

© 1947 Popular Science Publishing Co. Inc.

Harnessing the Small Stream

by c.d. basset

Reprinted courtesy of:

Popular Science Monthly,
355 Lexington Avenue,
New York, N.Y.

PART ONE

Many farms, ranches, and other fair-sized tracts of land embrace at least one brook within their limits. In most cases, the idea that a small stream can provide a useful source of power has never occurred to the property owner or, if it did, has been rejected as silly. The fact remains, nevertheless, that impressive advantages can spring from small water-power installations.

Electricity can be generated for general use, for pumping water, and for stand-by or emergency purposes; and the pond that is usually created can serve additionally as a means for watering livestock in dry times, for fire-fighting, as a swimming pool, as a place to raise fish for sport or as a "crop".

Power can be obtained from any flowing stream, no matter how small. Whether it is desirable to harness this power depends on two factors. First, does water flow all the year round, even in the late summer months? Second, does enough water flow to make the harnessing of it economically sound? The first factor is, of course, known to the property owner by observation; the second may be determined by simple measurements.

What's the least amount of power that is worth developing? There is in this country at least one water-wheel manufacturer who makes a line of small-capacity units, and this company's smallest hydroelectric unit develops 1/2 kilowatt. From this it can be inferred that, in this company's experience, it is not economically wise to harness a stream that will not develop at least 500 watts dependably at the switchboard. Half a kilowatt will light 10 fair-sized lamps or supply 2/3 hp. to operate, say, a deep-well pump. With this figure in mind as a criterion, the reader can make a preliminary reconnaissance of the water power available on his property. The chances are he will be surprised; even a seemingly insignificant stream can deliver many times this minimum.

The power available at the site of a water wheel (that is, before deductions for inefficiencies in the wheel and generator) is expressed in this formula:

$$\text{Hp.} = \frac{62.4 \times Q \times H}{33,000}$$

Here Q is the cubic feet of water passing through the wheel in one minute; H is the "head" or vertical distance in feet through which the water falls; 62.4 is the weight in pounds of 1 cu. ft. of water; and 33,000 the number of foot-pounds per minute in 1 hp. A number of methods exist by which the variables Q and H can be determined, but before considering them, it's well to examine first the possible sites for the dam and wheel, since they will necessarily affect the amount of head secured.

The location of the dam, as suggested in Fig. 1 should be governed by two principles. It should be placed where the greatest useful head is obtainable, that is, where the greatest fall occurs in the shortest length of stream. Such a site is often indicated by a natural waterfall, by a conspicuously steep slope or by the swiftness of the current. The second locating principle is a simple matter of cost: a dam should be placed where it can be smallest and still impound the most water. This means, in general, that it should be placed where the stream valley or cut is narrowest.

The site of the water wheel, Fig. 2, may be either at the dam or some distance below it. The former location is the more common, being simpler to build and eliminating the need for a pipe or penstock to deliver water to the wheel. Disadvantages include the fact that the spillway must be of ample capacity to protect the powerhouse in time of high water, and the fact that only the "artificial head" — that created by the dam itself — is available. In cases where the ground falls away abruptly below the dam site, the "divided-flow" layout may be desirable, for it greatly increases the head.

If located at a waterfall, right, a dam will often be small and inexpensive and the total head fairly large.

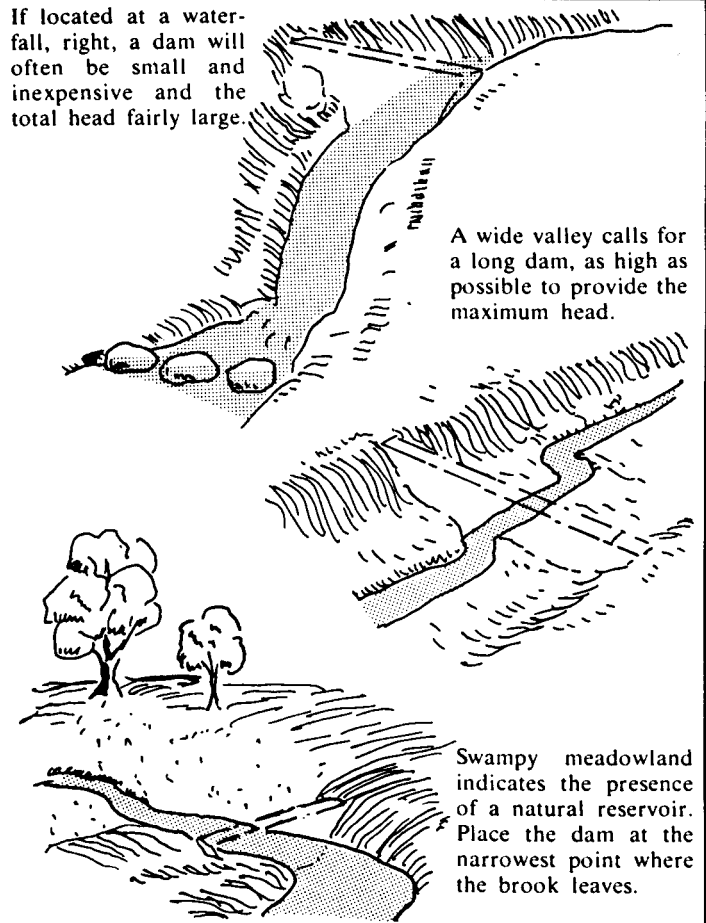
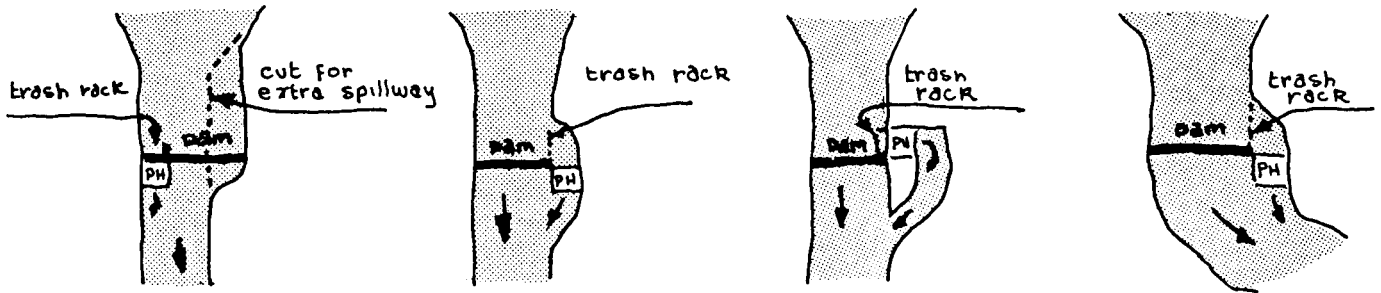
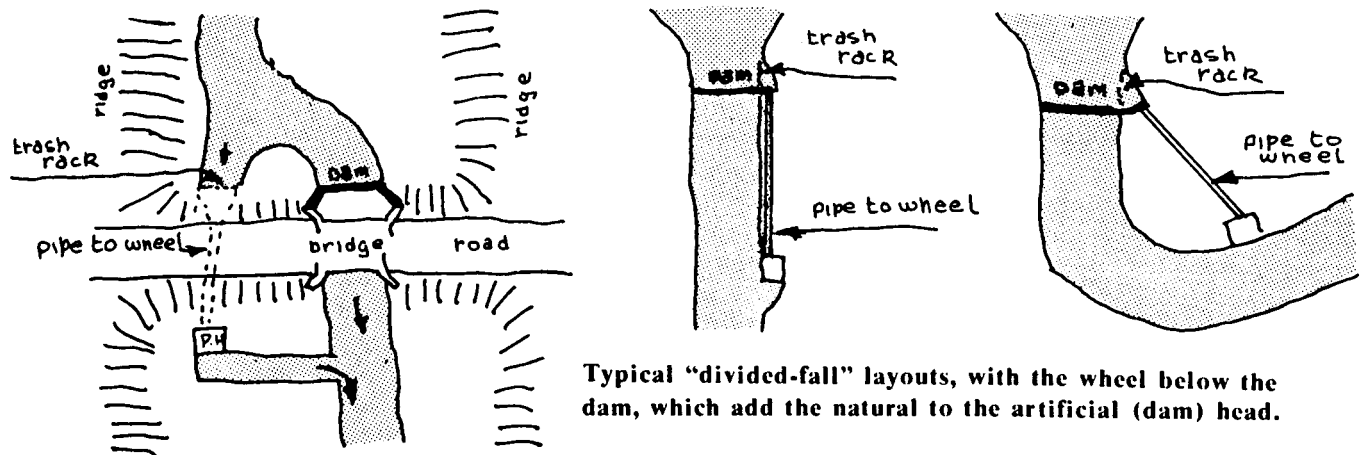

figure 1 - locating the dam

Fig. 2 Locating The Wheel



Typical layouts with the powerhouse at the dam, a location that uses only the artificial head.



Typical "divided-flow" layouts, with the wheel below the dam, which add the natural to the artificial (dam) head.

Another preliminary calculation should be made as to the height of the proposed dam. This is restricted, as a rule, only by the height of the valley walls at the site, and by the materials, equipment, and money available for building it. The higher it is, the greater the head and the larger the pond that will be created "Pondage" — water stored for use in times of peak demand — is an important factor in water power calculations. Power is rarely needed 24 hours a day, and construction of a dam of sufficient height to provide water storage will greatly increase the power available at the time of day required.

If, for example, a wheel is to be run for 16 hours a day, and if a dam is built that will impound all water flowing into the pond during the idle eight hours, the power capacity will be increased by 50 percent. Don't neglect to distinguish between "live storage" — the volume of water represented by the difference in height of the spillway flash boards and the wheel intake — and "dead storage" — the volume of water below the level of the wheel intake. The former is power banked against a time of need; the latter is worthless, powerwise.

Once the dam and powerhouse are tentatively sited, and the height of the first is provisionally set, it is time to measure the power available. Assume that all water flowing in the stream can be made to flow through the wheel, which is a fair assumption on small installations. This flow (Q in the power formula) can be determined by the "weir method", which involves constructing a temporary dam of controlled proportions or by the "float method", which is theoretically a trifle less accurate, though still quite satisfactory.

The float method (Fig. 3) involves the formula:

$$Q \text{ equals } A \times V \times 60$$

in which Q is the volume of water flowing in cubic feet per minute, A is the cross-sectional area of the stream in square feet at the site, and V is the average velocity of the stream at this point, expressed in feet per second.

Select a length of the stream that is fairly straight, with sides approximately parallel, and unobstructed by rocks or shoals for a distance of about 100'. Stretch a taut wire squarely across the stream near the middle of this length and measure the width of the stream here in inches. Mark this width off on the wire and divide it into ten equal divisions. From the centre point of each division, measure the depth of the water in inches. Then average the depth figure by adding each value and dividing by 10. The cross-sectional area of the stream, A, is now secured by multiplying this average depth by the width, and dividing the result by 144 to obtain the answer in square feet.

Your next step in determining Q is to measure the rate of flow. Using a steel tape, mark off a course along the bank that is 100' long; the mid-point of this course should be at the line where the cross section was measured. Stretch wires or rope tautly across the stream at each end of the course, and make a float by filling a bottle so that it rides awash. Provide it with a pennant so that you can follow it easily. Then set the float adrift in the middle of the stream, timing its progress over the course with a stop watch, beginning just when the pennant passes the first wire and stopping just as it passes the second.

Make a series of runs, averaging the results. The speed of the float in feet per second is then the length of the course divided by the average time. This result is not, however, suitable for immediate use in the flow formula, since not all the water in a stream flows as rapidly as that in the centre and near the top. If you multiply the float speed by the coefficient 0.83, the resultant value will serve as V in the flow formula.

Given an estimate of the amount of head to be present at the wheel, you can now make a rough determination of the horsepower your stream can provide. It's worth emphasizing, though, that this figure is necessarily only as accurate as the measurements that produced it, and that the power indicated is that present **at the time of measuring**. A single stream-flow value is not of itself particularly useful unless it is obtained at the time of lowest water, usually in the late summer months. Moreover, even if you have

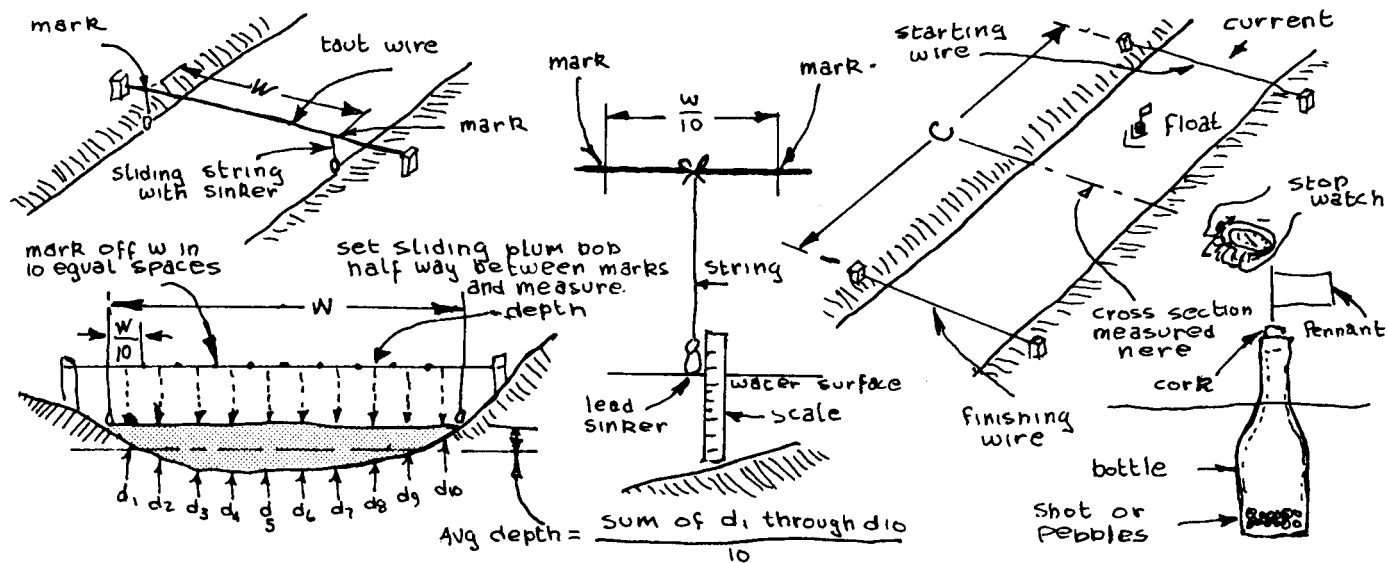

Fig. 3 Float Method of Measuring Flow

measured the flow at slackwater time, the figures should if possible be supplemented by others secured during maximum springtime flow, so that you can calculate the size of spillway needed to prevent damage to your installation in times of high water.

It's a good practice, for backyard engineers as well as for professionals, to refine, cross-check, and test your measurements by all means at your disposal. Such checks will not only reduce the chance of disappointment in the

PART TWO:

PUTTING WATER TO WORK

Measuring the flow of water in the stream or brook on your property is the logical first step in planning a small waterpower project. The float method of making this measurement is generally the easiest to perform and, if done carefully, is accurate enough for most purposes. If, however, a stream is so shallow at low-water time as to impede the progress of a weighted float, the weir method of measuring flow has advantages. Essentially a kind of water meter, a weir is a rectangular notch or spillway of carefully controlled proportions located in the centre of a small temporary dam. Two simple measurements permit the volume of flow to be accurately calculated.

Before constructing the dam, measure the depth of the stream at the site; the depth of the weir notch, M in Fig. 1, should equal this. Since the dam need not be permanent, a simple plank or tongue-and-groove lumber will serve adequately. No water must flow except through the weir, so care should be taken to seal the ends and bottom of the dam by extending planks into the banks and below the bed of the stream. Clay or loam puddling on the upstream side will stop minor seepage. Be sure the dam is perpendicular to the flow of the stream.

The weir should be located in the centre of the dam, with its lower edge not less than 1' above the surface of the water below the dam. This lower edge should be accurately leveled. Both this and the vertical edges of the weir should be beveled with the sharp edge upstream; a 1/8" flat on the bevel will keep the edge from breaking down. Proportion the weir so that its length L is not less than 3M, and larger if possible.

Drive a stake in the stream bed at least 5' upstream from the weir, pounding it down until its top is exactly level with the bottom edge of the weir. Allow the stream to reach its maximum flow through the weir and then measure with a ruler the depth in inches of water over the stake. Referring to the table on this page, you can now read the number of cubic feet per min. of water for each inch of L, the weir width. If you multiply the figure from the table by L, the result is the total amount of water flowing in cubic feet per minute, which is Q in the horsepower formula.

If your stream is already dammed, there is no need to construct another dam just to measure flow. It is quite possible to employ the existing dam, using its spillway as a weir, provided that all water can be made to pass through the spillway. Construct a wooden or metal frame to fit the

final result, but will also permit calculated economics in construction and greater efficiency in operation.

Before you begin even a preliminary reconnaissance of waterpower on your property, the writer suggests you secure a looseleaf notebook to be devoted solely to the project. Develop the habit of neatly entering all data as it is obtained, not forgetting to note dates and stream conditions at the time measurements are made. Such a record is a great help in performing sound calculations and producing excellent results.

spillway and seal it in place snugly. The centre of this frame should incorporate a properly proportioned weir notch. As before, M should equal the depth of the water flowing through the spillway before the weir is installed, and L may in most cases be half the width of the spillway.

To get an accurate estimate of available horsepower, you will need a precise figure for H, the head of water that will be present. *Head* may be defined as the vertical distance in feet from the surface of water in the pond behind the dam to the surface of the stream below the dam at the site of the wheel. This figure may be obtained by any of several methods in cases where a dam is already present, and with scarcely greater difficulty at the site of an unbuilt dam.

Measuring a difference in elevation can be quickly and accurately done with an engineer's transit and leveling rod. But since not everyone has access to these instruments, and since those who do would not need instructions on so simple a job as running a level, we'll pass on to other methods.

Figure 2 illustrates a very simple way of measuring a vertical distance. The equipment required is a carpenter's level, a folding rule or steel tape, a 1" by 2" by 6' board with two edges planed parallel, two wooden pegs, a stake and a C-clamp. These are items that can be found in

Inches Depth over Stake, D	1/8 in.	1/4 in.	3/8 in.	1/2 in.	5/8 in.	3/4 in.	7/8 in.
1 inch	.40	.47	.55	.65	.74	.83	.93
2 "	1.14	1.24	1.36	1.47	1.59	1.71	1.83
3 "	2.09	2.23	2.36	2.50	2.63	2.78	2.92
4 "	3.22	3.37	3.52	3.68	3.83	3.99	4.16
5 "	4.50	4.67	4.84	5.01	5.18	5.36	5.54
6 "	5.90	6.09	6.28	6.47	6.65	6.85	7.05
7 "	7.44	7.64	7.84	8.05	8.25	8.45	8.66
8 "	9.10	9.31	9.52	9.74	9.96	10.18	10.40
9 "	10.86	11.08	11.31	11.54	11.77	12.00	12.23
10 "	12.71	12.95	13.19	13.43	13.67	13.93	14.16
11 "	14.67	14.92	15.18	15.43	15.67	15.96	16.20
12 "	16.73	16.99	17.26	17.52	17.78	18.05	18.32
13 "	18.87	19.14	19.42	19.69	19.97	20.24	20.52
14 "	21.09	21.37	21.65	21.94	22.22	22.51	22.79
15 "	23.38	23.67	23.97	24.26	24.56	24.86	25.16
16 "	25.76	26.06	26.36	26.66	26.97	27.27	27.58
17 "	28.20	28.51	28.82	29.14	29.45	29.76	30.08
18 "	30.70	31.02	31.34	31.66	31.98	32.31	32.63
19 "	33.29	33.61	33.94	34.27	34.60	34.94	35.27
20 "	35.94	36.27	36.60	36.94	37.28	37.62	37.96
21 "	38.65	39.00	39.34	39.69	40.04	40.39	40.73
22 "	41.43	41.78	42.13	42.49	42.84	43.20	43.56
23 "	44.28	44.64	45.00	45.38	45.71	46.08	46.43
24 "	47.18	47.55	47.91	48.28	48.65	49.02	49.39

Table from James Leffel & Co.

This table shows the quantity of water passing over a rectangular weir in cubic feet per minute (cfm) for each inch of notch width. Depth D is read as a combination of the left-hand column and the top row. For example, if the depth over your stake is 5 3/8", follow over 5 (fifth row) to 3/8 (fourth column), and read the value as 5.01 cfm. Don't forget that this figure should now be multiplied by the width in inches of your notch.

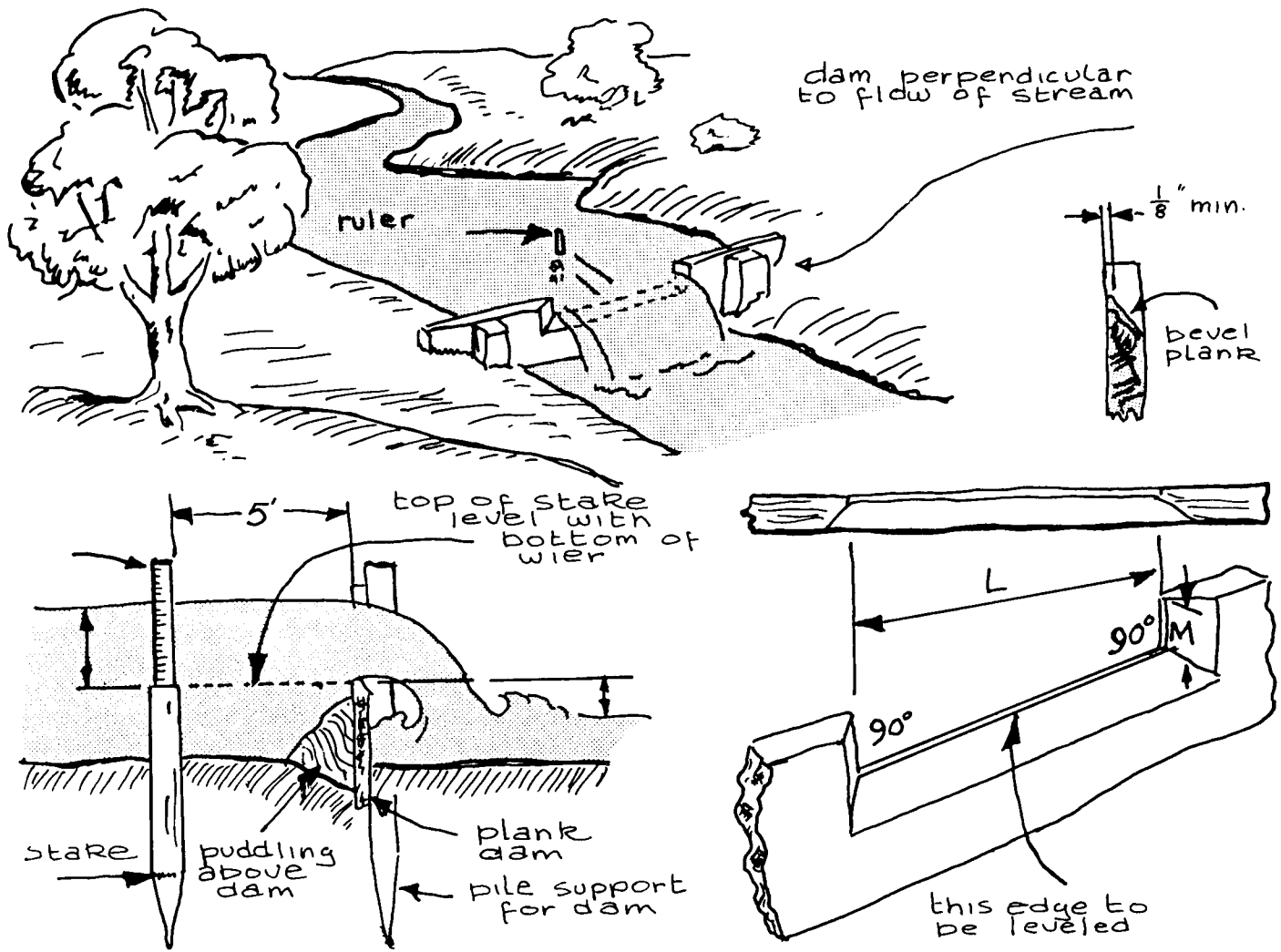
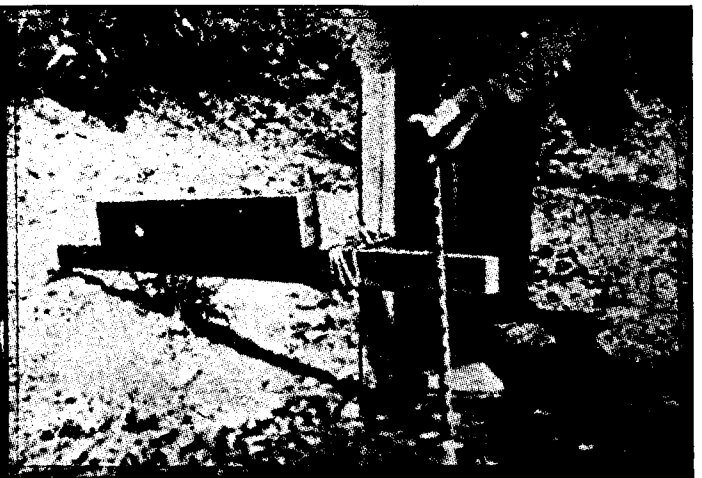

Fig. 1. Weir Method Of Measuring Flow. More trouble than the float method, this gives somewhat more ac-

curate results. It is especially useful in shallow streams, or if a dam is already present.



With the straightedge held level, vertical height between a pair of pegs is read off and noted.



Your last measurement should be to the surface of the water at the site selected for the water wheel.

almost any home, and certainly any farm. Though the method can be somewhat tedious if the difference in elevation is large, the results will be quite accurate with ordinary care in leveling and measuring. Note in the drawing that in the case of a pre-existent dam, one or more measurements needed to carry around the edge of the dam are subtracted from, rather than added to the total.

Less practical in most cases, though still of occasional special value, are two other ways to determine head. Elevations can be measured quite readily by the techniques of photographic surveying. For those who are familiar with the procedure, it is a simple matter to take the required pictures in the field and then scale the required elevation at the desk from the developed photographs. Another method involves the use of a barometer, either mercury or aneroid, to indicate differences in height. However, this method is useful only where the head to be measured is considerable, say, more than 25', and calls for special techniques to hold the probable error down to acceptable proportions. Except in unusual circumstances, the writer recommends that the method in Fig. 2 be employed, inasmuch as it requires little special equipment and with ordinary care gives good results.

With sound figures for both H and Q, you are now ready to calculate the available horsepower of your installation with the formula given previously. If the power is found to be sufficient to warrant continuing with the project, say 2/3 hp. at the least, your next step is to determine the nature of your power requirements. Here individual variations are so many as to make it difficult to outline a specific procedure. It's possible, however, to suggest factors you should consider in planning your power plant.

Some of the uses to which small-capacity installations are successfully put include directly powering pumps, mills, machine tools, or other small-demand machinery, and driving a generator to supply electricity for either lighting or power purposes. The latter type of installation is of course the more flexible and generally useful. Determine, then, the uses you propose for your water power, and tabulate the horsepower required after each item. In the case of electric motors or appliances rated in amperes or watts, remember that watts are volts times amperes, and that 746 watts are equal to 1 hp.

From this tabulation, the peak load can be determined. This is the sum of the power demands made by different pieces of equipment that may probably be in use at one time. Knowing power and load, you can now determine if the proposed installation will be on a sound basis.

Do not use your available horsepower figure directly, since deductions should first be made for losses in the water wheel and in the generator, if you intend to be using one. For small installations, assume wheel efficiency to be 75 per cent; many small wheels will better this, but the assumption will provide leeway for possible optimism in measuring H and Q. Generator efficiency can be assumed to be 80 per cent, a figure that will also be bettered in many cases but is on the safe side. Thus switchboard power may be expressed at $.75 \times .8 \times \text{hp}$, or .6 of the available horsepower.

At this stage of the game, it's well to mull over the possible variations and combinations, rather than to proceed with specific construction plans. Consider for

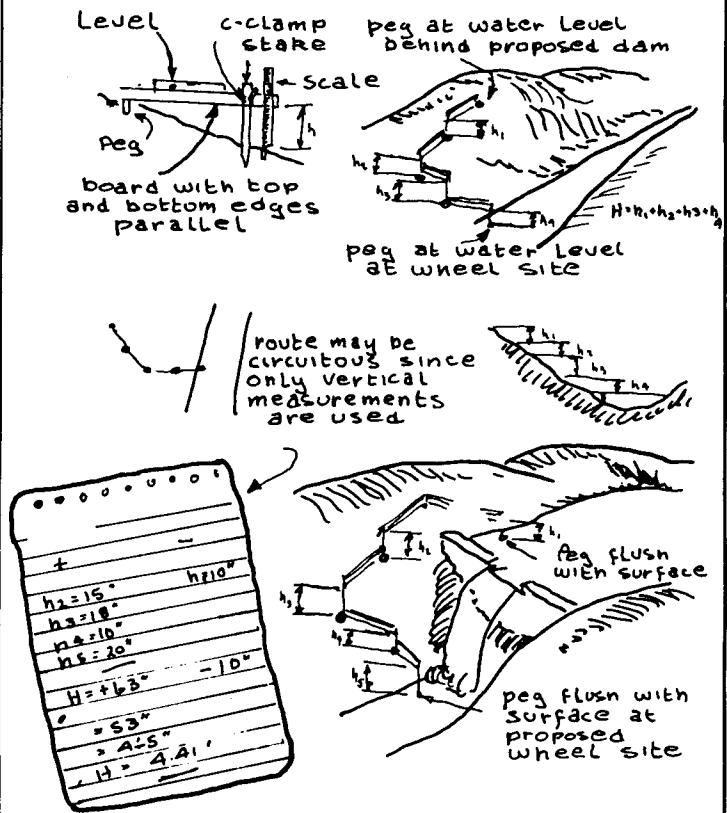
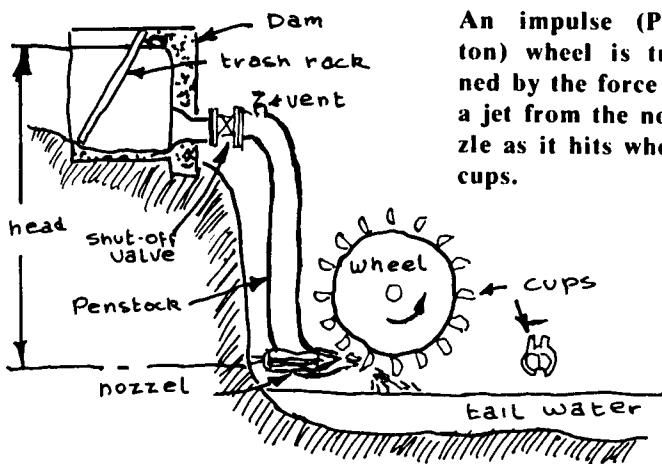

Fig. 2. Measuring Head. With a carpenter's level, straightedge, and pegs, head can be measured before or after the dam is built.

example the decision required if the indicated switchboard power will seemingly handle the peak load —whether to build a dam just large enough to do this job, or to build one substantially larger to handle possible future increases in power requirements. The former choice will be obviously cheaper at first but may not be so in the long run, since power demands have a way of growing and since it is rarely satisfactory to increase the structure of an existing dam.

If the peak load is apparently too high, various possibilities should be considered. Will "pondage" - water stored behind the dam overnight or in slack periods - help out? Can the use of equipment be dispensed with? Is the project necessarily a year-round enterprise, or can the low-power characteristics of dry season be ignored? A word of caution on these points may not be amiss: it's far better to plan an installation that will provide more power than you need than one which doesn't supply enough.

Whether, in the event that you decide to generate electricity, to use AC or DC is another decision to make. In circumstances where the generator must be located some distance from the load, AC is the only choice, for DC transmission losses would be too high, amounting in small installations to a prohibitive percentage of switchboard power. If your buildings and equipment are already wired to receive one type of current, it would obviously be sensible to fix on the same type of power; if for example your farm is already wired for a battery-type lighting system, there would be little reason to revamp the installation for AC. If on the other hand you are starting from scratch, I recommend the use of DC wherever possible. An AC



An impulse (Pelton) wheel is turned by the force of a jet from the nozzle as it hits wheel cups.

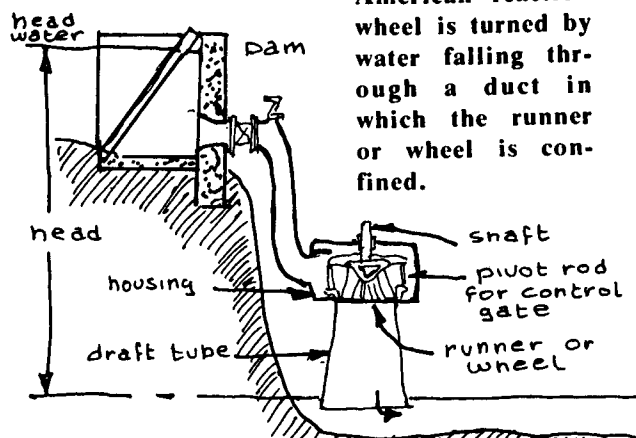

The Francis or American reaction wheel is turned by water falling through a duct in which the runner or wheel is confined.

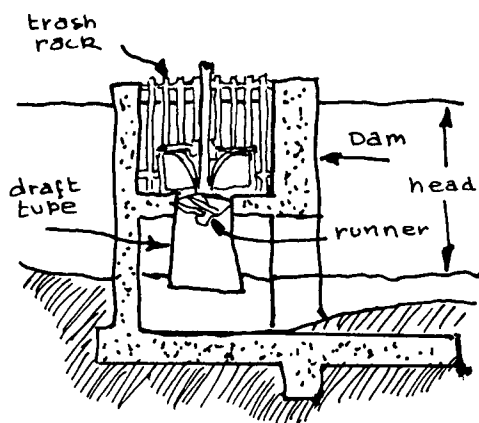

The propeller reaction wheel is moved by current flow on a high-speed horizontal-plane runner.

An overshot gravity wheel is rotated in part by impulse but principally by the weight of the water.

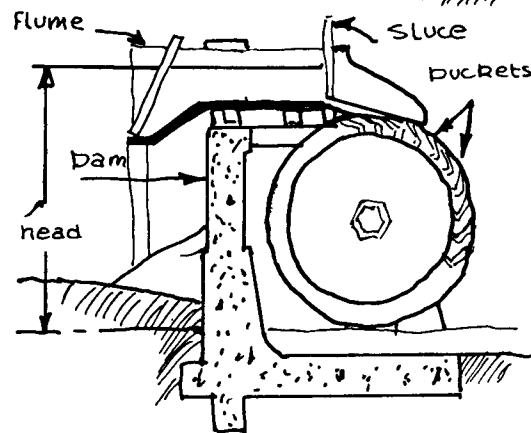

Fig. 3 Four Types Of Small Water Wheels

generator must be closely regulated at or slightly above synchronous speed, and close regulation requires complicated governing equipment that is tricky to build or expensive to buy. A compound-wound DC generator, on the other hand, provides inherently close voltage regulation over a wide speed range; and even a shunt-wound DC generator with a direct-acting field-rheostat regulator would be satisfactory.

Selecting the right wheel for your plant is perhaps the final step in your preliminary planning. There are three general types of water wheel — impulse, reaction, and gravity — and several fairly common varieties of each type. However, for small plant purposes, it is possible to narrow the number down to those shown in Fig. 3. Note that two types of reaction wheels, the Francis and the propeller, are shown, and but one variety of gravity wheel, the overshot one.

The impulse or Pelton wheel, operated exclusively by the force of the water from the jet includes among its advantages very slight leakage and friction losses, good efficiency under varying flows, and a sufficiently high shaft speed to drive a generator. It is more resistant to pitting by water containing sand, silt, or minerals than the reaction type. Its disadvantages include the fact that it cannot use

all the available head, is larger than a reaction wheel developing the same power, and will wallow in high tail water. It must be mounted as close to the tail water as possible.

The reaction wheel, either the Francis or propeller type, is turned by the fall of water through a duct or pipe in which the wheel is confined. It is the most compact of all wheels for a given power, uses all of the available head, and operates at a satisfactory speed for direct coupling to a generator. It is an efficient wheel over a wide range of conditions, and it can be mounted at any convenient height above tail water. Disadvantages include rapid corrosion with silted water, and relatively high leakage and friction losses, especially in small units.

Finally, there is the overshot gravity wheel, which is turned largely by the weight of the water and partly by impulse. It has good efficiency under varying flow, and is unaffected by sand, silt, or minerals in the water. Gravity wheels turn at a low speed, which is undesirable for driving a generator or high speed machinery, but suitable for some pumping and grinding applications. Such a wheel will wallow in high tail water, is the largest wheel for given power, and will be obstructed by ice in winter unless housed.

PART THREE:

DAMS TURN WATER INTO KILOWATTS

Concrete, though desirable, isn't necessary for damming a small stream. Beavers have gotten by for years without it. Suitable materials can be found on almost any farm. Logs, roughhewn timber, rock, masonry, planking, gravel, sand, and clay are all useful. Choose the materials most readily available on your property, or the least expensive if you must obtain them elsewhere.

You will have determined the height and width of the dam you will need to convert your stream to power. The summer months provide an ideal time for its construction, for then most brooks are at their lowest level and the water will not impede the progress of work.

Four basic types of small dams are shown in the accompanying drawings. All are adaptable in general to the kind of materials likely to be on hand and also the the head of power desired.

There are two basic principles of design to bear in mind no matter which you build. First, a dam should be sealed both above and below its foundation to prevent the

seepage of water through or under it. Seepage through a dam, if permitted, weakens the structure and will eventually break it; that under a dam will undermine its foundation. Then, too, some means must be provided to prevent undermining of the dam by the water that flows or spills over it.

In addition, you should check with your local authorities and possibly file plans for your dam with them. General supervision comes under the Water Board.

Figure 1 illustrates the earth dam. Sealing this type of dam is most important since seepage will literally carry it away if allowed to progress. The seal is put in first and the dam built around it. How far down it should go depends upon the kind of soil. A sand foundation, for instance, requires the seal to extend deeper than clay. If planking is used, it would be well to apply a protective coat such as tar or creosote.

A general pattern for depositing the earth fill is shown in the drawing, but it is not necessary to follow it unless different types of earth are available. Deposit the fill by layers, rolling and tamping each layer well. Then protect the waterside surface from erosion by covering it with a matting woven from brush. Plant turf on the top and downstream side to hold the earth.

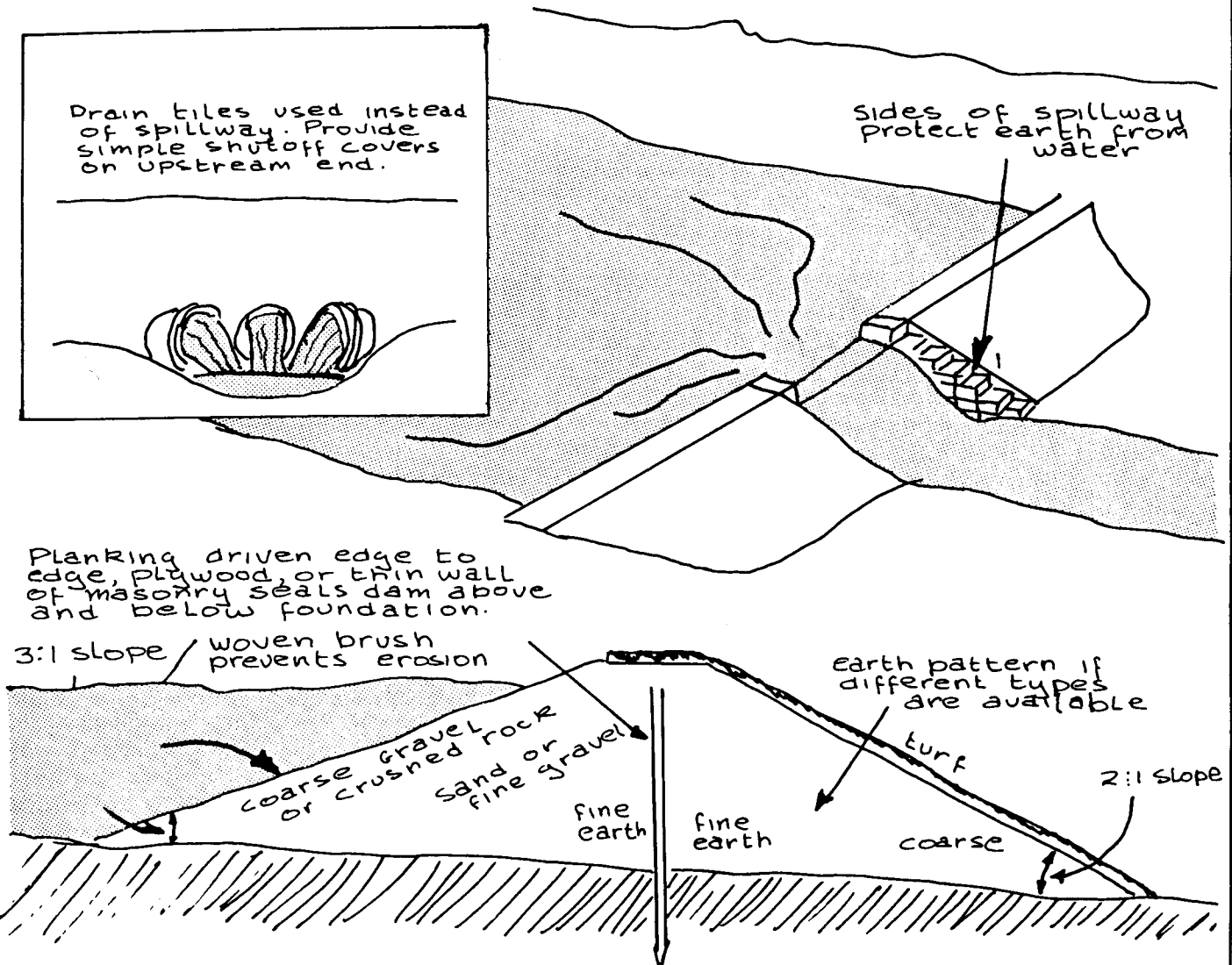

Fig. 1 The Earth Dam

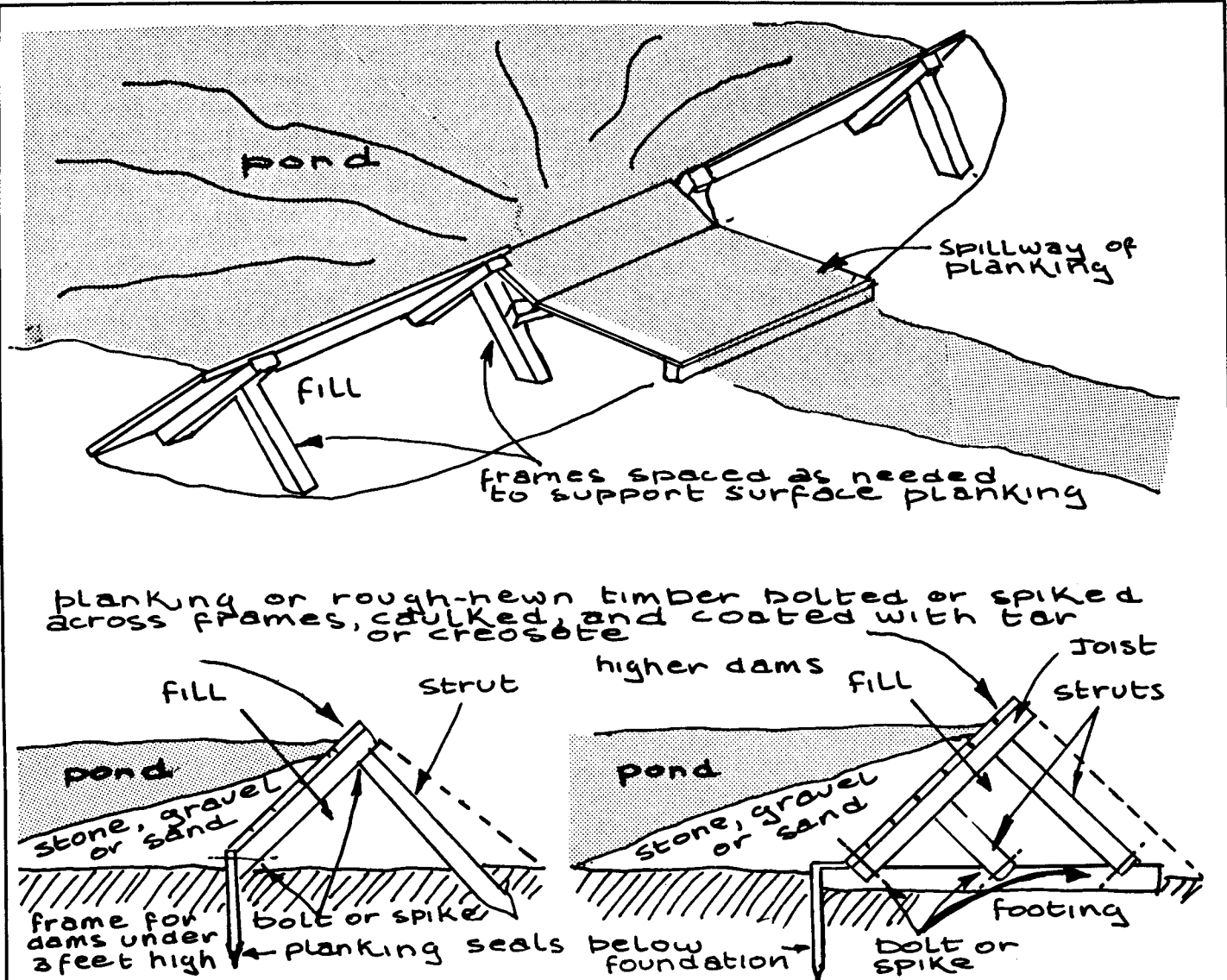

Figure 2. The Framed Dam

Such a dam obviously cannot have water spilling over its crest since this action would wash it away. Two suggestions for handling the excess water are shown. The spillway must be of some material, such as masonry or planking, resistant to the erosion of rushing water, and the sides must protect the open ends of the earth dam from spillage water. An alternative method of handling runoff water is with drain tiles instead of a spillway. Some means must be provided for shutting them off. A simple cover on the upstream end would serve.

Figure 2 shows the framed dam, which likewise can be easily built, particularly on a farm where lumber in any form from logs to planks is abundantly available. Each frame consists of one joist on which the surface timber is laid and one or more struts. Once the height of the dam is determined, the size of individual frames will vary depending on the contour of the gulley, those frames located at the lowest part being the largest. The frames are spaced according to the support the surface timber needs, that is, the thinner the surfacing the more supports needed.

Lay the planking surface or roughhewn timber horizontally and edge to edge across the frames, and bolt or spike each in place. Calk the joints and apply a protective coating. Fill is put in behind the downstream side. Build

the spillway entirely of planking or similar material.

The gravity dam, shown in Fig. 3, relies upon its weight for its stability. This dam would be most feasible where large rocks or field stones abound. Bricks, concrete or cinder blocks, and even chunks of broken concrete pavement are also excellent materials. The dam is strictly a masonry type, each block being laid with mortar.

Length is not a critical factor for any of these three dams, but it is important for the arch dam illustrated in Fig. 4. The placement of such a dam in a gulley is limited not only to the point of least width but also the point where the banks are highest. Otherwise, this dam would impound little water. It would seem unwise to build one to span a width of more than 10". If the heavy timber is used only as a frame on which to spike or bolt a surface of planking, as shown in one of the drawings in Fig. 4, the number of timber arches will depend on the strength of the planking and also on the height of the dam.

Only early foundations are considered in the drawings, but you may be fortunate enough to have a solid rock foundation on which to build. In that case a seal below the foundation will not be necessary, but some means must be provided to anchor the dam to the rock, such as with anchor bolts in the case of either the framed or gravity dam.

Fig. 3
The Gravity Dam

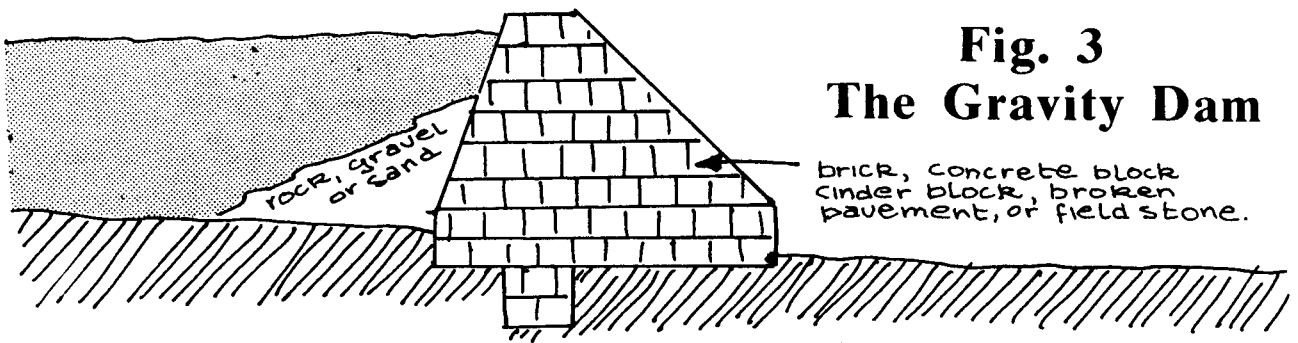

Likewise the dam should be sealed at the rock foundation to prevent seepage under it.

In most instances it will be found best to restrict the width of the spillway for excess water to some part of the total length of the dam. This will always be necessary in the case of an earth dam to prevent washing. The spillage water may be allowed to pour over the entire length of framed, gravity, and arch dams, however, if the precautions shown in Fig. 5 are taken.

If the downstream side of the dam, or of the spillway, is a curved hard surface of masonry or timber approximating the natural curvature of the water flowing over, it will guide the spillage water so it will be directed downstream without actually falling. Such a curved spillway surface is particularly satisfactory for an earth dam. Large rocks, bricks, or other hard objects placed on the downstream side of a spillway not having a curved surface will break the force of the free-falling water and prevent erosion.

The spillway in its simplest form takes the shape of a rectangular depression in the crest of the dam. It should usually be large enough to carry off sufficient excess water so that impounded waters will not top the dam at any season of the year. This, of course, is quite a problem, since accurate determination of spillway capacity requires a knowledge of the total area drained by the creek

being dammed plus data on the amount of rainfall at all seasons.

However, most of us will know whether or not the creek we are damming stays within its banks during the year. If it does, then a safe rule to apply would be to make the area of the spillway equal to the cross-section area of the creek at the dam when it is brimful or just ready to flood. The formula is illustrated in Fig. 6.

If the stream does flood, then either construct a dam that in an emergency can allow water to top its full length or build some sort of floodgate into the dam so it can be opened when necessary. One form such a floodgate could take is a group of drain tiles through the dam, as shown in Fig. 1.

The height of the dam you build will be determined by the area of the land to be covered by the impounded water. In general, the higher the dam, the greater the area covered by water above it.

All vegetation, brush, floatage, and the like in the area to be flooded and for about 15' around it should be burned out or otherwise cleared before the dam is built. This keeps down the breeding of mosquitoes and helps retard pollution. It is required in the regulations of some states and is a wise precaution even when not covered by law. In addition, all trees in the area to be flooded should be cut reasonably close to the ground.

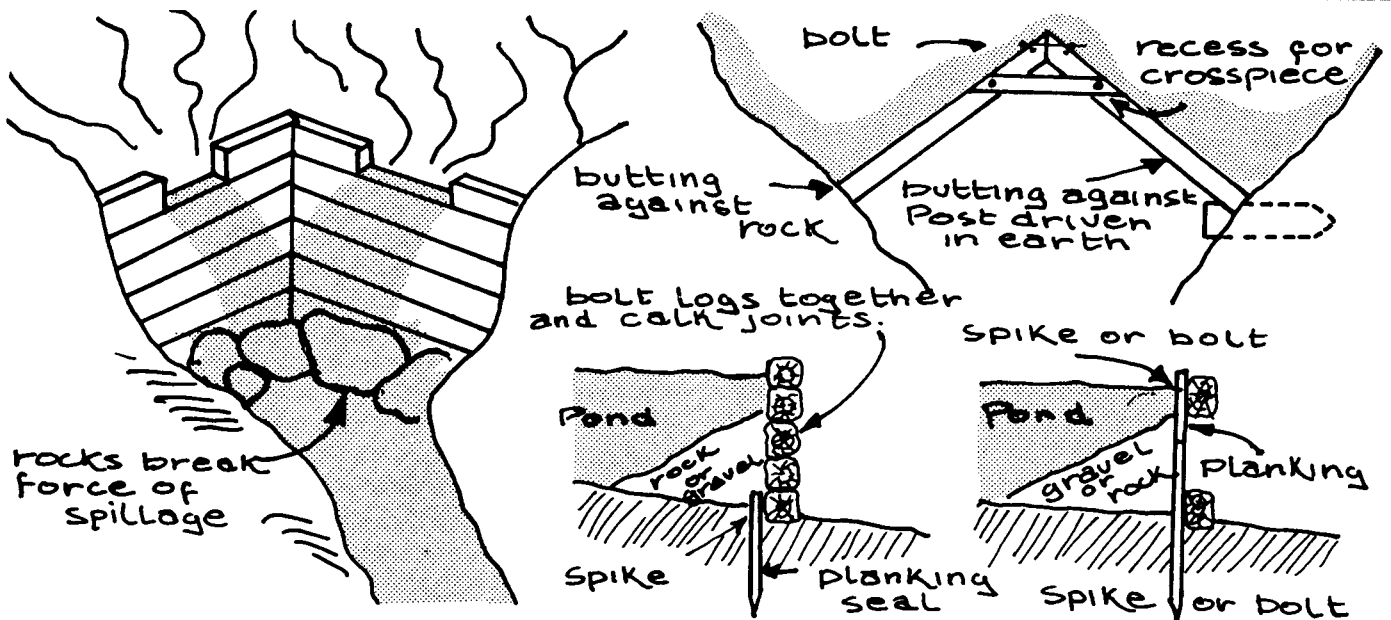

Fig. 4. The Arch Dam

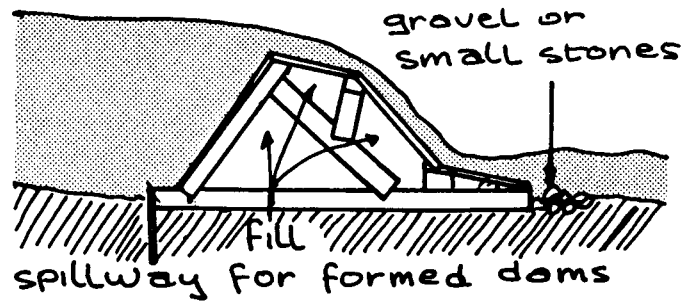
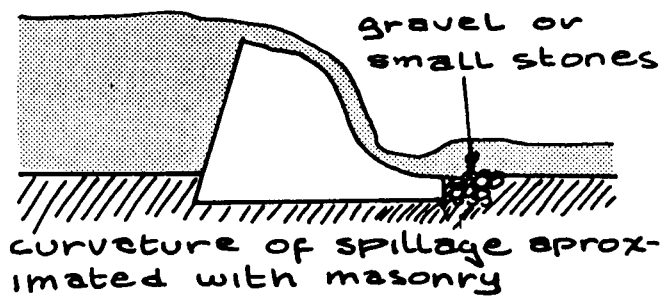
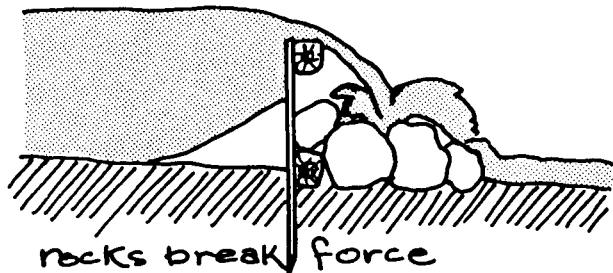

Fig. 5 - Methods of preventing spillage from undermining dam.



$L \times H = W \times D$
 L is length of spillway
 H is depth of spillway
 W is average width of brimfull creek
 D is full depth of creek

spillway with shorter "L" and deeper "H" - same area

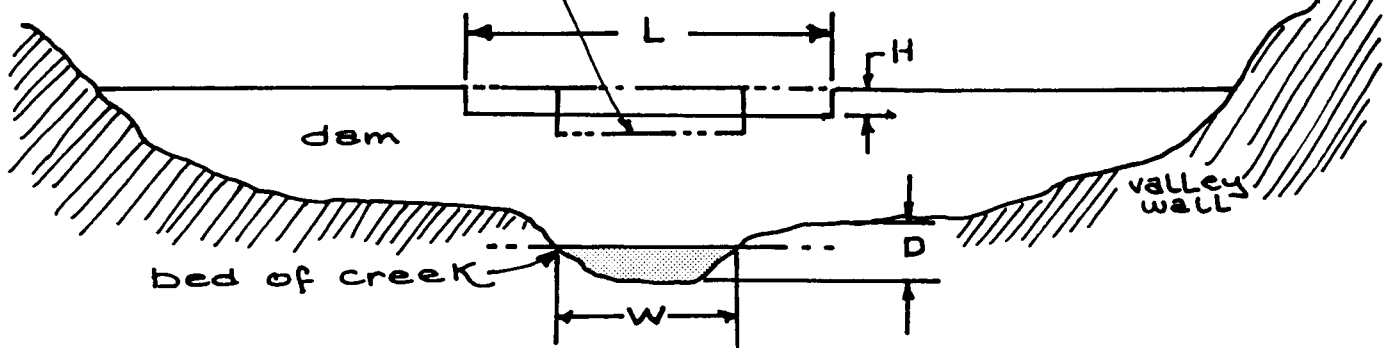

Fig. 6 - Determining the size of the spillway.

PART FOUR:

BUILDING AN OVERSHOT WHEEL

Often seen beside a picturesque rural mill, an overshot water wheel possesses two excellent characteristics — considerable mechanical efficiency and easy maintenance. Many have remained in service for decades.

Operated by gravity, the overshot wheel derives its name from the manner in which water enters the buckets set around its periphery. Pouring from a flume above the wheel, the water shoots into buckets on the down-moving side, overbalancing the empty ones opposite and keeping the wheel in slow rotation.

Such a wheel may be located near, but not actually in a stream. If a site on dry ground is chosen, the foundation may be constructed dry and the water led to the wheel and a tailrace excavated.

It should be noted, however, that an overshot wheel is practical only for a small-capacity output. How much power it will produce depends upon the weight of water the buckets hold and its radius, or lever arm. Expressed in another way, the output depends upon the weight of water transported and the height, or head, through which it falls while in the buckets. For maximum efficiency, the wheel

must use the weight of the water through as much of the head as possible. Therefore, the buckets should not spill or sling water until very near tail water.

Power Increases with Width

Although of simple construction, an overshot wheel is cumbersome in size. For this reason, before attempting to build one be certain you have the facilities to move and lift it into place when completed. Also allow yourself plenty of working floor space. It must be understood, too, that such a wheel is a sizeable project and requires a lot of material and time. Extreme care in cutting and assembling the parts is not essential, however, because the wheel, operating at slow speed, need not be accurately balanced.

Accompanying this article are drawings that illustrate the construction of a small wheel suitable for a water head of 6'3". The wheel itself has a diameter of 5', leaving a flume head of 15" to propel the water into the buckets. As shown in the table at the bottom of page 54, you may build the wheel to give a power output ranging from 1/2 hp. to 1 hp. at 10 r.p.m. All dimensions remain the same except the width, the horsepower increasing as this is increased. For

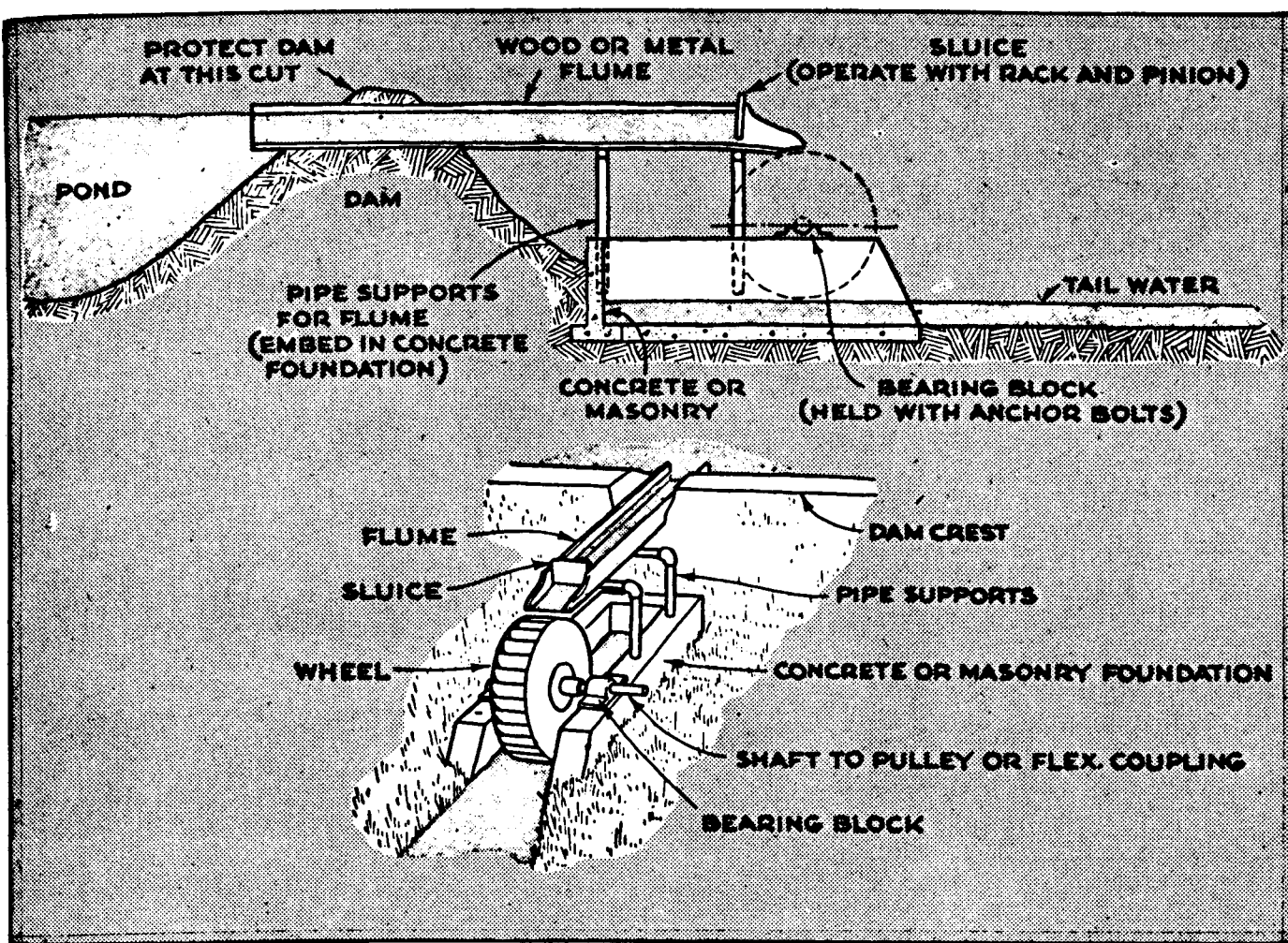

1/2 hp., the wheel should be 15 31/32" wide. For 1 hp., it should be 31-29/31. Before deciding on the wheel size, read Guy Immaga's article on page 58.

Virtually all large wheels are built with wood or steel arms, as in the drawing above, and have a shroud plate only around the outer edge, but you may find it simpler and more satisfactory to build the drum-type wheel described here. In this case, each shroud plate is a disk of 1/8" sheet steel sole plate to which it is continuously welded, by the buckets, by one of the two large diameter 1/4" steel hub flanges to which it is also continuously welded, and by the long hub itself.

Large Sheet Required

If preferred, the shroud plates may be made of wood. If so, care should be taken to bolt them securely to the hub flanges. Bushings pressed into the wood for bolts will give the wheel a longer life expectancy.

Sheet steel for the disks may be ordered direct from several large steel companies in case your local supply house is unable to furnish it. Ordinarily, such steel comes in standard 48" widths, so you may have to weld together two or more sheets to get the required 5' diameter, using either a butt weld or a backing plate. This will produce some distortion or ripple, as will the welding on of the numerous clips required. So long as distortion is local, however, and the main lines of wheel and shaft remain true, this will do no harm.

After the sheet has been prepared, scribe a 5' circle on it and cut it with the cutting flame of a gas welding torch. With ordinary care, this method should give sufficient accuracy. Vent and drainage holes should be drilled as indicated around each disk to lessen corrosion with the drum.

Good Buckets Important

The buckets are the most important element of the wheel. To give maximum efficiency, they must be formed so that the water enters smoothly at the top of their travel and remains in them until just before they reach the bottom. For this reason, the bucket form indicated on page 53 should be followed faithfully. Either sheet metal or wood is an acceptable material, but metal is better suited to cold climates, since wood is damaged when absorbed water freezes. Because the buckets are subject to wear from the water and sediment that it carries along, you may want to install them so they can be easily replaced.

In laying out and making wooden buckets, follow these steps:

Using a common centre, strike off two arcs, one with a 21-1/2" radius and the other with a 2'6" radius. Then draw a radius line intersecting these arcs.

From the point where the radius crosses the outer arc, draw a chord 10-1/2" long and from the new point where this intersects the outer arc draw a line to point E. You

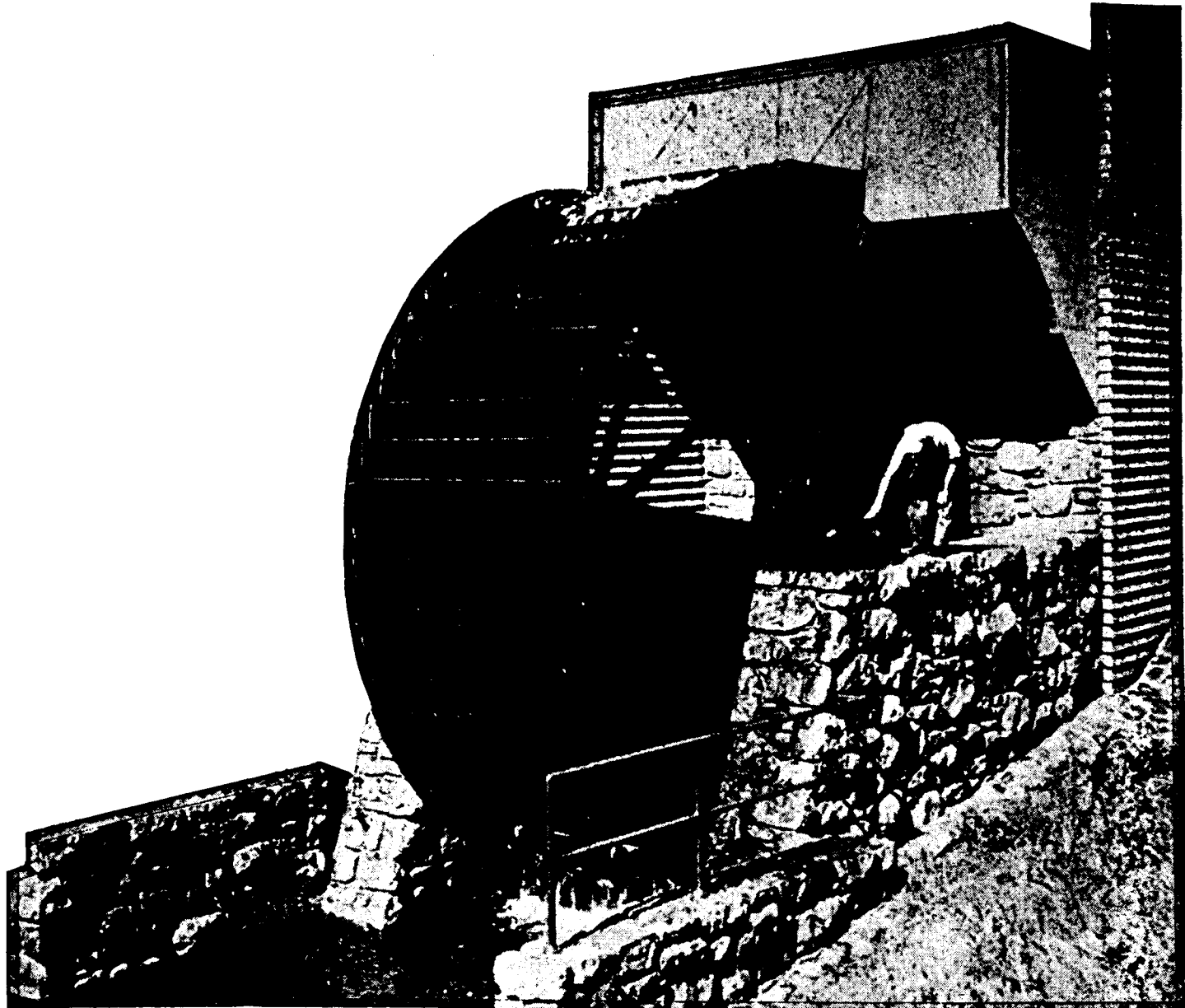

now have the inner trace of the bucket.

Take a piece of the bucket stock and lay it along the upper edge of this inner trace, and you have a cross section through the bucket. Cut your stock accordingly, making the length equal to B in the table of dimensions.

Steel Buckets Require Jig

Steel buckets are only slightly more difficult if you follow these steps:

Using a common centre, strike off two arcs on a piece of plywood, one with a $21\frac{1}{2}$ " radius and the other with a $2'6$ " radius.

Draw a radius line and then a tangent to the inner arc, making it vertical to the radius. From the point of tangency, measure 5" along the tangent. Mark this point.

Using this mark as a centre, strike off an arc with a 5" radius. This is part of the inner trace of the bucket.

At the point where the original radius line (Step 2) crosses the outer arc, draw a chord $10\frac{1}{2}$ " long, and at

point F where this chord intersects the outer arc draw a new radius line. Also at point F measure off 15 deg. of the new radius and draw line FG $11\frac{1}{2}$ " long.

Then, using G as a centre, strike an arc with a $11\frac{1}{2}$ " radius. This forms the rest of the inner trace of the bucket.

Cut the plywood along this line and along the lines that form a quarter ellipse. Using this as a pattern, cut several more quarter ellipses from scrap. Nail these to stretchers to make a bending jig around which the buckets may be formed.

Weld Wheel Parts

Welding of the various parts of the wheel produces an exceptionally strong construction. After getting together or making all the required parts, begin the assembly by welding four clips to each end of the hub sleeve. Then weld the required number of clips to the shroud plates for the sole plate, and weld the shroud plates to the clips on the hub sleeve. After welding both hub flanges to the shroud plates and the sleeve with a continuous weld, attach

the sole plate to the clips on the shroud plates with No. 8 self-tapping screws. Also weld the sole plate to the shroud plates with a continuous weld, and the bucket-support angles to the sole plate.

Attach wooden buckets to the supports with 3/4" No. 10 roundhead wood screws. If you use steel buckets, rivet or screw 10 clips to each side of each bucket and attach the buckets to the angles with No. 8 self-tapping screws. Then drill holes through the shroud plates in the way of the clips for the same type of screws.

Lubricate Bearings Well

Using locknuts and washers, fasten the hub sleeve to the shaft with two 3/8" by 4-1/2" bolts, placed at right angles to each other. Two bearing mountings having 2-3/8" renewable liners with shoulders should be bolted to the foundation. Place shims about 1/4" thick under the bearings.

Standard bearing mountings, variously called pedestals or blocks, may be bought complete with wick oiler or cup oil reservoir and with built-in self-aligning features. Standard bronze bearing metal liners or inserts likewise may be bought from any machine component supplier. Babbitt liners are equally satisfactory.

Although the wheel turns slowly, it is heavy and will be running almost constantly, so good lubrication of the bearings is essential. To this end, care should be taken to insure that the bearing liners are finished to the correct

fit. Porous inserts or inserts containing graphite are excellent for this application, but may cost more than regular bearing inserts.

It is important that the foundation be carried deep enough so that water falling from the buckets will not undermine it. Avoid a long flume if possible, in order to keep the construction as simple as possible. Strengthen it along its entire length with an exterior frame and support it well from dam to wheel with pipe uprights.

Sluice Governs Wheel

The sluice gate may be located at any convenient place along the flume. Since it is the governing mechanism of the wheel, its installation should be anything but slipshod. If it is installed at an angle as on the following page, water pressure will keep it at any desired position. If installed vertically, some mechanism, such as a rack and pinion, should be provided to keep it in place.

Adjust the sluice so that the buckets will run one-quarter full. This will give a wheel speed of 10 r.p.m. If the buckets are allowed to run more than one-quarter full, the efficiency of the wheel will drop for two reasons. Because of the increased speed, centrifugal force will throw water from the buckets. They also will begin to spill before approaching tail water. Although this practice does waste water, it may be profitably employed during freshet to increase the power output, for at such times the excess water would be wasted anyway.

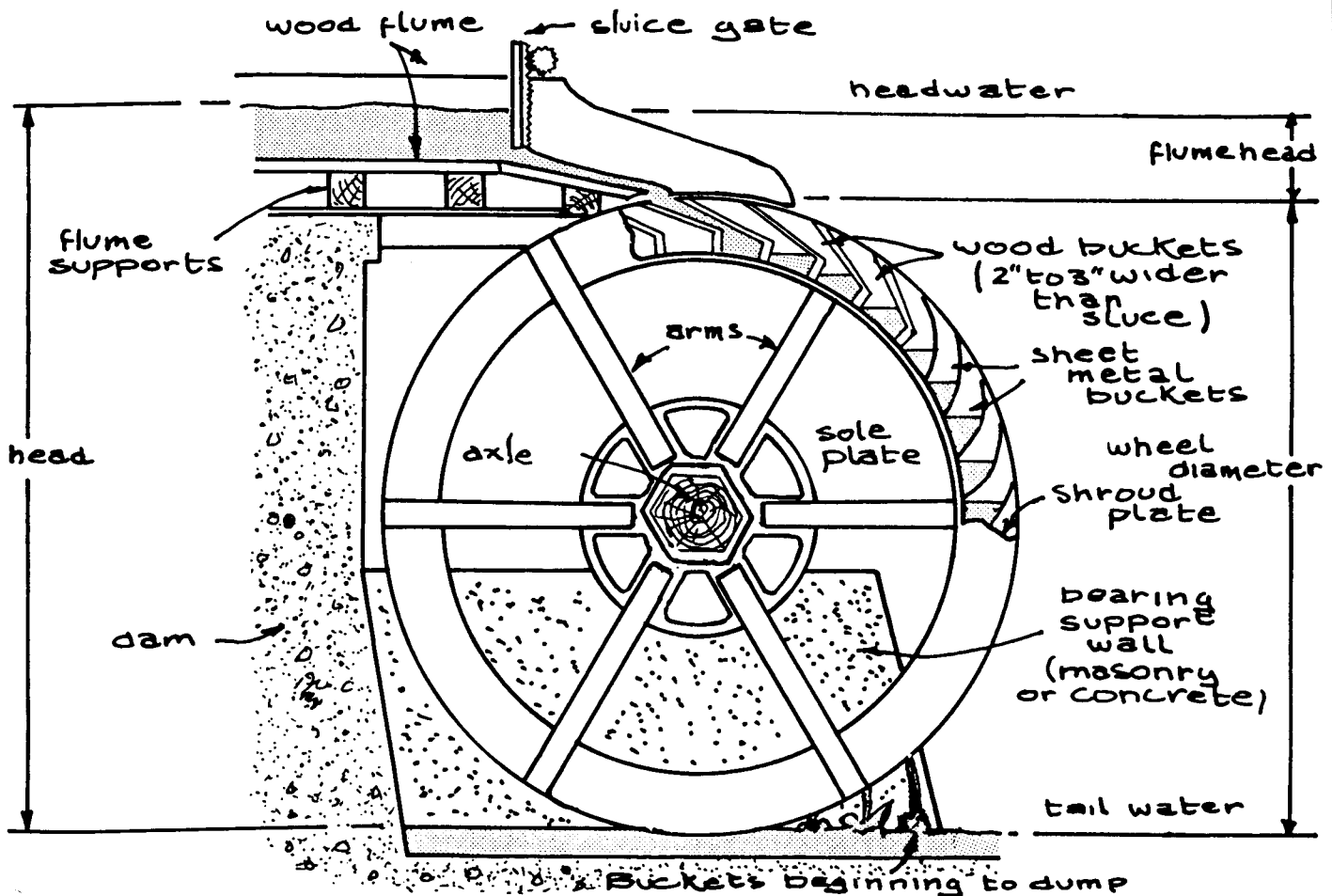

FLUME-3/4" SEASONED HARDWOOD

1" OVERHANG

kingdon

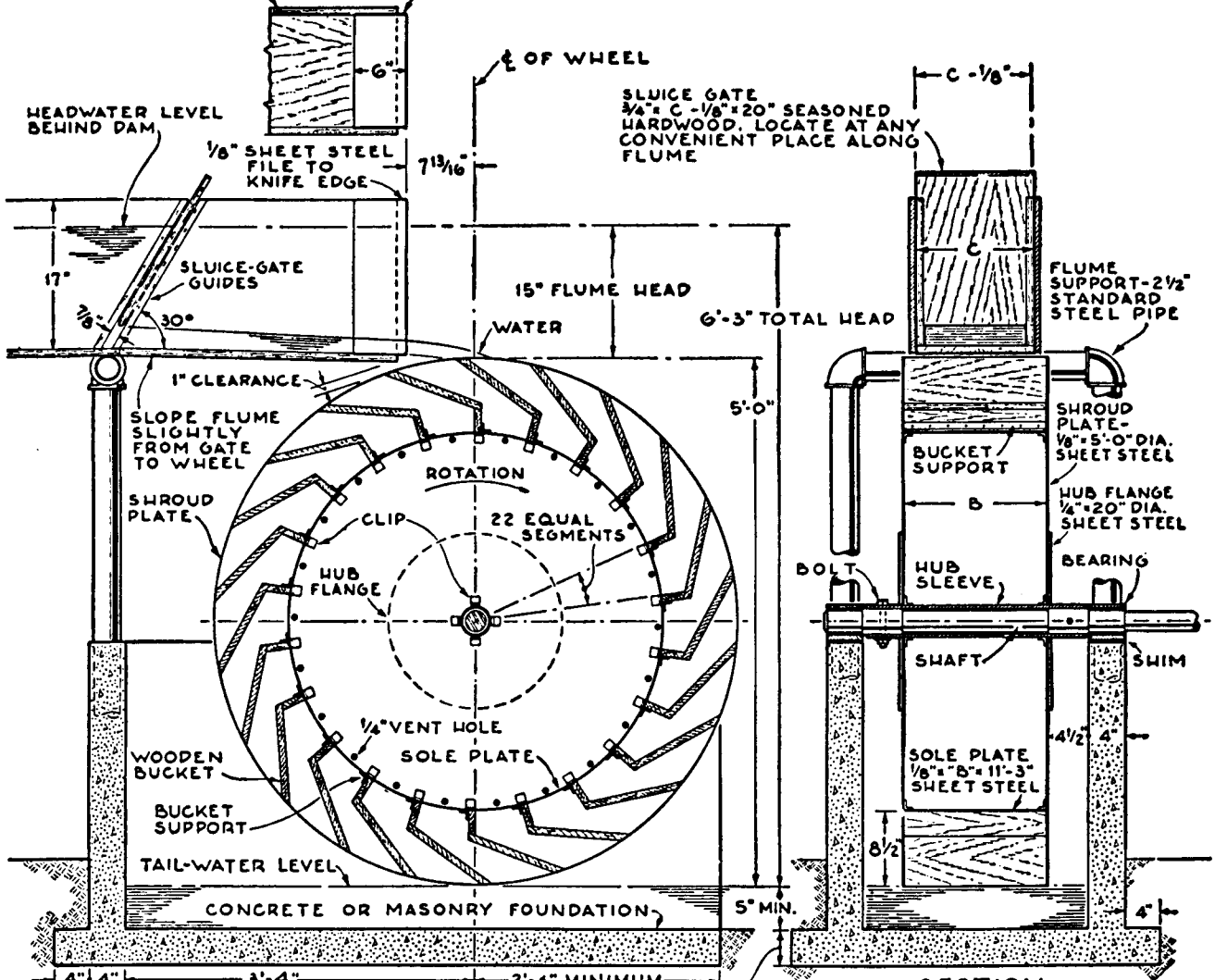

CENTERLINE ELEVATION

SECTION

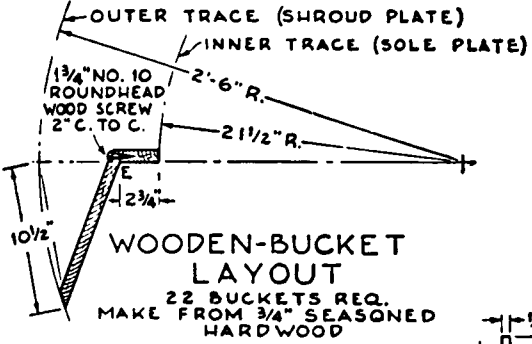

WOODEN-BUCKET LAYOUT
22 BUCKETS REQ.
MAKE FROM 3/4" SEASONED HARDWOOD

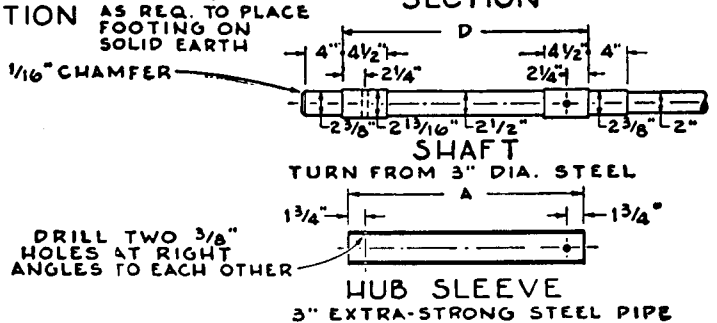

DRILL TWO 3/8" HOLES AT RIGHT ANGLES TO EACH OTHER

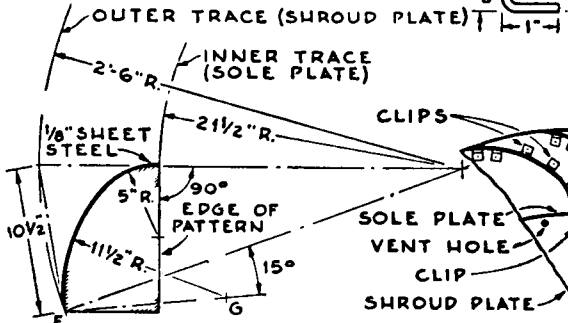

STEEL-BUCKET LAYOUT
22 BUCKETS REQ

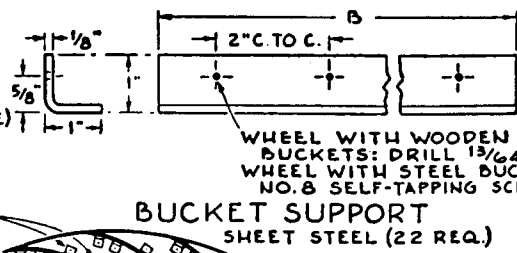

SEGMENT OF WHEEL SHOWING STEEL BUCKETS

CLIP
52 REQ. FOR WHEEL WITH WOODEN BUCKETS
272 REQ. FOR WHEEL WITH STEEL BUCKETS
MAKE FROM SHEET STEEL

DIMENSIONS				
SYMBOL	A	B	C	D
1/2 HP.	24 7/32	15 31/32	13"	25 7/32
2/3 HP.	29 3/16	21 5/16	18"	30 9/16
3/4 HP.	32 1/4	24"	21"	33 1/4
1 HP.	40 5/32	31 29/32	29"	41 5/32

Increasing the width of the wheel will boost its horsepower output. All other dimensions remain the same.

Water Wheel Design

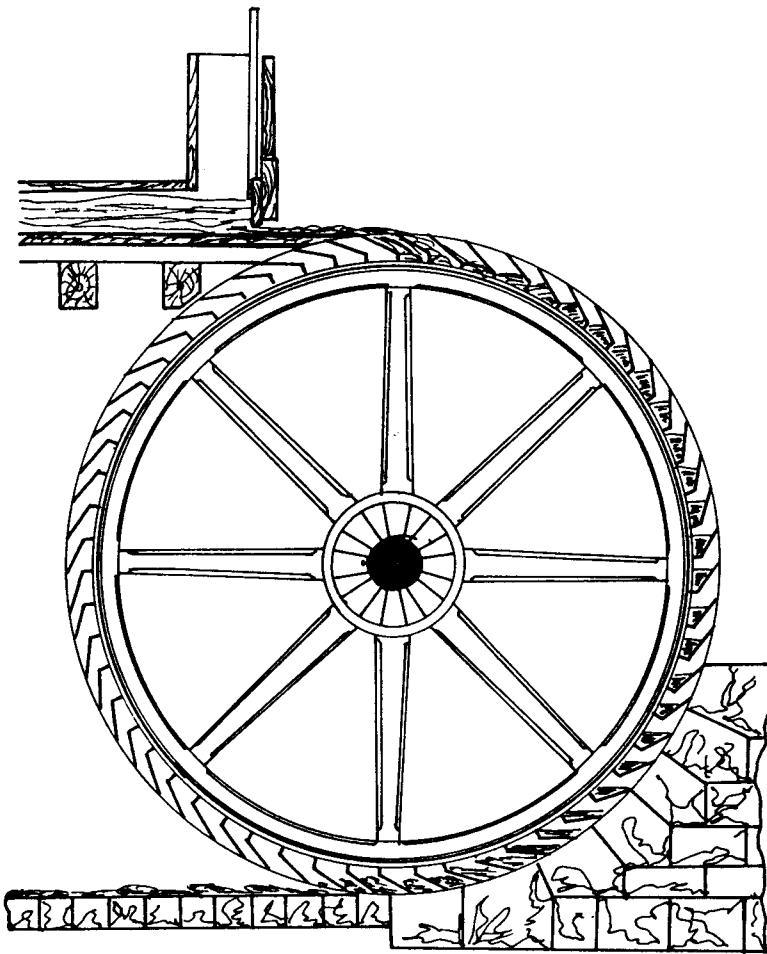

figure 1

Choice of Wheel

There are three basic types of traditional waterwheels. The overshot wheel takes water in at the top and discharges it at the bottom. The breast wheel takes water in somewhere in the middle of the wheel and discharges it at the bottom. The undershot wheel (Poncelet) both accepts and discharges water at the bottom.

The choice of wheel design depends largely upon its location. If you have a high head of water (20 ft. or more) then an overshot wheel is a good choice because a fairly narrow wheel (small volume) can be built, and no complicated breastworks are required. A disadvantage of the overshot wheel is that it requires an elevated feed trough, and a power license (since the water is taken out of the stream bed).

A breast wheel is suitable for falls of between 5 and 15 feet. It is more difficult to build because a breastwork (a shaped shoulder under the wheel designed to retain water on the wheel) is required, and the wheel must be wider to get the same power out.

A poncelet undershot wheel is suitable for falls under 7 feet. It must be very wide (for the same power), and requires a fitted race beneath the wheel.

For heads of 50 feet or more, a Pelton wheel is a good choice. Pelton wheels require very little water and a long feed pipe.

Overshot and High Breast Wheels

The simplest and most efficient of traditional waterwheels are the overshot and high-breast wheels. Water enters at or near the top of the wheel, is carried down one

side of the wheel in buckets, and is discharged at the bottom. The power of the wheel is not derived from the speed of the water entering the wheel, but from the force of gravity acting on the loaded side of the wheel — thus deriving the classification of “gravity wheels” (as opposed to impulse wheels, and turbines). Gravity wheels in general are large in diameter, and operate at slow speed with high torque.

Overshot: An overshot wheel (Fig. 1) is usually constructed with a nearly horizontal feed trough such that the water will enter the buckets with a velocity somewhat greater than the wheel so as not to be struck by the back of the buckets and be thrown off the wheel. A sluice gate is generally provided at the end of the pentrough to regulate the amount of water in the feed trough. An important modification of the overshot wheel is the pitch-back wheel, in which the direction of waterflow is reversed in the pentrough so that water may smoothly enter the wheel, and exit so that the bottom is 8 or 9 inches above the tailrace (level of mill pond), then the direction of the water will be reversed as the water falls out of the wheel into the tailrace, thus allowing a pitch-back wheel to rotate in the opposite direction, and use a straight pentrough feed.

A weakness in the design of overshot wheels is that water begins to be discharged at a point above the bottom of the wheel, and thus escapes before it has done all the work due to the fall. Three solutions to this problem are: (1) use a curvilinear form of bucket, (2) only partly fill the buckets (build a wider wheel), (3) by close fitting a

by guy immega

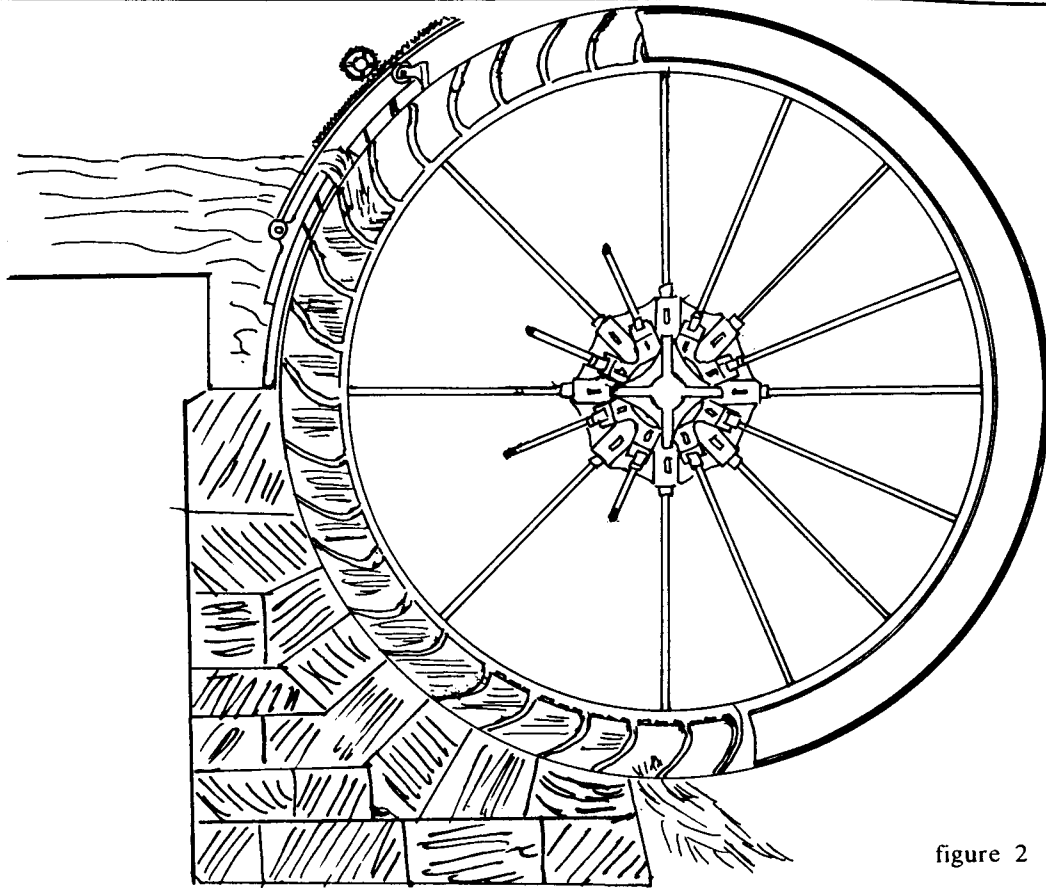

figure 2

stationary breast to retain the water on the lower half of the wheel. Overshot wheels are from 60 to 75 percent efficient, and require 12 to 10.8 cubic feet per second, to obtain one horsepower per foot of fall.

Breast-wheels: Breast-wheels generally receive water below the top of the wheel, and have a close fitting breast to keep water on the wheel. Some designs include a curved feed sluiceway which is lifted to obtain closure — rather than lowered — so that water entering the wheel will be at maximum possible elevation; this scheme allows the water to enter the wheel at variable levels, according to the height of the river. The design of this sluiceway is more complicated as it usually is curving to fit the wheel, and must fit tightly at the bottom so as not to leak water to a lower portion of the wheel. After the sluiceway, there are often guide plates to divide the water into the wheel.

The design of the buckets on breast wheels is different from overshot wheels. The difference is that the buckets are ventilated so as to allow air to escape as they are being filled. This obviates the problem of incomplete filling. There are two basic types of ventilated buckets: with and without a sole-plate. The sole-plate is a hoop of material as wide as the wheel which isolates the back of the buckets from the inside of the wheel. Ventilated buckets without a sole-plate allow air and excess water to vent to the interior of the wheel. Ventilated buckets with a sole-plate allow air and excess water to vent to the next highest bucket. Obviously, the ventilated bucket with sole-plate is the most efficient.

In high-breast wheels of 25 feet in diameter or larger, the breast is not required as the buckets have narrower openings (as with an overshot wheel), and retain water longer on the wheel. In this case, the loss due to spilling does not warrant the effort involved in building a high and

close fitting breast. Breasts can be constructed from wood and sheet metal, or from masonry. To be most efficient, they should be close fitting. With a close fitting breast, care must be taken to avoid having large foreign objects enter the wheel as they will get caught between the wheel and the breast and cause damage. Breast wheels should always be mounted above the tail water, and the bottom of the breast itself should stop about 10 inches from the extremity of the vertical diameter of the wheel. Both precautions are designed to prevent wheel drag. The efficiency of breast wheels is about 60 per cent.

Wheel speed: The speed of the periphery (edge) of overshot and breast water wheels is usually between 4 and 6 feet per second. A minimum velocity of 3 feet 6 inches per second is standard for falls of 40 to 45 feet, and a maximum velocity of 7 feet per second is standard for falls of 5 or 6 feet. In general, the higher the fall, the slower the edge speed, and vice versa; the formula is s equals $7.44 \cdot h^{.088}$ where s is speed in ft. per sec., and h is height of fall in feet.

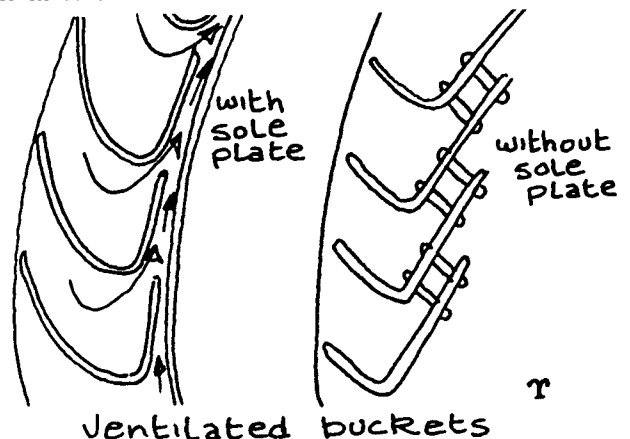

Wheel Buckets: Bucket aperture is the narrowest distance between buckets measured perpendicularly to the direction in which the water enters the wheel. Bucket aperture varies according to how high up on the wheel the water enters. The aperture should be from 5 1/2 to 8 inches for high breast wheels, and from 9 to 12 inches for low breast wheels. Note: bucket aperture is different from bucket spacing.

The area of opening of the buckets is the product of bucket aperture times the length between the shroud (inside width of wheel). For overshot and high breast wheels, 1 square foot area of opening per 5 cubic feet of bucket capacity is usual; for breast wheels which receive water at a height of not more than 10 degrees above the horizontal diameter, 1 square foot area of opening per 3 cubic feet of bucket capacity is usual. With these proportions, the depth of the shrouding (depth of bucket toward centre of the wheel) is assumed to be about 2 to 2 1/2 times the bucket aperture.

The spacing of buckets, or their distance apart, should be from 1 to 1 1/2 feet. The approximate formula is n equals $2.5d$ where n is the number of buckets, and d is the diameter of the wheel.

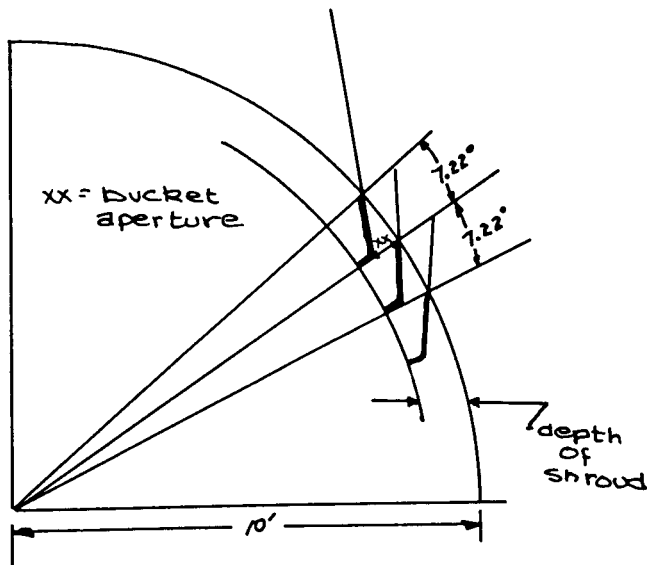

Overshot Wheel Bucket Design

figure 4

The shape of buckets is important to the operation of the wheel. The ideal shape is a curvilinear one, but often it is more practical to approximate the ideal with straight sections. For overshot wheels (Fig. 4), a convenient method for determining the bucket shape is to draw one radius inclined 34 degrees from the horizontal, and a second radius exactly one bucket arc (determined from the computed number of buckets on the wheel) below it; if a vertical line is drawn through the point determined by outer edge of the wheel and the first radius, then the bucket shape is defined by the vertical line and the second radius. The depth of the shrouds (the shrouds are the outer sides of the buckets — they determine the depth of the buckets, measured towards the centre of the wheel) is usually twice the bucket aperture (bucket aperture being the smallest dimension between buckets, and not bucket spacing).

Breast Wheel Bucket Design

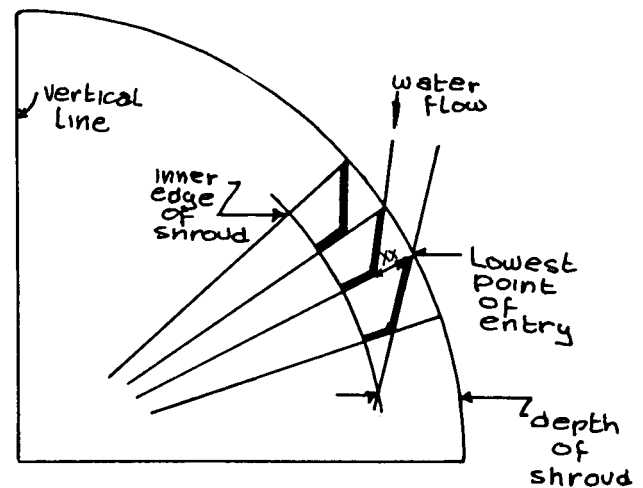

figure 5

The shape of the buckets for breast wheels is determined slightly differently. The wheel is planned so that the point and angle at which water enters the wheel is known; entry should be nearly tangential. Since the breast of a breast wheel is designed to keep the water on the wheel, the bucket shape need not be designed to hold water all the way to the bottom, therefore, the bucket shape (Fig. 5) is planned to allow maximum ease of water entry, which means that the initial angle of entry of water determines the shape of the bucket. To be precise, a line is drawn from the bottom edge of the feed trough in the direction of water flow to the wheel. Through the point where this flow line intersects the outside edge of the wheel, draw a radius. Draw a second radius exactly one bucket arc (determined from the computed number of buckets on the wheel) below it. The bucket shape is then defined by the flow line, and the second radius. The depth of the bucket is again 2 to 2 1/2 times the bucket aperture.

Design Computations: The design of a waterwheel is done according to the following steps. First the height of fall, and the volume of flow of the stream are determined. The amount of power available can then be computed. Next, the type of wheel should be selected: overshot wheels are easier to build, breast wheels can use lower falls; the selection of wheel will determine its diameter. The form of bucket is next determined. The computed edge speed of the wheel, and the volume flow of the stream, will determine the volume capacity of the bucket necessary (Note: the buckets should never be more than 1/3 to 1/2 filled). The volume capacity of the buckets will fix the necessary breadth (width) of the wheel.

As an example, suppose you have a little stream (30 inches wide and 6 1/2 inches deep) with a flow of 200 ft.³ per min. which has a head of 20 ft. This makes 7.87 horsepower (for power calculations, see page 40) available. If you wish to build an overshot wheel on this creek (it's the simplest to build), the diameter of the wheel will be twenty feet.

The number of buckets is n equals $2.5 (20) \text{ equals } 50$ buckets; one bucket arc equals $360/50 \text{ equals } 7.22$ degrees. From the geometry of the wheel, it is determined that the depth of shroud is about 1.12 ft. or $12 \frac{3}{4}$ inches. The distance between buckets equals the circumference of the wheel divided by 50 equals $20 \pi/50 \text{ equals } 1.25$ ft. bucket. The edge speed of the wheel is s equals $7.44 - 20(.088) \text{ equals } 5.69$ ft. per second.

Therefore the number of buckets which pass the feed sluice per second is the edge speed divided by the bucket spacing: $5.69 \text{ ft. per sec. divided by } 1.25 \text{ ft. per bucket equals } 4.55$ buckets per sec. The volume flow of the stream is 200 cubic feet per minute, which equals 3.33 cubic ft. per sec. Therefore the amount of water each bucket must hold is the volume flow of the stream divided by the number of buckets per second which is $3.3 \text{ cu. ft. per sec. divided by } 4.55 \text{ buckets per sec. equals } .69$ cubic ft. per bucket. The sectional area of each bucket is the area of the wheel minus the area of the wheel to the bottom of the buckets, divided by 50 buckets: $(\pi \times 10 \text{ squared minus } \pi \times 8.98 \text{ squared}) \text{ divided by } 50 \text{ equals } (314 - 254) \text{ divided by } 50 \text{ equals } 1.2$ square feet. Therefore the breadth of the wheel must be volume of the bucket divided by the sectional area equals $.69 \text{ cubic ft. per bucket divided by } 1.2 \text{ square ft. per bucket equals } .572$ feet wheel width. Since each bucket must be only $1/2$ to $1/3$ full, the breadth of the wheel should really be about $1 \frac{1}{2}$ feet.

Checking the geometry, the bucket aperture is about 5 inches (assuming one half inch thickness of wood in the bucket). The aperture times the wheel breadth equals about .6 sq. ft. opening per 2 cubic feet total bucket volume, which is the same as 1 sq. ft. bucket opening per 3.3 cu. ft. bucket volume. Therefore the area of opening of the bucket is rather larger than the ideal, 1 sq. ft. to 5 cu. ft. volume. This means that the outer boards of the bucket should be larger and closer to back of the preceding bucket. This would both decrease the area of opening, and help retain the water on the wheel for a longer time.

Poncelet Wheel

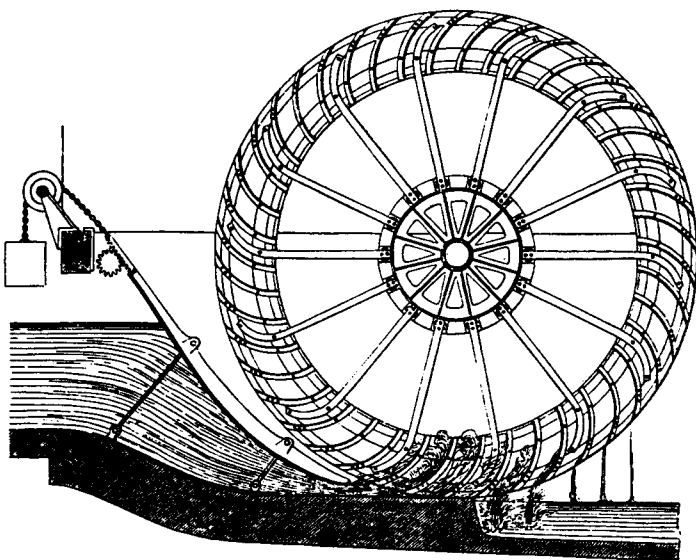
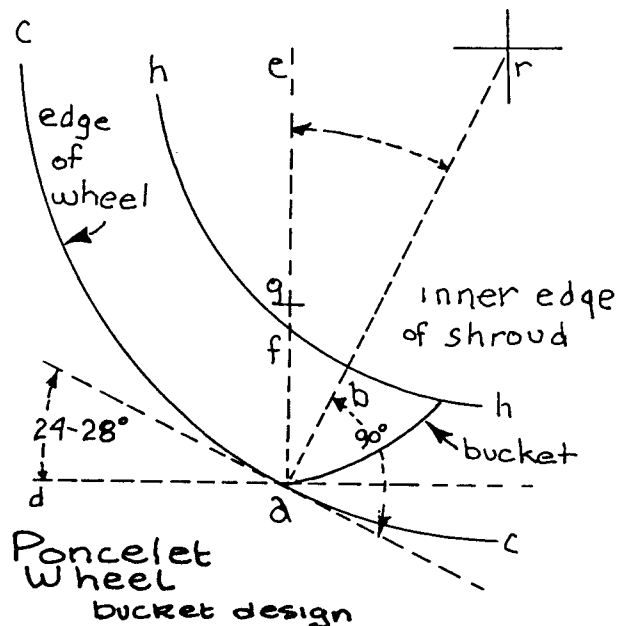

figure 6

Undershot Wheels

A well designed low breast wheel is, in effect, an undershot wheel. It is, of course, a gravity wheel because the weight of the water causes the wheel to turn. There is another class of undershot wheels which are called impulse wheels, because it is the velocity of the water striking the wheel which causes it to turn. The conceptual ideal of an impulse wheel is to extract all the kinetic energy from moving water, reducing the forward velocity of the water to zero, and afterward letting it drain vertically downward. For this to happen, the edge speed of the wheel must be one half the velocity of the water.

Primitive impulse undershot wheels were very imperfect in this respect, as the speed of the tailrace was considerable. The Poncelet wheel (fig.6), however, is quite effective, being as good or better than a low breast wheel, and giving efficiencies of better than 60 percent.



Poncelet Wheel
bucket design

figure 7

The buckets on a Poncelet (fig.7) wheel are curved, and open toward the interior of the wheel. To lay out the shape of the buckets, draw an arc cc as part of the external circumference of the wheel, and draw ar to be the radius of the wheel. Let ab equal $1/3$ to $1/4$ the height of fall, and draw hh as the inner circumference of the shrouding. Let the water first strike the bucket at the point a , from the direction da , so that the angle ear will be from 24 degrees to 28 degrees. On the line ae , draw fg equals $1/6$ af . From the centre g , with a radius ga , draw an arc from point a to the inner edge of the shroud; this arc describes the shape of a Poncelet wheel bucket. With less efficiency, this shape may be approximated with two or three straight boards.

The number of buckets on the wheel is determined by the formula $n \text{ equals } 8/5d \text{ plus } 16$, where n is the number of buckets, and d is the diameter of the wheel. The velocity of the water entering the wheel may be approximate by measuring the volume flow into the wheel (upstream) in cubic ft. per min. and dividing this by the area of the opening to the wheel in feet squared, yielding an answer in ft. per minute water speed. To obtain maximum power from the wheel, the edge speed of the wheel must be one half the water velocity.

The bottom 18 to 20 inches of the wheel must be very carefully fitted to the race for efficient operation. Also, the tail-race should expand in width and depth to keep the wheel clear of backwater.

The wheel shown in the figure was 16 feet 8 inches in diameter, and 30 feet wide, and was driven by a fall 6 feet 6 inches high, yielding 20,000 cubic feet per minute. With an edge speed of 11 to 12 feet per second, the wheel produced 140 horsepower.

Construction of Wheels

Since the speed of water wheels is generally low, they tend to deliver power at high torque, therefore, the axle of the wheel must be very strong. The 6 hp. overshot wheel in the previous example will deliver 5 or 6 times the torque of an automobile engine. Therefore a large wooden beam (railroad tie) or tractor axle will be necessary. One method of avoiding torque problems and getting higher shaft speeds is to take power from the outer edge of the wheel; this was usually done with cogs which are not common today. So it is tricky mechanically.

All gravity wheels must be very strongly built, as they must support the weight of the water on the wheel. Poncellet wheels may be lighter in construction, since they do not support any water weight.

There are two basic methods of wheel construction, the first is to have the spokes of the wheel support weight by compression. The second is to have the spokes support the wheel by tension; a wheel of this type was once built with chains as spokes — but this is not recommended. Most wheels operate on a combination of these principles.

New Work: My researches in water wheels have led me to several new design ideas. The first is a valve ventilated overshot wheel. This would allow the bucket openings to be much smaller, while having the buckets fill more quickly and empty later, and thus keep the water on the wheel longer. Simple plastic flap valves might work well.

A second design I've been working on is an impulse wheel midway in head and volume flow between the Poncellet wheel and the pelton wheel. This wheel would handle heads of about 20 to 50 feet in the form of water falls. This would allow small diameter highspeed wheels to be used, without expensive feed pipes.

Finally, I have been working on an impulse wheel design which will accept water near the center of the wheel, rather than tangentially. This would increase the speed of the wheel; making it more useful for electrical power generation.

Another device I have designed and built working models of is a "constant flow sluice." This sluice has a constant outflow of water no matter how much the input changes (above a certain minimum). The sluice is useful in situations where only a small portion of a rather large flow is needed and under low head conditions (for instance, feeding a Michell turbine). The regulation of water flow is accomplished by a low dam with a very low level to several inches above normal stream level. Most of the water flows over the dam, but the sluice later is taken from a pipe under the dam. This sluice water can be regulated again by a second small dam lower than the first.

plan view of constant flow sluice with single stage of regulation

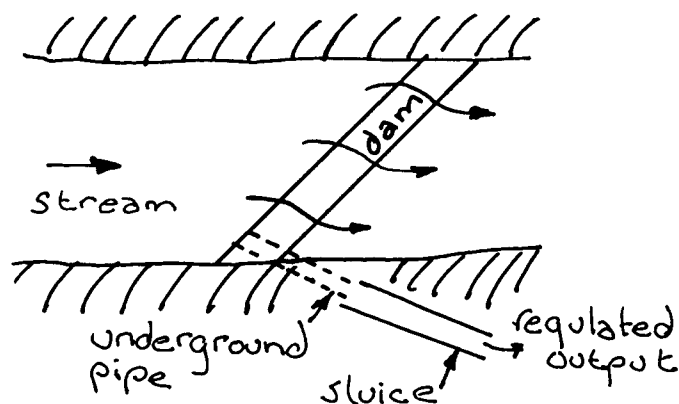

plan view of constant flow sluice with two stages of regulation

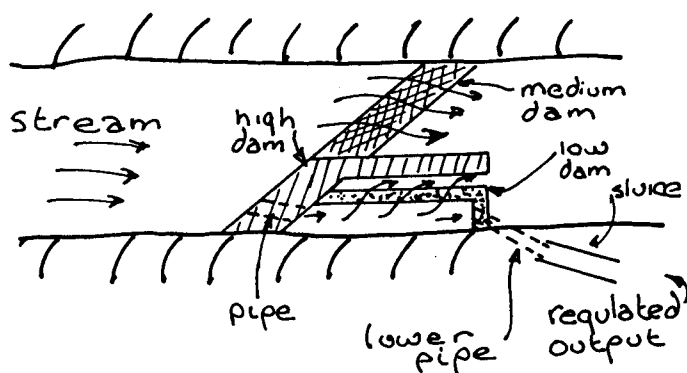

figure 9

The advantages of the sluice are that it requires no adjustments, and that it is easy to build.

If anyone wishes to work on these or other new designs, please contact me at address below.

Assistance: If anyone needs help on the design or installation of a water wheel, I will be glad to assist. Contact by mail to:

Guy Immega
P.O. Box 3952
Vancouver 3
British Columbia

Bibliography

Mills and Millwork
by Sir William Fairbairn
Longmans, Green and Co.
London, England
1888.

Power Development of Small Streams
by Carl C. Harris and
Samuel O. Rice

Reprinted from:

Low-Cost Development of Small Waterpower Sites

VITA

College Campus
Schenectady, N.Y.

The Michell (Banki) Turbine

Arrangement
for low-head
use without
control

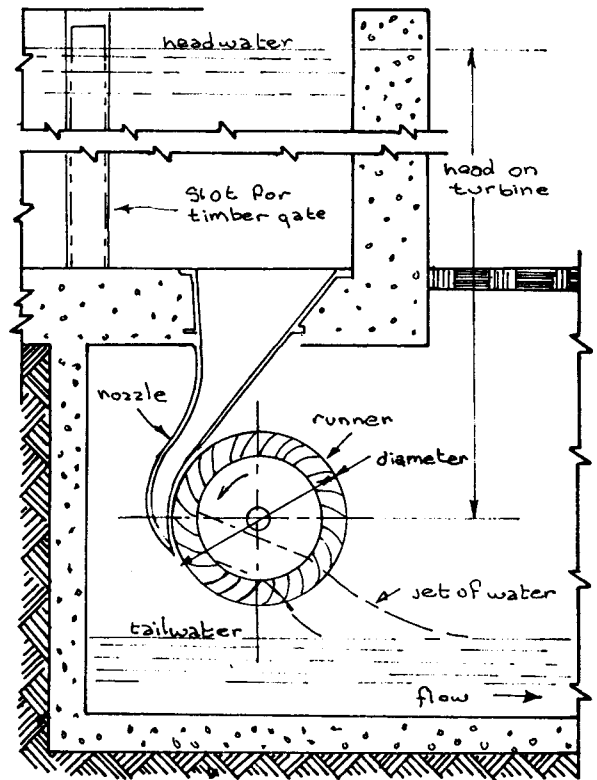

The Michell (or Banki) turbine is simple in construction. Welding equipment and a small machine shop like those often used to repair farm machinery and automotive parts are all that is necessary.

The two main parts of the Michell turbine are the runner and the nozzle. Both are welded from plate steel and require some machining. Figures 1 and 2 show the arrangement of a turbine of this type for low-head use without control. This installation drives a direct-current generator with a belt drive. Because the construction can be a DO-IT-YOURSELF project, formulas and design details are given for a runner of 12" outside diameter. This size is the smallest which is easy to fabricate and weld. It has a wide range of application for all small power developments with head and flow suitable for the Michell turbine. Different heads result in different rotational speeds. The proper belt drive ratio gives the correct generator speed. Various amounts of water determine the width of the nozzle (B1, figure 2) and the width of the runner (B2, figure 2). These widths may vary from 2 inches to 14 inches. No other turbine is adaptable to as large a range of flow.

The water passes through the runner twice in a narrow jet before discharge into the tailrace. The runner consists of two side plates, each 14" thick with hubs for the shaft attached by welding, and from 20 to 24 blades. Each blade is 0.237" thick and cut from 4" standard pipe. Steel pipe of this type is available virtually everywhere. A pipe of suitable length produces four blades. Each blade is a circular segment with a centre angle of 72 degrees. The runner design, with dimensions for a foot-long runner, is shown in Figure 3; and Figure 4 gives the nozzle design and dimensions. The dimensions can be altered proportionally for other size runners. Upstream from the nozzle discharge opening of 1 1/4", the shape of the nozzle can be made to suit penstock pipe conditions.

To calculate the principal turbine dimensions:

$$(B1) = \text{width of Nozzle (inches)}$$
$$= \frac{210 \times \text{Flow (Cubic feet per second)}}{\text{Runner outside Diameter (inches)} \times \sqrt{\text{Head (feet)}}}$$
$$(B2) = \text{Width of Runner between Discs}$$
$$= (B1) + 1.0"$$
$$\text{Rotational Speed (revolutions per minute)}$$
$$= \frac{862 \times \text{Head (feet)}}{\text{Runner outside Diameter (in.)}}$$

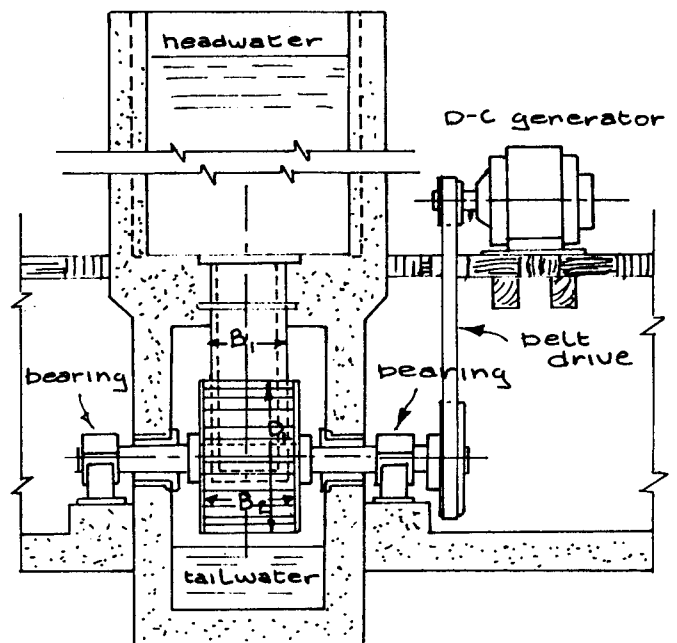

Arrangement of a MICHELL (BANKI)
turbine for low-head use
without control (3)

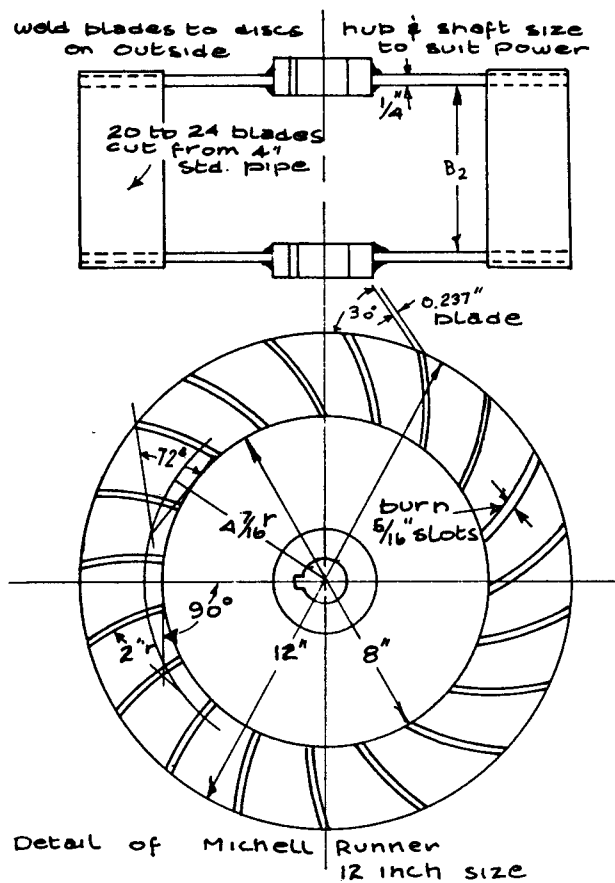

figure 3

Detail of Michell Runner
12 inch size

The efficiency of the Michell turbine is 80 per cent or greater and therefor suitable for small power installations. Flow regulation and governor control of the flow can be effected by using a centre-body nozzle regulator (a closing mechanism in the shape of a gate in the nozzle). This is expensive because of governor costs. It is, however, needed for running an alternating-current generator.

The application of figures 1 and 2 is a typical example.

For high heads the Michell turbine is connected to a penstock with a turbine inlet valve. This requires a different type of arrangement from the one shown here. As mentioned before, the Michell turbine is unique because its B1 and B2 widths can be altered to suit power-site traits of flow rate and head. This, besides simplicity and low cost, makes it the most suitable of all water turbines for small power developments.

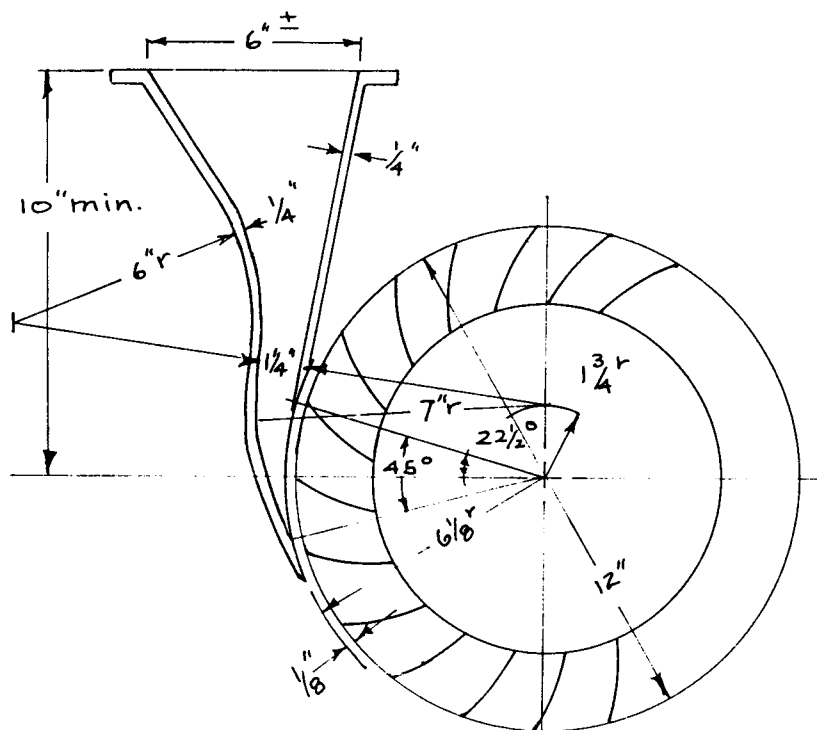

figure 4

Detail of nozzle for 12" MICHELL Runner



by glen bass

A Wooden Undershot Wheel

We divided the construction of the water-wheel into three parts: the dam, the trough (or millrace), and the wheel.

The Dam

We used a beaver-type dam. Beavers are very experienced hydraulic engineers. You would be wise to invest some time in studying their methods if you are going to mess around with a stream. You'll also have to get a power permit and water permit from the local water board.

The first thing we built was the **pier**, which is a log foundation that is embedded in one bank of the stream and lends support to the water wheel. The logs were all precut, numbered, and notched, and then assembled to form the cubic structure which is illustrated in figure 1. In this structure one side of the cube was left out and the ends of the logs were embedded sideways into the stream bed with dirt and rocks. It was then filled with more rocks.

Next we built the **pylon**. That was assembled just like the pier only it was a complete cube. Also, the pylon sits mid-stream. To install it in the stream, we laced heavy wire across the bottom of the cube to make a basket for the first layer of rocks. Then we floated the structure into position and sank it with rocks (see figure 1). In order to avoid some heavy lifting it would be easier to assemble just the base of the pylon first, or as many layers as you can carry into the stream from the bank, then position it in the stream, and add the first layer of rocks, and so on. The top layer of the pylon was foreshortened slightly (see figure 2) to provide a base for the support log which extended

from the pylon to the opposite bank of the stream. (see figure 1). This is was the backbone of the dam, so use good material. We chose a white pine log, very strong, not too heavy, and it was close to the site. To install the support log we had to make sure that both ends of the log were secured: the end resting on the bank we secured with dirt and rock, and the end which rested on the pylon was secured with wire.

Now we were ready to close the dam. This was actually the very last step in assembling the water-wheel, but we did

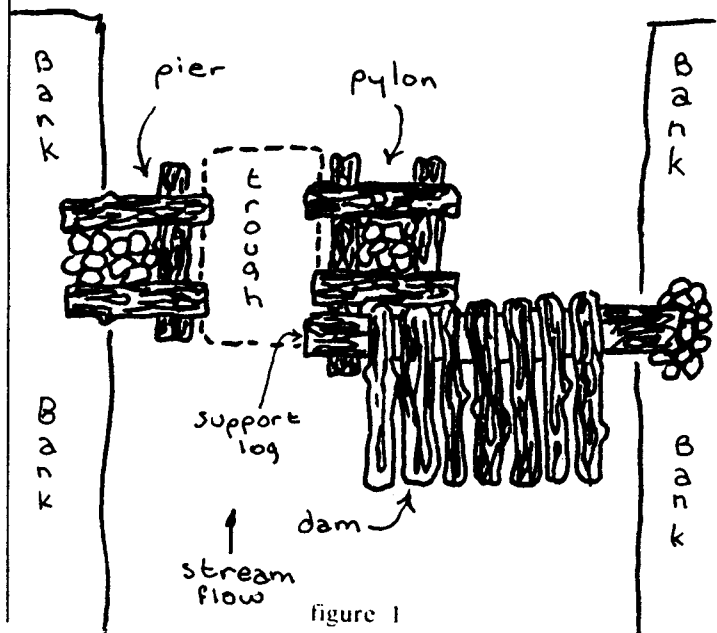

it at this point in order to test the structure before setting the wheel in place. Once the strength of the structure had been tested, the damming which was composed of brush and support logs was disassembled and then assembled again later. It was an extra day's work but it saved us a lot of trouble later.

As in any project, certain steps **must** precede others. **Before closing the dam**, the trough had to be placed between the pier and the pylon, otherwise the rushing water would cut a huge hole in the stream bed, undercut the pier and the pylon, and mess up the whole thing. The trough served to channel the water over wood rather than over the bottom of the stream so there was no washing away of stream bottom.

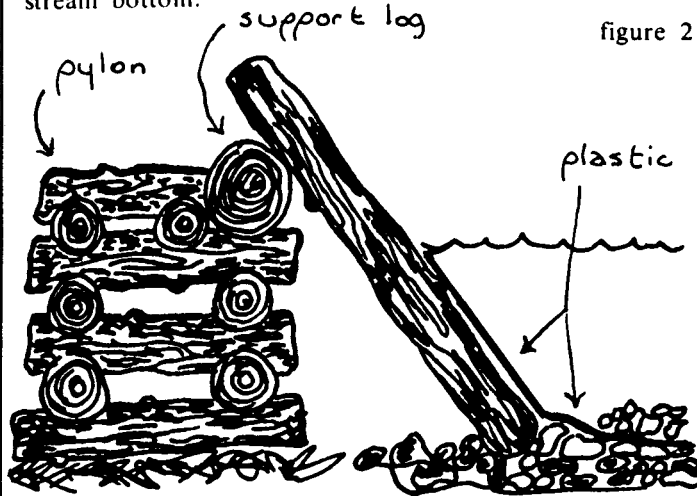

Our next step was to cut a number of small logs. They had to be long enough so that one end of the small log leaned against the support log while the other end of the small log was embedded in the stream bed and extended out against the current at an angle of 45 degrees relative to the bottom (see figure 3). The small logs were then placed as close together as possible leaning in a line along the support log (see figure 1). They were not nailed in place. Their placement at a 45 degree angle in relation to the stream bottom distributed the pressure of the rushing water: half onto the logs and half onto the stream bed itself. When all the logs were in place, the force of the water held them securely.

To complete the dam, we caulked the logs with lots of bark, brush, old hay, whatever was lying around. When doing this, however, we had to allow for the appropriate water level. We layered the packing to a level below the

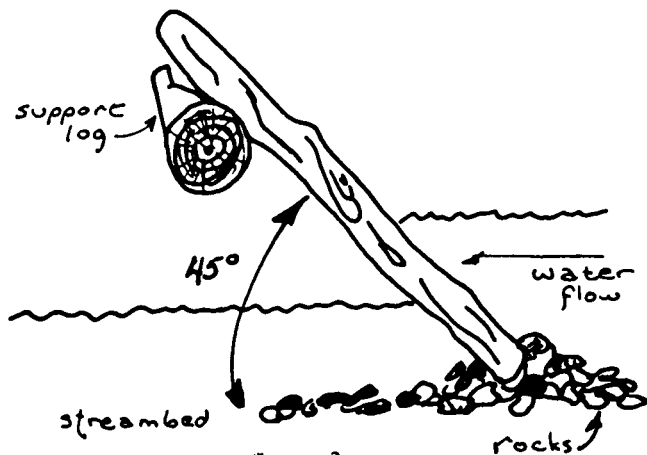

walls of the trough so that when there's an overflow, the water doesn't flow into the trough but rather flows over the dam into the stream. We then placed a sheet of plastic over the packing, anchoring it at the bottom with rocks. It extended from the proposed water level down to the base of the dam and **out into the stream bed at least 2 feet** (see figure 2). Again, the force of the water holds the material. The packing supports the plastic so that it does not balloon out between the logs. The plastic on the stream bed in front of the dam prevents undercutting. Also, the plastic was placed so that when the dam filled, the excess water, if any, passed readily between the logs above the plastic thus forming a natural spillway.

The Trough

The construction of the wheel consists of two parts: the trough or millrace and the actual wheel. The trough is not absolutely necessary but greatly increases the efficiency of the unit (by approximately 70 percent).

Here I must try to explain a little about what you are trying to do instead of how to do it. A stream may be viewed as matter (water) or as a **stream of energy**. The object is to convert some of this energy from linear motion to rotary motion. We describe the energy of the stream as either actual or potential. The actual energy is the tendency of elevated water to seek sea level, i.e. gravity. By constructing the dam, we accomplished two things: we "backed up" the stream or elevated it, and we channelled the motion into a place that would serve our purposes (the trough).

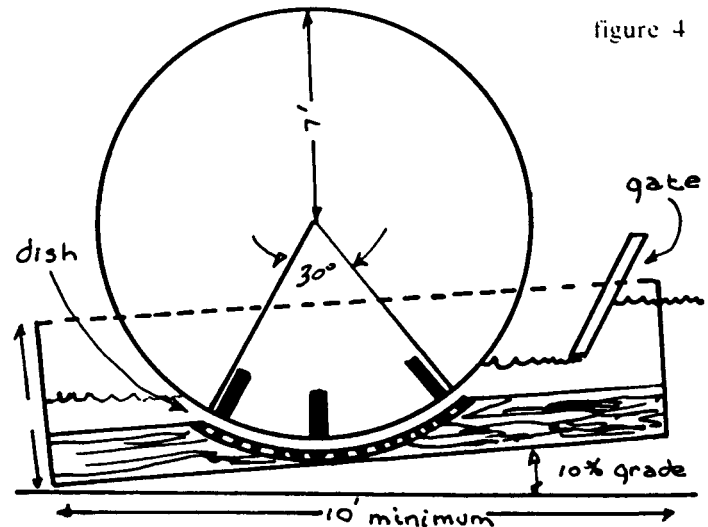

In constructing the trough we had to plan it so that the wheel would fit closely inside it, allowing at least 1 inch clearance on each side. We decided to build the trough 4 feet wide, based on equations from a textbook on hydraulics. Similar equations can be found on page 59. The trough had to be long enough to accommodate the wheel and also a gate at the front (see figures 4 and 5). The purpose of the gate was to control the flow of water through the trough in order to regulate the speed of the turning wheel. Also, the tail end of the trough had to be long enough to release the water smoothly and prevent undercutting of the stream bed in that area.

The floor of the trough has a **dish** into which the wheel fits. The size of the dish was determined as follows. We did all our plans to full scale with nails and string on the floor to avoid math errors. Draw an arc using the radius of the

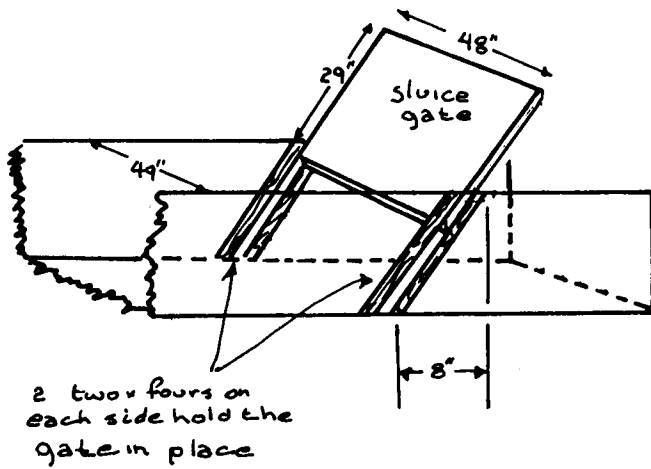

wheel (7 ft. in our case). Next draw a 30 degree angle with the apex at the centre point. Where the legs of the angle cross the arc, draw a line. This line is in alignment with the flow of the trough, and the arc is the dish (see figure 6). In our trough the dish was 4 in. deep. The 30 degree angle is important because the paddles of the wheel will be spaced 15 degrees apart. This means that as one paddle is entering the dish, another is at mid-point in the dish, and a third is at the exit point. This provides a smooth motion to the wheel.

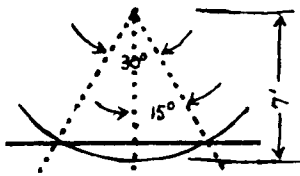
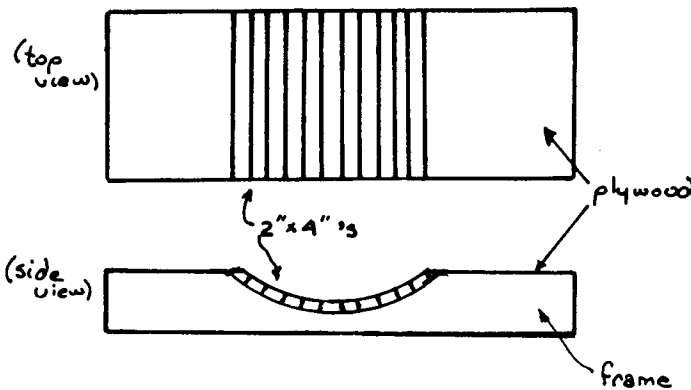

figure 6

We used 3/4-in. marine grade plywood, leaving space for the dish, of course. The floor of the dish was constructed of 2 x 4's nailed crossways in between the plywood walls (also 3/4-in. marine grade) of the trough (see figure 7).

figure 7

Trough floor & the dish



Before we installed the trough between the pier and pylon, we had to erect a structure to support the shaft of the wheel. We used two 18 ft. 2 x 6's on each side and installed them so that they were flush with the sides of the pier and pylon (see figure 8). The 2 x 6's extended well

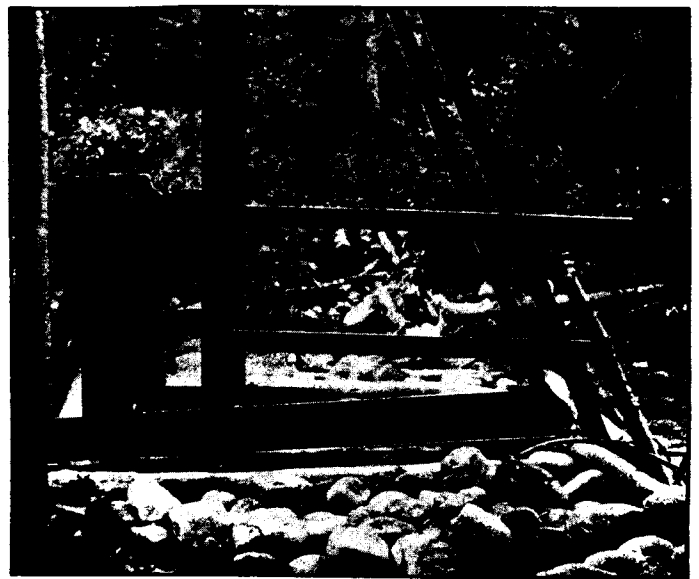

a - trough b - cross support c - wheel shaft support structure

figure 8

above the wheel and were tied together by a platform above the wheel. The cross support for the wheel shaft was made with a piece of 8"x 2 1/2" stock (see figure 9).

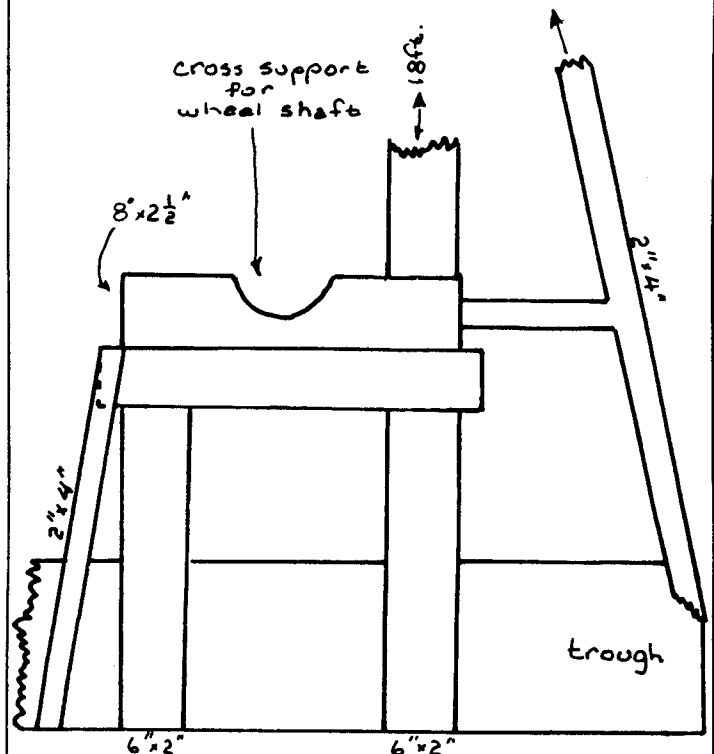
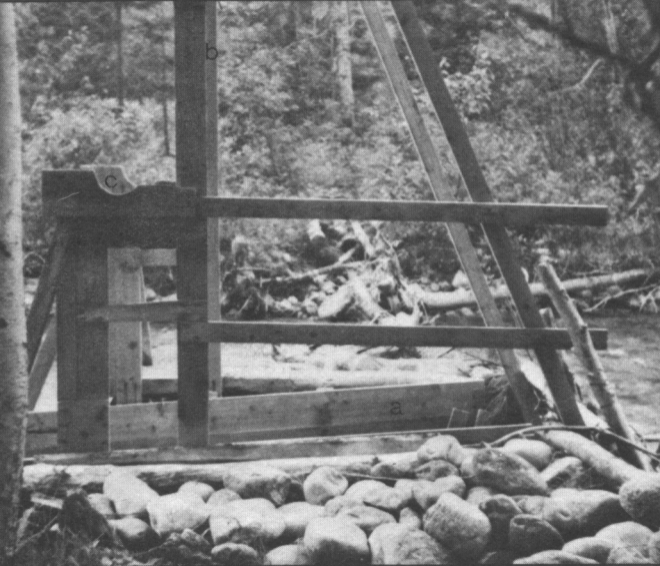

figure 9

After this was completed we nailed the trough in place between the pier and pylon. The floor of the trough was set at 10 per cent grade relative to the level of water behind the dam. For example, a 10 ft. trough would be 1 ft. higher at the front where the gate is while the other would be set at the same level as the water level behind the dam (see figure 4).



b

c

a

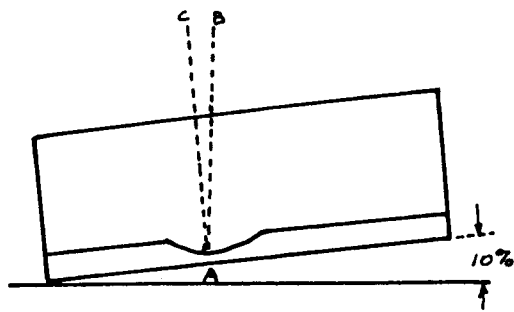
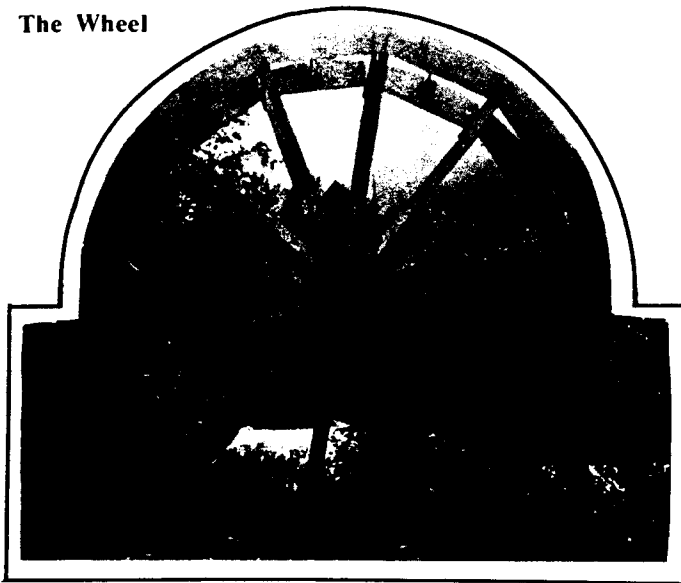

figure 9a

Remember that the shaft must be above the centre line of the "dish". Since the trough is placed on a grade the actual centre line A-C will be slightly behind the apparent centreline A-B.

The Wheel



We started with an 8" x 8" x 7' beam. For bearings we used 2 large ball-bearings salvaged from the scrap bin of a heavy equipment repair shop . . . about 9 in. in diameter (see figure 10). The ends of the shaft were rounded to accept the bearings.

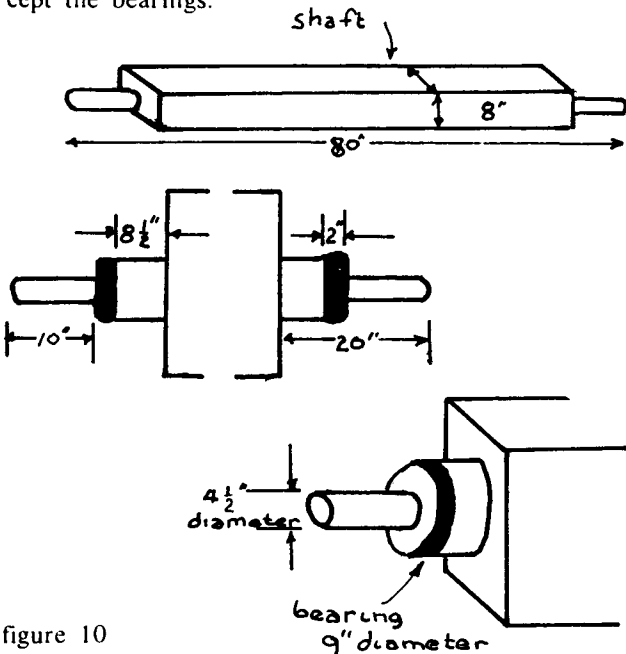

figure 10

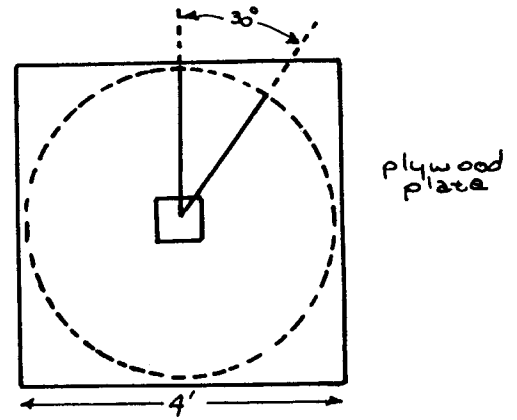

figure 11

In order to fix the spokes of the wheel to the shaft, we bought a 4-ft. x 8-ft. x 3/4-in. sheet of marine grade plywood and cut it into 4-ft. x 4-ft. squares. Then we cut an 8-in. square hole in the centre of each piece. Before cutting the 8-in. hole, we found the centre point and drew a large circle on the plywood, and then we divided the circle into 30 degree segments (see figure 11). These 30 degree lines were the centre lines for the spokes. Next we fixed the plywood to the shaft. Figure 12 illustrates how we did this: first, we inserted the rounded end of the shaft through the hole in the plywood so that the square edges in both parts were lined up, and then we fastened the plywood square onto the square part of the shaft end using four 2 x 4's (refer to figure 10 for detail of the shaft end). We used waterproof glue and ardox twist nails for all joints.

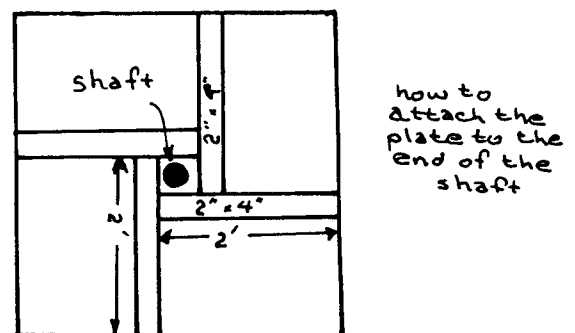
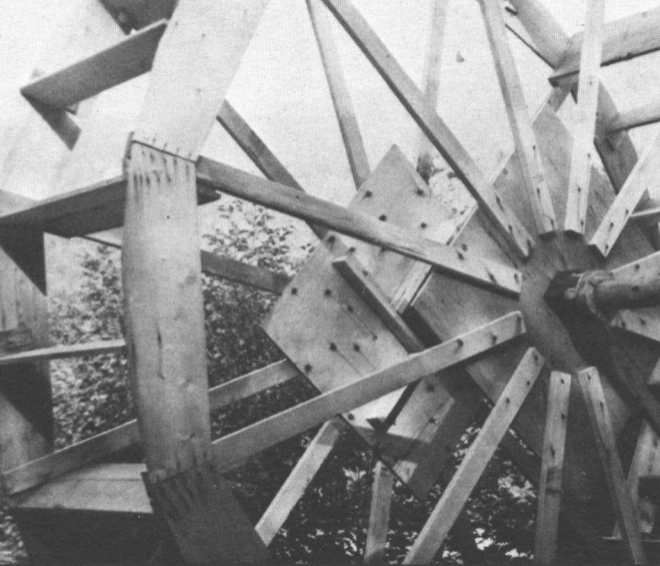

figure 12

After this we mounted the shaft on the cross support and aligned it to make sure it was true. Then we attached twelve 6-ft. 2 x 4's to each plywood plate using glue and bolts (see figure 13). By building the wheel in place, we were able to check the alignment constantly as we worked.

To join the ends of the spokes around the circumference of the wheel, we used 1" x 12" stock. On our wheel the distance between the spokes at the circumference was 44 inches (see figure 13). After the stock was attached, we rounded the outer edges.



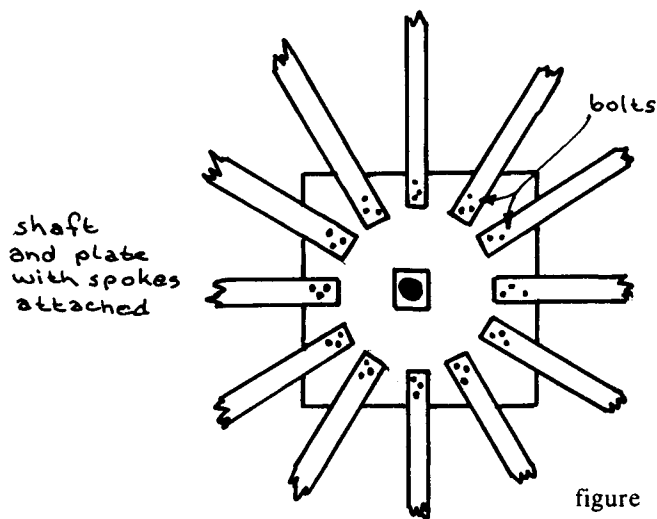

figure 13

Next we added the paddles. There were 12 paddles that were affixed to the 12 spokes, and another 12 paddles that were affixed between the spokes. The paddles affixed to the spokes consisted of two boards spanning the width of the wheel. Board 1 (see figure 14) was advanced 2 inches into the flow of the water by means of a small wedge attached to the end of each spoke, and board 2 was attached above board 1 but flush with the spoke. This created a scooping kind of paddle. The paddle affixed between the spokes was just one board and was attached to the 1" x 12" stock that was used to join the ends of the spokes around the circumference of the wheel (see board 2 in figure 14). Board 3 had to be aligned at the same angle as board 1, ie. in relation to an imaginary spoke drawn from the centre of the wheel to the 1" x 12" piece of stock adjoining the spokes. If the water flows over board 3 rather than being cupped by it, another board similar to board 2 may be attached above it to make another scooping paddle (board 4 in figure 14). Ideally the paddles would be made of curved sheet metal (with a radius of 1 ft.) but because they would have cost \$3.00 for each blade, we used wood.

Our wheel turns at 20 RPM and generates an estimated 3 HP. Now we are looking for a water pump to complete the system. Our future plan is to build a long work shop parallel to the shaft of the wheel with a high speed metal shaft running the length of the shop. Attached to the shaft we plan a deep-freeze (with motor removed), a wringer washer, a 12 V generator, a small wood-lathe, and a flour mill.

We face two problems in operating this system: (a) ice in winter, (b) high water. Removing some logs from the dam should take care of the spring flood. The ice problem we will work out when it comes. Perhaps enclosing the entire structure in a shed will solve this.

Generally we used good material throughout and spent \$130.00 on lumber, nails, glue, etc.

Aside from the fact that we feel the wheel will be a dependable (and cheap) power source the project has given us all a new sense of what energy is and how it is related to our lives.

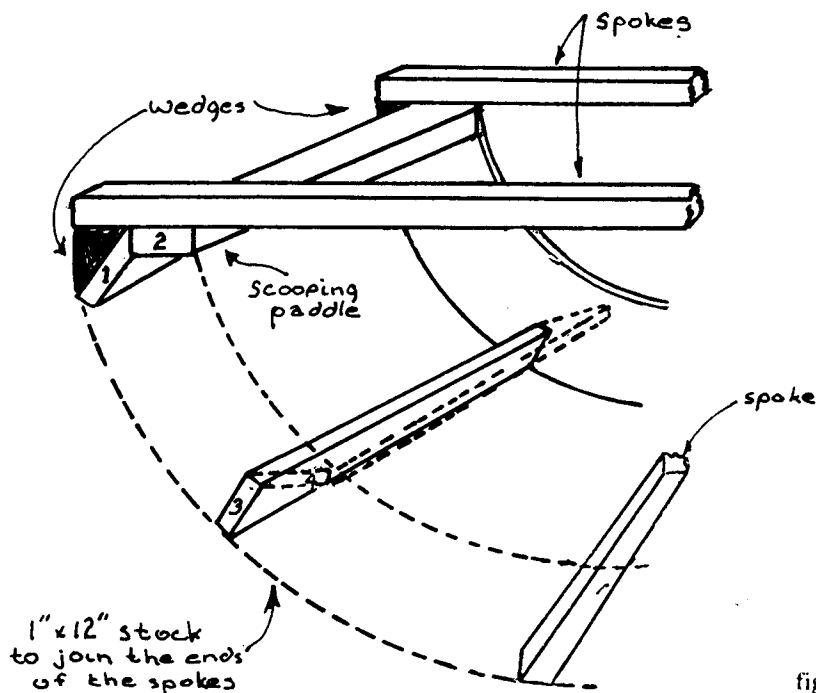
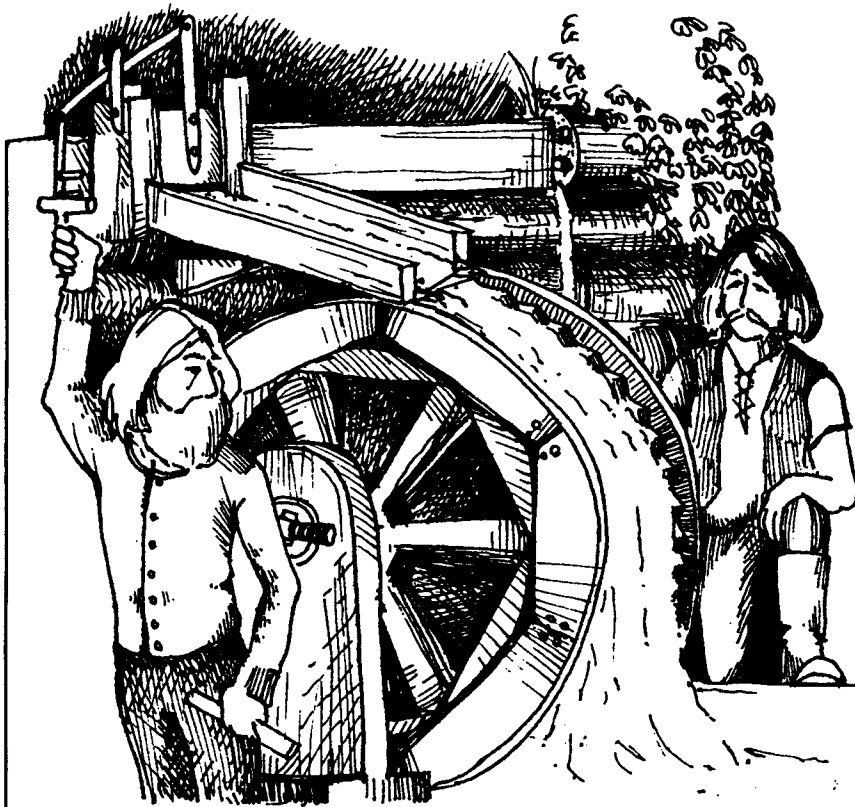

figure 14

A Wooden Overshot Wheel

by don gilmour



If you wish to build an overshot wheel, the first thing would be to measure the available power by the amount of water flowing and the distance of fall. The directions for this can be found on pages 40 to 50.

My wheel has been running continuously for two years without added lubrication or trouble. It's simply designed and easily constructed with a minimal outlay of money. With a bit of hunting for used materials, you should be able to build it for very little money.

After measuring your available water power, refer to page 55 for the best dimensions to construct your wheel. The construction requires the manufacture of five basic parts: the disc, the shrouds, the buckets, the mounting framework and the pulleys.

The Disc

To make the disk saw out a circle of 5/8" plywood 44" in diameter, and mark the center. Now nail small sections of 1" x 2" on the sides all around the rim. These pieces should be cut to the same radius or curvature as the rim of the disc. Do this on both sides. The object is to thicken the rim. Now cut a 4' x 8' sheet of 1/4" plywood into strips 15" wide. Bend the strips so that they overhang on the disc equally. Nail all around the rim like a wide tire. Nail a second layer over this staggering the joints from the first layer to give added strength and tightness.

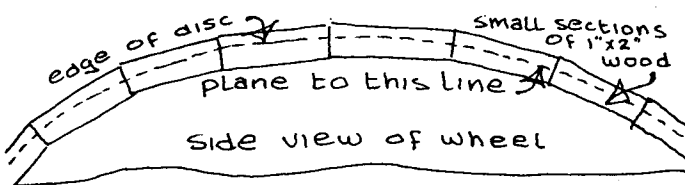

figure 1

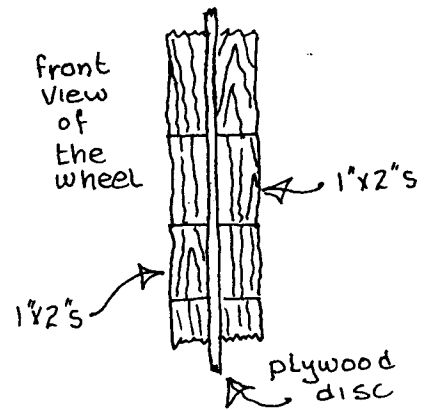

figure 2

The Shroud

The shrouds close in the sides of the bucket (see figure 3). Attaching the shrouds increases the wheel diameter to approximately 5 feet.

To construct them, cut pieces of cedar lumber into sections to match the cardboard pattern which is designed as follows:

Take a yardstick or equivalent size piece of wood and drive a nail through one end of it and into the floor. Measure 22 1/2" from this nail and drive another nail through the yardstick only. Use this 'compass' to scribe the two curved lines (figure 3) for the shroud pattern. Make the shroud pattern long enough to efficiently utilize the wood you have available. My lumber was 11" x 7/8" cedar stock.

Nails are driven through the double plywood rim into the edge of the shrouds to fasten them in place. A second set of shrouds made from the same pattern is constructed of 1/4" plywood. They are nailed on the outside of the original shroud in such a way as to cover the seam between shrouds . . . it also adds strength and increases water tightness. The neater and tighter the better.

The wheel should look something like a giant spool. You can butter up the cracks with any suitable asphalt roof patching compound or water-proof crack sealer.

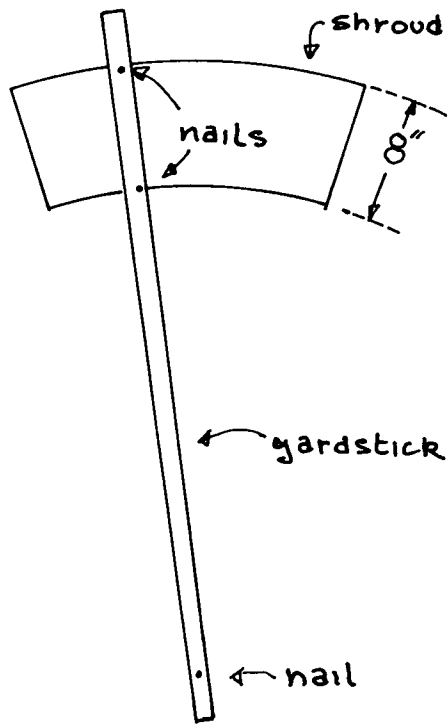

figure 3

The Buckets

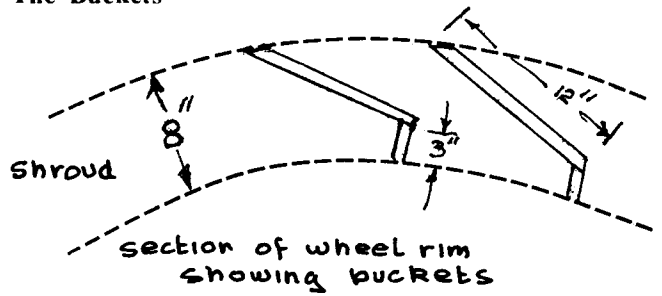

figure 4

The 12 buckets are made from fir. They are assembled and the two parts of each are nailed together on a bench before installing between the shrouds. Measure the distance between the shrouds and make the buckets to fit neatly between so they will stay reasonably watertight. The water inlet trough should be narrower than the wheel with up to 10" high sides.

Mark the location of each bucket on the wheel so they come out similarly spaced. Use your fudging faculties and divide up the spacing.

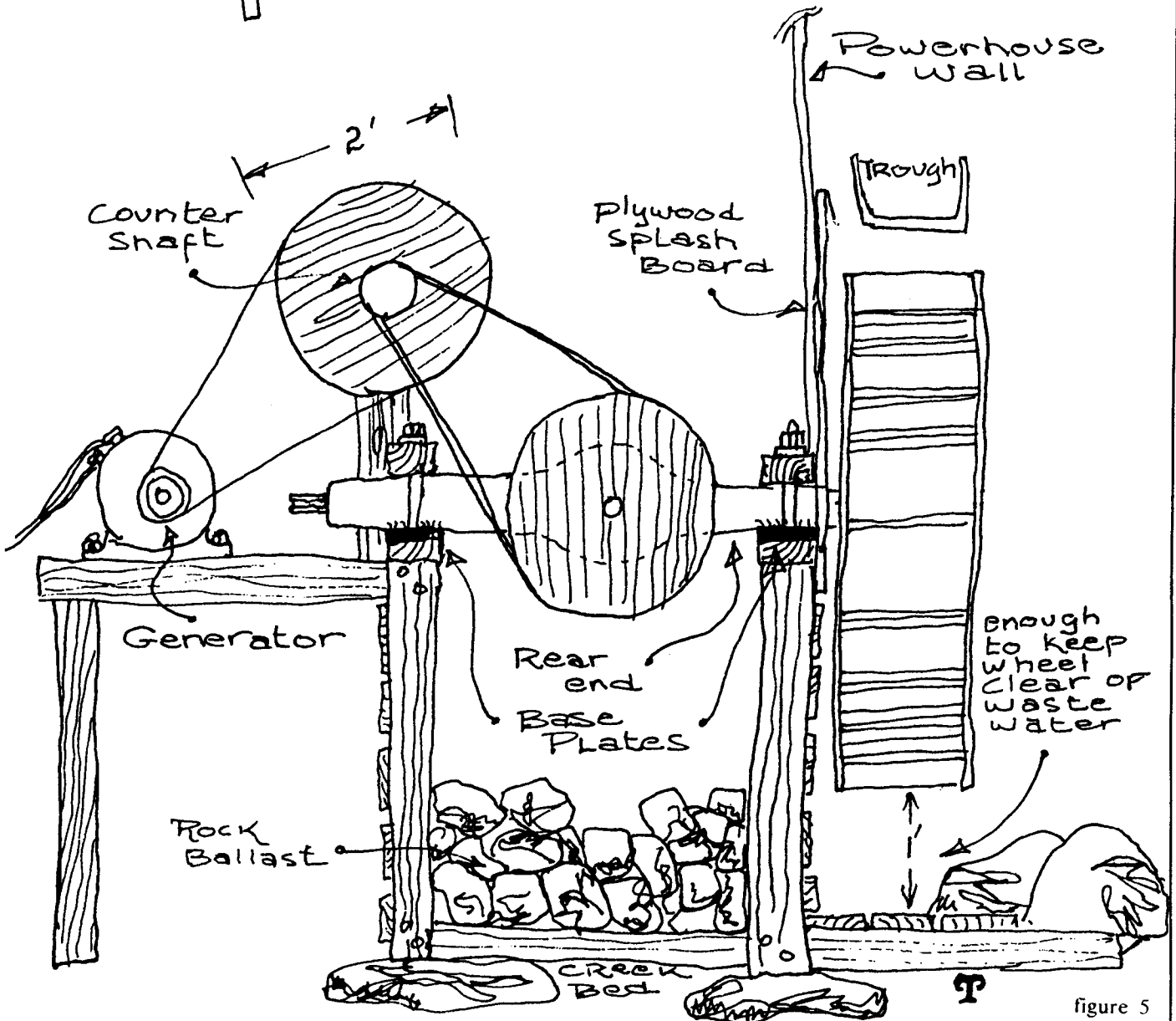

figure 5

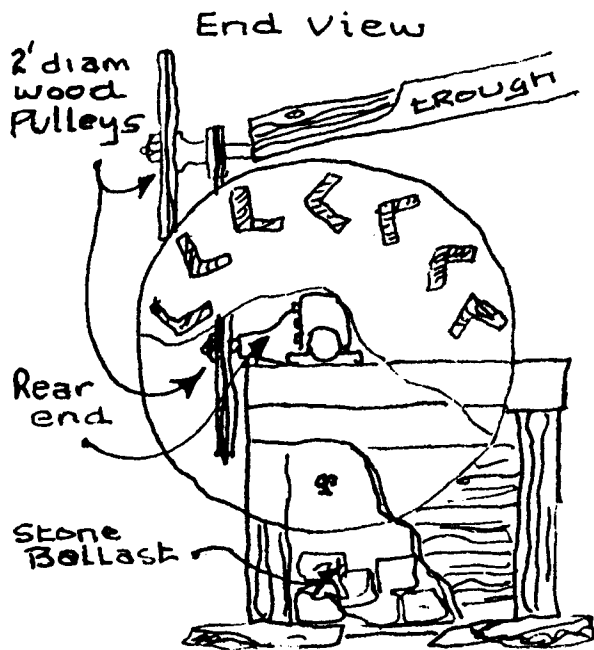

figure 6

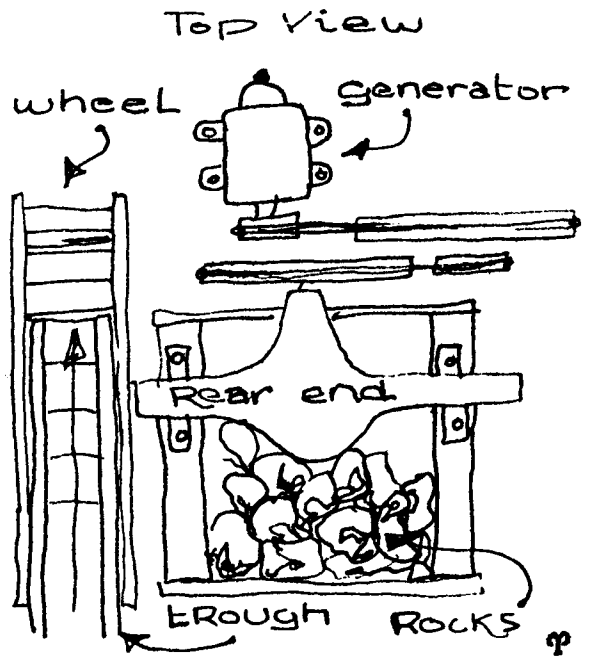

figure 7

Mounting the Wheel

Take a rear end from a full sized car and fix the differential gears so the two axles turn as one unit. You can jam these gears by welding or otherwise so they don't operate. Cut off one axle and the axle housing to get rid of the brake assembly if you wish. The other axle should be cleaned of brake parts to expose the hub and flange. You may have to knock the bolts out and get rid of the brake drum. The wooden disc of the waterwheel needs to have a hole made in its centre to closely fit the car wheel hub. Also it should be drilled to match the old bolt holes and bolts installed with washers under the nuts.

Before mounting the wheel in place have a base plate welded to the axle housing. It should be on what is to be the underside, with two holes for 1/2" lagscrews or do it your own way. Make some kind of anchor to hold the opposite housing from moving around.

If you want to do it pioneer style then hew poles square or use 4" x 4" for the framework as in the illustration. Install the rear end in place using lagscrews or bolts to hold it. Install the wheel.

Pulleys

Make two pulleys from 5/8" plywood and nail sections of 1" cedar or fir lumber on one side of the rim to widen it. These are for belt pulleys. Bolt one of them centrally onto the flange from which you removed the car drive (torque) shaft. The second pulley goes on the countershaft with a 6" x 5/8" V-pulley along side it. See what you can scrounge up. The important thing is to get the 2 ft. and 6" pulley turning as a unit and on some kind of bearings such as auto front wheels. If you make your counter shaft of grease sealed ball or roller type bearings you should have a more efficient or carefree plant.

There should be a gate to stop the water from flowing in the trough thereby controlling the speed or shutting the wheel off. It can be made to slide over the end of the

trough if the butts of planks are nice and square. It operates in the manner of a gate valve.

At the first run the wood pulley can be turned true and the rim given a slight crown (rounded groove) which helps the belt stay on. Install the countershaft, fitting the V-belt from the 2" pulley to the 6" V-pulley on the countershaft. When the countershaft is running O.K. turn the rim of its pulley and crown a little. The turning operation needs care to avoid accidents. Use a long handled chisel or scraper. One needs a firm support under the tool to operate in a manner similar to a woodlathe. A V-groove in these pulleys will wear the belt away. The slightly crowned wood face works better and runs for years without noticeable wear.

The second belt goes from countershaft wooden pulley to the generator metal V-pulley or whatever you wish to drive. A 4" pulley will be easy on the belt and give you about 1800 R.P.M. The wood pulley on countershaft can be larger diameter for greater speed.

A car generator will give you a fine lighting system if you put the battery at the house end of the line. Use No. 8 wire for a distance of 50 ft. to 100 ft., and beyond that, No. 6 wire. The generator will build up extra voltage to overcome the normal voltage drop in the line. Fifty watt bulbs are still available in 6 and 12 volts. You may still be able to find 100 watt bulbs for 6 or 12 volt systems. The bases are the same standard screw as the 110 volt bulbs so they fit standard light fixtures. A 32 volt battery system is still better than a 12 volt system.

You can get up to 500 watts of 110 volt A.C. from this wheel with an efficient, self regulating, 4 pole alternator, but it will be difficult to keep close to 60 cycles unless the load is unchanging. You won't be able to store power as you can on a battery system.

Log dams and all the woodwork which keeps wet will last for years. Parts of the wheel that are exposed to the elements should be coated with a preservative.