

AT MICROFICHE
REFERENCE
LIBRARY
A project of Volunteers in Asia

Well Construction Using Curved Hollow Block

By: C. Gampher and S. Gates

Published by: Well Construction
1100 West Main St.
Jefferson City, MO 65109

Available from: Well Construction
1100 West Main St.
Jefferson City, MO 65109

Reproduced with permission.

Reproduction of this microfiche document in any form is subject to the same restrictions as those of the original document.

Well Construction Using Curved Hollow Block

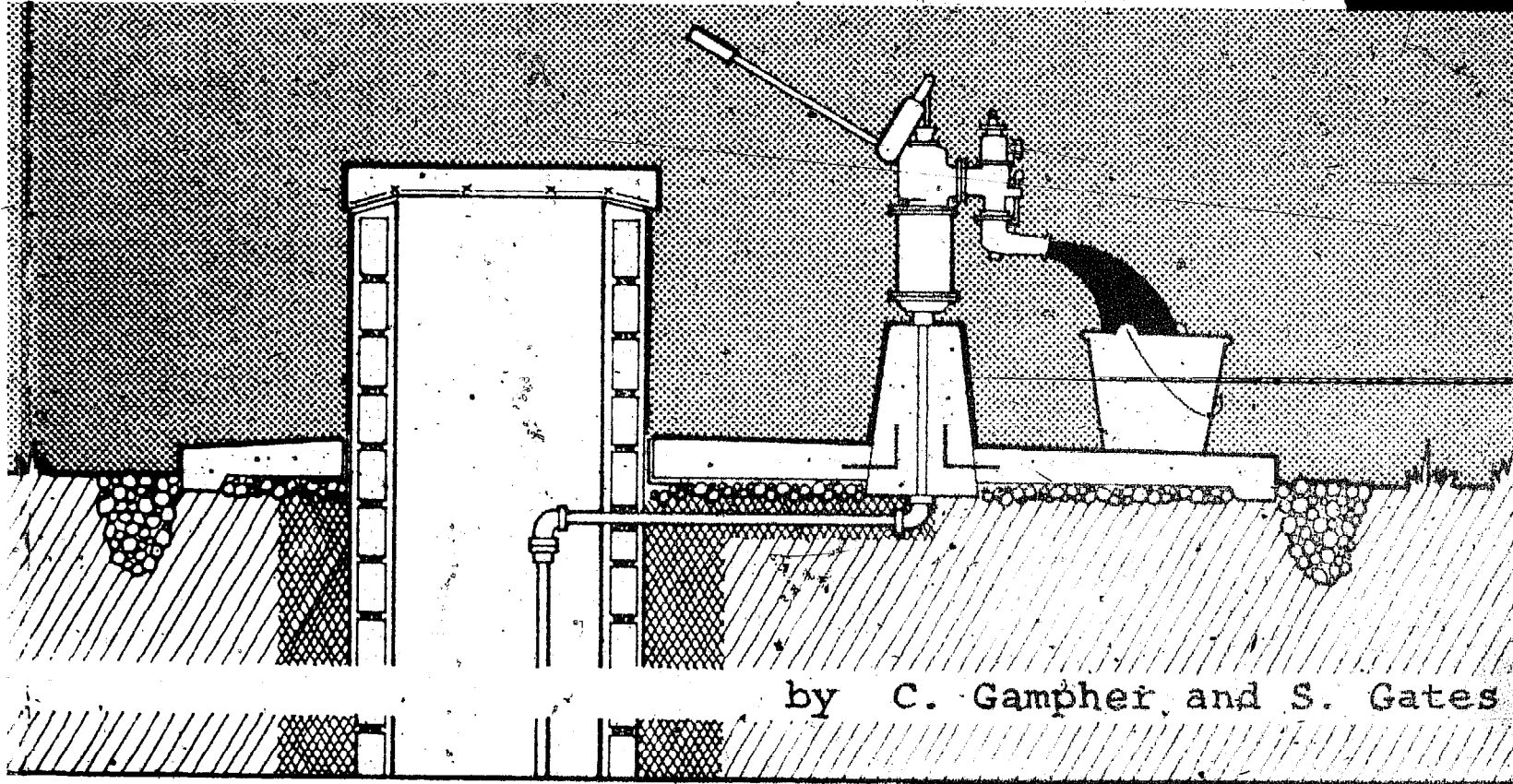

by C. Gampher, and S. Gates

First edition- 1,000 copies- November 1989.
Printed by: Don Bosco Press, Makati, Manila.
Funded by the Australian Embassy-Philippines,
Direct Action Program.

@Copyrighted. Portions of this book may be copied for
educational purposes only. No copies may be
sold for profit without written consent from
the authors. Revisions and translations are
encouraged provided the authors are notified
prior to reproduction.
Send notification or comments to:

Well Construction
1100 West Main St.
Jefferson City, MO 65109
U.S.A.

Table of Contents

2	Acknowledgements		
5	Construction summary		<u>Appendix</u>
6	Well Diagram	88	Sanitizing the well
8	Introduction	94	Pump maintenance
10	Community organization	96	Pump parts
12	Getting started	98	Pump problems & repair
22	Hollow block form	100	Concrete ingredients
33	Concrete hollow block	102	Cement mix ratios
41	Cutting ring	104	Materials for form
50	Cylinder	104	Tools
64	Pump stand and cover	106	Materials for one well
75	Apron	111	Cost of one well
83	Hardware	112	Glossary



AUSTRALIAN EMBASSY
MANILA

FOREWARD

Earlier this year, the Embassy's Direct Action Program (DAP) provided Pesos 40,000 to fund the construction of fifteen wells by the Bacao Rural Waterworks and Sanitation Association on Dumaran Island, Palawan Province--a project which used and proved the authors' technology and design. All involved in the implementation of this project, especially the authors, Suzi Gates and Cary Gampher, should be proud of what was accomplished.

The project was a pleasing example of the simple, modest, and cost-effective provision of a basic need to a distant community. One of the main challenges of providing needed technologies to developing countries is ensuring that they transfer and extend themselves to the target community in a lasting fashion. This booklet attempts to do this in one very appropriate area and I am very pleased that the Australian Embassy's DAP has been able to fund the first printing.

My congratulations to Suzi Gates and Cary Gampher on their work and I hope the book will, in time, be developed further and, if possible, translated into other Filipino languages.

To the potential user of this book, may I wish you luck, good digging, and clean water.

10 November 1989

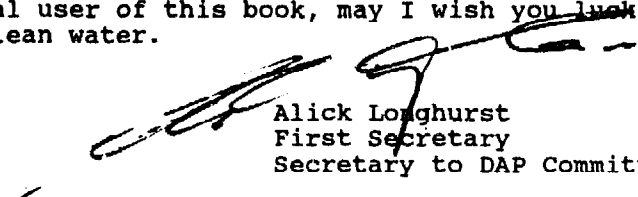

Alick Longhurst
First Secretary
Secretary to DAP Committee

PREFACE

This book is intended to teach people with little, or no, experience working with concrete how to build wells using curved hollow blocks. The information in the book is based on our experiences while working with the Potable Water Project sponsored by the Australian Embassy in Barangay Bacao, Dumarán, Palawan in the Philippines. In 1989 the cost of building one well, excluding labor and donated materials, was approximately \$120 U.S.

We have tried to reduce the technology of building the wells to its most basic elements, minus the engineering and construction lingo. In your trials you will undoubtedly discover better and/or easier ways to build the wells. Prior to your project, however, we hope this book makes your task a little easier.

While this original draft is written in English for the purpose of dispersal to development agencies, we do encourage its translation into the local dialect for distribution on the community level. Please send a copy of any translation to the address listed on the inside front cover so we can follow the development of the manual.

Good luck. Helping to bring the basic need-- water-- to a community must be one of the most rewarding projects to undertake. It has been for us.

Cary Gampher and Suzi Gates
U.S. Peace Corps Volunteers
Bacao, Dumarán Island, Palawan, Philippines
1987-1989

ACKNOWLEDGEMENTS

We are greatly indebted to the following people and organizations for their support, careful revisions, honest criticism, and encouragement through the many phases of this manual. Maraming salamat sa inyong lahat. Thank you all.

The Australian Embassy, Philippines.

Bacao Rural Waterworks and Sanitation Association, Bacao, Dumarán, Palawan, Philippines.

Congressman David Ponce de Leon, First District, Palawan.

Dr. Romeo A. Estanero and Asst. Professor Leopoldo A. Polintan, Civil Engineering Department, De La Salle University, Manila, Philippines.

Former Acting Project Engr. Domingo Janoras, Acting Project Engr. Moreno Navarro, Engr. Marilou Celzo, Mr. Eugenio Bito-onon, Jr., Rural Drinking Water Supply, Department of Public Works and Highways- Project Management Office- Palawan Intergrated Area Development Project, Palawan, Philippines.

Dr. Andronico Mendoza, M.D., New Washington, Aklan, Philippines.

Eng. Petronio Muring, Water Resource Center, University of San Carlos, Cebu City, Philippines.

Project Director Florencio Padernal, Sr. Engineer Ramiro Claudio, and Sr. Chemical Engr. Sylvia Amit, Department of Public Works and Highways, Project Management Office-Rural Water Supply, Manila.

Project Director Pabito Panares, Rural Water Supply and Sanitation Project,
Department of Local Governments, Manila, Philippines.

Peace Corps Volunteers Annette Moyer, Scott Richardson, Dave Read, Andrew
Salloch, Jim Sharmen, Ben Theis.

Mr. Nelson Resurreccion, carpenter and originator of curved hollow block form
in 1976, Cawayan, New Washington, Aklan, Philippines.

Engineer Phil Roark, WASH, Washington, D.C.

Mr. James Tolisano, Water Use Specialist, Santa Fe, New Mexico, U.S.A.

Tulongan sa Tubigan Foundation, Quezon City, Philippines.

United States Agency for International Development, Philippines.

United States Peace Corps Office for Training and Program Support, Washington,
D.C.

U.S. Peace Corps/Philippines: Asst. Librarian Lani Berino; Susan Bulanhagui;
Nelson Concepcion; RAPCD Bill Courtney; Annie Dizon; Program Officer Carole
Kimball, Milet Mapile; Country Director Jim Lehman; Mary Rose Martinez;
Program Assistant Jolie Nuguid; Angie Quinto; Program Assistant Gloria Raif;
Librarian Fe Sajulan; Administrative Assistant Emily Silvano.

Volunteers In Technical Assistance: Mr. Luis Diaz, P.E., Geologist Charles T.
Snyder.

**THIS BOOK IS DEDICATED TO
SAMMI AND RI**

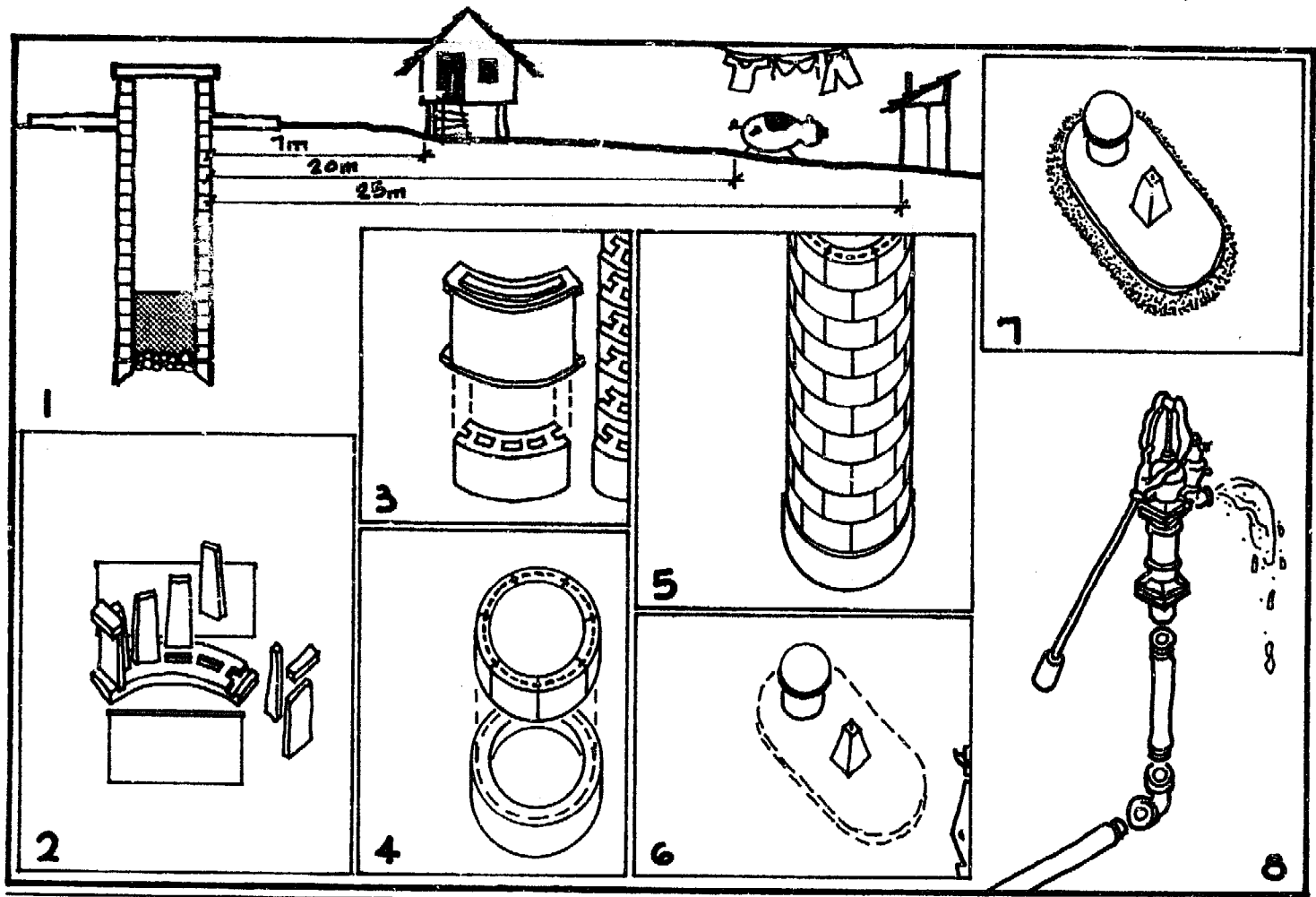

Construction summary: 1) Getting started, 2) Block form, 3) Hollow block, 4) Cutting ring, 5) Cylinder, 6) Stand & cover, 7) Apron, 8) Hardware.

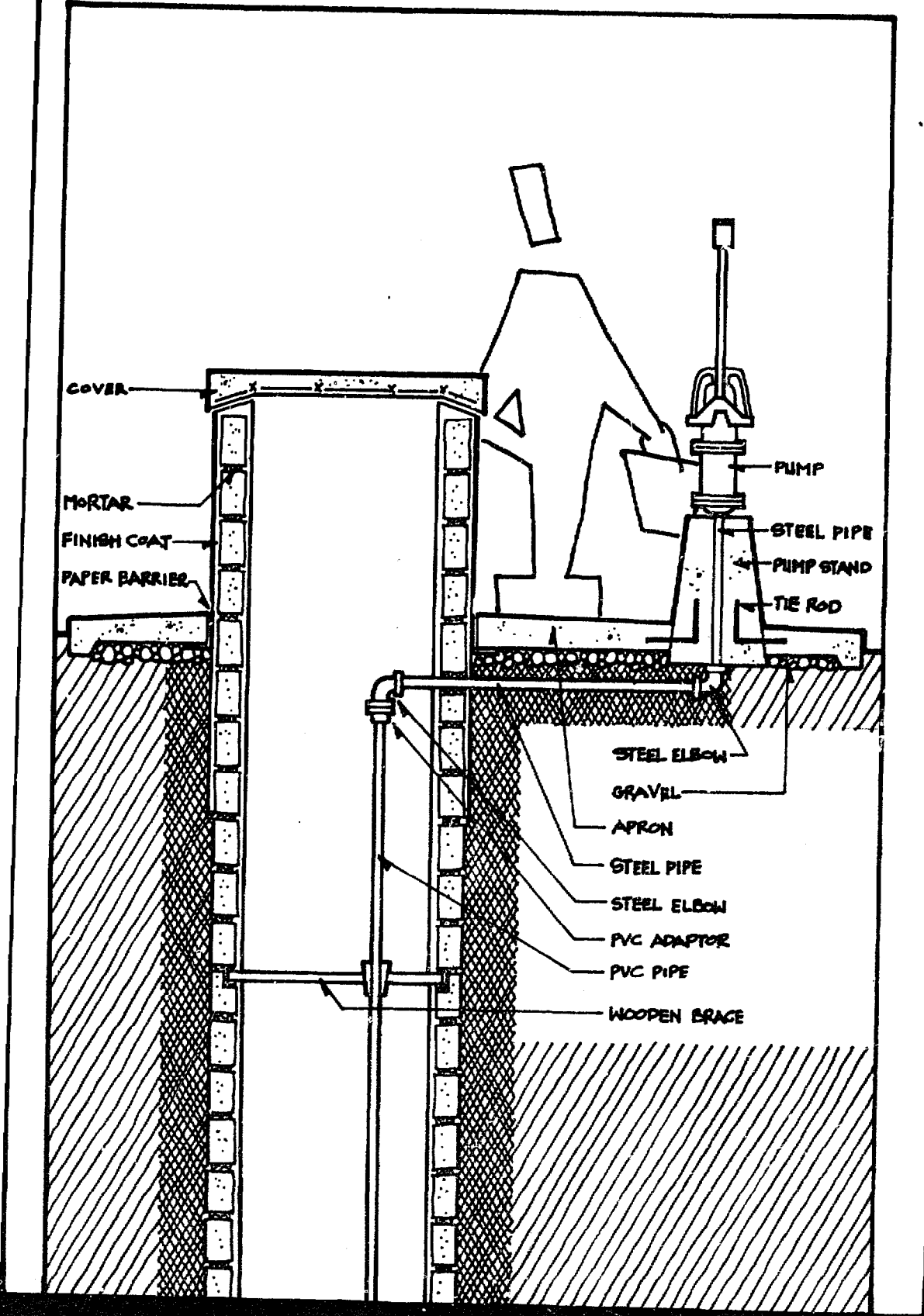

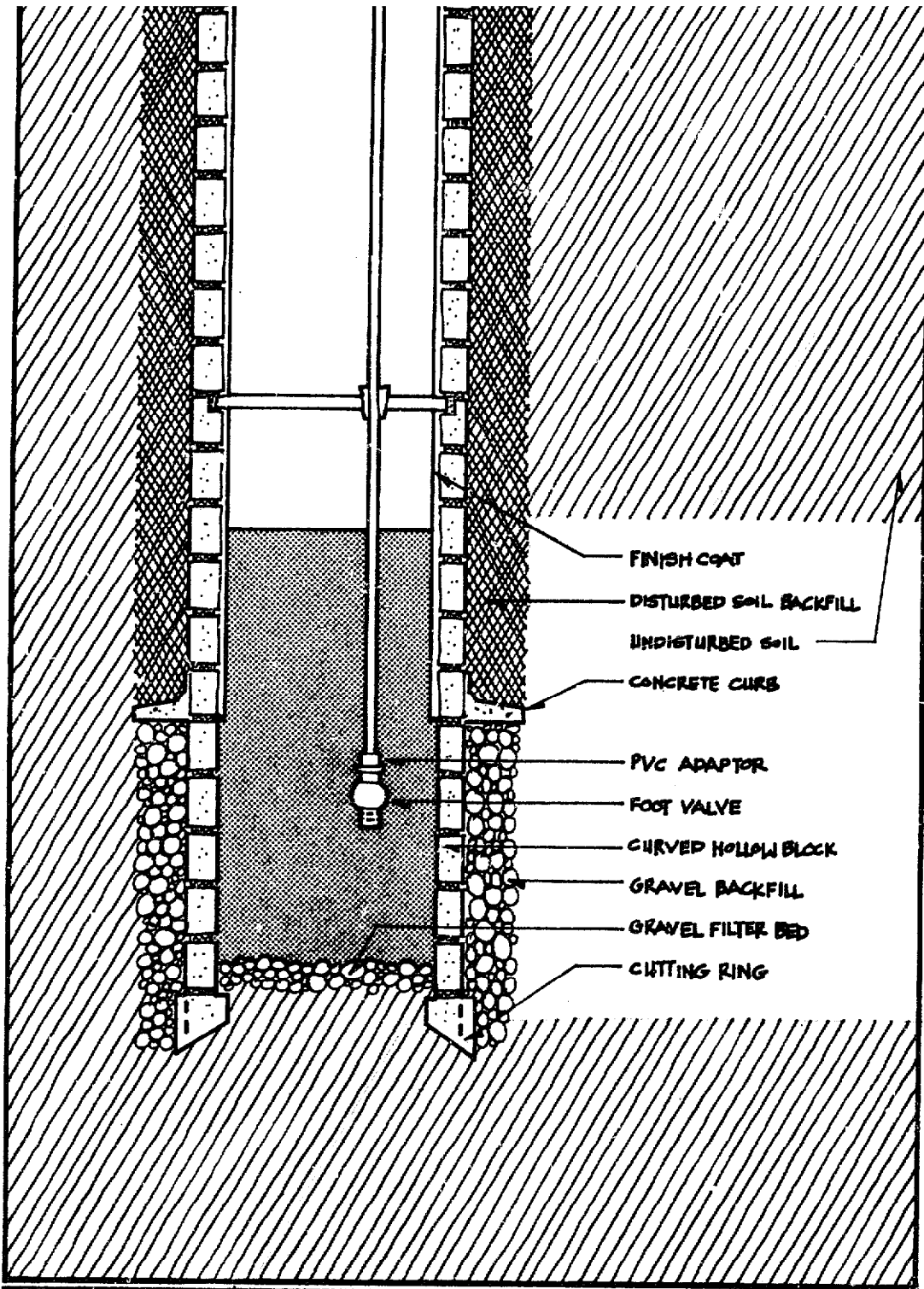

Well diagram using curved hollow block. Includes cover and separate pump stand/apron.

INTRODUCTION

Curved hollow block wells are designed to be used in remote mountain, lowland and coastal areas which lack infrastructure and where transportation is difficult.

The technique is similar to the technique of using street culverts to form a cylinder. The advantage of curved hollow block over culverts in remote sites is that the block form is light, portable and inexpensive and two to three people can build a well from start to finish. Culverts are heavy and require reinforcing bars and special machinery to transport and lower into the well hole. Curved hollow block wells are a practical alternative in hard-to-reach areas and where the low number of wells being built cannot justify the expense of transporting culverts.

The technology of the wells builds on a skill that already exists in many areas--that of pouring and constructing with hollow block. The well is designed to take advantage of the inherent strength of the circular shape and does not require steel reinforcing. Thus, the mix of the concrete and the curing time have been altered to insure strong blocks while the skill needed to make and use the blocks remains the same.

The well design described here situates the pump to the side of the well and the cover is removable. In the event the pump breaks, the users can remove the cover temporarily and fetch water. Once again this is an adaptation for remote areas where spare pump parts often take a long time to arrive. (See pages 6 and 7 for well diagram.)

The hollow block cylinders with a seven-block circumference described in this book have been built repeatedly to a depth of 7m (23 ft.) without any structural problems. The technology is such that the wells should be structurally sound down to extreme depths; however, no lab tests have been done to confirm the exact depth restriction. Hard-packed clay and loose sandy soils put pressure on the well cylinder and will therefore place some limits on the depth of the well. In comparison, rocky soils and sandstone place little pressure on the cylinder wall. Wells similar to those described here have been built in Africa to depths of 30m (100 ft.).

If the water in the well is within 7m (23 ft.) from the surface at the end of the dry season, then a shallow-well suction pump can be used. A well with a groundwater line (GWL) below 7m will require a pump with deeper design specifications. Areas with a deep water table might save time and money by drilling for water with a simple, manually operated drill.

COMMUNITY ORGANIZATION

The authors' experience has been that a successful project focuses on improving a condition that the community recognizes as a problem. The project should also build on a skill that already exists in the community. Thus the term "appropriate technology." If these two conditions are met, the community members will gain confidence in their abilities to master community problems, are more likely to maintain the current project, and will possibly undertake more projects in the future. In this instance, the initial project becomes part of the larger scheme of overall community improvement. A project intended to supply a community with clean drinking water also supplies enough water for small home gardens. Health and sanitation are thus improved.

The Bacao Potable Water Project on which this manual is based was organized so that no one person or one well would dictate the success or failure of the project. Neighbors of 10-15 families organized to build the well they would drink from and chose a well manager among themselves. The manager was responsible for organizing construction teams and well maintenance when the project was complete.

The small neighborhood groups began to compete for the best designed and decorated wells. Most of the adaptations and helpful hints in this manual arose from the competition between the groups and the personal creativity of the group members.

While obtaining potable drinking water is the first goal of this project, the long-term goal is to maintain a source for potable drinking water. Maintenance training is essential, especially in remote areas, if the project is going to succeed.

And finally, the community development worker must be willing to let the project succeed or fail in accordance with the community's own commitment to it. Sometime before the end of the project, the development worker should have withdrawn to the point that his or her presence is not necessary for the operation of the project. The community should be able to maintain the project independent of outside "specialists."

GETTING STARTED

Choose a well site which is accessible to the well users and where there is enough clean, safe water to justify a well. Avoid building wells in an area with rice paddies or that floods because standing water could contaminate the well. Plan to build a minimum of one well for every 10-15 families to prevent excessive wear on the pump.

GUIDELINES FOR LOCATING A WELL SITE

The well should be uphill and no less than:

1. 25m (81 ft.) from the closest pit latrine;
2. 20m (65 ft.) from any bathing or laundry areas, animal pens and other water sources;
3. 7m (22 ft.) from any houses. (See Fig. 1)

When locating two or more wells, avoid placing them in a line parallel to the underground water flow, especially in hard-packed soils, because the wells will share the same water source and take longer to fill up after use.

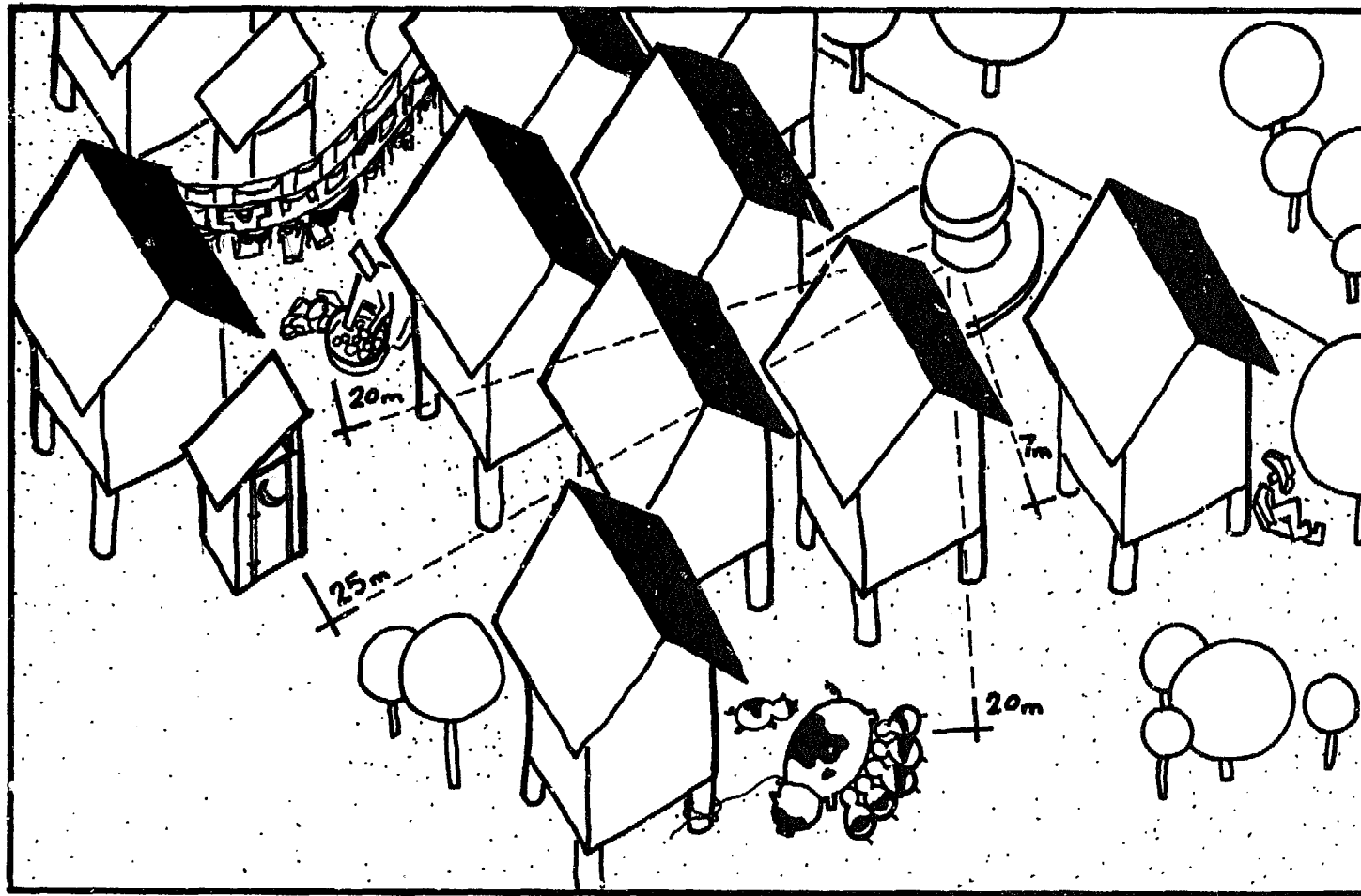

Fig. 1 Locating a well: distance restrictions.

If the well site is on the coast, build the well as far back from the shoreline as possible and stop digging when 1m of water stands in the well. Take care not to dig too deep because the water may turn salty. Figure 2 demonstrates what happens if a well is too deep, too close to the shore or if too many wells are located in one line parallel to the shore. In these instances, salt water rises to fill the void created by the drain on the fresh water table and enters the well.

Build wells at the end of dry season when the groundwater line has dropped to its lowest point. This will insure that the well has water all year.

Before beginning to dig the hole for the well, build a simple fence around the site to prevent children from playing too near the hole. In stable soils start by digging a hole 2m (6 ft.) in diameter to the groundwater line. (See Fig. 3) Continue digging a minimum of 1m after reaching the groundwater line. Be certain that at least 1m of water remains in the well at the end of dry season. It may be necessary to remove water while digging the hole.

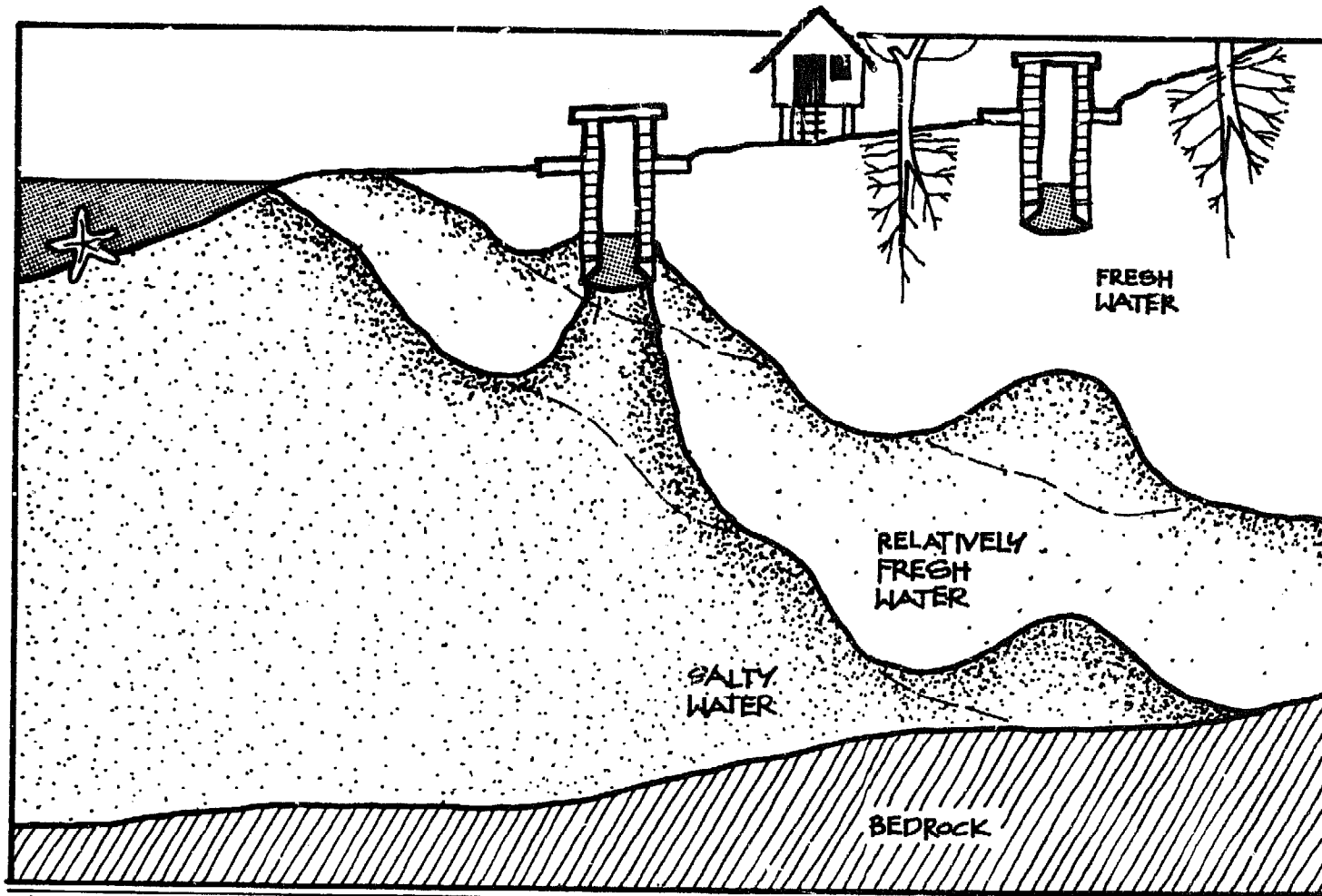
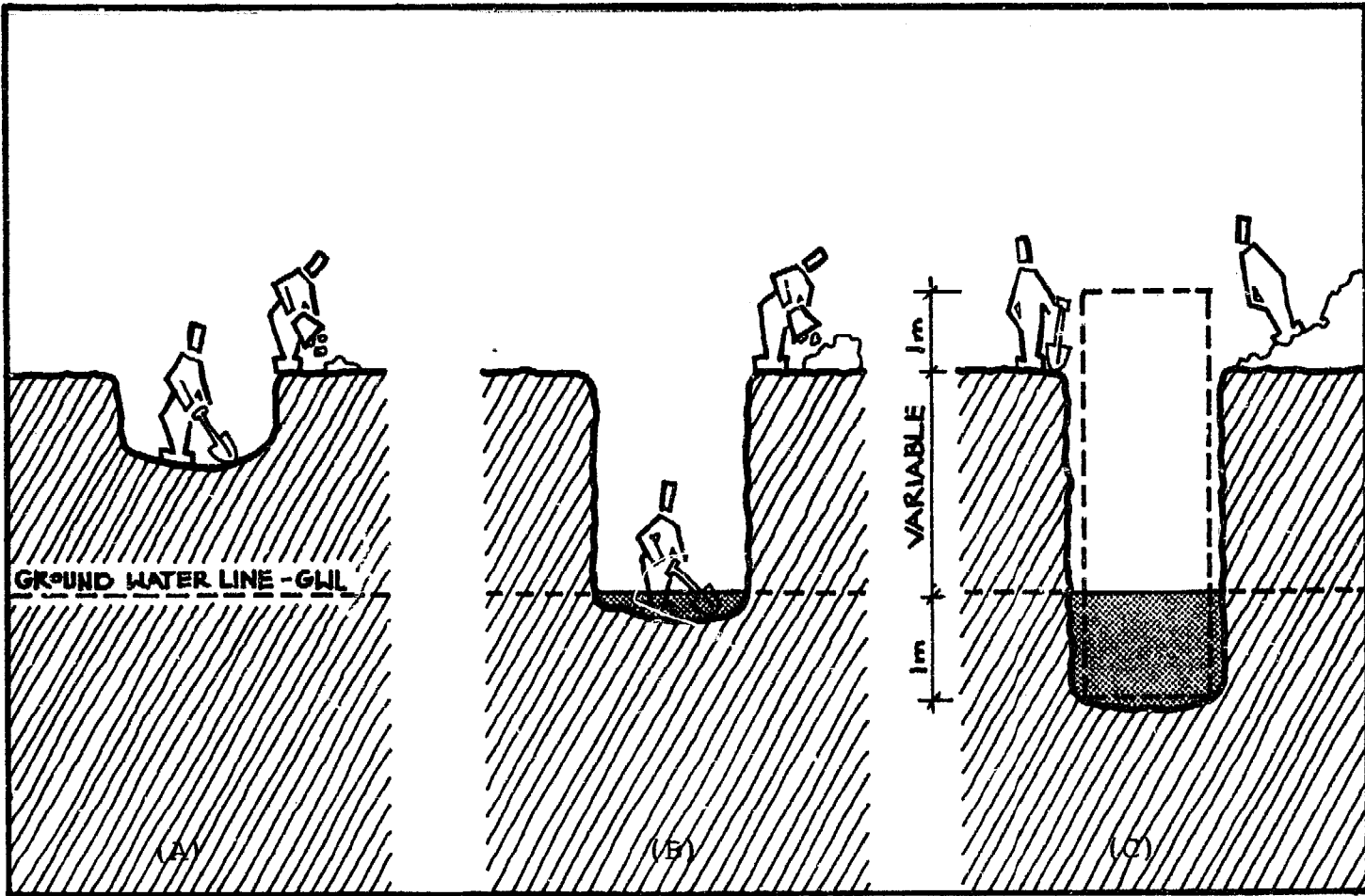

Fig. 2 Effect of well on underground water conditions.



16 Fig. 3 Dig well hole at the end of dry season. A) Remove soil,
B) Remove soil and water, C) Dig 1m below groundwater line (GWL).

In unstable soils either line the hole with an indigenous material such as bamboo wall siding or, if the soil is really loose, such as dry sand, use the "sinking method." (See Figs. 4 & 5 for a visual description of both methods) Experience has shown that moist, compacted sand is not susceptible to cave-ins and therefore may not require a hole lining.

The **sinking method** is recommended in extremely loose soils where digging through rock is not likely to be a problem. To perform the sinking method, first dig as far as is safely possible. Next build a partial cylinder as described on pages 41-49 and lower it into the hole. To "sink" the cylinder, dig a hole in the center of the well. Scoop out the soil from the perimeter and under the cylinder. Repeat. As the cylinder sinks, add layers of hollow block. Continue sinking the cylinder until the water is 1m (3 ft.) deep and the cylinder is even on all sides. The sinking method is more time-consuming and labor-intensive than either the **direct dig** or **lining method** and should only be used if the other methods are inappropriate.

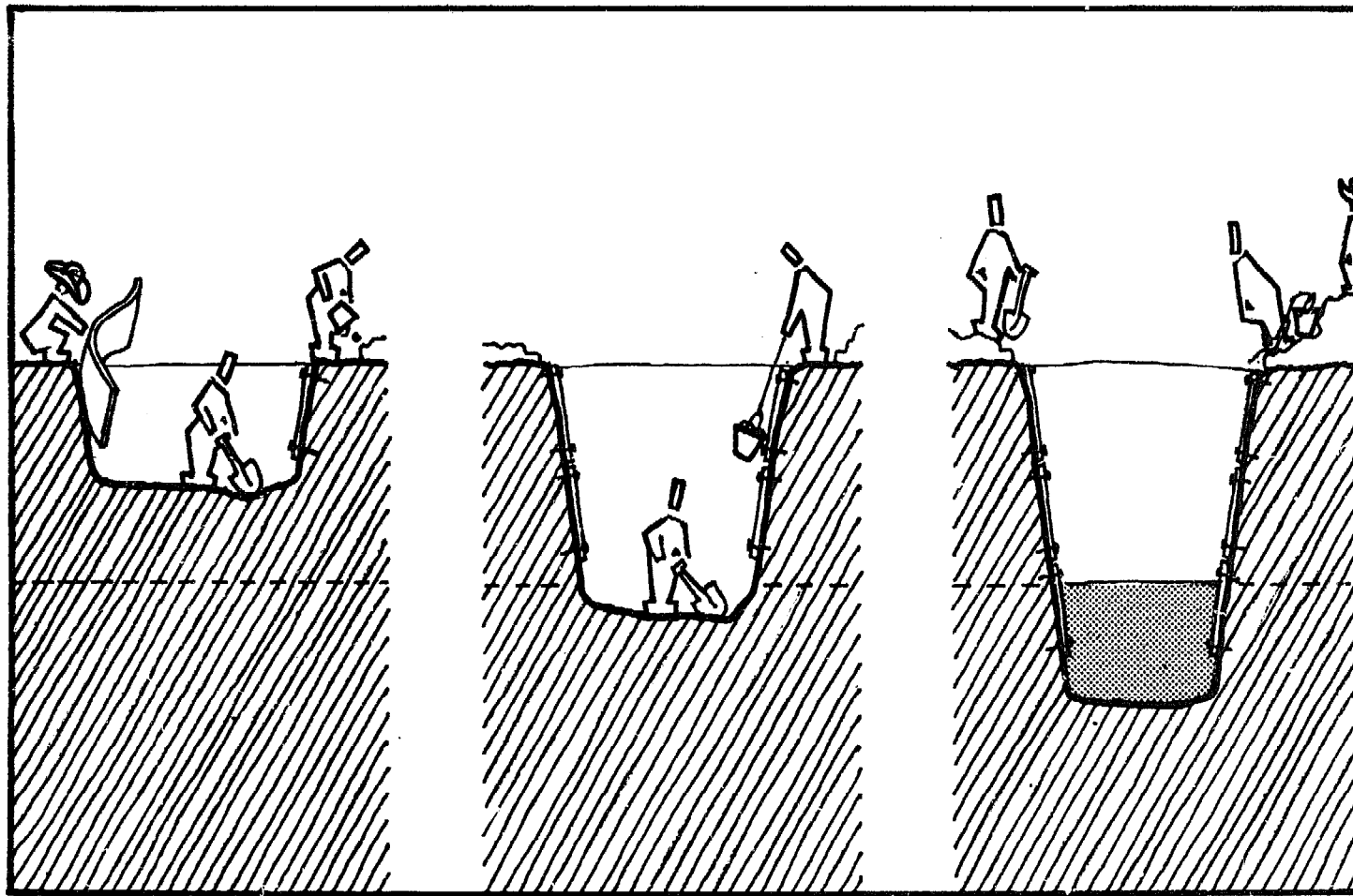

18 Fig. 4 Lining method in loose soil. Taper sides to prevent cave-ins.

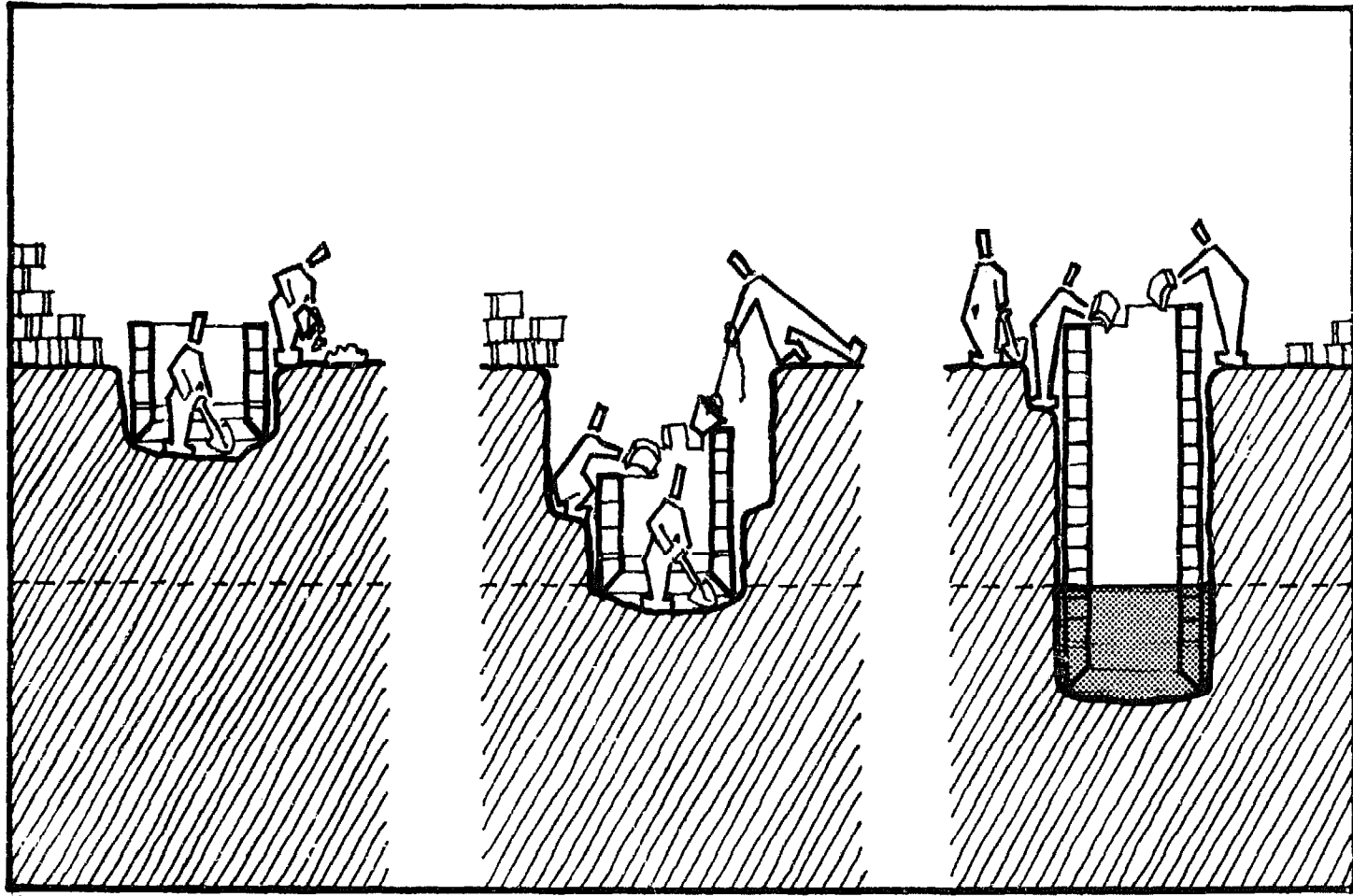

Fig. 5 Sinking method. Remove soil from under partial cylinder and build cylinder.

Hollow Block Formula

Use the following formula to calculate the total number of hollow blocks needed in the cylinder:

$$\frac{3AB}{2} = C$$

A= Number of blocks in one layer.

B= Height of cylinder in feet.
(hollow blocks are measured
in inches and feet)

C= Total Number of blocks needed.

For example: A=7; B=18

$$\frac{3 \times 7 \times 18}{2} = 189 \text{ blocks needed}$$

See Fig. 6 for an illustration of this formula.

Seven blocks per ring is the ideal circumference. However, the blocks can be used to form six- and eight-block round cylinders. The larger the diameter of the well, the greater mobility the person working inside the well has. The drawback to a larger, eight-block circumference is that the foundation ring is heavy and more difficult to lower into the hole.

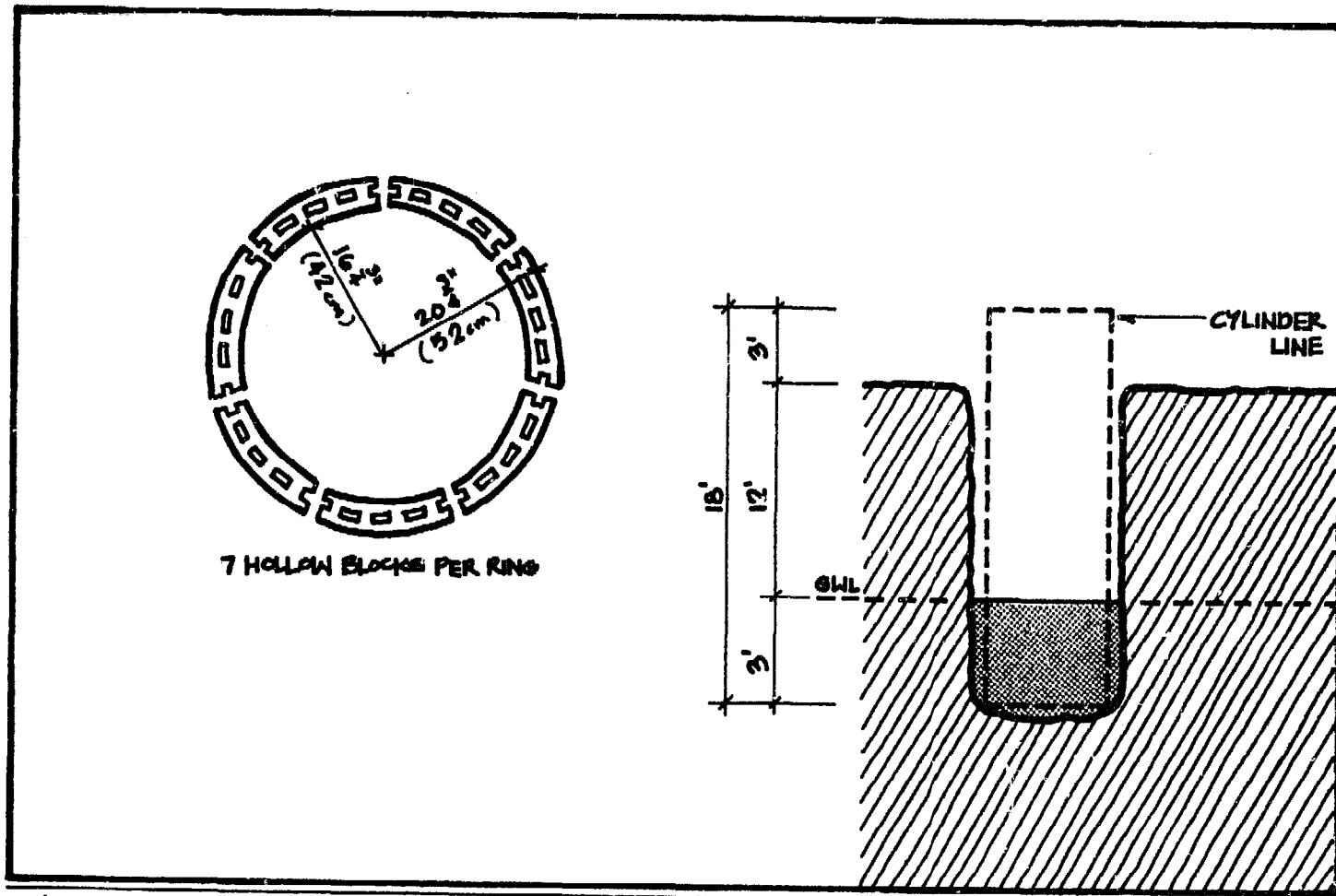

Fig. 6 Information needed to calculate number of hollow blocks.

HOLLOW BLOCK FORM

Hire a skilled craftsman to build the 4"x 8"x 16" curved hollow block form. This person, whether a carpenter, furniture maker, or boat builder, must give particular attention to detailing and workmanship because the performance of the curved hollow block form is crucial to the project's success. The materials needed are wood, steel and two sizes of nails.

Trace the outline of each piece of the form onto the wood and steel as shown in Fig. 7a and 7b.

Use a nail and piece of string to trace the pattern for piece "C" onto the wood. Mark $16 \frac{3}{4}$ in. (42 cm) and $20 \frac{3}{4}$ in. (52 cm) on the piece of string. Secure the 1 in. x 10 in. x 40 in. piece of wood so it is stationary. Fasten a nail or peg to the ground or working surface 20.5 in. from the end of the wood and 15.1 in. away from the board. (See Fig. 8a). Tie one end of the string to the nail and attach a pencil at the $16 \frac{3}{4}$ in. mark. Draw an arc on the wood. Transfer the pencil to the $20 \frac{3}{4}$ in. mark and draw another arc. (See Fig. 8b) To check the arc for accuracy, measure a piece of string $18 \frac{1}{2}$ in. long and lay it on the inside arc. (See Fig. 9a) Next measure a string $21 \frac{1}{2}$ in. long and lay it on the outside arc. Connect the two arcs with a 4-inch straight line on each end. (See Fig. 9b)

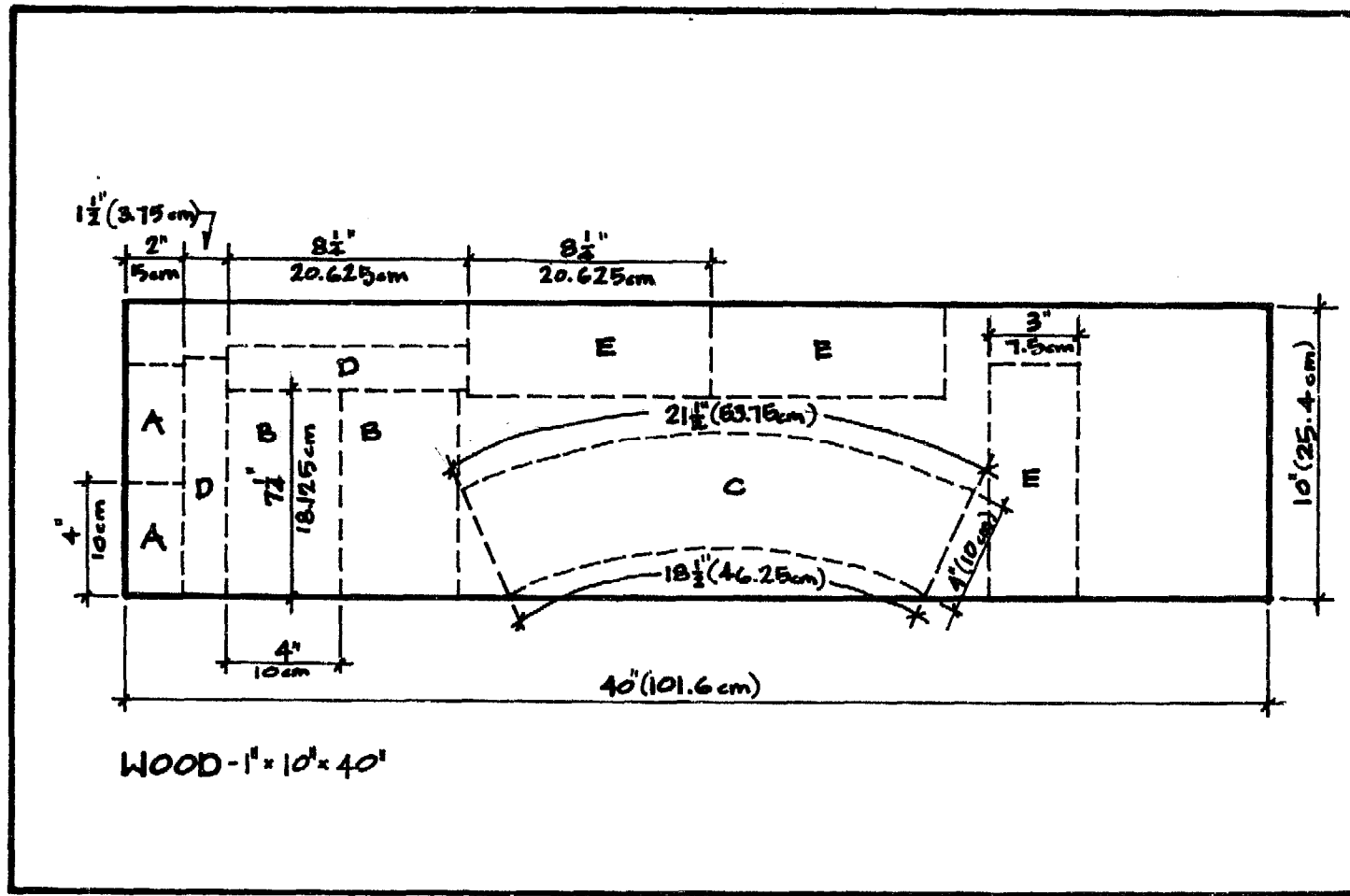
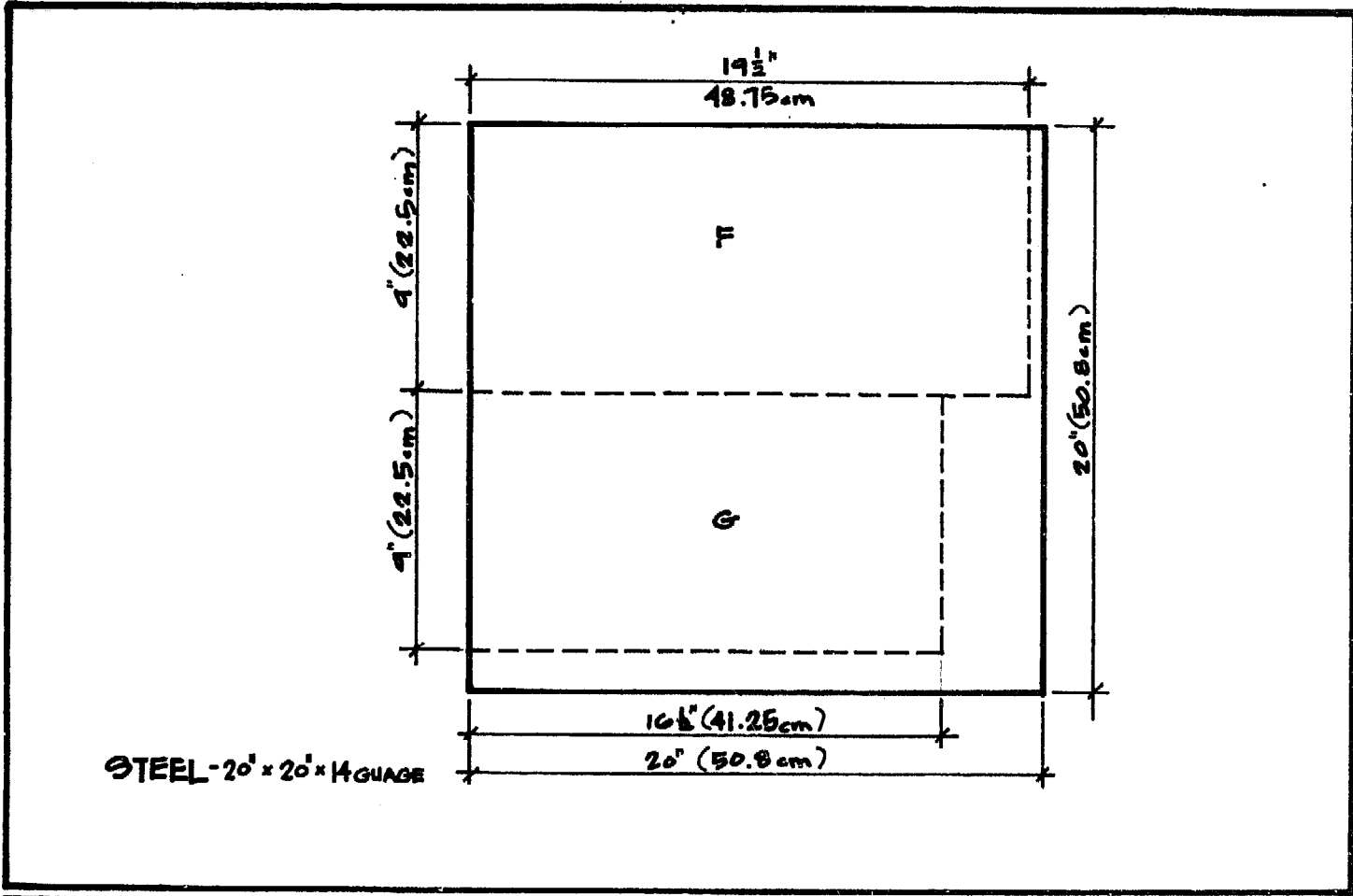

Fig. 7a Hardwood for hollow block form. 2 pcs. each "A", "B", "D"; 1 pc "C"; 3 pcs. "E".



24 Fig. 7b Galvanized steel for hollow block form.

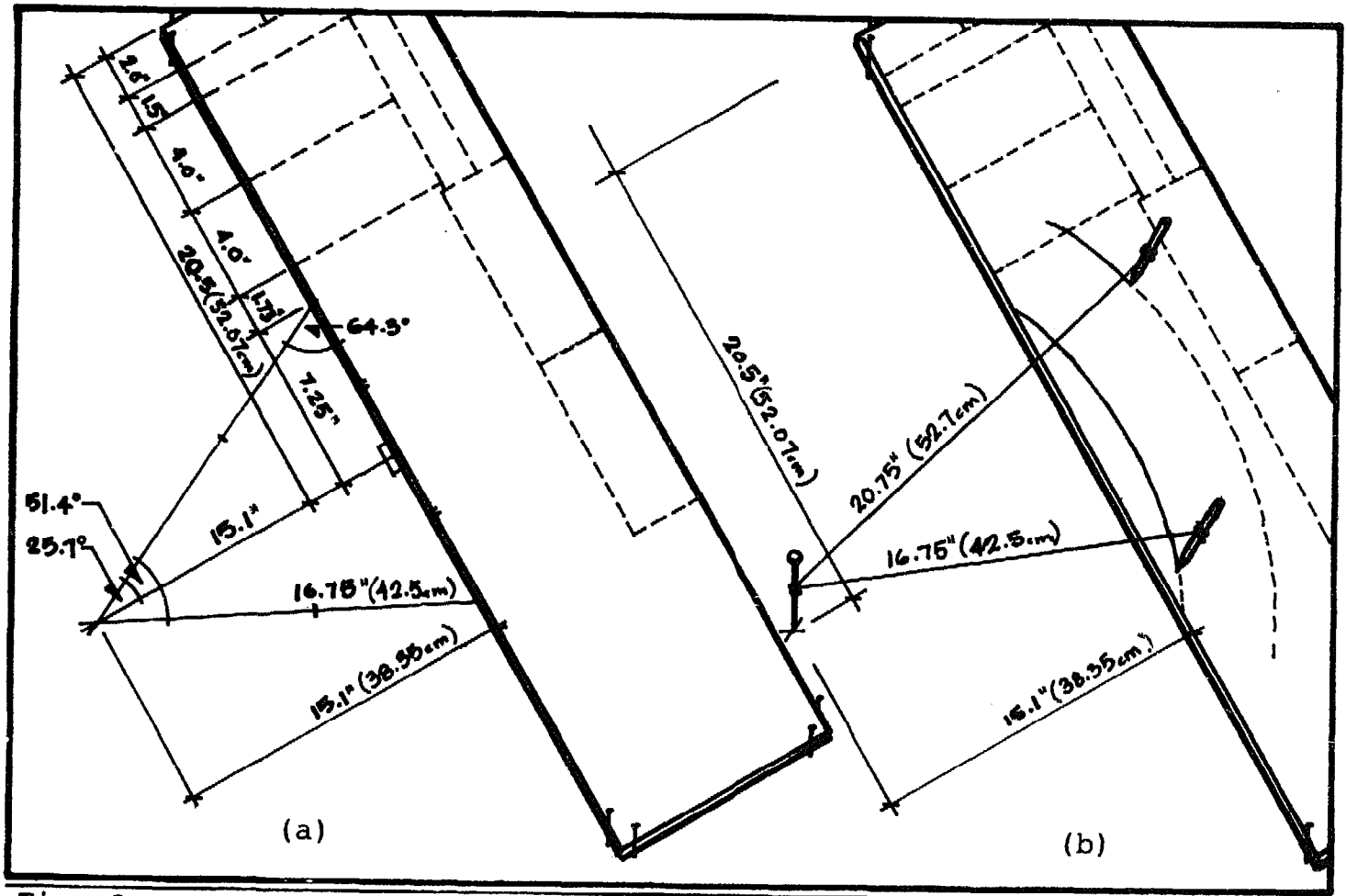
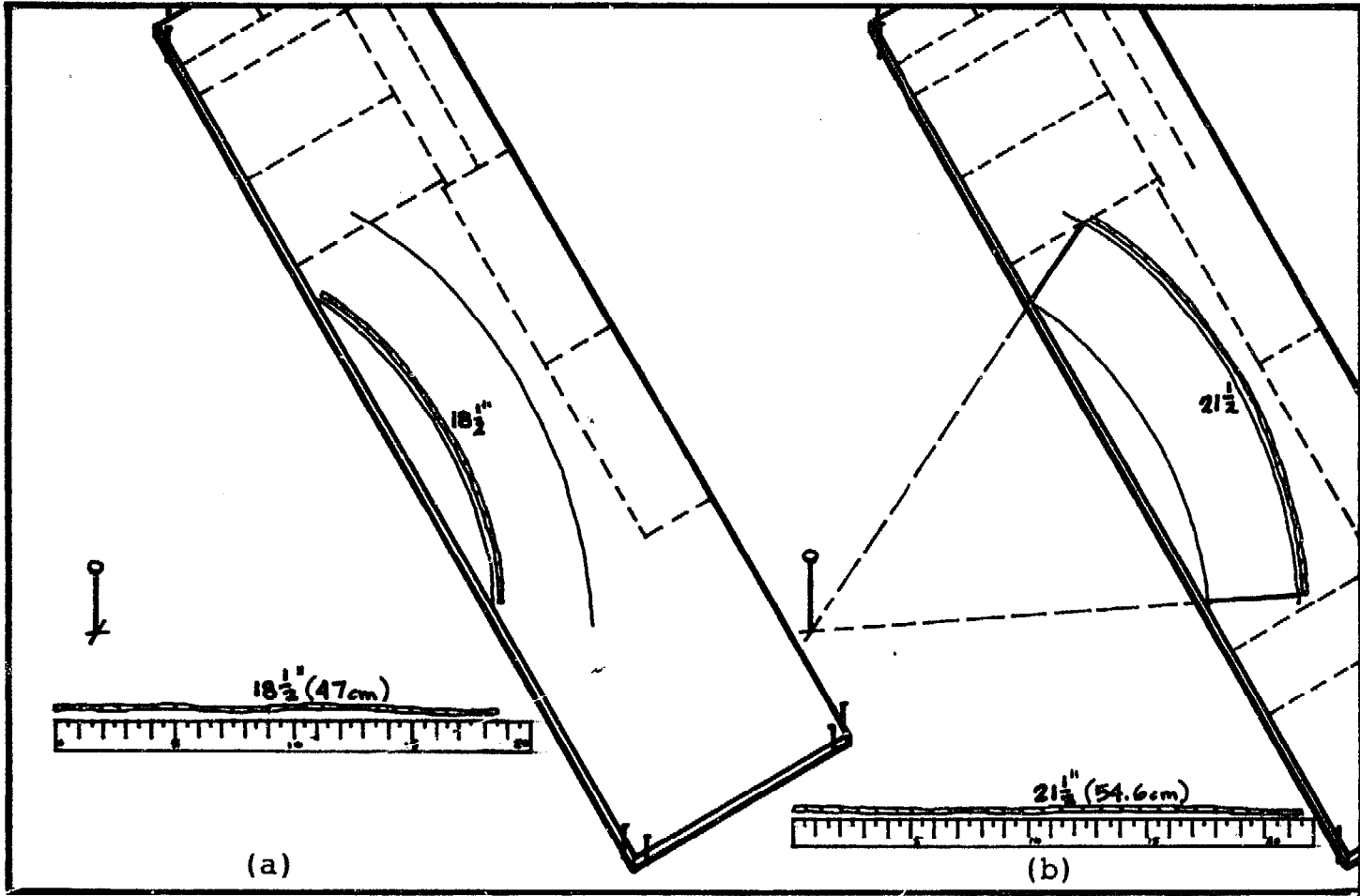

Fig. 8 Constructing "C". (a) placement (b) drawing arcs.



26 Fig. 9 Check accuracy of arcs and connect with 4 in. straight line.

After cutting out the pieces, note that pieces "D" and "E" must then be tapered according to the dimensions in Fig. 10. Note that the dimensions in Fig. 11 refer to the centerline measurements in piece "C" while Fig. 10 details the exterior and interior arcs of "C". Make the 1/4 in.-deep notches in "C" with a wood chisel.

Fig. 12 shows the approximate relationship of all the pieces of the form. Assemble all wooden pieces using 1 1/2 in. nails and attach the two pieces of metal with 1/2 in. nails as shown in Fig. 13. In addition to tapering wooden pieces "D" and "E", round and/or roll the edges of the metal as shown in Fig. 14. Again the care used in constructing the curved hollow block form directly affects the quality of work to follow.

28 Fig. 10 Cut out pieces. Taper "D" and "E" according to figure.

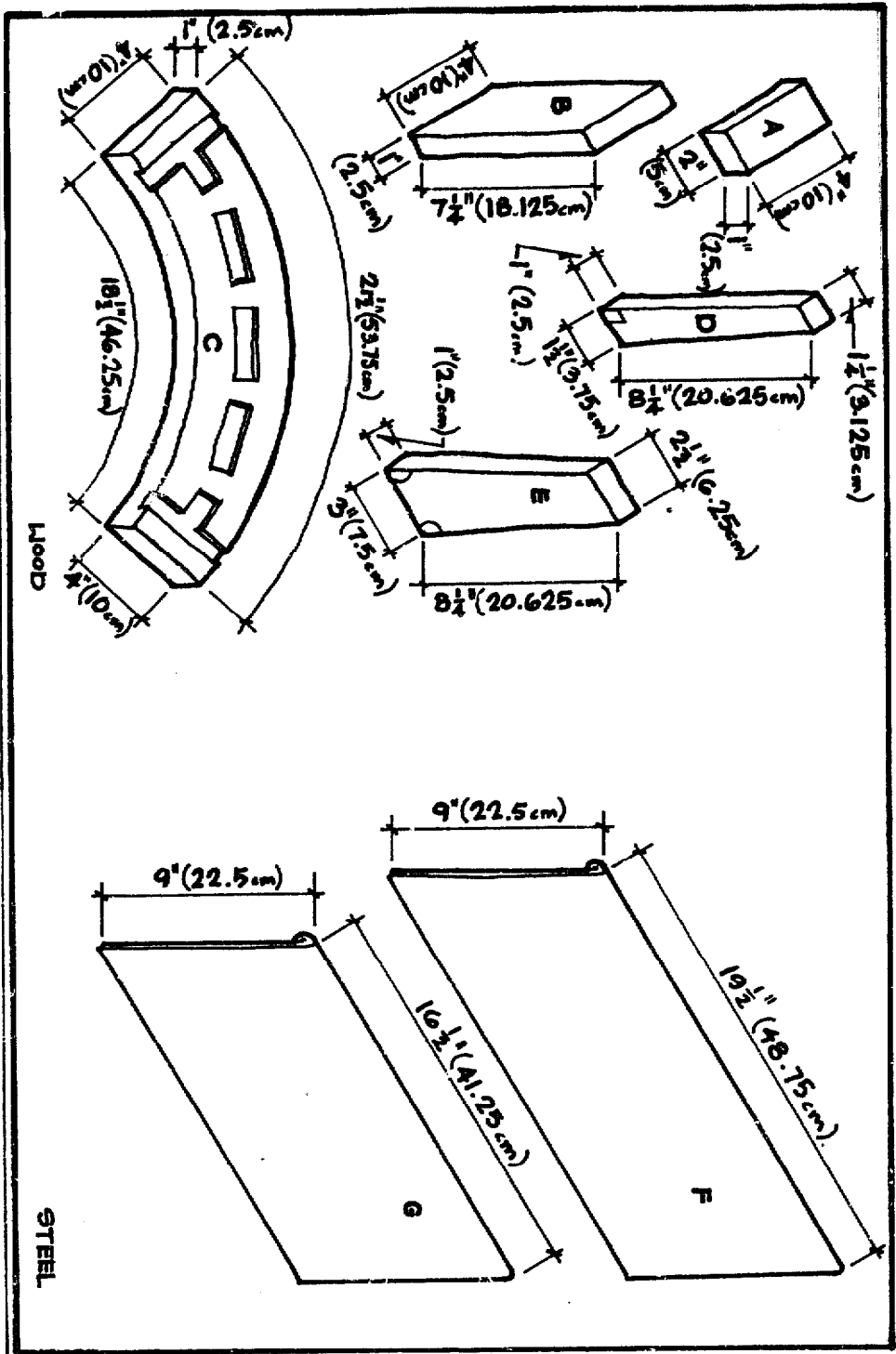

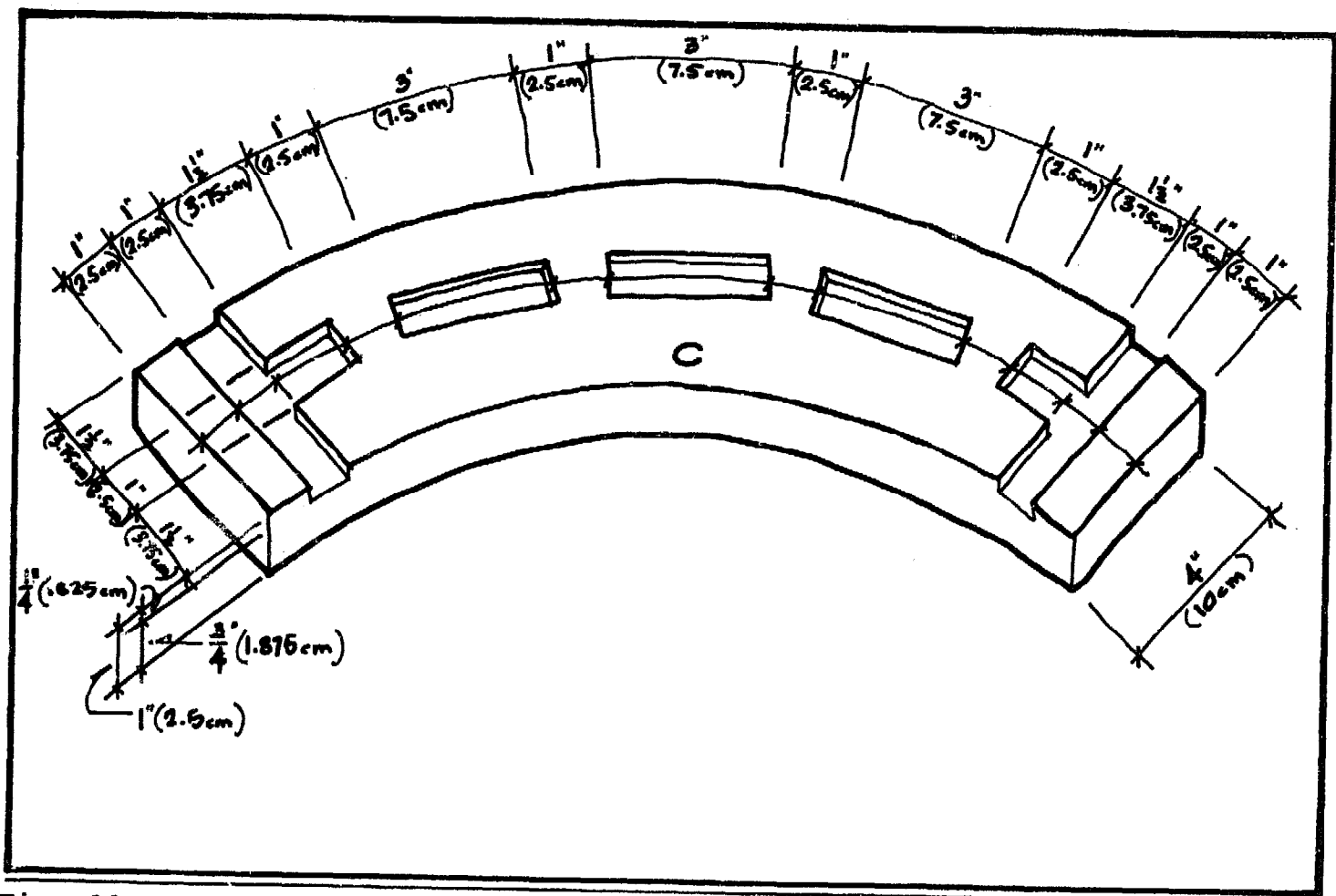
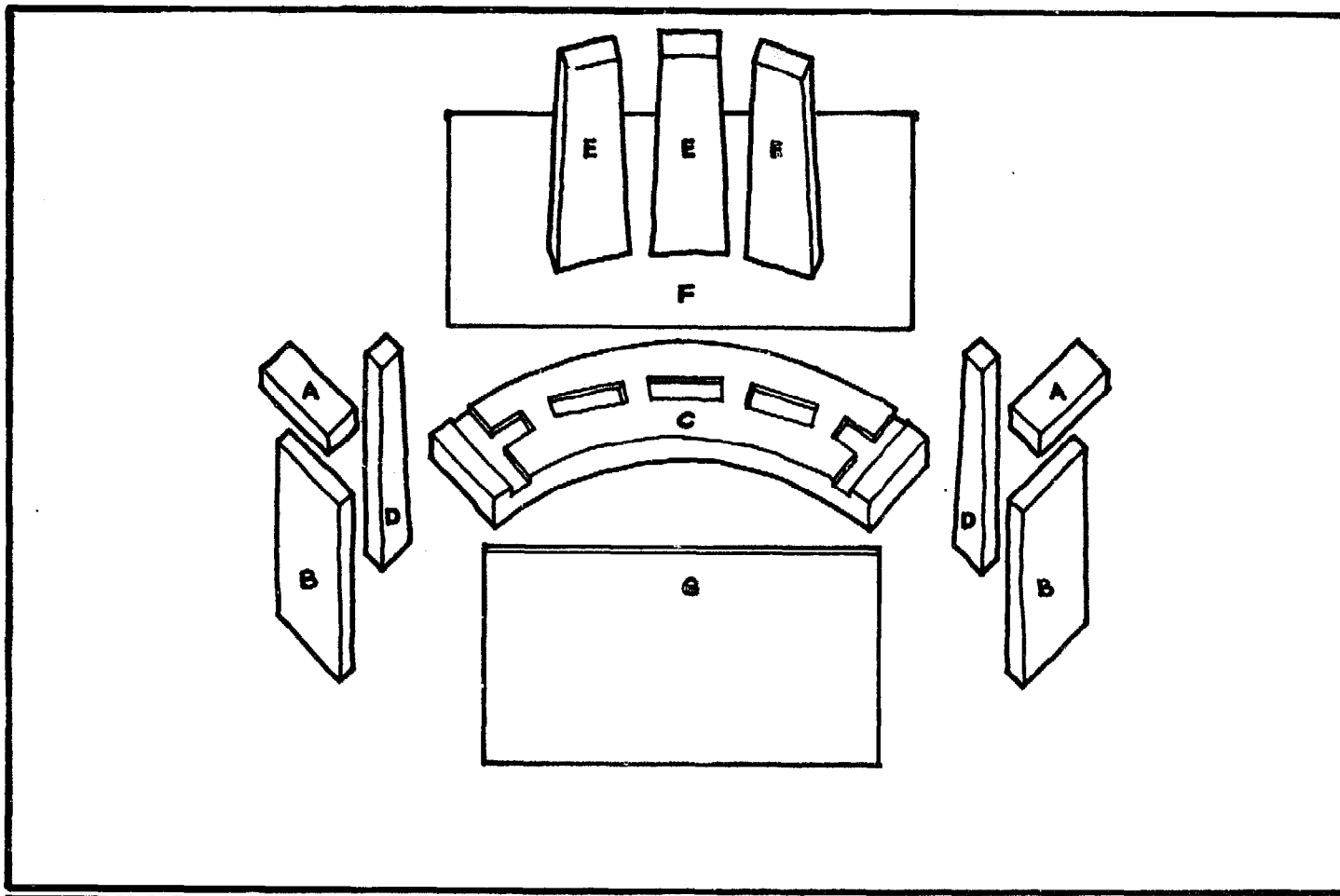

Fig. 11 Detail of "C". Dimensions at top are of centerline and notches. 29



30 Fig. 12 Relative positions of pieces of hollow block form.

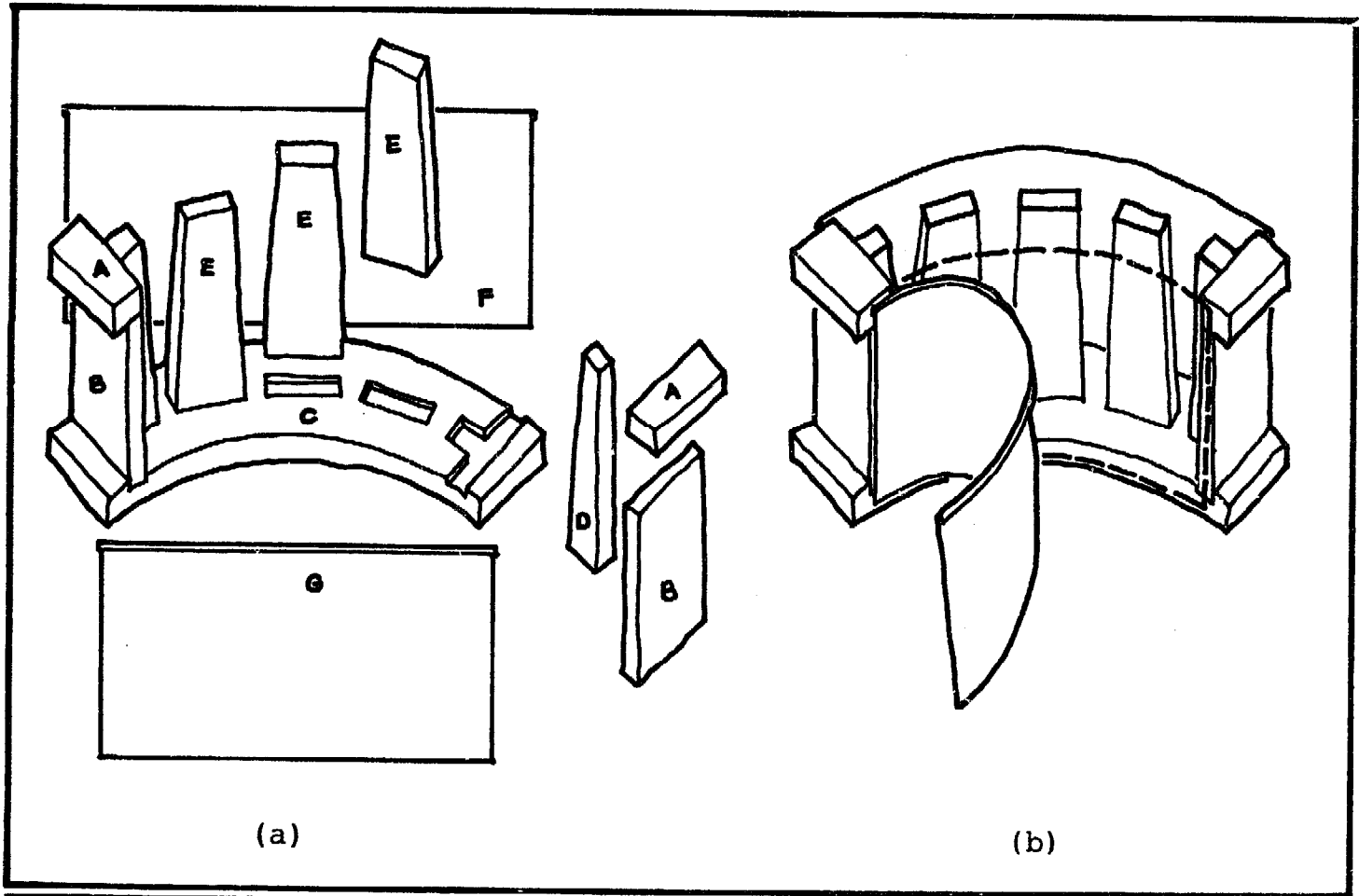
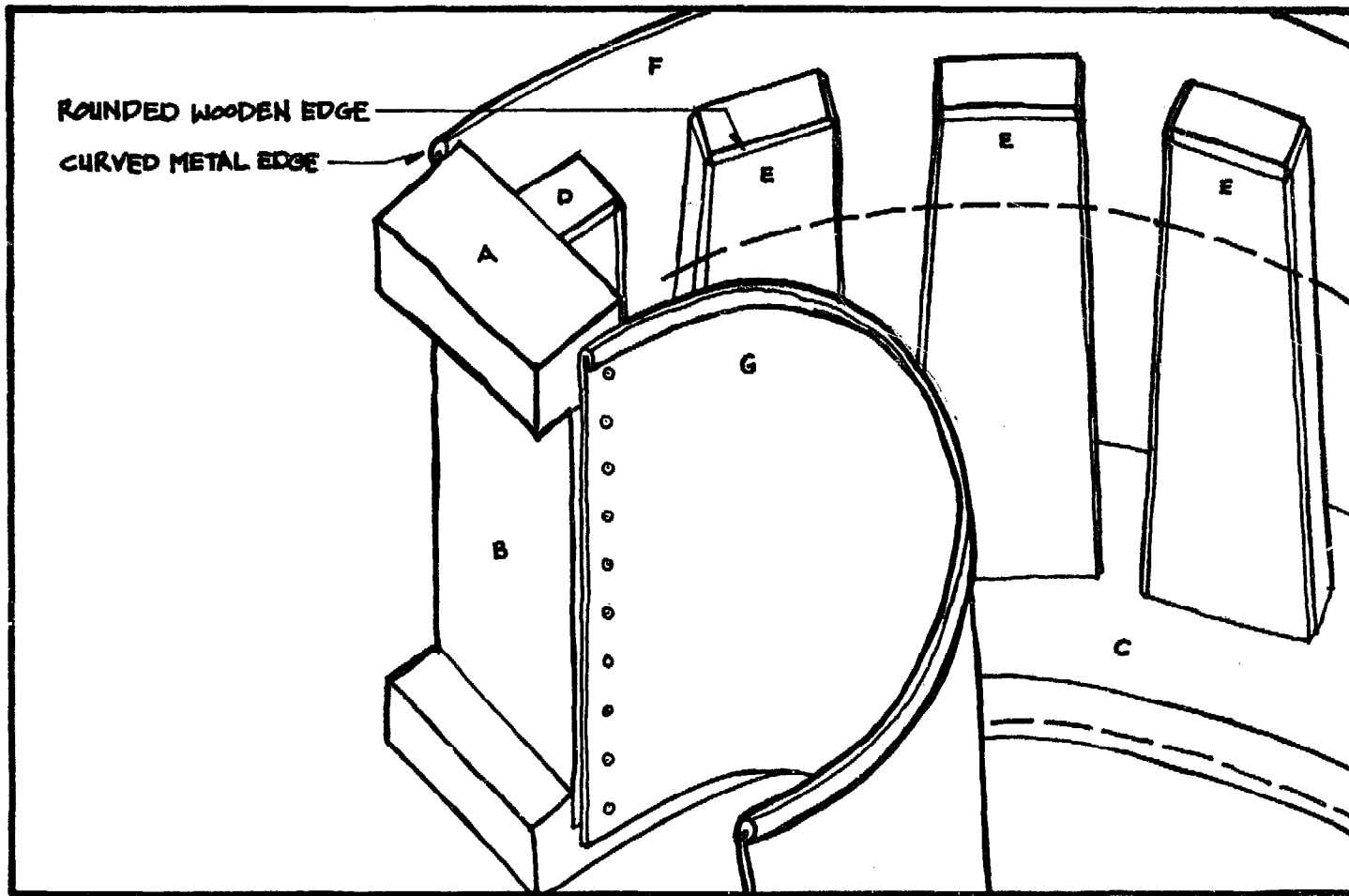

Fig. 13 (a) Partial assembly of form; (b) Completed form with metal cutaway.



32 Fig. 14 Hollow block form. Rounded edges on wooden posts and sheet metal allows smooth block release.

CONCRETE HOLLOW BLOCK

Quality hollow blocks are essential to the overall quality of the well construction. The ingredients of concrete hollow blocks are cement, sand, aggregate (gravel), and water. Aggregates and types of sand vary greatly and affect both the amount of water needed and the workability of the concrete mixture. Test a few trial mixes in the hollow block form before settling on any one mix ratio.

Proper mixing and curing of the hollow block are the most important steps in building the well. One 40-kilo bag of cement should yield no more than 35-40 blocks. The blocks must be cured in the shade and watered 2-3 times a day for seven days. This will assure strong hollow blocks and a strong well.

The consistency of sand is best if it is fine and powder-like, not coarse. Hollow blocks made of coarse sand do not hold their shape well after leaving the form. If the project is along the coast, high-quality, non-salty sand can be obtained while digging the well. If the ground composition is something other than sand, collect approximately 10 m³ (20 50-kilo rice bags) of sand per well at the site before starting construction. If the sand is salty or dirty, rinse it well before using it.

The recommended starting concrete mixture is 1
container cement: 4 containers sand: 2 containers aggregate:
1-4 containers water.

*NOTE: The amount of water you will need will depend
on the type of ingredients in the concrete mix.

As compared to other mixtures of concrete, the mixture
for hollow blocks is relatively dry. Once enough water is
present that the mixture holds its form when compressed in
the palm of the hand, the water content is correct. All
other concrete mixtures in this project will contain enough
water that they can be crudely poured from a container and
will therefore be referred to as "wet" mixtures. (See Page
102 and 103)

Begin making concrete by thoroughly mixing the cement
and sand. Then make a depression in the center of the
cement/sand mixture and add all the aggregate. (See Fig.15)
Do not mix. Slowly add water until the aggregate is
saturated. Allow this to set for five minutes until the
water permeates the outer ring of sand and cement. After
five minutes the aggregate can easily be mixed into the
moist sand and cement. If the mix still cannot form a ball
in the palm of the hand, it is too dry. Add more water.

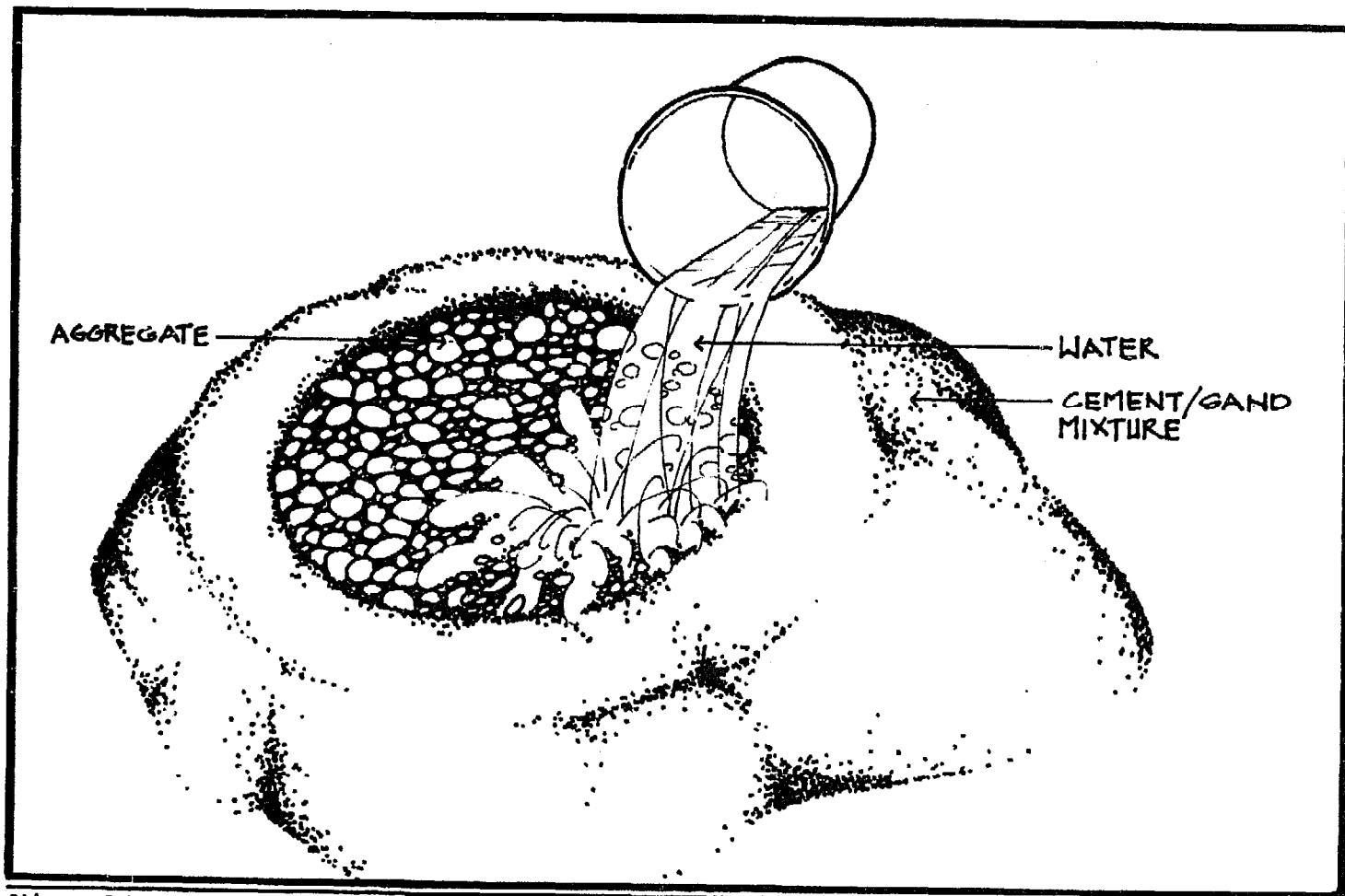

Fig. 15 Making concrete. Cement/sand mix with aggregate and water added in center.

Non-salty, 1/4-inch sifted gravel or coral can be used as aggregate. Smooth-surfaced aggregates require less water in the mixture and the blocks tend to free themselves from the form with less friction than blocks made with rough, porous aggregate such as coral.

Three people are needed to keep one hollow block form in constant production. One person keeps the supply of cement, sand, aggregate and water constant. The second mixes materials. The third person operates the hollow block form.

With two forms, six people can work together in two teams of three persons each. Friendly competition often develops between the two groups as to who can produce the highest number of quality blocks in the shortest amount of time. This sparks interest in the project and encourages productivity. Members of the community unable to perform rigorous labor can be assigned the task of supplying the work force with fresh drinking water and snacks.

Slowly fill the hollow block form with concrete. (See Fig. 16) Tap the form on the ground to insure an even settlement of the concrete within the form. Fill the form until concrete is heaped on top. Lightly pat down the concrete with a piece of wood and scrape the excess from the top. Do not pack the concrete into the form so tightly that it is difficult for the block to slide free.

If the hollow blocks are being made on a concrete slab, keep the slab dry and sprinkle it with sand to prevent the moist blocks from sticking to the surface. If, however, the blocks are cast on an earthen surface, apply liberal amounts of water to the ground. This is done to counteract the tendency of the ground to draw moisture from the new hollow blocks.

Now turn the form over, tap the sides of the form with a piece of wood and slowly lift it to allow the new hollow block to slide free. (See Fig.17) If the block sticks in the form, try lining the bottom of the form with a removable piece of semi-rigid sheet metal. The lining should come out of the form with the block. Wash the lining and the inside of the form before refilling it with concrete.

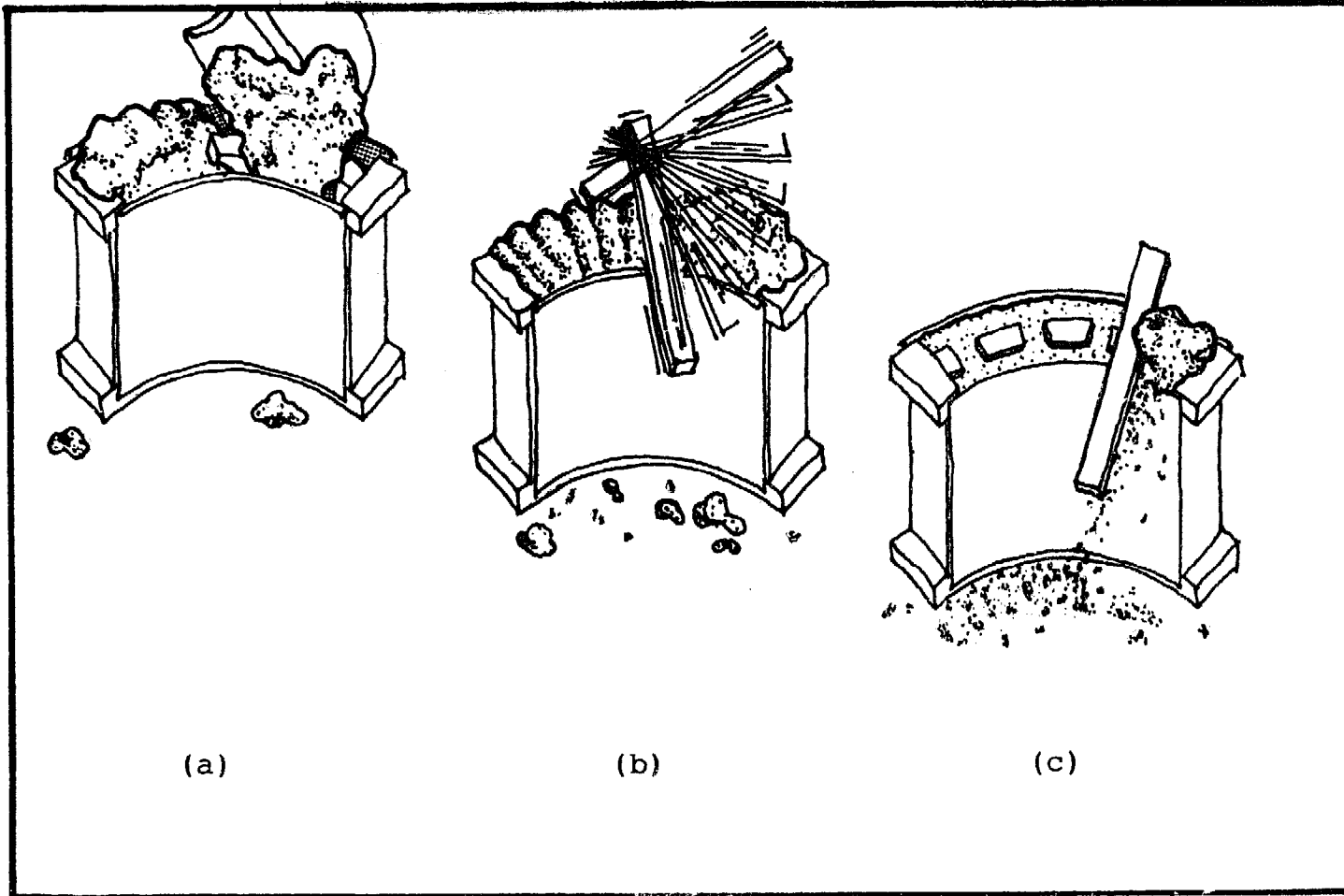

38 Fig. 16 Making hollow block. (a) Fill form, (b) Pat, (c) Scrape excess.

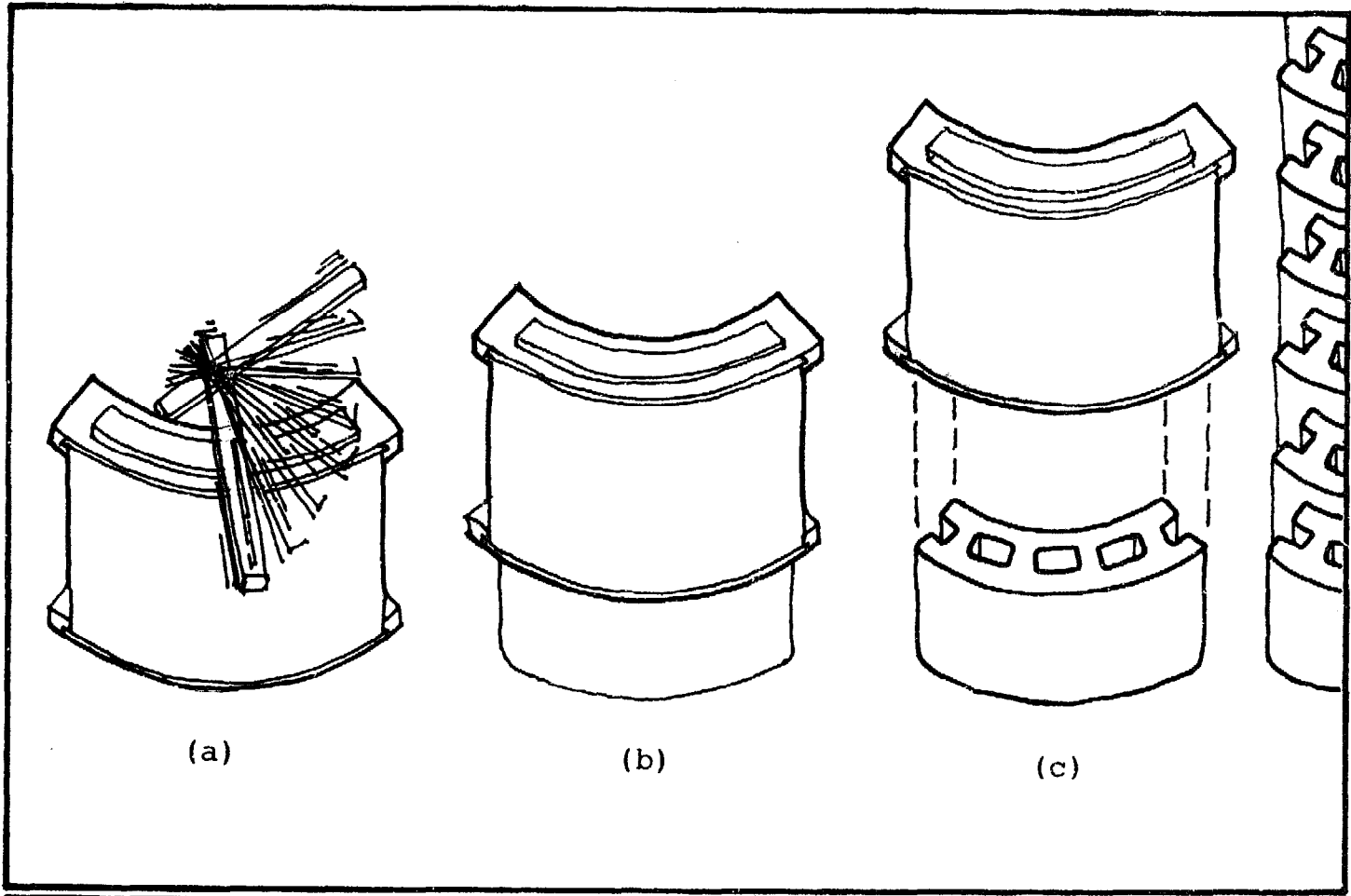

Fig. 17 Block release. (a) Turn over form, (b) Tap sides and bottom, (c) Lift.

Twelve hours after making the hollow blocks, sprinkle them with water. The chemical process whereby concrete mixtures harden only takes place in the presence of water. When water no longer exists in concrete, the hardening process ends; therefore, strength is gained when the drying time is lengthened.

To insure an extended drying time, hollow blocks should be made in a shaded area or under a pavilion and, beginning the second day, watered liberally two to three times a day for one week. It is critical that water is present the first week to insure a strong block. Hollow blocks should never be allowed to dry in the sun.

Six people working with two hollow block forms can easily produce 150 blocks in one day with approximately 35-40 blocks in one, 40-kilo bag of cement.

*Note: Use ordinary cement for the entire well. Waterproof cement is necessary for water storage tanks.

CUTTING RING

The cylinder portion of the well is made by stacking multiple rings of hollow block on top of one another. It is extremely heavy and needs a solid, concrete foundation ring to support it. A foundation is necessary to keep the hollow blocks from splitting apart if the cylinder settles. The foundation with a bevelled underside is known as a cutting ring. The bevelled cutting ring helps the cylinder settle evenly.

Pour the cutting ring 24 hours after making the hollow block in order to use the blocks to plan the circumference of the well. Flatten a pile of wet sand, clay or firm soil, 1.5m wide x .5m high (58 in. x 19 in), adjacent to the well hole so the cutting ring will be easy to transfer.

The medium must be wet so it does not collapse and does not draw moisture from the newly poured cutting ring. Sand is the ideal medium because it is easy to mold. The excess sand from the hollow blocks can be used for the cutting ring mold.

Form a circle on top of the mound using the number of hollow blocks in the circumference of the well. Remove the hollow blocks and use the depression where the blocks were as a guide for the cutting ring pattern. (see Fig.18) Figure 19 shows how to use string as a guide for the cutting ring pattern described below.

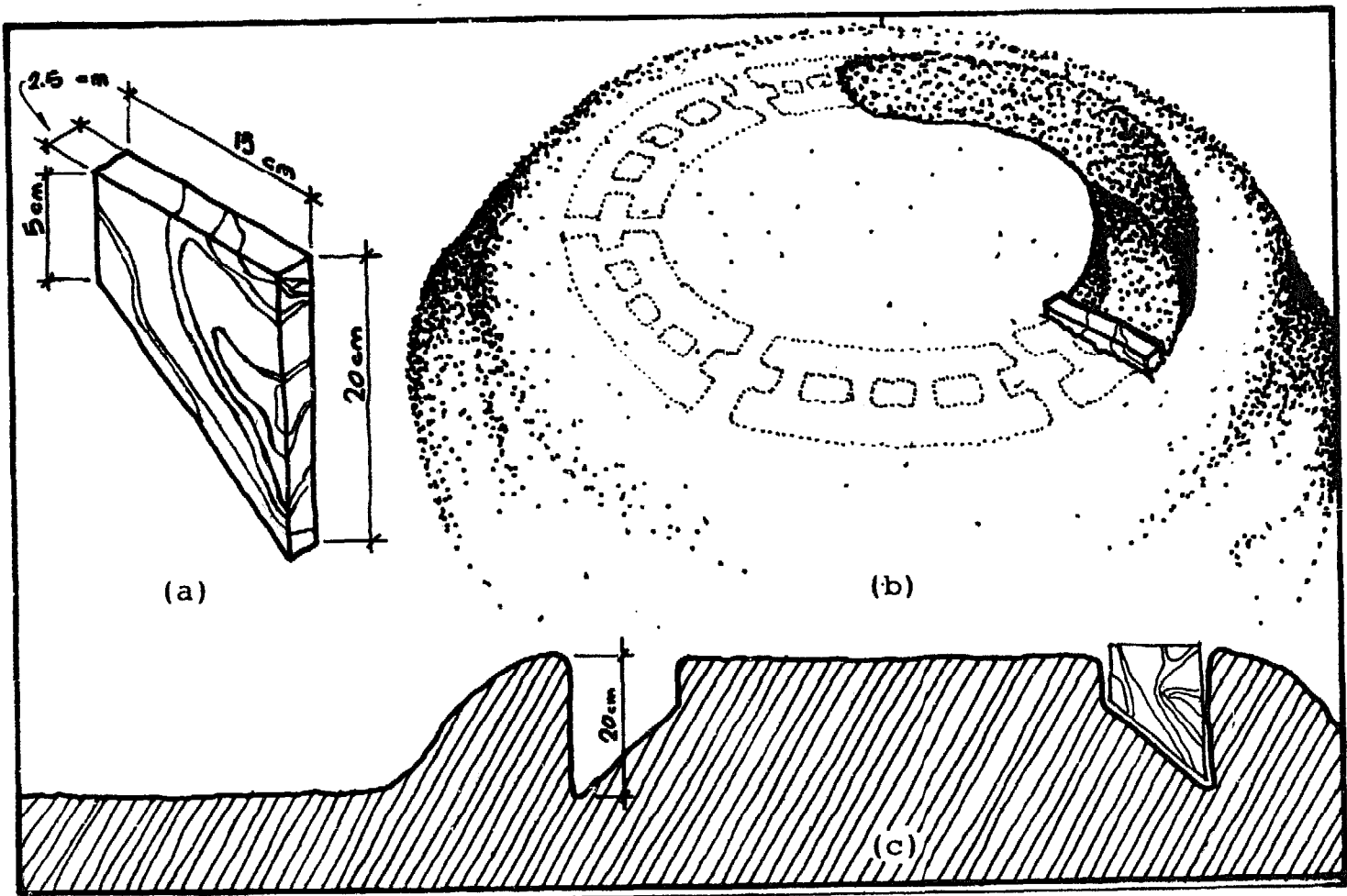

42 Fig. 18 Cutting ring. (a) Cutting ring pattern, (b) Imprint of hollow blocks in sand, digging trench, (c) Section of trench.

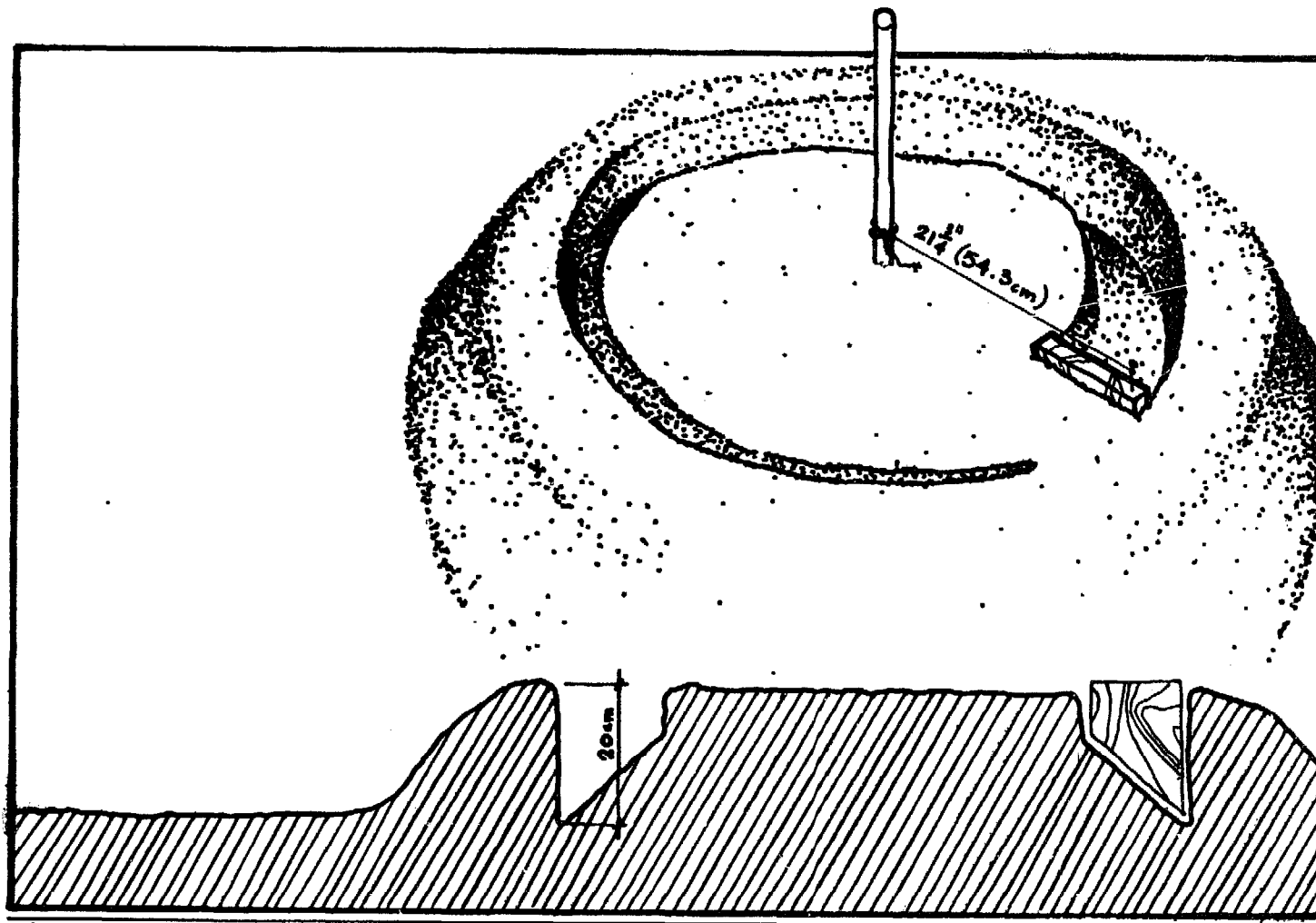

Fig. 19 String method for making cutting ring mold with side section below.

Cut a piece of plywood or 1 in. x 6 in. lumber into the cutting ring pattern shown in Fig. 18a. Use the pattern to dig a bevelled, circular trench 20cm deep (8 in.) for the cutting ring. Remove the excess sand from the trench while digging. Form the trench so that it extends 2.5cm (1 in.) on the outside and 2.5cm (1 in.) on the inside of the hollow block print and so the deeper portion is on the outside of the ring.

Next make (2) reinforcing rings out of sliced bamboo or 6mm steel bars to fit in the center of the trench. (See Fig. 20) These reinforcing rings are intended to absorb some of the tension in the cutting ring caused by the load of the hollow blocks.

The mix for the cutting ring is **1 container cement : 2 containers sand: 2 containers aggregate**. The higher ratio of cement in the mix gives extra strength to the cutting ring in order to support the weight of the cylinder. Add plenty of water to the mix so it is easy to manage.

Fill the bottom of the trench with 5cm (2 in.) of concrete. Place the first reinforcing ring on top of the new concrete and add 10cm more (4 in.) of concrete. Add the second reinforcing ring and pour 5cm (2 in.) of concrete to fill the trench. Coat the top of the trench with a mortar mix of **1 part cement: 4 parts sand** and return one layer of hollow block to the top of the cutting ring. (See Fig. 21)

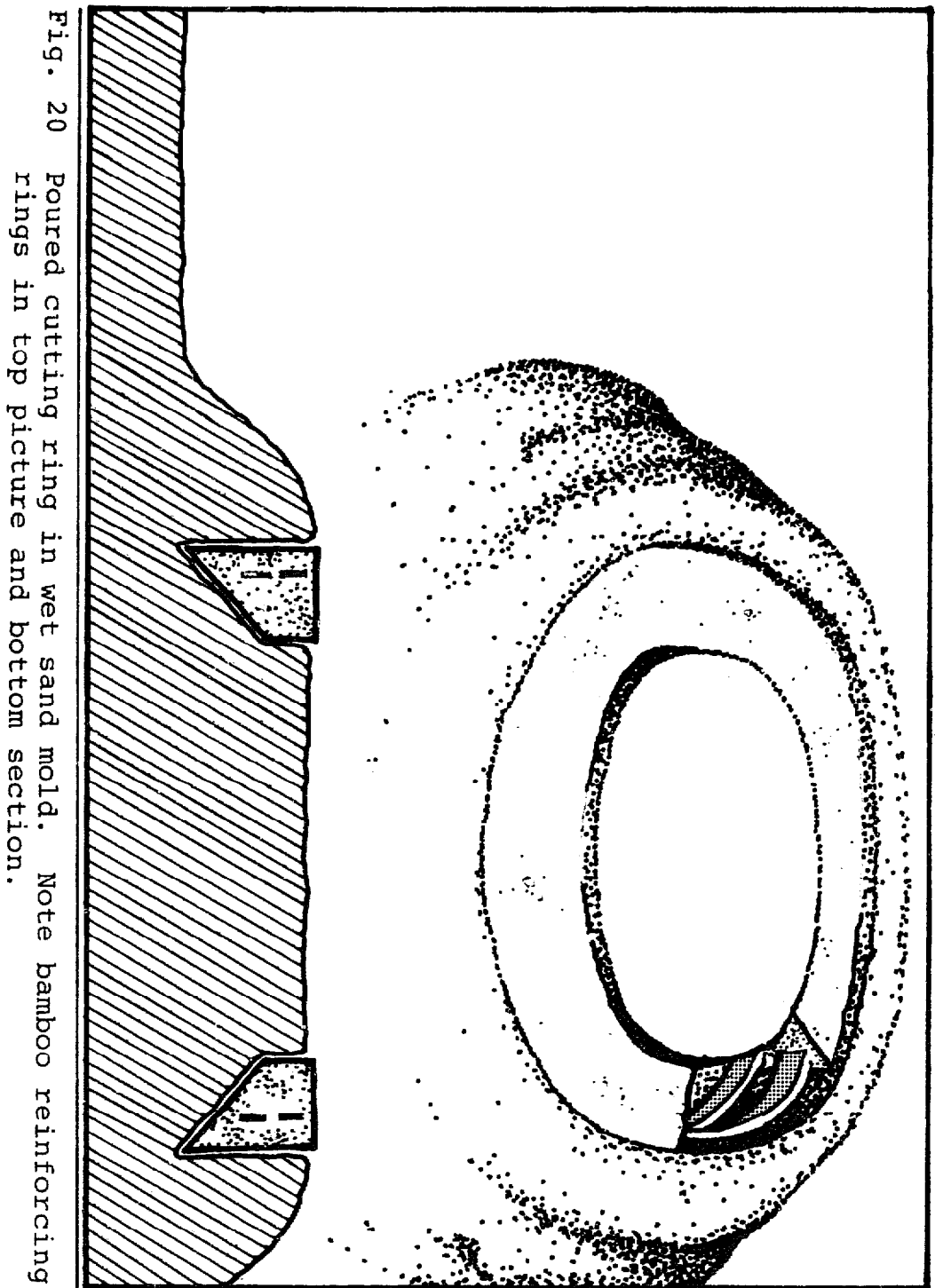
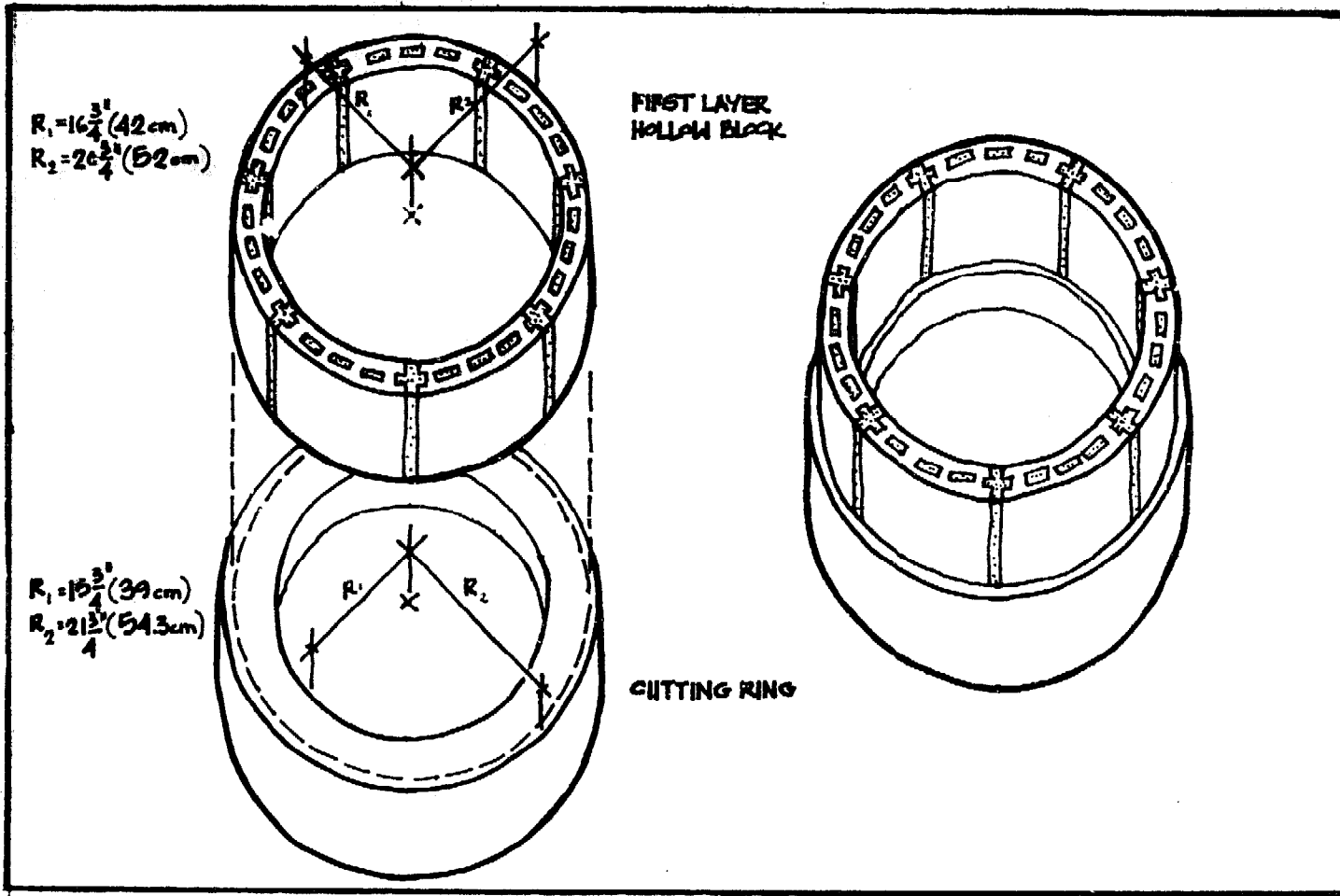

Fig. 20 Poured cutting ring in wet sand mold. Note bamboo reinforcing rings in top picture and bottom section.



46 Fig. 21 Placement of first row of hollow block on cutting ring. Note the cutting ring is wider than hollow blocks.

Hollow blocks must cure for 24 hours before they are strong enough to transfer to the cutting ring. Always water the blocks before using them so the surrounding surfaces do not draw out the moisture and weaken the block. Be careful placing the blocks on the freshly poured cutting ring because they are still fragile.

Unlike a square well which requires steel reinforcing in the walls, the inherent strength of the circular-shaped well minimizes the the need for steel reinforcing. While the concrete is wet, it is optional to drive a 1/2m (20 in.) bamboo dowel through the center hole of each block and into the cutting ring. The dowels are not necessary for strength, but they will help keep the cylinder going straight up as more layers are added. Those experienced in working with hollow block may omit the dowels. (See Fig. 22)

Completely fill the holes in the first layer and all the joints between blocks with a mortar mix of **1 part cement: 4 parts sand**. Add enough layers of hollow block to the top of the cutting ring so that when it is lowered into the water the top of the top layer is above the groundwater line. (see Figs. 23)

Water this partial cylinder two or three times a day for one week and keep it shaded while the blocks and cutting ring are curing. Let the partial cylinder cure one week before transferring into the well hole.

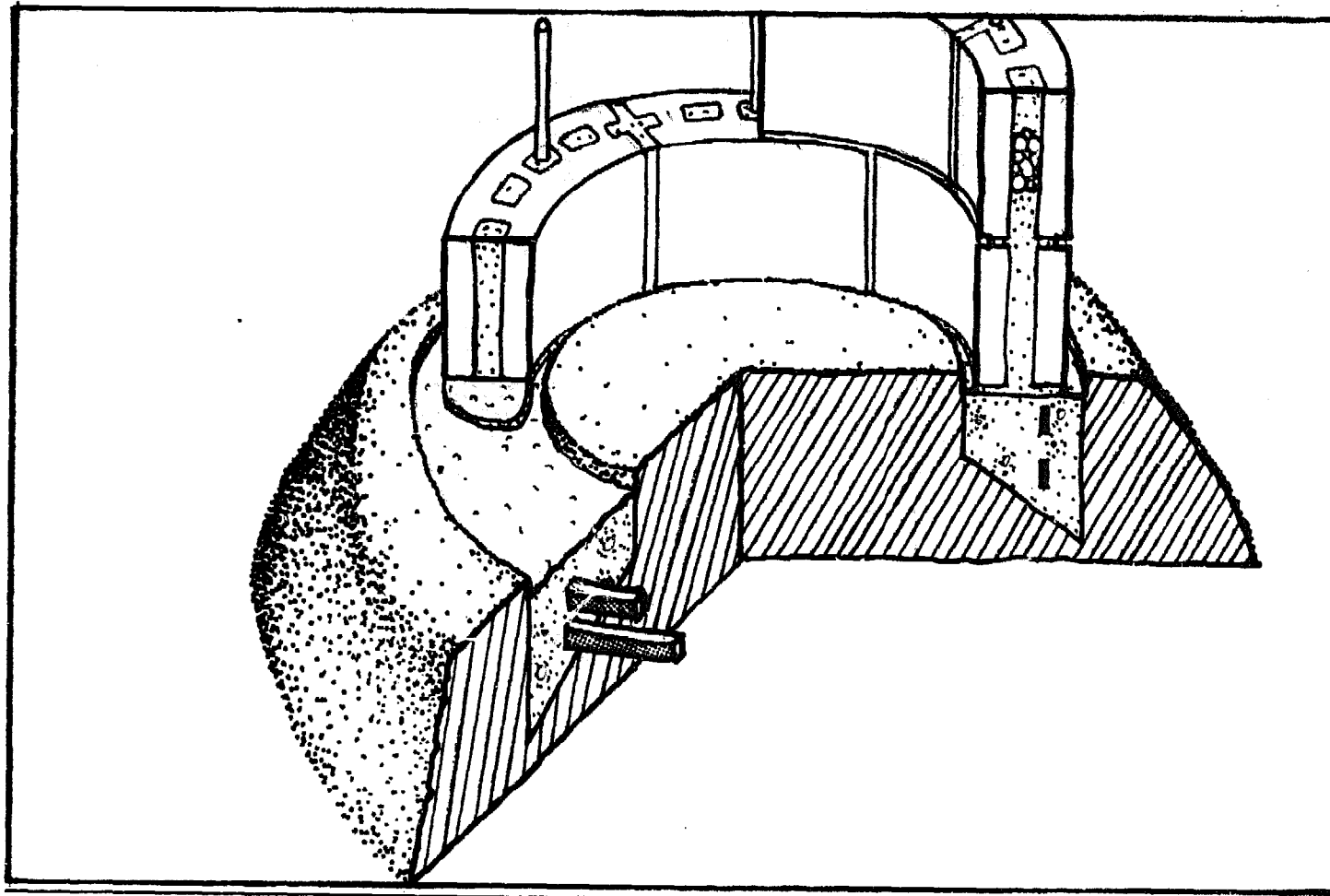

48 Fig. 22 Detailed cutaway of cutting ring with partial cylinder in progress.

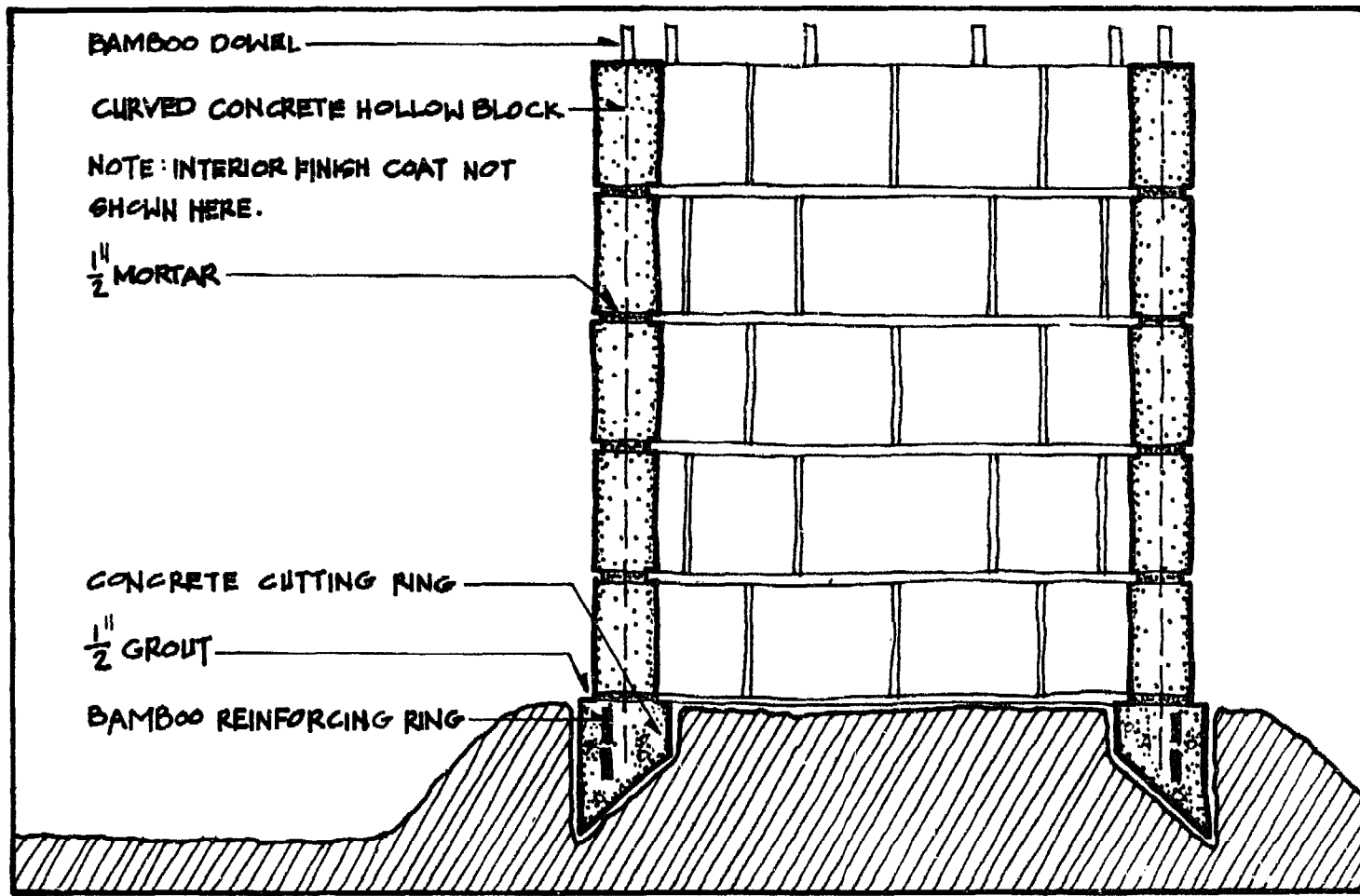

Fig. 23 Completed partial cylinder. Must be higher than the water in the well is deep.

CYLINDER

Making a curved hollow block cylinder is similar to building a non-loadbearing wall of hollow block. Three people can easily complete the cylinder in two days; however, eight to twelve people are needed to lower the partial cylinder into the water.

Before lowering the partial cylinder, make sure the bottom of the well is level. This will insure that the cutting ring is not under unnecessary stress and that the finished cylinder is straight. There are mechanical and manual ways of lowering the partial cylinder; two of the most popular are shown in Figures 24 and 25. The people in the area will undoubtedly have another solution to lowering the ring. Be careful not to crack the cutting ring portion of the partial cylinder while transferring it.

Once again, make certain that when the partial cylinder is lowered into the well, at least one-half a block is above the water so the next layer of block can bind and dry to the exposed block.

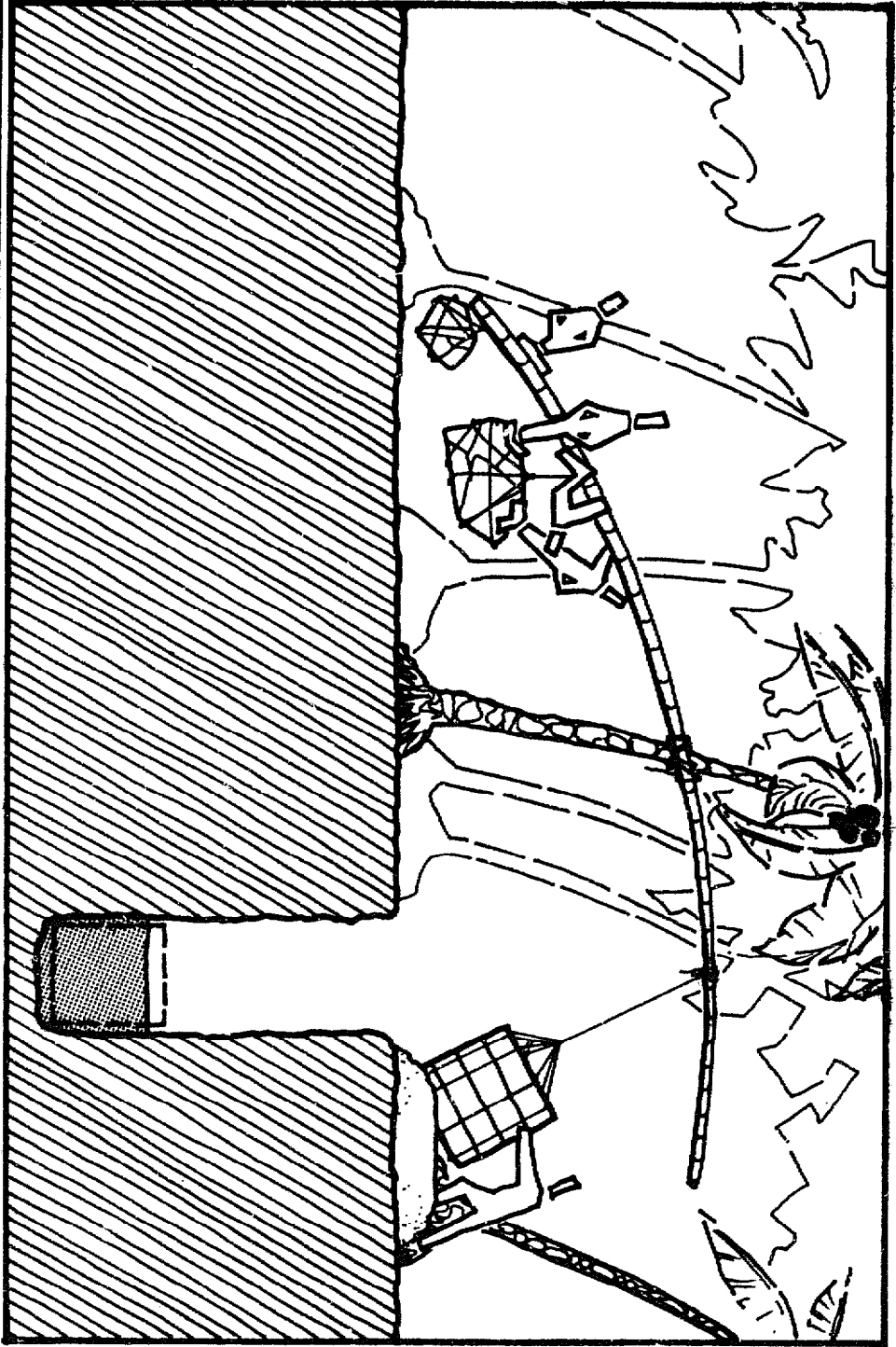
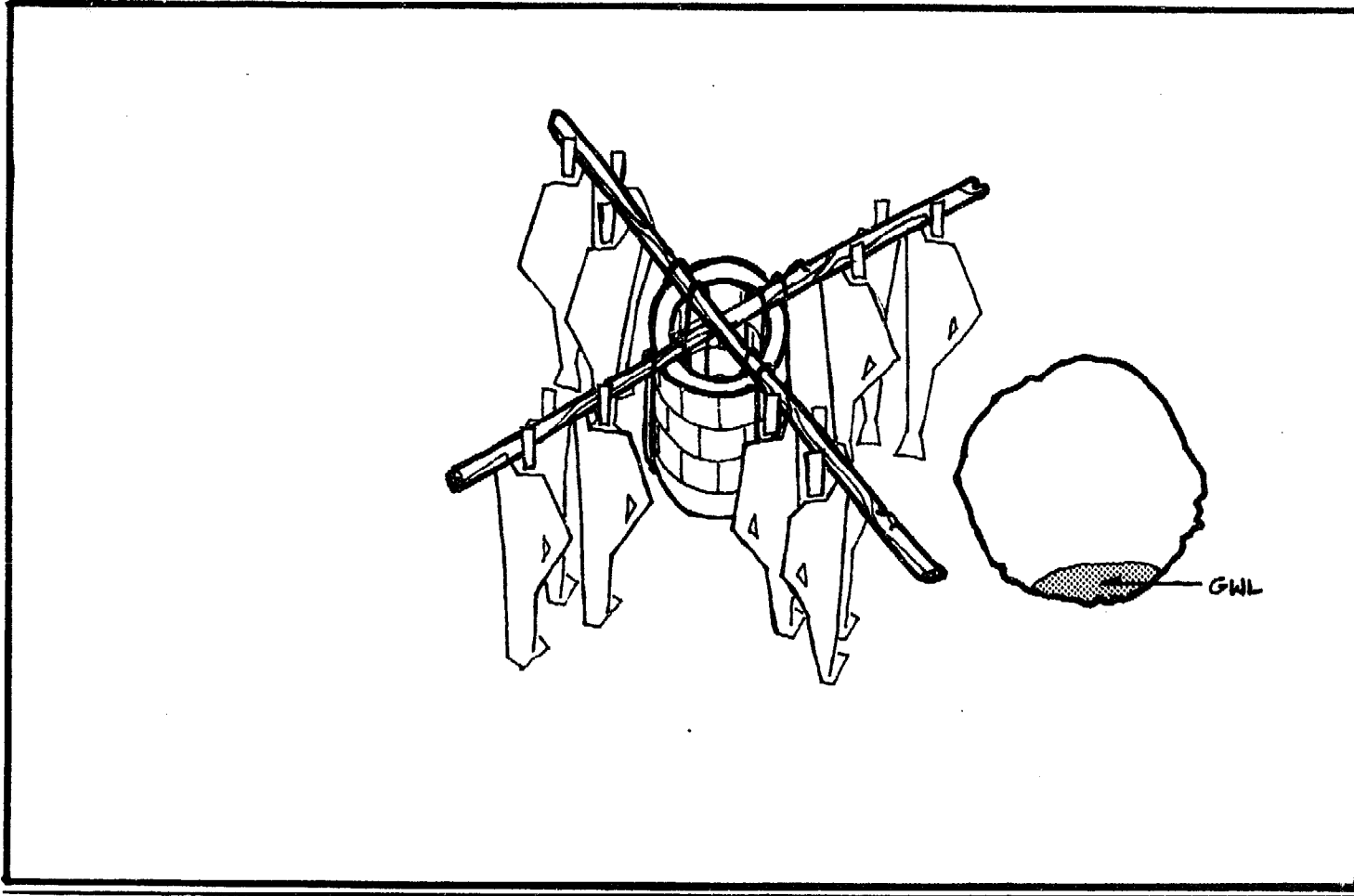

Fig. 24 Manual crane to transfer partial cylinder into well hole.



52 Fig. 25 Group of nine to lift partial cylinder into well hole.

After the partial cylinder is in place, a work team of three can begin to build the remaining portion of the cylinder. Fill the openings in the half-exposed hollow block on the partial cylinder with mortar and place a 5mm -15mm (1/4 in.- 1/2 in.) layer of mortar on top of the block. Wet the blocks, slide the block over the bamboo dowels and settle it firmly on the layer of mortar. Be sure that the new hollow block is in line with the block below it and that the block placement is staggered so the joints between blocks rest on a solid block below.

Both the vertical and horizontal joints between the blocks must be filled completely with mortar. If cement is limited, lay the first row of hollow block on the cutting ring with pure mortar. The holes within the block on all additional layers can be layered with 1/3 mortar, 1/3 aggregate and the top third with mortar. (See Fig. 26) If bamboo dowels are used as guides to keep the cylinder straight, be sure to pack mortar around the dowel.

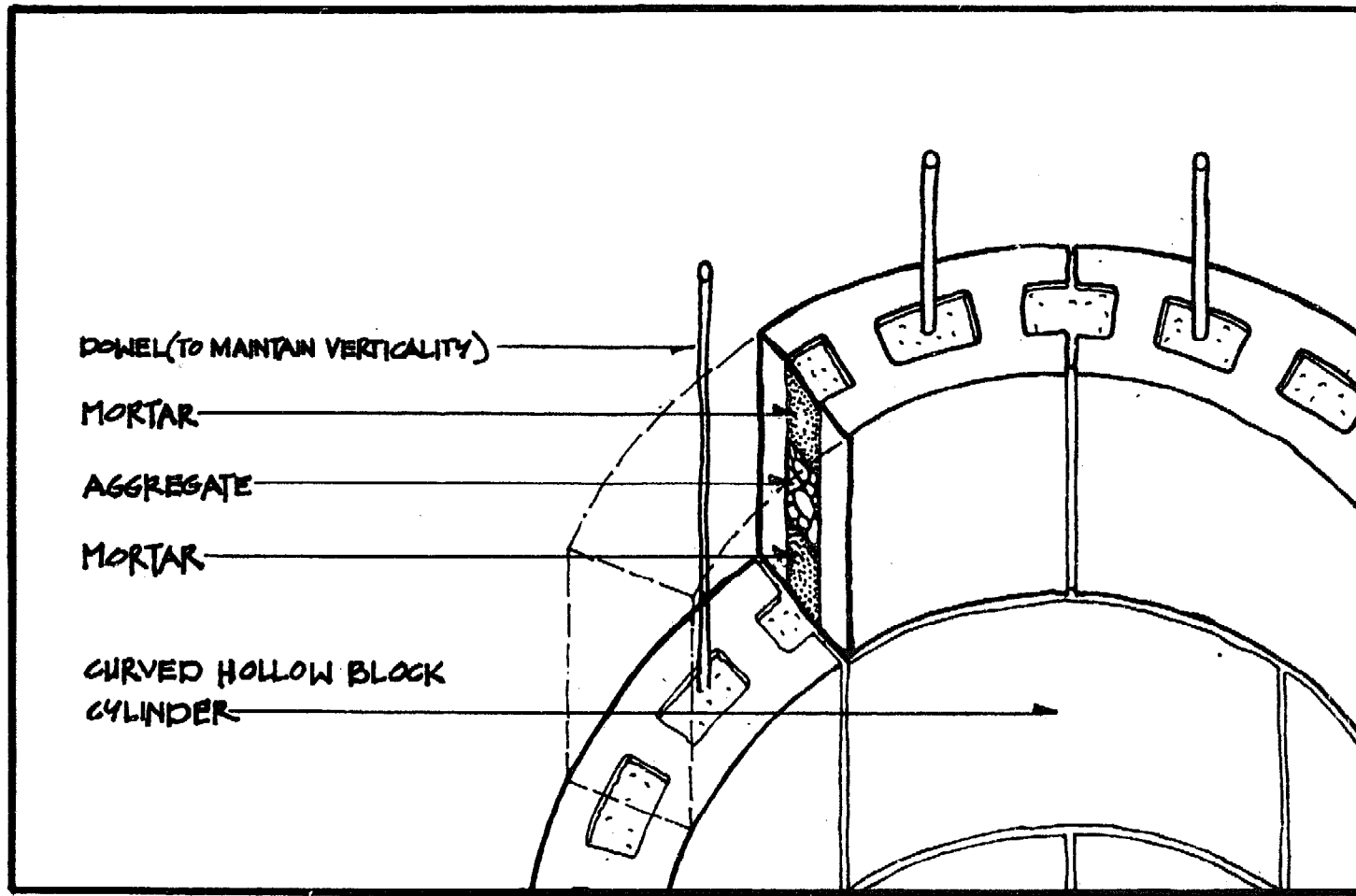

54 Fig. 26 Cylinder construction. Alternating mortar and gravel conserves cement.

The cylinder can take 1-3 days to build depending on the speed of the workmen. If the cylinder takes more than one day to build, complete a row of hollow block and fill the holes and joints halfway with mortar. The next day completely fill the holes and joints with mortar and continue building the cylinder. The fresh mortar will bind the new block to the block laid the day before. The seam between the day-old construction and new layer will be within a single block where it is less likely to crack from pressure.

Place a pipe brace one-third and another two-thirds the way up the cylinder by chipping away a portion of the hollow block as shown in Figure 27. Secure the braces to the cylinder wall with mortar. The braces will prevent the pipe from vibrating while water is being pumped out.

As the cylinder rises, backfill on the outside of the wall with gravel, a 5cm- (2-in.) concrete curb, and the original soil medium as shown in Figure 28. The gravel permits water to enter the well more quickly while the original medium acts as a filter. The concrete curb between the gravel and soil acts as a final bearer to contaminated run-off. Backfilling will allow one person to work on the inside and another to stand on the outside of the cylinder and greatly speed up construction.

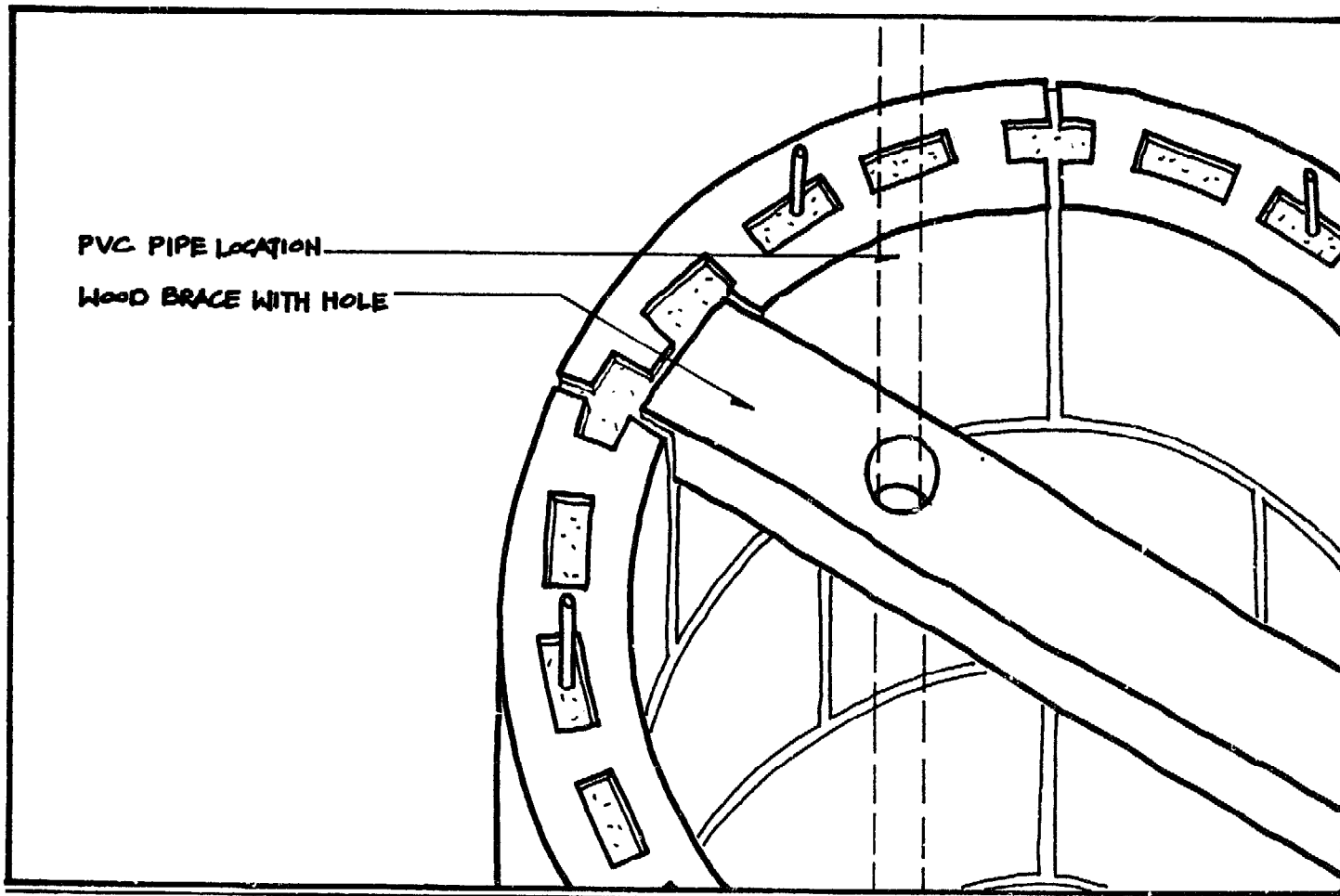

56 Fig. 27 Installing wooden brace. Brace limits pipe vibration during pumping.

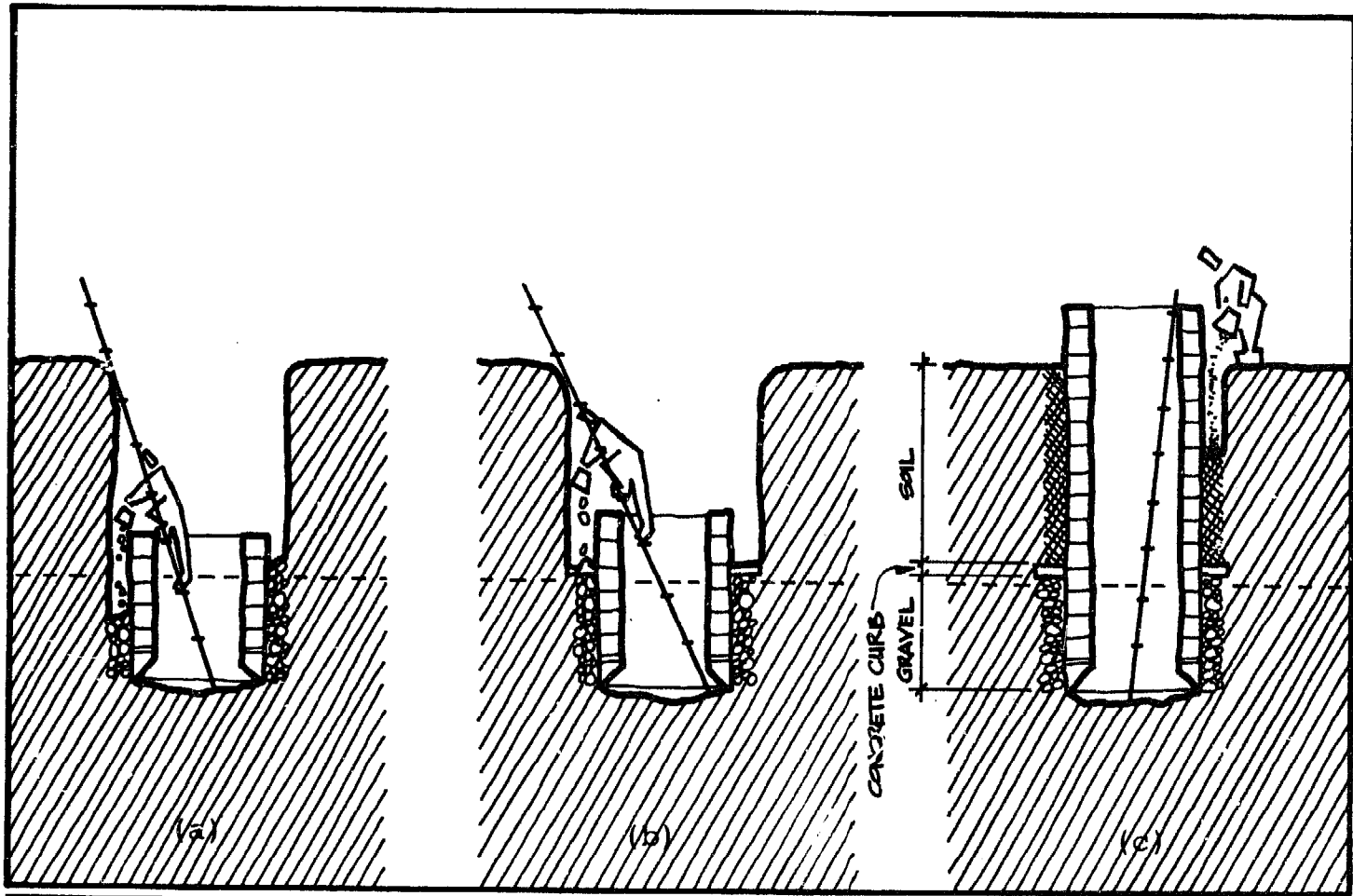

Fig. 28 Backfill as cylinder rises. (a) Gravel to height of partial cylinder. (b) 5cm (2 in.) concrete. (c) Fill with original soil. 57

The mortar used throughout the well construction is a mixture of 1 part cement: 4 parts sand. Sift the sand through two 3mm (1/8 in.) screens before mixing it with the cement and water. Add enough water to make the mortar easy to manage--it will be more wet than the hollow block mix. Use a diamond trowel or edging tool to smooth the mortar.

Put a finishing coat of mortar on the inside of the wall starting from the top of the partial cylinder in order to lessen the risk of contamination from the surrounding area. Do not put a finishing coat on the partial cylinder itself so that water can penetrate the well more quickly.

Build the well so that it extends 1m (3 ft.) above ground level. This will prevent surface run-off and refuse from entering the well and contaminating the water and act as a safety precaution for children playing around the well.

That part of the cylinder which is above the ground should also be finished on the outside starting 1/2m (approx. 2 ft.) below ground level as a precaution against surface contamination.

Place a 15mm (1/2 in.) wedge of mortar on the top layer of hollow block to seal the cylinder with the cover. (See Fig. 29) The wedge shape will prevent the cover run-off from entering the well.

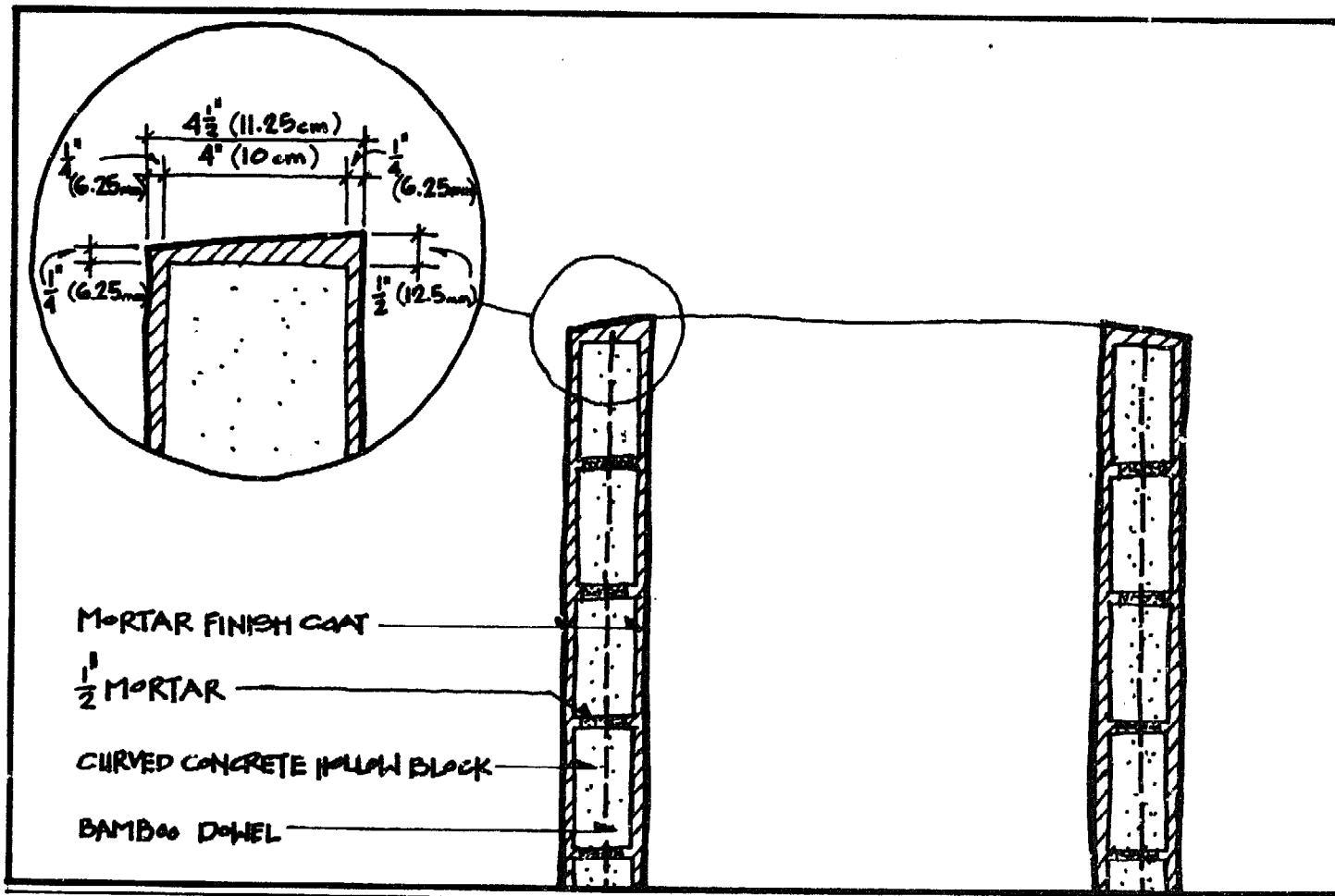

Fig. 29 Mortar wedge on top of cylinder to prevent contaminants from entering the well.

As another precaution against contaminated drinking water, add a well pump and cover. To install a pump with the well, make a 5cm hole (2 in.) in the cylinder wall 15cm (6 in.) below ground level through which the piping will pass. (See Fig. 30) Situate the pump off to one side of the well so that any spillage does not return in the direction of the well and so the well can still be used if the pump is not working.

If laundry and bathing are to take place near the pump, run a horizontal steel pipe 6m from the well for the pump. However, if the users agree to bathe and do laundry away from the well, a 1 1/3m (132cm or 52 in.) horizontal steel pipe should be sufficient. Dig a trench 6cm wide x 15cm deep (3 in. x 6 in.) the length of the horizontal pipe and in line with the hole in the cylinder wall. At the end of the trench dig a 30cm x 30cm x 5cm deep hole (1 ft. x 1 ft. x 2 in) to serve as the base of the pump stand. (See Fig. 31)

Assemble the horizontal pipe and 60cm (2 ft.) vertical pipe with a plumbing wrench according to Figure 31. The horizontal pipe should extend 30cm (1 ft.) into the cylinder when in place. Be sure to wrap the threaded ends of the steel pipe with sealant tape before attaching any hardware such as elbows. After laying the pipe, fill the trench with 10cm (4 in.) of dirt. (See Fig. 32) The pump stand will be filled with concrete later.

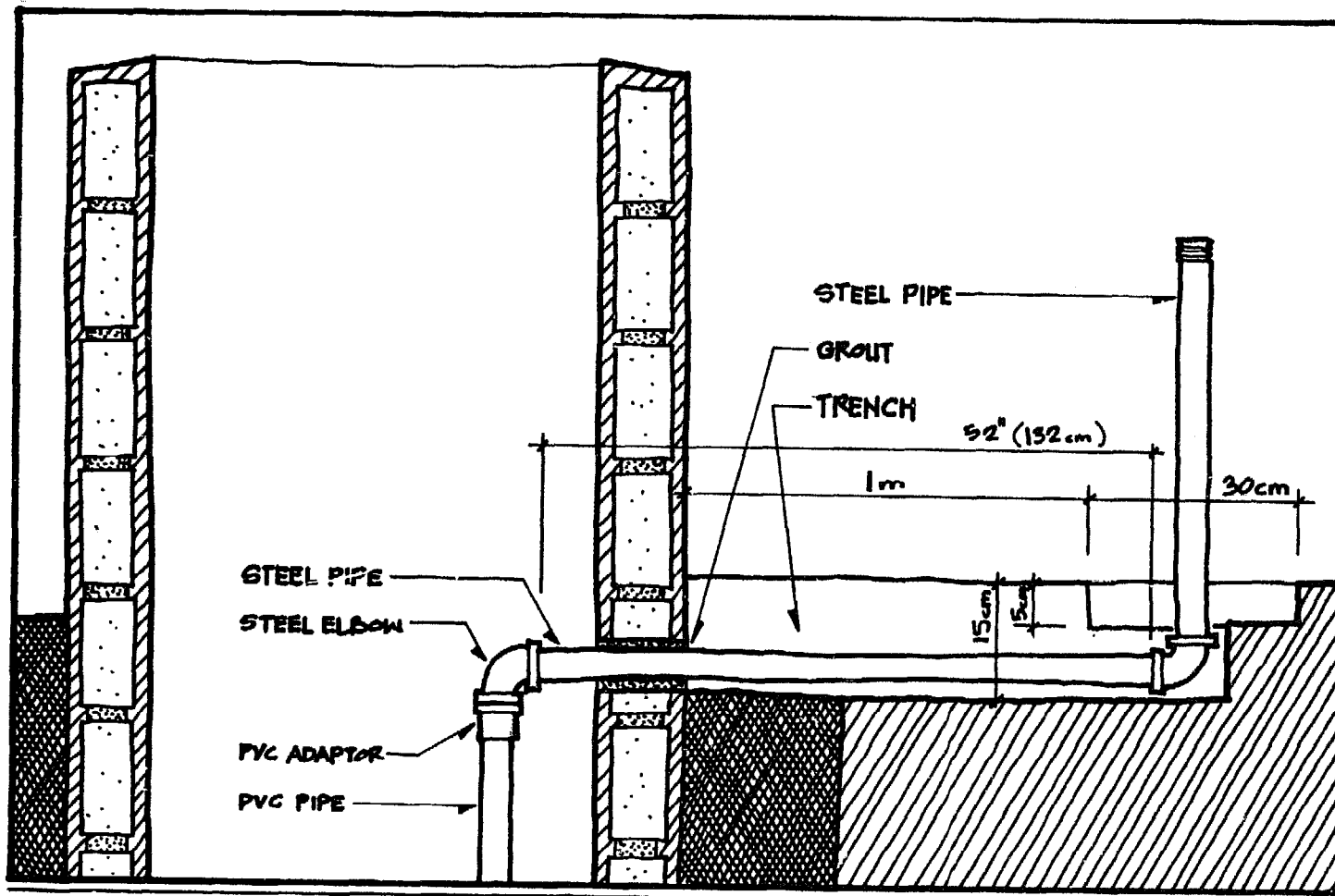
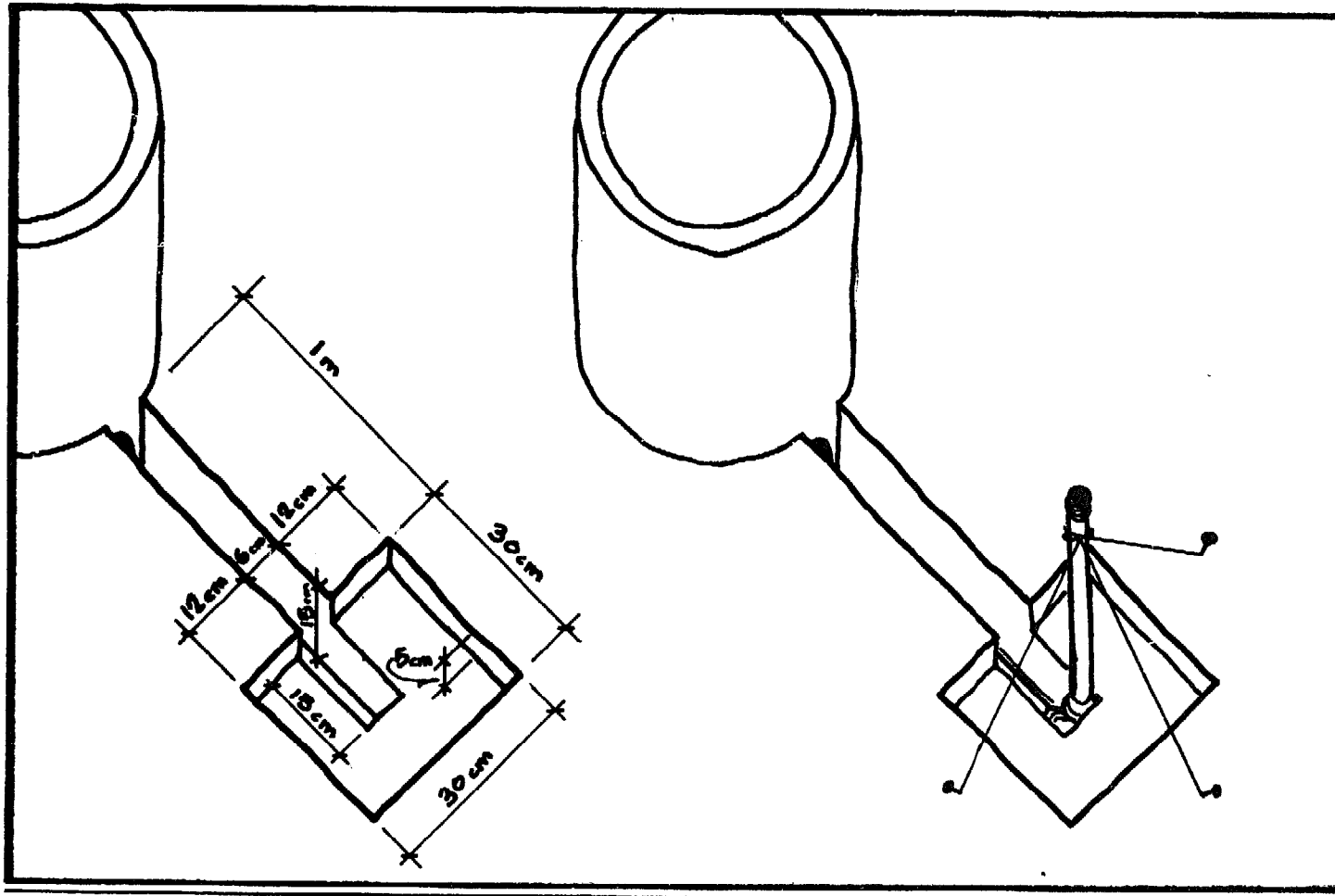

Fig. 30 Trench for steel pipe.



62 Fig. 31 Detail of pipe trench and hole for pump stand.

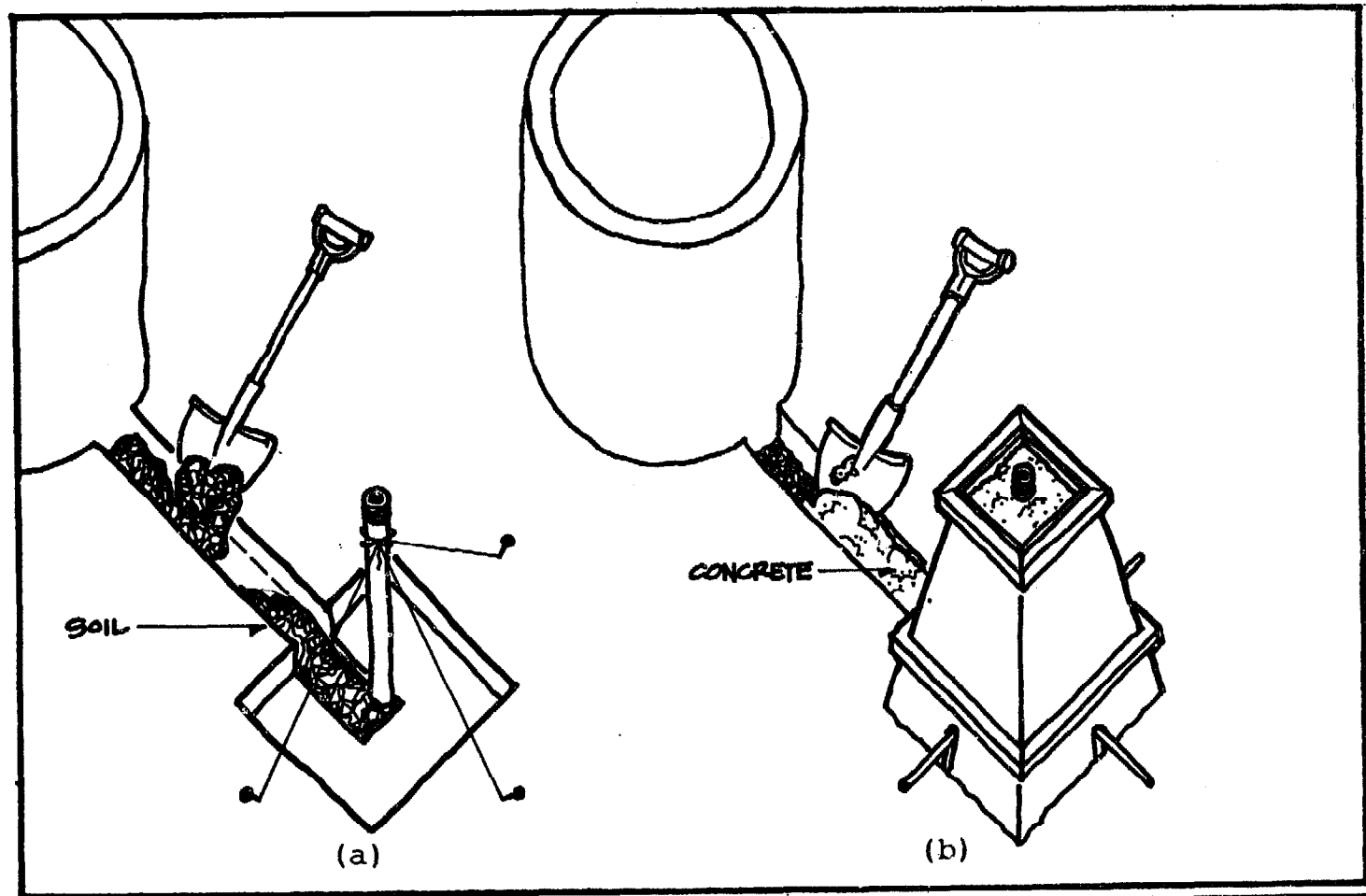

Fig. 32 Fill trench and pump stand. (a) Fill trench with 10cm of soil. 63
(b) Later top trench with 5cm of concrete and fill pump stand.

PUMP STAND AND COVER

People enjoy the opportunity to personalize their wells. The exterior finish of the cylinder as well as the cover and pump stand is where personal creativity and group input begin to take place. Later, each group can design its own apron, fence and signboard for the well. Pride in their workmanship gives a greater assurance that the group that built the well will also maintain it.

The group building the well tends to want to make the apron too large for the amount of cement available; therefore, make the pump stand and cover first. While there are endless varieties of pump stands and covers, only one is described in detail here.

The **pump stand and cover** are made at the same time. The concrete mix for the **pump stand** is: **1 part cement: 4 parts sand: 2 parts aggregate.**

Make the form for the **pump stand** from scrap plywood, cooking oil cans or any other locally available material. (See Fig. 32) Make the form so that the finished pump stand is 20-30cm (8-12 in.) on each side if it is cubical or at least 20cm (8 in.) in diameter if it cylindrical. Personal creativity can enhance the appearance. Figure 33 shows examples of different pump stand shapes.

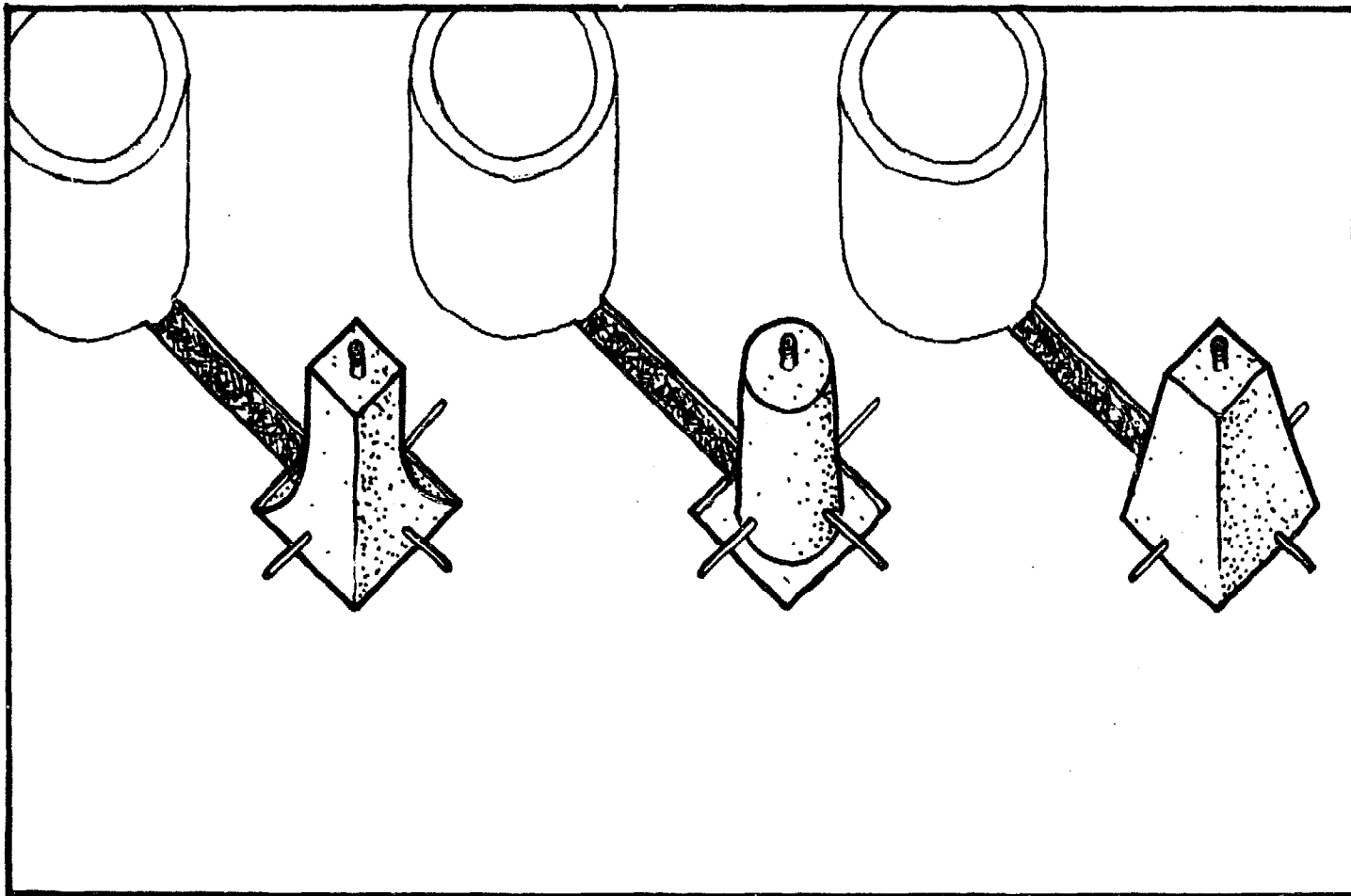

Fig. 33 Alternative pump stand designs.

The pump stand must be the height of the vertical pipe with 3cm (1 1/4 in.) of the threading extending above the top of the stand in order to attach the pump. Cover the opening of the vertical pipe and pour the concrete into the form. Add dowels, nails or chicken wire to the base of the concrete stand to tie it in structurally with the apron which will be poured later. (See Fig. 32)

The cover provides protection for the top opening of the cylinder. The cover described here is removable so the well can be used if the pump is not working. The concrete mix for the cover is: 1 part cement: 2 parts sand: 2 parts aggregate.

To begin making the cover, place three temporary braces across the hole to support the form. (See Fig. 34) The braces can be removed after the cover has cured. Next cut a piece of semi-rigid material, such as sheet metal, heavy cardboard or bamboo wall siding, into a circular shape to fit on top of the well and lay it on the braces.

Wrap the top of the cylinder with another piece of semi-rigid material, thin sheet metal will work, to hold the wet concrete in shape while it dries. This material should extend at least 12cm (6 in.) above the top of the well.

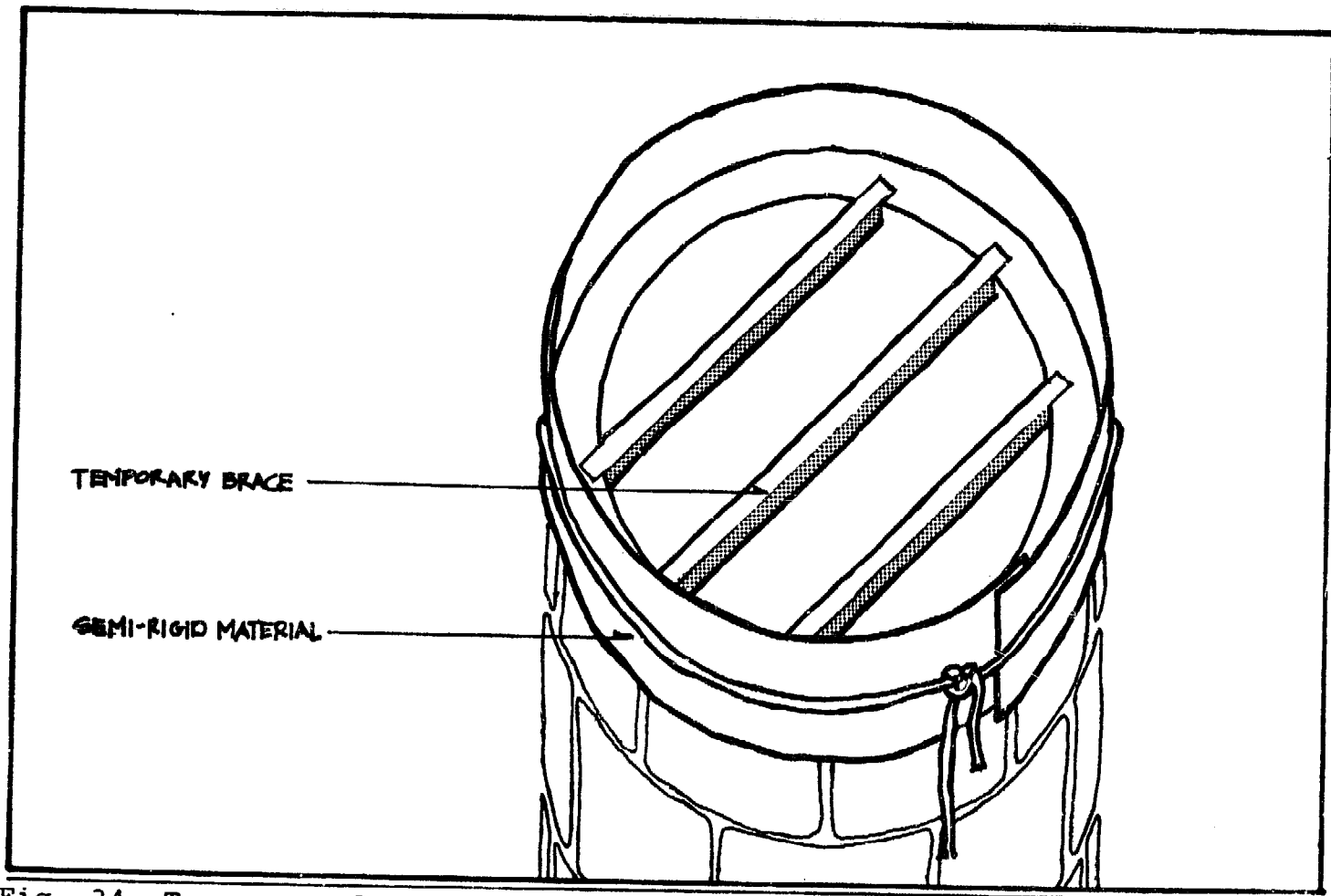

Fig. 34 Temporary formwork for cover.

Next, fold ordinary poultry wire accordion-style, three layers deep, and place it on the rigid material. To support the weight of the concrete, the poultry wire must be located on the underside of the cover. Cut or fold the wire layers into a circular shape and fit it into the cover mold. (See Fig. 35)

Use a scrap piece of steel bar to make handles for the cover. Bend the steel in such a way that two anchoring legs extend through and below the poultry wire mesh to insure that the tensile stress of lifting the cover is passed from the handles to the poultry wire and not to the concrete. (See Fig. 36)

Apply a mixture of 1 part cement: 2 parts sand: 2 parts aggregate 5cm (2 in.) thick above the wire mesh. Slightly slope the surface of the cover down toward the outside edge so water does not collect on top. After the concrete has hardened sufficiently, separate the cover from the mold, turn it over and apply a finish coat to the bottom side to conceal any exposed gravel or wire mesh. (See Fig. 37)

Another option for making the cover is to pour it in a sand mold similar to the method used to make the cutting ring. (See Fig. 38) Alternative cover designs are shown in Figure 39.

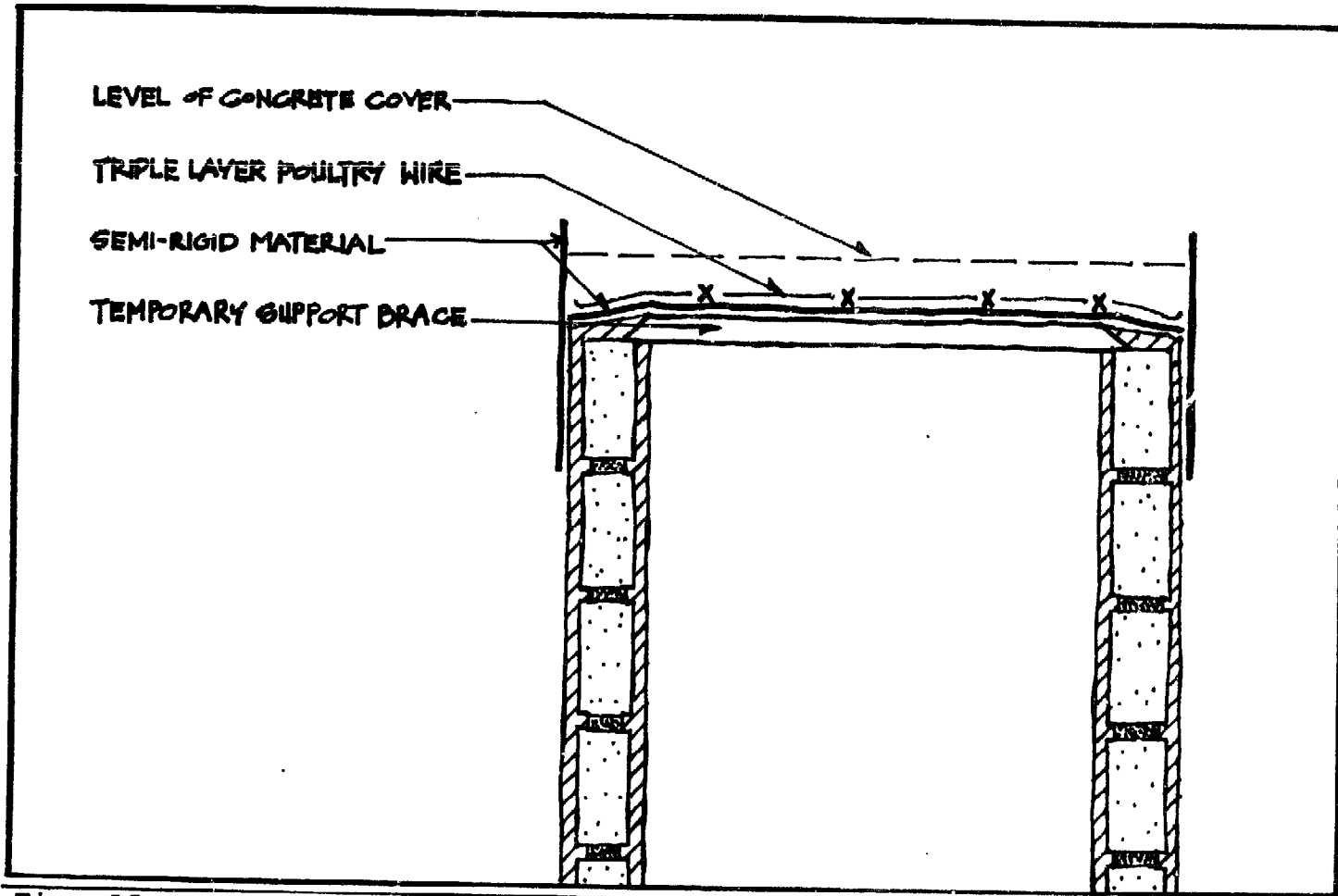
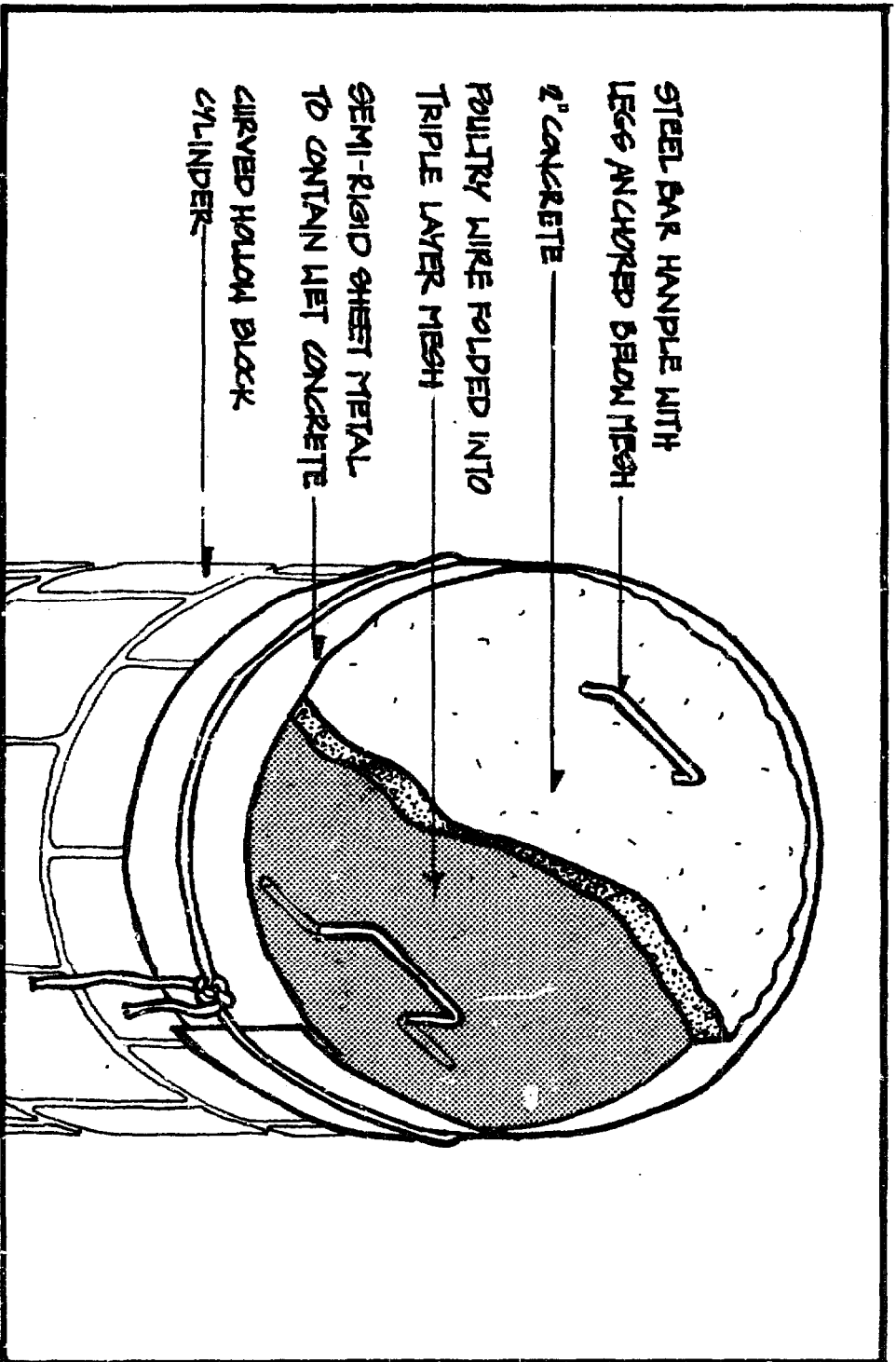

Fig. 35 Section through cover formwork prior to pouring concrete.



70 Fig. 36 Cutaway through concrete cover. Note handles are anchored through the three layers of poultry wire.

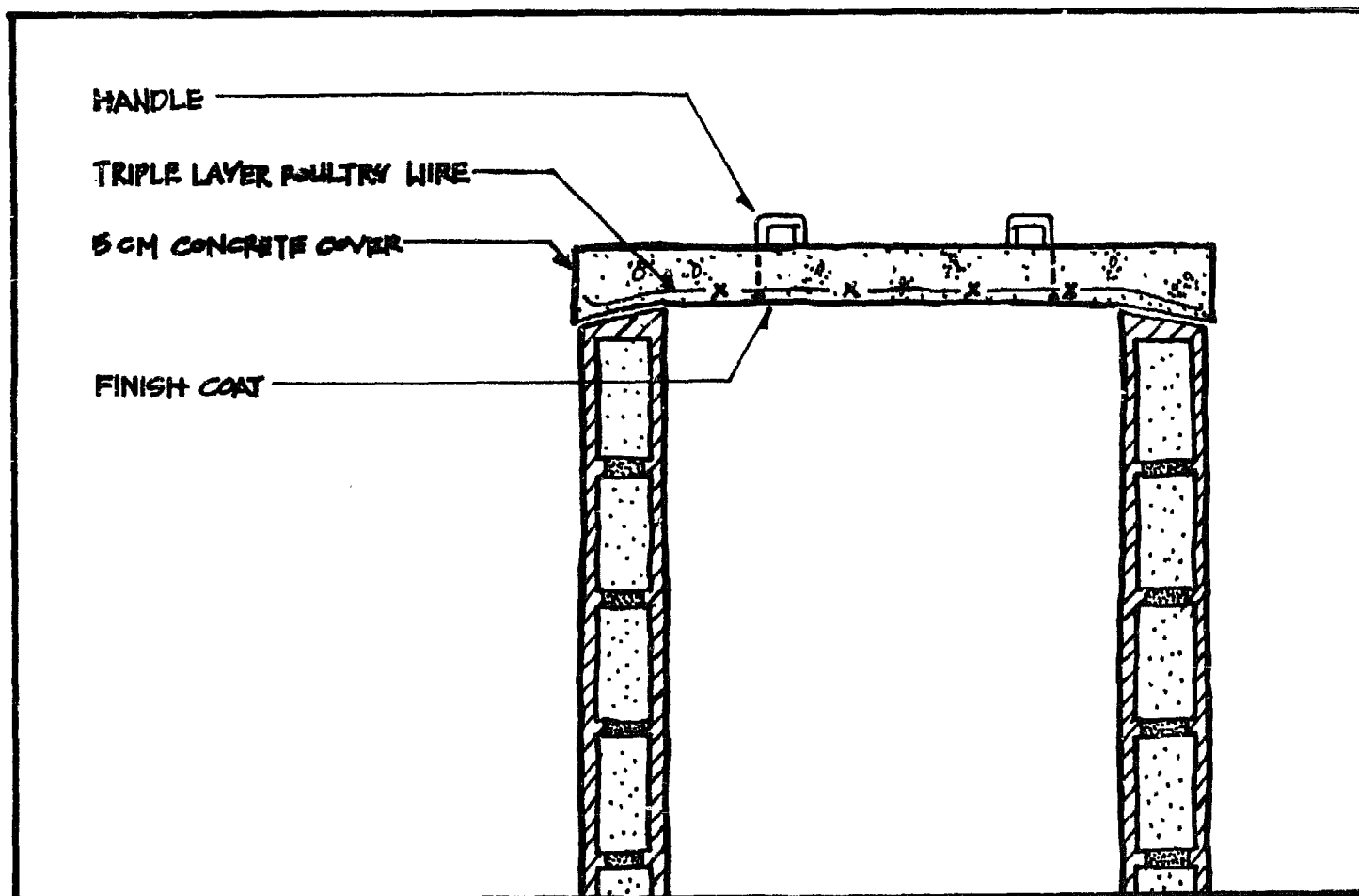
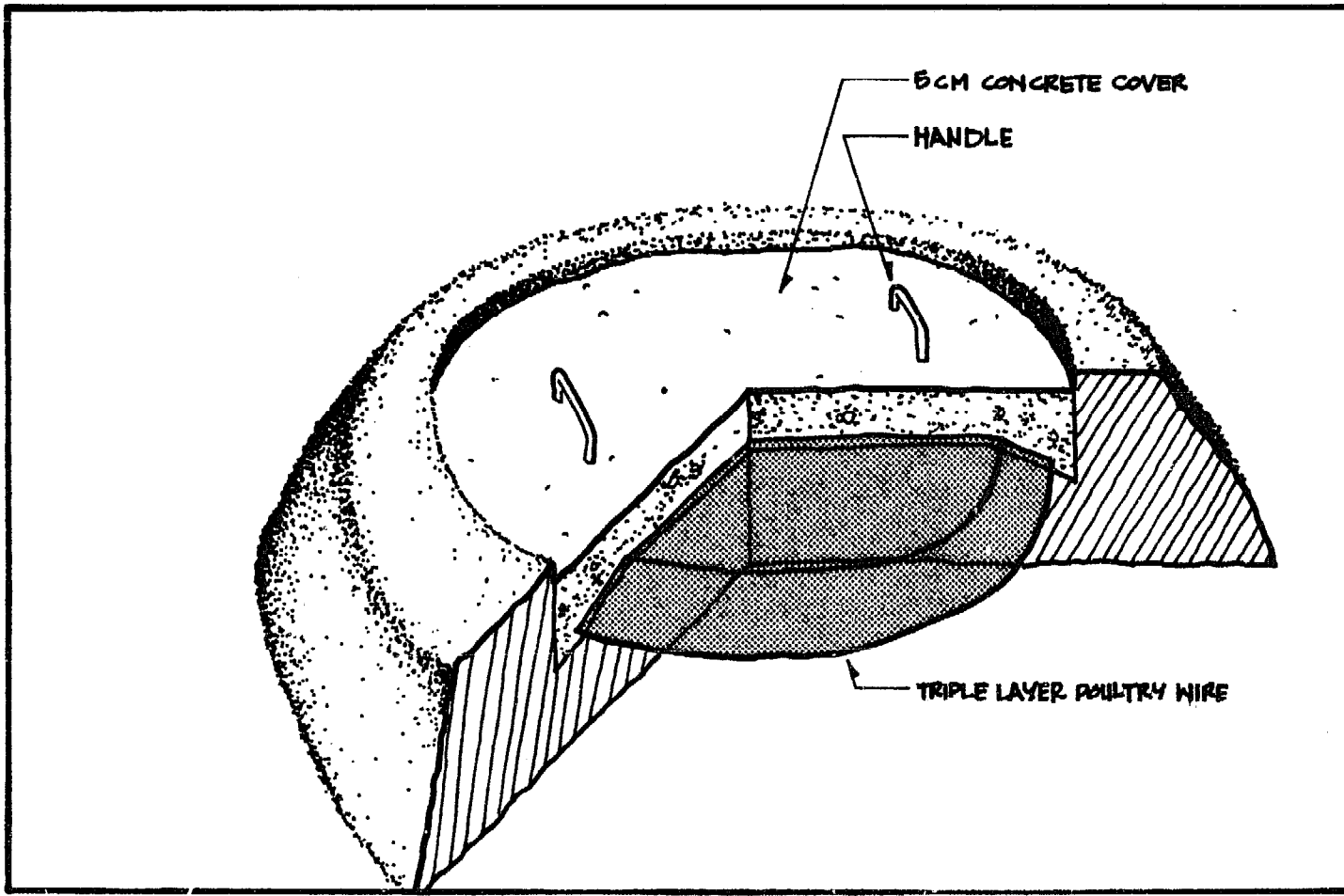

Fig. 37 Section through concrete cover.



72 Fig. 38 Earthen mold. Alternate cover method. Cutaway view.

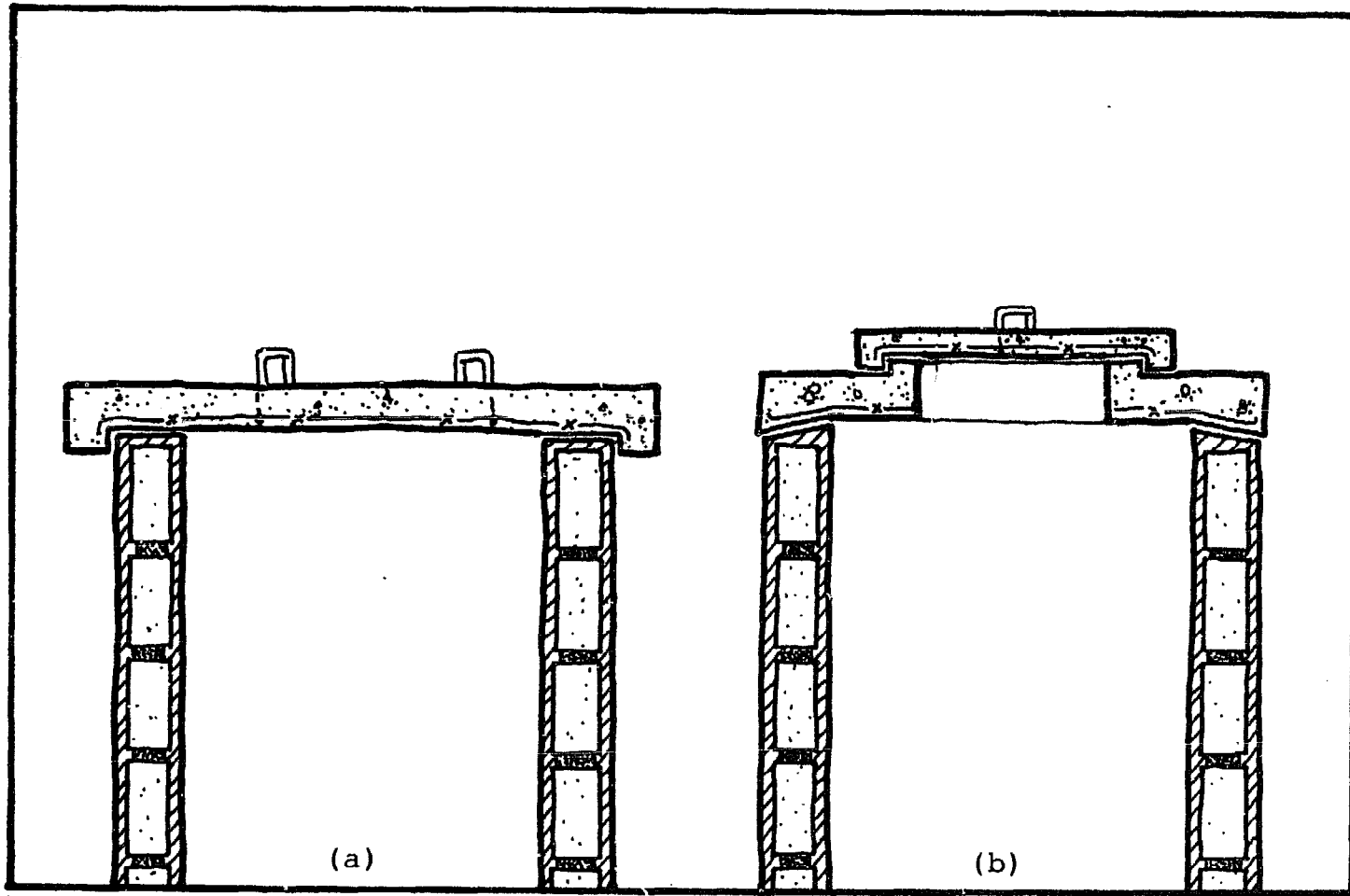

Fig. 39 Alternate cover designs. (a) Overlap. (b) Hatch.

As stated earlier, the cover is intended to be removable. In the event of pump failure, the cover can be removed so the users can fetch water while the pump is being repaired. If the cover is removed, a lightweight, temporary cover should be placed over the well opening to prevent debris from falling in. Water from an open well should be boiled for 10 minutes or chemically treated before drinking. Once the the permanent cover is replaced, the water must be chlorinated to disinfect the well. Chlorination is explained in detail on pages 88-90.

***NOTE:** To improve the appearance of the well, apply a finishing coat of 1 part cement: 2 parts sand on the cylinder, cover, apron and pump stand at the end of construction.

APRON

Two functions of a concrete apron are to direct excess water away from the cylinder thus avoiding contamination of the water source and to provide a stable ground surface. The possibilities for the shape of the apron are endless ranging from purely functional to surreal. (see Fig.40)

To begin making the apron, clear the area of all construction debris and level the soil where the slab will be poured. Dig a trench 15cm wide (6 in.) and 10-15cm deep (4-6 in.) where the edge of the slab will be. This is to insure a strong slab perimeter. Use scrap wood and/or sheet metal to form the outline shape of the floor slab. If the shape of the slab is curved, sheet metal works best. Spread 5cm (2 in.) of gravel on the cleared area and compact it. Refer to the "Tools" section on page 104 for specifications of a locally made compacting tool.

Wrap the base of the cylinder with one layer of paper. (See Fig. 41) This separation will allow the cylinder and apron to move independently and alleviate cracking in the event the cylinder settles.

Use a mix of 1 part cement: 6 parts sand: 3 parts aggregate for a durable apron.

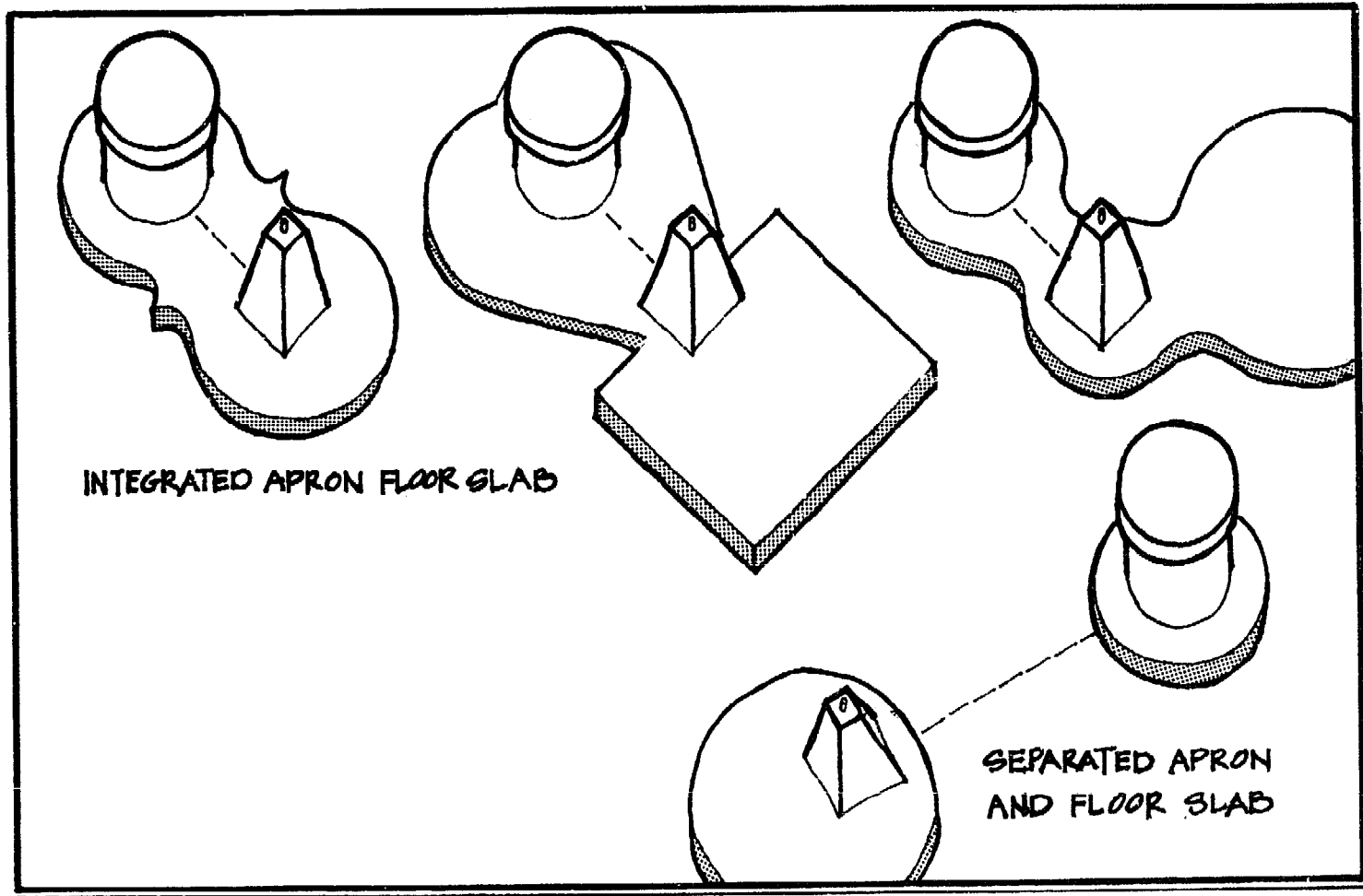

76 Fig. 40 Alternative apron/floor slab designs.

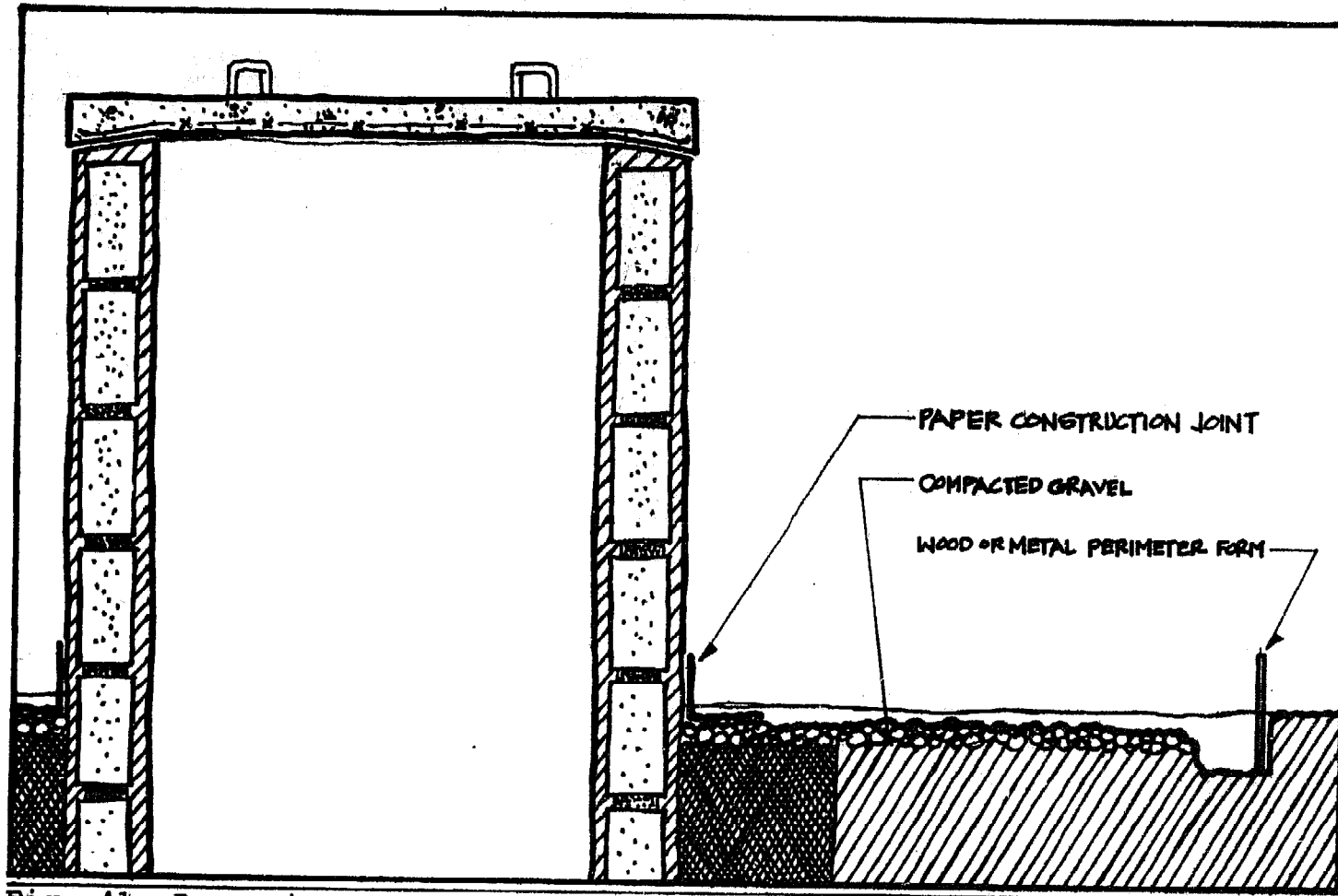

Fig. 41 Preparing to pour the apron.

Before pouring the apron, be sure that at least 1m (3 ft.) of water is in the well at the end of dry season. If there is less than 1m of water, remove soil from the bottom of the well and under the cutting ring so the cylinder sinks. Remove soil until 1m of water stands in the well. (See Fig. 42) Be sure to chisel an oblong hole in the cylinder wall to accommodate the horizontal pipe as the cylinder sinks. (See Fig. 43) Once the pipe and cylinder are in place, seal the hole around the pipe with mortar.

Now pour the slab. Tear the paper off at floor level after the slab has hardened.

Shape the slab so it gradually slopes towards the perimeter (5mm per 30cm ; 1/4 in. per foot). The slope assures the water is channeled away from the cylinder. (See Fig. 44) Rough the surface of the slab with a broom so the slab is not slippery when wet. Add any designs with cement dye last.

If the pump is located a considerable distance from the well cylinder, then pour a small apron around the cylinder and a separate floor slab around the pump stand. (see Fig. 40)

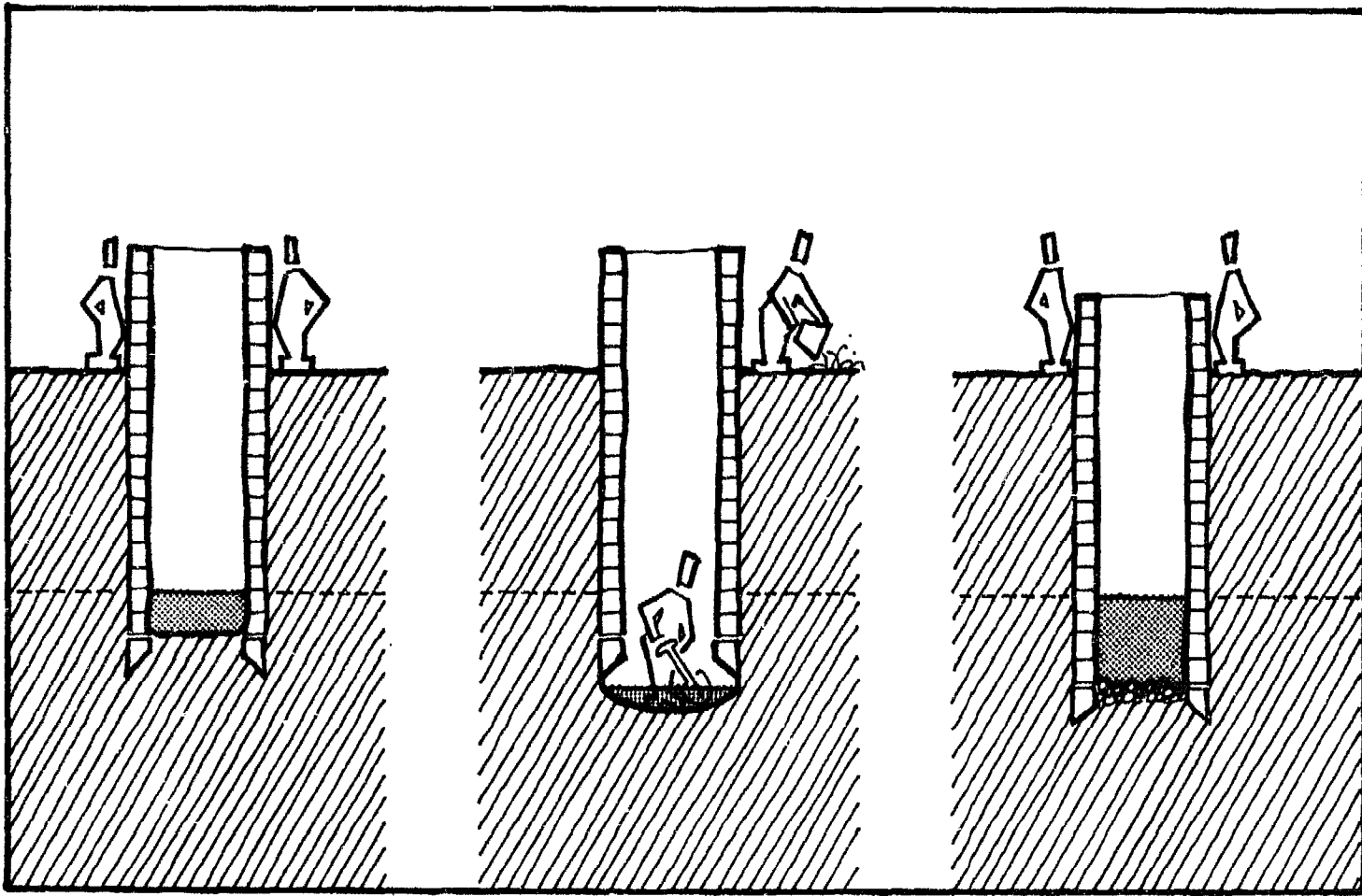
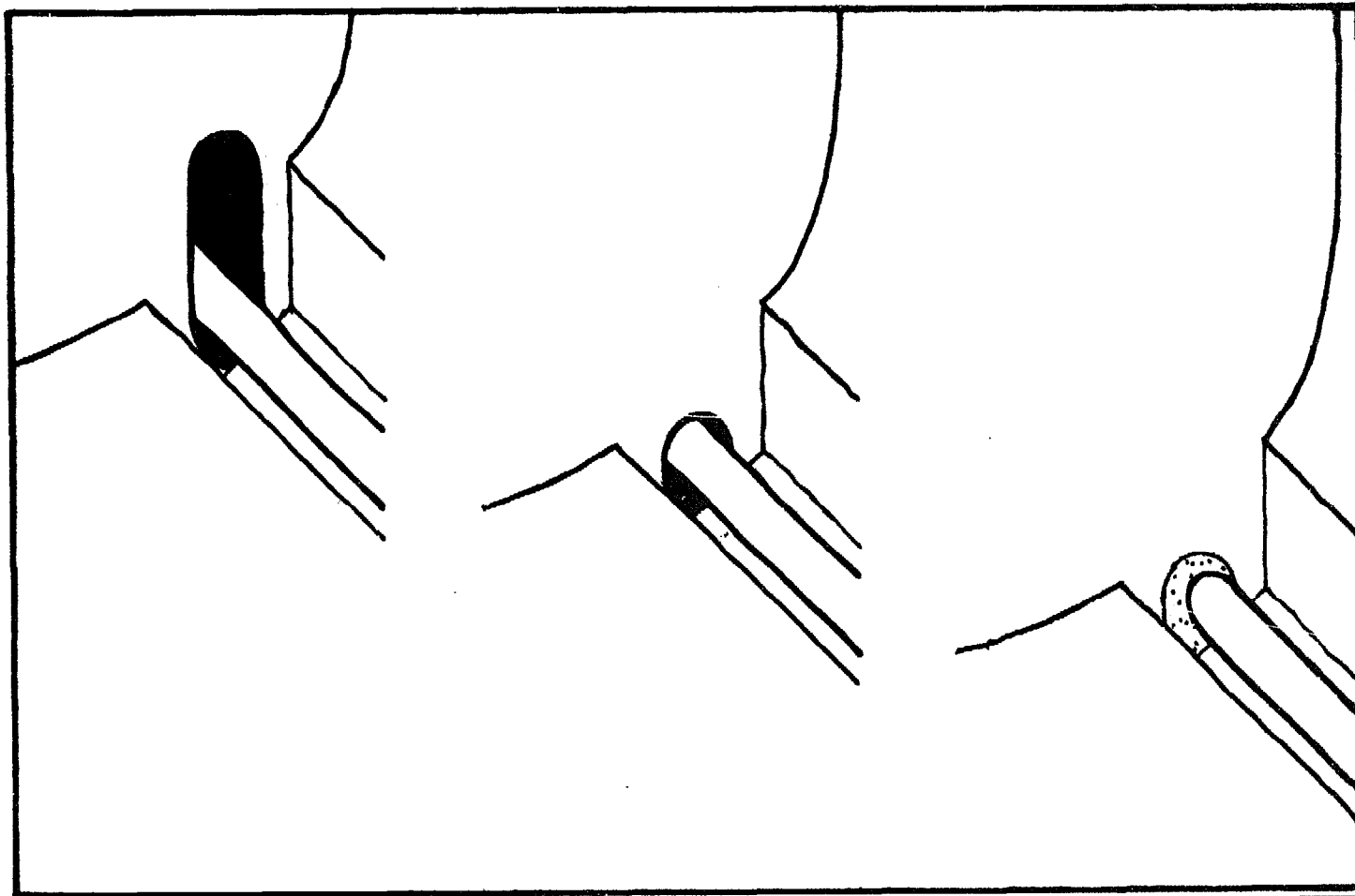

Fig. 42 To deepen water in well, remove soil from under cutting ring. 79



80 Fig. 43 Pipe hole adjustment during excavation allows cylinder to sink.

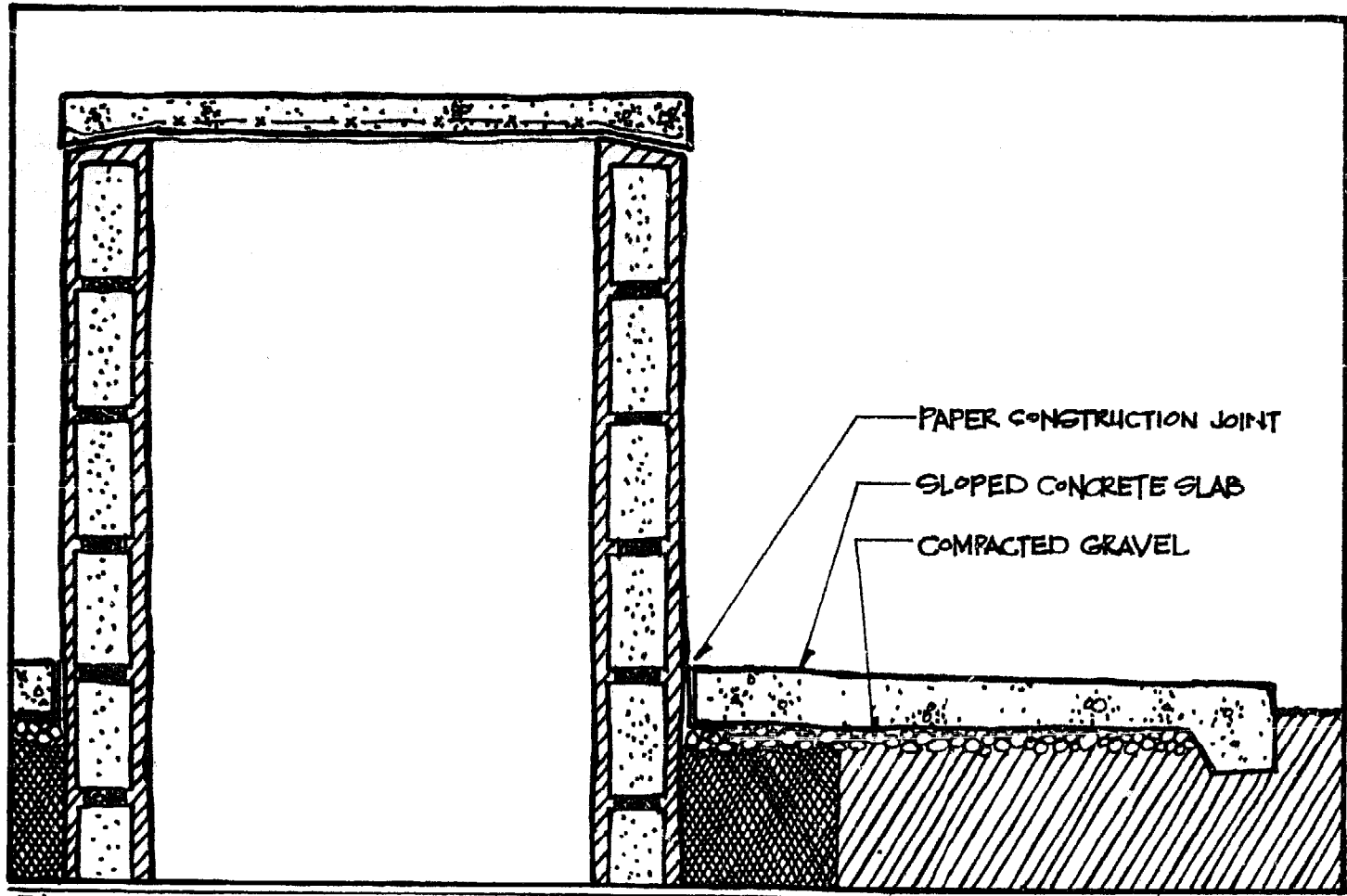

Fig. 44 Poured concrete apron/ floor slab.

These wells have been built in tropical climates where the temperature remains relatively constant; therefore, the expansion and contraction of the concrete is minimal. If wells of this type are being built in an area where temperatures drop to freezing, contact a structural expert for construction recommendations.

HARDWARE

The hardware needed to equip a shallow well with a pump is not complicated. While canvassing stores for the most competitive prices, ask for advice on the hardware. See pages 104-110 for a list of all hardware and materials. Page 111 details a cost breakdown for one well in 1989.

Now that the concrete work is complete, remove all debris from the bottom of the well and spread 8cm (3 in.) of washed gravel on the bottom. The gravel will filter the water before it enters the pipe. Do not seal the bottom of the well with concrete. Water must be able to enter the well through the bottom.

To begin assembling the piping, cut the 1 1/4-in. PVC pipe to extend from the steel elbow inside the cylinder through the two pipe braces to at least 30cm (12 in.) from the gravel filter at the bottom of the well. Rough the end exterior surfaces of the PVC pipe as well as the interior surface of the two 1 1/4-in. PVC male adaptors with sandpaper. Apply PVC Non-Toxic Cement to the exterior ends of the pipe and to the interior side of the non-threaded end of each adaptor. Attach an adaptor to both ends of the pipe and rotate each 180 degrees (one-half circle).

After the cement is dry, apply sealant tape to the threaded portion of one of the adaptors and attach the foot valve. Lower the pipe into the well and through the pipe braces. Wrap sealant tape on the threading of the other adaptor and attach it to the steel elbow inside the well. Do all final tightening with a pipe wrench. Later, in order to repair the PVC pipe, adaptors, or foot valve, unscrew the PVC adaptor from the steel elbow inside the well and remove the PVC pipe. (See Fig. 45a & b for well hardware diagrams)

Wedge pieces of wood between the pipe and the pipe brace to keep the pipe from vibrating when water is being pumped. (See Fig. 46)

Pay careful attention to preventing small particles from entering the foot valve. Tiny bits of debris such as sand hasten the deterioration of the internal pump mechanisms. See Figure 47 for examples of local adaptations designed to protect the foot valve.

The next step is to install the pump. First disengage and lubricate all external joints to provide a proper seal. Grease all exterior moving parts of the pump to reduce friction. Now wrap the threads of the partially exposed vertical steel pipe with sealant tape. Attach the pump to the pipe and tighten with a pipe wrench. Before pumping water make sure nothing has fallen into the well which might clog the pipe.

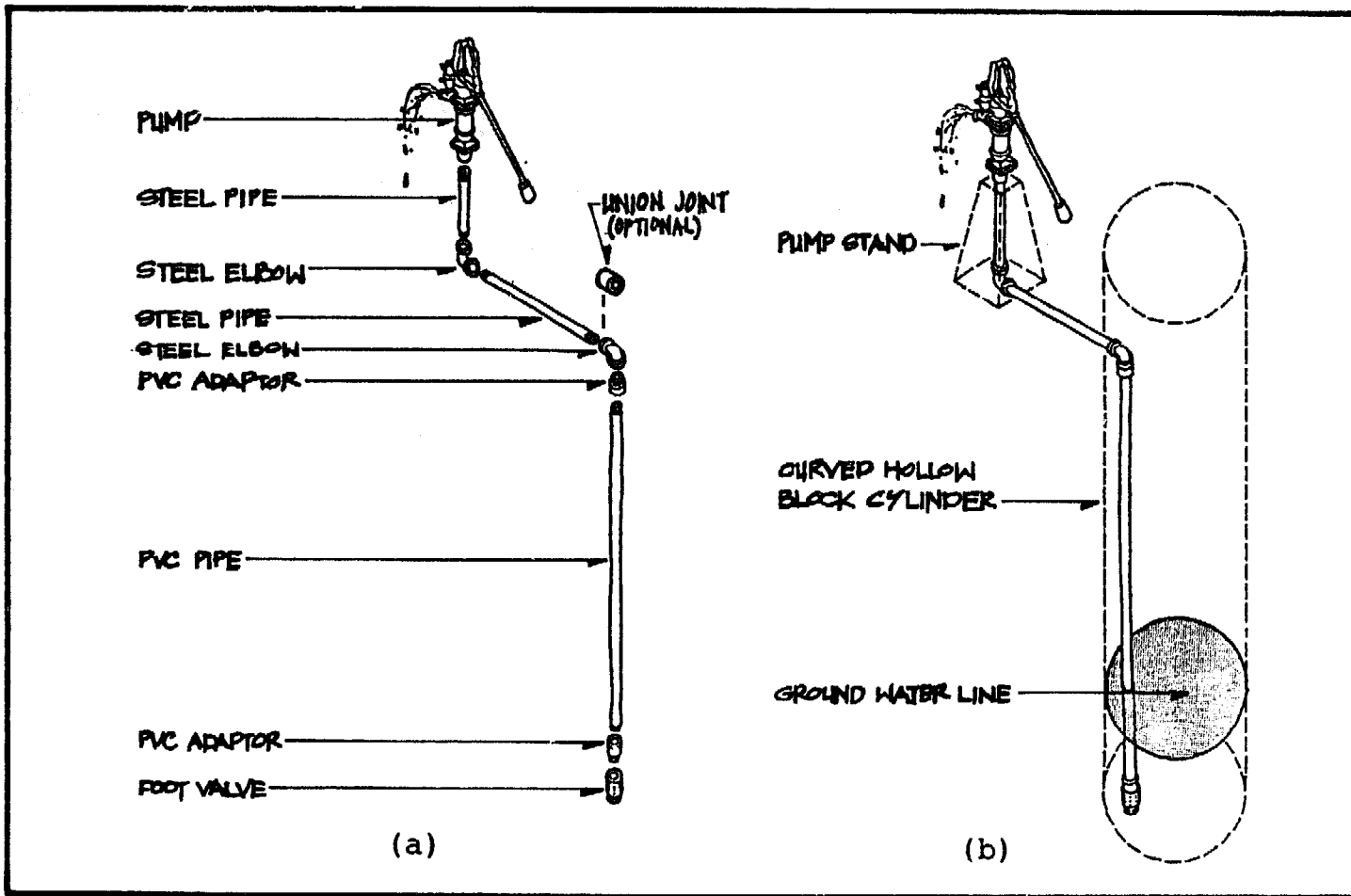
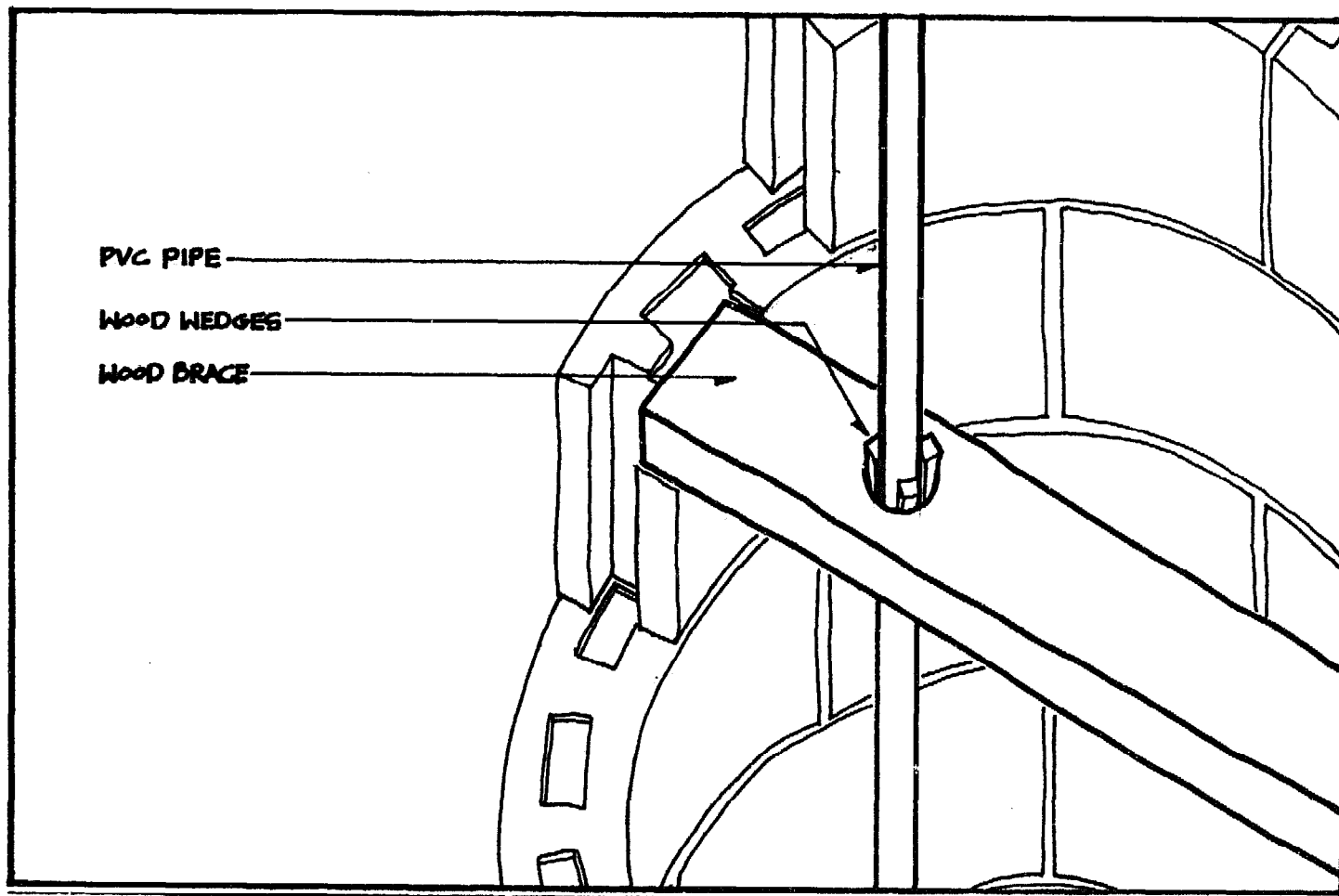

Fig. 45 (a) Well hardware placement; (b) Hardware in relation to well and pump stand.



86 Fig. 46 Placement of vertical PVC pipe through wooden brace and held in place with wooden wedges.

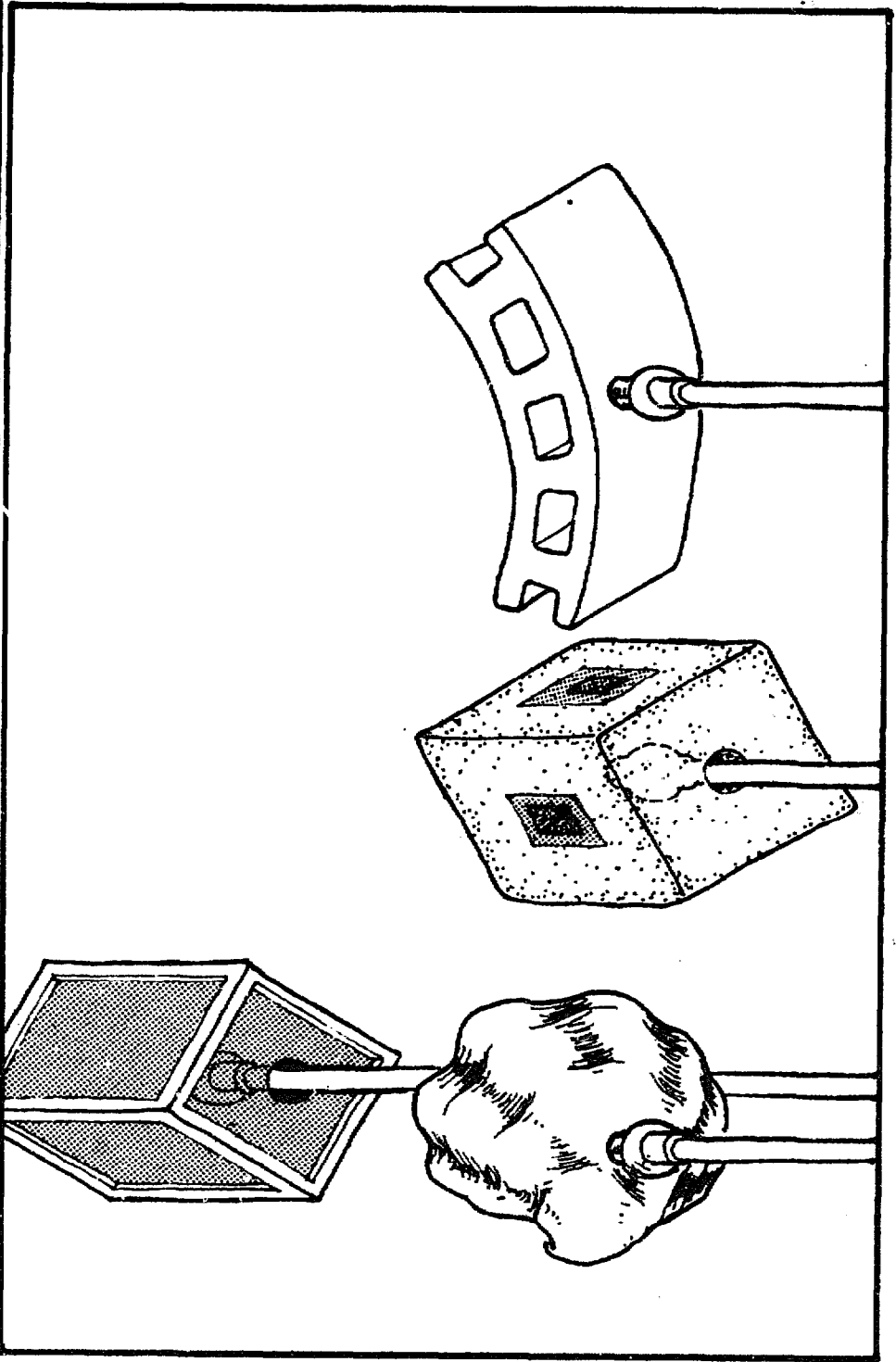

Fig. 47 Various ways to protect foot valve from debris: extra hollow block, concrete box, sea shell, screened box.

APPENDIX

SANITIZING THE WELL

The sanitary condition of the drinking water is the most important issue to consider when building a well. Five final steps to assure proper sanitation are: chlorination of the water, construction of a fence, adequate drainage, posted guidelines, and pump maintenance.

Chlorine can be obtained in tablet, powder, or ordinary liquid bleach from private dispensors or public health agencies. After construction and every four months afterward **super chlorinate** the well. To super chlorinate the well add **100 mg of high concentrate chlorine per liter of water**. (See page 89 for the chlorine dosage of a well with a seven-block circumference)

Dilute the chlorine in a 5-gallon plastic bucket of water before mixing it in with the well water. Plastic (or glass) containers are required because metal corrodes when exposed to high concentrations of chlorine. Scrub the side of the well using the chlorinated water and broom. Take care that no one touches or drinks this water. Leave the high-concentrate chlorine in the well for 24 hours. Then pump out the water until the water in the well no longer smells like chlorine. Super chlorination is intended to clean the water, well sides and pump fixtures.

SUPERCHLORINATION TABLE
7-block circumference
100mg/l or 100 ppm

Water depth	Volumn m³	Cal. Hypochlorite 70% (HTH) # tablets needed	Liquid Bleach 5% liters needed	Bleaching Powder 30% gr. needed
1m	.55	3.9	1.1	185
1.25m	.69	4.9	1.4	230
1.5m	.83	5.9	1.7	277
1.75m	.97	6.9	1.9	323
2m	1.11	7.9	2.2	370
2.25m	1.25	8.9	2.5	417
2.5m	1.38	9.9	2.8	460
2.75m	1.52	10.9	3	506
3m	1.66	11.9	3.3	553

Volumn= radius² x 3.14 x water depth
Dissolve chlorine in 5 gal. of water before adding to well.
1 lb.= 453.6 grams; 1 tablet= 20 grams

Super chlorinate the well every four months and after the first heavy rainfall of the year, if the cover was removed, and if the area around the well has flooded to be sure run-off does not contaminate the well. Take care not to expose plants or animals to super-chlorinated water when pumping it out of the well.

A strong **fence** surrounding both the pump and cylinder is another characteristic of a sanitary well. Construct the fence of locally available materials and sturdy enough to prevent roaming livestock from entering the well area. Since animals cannot enter, the users of the well are free to plant flowers and vegetables inside the fence to take advantage of the run-off water. Do not plant large trees near the well because the roots of the tree will eventually penetrate the cylinder and crack the wall.

Malaria and other diseases spread by mosquitoes remain endemic in many areas of the world. Stagnant water around a well site provides prime breeding ground for mosquitoes and should be avoided. Good **drainage** allows excess water to be quickly transferred below groundlevel where it will eventually filter down to the existing water table.

There are two common ways to provide drainage for the run-off water. One option is to dig a trench around the entire floor slab at least 30cm wide x 30cm deep (1ft. x 1 ft.) and fill it with gravel. If the run-off water has been more precisely controlled, then a drainage pit is more appropriate. This is done by digging a pit approximately 1 cubic meter where the water is concentrated and filling it with gravel. (see Fig. 48 for samples)

Post the **guidelines** for the use of the well as previously agreed upon by the users of the well. The guidelines should be written in the dialect most commonly spoken among the well users. (see Fig. 49)

To insure that the water reaches the well users, a strict **pump maintenance** program should be implemented. The maintenance guidelines listed on pages 94 and 95 are intended to be implemented by an appointed well manager. Figure 50 depicts the parts of a typical shallow well pump for easy identification and the ordering of spare parts. Common hand pump problems and repairs are listed on pages 98 and 99.

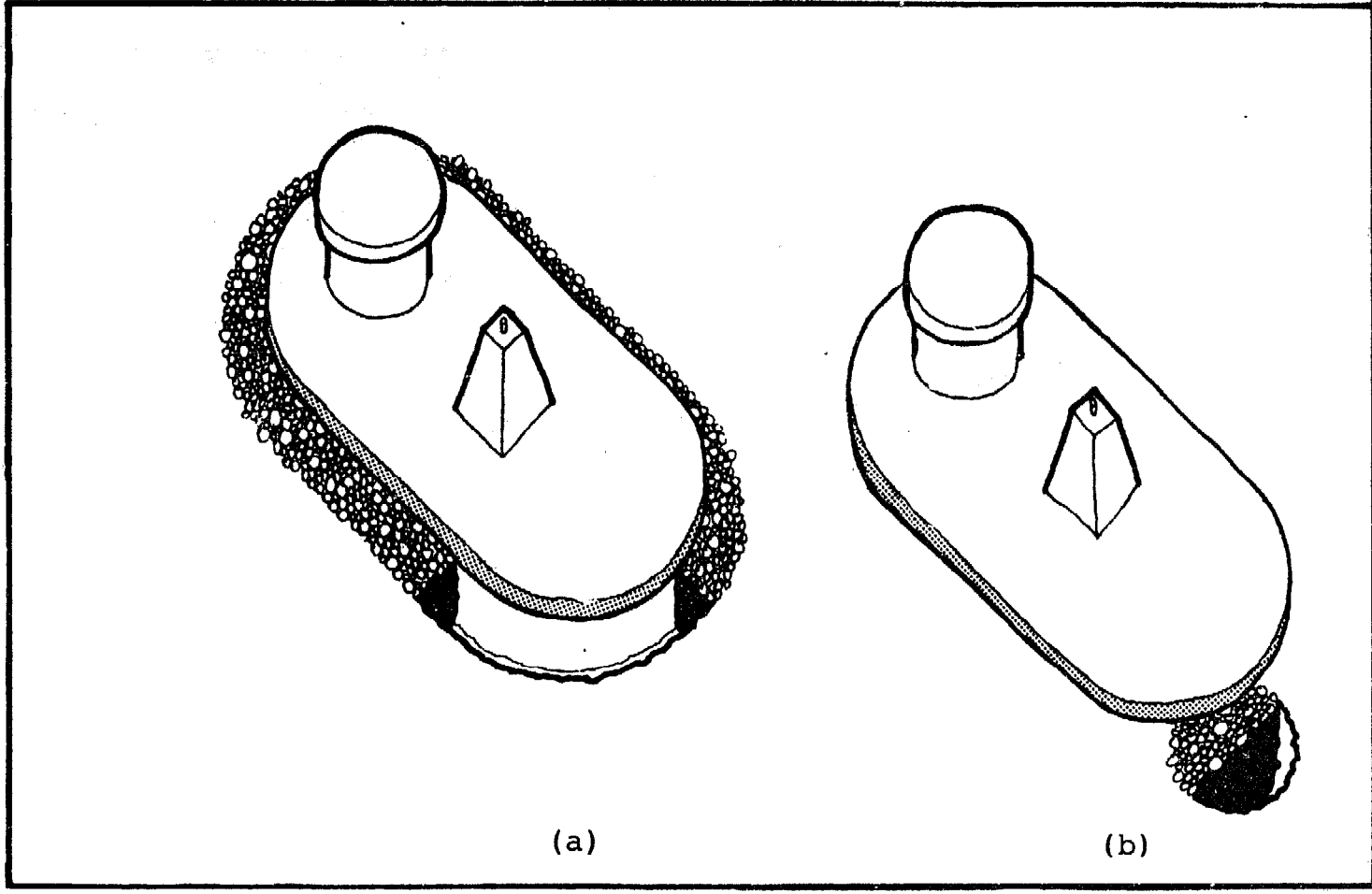

92 Fig. 48 Proper drainage from floor slab. (a) Sloped slab with gravel surrounding slab. (b) Slab with curb and outlet.

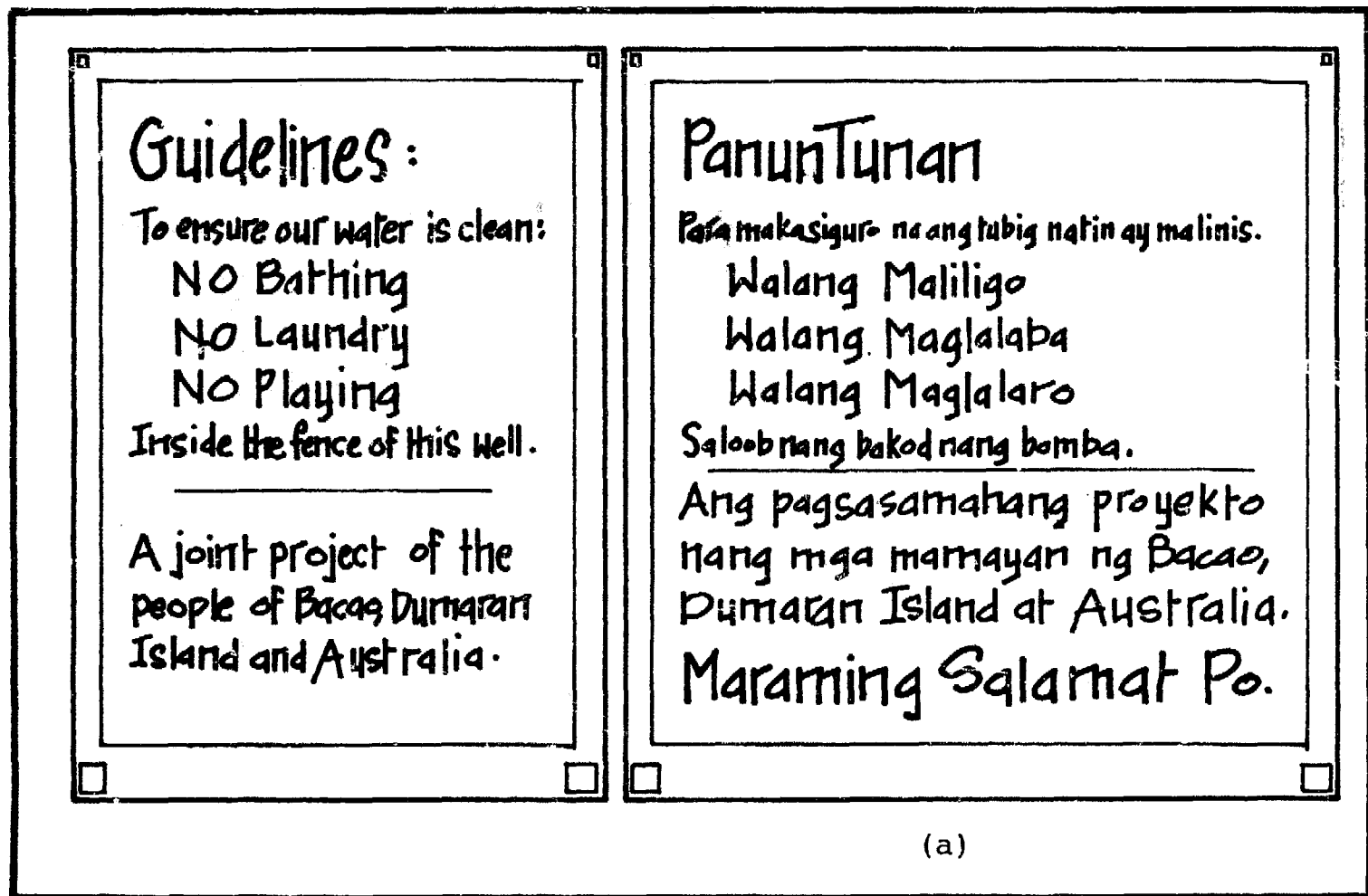

Fig. 49 Sample of posted guidelines. (a) In local dialect.

PUMP MAINTENANCE

The following are recommended guidelines for simple hand pump maintenance:

DAILY

- * Lock and unlock pump at hours agreed on by village.

- * Clean pump spout.

WEEKLY

- * Thoroughly clean pump, spout, surroundings.

- * Oil or grease all pins, bearings, sliding parts and shaft. Check for rust.

- * Repair irregularities such as tight parts, leaks, particles in water.

MONTHLY

- * In case of leaks, replace packing around pump shaft on top of the pump unit or tighten gland. Leave nut loose enough to allow a slow drip of water to lubricate the packing.

- * Check that all nuts, bolts and pins and shaft connections are tight.

MONTHLY cont.'d

* Check for signs of wear on rubber fittings and rubber cup. If pump fails to raise water when pumped slowly, 10 strokes per minute, replace cup.

* Super chlorinate every four months.

* Carry out weekly maintenance tasks.

ANNUALLY

* Paint all exposed parts to prevent development of rust.

* Repair any cracked concrete.

* Check wear on handle bearings and replace parts as necessary.

* Check foot valve; replace if leaking.

* Replace packing around pump shaft.

* Overall pump and well inspection and repair.

McJunkin, F.E. "Hand pumps." Technical Paper No. 10, International Reference Center, The Hague, 126 p. 1982.

"JETMATIC" SHALLOW WELL PUMP PARTS
Fig. 50

- | | | |
|------------------------------|--|----------------------------|
| 1. Hose joint | 12. Valve cover | 23. Priming cap
packing |
| 2. Cap | 13. Valve weight
(valve) | 24. Handle |
| 3. 3-way spout
upper body | 14. Valve | 25. Lever |
| 4. Check valve | 15. Lower plunger | 26. Double rod |
| 5. 3-way spout
body | 16. Cylinder
porcelain
enameled inside | 27. Shaft |
| 6. Change lever | 17. Rubber packing | 28. Head |
| 7. Change valve | 18. Valve weight
(pump) | 29. Pin |
| 8. Spout | 19. Chamber | 30. Gland |
| 9. Hook | 20. Rubber cup | 31. Packing |
| 10 Nut and bolt | 21. Upper plunger | 32. Collar washer |
| 11 3-way spout
packing | 22. Priming cap | 33. Gland bushing |

"Hand Pump Design." Technical Drawing No. 19, University of San Carlos, Water Resources Center, Cebu City, Philippines.

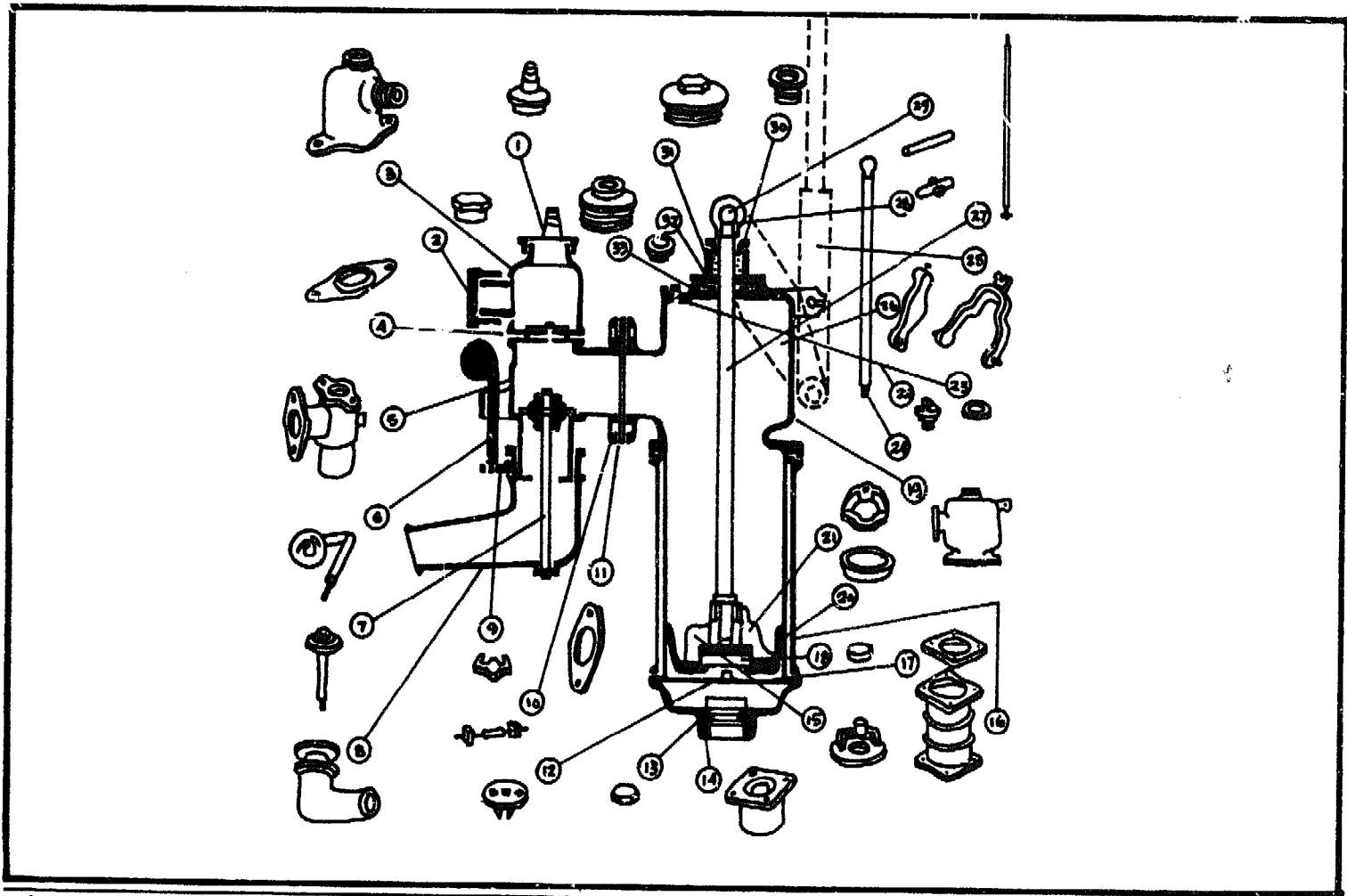

Fig. 50 "Jetmatic" shallow well pump parts.

COMMON HAND PUMP PROBLEMS AND REPAIRS

Numbers refer to Fig. 50

<u>TROUBLE</u>	<u>LIKELY CAUSE</u>	<u>REMEDY</u>
1. Pump delivers little or no water.	A. Worn-out rubber cup (#20); rubber packing (#17); priming cap packing (#23); or plungers (#15, 21).	Replace worn-out part.
	B. Loosened priming cap (#22).	Tighten priming cap.
	C. Leaks in pump cylinder (#16).	Tighten cylinder screws.
	D. PVC pipe or foot valve clogged with debris.	Clean out pipe and foot valve.

PUMP PROBLEMS AND REPAIRS cont'd.

<u>TROUBLE</u>	<u>LIKELY CAUSE</u>	<u>REMEDY</u>
	E. Defective valve cover (#12).	Replace valve cover.
	F. Groundwater level drops.	Deepen well or reduce number people using the well.
2. Pump is noisy.	A. Bearings or other working parts of pump are loose.	Tighten or renew parts. Grease moving parts.
	B. Pump is loose on mounting.	Tighten mounting.

(after McJunkin, 1982)

INGREDIENTS IN CONCRETE MIX

WATER Use clean, non-brackish water for all concrete mixes. Add a liberal supply of water to all mixes with the exception of hollow block. Add enough water to the hollow block mixture to make it moist and easy to work with but still dry enough that it can be formed into a ball in the palm of the hand. The hollow block mixture must be dry enough that it holds its shape after coming out of the form.

CEMENT The shallow wells discussed here are made with ordinary cement such as Portland Cement. Waterproofing cement known as Sahara Cement is needed if adapting the well technology to make underground water storage tanks. Purchase cement near the time of construction because it loses strength quickly. Find a secure, dry area near the construction site to store the cement.

SAND Use a fine, powder-like, non-brackish sand whenever possible to be sure of a strong bond with the cement and gravel. Screen the sand through a 3mm (1/8-in.) screen when using it for making mortar. Dirty or salty sand must be washed before use.

AGGREGATE Use small, smooth gravel whenever possible. Concrete made with smooth-surfaced gravel disengages from the hollow block form more easily than that made with rough gravel. Gravel used in making concrete for curved hollow blocks must be screened through a 5mm (1/4-in.) screen to avoid clogging the form. Substitute aggregates such as old broken corals have been used to make concrete, but be sure to wash it if it is salty. Remember that porous aggregate will require more water for the mix than non-porous aggregate.

The ratios shown on Page 102 are the minimum amounts of cement needed. Add a bag or two to this amount when building the first well to allow for experimentation and mistakes.

The composition of local materials varies drastically from one site to another, and even from one well to another at the same site. Therefore, experiment with different mixes prior to construction. (See Fig. 51 for a sample mix for concrete hollow block.) The amount of water needed in a concrete mix varies according to the material composition. The following is an example of that variation between two work groups in the same location: One group used smooth, dense, river gravel as aggregate while the other used rough, porous coral. The group using coral was forced to add additional water because the porous coral absorbed extra water and more sand to allow the rough edges of the coral to slide more easily from the form.

CEMENT RATIOS

<u>Item</u>		<u>Unit of Volume</u>		
		Water	Cement	Sand
Hollow Block	Dry	1	4	2
Cutting Ring	Wet	1	2	2
Mortar	Wet	1	4	0
Cover	Wet	1	2	2
Pump Stand	Wet	1	4	2
Apron	Wet	1	6	3
Finishing	Wet	1	2	0

*Note: These ratios call for the minimum amount of cement allowable. Additional cement may be added for extra strength.

CEMENT RATIOS

<u>Item</u>	<u>Unit of Volume</u>			
	Water	Cement	Sand	Aggregate
Hollow Block	Dry	1	4	2
Cutting Ring	Wet	1	2	2
Mortar	Wet	1	4	0
Cover	Wet	1	2	2
Pump Stand	Wet	1	4	2
Apron	Wet	1	6	3
Finishing	Wet	1	2	0

*Note: These ratios call for the minimum amount of cement allowable. Additional cement may be added for extra strength.

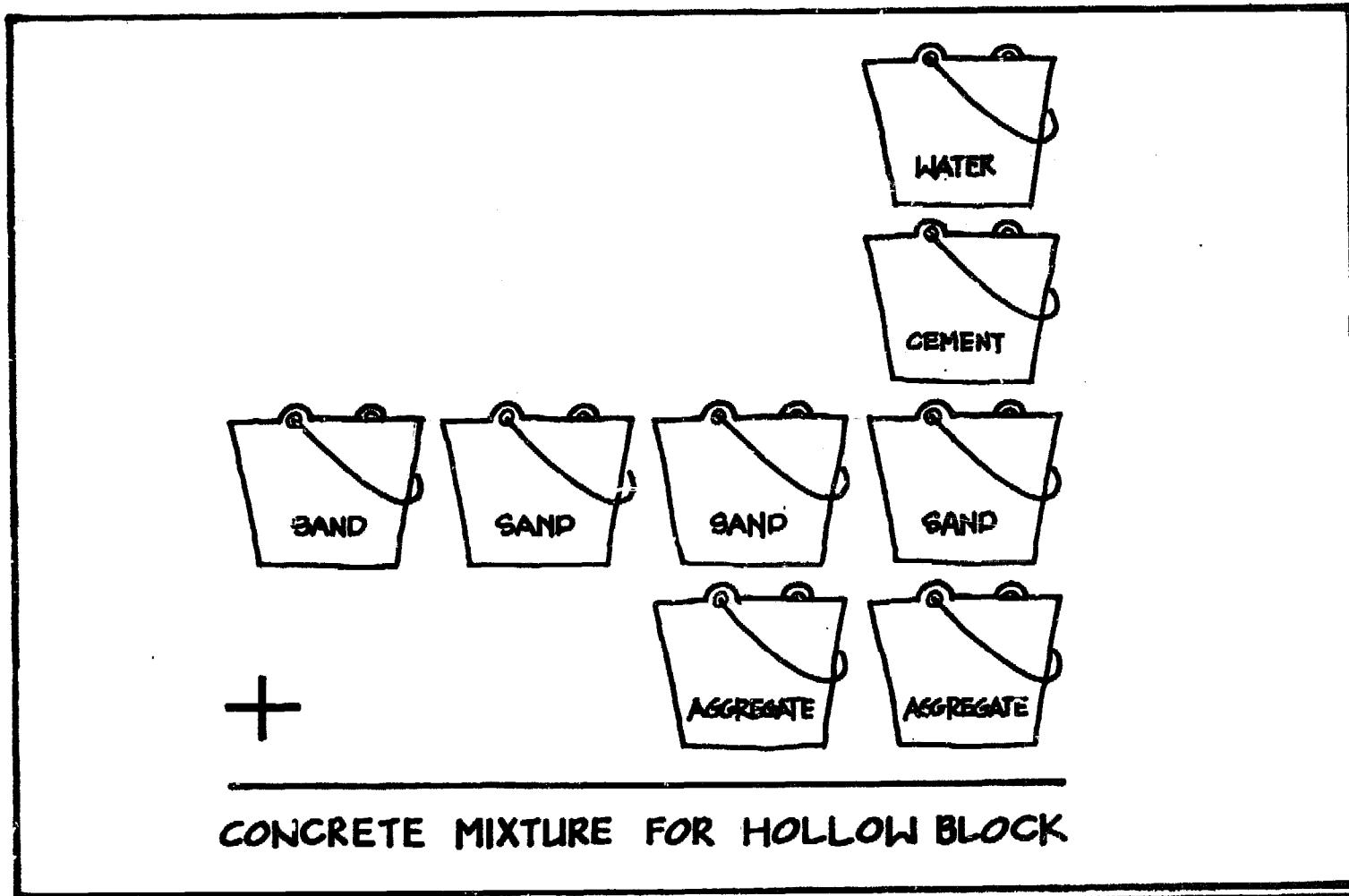

Fig. 51 Sample concrete mix. Water content can vary depending on water content in sand.











MATERIALS FOR HOLLOW BLOCK FORM

<u>Material</u>	<u>NO.</u>	<u>Specifications</u>
Hardwood	1	1" x 10" x 40"
Galvanized steel	1	20" x 20", Gauge 14.
Nails	1 kilo	1 1/2"
Nails	1/2 kilo	1/2"

TOOLS FOR WELL CONSTRUCTION

<u>Tool</u>	<u>NO.</u>	<u>Specification/Comment</u>
Adjustable wrench	2	12-in. Use to tighten and seal joints and exterior moving parts of the pump after the initial lubrication.
Hacksaw blade	2	High-standard. Use to trim excess threading on the steel pipes and cut PVC to correct lengths.
Pipe wrench	2	20-in. Use to assemble piping system and tighten pump unit to the vertical steel pipe.



	Screen	1m ²	6mm (1/4-in.), galvanized. Use to separate oversized, unwanted aggregate.
	Screen	1m ²	3mm (1/8-in.), galvanized. Use to screen sand for mortar and finish coats.
	Shovel	2	Rounded-edge. Used for digging and mixing concrete.
	Square trowel	1	Metal plate used to smooth all concrete surfaces.
	Diamond trowel	1	Use to apply mortar between hollow block and finishing.
	Wheel barrow	1	Transport materials.
	Cutting ring pattern	1	Plywood or 1" x 6" lumber. Use to form cutting ring. See Fig. 18.
	Compacting tool	1	Hardwood or medium-sized log with handles used to pound gravel into hard surface before pouring concrete slab.
	Wood chisel	1	3/4-in. Use to notch form and cylinder.
	Hammer	1	Standard. Use to build form.

MATERIALS FOR ONE WELL

7m deep; seven-block circumference

<u>Material</u>	<u>Amt.</u>	<u>Specification/Comment</u>
Cement	9-12 bags	Ordinary. Buy amount needed immediately. Use for blocks, cutting ring, cover, pump stand, floor slab, mortar, finishing.
Foot valve	1	1 1/4-in., typically brass, also known as "check valve." Holds water in pipe when the pump is not in use thus omitting the need to prime. Keeps debris from entering pipe system. Leave handle in up position when pump not in use so pipe is full of water and requires less pumping.
Pipe brace	2	Wood. 1" x 4" x (diameter + 2"), 1 1/4" hole for pipe to pass through. To control pipe vibration during pumping. (See Fig. 27)

G.I.
steel
pipe

2

1 1/4-in., galvanized steel pipe, Schedule 40. Do not use Sch. 20 as it is not guaranteed to last the life of the well. Need two (2) pipes per well. 1) One horizontal between the cylinder and pump stand. Decide horizontal distance before purchasing pipe. Minimum horizontal distance is 1m 33cm (52in.). Horizontal distance can be greater if budget permits. 2) Second piece of pipe is a 60cm (24 in.) vertical pipe which passes through the pump stand and into the base of the pump unit. Have pipe cut to right lengths and threaded on both ends before transporting to rural area. Do not substitute plastic pipe for steel pipe. Well design requires steel pipe for strength and stability.

G.I.
steel
elbow

2

90 degree angle, 1 1/4-in., Schedule 40. One to join vertical and horizontal steel pipes. Another to join horizontal steel pipe to the male adaptor on the vertical PVC pipe inside the cylinder.

Grease	1	Any common lubricant for all pump joints and exterior moving parts.
Suction pump	1	Needs 1 1/4-in. pipe connection. Many varieties available. Needs to pull water from well depth. The very inexpensive "pitcher pump" will not work in the system described here. A pitcher pump must be directly above the water source. The pump in this system is off to the side of the water source so the cover can be removed to clean and repair the well. Extra money spent on top-of-the-line suction pump is well spent. Keep pump well lubricated.
Rubber cup	2	Mechanism inside pump which creates suction and draws up water. Keep a stock of high-quality transparent cups because they wear out quickly. Standard-issue black are not as durable as the transparent.
Paint	var.	Bold colors easy to read from a distance. Use on signboard.
Plywood	var.	1/8-in. marine plywood. Use as signboard for well guidelines.

Poultry
wire

1m x 2 1/2m with 25mm holes (3 ft. x 9 ft. with 1-in. holes). Accordion fold wire into triple layer mesh and place in bottom of cover. Be certain legs of handles pass through the mesh holes and rest below the mesh. Poultry wire can also be used to reinforce concrete curbs or join pump stand to floor slab.

PVC
cement

- 1 Also known as Eslon Cement. Acts same as epoxy, but unlike epoxy, PVC Cement is non-toxic and safe to use in the plumbing for drinking water. Used to join PVC piping to PVC male adaptors. Roughen all surfaces that will be joined with PVC Cement. Apply PVC Cement and rotate pieces 180 degrees (one-half circle).

PVC
male
adaptor

- 2 1 1/4-in. Eslon Blue, Moldex Blue, Neltex Blue, or other comparable non-toxic PVC. Only blue PVC is non-toxic and safe for drinking water wells. Cement adaptor to each end of PVC pipe after it is cut to size. One adaptor foot valve to pipe; the other joins the pipe to the steel elbow inside the cylinder.

PVC pipe	var.	1 1/4-in. Eslon Blue, Moldex Blue, Neltex Blue, or other comparable non-toxic PVC. Carries water from foot valve to horizontal steel pipe. Cut to size so pipe extends at least 12 inches from the bottom of the well.
Teflon (sealant) tape	2 rolls	Used to ensure tight seal between hardware. Wrap on threaded ends of steel pipe and male adaptors before attachment.
Rags	var.	For cleaning PVC pipe after cutting. (see pages 6 and 7 for location of well hardware.)

ITEMIZED COST OF ONE WELL
P20= US\$1.00

<u>Item</u>	<u>Community Donation</u>	<u>Requested Funds</u>	<u>Total</u>
Bamboo fencing	P 105		
Gravel	240		
Sand	350		
Cement		P 765	
Plastic pipe		130	
Steel pipe		110	
Steel elbow-4		210	
Suction pump		882	
Foot valve		320	
Labor (3 men x 1 wk)	P 630		
Chlorination	80		
TOTAL	P1,405/\$70.25	P2,417/\$121	P3,822/ \$191

Bacao Potable Water Project. Barangay Bacao, Dumarán, Palawan, Philippines, 1989. Community contribution of labor and local materials: funds requested from the Australian Embassy to purchase materials: total cost of one well.

GLOSSARY

Accordion style- Folds, back-to-back like a child's paper fan.

Aggregate- Gravel which makes up the bulk of concrete.

Apron- Concrete floor around well that channels run-off water away from the well.

Backfill- To return some of the excavated material back to the hole from which it came.

Brackish- Somewhat salty.

Cement- A powder of lime and clay used to make concrete.

Circumference- The measured length of the outside line of a circle.

Compacted gravel- Gravel pounded into a hard surface.
Usually supports concrete slab.

Concrete- A mixture of sand, aggregate, cement and water used in construction.

- Construction joint-** Space between two sections of concrete which have been separated by a light material. This prevents sections from bonding and is used to control cracking. See Fig. 41.
- Culverts-** Concrete cylinder reinforced with steel bars used for underground drains and waterways.
- Cured-** Hardened concrete.
- Cutaway-** Graphic technique which removes a part of the drawing to reveal detail.
- Cutting ring-** Solid ring of concrete with bevelled underside which supports the hollow block cylinder and keeps the blocks from splitting apart if the cylinder settles.
- Debris-** Fragments of rock or rubble which might fall in a well and contaminate it or clog the pipes.
- Diameter-** Measured line from one side of a circle to another and passing through the center point.
- Dilute-** To thin out or break down by mixing with liquid.
- Disturbed soil backfill-** Soil removed from well hole and later returned.

"Dry" cement- Cement with just enough water to form a ball in the palm of the hand; used for hollow block.

Finishing- Final, smooth coat of cement and sand mixture used to improve the appearance of the well and to seal the well from contaminants.

Foundation ring- Seal cutting ring.

Friction- Rubbing of one surface against another.

Groundwater line (GWL)- Point where potable water is reached when digging a well. Also known as: water table or static water table.

Joints- Vertical or horizontal space between hollow block that is filled with mortar.

Mortar- Mixture of cement, sand and water used in construction.

Perimeter- The outer edge of an area.

Pipe brace- A wooden support beam which spans the diameter of the well to keep the vertical PVC pipe from vibrating while pumping. PVC pipe passes through hole drilled in brace.

- Pump stand-** Concrete stand which stabilizes the pump while water is being drawn.
- PVC pipe-** (Poly Vinyl Chloride) Plastic pipe.
- Radius-** Measured line from the exterior of a circle to the center point.
- Reinforcing bars-** (Rebar) Steel bars used for structural support in construction.
- Reinforcing rings-** Circular-shaped pieces of rebar or sliced bamboo used to give strength to the cutting ring.
- Sheet metal-** Galvanized, flat metal often used on roof ridges to keep rain from entering.
- Tensile stress-** Forces "pulling" a material apart. Must be compressed from outside to keep material from breaking.
- "Wet" cement-** Cement with enough water content it can be crudely poured from a container.

