



The
WATER
SYSTEM

By Michael Hackleman

(This is the first of a two-part series)

Urban-dwellers rarely concern themselves with a water system. Getting water in a home or an apartment is usually a phone call, some paperwork, and a monthly bill away. In this case, the water is simply turned on by the local water company. Or it's already on, and only the name is changed for billing purposes. Rural dwellers may experience a similar process if the habitat is located in a water district, or a water system has already been developed and is fully operational.

What awaits the proud owner of an undeveloped piece of land? If you've got utility electricity available, the local chamber of commerce will probably point you at the local well drilling company. Thereafter, you need have no more to do with the process of developing a water system than writing checks for the hardware

and labor. If the raw land lies too far beyond the utility grid, you will go through the throes of information hunting and a myriad of confusing decisions that may or may not result in a satisfactory water system.

Left out in all of these scenarios is any real thought process that will result in a well designed water system. There are functions, processes, and materials in every system. Today, where utility power is available, there is a distinct prejudice toward the demand system, i.e., one using a submersible pump. Once informed, many people will choose a store system, i.e., one using a piston pump and tank. Which is better and why?

What sets the well-designed water system apart from others? Ease of use? Versatility? Functionalism? Efficient use of water and energy? The hallmark of a well-designed system is simple: it cannot be improved upon. You might find its equal but you can't find its better.

The lifeblood of a water system is the water itself. If it is to sustain you and perform the uses you will put it to, the water source must be carefully selected lest it become a source of concern. Water found in nature is "wild." Transforming it into a form that will satisfactorily do the things we ask of it requires energy. This is the system's heart. The system's energy source must also be selected so that the two, water and energy, merge in a hard-working symbiotic partnership that will demonstrate again and again how wise it was to expend the effort toward this end. Let's look at sources of water, sources of energy, and the components involved in processing water itself.

SOURCES OF WATER

There are many potential sources of water for use in the rural water system (Fig. 1). Among the more promising sources are streams, springs, ponds,

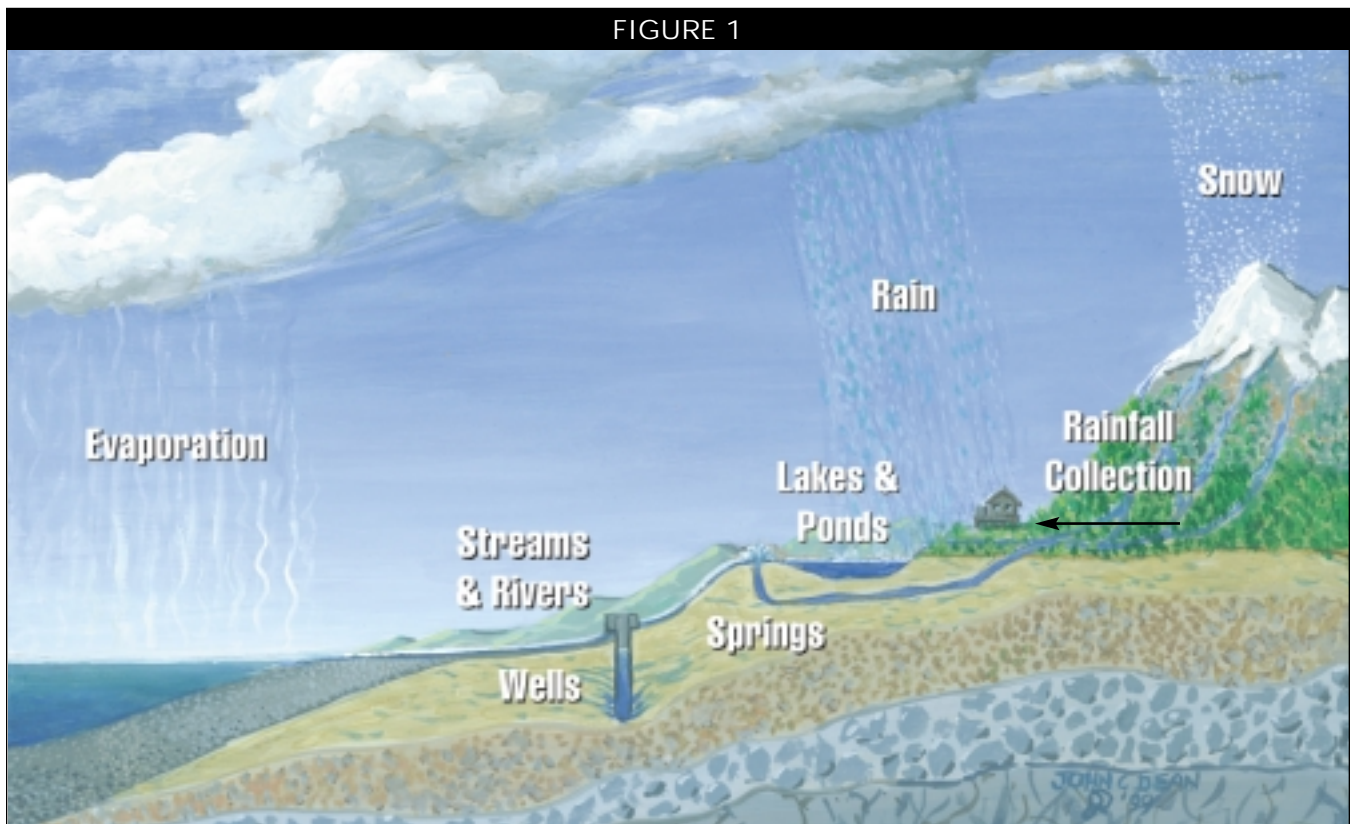

There are many potential sources of water.

FIGURE 2



A shallow well may be dug with a backhoe.

and wells. It is even possible to collect the falling rain.

Access is everything. Right off, some of these potential sources may be eliminated from the list; you either have them or you don't. Some sources can only be listed as "probables," particularly if there's no visual evidence of their presence. The extremes are interesting. It would be just as rare to find a piece of property that boasted all of these sources as one where none of them existed. So it's safe to start with the assumption that there is at least one source available to any piece of land and a strong possibility of more than one.

Each source of water is unique. But if it is to find a place as the source of water for a water system, it must pass a test. It's not difficult to list some of the questions we would be likely to ask of it. However, let's first look at some of the characteristics of each source that both define it and help distinguish it from the other sources.

Rivers and streams: Rivers and streams represent a good source of water. Streams tend to vary more in

flow rates, helping shed immediate rainfall, whereas rivers typically display a delayed runoff of rain and are fed by a seasonal release of water locked in snowcaps or glaciers.

All rivers have their birth as streams and creeks, so size is the basic difference between a stream and a river. The sheer number of streams needed to supply one river indicates the higher probability of finding a stream on a piece of land than a river.

Springs: Springs are magical water flows from the ground, in a trickle or a copious flow of unusual clarity and purity. The actual source of the water varies. It may be the reemergence of a stream that has gone underground. Quite often a seasonal stream is only a portion of an underground run of water that, because of sheer capacity, sometimes shows itself aboveground as overflow. Springs may also be the result of a tear in the fabric of the water table itself, when internal pressure "bleeds off" the excess water. In particularly dry regions, the water in some springs may come from a very great depth.

Lakes and ponds: The flow of water in a river or stream may be temporarily interrupted by large depressions in the ground which must be filled before the journey is again resumed. If it's a big depression, we call it a lake; a smaller one is simply a pond.

Sometimes a lake or, more frequently, a pond is not supplied just by a stream or river. In fact, it may receive a major portion of its water from a spring. There are a number of ways to determine whether this is the case. If a pond is one of several water sources available to you, you may want to defer some decisions until you've positively established the pond's true source of water.

Shallow wells: So far the discussion has centered on natural water sources (although it is possible to build a lake or pond). However, if the water is not so readily accessible, a

shallow well is one way to get at it, particularly if you know it is just below ground level. And while a shallow well can be dug with machinery, it also can be hand dug. Traditionally, a shallow well may be 3 to 4 feet in diameter (**Fig. 2**). Because of the extreme danger to the digger in the event of a cave-in, these wells are limited to a maximum depth of 25 to 30 feet.

Deep well: A deep well may be needed to reach groundwater. The range extends, for our purposes, from 25 feet to several hundreds of feet. Wells to several thousands of feet are not uncommon, but at the going rate few private individuals could afford to drill to such depths.

The diameter of the hole that's drilled to reach water is as varied as the depths to which one might need to drill to reach water. Naturally, the larger the hole, the higher the cost. But while small and large holes alike can reach water, the difficulty of extracting it (or housing the equipment designed to do this) increases significantly as the diameter drops below 6 inches. A compromise is indicated. It will be easier to find the optimum diameter once a water-extraction system is selected and size of the equipment available from local well-drillers is determined.

Rainfall: Precipitation initially supplies the water for streams, rivers, lakes, ponds, springs, and wells. However, in whatever form—rain, snow, hail, sleet, or condensation—rainfall is a potential source of water in itself.

A clue to the means whereby rainfall can be tapped as a water source is supplied by nature. Streams and rivers, at the persistent urging of gravity, channel the runoff from rainfall to lower elevations. Damming one of these sluices is, in effect, a means of rainfall collection. Another crude but inexpensive way to duplicate this effect is to

continued on page 13

dig a trench across a slope in the path of runoff, terminating the lower side in some type of storage.

Serious collectors of rainfall are both practical and innovative, merely channeling rain shed by rooftops and their edge-mounted gutters into storage such as a cistern for later use. A surprisingly small amount of roof area will yield thousands of gallons of very clean water each year (**Fig. 3**). Rainfall measurements are taken by a number of agencies and records extend back for fifty years or more. Using these figures and allowing for a 20 to 30 percent loss due to splashing, overflow, and initial washdown of the rooftop, a remarkably accurate determination of capacity may be assessed for any rooftop.

Combining sources: There is a strong tendency in the United States for individuals to establish one strong source of water at a particular site and, damn the expense, set up the entire water system around it. This approach to water-system design is understandable. However, many areas don't experience such hardy water sources. And where they exist, the supply diminishes as populations expand and the use of water increases.

Given the diminishing availability of pure water sources, the notion of "one source, one system" becomes both foolish and dangerous. It's foolish because most situations have access to at least two water sources. It's dangerous because single-source systems are inherently vulnerable to the possibility, however remote, that the source will dry up. Even a temporary stoppage can be trouble for a system that has made no provisions for such an event.

Evaluating sources

Each source of water has inherent qualities and limitations. Decide which is an advantage or disadvantage to you.

Access: Access implies on-site presence. While much may be hidden from the eyes, if you don't have it, you don't have it. Relative to streams, ponds, and springs, a walk of the land will quickly reveal whether they're there or not. If they are, list them as probables. The same goes for any source that is intermittent, such as seasonal streams. However, don't confuse "don't know" with "definitely not." For most properties, the evaluation of this single criterion access will cut the list of possible water sources in half.

Ease of development: On a scale of one to ten, make a preliminary evaluation of the relative ease or difficulty of developing any probable water sources. In a way, this is an availability rating. If you can walk right over and scoop it up, it gets a high rating. If you don't know, give it a question mark.

Water and the law: Access to, and availability of, water is not equivalent to the legal right to use it. Just because a stream flows through your property does not mean that you can take any of it for any purpose you wish. In some instances it may be permissible to take the water for household use or for a small garden, while other usages such as irrigation of fields, watering of livestock, and power production may be prohibited. In some places, this may even apply to a spring that starts on your own but that passes over the property line.

Legal use of water is defined as "riparian," "appropriative," or both. The first acknowledges the need to share water, and the second is "first come, first served." It's beyond the scope of this article to cover all of the possibilities in sufficient detail. But it's up to you to fend for yourself. Water rights are not always clearly designated in the property deed, nor are they automatically part of the title search that commences once a property is in escrow. Little wonder, then, that people buy a piece of land only to

FIGURE 3: Net yield of water for cisterns per square foot of catchment area

Minimum annual rainfall (inches)	Water yield (sq. ft.)* (gallons)
10	4.2
15	6.3
20	8.3
25	10.5
30	12.5
35	14.6
40	16.7
45	18.8
50	20.8

* Adjusted for 30% water loss due to leakage, splash, roof washdown, and evaporation

Rooftop rain collection is used worldwide.

discover sometime after the sale that their right to the water on their land is restricted or prohibited. For this reason, any property that has an unusual abundance of water that has not been developed should be treated as suspect in this matter. If you want to make some use of the water, make its legal use part of your conditions of sale, or keep on looking.

Contamination: All surface waters are subject to pollution. Airborne pollutants brought down by the rain. Fecal matter from animal stock, camper owners, and improperly installed and maintained septic systems. Minerals washed from tailings (the material left over from mining operations). Logging. Roads. Landscaping projects. And others. The probability of contamination is higher with each passing mile.

Lakes and ponds are in the same predicament as the rivers and streams that feed them. However, unlike their nomadic cousins, their still waters are not always able to pass the problem on downstream somewhere. Instead, the suspended material precipitates and coats the bottom. Left undisturbed, the polluted material is quickly covered by other suspended material.

However, if the inrush of water feeding the pond or lake normally stirs up the sedimentary layers, watch out. Those who harvest the rich silt from seasonal ponds should take note. They may get much more than they bargain for.

Springs and wells are least affected by contamination, even though their water percolates down through the soil from the surface. The soil itself is an excellent filter. In fact, the water doesn't have to go very far at all. With some soil types, a few feet is sufficient to remove most of the contaminants. For this reason, water from springs and wells is some of the purest available. However, this water is also exposed to mineral deposits, and other substances. Their concentration in the water may exceed levels acceptable for human consumption.

Collected rainfall is also quite pure. The first few minutes of rainfall should purge the air through which it passes of contaminants. Furthermore, this same water will flush the actual

collection system (a rooftop?) of any other particulates. But, while this source altogether bypasses the type of exposure experienced by streams, rivers, ponds, lakes, springs, and wells, it is also devoid of the beneficial trace elements found in these sources. If used as the only source of drinking water, its sterility actually could be unhealthful.

These are relative indicators. Until proved otherwise, water from any source should be considered suspect and tested. If need be, it should be treated for the presence and relative concentration of a host of elements, minerals, pollutants, and bacteria.

Any source of water exposed to the open air may also be contaminated by nuclear fallout. Whether it's from testing or an actual war or the failure of a nearby nuclear power plant, the effect is the same. Naturally, rivers, lakes, streams, and ponds are easily contaminated by fallout. Again, springs and wells are the least affected. However, a big part of this is "cover." An open

spring box, open storage of well water, and a rooftop system for rainfall collection defeats the natural protection of these sources from contamination.

Proximity to usage: A potential water source should be rated according to its distance from the point where the water is needed. This evaluation assumes that the building site has already been established. If it has not, pick some "possibilities" and evaluate the potential sources accordingly. Precise distances are not required. A simple comparison between two or more sources is sufficient for now. In the final analysis, it's conceivable that developing a less accessible source closer at hand may be preferable to the cost or relative difficulty of transporting water from a readily available water source.

Elevation: The elevation of each water source relative to the usage site should be noted. It takes energy to move water. If the water can move itself via gravity flow, all the better.

SIDEBAR A: MEASURING A WATER SOURCE'S CAPACITY

Measuring capacity is rarely a difficult task. However, such a measurement represents an instantaneous reading. Measure it later—by the hour, day, week, month, half year, or year—and you're likely to come up with as many different values as the actual number of readings taken. Why?

Simply stated, capacity varies. Rainfall, snowpack, seasons, drought, or unusually wet periods influence capacity. So do earthquakes, evaporation, seepage, increased usage, and higher population densities. No water source is exempt from the effects of some of these conditions. Minor fluctuations are of no concern. The variance in the readings one will obtain from any one source over a period of

time, however, is evidence enough that we're not talking about insignificant differences.

If we took the readings at regular intervals over the span of a year, we'd know both the minimum and maximum values of capacity. A fail-safe tactic then, is to build your system based on the lowest figure obtained. Another tack—basing your system on a capacity figure halfway between the minimum and maximum readings—makes more sense, but it introduces an element of risk. Voluntary conservation may be needed during the drier portions of the year. A saner and safer course might be to select a rating closer to the minimum and between one fourth and one third the maximum.

It is impractical to wait long enough to take readings over a peri-

od of a year just to obtain figures and then extrapolate a reasonable design capacity. A faster means of obtaining a sound answer is to discover exactly what factors are responsible for the variance in the capacity of any water source. This has a fourfold effect. One, it helps select the best time to take the reading. Two, it indicates what can affect the accuracy of the reading. Three, it permits adjustment of the reading to a figure useful in system design. And four, it indicates what can affect the specific source(s) you use. This assures a quick response to a crisis and implementation of conservation techniques or alternate water sources. It beats waiting until the effect is felt and it's too late. A fish has no exclusive claim to being stranded high and dry.

So, higher ratings go to sources that are higher than the usage site. This is relative. A high-elevation water source that is too far away, is not in line of sight, or is traversed with gullies or other inhospitable terrain is less appealing. Approximate these elevations above or below the level of the usage site.

Capacity: Any water source has a capacity. This refers to the maximum amount of water it will deliver under any condition. It's usually described in some convenient term such as gallons per minute (gpm) or gallons per hour (gph). Depending on the source in question, there is always some means of approximating or measuring the source's capacity (**Sidebar A**). Let's look at the factors that may affect the capacity of the water source. This includes the measurement, usage, evaporation, seasonal variation, rainfall, and other factors.

The measurement. Always choose as large a time frame as permissible—anything timed in seconds, or portions thereof, includes a larger degree of possible error than something timed for half a minute or more. Then, no matter what pains you took to do it right, repeat the measurement. An accurate reading is a repeatable one.

Usage. A variance in capacity may be attributable to a variance in the use of the water. How many times have you heard someone claim that there's less water available during the summer than in the middle of winter? There are other factors that affect this, but one that's frequently forgotten is that there's a greater need for water in the summer for cool showers, the watering of orchards and gardens and such than in winter. This doesn't constitute a real change in capacity, but it sure feels like one.

An influx of new residents in the immediate vicinity will inevitably bring about a greater usage of water, decreasing the supply of some sources. Or there may be very little

SIDEBAR B: LOSSES DUE TO EVAPORATION

Under the worst possible conditions—very dry air, lots of wind, a hot and sunny day—the amount of water lost to evaporation is actually measurable. To see this, find a pond and stick a ruler in the mud. Take a reading in the morning of a high-evaporation day and another that evening. I've measured a ¼-inch loss in one day strictly from evaporation. (This test assumes that no other water is being taken from the pond.) With a big pond, it adds up quickly. For example, with a circular pond 50 feet across, a ¼-inch drop adds up to 306 gallons lost per day. That's 2,140 gallons a week—in one month, 9200 gallons sucked up by evaporation. It doesn't take many months to dry up a pond at that rate.

change. Even a new well or spring development nearby will not necessarily tap your own supply. At worst, the water table may drop and a stream dry up. Depending on the types of water rights in your area, you may or may not be able to do something about it. More drilled wells in the immediate area will inevitably lower the water table further, and your well could dry up. Unfortunately, subsurface water is not nearly so well protected in a legal sense as streams or rivers may be. The difficulty of proving that any specific well is responsible for the loss of others is obvious.

If you are still in the developing stage, this might be a case against a spring or well development. Is there a potential for a lot of new wells or a few high-consuming wells (as for industry or business) in the vicinity in the years ahead? Naturally, the smaller the parcel of land, the higher the probability of some effect from a neighboring well near the property line. Sitting snugly in the middle of even a piddling forty acres is buffer enough against interference in most instances.

Evaporation. Water left standing in the open will be sucked up by the air as water vapor. This is called evaporation. The rate at which water evaporates depends on the dryness of the air, the temperature of the ambient air and water, the amount of water exposed (the surface area), and the amount of air movement (wind

speed). If this is the source for a water system or the storage for water taken from other sources, evaporation must be taken into account in estimating its capacity (**Sidebar B**).

Water standing in spring boxes, wells, covered tanks, or cisterns (closed reservoirs) also experiences some losses due to evaporation. However, since less air is in contact with the water under these conditions, smaller losses are incurred.

Spring and stream-fed ponds and reservoirs may show little capacity variance due to evaporation losses, as these may be offset by input. On the other hand, ponds or reservoirs that are filled by a seasonal stream must hold their own against losses other than normal use, such as evaporation or seepage. In these cases, evaporation becomes a critical factor.

There's little one can do about evaporation from an existing pond. A new pond, on the other hand, can be designed to minimize losses. Start with the pond's shape. It should be relatively deep in proportion to its surface area. Retaining the volume but halving the surface area will halve the evaporation losses.

A second tactic is to site the pond out of the direct rays of the sun. Taking advantage of shade trees or natural shading from hills will help. Know the sun's path through the sky during the summer months. If natural shade is not available, build it. If it's too expensive to shade the reservoir

altogether, erect a structure that will shade the water for at least a portion of the day.

If nothing else, knowing the effect of evaporation should indicate the futility in simply damming up a section of a creek in the merry belief that this is an automatic guarantee of water through the hot summer. And, as the levels sink, you won't be lured into an assumption that it's "seeping away" and throw more money into solving that problem. Of course, you could be losing water both ways—to evaporation and seepage—but each inflicts losses that no conservation techniques will dent.

Seasonal variation. A dry creekbed in the middle of summer may be a raging stream during winter. Measuring the level of water in a well will invariably lead to higher readings in the dead of winter than those taken in the fall. That comes as no surprise to most people. Winter may bring cold and misery, but it also brings precipitation. In the form of sleet, rain, hail, or snow, it's still water. And as the water makes its way over and into the land, the water table rises, the creeks begin to flow or flow more profusely, and ponds fill.

Any measurement of capacity must take into account the season in which it's taken. A water system designed around a reading taken at the end of summer is never going to want for water. A system based on a reading in the spring of the year may find itself in trouble by summer's end.

How much difference will exist between the two readings? Unfortunately, it's too situational to generalize. The capacity rating used for system design will probably be something below the average of these two readings.

Fortunately, we don't always have to be exact with these figures. It is helpful to have some numbers for system design, but we must not lose sight of the fact that capacity does vary. Inevitably that means that sometimes

there will be too much water and at other times too little. A good system can easily handle the rare instances where there's too little source capacity. It's a versatile system that is able to make use of the instances where there's "extra" water.

One limitation of end-of-summer capacity measurements is that the source may have just temporarily run out of water. An otherwise good source of water may be hidden. Don't be put off by a really low reading. Besides the fact that it's the reliability of the source that's important, take some consolation in the fact that the reading you've obtained probably represents the lowest it will ever be.

Rainfall. While winter is normally characterized by an abundance of water and summer by a lack of it, rainfall occurs in varying amounts throughout the year. So rainfall at other than seasonal times is a bonus and its absence a penalty to some water sources. Few water sources will note a measurable difference in capacity from a light rain, even if it's over a period of several days. If the rain is heavy, however brief it may be, the ground may not absorb it rapidly enough and runoff will occur. In this event, even seasonal streams may flow and ponds will fill.

This event should be treated solely as a bonus to a system—if it's able to capture it. This bonus will permit an extra ration to the garden and a long shower for yourself. However, no system should be designed around such a chance occurrence. Accordingly, whenever a measurement of capacity is taken after any such freak event, the reading must be adjusted accordingly.

Cloudbursts and heavy rainfall runoff may be considered for their water potential, in addition to a system's own reliable water source, if they occur often but aren't predictable enough to depend on. Here the gain must be weighed against the cost of establishing some means of collection,

and possibly storage, of the runoff. Since heavy runoff is characterized by turbidity (suspended particles like silt, organic materials, etc.), a secondary storage setup is recommended, even if it's only temporary. This recognizes that while filters to eliminate water turbidity do exist, the best overall means of controlling this condition is to let the water "pool." Once immobilized, the suspended particles will simply settle to the bottom of the holding tank.

Springs and wells are unlikely to experience any immediate increase in capacity due to rainfall. If the rainfall is short-lived and comes down hard, there will be no increase, since the water will escape along the surface. A long, slow rainfall will raise the water table, but it will take time for the water to reach it through the earth. Any measurements from either a spring or well that are taken a few days to a few weeks after a long, steady rainfall may affect a capacity measurement. The reading should be adjusted accordingly.

Other factors. Other factors will affect either capacity or our measurement of it—earth tremors, leaks in the system, etc. The intermittent nature of any wildly fluctuating water source motivates people to seek other, more reliable sources. But in the cost/benefit ratio taking into account such factors as dollars, time, skills, knowledge, reliability, simplicity don't rule out extensive or occasional use of variable capacity sources. No source is a guaranteed, long-term thing.

Fortunately, anything that might affect capacity only influences some of the potential water sources at any given site. Therefore a multiple source water supply is preferable to one seemingly strong source. If nothing else, permit options in the final design and sketch out a few details for connecting up to an alternative source should you need to. A preplanned

continued on page 19

course of action in an emergency is a whole lot better than merely reacting to the situation.

Specific uses: We'd all prefer to have grade AA water or better, but with the sources available to us that may not be possible. Water purification beyond some token filtering is costly, complex, and difficult to maintain, and should always be avoided. Too often a water source that's only slightly tainted is crossed off the list in favor of one that delivers purer water at a significantly higher cost in development, transportation, or complexity.

A large part of the difficulty in this thought stems from a tradition lumping all of our water uses together as needful of the same level of water purity. That is, we demand drinking water quality in the toilet!

Understandably, we will want a high level of purity in water used for drinking, cooking, dishwashing, bathing, and some gardening. Other needs—agricultural, watering stock animals, washing clothes, treating sewage, watering lawns, washing cars, storage in case of fire, and so on, do not require perfect water. The two groups overlap and may even be separated into other “shades” of water purity. Only the ready availability of pure water has prevented more extensive implementation of “graywater” systems.

Other than the cultural stigma attached to graywater use, the main objection to multiple uses of water has been the need for duplication of pipe runs and sufficient planning to ensure that the various levels of water do not unwittingly merge. For existing systems requiring retrofits, the objection is valid. However, for new systems the cost of the extra material and designwork is very competitive with the higher need for water and the energy required to pump it from supply to use. Since pure water sources are decreasing and the cost of energy is increasing, a system that favors low

water use (characteristic of multiple use systems) also uses less energy.

COST: So many of us have taken water for granted so long that when it comes time to shell out some money for a water system, we're shocked at the cost—we might be talking about thousands of dollars! Striving to keep the costs to a minimum is natural, and any system should be cost effective. However, it's unwise to concentrate too long or heavily on cost right away. Otherwise, we end up letting this factor lead us through the myriad of decisions, and down the line we end up paying for it in some other way. Maybe the ultimate cost will be too high in intangibles—dissatisfaction, for example, or time and worry, adjustments in lifestyle, a lack of versatility in the system. Sometimes, though, we're talking about hard cash repairs, refits, modifications for every little new thing that's added to the system, extraordinary maintenance, the cost of consumable materials such as filters and chemicals, those monthly energy bills, etc. Rarely do our troubles stem from ignorance; too often, we know these things exist. If we had the power really to minimize them as effectively as we're able to convince ourselves of their supposedly minimal effect, we'd have something.

Good design can significantly reduce the impact of the initial cash outlay for a system. For example, an honest appraisal of what's needed right now and what can wait until later gets things going with a reduced cash outflow. Planned “add on” always costs less than modifications that weren't anticipated from the start. Another merit of this approach is that it permits a “weathering” of the system. Changes do occur, so the water system you design may have a different feel once you start living on your land a year from now. People change, situations change, and both affect the system. A wise course of action takes that into account. Design it, build the portion you can afford, and build in

sufficient leeway for changes as they're needed or when you will have the money. You get what you pay for. Remember: the bitterness of poor quality is remembered long after the sweetness of low cost is forgotten.

ENERGY SOURCES

As with anything that has weight, if we want to move water from one place to another we must use energy to do it. Individual water systems have individual energy needs. Very few are lucky enough to require “no” energy, and some are unlucky enough to require energy at every step—extraction, transport, pressurization, and storage. Water that required one or more of these steps to be converted from standing water into useful form for household or farm use is said to be processed.

Let's look at the variety of energy sources that may be set to work processing water.

Gravity: Whenever and wherever water is high enough to let gravity do all the work, let it. Sometimes, even when it isn't high enough, it pays to go out of your way to give it this potential for the benefits it yields over the energy expended in the effort. More on this later.

Human muscle power: Water may be processed by human power. This takes two forms. One is through use of the bucket, where a person scoops up the water and walks from the water source to the point of usage. At the rate most families use water today, this would prove labor intensive. However, the idea has some merit, and should not be rejected outright. The initial investment is small (one bucket) and the exercise alone should keep anyone fit.

Human power can also transport water through the use of a pump. The hand operated pump standard has been around for a long time, and it's guaranteed to give you strong arm muscles along with the water. A variation on

the theme is a pedal-powered water pump. Legs are more powerful than arms, and through suitable linkage the leg muscles may be put to work pumping water. Admittedly, for all that pedaling the scenery doesn't change much, but at 100 gallons to the "mile," who's complaining?

Animal power: Prior to the use of fossil fuels, physical labor beyond the capacity of the ordinary man or woman was done by beasts of burden such as horses, oxen, or goats. This is still a good possibility for pumping water wherever any of these animals have been reintroduced to the farm or homestead. However, considering the amount of feed these critters can consume, centering any water system totally around animal power is a doubtful possibility.

Fossil fuels: Another popular energy source for processing water is fossil fuels. Initially only oil was available. Its use was limited to centralized facilities where oil burning turbines drove generators, producing electricity that was, in turn, transported over wires to the usage site. Once there, the electricity could power electric motors that would supply the needed mechanical motion to operate pumps of various types. Fossil fuels in the guise of utility-supplied electricity are probably the number one source of energy for water systems in the U.S.A. today. High density fuels—propane, diesel, kerosene, and gasoline—derived from fossil fuels may also be purchased for engines powering onsite water processing equipment. However, the cost and noise factors usually limit this usage to backup systems for use only during emergencies when the primary system isn't functioning.

Waterpower: Moving water is also an energy source, whether it's a river or a waterfall. Either way, this energy may be captured by a variety of novel mechanical or electrical devices. In turn, these will pump a portion of this water (or water from

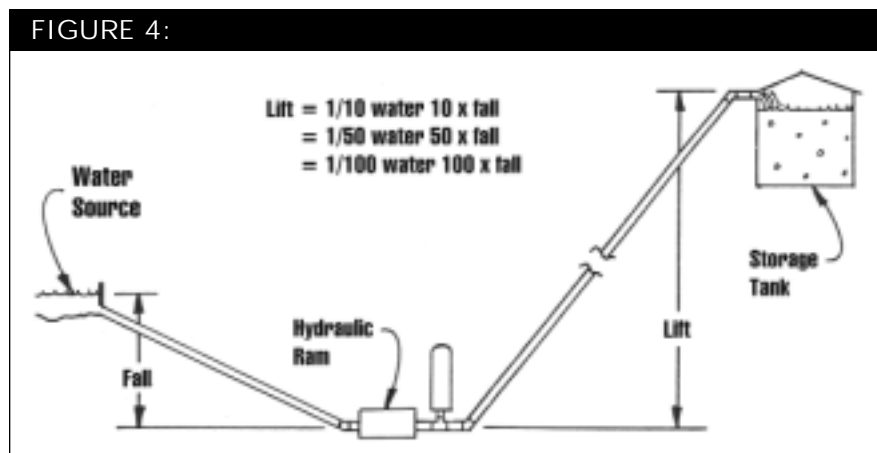

The hydraulic ram is a water-powered water pump.

another water source) to places far away or higher up anywhere the water would not flow of its own accord.

The simplest device available is the hydraulic ram (**Fig. 4**), which uses the energy of water to pump a small portion of the water to a higher point. Theoretically, the hydraulic ram will pump 1/10 of the water 10 times as high as the waterfall, 1/100 of the water 100 times as high, and so on. Pump inefficiencies reduce this amount somewhat. If a landowner has access to a river but either has no legal right to use any of its water or chooses not to, the dual-acting hydraulic ram is useful. It uses the energy of the river's water to pump water from another source such as a spring or well to the appropriate place.

Waterwheels and turbines will also pump water directly. More often, however, they are connected to other devices that supply mechanical energy or, in the case of generators, electrical energy.

Natural gas: The decomposition of organic materials under certain environmental conditions produces natural gas. At the utility company level, this gas is often processed to produce propane, which has a higher energy yield per cubic foot than natural gas and is easier to liquefy.

Back on the farm, natural gas may be produced from animal or agricul-

tural waste in a digester. Methane (CH_4) is the desired end product, but it is produced in company with other gases and substances. In this mix, it's called bio-gas. Detectable amounts of bio-gas may be produced from a remarkably small amount of organic material. For application in a water system, sufficient bio-gas must be produced to power a small internal combustion engine. This in turn can operate a water-pumping mechanism or produce the electricity to power a motor that will drive a pump. This requires an enormous amount of animal or agricultural waste. Nevertheless, where the right conditions exist, the production of bio-gas is a viable alternative to on-site energy sources for small, engine-driven water pumping functions.

Wind power: Another major source of energy for water processing systems is the wind. Here, one of several types of wind machines extracts the wind's energy and converts it into the mechanical motion needed to work a water pump. If there's a problem with this setup, another type of wind machine can be used to produce electricity to power a motor connected to a water pump. As far back in recorded history as you'd care to go, wind has been harnessed to pump water. In some areas the wind is both constant and strong enough to guarantee water

processing around the clock, but this is rare. Any system that uses the wind's energy for water extraction and transport must be equipped with sufficient storage to satisfy demand during periods of low or no wind.

In the 1800s there was a definite need for water pumping in very remote areas for livestock and agriculture. To meet this need, private companies developed wind machines that were simple, rugged, and virtually maintenance-free. Even the later introduction of electrically powered motors and oil, kerosene, or gasoline engines could not stem this industry. After the initial investment, there is no further operational cost with a wind machine. Closer to the farmhouse, these wind machines did yield to the high capacity electrical pumps. The mere presence of the old towers and windmachines today is proof enough that the farmer or rancher wasn't inclined to let them go altogether. Even in disuse, these reliable machines are hard to part with.

Selecting energy source

Each potential energy source—gravity, muscle power (human or animal), fossil fuels, natural gas, water, or wind—should be evaluated in terms of energy needs, reliability, availability, access, independence, complexity, and cost (initial and ongoing). If you have no prejudice in the matter, this becomes a straightforward process of elimination, followed by a simple choice if more than one source emerges unscathed. If you do have preferences (most of us do), this process may help you select a secondary, or backup, energy source. Is that necessary? Judge for yourself.

Energy needs: A prime factor in selecting an energy source is its ability to handle our system's needs in processing water. Irrespective of how much that amounts to, you want to keep this to a minimum. A system's

need for energy is ongoing. Since energy in any form costs something, both dollars and "sense" dictate using as little as possible.

Now is as good a time as any to introduce the Concept of TANSTAAFL. That's short for "There ain't no such thing as a free lunch." Don't expect something for nothing. No energy source is free. What about gravity? True, gravity is everywhere. Yet, if the water source on the property is too low relative to the usage site, you can't put gravity to work unless you first expend some other form of energy to lift the water high enough for gravity to take over. If your site doesn't permit you to take direct advantage of gravitational energy, one fact emerges: you have a lot more energy sources to choose from if you can keep the system's energy requirements very low. Water pumping wind machines, for example, will suffice even in areas of very low wind. They're designed to operate at low wind speeds. This advantage is lost in energy intensive systems, as would be the case with muscle power, methane, and small scale waterpower developments. All too quickly, energy sources available onsite are lost in the "big energy" shuffle.

Reliability: Reliability is, first and foremost, not having to worry about the system. Open a faucet and you should get water. If the storage tank is low, either it is filled automatically or, through a monitor, you are informed when refilling is needed. Reliability is also continuance. Everything wears out sooner or later, but frequent breakdowns are a symptom of a problem.

Reliability doesn't just happen. If this factor isn't built into the system in both its design and equipment, it's doubtful that it will be exhibited during operation. How do you design for reliability? That's easy—follow the kiss principle: Keep It Simple, Silly! A system is no better than its smallest or weakest part. If you skimp

on any aspect of the system, it's going to get you.

Reliability is increased as the number of energy conversions and transfers involved between the prime mover (energy source) and the application decreases.

Let's compare two systems. In System A, a water pumping wind machine converts the wind's energy to mechanical energy (rotary motion) and then into a reciprocating action (up and down motion) which, via a long rod, works the water pump. This amounts to one energy conversion and two simple energy transfers. In System B, the water system is based on a submersible pump powered with utility supplied electricity. How many steps are involved? Since most of this electricity comes from oil or coal burning power plants, the coal or oil must be found, extracted, processed, transported to the power plant, and burned. The resultant heat produces steam, which drives turbines coupled to electrical generators. The manufactured electricity travels through power lines to your land, where it drives an electric motor which in turn operates a pump. That's six energy conversions and four energy transfers.

Now, I ask you which system, A or B, is likely to be more reliable?

Availability: Availability has a time frame. What has been available in the past and is now may not be available in the future. Many people don't like to think about that—it smacks of doomsday—but there's no avoiding it. The world is running out of oil, natural gas, and coal. The experts may not agree on when our supplies of these natural resources will be exhausted, but it will happen. This is the time of plenty, and chances are pretty good that it won't happen in our lifetime. However, long before the fuels run out, the ripples of the shortage will make themselves felt.

Independence: An offshoot of availability is a personal decision involving independence. However

gregarious we are, most of us would like to gain control of our individual lives. The convenience of utility supplied electricity, then, might be shunned for the independence to be gained by using available on-site energy sources to which no meters are attached.

Independence comes when you take on the responsibility for the system—its maintenance, correct operation, and at least minor repairs.

Complexity: The connection between reliability and complexity has already been established. Complex systems seem easier to operate than simple ones. Why? Essentially, automation takes the burden of decision making away from the human user. Given the sheer number of factors at work, to choose the correct response for any given set of circumstances requires an extensive monitoring and control setup.

There's nothing inherently evil about complexity. Any increase in vulnerability arising from the number of parts is easily offset if the owner/operator understands how it's all supposed to work. Supposedly, then, it's easy to troubleshoot and isolate malfunctioning components. This makes the individual an integral part of the system.

The alternative is to set up a simple system and retain the decision making aspect yourself. Certainly the fewer the component parts, the less there is to go wrong. I prefer this approach because it keeps me in touch with my system. A side effect of this involvement is that I'm apt to notice a problem that can be fixed before it results in a breakdown or requires the replacement of an expensive component.

Cost: It's sometimes difficult to separate the energy costs from the system costs. For example, the use of some variable, intermittent, or low yield energy source demands a provision for water storage (tank, cisterns, etc.). However, there are other reasons

that might prompt an individual to use a storage system. Or to install a much larger size than what's required for simple utilization of the energy source itself. Without getting into actual dollars and cents, we can establish a few associations. One concerns the initial cost versus the ongoing cost. Utilizing available on-site energy sources such as wind energy and water energy seems at first prohibitively expensive. All the money is up front. By comparison, a utility powered submersible setup comes with a lower initial price tag. However, there's a string attached. It all runs on specialized energy that must be purchased in monthly installments. The "string" is suddenly an umbilical cord. Water systems based on renewable (independent) energy generate their payoff in dollars saved through the years.

It was an enlightening experience to rebuild my water pumping windmachine and be told that the last time the company made a major change in the design was 1933! What does this have to do with costs? If you're to spend hard earned dollars on equipment, it's nice to get built-in quality, ruggedness, and craftsmanship. Even several generations ago, the workmanship was superb. Manufacturing dollars spent on equipment of an older design go into materials. Newer equipment must pay off tooling, designwork, and advertising to inform the public that the product exists.

Multiple energy sources: Just as it's good to have more than one water source, it's good to have more than one energy source.

Any energy source or service can suffer a temporary interruption. How well the system will fare during this period is a matter of design and luck. Minimizing the "luck" part is, of course, desirable. Systems that apply all of their energy to processing water in such a way that it may thereafter assume energy-free (gravity) flow and pressurization are prepared for such eventualities. Some owners may find

the price tag for this brand of security a little steep.

An alternative is the system that utilizes two or more energy sources. While either may be interrupted at any time, the probability that they would both disappear simultaneously is mighty low. Add a third energy source and you can bet your nest egg that you'll have at least one of the three sources operational at any given moment.

Contemplating the use of two energy sources when you haven't even picked one may seem a bit much at this point. No problem. Pick one, design the system around it, and install it. Use it that way for a while. Keep thinking about that alternative, though. Which is the right one may not really become clear until later anyway.

The only important thing you should do before installing a water system is keep your options open. For example, it's always nice to avoid duplicating any more of the equipment than is necessary. Knowing beforehand what additional source might be used will help you select equipment that may also accommodate the other energy source when (or if) it's added. Forethought will at least identify where the systems can be joined. Even if the "mate-up" plumbing is not installed initially, you can keep this area of pipe accessible and otherwise unencumbered for it later. If two energy sources are intended, why not select one that's free, provided you have the equipment to harness it? I can understand a system that has a gasoline-fueled standby generator backing up a utility electricity-powered submersible pump. I can better appreciate a submersible setup with a wind energy backup. A focus here is the word "backup." If the wind machine doesn't supply a major portion of the system's energy needs during the year, at least it didn't cost anything, other than the initial expense of hardware. The same cannot be said for the standby generator. Besides, why

rule out the possibility of a pleasant surprise? Wind machines often pay their own way. If it produces more than 50 percent of the energy needed, you can then say that the utility-supplied energy is the “backup” for your water system.

WATER PROCESSING

The water source and the site where the water is used are frequently separated by some distance. Even if they aren't, having water at the usage site does not automatically guarantee water flow from faucets, spray from showers, or a full toilet bowl. If we want this capability, then the water must be “processed” into useful form. Processing water involves as many as four functions (**Fig. 5** and **Sidebar C**). The standard utility-powered water system based around the submersible pump performs these functions simultaneously. While this is convenient, it is also wasteful and inappropriate. Each function is distinct. A good water system acknowledges the differences in functions and accommodates their virtues individually. The explo-

SIDEBAR C: THE FOUR FUNCTIONS OF WATER PROCESSING

Water processing involves four functions:

Extraction is the vertical movement of water. On an X-Y axis, this is the Y component and it represents lift. Extracting water from a well and pumping water up a hill are examples of extraction.

Transport is the horizontal movement of water. On an X-Y axis, this

is the X component and it represents the way pipes will route water from a well to a tank or usage.

Storage is the accumulation of water. This may be in a well, a tank, or a pond.

Pressurization is the factor that ensures that water will flow out of a faucet with sufficient volume to be useful.

ration of these four processes is best revealed by arranging them in a different order: transport, pressurization, storage, and extraction.

Water transport

Pipe comes in a variety of sizes (to handle varying flow rates), standard lengths (to keep it manageable), and materials. Pipe made from copper, steel, or plastic is readily available. All types of pipe can be cut to any desired length or, through the use of couplers, extended to any dimension

over the length of one standard section. Depending on the type of pipe used, the sections are joined by screwing, gluing, or soldering.

Pipe can do everything that a channel or ditch can do and then some. For example, pipe can easily transport water down sharp inclines. Moreover, by attaching the appropriate fitting—a valve—the water flow may be stopped. The real uniqueness of pipe is that its use is essential to the delivery of water to a usage site that is above the water source. Transporting water horizontally does not require much energy. Even in a gravitational system, less than one degree of slope will permit water movement in a channel or pipe without further assistance. In fact, even in a perfectly horizontal pipe or channel, water will flow until it's all at the same level in the pipe. So there's demonstrably not much resistance on the part of water to flow. Once flowing, it wants to continue flowing, too. If any energy is consumed in transporting water horizontally, it is only to overcome the resistance of the channel or pipe itself.

Water pressurization

Water pressure is essential. If you have it, water gushes out of faucets. If the pressure is weak, the water trickles. Without some pressurization, no water flows. Pressure has some inter-

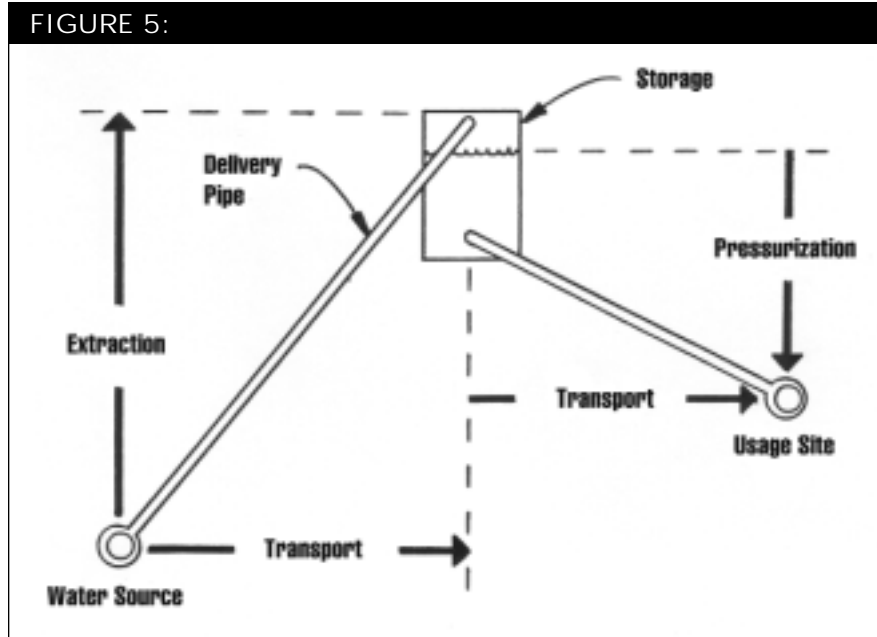

Processing water may be divided into four functions.

SIDEBAR D. PROPERTIES OF PRESSURE AND ITS MEASUREMENT

1. Pressure is not related to the length of pipe or to the angle of the pipe. Instead, pressure is directly related to the vertical distance between the level of water and the point of measurement. This is the depth of the water. In water systems, this distance is called the "head." Head is measured in feet.

2. Pressure is linear and directly proportional to the depth or head.

3. Water is virtually incompressible. That means that while you can pressurize it, this doesn't reduce its volume. Water is very different from air in this respect.

4. Pressure is not related to an amount of water—the number of gallons—but, again, only to the depth of water in any combination of vessels and pipes.

5. Since pressure is a force and force can be measured, we can measure pressure. First let's establish the units we'd use. A common

one is pounds per square inch, or psi. Metric fans will describe pressure in terms of kilograms per square centimeter or square meter: ksc or ksm. Hereafter, we'll stick with psi.

6. A really accurate instrument will measure the water pressure at a depth of one foot at .433 psi. At two feet, that's .866 psi. That also means we'd get 1 psi at a depth of 2.4 feet. A depth of 10 feet would measure 4.33 psi and thirty feet of depth would be roughly 13 psi.

7. That water has a pressure of .433 psi per foot of depth can be verified by converting the weight of one cubic foot of water (62.4 pounds) to that weight per square inch at its bottom. Since there are 144 square inches in a square foot, dividing 62.4 pounds of water by 144 square inches yields .433 pounds per square inch.

esting properties and may be measured (**Sidebar D**).

Static vs dynamic pressure:

With pressure, we have flow at varying rates. Without it, sprinklers and nozzles won't work. Some washing machines won't operate satisfactorily if there's little or insufficient pressure.

How much pressure are we talking about? Ask a dozen people that question and you're likely to get a dozen different answers. However, they'd range between 25 and 60 psi. Can we narrow it down? Yes the standard is 30-35 psi. The suggestion of this standard is that this amount of pressure provides acceptable pressure in your system. Before you accept that as your standard, I'd like to tell you a story. When I had land in the Sierras, I could only manage to place a tank on a hillside that gave me 30 feet of gravity flow water, or a piddling 13 psi. Still, when I turned on a faucet, the water would blast out. By using

larger pipe (1 1/2") in the ground coming down the hill, I had little pipe loss, and 13 psi seemed like 50 psi in other systems.

In a culture where electricity is cheap and pipe is expensive, small pipes are generally used in water systems. At high flow rates, this results in horrible pressure losses. To compensate, high pressure pumps are used. The trouble starts when people naively install the same size of plumbing in their low pressure system. With such high pressure losses, there's no performance. Only by installing larger pipes can high flow rates and satisfactory pressure be sustained.

Pressurizing pumps: Irrespective of the energy source, the hardware that accomplishes both water transport and pressurization in lieu of gravity is the force pump. It's also called a pressure pump, water pump, or lift pump. By whatever

name, it exerts a force that will push water along through a pipe.

Transporting water is neither difficult nor energy intensive because it moves water perpendicular to the force of gravity. Only resistance of the pipe itself will fight this effort. However, transporting water is actually a byproduct of the process of pressurizing the water. It takes a very strong force pump to push the water very hard and fast. When the pump's sole function is to pressurize and transport water, I'll refer to it as a pressurizing pump.

A pressurizing pump can be quite small, uses little energy, and doesn't cost very much. One with a working pressure of 30 psi and a pumping capacity of 10 gpm (gallons per minute), enough for most household uses, would cost under \$100 and sometimes half that amount.

Water storage

As squirrels put away nuts for the winter, one should tuck away some water for a time of greater need. Some water sources, notably ponds and lakes, automatically include the provision of storage. Streams and rivers use the storage of snowpack. Springs and wells have their water stored in the ground.

Artificial water storage buffers the source's inherent capacity against the widely varying flow rates characteristic of any water usage. The actual storage technique used—pond, lake, reservoir, cistern, tank, etc.—is situational. There are many reasons why someone might use water storage (of whatever type). Water storage could gobble up a good chunk of the money allotted for a water system. It's not unusual to find water storage as an integral part of some system that doesn't need it. It may be included for the practical and versatile features it exhibits.

Water storage is useful for normal usage, source variance, energy avail-

ability, gravity flow, gravity pressurization, fire fighting, blackouts, and other emergency situations.

Normal usage: If the highest rate of usage exceeds the capacity of the source, there's a problem. Without storage, the user must avoid higher than capacity flow rates and all things that need them for proper operation. Or develop another water source with sufficient capacity to handle the highest usage rate. With storage, however, the water source is able to provision the system against high usage rates. Pumping "low and long" from source to storage enables water usage to be "high and short" as needed.

This is a neat trick. Through proper applications of storage techniques, even a water source with an extraordinarily small capacity may be useful (**Fig. 6**). However, this does not increase the source's capacity. In the end, the ledger must balance. The total usage of water in gallons in a 24-hour period cannot exceed the source's capacity to store that much water during the same time period.

Source variance: The ability of storage to handle the variances in the capacity of the source, in addition to the fluctuations of usage, depends largely on the water source itself. Some are less susceptible to variance than others.

Most systems need only concern themselves with building a small reserve. But somewhere harks the possibility that the highest use may occur simultaneously with the lowest capacity. Ergo, no water. If this is about to occur, however, it's easy enough simply to exercise some basic conservation to ride out the crisis. In many ways that makes more sense than trying to conceive of every eventuality, designing the system accordingly, and having to foot the bill for all that protection.

Gravity flow: Even if the water source is not located at an elevation higher than the usage points it may be possible to site water storage there. If

FIGURE 6:

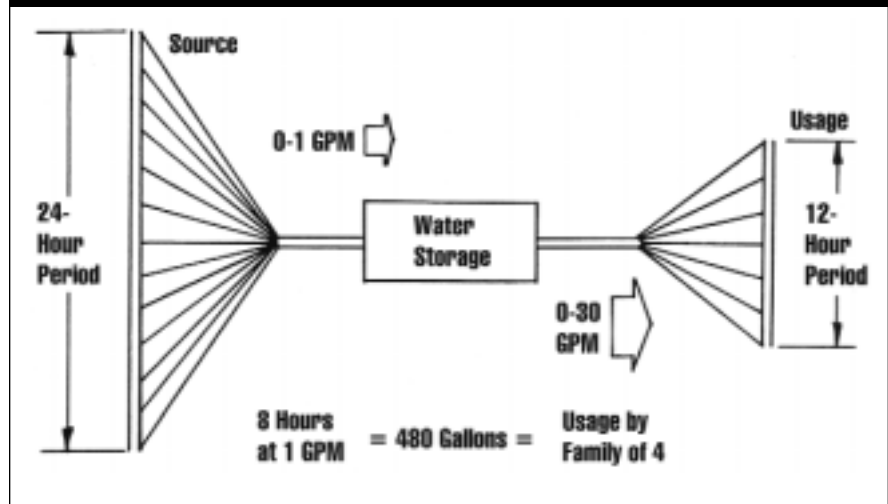

A low capacity source yields a good store of water over time.

the terrain is cooperative, this may involve a hillside location. If it's all flatland or your usage site is located at the highest point, this advantage may be weighed against the cost of slightly elevating, say, a storage tank to achieve gravity flow. This would not necessarily eliminate the need to pressurize the water for some uses. Still, the extra five to ten feet of head (over direct delivery to usage) would not represent any real burden for the pump that must extract and transport the water to storage. Additional uses such as gardening and watering livestock might well be served with this pressurized water, thus eliminating the need for a pump large enough to pressurize all the water.

Gravity pressurization: Landowners with a water source high above the usage site will benefit from natural (gravity) pressurization of water. By storing water, everyone can be a winner. No matter how far down the hill or under the ground the water may be, we can always lift it higher than the usage site to a storage site situated to allow gravity pressurization. Where a system has gravity transport and pressurization, the only energy required will be that applied to extraction and, perhaps, some transport. A demand system installed in identical

circumstances must extract, transport, and pressurize water at the highest usage rate. This requires energy use at high rates and large pipe to avoid pressure loss at the higher flow.

The store system, on the other hand, lets the position of the tank handle peak usage needs high flow rates, pressurization, etc. At the same time, it permits low energy extraction of water through (possibly) smaller pipe. Or the utilization of energy sources that are low yield in nature. The additional energy required to boost the water the extra distance to storage (to take advantage of gravity pressurization) should be considered. At such a low rate of flow, it's not likely to be significant.

Beware. The potential for the store system in this situation is exciting but, alas, not always realizable. Don't ignore the relevant factors and impose a system on a situation that is not a good match.

Fire fighting: A rural home or farm does not enjoy the same availability of water as the city. It is often supplied by individual wells or springs. Even if fire trucks can respond quickly enough to be effective, there are no convenient hydrants to which they may attach hoses. Accordingly, many fire trucks are

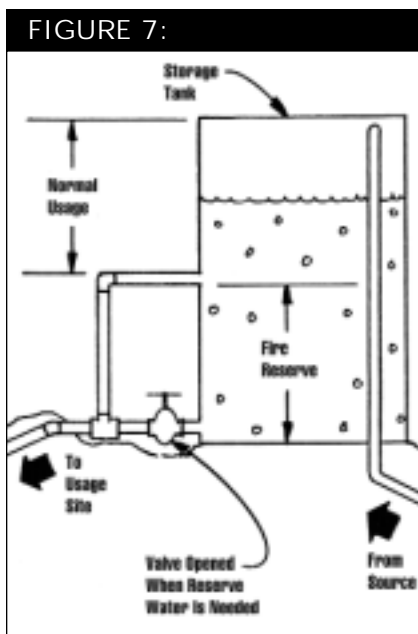

Simple plumbing ensures ample water for emergency needs.

designed to carry their own supply of water. Obviously the aid they render is minimal if the fire is not completely doused before they run out of water.

Water storage is fire insurance. Where the system design has sited water storage for both gravity transport and gravity pressurization, hoses and sprinkler systems will still be functional when electric power is lost during a fire. Even a system normally in need of electricity for water transport and pressurization from storage may be saved. Several measures may be taken to accomplish this task when utility power fails. In any instance, the presence of stored water assures the replenishment of a fire truck's dry tanks. Even if the fire fighters can't use your fittings, they usually have the equipment to draw water from your tank through a hose they carry for just that purpose.

It is of little use to anyone with a storage tank if the aforementioned fire occurs at a time when the tank is low or empty. Keeping a tank topped off all the time, however, is neither practical nor always possible. This is partic-

ularly true in systems that use a wind machine for pumping water or pump from low yield water sources. How about designating a certain portion of the tank (one half? one fourth?) as a reserve for fire fighting only? A simple plumbing modification (see Fig. 7) will handle normal usage. In the event of a fire the valve is opened and the water reserve is now available.

Blackouts: In the event of a power failure the inability to use the toilet, shower, or kitchen faucet is a nuisance. Since gravity is unaffected by such failures, any water system based on gravity pressurization functions normally in a blackout. Every system using pressurizing pumps for stored water may also be safeguarded from this effect by hooking up a battery to a 12V pressurization pump.

Other emergencies: Other events may interrupt the normal operation of a water system. Normal maintenance, i.e., lubrication and replacement of chemicals and filters and component failure can render the system inactive for a time. Cataclysmic events such as freak storms and earthquakes can incapacitate any system. Those equipped with storage, however, can supply their owners with enough time to cope with other pressing matters and set up some alternative pumping if required. As with fires, without implementing an actual reserve capacity in the storage system, there's no guarantee that you'll have a full or partially full tank when an emergency occurs. Don't leave this to luck! Through either automatic functioning or an audible or visual indicator, a reserve capacity should be protected against being drained off in normal, everyday usage.

Types of storage: Storage can take many forms. First of all, it may be readily available, as a nearby pond or lake. With the right kind of terrain, ponds or lakes may be made to take advantage of the presence of streams, rivers, or springs. Wherever there's little hope of channeling surface water

into these depressions, a man-made pond may be scraped out of the earth. Another type of storage is the reservoir. It may be earthen or have its sides and bottom lined with concrete. Generally, a reservoir is an uncovered, concrete-lined storage container.

The same factors that limit the use of ponds and lakes as sources of water apply to their use as storage systems. Reservoirs suffer from the same limitations, so I will not consider them any further for primary water storage. Any one of the three may faithfully serve as secondary water storage. It is somewhat annoying in water scarce areas to see a sudden shower yield a small flood. All that water going to waste! With secondary storage, a system may take advantage of a freak rain shower without having to depend upon it. The water captured in this manner may be used wherever needed.

The remaining three storage systems—the well, tank, and cistern—are all good candidates for primary water storage. **(Sidebar E)**

Characteristics of storage: Some other good but not so obvious characteristics of storage will manifest themselves at some point. In the interest of saving you some time and money, let's look at open versus closed tanks.

Closed tanks. "Closed" tanks are sealed against the atmosphere. They're also referred to as pneumatic, or pressure, tanks. They're small—most don't exceed a 100-gallon volume—and are intended primarily to aid in water pressurization. Though found in any system where the water is pressurized (except gravity), they are most useful in the "demand" water system. Contrary to popular opinion, pressure tanks are not really intended to store water. If so, they would do a bad job; a 100-gallon tank can hold only about 15 gallons of water under pressure. The rest of the space is for compressed air. A pressure tank should never be con-

SIDEBAR E: PRIMARY WATER STORAGE

There are three candidates for storing water: in-well, tank, and cistern.

1. In-well. Due to the characteristics of wells, once water is struck at some depth, the water level may rise significantly. For example, in my own well in the Sierras, water was struck at 125 feet and immediately rose to within 40 feet of the surface! Attempting to find a larger capacity (the well had tested at 4½ gpm), we drilled the well to 150 feet before we stopped. Since the deep-well cylinder we installed sits at a 125-foot depth, we have 85 feet of "storage" in the well (125 feet minus 40 feet). For a hole 6 inches in diameter, that's approximately 1.5 gallons of water per foot. For 85 feet, this represents 128 gallons of storage water.

In a way, this was free. We had to drill to 125 feet in order to hit water in the first place. However, had we hit water at 40 feet, we probably would not have drilled more than 25 feet farther. Why? At \$10 per foot of drilled well, the in-well storage capacity is costing over 6 dollars per gallon! We had already decided to site the storage tank for both gravity flow and gravity pressurization. Therefore, the "siting" of the in-well storage was not a matter of preference and is, in fact, in the wrong place!

In-well storage has its place. In a "demand" water system, in-well storage serves as a buffer against

higher-than-capacity usage while assuring that the inlet to the pump is, at all times, submerged. Low-capacity wells may need to be drilled extra deep to prevent draw-down—the distance the water level drops during normal pumping—from exposing the pump inlet. However, at the lower pumping rates characteristic of stored water systems, drawdown is seldom a problem.

2. Tank storage. Water may be stored in tanks made of wood, metal, concrete, or plastic. Plastic and some types of metal tanks can be delivered to the property ready for use. Of course, this is more expensive than building tanks or cisterns on the site. This relatively higher cost of storage may be justified in light of the convenience and the built-in protection against contamination (relative to the cistern).

3. Cistern storage. A cistern is normally classified as underground water storage. Since tanks, reservoirs, and cisterns overlap somewhat in definition, we will define a cistern to be a non-portable concrete tank that is built on-site, is buried or partially buried (using the earth to help support its walls and bottom), and is completely covered (which distinguishes it from a reservoir). By this definition, little or no sunlight reaches the water in a cistern. With proper screening the water is not accessible to anything larger than a gnat except through an access hatch.

fused with a tank designed to store water.

Open tanks. Tanks that serve only to store water are usually "open" to the atmosphere. This category includes cisterns or steel tanks because, in fact, they're only covered, not sealed against atmospheric pressure. A tank that stores water should

always be equipped with a vent pipe, which permits free movement of air into and out of the tank as the water level falls and rises.

Tanks that are completely buried in the ground are most susceptible to air-flow blockage, but it's an easy situation to remedy—a vent pipe may be attached at either the input or the out-

FIGURE 8:

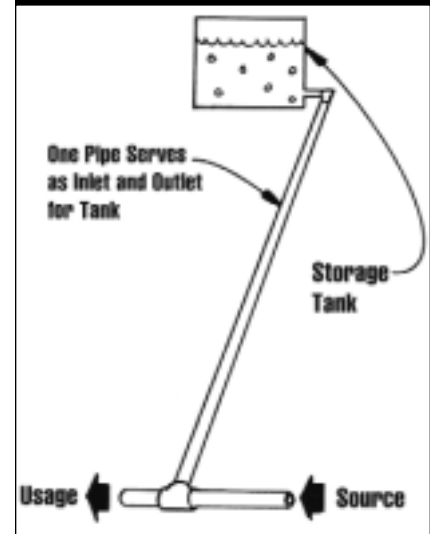

A tank may share the same pipe for inlet and outlet.

put pipe. Luckily, this can double as an overflow pipe. Since some systems may normally route tank overflow to some other use, i.e., gardens, orchards, pools, and other tanks, it may be wise to isolate the two functions so that there's no risk of blockage.

Tank plumbing. Typically, a tank (hereafter also meant to include cisterns and reservoirs) has the inlet pipe at the top and the outlet pipe at the bottom. This follows from the days when wind-powered water pumping extracted the water from wells and transferred it directly to storage. However, insofar as pressure is related to the depth and not the quantity of water, it will make no difference to the pumping (and extraction) equipment if the water inlet to the tank is located at the bottom instead of the top. Either way, the water gets to the storage tank. It's actually easier to pump water into the bottom of the tank. At low tank levels there's a few feet less head for the lift pump to push against. As the tank approaches its maximum level, this difference is negligible.

One distinct advantage of locating the inlet pipe at the base of the tank may be for the inlet and outlet to share

the same pipe. This is very situational but it avoids duplication and cuts pipe costs in half. Where there is a potential for gravity flow (pressurization), this little trick cuts in half the length of pipe needed to do the job (Fig. 8). The idea of combining the inlet and outlet causes some confusion about operation. What happens when water is being used at the same time water is being extracted and transferred to storage? How can the water flow up and down the common pipe at the same time?

The answer is simple. It doesn't. When the supply rate from the source is greater than the usage rate, all of the usage water comes directly from the supply (Fig. 9). The remainder of the supply water is pumped to storage. When the supply rate is lower than the usage rate, all of the supply water goes toward usage and the remainder comes from storage. As confusing as it may seem, the water knows what to do. Variation in supply or usage

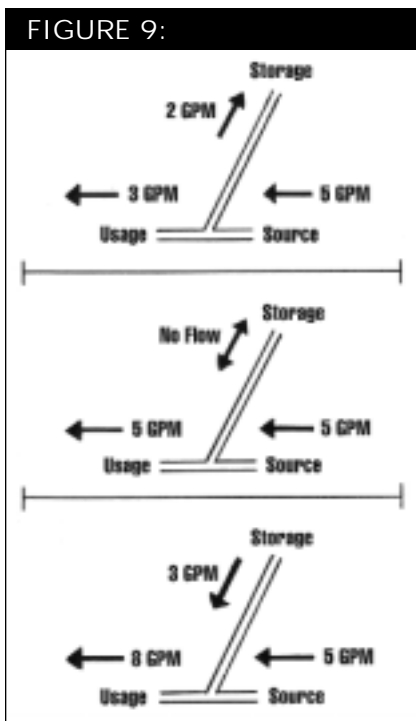

Water always knows which way to go in a variable flow.

SIDEBAR F: THREE TECHNIQUES OF EXTRACTING WATER

There are three techniques of extracting water: hauling, induction, and pushing.

1. Hauling. Hauling implies capturing, lifting, and dumping the water for immediate or eventual use. This includes techniques such as buckets pulled up by ropes, the use of a mechanical lever (the hand-cranked winch over an open well), or a mechanical conveyance system. For anything other than very small water needs or small distances, this method tends to be labor-intensive. It may be practical if a renewable source of energy, such as water or wind power, is available.

2. Induction. Water may be extracted by induction, or suction, which utilizes the natural forces of both gravity and atmospheric pressure in producing a vacuum (Fig. 12). If you evacuate the air from a pipe with its lower end submerged in water, atmospheric pressure will push the water up the pipe. This is similar to sucking soda through a straw. The better the vacuum, the higher the water will rise.

Extracting water by suction is limited to the amount of force exerted by atmospheric pressure. At sea level this amounts to a limit of 32 (vertical) feet for a perfect vacuum. Since we can't generate a perfect vacuum, the practical limits of suction are about 25 feet. With each thousand feet above sea level, this

value decreases by another foot. At 7,000 feet, then, the practical value of suction is about 18 feet (25 feet minus 7 feet).

Elevating water by suction is limited to the type of pump that is able to generate a vacuum or is able to hold its "prime." The smallest air leak in the pipe will nullify the lifting of water by suction.

One offshoot of extraction by induction is the siphon. Most of us, at one time or another, have had to use a siphon hose (otherwise known as an Oklahoma credit card) to extract gasoline from a car's tank. Those who have tried this and failed are usually in violation of one very important rule of the siphon: once started, the outlet of the hose (or pipe) must be lower than the level of fluid at the source. Also, if the fluid level drops below the pipe's inlet, air will enter the system and stop the siphoning effect. To avoid constant priming, a faucet may be added. This will limit the extraction flow rate to something less than the source's own capacity.

3. Pushing. Most water systems use the "push" technique for extracting water. Here, pumps collect the water and force it upward. If the pump's outlet is open to the air, you get a fountain. Confine the forced water to the inside of a pipe, and the water will rise upward to some higher point in the pipe.

rates produces no detectable or undesirable effects.

There is one potential problem in using the common pipe idea: the lift pump in the system may "leak." This would allow backflow out of the storage tank when not in operation. Theoretically, it doesn't but experience says otherwise. Pumps wear and their seals may leak. If the pipe that

connects the source to storage enters the tank at the top, the only water "lost" back into the well is that which is in the delivery pipe. Where the inlet pipe is situated at the bottom of the tank, the loss could be all of the water in the tank. There is a simple solution to this problem—a check valve. Use a

continued on page 31

gravity type (not a spring type) check valve. In placing it at the outlet from the well, you ensure that no water will be lost back into the well from pipe or tank. At fifteen to twenty dollars in cost, the check valve is cheap insurance against backflow.

Tank Cleanout. The tank outlet is rarely located in the very bottom of the tank. Indeed, it is about 6 to 12 inches up the side. Why? Operate the system for a while, then drain the tank and you'll have the answer! The polite name for all of that gunk and muck coating the bottom of the tank is sediment. How did it get there? An open tank or a poorly covered one will always allow dirt, leaves, insects, lizards, and mice into the water system. Also, the incoming water may carry its own sediment, held in suspension. In the tranquil waters of the tank, this will precipitate out. Some minerals in the water itself will, upon contact with air, precipitate out in a storage tank. Locating the outlet up the side of the tank a wee bit, then, will always result in this accumulated debris.

Whatever the source, provide some means of ridding yourself of this accumulated debris. The simplest setup is to install a cleanout plug in the lowest part of the tank. Then, when it's time, you drain the tank. Better yet, let it drain through normal usage after shutting down the refilling system. Then, remove the plug. If the tank bottom isn't designed to drain like a bathtub or isn't tilted to ensure removal of all refuse littering the bottom, remove the plug while the water level in the tank is still high. This will flush out the debris.

While this technique works, I prefer an additional feature in a storage tank access. With reservoirs and open top tanks this is already provided. Covered or buried tanks should include an access hatch. If you can squeeze your body into the tank, you can be absolutely certain the bottom is clean. A bonus is a visual confirma-

SIDEBAR G: PUMPING CAPACITY

In a water system the precise capacity of any pump may be established by asking three questions.

1. How much water must we lift?
2. How high do we want to lift it?
3. How fast do we want to lift it?

The relationship between these three factors—how much, how high, and how fast—may be equated to another standard: horsepower. One horsepower equals 33,000 foot-pounds per minute. If 33,000 pounds is lifted one foot in one minute's time, one horsepower has been demonstrated. If one pound is lifted 33,000 feet in one minute's time, that's also 1 horsepower. If 330 pounds is lifted 100 feet in one minute, that's still 1 horsepower's worth of work. In working with water, we're used to dealing with gallons, so let's convert the formula.

One gallon weighs 8.33 pounds. 33,000 foot-pounds per minute divided by 8.33 pounds will lift 3,962 gallons of water a vertical distance of 1 foot.

If we do it in one minute's time, it only consumes 1 horsepower. If we round off this figure to an even 4,000 gallons of water per minute per foot and change nothing else, then 1 horsepower will lift:

400 gpm through a head of 10 feet.

40 gpm through a head of 100 feet.

4 gpm through a head of 1,000 feet.

For flow rates in the 4 gpm range, it won't take much horsepower to lift water some pretty hefty distances.

Beware! These figures represent water horsepower only. No allowance has been made for any losses. These figures assume frictionless pipe, a 100 percent pump efficiency, and a perfect conversion of the energy (from whatever source) into the mechanical motion required by the pump mechanism.

In most instances, we must multiply the calculated water horsepower by at least a factor of two or three to compensate for pump efficiency, gas engine inefficiency, and pipe losses.

tion that the sediment level is getting a bit thick. There are other advantages in having some access wall scrubbing, checking on water turbidity, water level detection, help in removing accumulated debris, and repainting of the interior walls. Access demands control. A hatch with a child proof locking mechanism is the minimal requirement.

Overflow. Any type of pump used to store water in an open tank is said to be pumping into an "open head." Therefore if the water leaving storage does not keep up with the water coming in, the storage tank may overflow. This is not such a serious event, but it can be messy. Can it be avoided? Yes—prevention is one possibility. It requires, among other

things, some means of detecting the presence of overflow. Better yet, put unintentional overflow to some practical use.

Sizing storage: The amount of normal usage, source capacity variance, energy availability, emergency needs, favorable terrain all affect the sizing of water storage. How much is needed? You're one step closer to the answer once you've sketched the preliminary design and selected primary and secondary water and energy sources.

Water extraction

While it's handy to have the water source on the same level as or above the usage point, many people are not

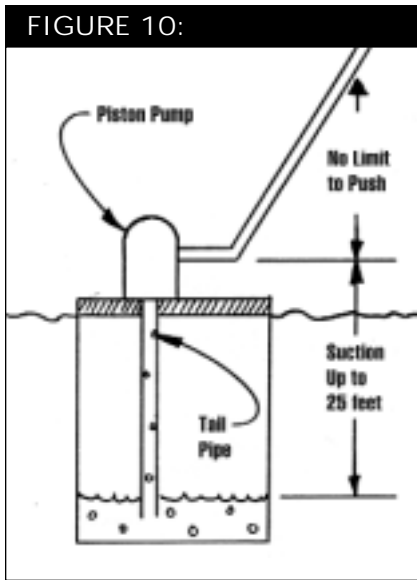

Suction allows water to be drawn up into a pump.

so fortunate. When the water is at the bottom of a hill or at the bottom of a well, the water must be extracted.

There are basically three ways to extract water: hauling, induction, or pushing (Sidebar F).

Some types of force pumps combine several of these extraction techniques in normal operation. For example, the shallow well pump is mounted as high as 25 feet above a water source. In operation, it sucks water up through its inlet pipe and then pushes it to a much higher elevation (Fig. 10). Another force pump, the deep well

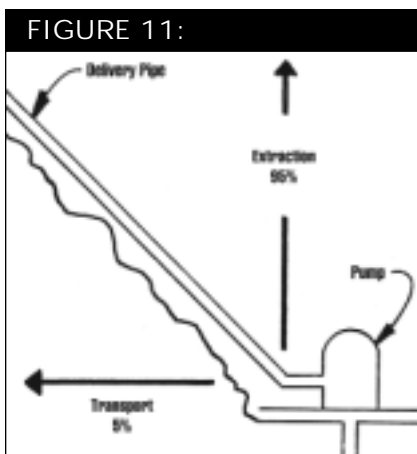

Transport of water uses less energy than extraction.

piston pump, is technically able to use all three extraction techniques—suction, lift, and push—in one cycle of its operation. Other types of pumps (jet and centrifugal) use only one extraction technique under the best of conditions.

The lift pump: As previously defined, extracting water is distinguished from both transporting and pressurizing water in that it involves only the vertical component of water processing—moving water straight up. A pump that will force water upward may be called a lift pump to help distinguish it from a pressurizing pump. That’s important, because for all practical purposes you couldn’t tell them apart—they’re both force pumps. In real life, a pressurizing pump will lift water and a lift pump will pressurize water. However, a pressurizing pump’s principal job is to pressurize water for use. Transporting it is simply a byproduct. On the other hand, a lift pump’s purpose is to extract water. This may be to get it out of the well (a purely upward motion) or up a hill. It will probably include some horizontal transport as well (Fig. 11).

There are pumps that do all three things—extract and transport and pressurize. As we shall soon see, the requirements of these pumps are quite different from those of pumps that work simply to extract water.

A pressurizing pump fights only pipe resistance. A lift pump must fight pipe resistance and gravity. A lift pump, therefore, must pump harder and faster to overcome the opposition. But how much pressure do we need to fight gravity?

One of the two major ratings of any lift pump is how much pressure it will develop. For each foot of height that we want to raise water, we will need a pump pressure of .433 psi. A 10-foot raise requires 4.33 psi. A 100-foot raise requires 43.3 psi.

Pumps don’t just “make” pressure. A pump produces pressure at some

particular rate of flow. Use it in different situations and within limits, it will supply different rates of flow. In a way, we can say that it trades off pressure for flow rates. The higher the pressure (the head) into which it must pump, the less the flow. So, in addition to the pressure needed to combat gravity and losses, all pumps must add service pressurization (Fig. 12).

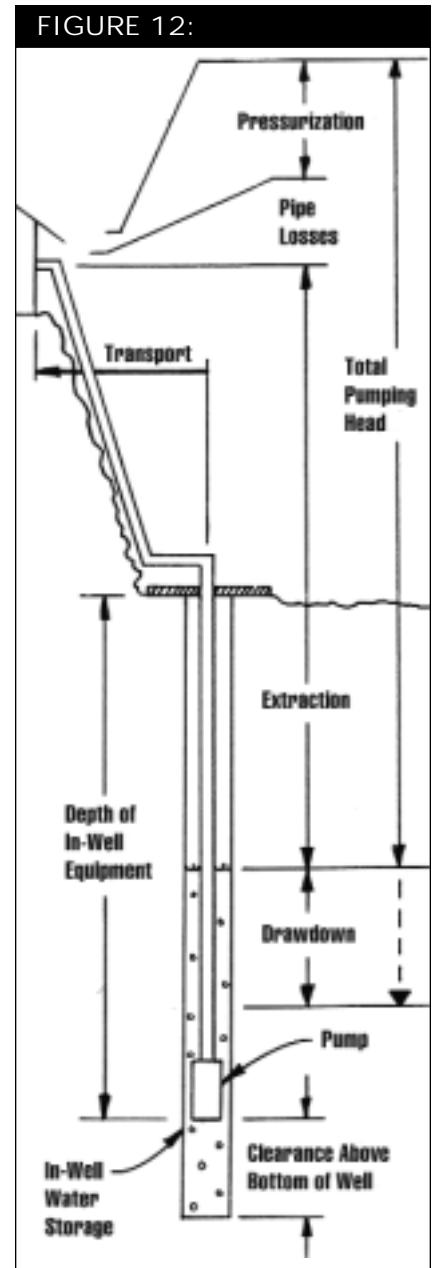

The dynamics of water processing.

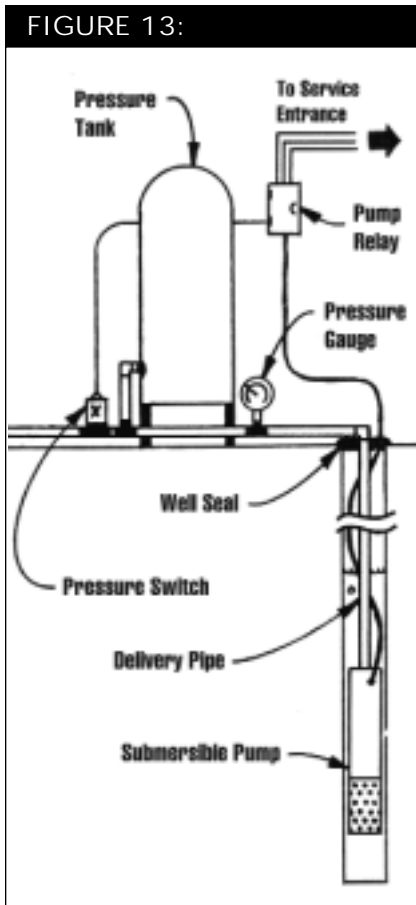

Standard components of the demand-type system.

Water horsepower: A really good way to get a feel for the dynamic state of water extraction is to look at the energy requirements. Lifting water is akin to lifting weights. Depending on your muscular build, you could lift a small weight from the floor to a point over your head in a certain period of time. Lifting a larger weight through the same distance would probably take you longer. The range of weights is unimportant. The essence here is that each of us has a built-in capacity for work. The same goes for pumps. They have design limits. It doesn't matter what type of energy source is connected, they can still only handle a specific work capacity. And as in human weight lifting, we're working with three

things: weight, distance, and time (Sidebar G).

Water extraction and energy: It takes energy to extract water. Let's review the issues:

1. For any flow rate, we need a certain amount of energy to push the water against both gravity and pipe resistance. Double that flow rate and the energy required is double the original value plus the additional energy required to combat the fourfold increase in pipe resistance.

2. If higher flow rates result in higher energy requirements and increased pipe resistance, that also means that lower flow rates will need less energy and suffer lessened pressure losses.

3. It is true that if we pump water at a smaller flow rate, we must also pump longer to get the same total amount of water to the same elevation.

Extracting water quickly prohibits the use of some energy sources which simply cannot produce energy at a high rate. Systems capable of producing energy in smaller amounts can get all of the water to the desired elevation but will simply require more time. The effect of pipe resistance is almost eradicated at lesser flow rates, so slow pumping has a greater overall efficiency for the water pumped. Only with a well installation is the lift pump pushing water straight up. If, instead, it pushes the water through a pipe up a hillside at some angle of slope, a horizontal component or transport is also involved.

Final comments: Even though I have separated the functions of water processing into extraction, transport, storage, and pressurization, the two basic types of water system—demand and store—frequently combine these functions in operation.

The demand system is inactive except when water is required. Then, when the system turns on, one pump does everything—extraction, transport, and pressurization (Fig. 13). While it may be convenient, it is inefficient since the pump requires a rate

of energy usage that represents the largest rate of water flow (in gpm) needed in the system. Even at very small flow rates, then, the pump uses energy at a rate that may be 5-10 times the amount required to handle the specific need.

The store system separates the functions that are necessary at the water source from those required at the usage site (Fig. 12). In this setup, extraction and transport of water from the source may be tailored to source capacity without ignoring the widely varying needs—pressure and flow rates—of the usage point. The buffer that performs this minor miracle is storage. If storage can be sited high enough above the usage site to make gravity pressurization possible, the extraction head is only slightly increased. If storage is too low for gravity pressurization, a small pressurizing pump may be added. Either way, the overall energy needs and efficiency of a store system is a fraction of that required for a demand system.

Preview: In the next issue of *Backwoods Home Magazine*, we will look more closely at the variety of tanks that may be used in a water system, the ratings and installation of pumps, water system accessories, and examples of both the demand type and store type water systems.

(Michael Hackleman is the author of seven books on do-it-yourself renewable energy topics. For a current publications list, send an SASE to P.O. Box 327, Willits, CA 95490.) Δ

The Cutting Edger of Bandmill Technology
 Ask About Financing
 800-743-5039
 www.sawmill.net
 Western Sawyer - The only bandmill that makes edge and width cuts in same pass!