

Spiral Pumps – How to make
General non-powered pump reference.

<http://www.builditsolar.com/Projects/WaterPumping/waterpumping.htm>

<http://www.earthgarden.com.au/waterwheel.html>

Spiral Water Wheel Pump

This pump uses a rotating pipe coil to pump water. It requires only moving water to power it.

The pump in the picture pumps 400 gallons per day to a tank 50 ft above the pump.



Low-impact lifestyle extraordinaire, John Hermans, devised and built a water wheel for Earth Garden's writer and forest campaigner, Jill Redwood. Jill can now refill her water tank from the Brodribb River near her farmhouse in Victoria's East Gippsland. Her water wheel is silent, pumps about a litre a minute, goes 24 hours a day, has only one small moving part, and works on an ancient principle. Here John describes how to build one.

by John Hermans

Clifton Creek, Victoria.

AS I have no political lobbying or media skills my way of helping the environment campaign is to help those committed to saving forests. My skills lie in the areas of inventing and building. Jill had a 5 hp fire fighting pump she used to refill her concrete water tank every fortnight or so. I first devised an alternative pump using a set of water wheels, which, via chains and cogs that gave a 4:1 step up, drove a small piston pump.

The petrol pump was temperamental and noisy. This improved model was temperamental and oily. It did work quite well but was prone to occasional mechanical failure and there was the possibility of it leaking oil into the pristine Brodribb River. So I got to work on an idea I had seen illustrated as a kids' toy. As Jill lives on the upper reaches of the Brodribb River, the small flow in the river was not enough to operate a hydraulic ram pump. The spiral water wheel has the advantage of being environmentally friendly, almost maintenance free, made of basic cheap materials and is relatively easy to make for anyone with a welder.

This positive displacement pump is made from a single length of coiled poly pipe and is designed to be powered by water. The pipe is coiled in a vertical plane and mounted on a horizontal axle. As the paddles rotate the coil of poly pipe above the water, the lower part is immersed. The open end of the coil takes a small 'gulp' of water every time it rotates. An alternating sequence of air and water is

driven along the pipe towards the centre of the spiral. Successive coils of pipe lead to a cumulative increase in the pump's pressure output. When a land-fixed pipe is connected to the last and smallest coil, then water can be shifted to a higher point, such as a dam or a tank. In this case, Jill's tank is about 16 metres above the river.

Paddles and coils

The set of undershot paddle wheels (powered from water flowing below, not from water dropping onto the wheels from above) drives the whole show. This is one of the oldest and simplest forms of motor, driving one of the oldest and simplest forms of pump. The whole unit consists of only one small rotating part called a rotating joiner, or in plumber terms, a spinning nipple.

When assembling the coils on the spokes of the frame, I had no idea how many coils and at what diameter was needed to pump the water to the 16 metre head. The water wheel ended up about two metres in diameter. As the water wheel and the spiral both needed to dip into the water, the coil has to be the same diameter as the paddles.

Three quarter inch (19 mm) poly pipe can be coiled down to about 500 mm in diameter before it starts to kink. If the coils are kept close together, around 40 coils can be made. I decided to make two lots of coils consisting of 20 coils each, so there were two openings to take a 'gulp'. In theory this should have pumped twice the volume of water as a single coil rotating at the same speed. However, this proved to be too heavy for the flow of the stream to move, so I had to remove one coil of pipe. As Jill's place is three hours drive away, there was much guesswork involved in my workshop and redesigning on site.

The final coil design saw 50 metres of three quarter inch (19 mm) poly pipe coiled into 20 loops from 2 metres to half a metre diameter. The pumping rate at this site is about one litre a minute but varies from season to season.

Figuring it out

My theory then is that to successfully pump water, the coiled pipe needs to be about three times as long as the height it is being pumped to. That's a 3:1 ratio. I assumed that the size of the pipe is less important than the total length. Larger loops are more effective at forcing water up than small loops but consume more length. Fewer larger loops may be just as effective as many smaller loops.

The water exiting the smallest coil in the centre is piped into the hollow shaft of the water wheel's axle. The end of this then joins a stationary water pipe near the bank, in this case connected to a boom arm (described below). To join the rotating shaft to the fixed poly pipe, a joiner is needed that can spin constantly. Unless the connection is perfectly in line, these watertight rotating joiners can wear out quickly.

To avoid flood damage to this water wheel pump, I mounted the axle and bearings onto a three metre boom of 100 mm RHS that pivots at the end anchored to the bank. Along this boom, a height adjustable support is set into the bank. A steel cable is attached to the water wheel that is operated by a winch fixed even higher up the bank (see illustration). Not only does this allow it to be cranked out of the water if a flood is imminent and hoisted safely above flood height, but it also allows the water wheel to be lowered or raised to match the high and low flows of the river.

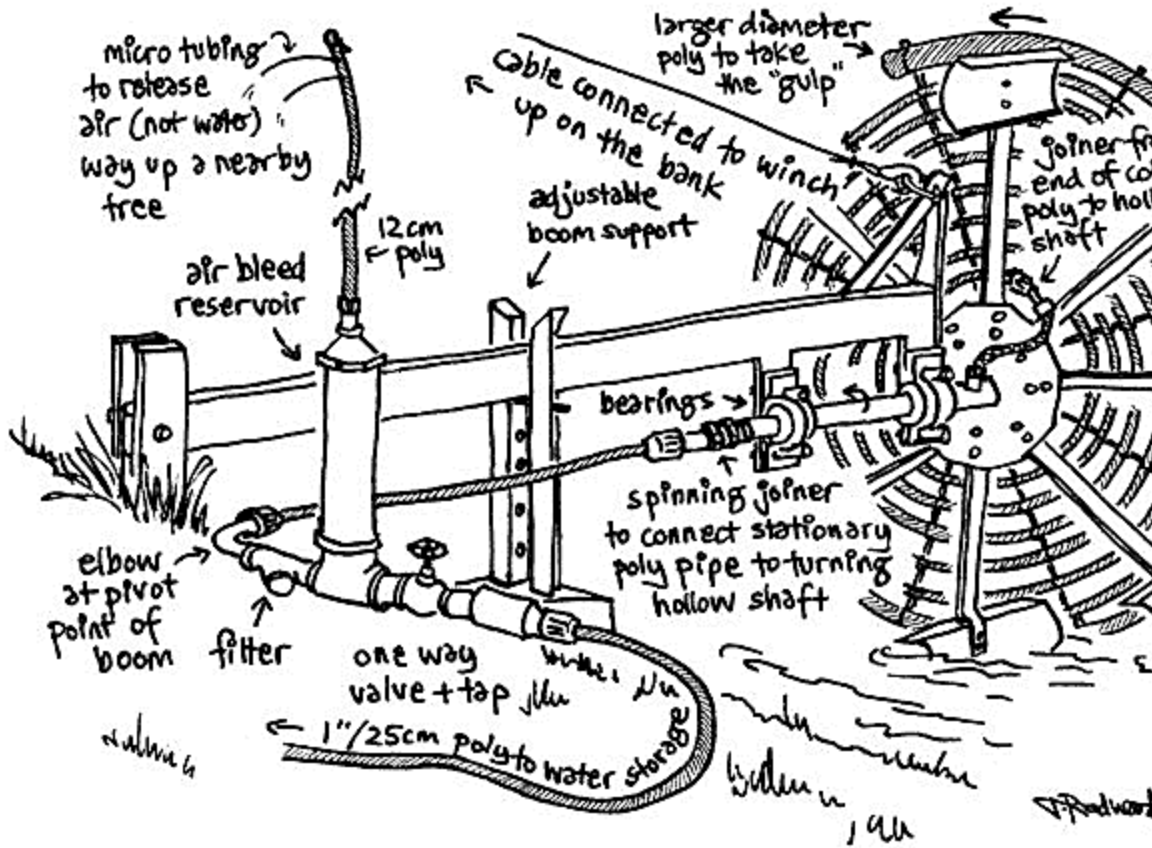

The spiral water wheel replaced a noisy and temperamental petrol pump.

Construction pointers

Here are a few more pointers to help with constructing the coil section. To attach the poly pipe to the angle iron spokes, use 1 mm stainless steel wire (you can order it from engineering suppliers). The end of the three quarter inch poly pipe that scoops up the water should be increased in diameter for the last loop. I used one inch (25 mm) for half a loop and then one and a quarter inch (32 mm) poly pipe for the last half a loop. This allows for greater volume to be scooped up each rotation.

As both water and air are pumped up the delivery line together, it is best to send the pumped water directly to the storage tank or dam. If the inlet and outlet line to the tank are the same, a special air bleed line close to the pump will be needed, as Jill discovered when trying to use the taps on the same line or have a shower!

A one-way valve will also need to be set in the line to stop water draining back out when the wheel is not pumping. A filter isn't a bad idea either. You can also fix a fly wire guard to the inlet end of the coil that also reduces debris from entering the system.



One modification that had to be made over the last couple of years has been a more robust and reinforced hollow shaft. The constant flexing and movement of the water wheel, especially with faster flows, stresses metal and any weak spots are soon discovered. The water wheel was sited on a slight bend in the river where it was narrow and the water had a higher velocity.

Variables that allow this design to pump effectively are:

- river flow
- size of paddles
- number of paddles
- diameter of the wheel
- diameter and number of the coils
- submergence of the coils
- inlet pipe diameter
- height of storage tank/dam.

This spiral pump was a direct replacement of a small standard piston pump and has proved to be just as efficient at pumping a set volume per day.

Overall, it's a beautiful piece of alternative technology. And Jill says it also doubles as relaxation therapy: after a torrid session dealing with planet wreckers, sitting by the river watching it quietly turn puts some equilibrium back into the soul.

<http://www.builditsolar.com/Projects/WaterPumping/waterpumping.htm>

The Spiral Pump

A High Lift, Slow Turning Pump

By Peter Tailer, TailerP@aol.com

80 Lyme Road, Apt 318
Hanover, NH
03755
U.S.A.

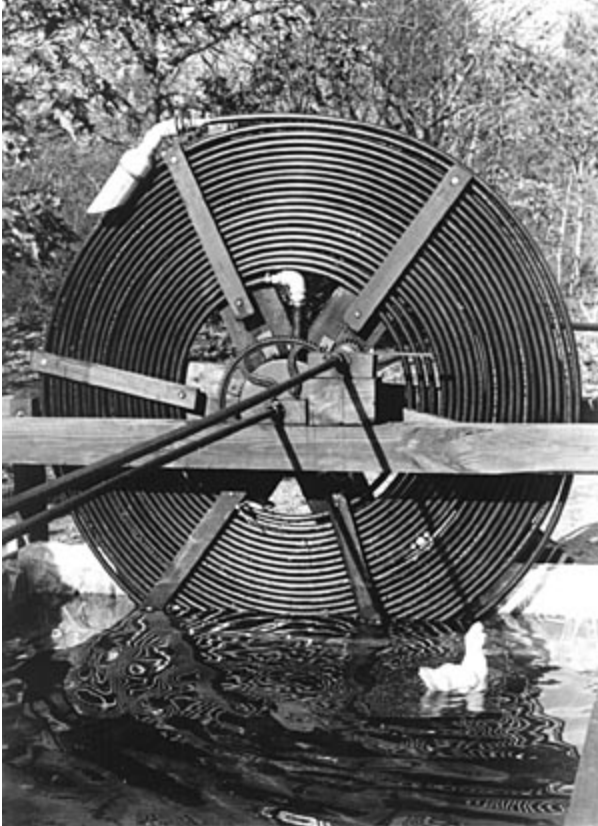

Summary: A spiral pump, first invented in 1746, has been recreated and tested at Windfarm Museum using lightweight and inexpensive modern materials. A 6 foot diameter wheel with 160 feet of 1-1/4 inch inside diameter flexible polyethylene pipe is able to pump 3,900 gallons of water per day to a 40 foot head with a peripheral speed of 3 feet per second. With its low torque requirements, the pump is particularly suited to be mounted on and driven by a paddle wheel in a current of two feet per second or greater. This easily built, low maintenance spiral pump can be used to provide water without the need for fuel wherever there is a flowing stream or river. It can also be hand turned or otherwise driven to provide a low cost, efficient pump.

Table of Contents

- [History of this Document](#)
- [History and Theory of the Spiral Pump](#)
- [Construction](#)
 - [Wheel and Spiral](#)
 - [Rotary Fitting](#)
 - [Testing Apparatus](#)
- [Testing Procedure](#)
- [Test Results](#)

- [Discussion](#)
 - [Flow Over](#)
 - [Blow-back](#)
 - [Air Lift](#)
 - [Coil Design](#)
 - [Pump Efficiency](#)
- [The Inclined Coil Modification](#)
- [Conclusion](#)

History of this Document

First distribution 1986.

Additions 1998 and 1990.

OCR scan and conversion to HTML by Chris Pirazzi, chris@pirazzi.net, 2005.
Please report any typos or errors to both chris@pirazzi.net and
TailerP@aol.com.

Internet address of this document: <http://lurkertech.com/water/pump/tailer/>

There are other interesting documents about water-powered water pumps at:

<http://lurkertech.com/water/>

which readers of this document may also find interesting.

History and Theory of the Spiral Pump

In some instances, records of preindustrial technology can be a source of concepts which can be updated with modern materials and modified to be utilized in today's technology transfer efforts. In recent research, Peter Tailer, curator of the Windfarm Museum on Martha's Vineyard, Massachusetts, uncovered a two hundred and forty year old invention that has great potential as a low cost, low technology pump for certain situations. This invention is the spiral pump created in 1746 by H.A. Wirtz, a pewterer of Zurich, Switzerland.

Wirtz invented the spiral pump to provide water for a dye works just outside of Zurich. Little is known about the inventor or the circumstances that led him to create the pump. He probably was aware of the tubular form of the Archimedes screw and the Persian wheel. Both of these pumps had existed for hundreds of years. They were low lift rotating pumps which could not raise water higher than the pump structures themselves. As Wirtz was a pewterer, he would have

possessed the metal working skills necessary to form a tubular spiral. It is most likely that the dye works were located on the Limmat River, a tributary of the Rhine, where the pump was powered by either a water wheel or horse whim.

The Wirtz spiral pump was constructed so the end of the outside pipe coil opened into a scoop. The inner coil led to the center of the wheel where it joined a rotary fitting at the axis of the machine. Figures 1 & 2 show an historical reference's representation of the pump. This was taken from *A Descriptive and Historical Account of Hydraulic and Other Machines for Raising Water* by Thomas Ewbank, edition of 1849, New York City.

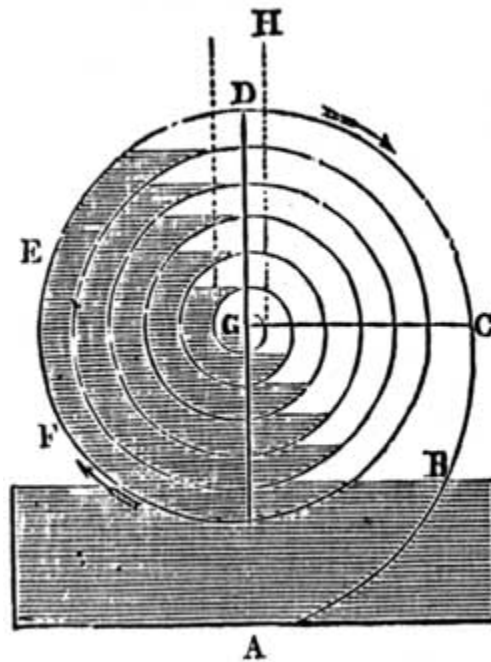

Figure 1: Historic Wirtz Pump—1842 drawing

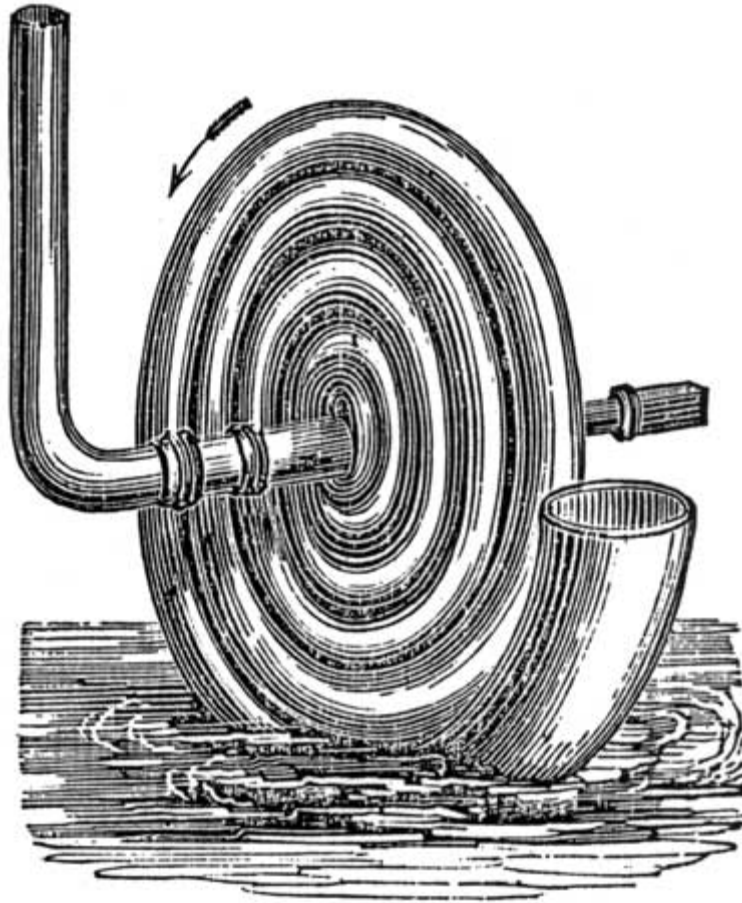

Figure 2: Historic Wirtz Pump—1842 drawing

The Wirtz pump was constructed so that, with each revolution of the spiral, the scoop collected one half the volume of the outer coil. As water was taken into the coils, each column of water transmitted the pressure through the air to the preceding column of water. In this way the water in each coil was displaced to provide a pressure head. A cumulative head was built up at the inner coils and was conveyed through the rotary fitting to an ascending delivery pipe.

Ewbank reports these pumps to have been highly successful and states they were used in Florence as well as Archangelsky in the later part of the 18th century. In 1784, a machine in Archangelsky is recorded to have raised "a hogshead of water in a minute to an elevation of seventy-four feet, through a pipe seven-hundred-sixty feet long." Lead or sheet metal was probably used to fabricate the coils, which must have made the machine extremely heavy. Problems encountered with the weight are mentioned as well as the general unwieldiness of the larger machines. These slow turning, cumbersome pumps became obsolete with the development of high speed steam engines.

An ideal Wirtz pump would follow Boyle's pressure-volume relationship and the coil volumes would change with respect to changes in the entrapped air volumes. Tubing of uniform diameter would not be formed as a spiral or as a helix. This was understood by Olinthus Gregory in his work entitled *Treatise of Mechanics*, edition of 1815. Gregory states on page 230 of Volume I that, "If, therefore, a pipe of uniform bore be wrapped round a conic frustum...the spirals will be very nearly such as will answer the purpose. It will not be quite exact[,] for the intermediate spirals will be rather too large: the conoidal frustum should in strictness be formed by the revolution of a logarithmic curve. With such a spiral the full quantity of water which was confined in the first spire will soon find room in the last, and will be sent into the main at every rotation. This is a very great advantage, especially when water is to be much raised."

Gregory also described spiral pumps formed as a huge clock-spring-like spiral sandwiched between two wood disks. This construction would allow the cross-sectional area of the coils to be varied so that a spiral pump could be built with the correct volume in each successive coil.

The above cited 1849 work by Ewbank stated that he was not sure of the relative advantages of the spiral or the helical Wirtz pump, the helical pump having coils of the same diameter. The limits of the helical pump can be approximated. If the inlet coil takes in half its volume in both air and water, when maximum pressure is developed by the helical pump, the final cumulative pressure head in the discharge coil will be substantially equal to the coil diameter. Coils towards the inlet coil will develop heads of decreasing pressures as air in the successive coils is compressed to a progressively lesser extent. After a large number of helical coils, the pressure head in the inlet coil will approach zero. Water will occupy the bottom half of the inlet coil and water will be displaced by pressure to the inlet side of the outlet coil. Thus the cumulative volume change of air trapped in the inlet coil will substantially approach one half when this air reaches the outlet coil. This cumulative reduction in volume can only provide an outlet gauge pressure of one atmosphere, so that a helical Wirtz pump can apparently only pump to a limiting head of 54 feet.

While this may be a sufficient head for many purposes, Windfarm Museum built a spiral Wirtz pump to evaluate the potential to reach higher pressures and pump to high heads.

In considering the idea of building a spiral pump, we theorized that if cumulative heads build up a pressure of one atmosphere (14.7 psi or 34 feet of water), the volume of air in that coil will be compressed to one half its initial

volume. However, the water in that coil is incompressible and occupies its original volume. Thus, in theory, the length of the coil where the pressure reaches one atmosphere should be 3/4 the length of the first coil if the first coil takes in half its volume of water and half of air with each revolution. If the innermost or discharge coil is one half the length of the first coil, a theoretical evaluation would indicate that it would be completely filled with water.

However, Ewbank stated that, when compressed air and water occupied more than the volume of an inner coil, the water "will run back over the top of the succeeding coil, into the right hand side of the next one and push water within it backwards and raise the other end." This caused a succession of flow back over the tops of the coils ending with a dumping of the excess and a lessened intake at the scoop. This can only take place in a spiral pump where the volume of the coils decreases to the extent that some coils cannot accommodate water and compressed air passed into them. The Windfarm spiral pump was built with the diameter of the inner coil about one half that of the outer coil. This was done so that a spiral of a given outer diameter could accommodate more tubing of a given diameter to provide greater cumulative heads and pump to the greatest height possible.

The possibility that Wirtz pumps constructed of modern materials could be used in specific situations in developing countries motivated the Windfarm staff to build and test a working model. The model was constructed under the direction of Jonathan West who also designed the testing procedure.

When built with modern lightweight and inexpensive plastic pipe, the spiral pump can be mounted on and driven by a paddle wheel. For pumping to low heads, the spiral pump is quite satisfactory. However, when higher heads are required, the spiral pump can be used to provide water for a home, a village, a fish farm, or small scale irrigation. This simple machine can be site built and maintained by relatively unskilled users.

Since first completing this report, two projects came to our attention. First was an article in a quarterly publication entitled *Waterlines*, Intermediate Technology Publications Ltd., 9 King Street, London WC2E 8HW, UK. In Volume 4, No. 1, of July, 1985, there was a report on pages 20-25 of a Danish Guide and Scout Association project on the Nile near Juba in Southern Sudan. This project used raft-mounted, paddle-wheel-driven, helical Wirtz pumps for irrigation. Each pump had four sets of 2" ID (52mm) tubing which was wound on a float-mounted drum which was paddle wheel driven to pump to a head of 13'4" (4 meters). These pumps were reported to be very successful pumping to this head.

The second Wirtz pump project was brought to our attention by Peter Morgan of the Blair Research Laboratory, P.O. Box 8105, Causeway, Harare, Zimbabwe. Peter Morgan was probably the first person to build a Wirtz pump after it was forgotten and lost for more than a century. His account of its re-invention follows as it is not only interesting, but helpful in understanding the device:

The spark of the idea jumped when I was adjusting a pipe carrying a gas from a biogas digester we had installed beneath a toilet at the Henderson Research Station near Mazowe. The tank had developed at least one cubic meter of methane, but I could get no gas out of the end of the pipe which led from the digester to the stove nearby. I remember being annoyed by this as it was obvious that a type of airlock had developed in the pipe leading gas from the tank to the outside.

We looked down the toilet hole and I noticed that the pipe had become coiled several times. This was possible because we had allowed quite a lot of pipe to be used to accommodate the up and down movement of the digester gas tank. In earnest I pulled hard on the pipe whilst looking straight at the end of it. The pulling of the pipe released the airlock and I got a facefull of very bad smelling mess and gas. Pulling the pipe had released the airlock and gas now flowed freely outward.

From that moment I wondered what could have been going on down there. It was obvious that fluid produced by the digester had built up at the base of the coils to produce airlocks. These had, in effect, held back the gas produced by the digester. I wondered whether the reverse might be true. Could one coil a pipe up, which contained a number of deliberately made airlocks, and develop pressure?

On a later visit to Henderson with my good friend, Peter Gaddle, Blair's Chief Field Officer at the time, we came across a length of clear plastic pipe laying on the ground. Recalling the experience with the digester, I picked up the pipe and coiled it vertically in my hands with the innermost coil turned to the horizontal and then turned upward to form a vertical segment.

I asked Peter to carefully pour water down the vertical pipe. Water passed over each spiral of the tube into the next spiral and then into the next. A series of airlocks had been formed in the pipe. As more coils had water and airlocks form in them, the level of the water standing in the vertical segment became higher. I rotated the whole spiral tube in my hand and, to my joy, water shot out

of the top of the vertical pipe segment above the spiral! This was a most memorable and thrilling experience for Peter and me.

I couldn't wait to get home and make a bigger version of the model in my kitchen. This too worked well and I found that by adding water to one end of the spiral and rotating it, I could drive water up the vertical pipe segment some distance.

The day following Peter and I built a two meter diameter model at Henderson and fitted it to a waterwheel with paddles attached. The paddle wheel was mounted in a small water channel. The wheel turned and on each turn I arranged for the outer coil to pick up water from the channel. On each turn a core of water followed by a core of air passed into the spiral next to it until finally arriving at the innermost coil. It was the led to a rising pipe through a simple water seal. The effect was thrilling as the system worked so well. Water was fed into a tank and the machine worked for years afterward.

I then developed a horizontally opposed spiral pump with two water inlets and two coils feeding to a single outlet. This doubled the volume of water produced. From this we then built a much bigger 4 meter diameter wheel on the Mazowe Citrus Estates canal. This pumped an impressive 3697 liters of water per hour to a height of 8 meters above the canal. After two or three years, only the wheel was rebuilt of stronger materials where it remains today as reliable as when first built. Several other wheels have since been built in Zimbabwe.

Peter Morgan's work with the Wirtz or spiral pump has been published in a local Zimbabwe science magazine, "Science News", in the United-States-based VITA (Volunteers in Technical Assistance) News of January, 1983, and in a Blair Bulletin of 1984.

Construction

Wheel and Spiral

When considering the building of a spiral pump, we assumed that the pressure produced would be directly related to the wheel diameter and the number of coils. After some deliberation, a six foot wheel was built. It was felt that a smaller wheel with proportionately smaller coils might not provide high enough pressures for a realistic evaluation of working sized machines.

Two different pipe sizes were used to form coils on the wheel to provide a broader range for the tests. The first series of tests were performed on the wheel

with the coils formed from 160 feet of 1-1/4 inch ID flexible polyethylene pipe (rated 100 psi at 73°F). This configuration is shown in Figure 3:



Figure 3: Front view of Wirtz pump

The outside coil was formed on the circumference of the six foot wheel. Each successive coil was wound closely within the outer coil to maintain the largest possible diameter for all the coils. This provided thirteen coils with the radius of the outer coil being 36 inches and the radius of the innermost coil being 17 inches. Another series of tests was performed on the wheel with coils formed from 280 feet of 3/4 inch ID flexible polyethylene pipe (rated 100 psi at 73°F). A photograph of this wheel is shown on the cover. This was wound with the outer coil 36 inches in radius and the innermost coil 16 inches in radius to provide a total of twenty-one coils.

The wheel itself was built in a six spoke fashion with a double thickness of 1 x 8 planking. A 1-1/2 inch hole was drilled in the center of the wheel to allow passage of a pipe leading from the innermost coil to the rotary fitting. See Figure 4:



Figure 4: Back view showing rotary fitting

A 1 inch steel shaft provided a cantilevered support for the wheel by means of a fabricated hub. The shaft was welded to a 12 inch diameter 1/4 inch thick steel plate. Six 3 x 3 x 1/4 inch pieces of angle steel were cut 1 1/2 inches long and welded to the plate at equal spacings to provide brackets to fix the hub to the wheel. The stand-off provided by the brackets allowed the pipe from the innermost spiral to pass behind the plate and, with a 90° connector, extend through the hole in the center of the wheel.

Rotary Fitting

The rotary fitting, while it is easily fabricated, is a critical part of the spiral pump. It must provide a relatively watertight seal to prevent fluid and pressure loss. An exterior view can be seen in Figure 5 and a detailed drawing with all of the parts indicated and described is shown in Figure 6:



Figure 5: Close-up of rotary fitting

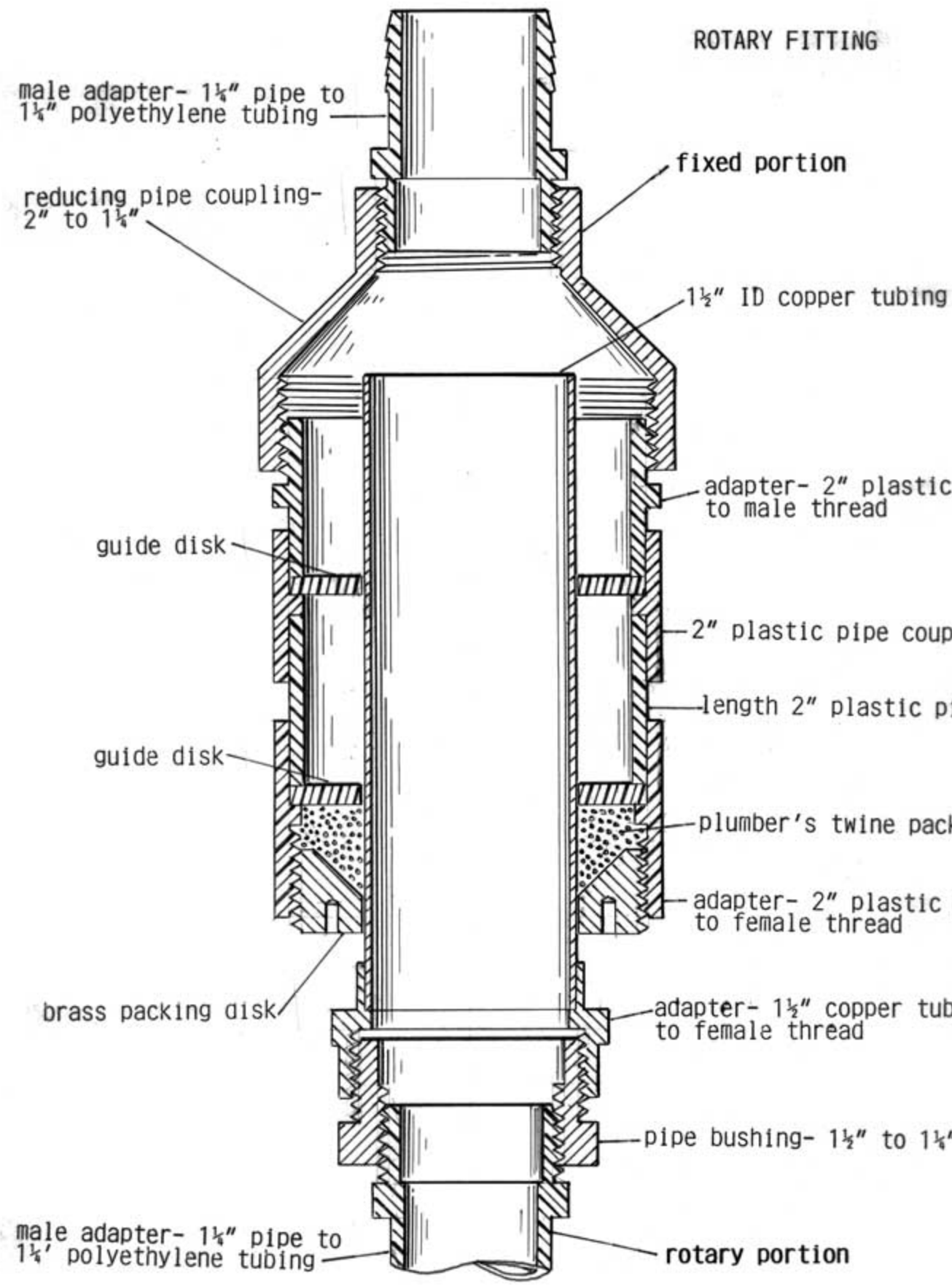

ROTARY FITTING

male adapter- 1 1/4" pipe to 1 1/4" polyethylene tubing

fixed portion

reducing pipe coupling- 2" to 1 1/4"

1 1/2" ID copper tubing

adapter- 2" plastic to male thread

guide disk

2" plastic pipe coup

length 2" plastic pi

guide disk

plumber's twine pack

adapter- 2" plastic to female thread

brass packing disk

adapter- 1 1/2" copper tub to female thread

pipe bushing- 1 1/2" to 1 1/4"

male adapter- 1 1/4" pipe to 1 1/4" polyethylene tubing

rotary portion

Figure 6: Longitudinal section through rotary fitting

The rotating portion of the fitting was formed by connecting a 6 inch length of 1-1/2 ID copper pipe to the polyethylene extending through the center of the wheel. The copper pipe was used as it provides a good bearing surface for the packing.

The fixed portion of the rotary fitting was constructed from 2 inch ID rigid plastic polyvinyl chloride (PVC) pipe and pipe fittings. The first element of the housing entered by the copper pipe is a brass disk which retains packing. This packing disk was made from a 2 inch brass threaded pipe plug which had been drilled and filed for a clearance fit around the copper pipe. A pair of small shallow holes (not through holes) were drilled on each side of the large opening transfixing the copper pipe. This pair of holes allowed a special wrench with two projecting pins to be used to turn the disk. The brass disk was screwed into an adapter for 2 inch plastic pipe to female thread. Since the brass disk retains and compresses packing, it greatly helps to form an inwardly sloping 45° chamfer or bevel to urge packing towards the rotating copper pipe.

Two guide disks were fabricated from flat plastic stock obtained from 2 inch PVC threaded pipe plugs. The centers of the guide disks were drilled and filed to provide a clearance fit for the 1-1/2 inch copper pipe. The outer edges of the disks had the threaded portion of the plugs filed away so that their OD would match that of 2 inch PVC pipe. A guide disk was inserted on the far side of the inner annular dividing ring of the female adapter. A short length of 2 inch plastic pipe was inserted and glued in the adapter to clamp the first guide disk in place. A 2 inch coupling was then glued at the other end of the short pipe length.

The second guide disk was inserted in the coupling against its inner annular dividing ring and an adapter for 2 inch plastic pipe to male thread was glued in place to secure it. A 2 inch to 1-1/4 inch reducing pipe coupling was placed on the adapter to receive a 1-1/4 inch male adapter for polyethylene pipe.

The seal of the rotary fitting was formed by a packing of plumber's twine between the copper pipe, the first guide disk, and the brass disk. The brass disk was slipped on the copper pipe and then the soft cotton packing was wound around the pipe in the direction it was to rotate. At this point the brass disk was tightened. It was found necessary to securely clamp the non-rotating portion of the fitting to the test stand and the tubing of the rotating portion to the wheel in

order to keep pump pressure from forcing the elements of the rotary fitting apart.

Any equivalent rotary fitting construction may be used.

Testing Apparatus

The pump stand or mounting frame was built so that the Wirtz spiral pump could become a permanent operating exhibit and teaching tool when set in a lake at Windfarm Museum. For this reason the wheel was placed at one end of an eight foot long stand so that, when it was in the lake, it would be able to be turned from the shore. The wheel was rotated by a gear and pinion having a 4.5 to 1 ratio. The drive gear was bolted to the hub and the pinion was fixed on a raised shaft parallel to the drive shaft. The pinion shaft was turned by a hand crank offset 12 inches from the shaft. All bearings on the apparatus were oiled oak block.

For the early testing, a small water tank 7x2 feet was constructed beneath the wheel using wooden planking and a single 4 mil polyethylene sheet draped within for a seal. A weir was notched in the tank and used in conjunction with a running garden hose to maintain a constant water level. For later tests, a larger 7x9 foot tank was built so that pumping during a series of tests did not significantly change the water level.

In order to gather information on the actual height to which the pump could deliver water, the discharge was directed up a nearby 70 foot windmill tower. See Figure 7:



Figure 7: Pump, scoop, and test tower

At each test head, or level to which the water was being pumped, a catchment system was set up that allowed the discharged water to be directed into or out of a bucket with control lines operated from ground level. The catchment bucket funneled the discharge into a drain pipe which led to measuring containers below. A pressure gauge, a purging valve, and a delivery pipe shut-off valve were also installed in the system at the base of the tower. See Figure 8:



Figure 8: Pressure gague and fitting at base of test tower

To measure the torque required for pumping, a rope and a 50 lb. spring scale were used. The rope was attached to and wrapped around the circumference of the wheel and led over a pulley placed on the test stand. This allowed the pulling of the rope to directly turn the wheel by exerting a force tangent to its circumference. This apparatus is shown in Figure 9:



Figure 9: Torque test apparatus

Testing Procedure

Three groups of tests were carried out to determine the parameters of the spiral pump. The first tests were performed to determine the capacity of the pump at different speeds. The second group of tests were performed to determine the effect of different sizes of scoops. The final group of tests were carried out to

determine the relationship between the size and number of coils with respect to the actual heads to which water could be delivered.

The initial tests to determine the pump discharge with respect to its rotational speed measured discharge while varying the revolutions per minute (rpm) from two to twelve over three minute intervals. The wheel for these tests mounted the coils of 1-1/4 inch ID tubing described above. The scoop for these tests was of 3 inch ID pipe 22 inches long.

The first tests showed the positive displacement nature of the spiral pump as the water delivered remained fairly constant with different wheel speeds. This indicated that the tests on the scoops of different capacities could be made at a single selected rpm. The historical references suggested that the scoop be sized so that one-half the volume of the outer coil is collected with each revolution of the wheel.

The second tests were also carried out using the 1-1/4 inch ID tubing coils mounted on the wheel. The scoops were of 3 inch ID plastic pipe and had their open ends cut at an angle so that they were level with the water upon exiting. The effective scoop lengths were 1, 12, 22, and 36 inches. Scoop length was measured from the square cut end to the center of the angle cut. Discharge and torque measurements were made at heads of twenty and forty feet for all the scoop sizes.

The torque was measured by attaching the 50 lb. spring scale to the rope wrapped around the periphery of the wheel and pulling in a steady manner. Twelve readings were recorded at equal intervals over two revolutions.

The third group of tests were made with the wheel mounting coils of the 3/4 inch ID pipe described above. Water was pumped to 40 and 60 feet with output and torque measured.

An additional pump/no-pump test was carried out at 80 feet using an extension attached to the top of the tower. It was not possible to set up the catchment system at this level to measure output.

Test Results

The results of the first series of tests are shown listed in Figure 10:

H = height pumped = 40' Length 3" ID scoop portion = 22"
 RPM = speed of wheel Rev = revolutions of wheel
 F = force in pounds exerted at wheel circumference
 W-out(ft-lb) = work out = Discharge(gal) x H(ft) x 8.34 lb/gal
 W-in(ft-lb) = work in = force(lb) x distance(ft)
 = F(lb) x Rev x wheel dia.(ft) x π
 Efficiency = W-out / W-in

RPM	Rev	Dis. (gal)	Force (lb)	W-out (ft-lb)	W-in (ft-lb)	Eff. %	Press. (psig)	Flow (gal/m)
2	6	3.67	26.1	1224.3	2950.5	41	18.0	1.22
3	9	5.42	26.1	1808.1	4425.6	41	18.0	1.81
4	12	7.33	26.1	2445.3	5900.4	41	17.0	2.44
6	18	10.92	26.1	3642.9	8850.6	41	16.5	3.64
8	24	14.67	26.1	4893.9	11800.8	41	16.0	4.89
12	12	8.08	26.1	2695.5	5800.4	45	15.5	8.08

Figure 10: Outputs at different speeds

These tests found the Windfarm spiral pump to be a positive displacement pump.

Figure 11 graphs the wheel speed vs. the pump output:

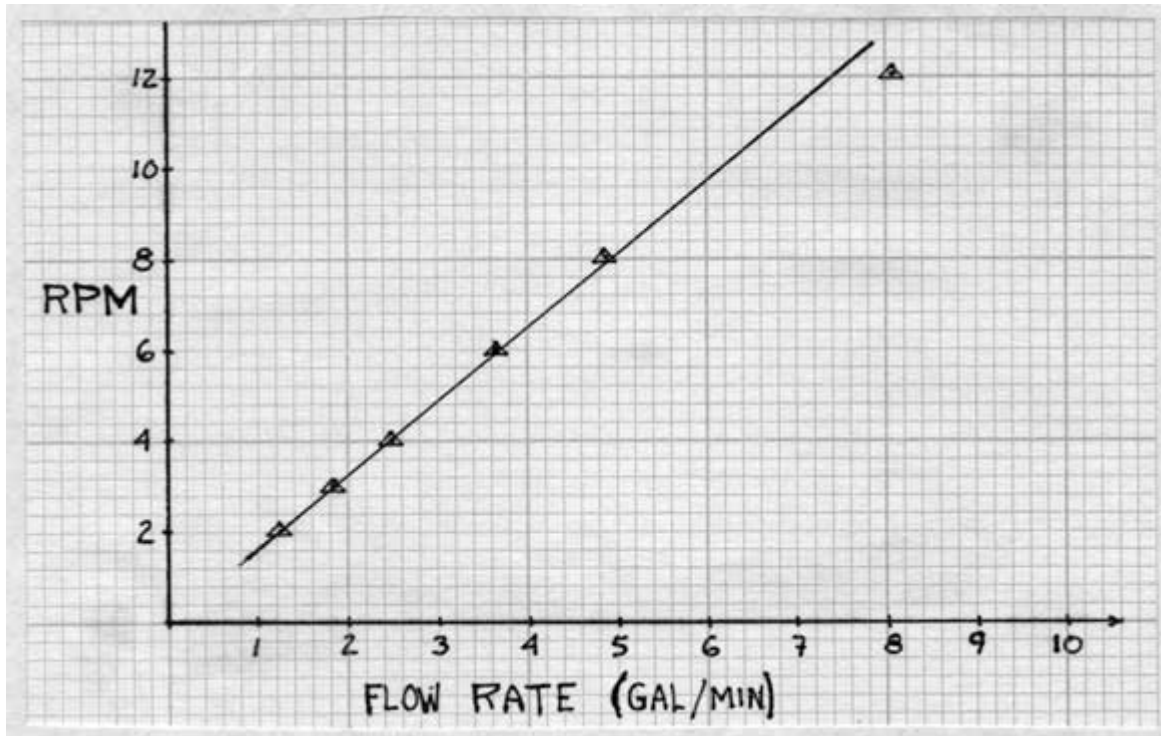

Figure 11: Flow rate and speed

The output and torque measurements for different scoop sizes are shown in Figure 12:

Pump turned nine turns @ 3 RPM

L-sc = length in inches of 3" ID scoop portion

Dis. (gal)	Head (ft)	F (lb)	L-sc (in)	W-in (ft-lb)	W-out (ft-lb)	Eff. %	%Volume (1st coil)
5.58	40	28.1	36	4764.6	1862.6	39	85
5.75	40	26.1	22	4425.5	1918.2	43	75
5.67	40	24.5	12	4154.2	1854.8	45	62
3.88	40	20.2	1	3425.1	1294.4	37	36
6.12	20	16.2	36	2746.9	1021.8	37	85
6.39	20	18.5	22	3136.9	1065.9	34	75
5.85	20	15.9	12	2696.0	974.1	36	62
4.41	20	14.9	1	2566.4	735.6	29	36

Figure 12: Scoop lengths, outputs, and efficiency

The output and torque measurements for the 3/4 inch tubing are shown in Figure 13:

RPM	Rev	Dis (gal)	Head (ft)	Press (psig)	W-in (ft-lb)	W-out (ft-lb)	Efficiency %
2	20	3.75	60	25.0	4860.7	1876.5	39
4	20	3.75	60	23.5	4860.7	1867.5	39
5	20	3.50	60	23.5	4860.7	1751.4	36
6		--blowback--					
2	20	4.75	40	17.0	4031.8	1584.6	39
4	20	4.50	40	16.5	4031.8	1501.2	37
6	20	4.50	40	16.0	4031.8	1501.2	37
8	20	4.40	40	15.5	4031.8	1501.2	37
10	20	4.50	40	15.0	4031.8	1501.2	37
12	20	4.50	40	15.0	4031.8	1501.2	37

Note: Length 3" ID portion scoop = 5"; immersed length 3/4" tubing also acting as a scoop = 36".

Figure 13: Data for 3/4" tubing spiral

Discussion

The results of the first group of tests performed on the Windfarm spiral pump show it to be a positive displacement pump at low speeds. As long as the wheel turned at all, there was output. For the larger size pipe the machine also performed well at the maximum speed tested, 12 rpm. It actually had a 4 percent increase in efficiency at this higher speed (this higher calculated efficiency could be due to our inability to measure the actual torque input at the higher speeds where air lift may have decreased pumping pressure). In addition, the pump was turned at the highest speed possible with the described gearing, 16 to 18 rpm, and it continued to pump. The maximum wheel speed for this wheel would appear to be not much greater than 18 rpm as this speed causes considerable disturbance when the scoop enters the water. Any higher speed would probably result in a decrease in efficiency.

The results of the speed tests on the smaller, 3/4 ID tubing show a greater limiting effect. The maximum pumping speed at a 60 foot head was 5 rpm. At speeds greater than this, pumping ceased due to a disruption of the flow in the coils. This condition was labeled "blow-back" (discussed in detail [below](#)).

The smaller tubing was found to perform well at wheel speeds up to 5 rpm at the 60' head and up to 10 rpm at the 40' head. The efficiency was calculated to

be about 39% for all of the operating speeds. A 1.5 psi drop in pressure was discovered between 2 and 5 rpm, from 25 to 23.5 psi. This is believed to be due to the air lift effect in the delivery pipe (discussed in detail in the [Air Lift](#) section below).

The tests on the scoop sizes done on the 1-1/4 ID coils found the suggestion of the historical references that the scoop collect one half the volume of the outer coil to appear to be accurate. The volume collected by a scoop is the sum of the volume of the 3 inch diameter scoop and the volume of the immersed and water-scooping portion of the outer coil which was about 30 inches. As may be seen in Figure 12, at the 40 foot head the 12 inch scoop filling 62% of the outer coil was 2% more efficient than the 22 inch scoop filling 75% of the outer coil. The 36 inch scoop filling 85% of the outer coil was 6% less efficient than the 12 inch scoop and the 1 inch scoop that filled 36% of the outer coil was 8% less efficient.

At the twenty foot head the 36 inch scoop filling 85% of the first coil was 1% more efficient than the 12 inch scoop filling 62% of the first coil. This may be explained because, at the lower head and pump pressure, the losses due to the friction in the machine require a larger percentage of the total pumping torque.

Flow Over

During the tests a rush of water could be heard flowing from inner coils backward to outer coils. This verified Ewbank's 1849 indication that this flow took place. The flow appears to take place only when the inner coils have insufficient volume to contain the compressed air and water passing to them. Although it must reduce pump output, it is not certain to what extent this internal flow influences the characteristics of the spiral pump. It may maximize the effect of the air columns or cumulative heads of the inner coils. As suggested by Gregory in 1817, a spiral pump could be designed to minimize or eliminate this internal flow. The extent that such a design may result in a higher pump efficiency remains to be investigated.

Blow-back

Blow-back occurs when the pump pressure exceeds the cumulative pressures of the coils. The blow-back pressure is the pressure at which this occurs. This pressure can be determined for each wheel configuration by closing the valve on the pump output and pumping until there is a sudden drop in pressure and a surging of water and air back through the scoop. During the Windfarm tests,

blow-back happened under different conditions for the two pipe diameters tested.

Blow-back was found to occur at lower wheel speeds for the smaller diameter pipe of 3/4 inch ID. At 60' blow-back took place at 6 rpm whereas, at 80', it happened at 5 rpm. This was probably due to the larger friction factor for small diameter pipes. There was no blow-back encountered at slower speeds. Blow-back also did not occur after stopping the wheel, allowing it to stand, and then resuming pumping. In addition, for these smaller diameter pipe coils if the wheel was oversped and blow-back occurred, the machine was able to resume pumping when turned at normal operating speeds. This indicated a self-starting capability.

For the larger diameter pipe of 1-1/4 inch ID, the pump was found to be more sensitive at low wheel speeds. For heads up to that indicated by the blow-back pressure, the pump operated well at all speeds. When the head was higher than blow-back pressure, blow-back was encountered at very low wheel speeds or after stopping and then restarting. At these heads the air lift effect apparently had to play a larger role. At the 60 foot head, it was necessary to purge the system by reducing pump output pressure by opening the valve at pump level before it was possible to start pumping. On starting to pump to 60 feet, a wheel speed greater than 2 rpm had to be maintained. In addition, if the wheel was stopped from a higher speed and allowed to stand, on restarting the pump, blow-back would occur. This could be explained because, in the 60 foot high, 1-1/4 inch delivery pipe, air was able to bubble up more easily through the water. On resumption of pumping not enough air was introduced into the delivery pipe with the standing water to reduce pressure below that which causes blow-back.

Air Lift

The very principle that allows this pump to create columns of water within its coils, that of alternately taking in air and water, also acts to increase the delivery head. The air, which is compressed as it moves toward the center of the wheel, expands as it goes up the delivery pipe, producing a lift effect on the water. Testing proved this effect by showing that the actual head reached was greater than that indicated by the pressure gauge in the system. The air lift effect was most evident when pumping to heights greater than those indicated by the blow-back pressure.

The air lift effect was found to vary for the two pipe diameters tested. For example, the 3/4 inch ID pipe coils pumped water to 60 feet using a 1/2 inch ID

delivery pipe operating at 23.5 psi. This pressure is equivalent to a 54.5 foot column of solid water. When the elevation was extended to 80 feet after an initial pumping pressure of 27.5 psi, the system settled to an operating pressure of 23.5 psi. By closing the valve to the delivery pipe, blow-back for this wheel configuration was found to occur at 28.5 psi. This pressure is equal to a 66 foot column of solid water. In addition, the maximum wheel speed at which pumping would occur decreased as the head increased for the smaller diameter coils. At 60 feet, a speed of 5 rpm would allow pumping. At 80 feet, the maximum pumping speed was reduced to 4 rpm.

Wheel speed also was involved in the air lift phenomenon and was linked to blow-back. At very low speeds for the wheel with larger diameter coils pumping into the larger delivery pipe, the air was able to bubble up more easily through the water in the delivery pipe. This reduced its lifting effect and led to an increase in pump output pressure until blow-back occurred. This happened only when pumping to heads greater than water alone could be pumped at the blow-back pressure. At higher wheel speeds, air lift allowed the larger pipe to pump to heads higher than that indicated by the blow-back pressure.

The size of the delivery pipe also appeared to influence the air lift effect. With the 1-1/4 inch ID delivery pipe at 60 feet, the 3/4 inch coils pumped with a pressure between 23.5 and 25 psi. When the delivery pipe from the 3/4 inch coils was changed from 1-1/4 inch ID to 1/2 inch ID at a head of 60 feet, the initial pumping pressure was 25 psi. It then stabilized between 16 and 21 psi with continued pumping. With the larger delivery pipe the pump pressure remained high as the small air volume put out by the 3/4 inch coils did not provide much air lift.

Coil Design

A method of approximating the number of spiral pump coils for a given delivery head up to 100 feet mounted on a given size wheel has been derived using Boyle's pressure-volume law. The following assumptions have been made to arrive at this approximation. The first is that the coils are represented as a static series of pressurized interconnected u-tubes. Each tube is sized to be equal to the volume of the water (assumed to remain constant and equal to one-half the total volume of the first coil) plus that of the air. Since the air is compressible, the total volume of each respective u-tube would decrease as the center of the wheel is approached. Another assumption is that within the first coil and all the other coils, the head within each coil is assumed to be equal to the diameter of that coil. Actually, the maximum head in a given coil extends from the upper wall of the pipe at the bottom of the coil to the lower wall of the

pipe at the top of the coil. However, this assumption would give less than a 5% error in the case of the outer first coil of a six foot wheel with 1-1/4 I.D. pipe.

Knowing the pressure and the volume of the first coil (atmospheric pressure and the diameter of the wheel) and the delivery head or gauge pressure required at the n-th coil, then the volume of the n-th coil, which is its head or diameter in this simplification, can be determined. With the diameter of the n-th coil, the number of coils can be determined by assuming that the average head between the first and the n-th coil multiplied by the number of coils will give the total head. When designing a spiral pump, a 20% margin should be added to the determined coil number. This margin will help account for different pipe diameters and other variables.

For design of a spiral pump:

$D = h_1$ = wheel & outer coil diameter and the outer coil head

H = delivery head n = number of coils

d = pipe diameter h_n = head in n-th coil

Boyle's Law : $P_1 \times V_1 = P_n \times V_n$

$P_1 = P_{atm} + D$ V_1 = air volume first or outer coil

$P_n = P_{atm} + H$ V_n = air volume last or inner coil

$V_1 = \pi \times (\frac{1}{2}d)^2 \times D$ $V_n = \pi \times (\frac{1}{2}d)^2 \times h_n$

given: H , D , & d , find h_n and n

to find h_n :

$$P_1 \times V_1 = P_n \times V_n$$

$$(P_{atm} + D) \times \pi \times (\frac{1}{2}d)^2 \times D = (P_{atm} + H) \times \pi \times (\frac{1}{2}d)^2 \times h_n$$

Therefore: $h_n = (P_{atm} + D) \times D / (P_{atm} + H)$

to find n :

$$n \times (D + h_n) / 2 = H$$

Therefore: $n = 2H / (D + h_n)$

Note: The pipe diameter, d , cancels out in the above equations. Once the number of coils required for a given wheel are determined to provide a given pressure or head, a suitable pipe size can be selected to form the coils of the spiral pump.

EXAMPLE:

given: $H = 50'$ $D = h_1 = 6'$ $P_{atm} = 34'$ of water
find: h_n and n .

$$h_n = (P_{atm} + D) \times D / (P_{atm} + H) = (34 + 6) \times 6 / (34 + 50)$$
$$h_n = 2.9'$$

$$n = 2H / (D + h_n) = 2 \times 50 / (6 + 2.9) = 11.2$$
$$n + 20\%n = 13.5 \text{ coils}$$

Compare this estimate to the Windfarm pump test results where $D = 6'$, $n = 12$, and $h(n) = 3'$. With 1-1/4 ID tubing, blowback occurred at a head, H , of 48.5' of water. With a suitable delivery pipe and output, air lift will allow pumping to a higher elevation.

Pump Efficiency

There are several losses in the Wirtz pump that affect its efficiency. Within the coil fluid flow losses are quite small. If the Windfarm pump is turning at 9 rpm, water in the outer coil is moving at about 2.8 ft/sec and in the inner coil at about 1.4 ft/sec. The average flow rate in the length of tubing is about 2.3 ft/sec, greater than the mere average of the two speeds, as more of the tubing forms larger diameter coils than smaller ones. From pipe flow tables the head loss for 1 1/4 in tubing would be about 5 ft of water. Even this small loss would be considerably reduced as the coil is not completely filled with water but has portions filled with air which has a vastly lower flow resistance.

Another small loss would result from drag as the outer coils and the scoop turn in water to be pumped. This would be low as the speed is under 3 ft/sec.

A much larger loss in the Windfarm pump coil is the result of "flow over" as described above. The inner coil can't hold the water scooped by the outer coil and the compressed air. As a result, torque which has been expended raising water on one side of the coils is lost as water runs down the other side. The efficiency of the Windfarm pump pumping to a head of one atmosphere would be greatly improved if the inner coil was 3/4 the diameter of the outer coil. The half of the volume of the outer coil of water and the half the volume of the outer coil filled with air and compressed to one atmosphere would then just fill this 3/4 diameter inner coil without flow over losses, when pumping to lower heads under one atmosphere, a helical pump is probably easier to construct and about as efficient as a spiral pump.

In the delivery pipe there are two losses which reduce efficiency, fluid flow resistance and air lift slippage. Fluid flow losses are reduced by larger diameter delivery pipes, but air lift losses are lessened by smaller diameter pipes. Conventional air lift pumps bubble a steady stream of compressed air into the bottom of a riser pipe submerged below the water surface in a well. If the weight of water and air in the riser pipe is less than that of the water above the bottom of the riser pipe, water will flow up the riser pipe to be pumped from the well. As reported in *Marks' Standard Handbook for Mechanical Engineers*, Eighth Edition, 1978, air lift pumps can have an efficiency of 50%.

As stated above, a pump pressure of 23.5 psi or 54.5 ft of water lifted water 80 ft in a 1/2 in delivery pipe. This would indicate air lift alone was lifting water an additional 25.5 ft. If we assume the work that went into lifting a solid column of water and the work compressing air were equal, then the air lift should have raised water another 54.5 ft. and the air lift efficiency of this pump is $25.5 / 54.5$ or 47%. Optimum delivery pipe sizes were not tested or the efficiency of air lift in sloping delivery pipes.

It is very possible that an optimum delivery pipe size might provide a higher air lift efficiency in a Wirtz pump as it introduces slugs of water interspersed with volumes of compressed air into its delivery pipe rather than the steady bubbling of air as in the air lift pump. This will have to be determined by experimentation. At any rate, an overall efficiency of up to 75% would be indicated for a well designed Wirtz pump.

The Inclined Coil Modification

Figure 19 shows an inclined coil Wirtz pump developed by David Hilton of 9 Rowbotham Street, Toowomba, Queensland, 4350, Australia and reported in the quarterly *Waterlines*, Intermediate Technology Publications Ltd., 9 King Street, London WC2E 8HW, UK, in the issues of July, 1987, and October, 1989:

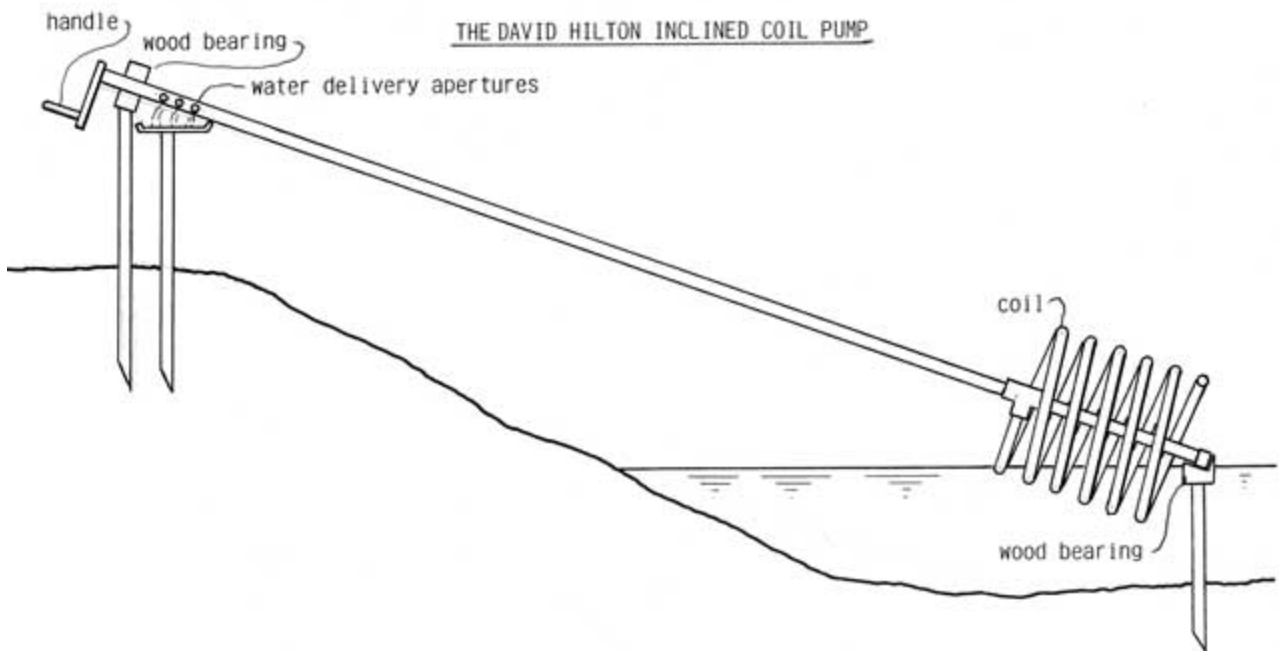

Figure 19: Inclined coil Wirtz pump

The great advantage of the inclined coil pump for low head pumping is that it does not require a rotary fitting. A length of steel pipe is mounted on simple wood bearings to incline downward into water to be pumped. A helical coil is formed at the lower end of the pipe and enters it from a pipe "T." The first coil of the helix with an open end is half immersed in water so that a scoop is not required to fill half the coil with water.

At the upper end of the pipe openings are formed through which pumped water may flow into a suitable trough. A handle may be provided to turn the pipe and its mounted coil as a unit. To increase output, a second coil may be connected to the pipe by a second "T" with its turns disposed between those of the first coil. This double helix would double output.

In Figure 19, no mounting for the helical coils is shown. Any suitable mounting may be clamped or welded to the pipe to have the coils wound about it. with a 20 ft pipe inclined about 20°, this pump can raise water to a height of 7' or over 2 meters. If desired, a paddle wheel can be mounted on the inclined pipe above the helical coil to turn the pump.

David Hilton describes an alternate construction in which a drum is fixed to extend from the lower end of the pipe. The helical coil or coils are wound around the drum and connected to the pipe. The drum floats on the water

surface. The lower end of the pipe is laterally positioned by two vertical stakes driven near the drum. This allows a rise and fall in the body of water being pumped.

Conclusion

The limited tests performed on the Wirtz spiral pump constructed at Windfarm Museum demonstrate the excellent potential of this preindustrial concept when combined with today's available technology. One of most attractive ways of powering the spiral pump is to mount it on a paddle wheel placed in a river or stream. A series of paddle wheel driven spiral pumps may be connected to a common delivery pipe for a higher volume output.

In some circumstances, hand or motor driven spiral pumps could be used to pump to high heads from canals, lakes, or very slow flowing rivers. Low maintenance and ease of construction would make a driven spiral pump a good choice compared to a piston pump.

A 6 foot diameter water wheel with 5 foot long blades 8 inches wide could be constructed of wood as shown in Figures 14 and 15:

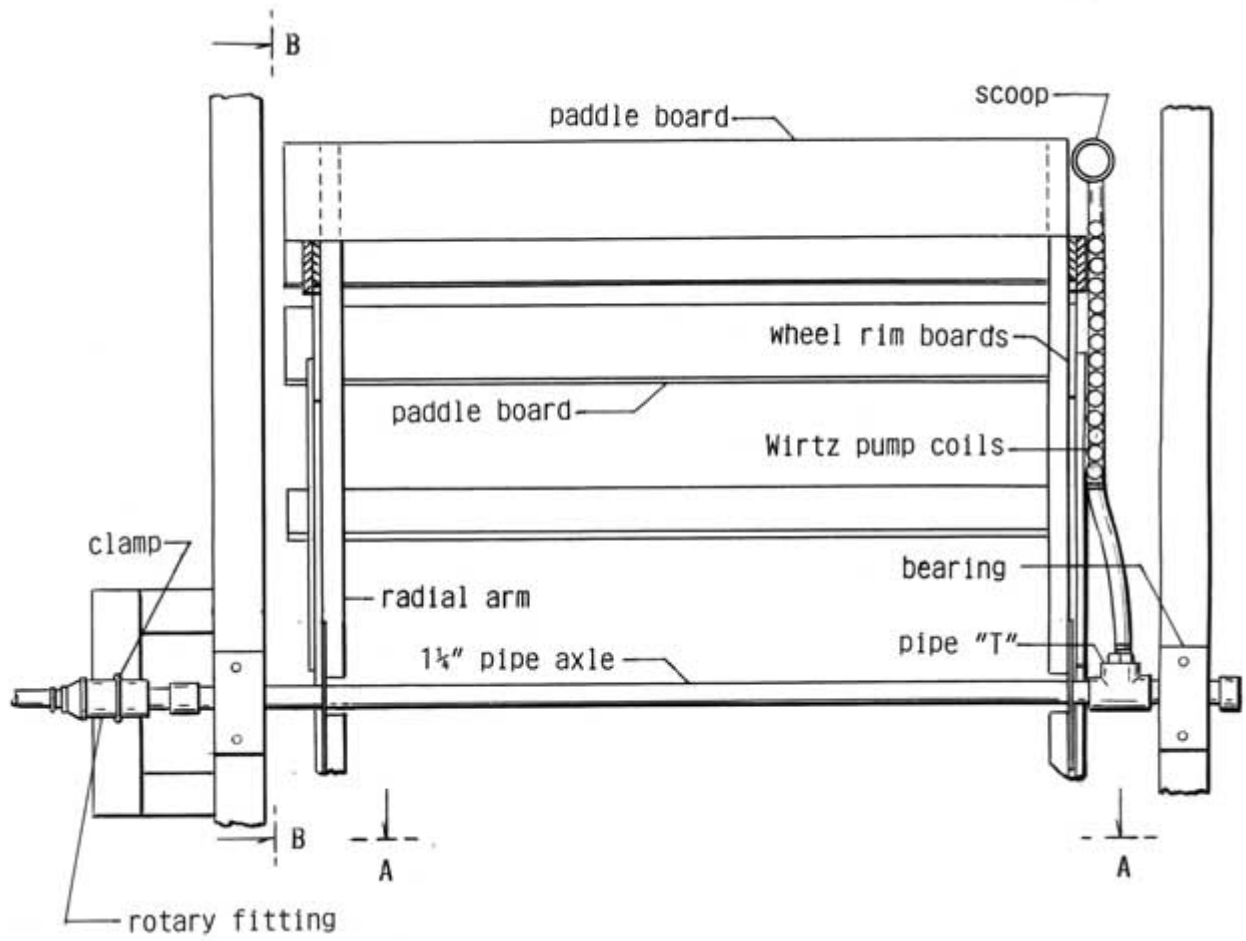

Figure 14: Top view of paddle wheel and coil pump

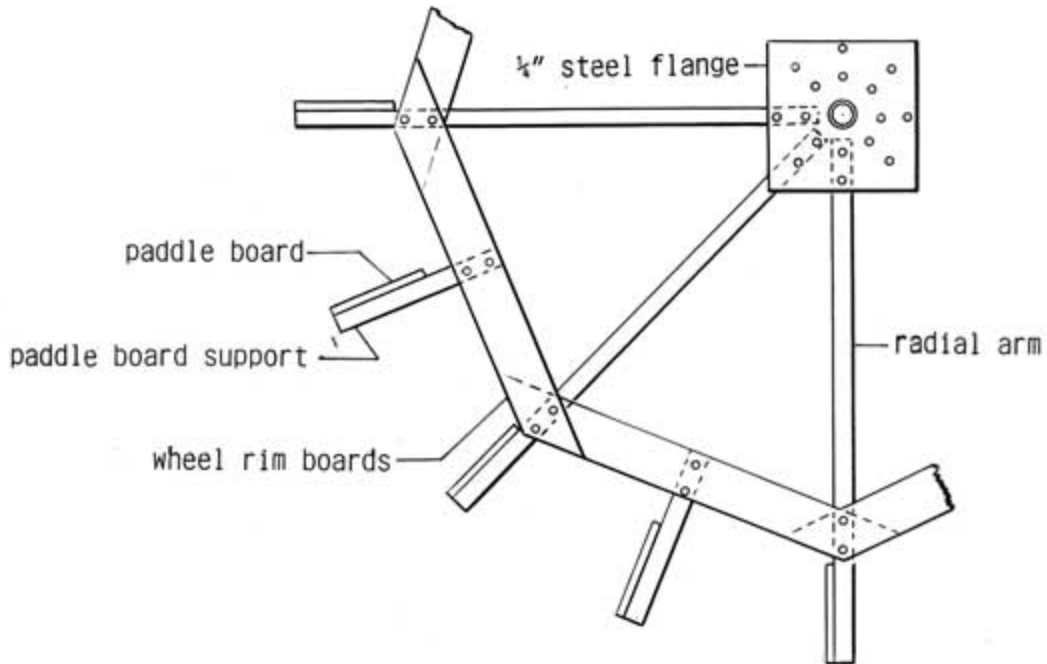

Figure 15: Side view of paddle wheel

It could use steel pipe for both the paddle wheel bearing shaft and a communication for pumped water to the rotary fitting. The wheel could be made using nominal 2 x 2 inch spokes and paddle mounts. The rims would be 1 x 4 inch boards. The bearings could be made from oiled hard wood or brass.

The cost for the material for this paddle wheel is estimated to be between \$100 and \$150. The cost of the flexible polyethylene pipe used at Windfarm was \$20 per 100 feet for the 3/4 ID and \$60 per 100 feet for the 1-1/4 inch ID (Sears 1985 Fall/Winter Catalogue).

Figure 16 shows the force on a 5 foot by 8 inch paddle according to the velocity of "slip" or the relative velocity of water to an immersed paddle:

Paddle drag test

Paddle 8 inches wide and 5 feet long.

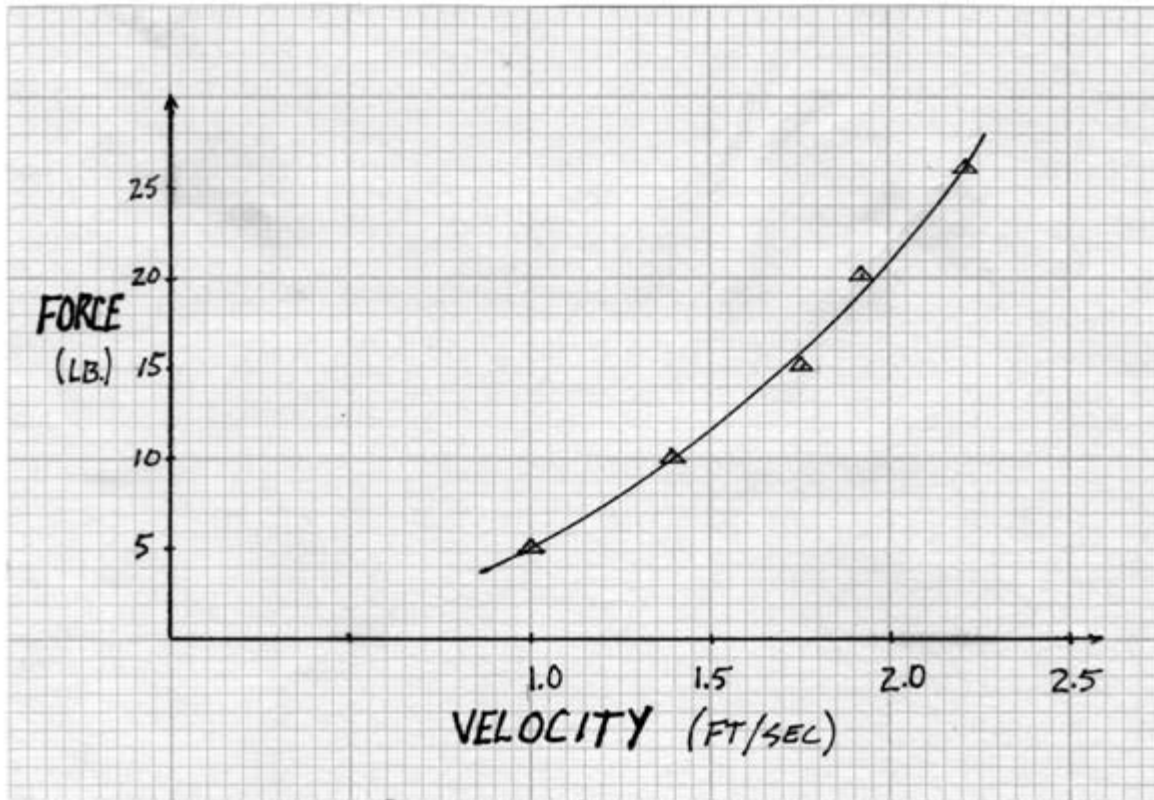

Figure 16: Paddle velocity and force

Sufficient force to turn the wheel of the Windfarm test pump mounting 1-1/4 inch coils and pumping to 40 feet is developed with a slip of less than 2.5 feet per second. The output of a paddle wheel mounted Wirtz spiral pump would be determined by the velocity of the water flow where it was mounted.

If the river or stream flow was 3.5 feet per second, the paddle wheel mounted pump would have a peripheral speed of 1 foot per second or turn at 3 rpm. It would then pump 1300 gallons a day to a height of 40 feet. If the flow driving the wheel had a speed of 5.5 feet per second, the pump would turn at 9 rpm and deliver 3900 gallons a day.

Paddle wheels turning spiral pumps could be mounted on piles with a provision to adjust them to river level changes. They could also be mounted on floating pontoons anchored in a river as was demonstrated by the Danish helical pump. Another mounting would have paddle wheels with each mounted between a pair of arms. The pairs of arms would hang from a horizontal cable extending

across the current flow. This mounting might be superior as river trash would not have piles or floats to foul. Floating trash would strike the paddle wheel and swing it upward and down stream on its arms to allow floating trash to pass.

Building and testing the spiral pump at Windfarm Museum demonstrated that the design of the pump allows great latitude. Unlike the test Windfarm pump, the innermost coil should be more than one half the radius of the outermost coil to limit internal flow over in the spiral and resulting reduced output and lowered efficiency. The formulas above can be used to roughly approximate coil design.

Many variations in Wirtz pump construction are possible. Larger and smaller diameter tubing could be connected to form a given spiral to provide volume changes as water passes from inlet to outlet coils. If the required number of coils will not fit in a flat spiral, they could be wound in parallel with two or more adjacent coils for each diameter.

To provide a comparison with similar technology presently in use, the machine of Figures 17 and 18 is pictured:

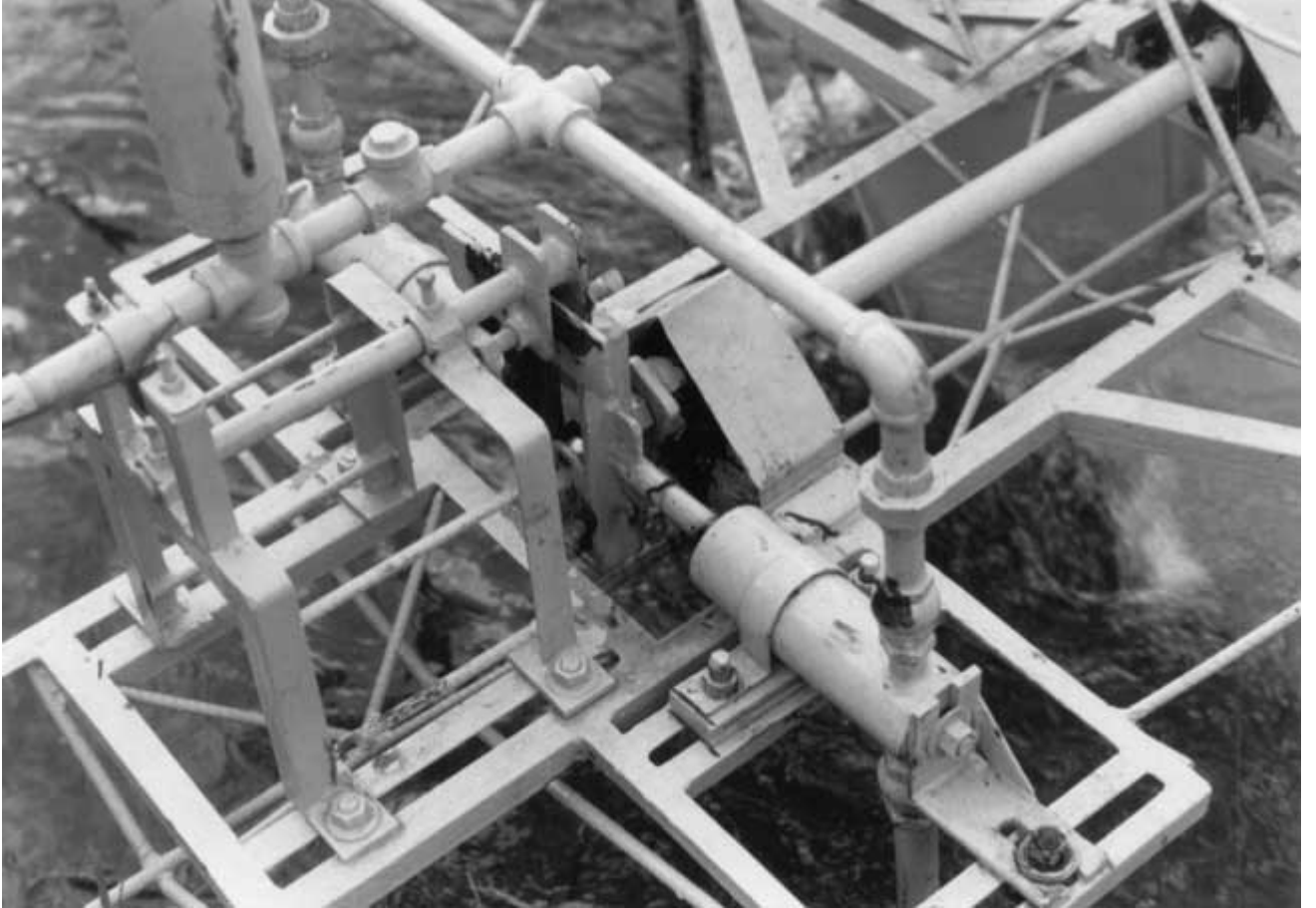

Figure 17: Complex stream driven alternative pump



Figure 18: Complex stream driven alternative pump

This machine is a piston water pump driven by a paddlewheel. It was photographed just after installation in a developing country. In comparison with the spiral pump, it appears to be extremely complex.

As there are no valves or moving parts except for the wheel and the rotary fitting, the spiral pump should have a very long service life. After almost 240 years, the Windfarm Museum tests indicate that the Wirtz spiral pump has a renewed future providing water for irrigation, fish farming, village, or home.

<http://www.wildwaterpower.com/>

Welcome to Wild Water Power!(Best viewed with Microsoft Explorer-Or its all over the place) Last updated: 06/20/07

Shown below are my various forms of new hydro power. My first attempt was an overshot wheel design with a chain drive. My second attempt was a Persian Waterwheel design

which makes electricity, which I call a Gravity Wheel. My last and by far the best, my Pressure Wheel design which I am still developing.

The chain drive Overshot wheel is cheap, but too complicated.

Getting the chain onto the wheel was always a problem. Even when getting it on perfectly the pressures involved were great. This caused wear and tear on the system. Pictures of this wheel are on the bottom and in on the Picture gallery page. It is probably best to go with a gear box. There are a few links on my "contacts" page showing wheels that use gear boxes.

The Gravity wheel is a great design. The flow of the river rotates the wheel, which lifts water in buckets which are connected to the side. This was inspired by the ancient Norias, or Persian water wheels. The difference between the Norias and the gravity wheel is just the materials used to build it and the water raised is used to run down to a turbine, not put on an aqueduct for irrigation.

My latest design I call a Pressure Wheel. I got the original idea from this site: <http://aquamor.tripod.com/Wheel.htm>.

I realized that this fellow had created a wonderful water lifting device. It also dawned on me that it has the perfect characteristics to garner power off a river. The problem with my Gravity wheel design was that of size. To create fifty foot of head, you had to make a fifty foot wheel. This is not a solution for a homeowner, nor is it all that practical for mass production. Using a spiral pump changes all of that; it turns rotational movement into pressure.

My design differs from the Aquamor site since I run the pressurized water through a turbine and the pressurized air through an air motor. Both of these run one generator.

The small one below is for test purposes. It is created out of PVC pipe and fiberglass reinforced plastic. It has an enclosed system. The fluid is scooped from the reservoir on the side; the fluid then goes through the spiral pump, which changes the movement of the wheel into pressurized air and fluid; that fluid then leaves the wheel through the rotating coupling and into the separator tank. From here the air

goes to an air motor and the fluid through a Pelton turbine. The final step is when the fluid leaves the turbine and is gravity fed back into the reservoir.

For this small prototype I did not spend the money for the turbine or air motor, it is for demonstration purposes.

It takes slow movement and converts it into pressure. How much pressure? That is determined by four main factors.

- The size of the Restriction the spiral pump goes into
- The number of spirals that are in the spiral pump.
- The inside diameter of the spirals that are in the spiral pump. -
- The air to water ratio in each spiral.

So, what does this get rid of? It gets rid of any type of transmission or gearing to make the flow of the river or ocean usable. The pressure developed can be run into an off the shelf turbine. The wheel and spiral pump are made of things you can pick up at your local Hardware Depot .It is ridiculously simple, the spiral pump have one wearable part, the rotating coupling that allows the pressurized water to come out of the wheel .This system can be used on overshot, breast and undershot wheels. Traditionally overshot wheel have been the true prime movers of the Wheel world. But this is now not the case. Large rivers will be much easier and cheaper to harness with an undershot design. In the ocean there is no limit to how big this system can be made.

Note: Think of it this way, this is not so much a waterwheel as an extension of a turbine that allows that turbine to harness large quantities of water, without a dam.

A little about myself. I have an Associated Degree from Denver Automotive and Diesel College. I was in the Navy for four years working on the electrical systems of F-14's as an Aviation Electrician. And I recently graduated from the University of Connecticut with an independent study degree in the History of Technology.



Short video explaining the basic concepts that make it work. Videos use Quicktime. Please ignore Flash, he is a bad boy.

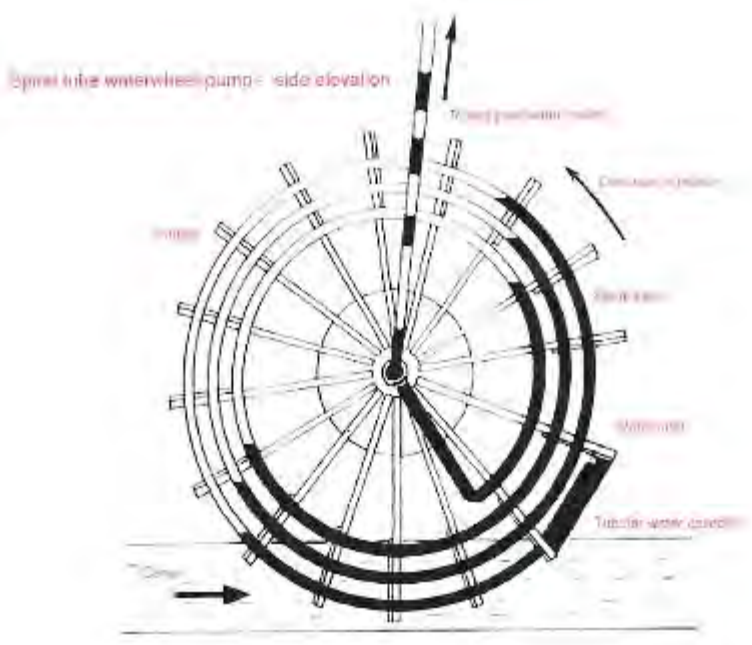



Alternative Energy and Lifestyles

[[Join Now](#) | [Ring Hub](#) | [Random](#) | [<< Prev](#) | [Next >>](#)]

Visit a complete list of [WebRing](#) memberships [here](#)

This site is a member of WebRing.
To browse visit [Here](#).

Spiral Pump Sites!!!!
[Story of a Waterwheel.](#)

[Peter Tailers Emperical Testing](#)

[Alan Belchers Quantification](#)

Alternate Energy Resource Network Webring

[[Join Now](#) | [Ring List](#) | [Random](#) | [<< Prev](#) | [Next >>](#)]

I found this one online. It is a spiral pump in its traditional job, raising water. I think it is about six foot tall (the site does not say), and raises 16 l/min up to 25m ht. That is a lot of pressure to lift that high. Even though it is very crude, is not floating (one has to wonder what happens when the big flood comes) it is the largest, heavy duty spiral pump I have found. If this was mine I would fit it to not only raise water but also produce electricity. It gives an indication of what is possible. One day I would like to think of this as small.



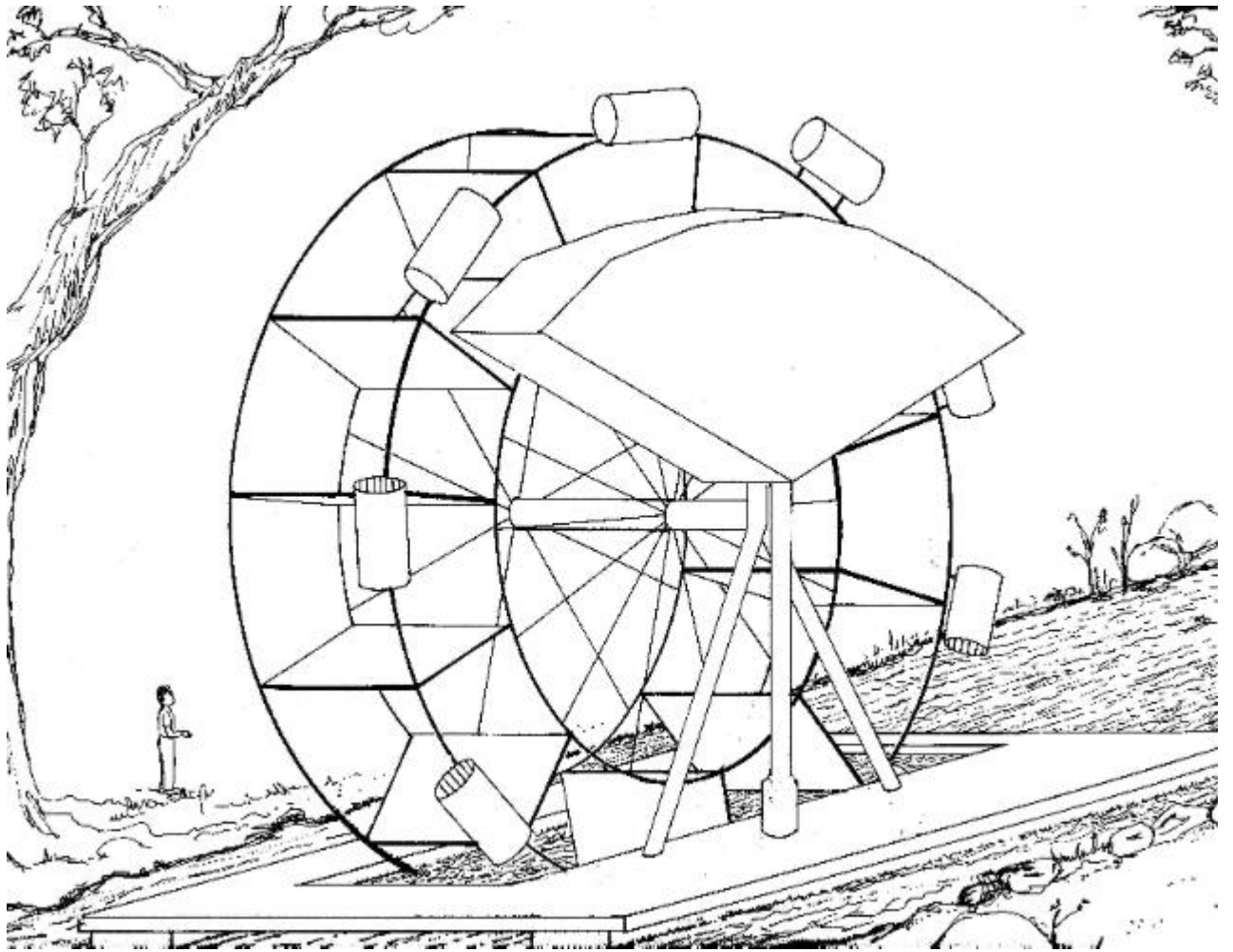



Gravity Wheel-converts the flow of a river into water pressure by lifting the water; thus *creating* head. It acts as a huge transformer, changing high volume-low pressure into low volume-high pressure. The problem with this design is the head created is limited to the size of the wheel itself.

CHAIN DRIVE OVERSHOT WATERWHEEL- This was my first waterpower project. It is nine foot in diameter, five foot wide and produces 1500 watts with approximately 1000 gallons per minute. The chain drive is much more complex than a spiral pump setup. The wheel itself is great, it is made of 4x4's and used plastic buckets. This is very cheap and I am going to eventually retrofit it to have a spiral pump and turbine.





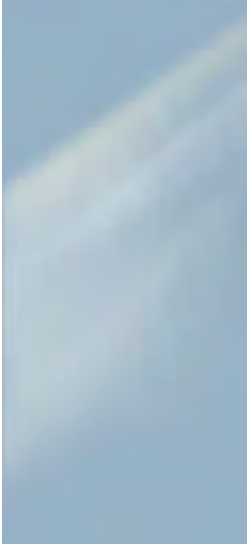

PICTURE GALLERY!

This is not in the video, so take note. I cut three inches from the bottom of the lid. I then cut it like you see (yes it is wobbly, but both sides match up perfectly), making sure to cut a bit of plastic out underneath where it swings (or it will hit and not swing). Then I drill through the pieces and the bucket and attach it all with a stainless steel nail, which I then bend. The nail is not the only thing holding it on, the lid snaps down also.



I used regular pillow block bearings. They are cheap and last a long time. I am still debating the merits of using sealed, oil filled bearings. They are a lot more money, but require no maintenance. Nor do they need protection from splashing water.



This is not in the video, so take note. I cut three inches from the bottom of the lid. I then cut it like you see (yes it is wobbly, but both sides match up perfectly), making sure to cut a bit of plastic out underneath where it swings (or it will hit and not swing). Then I drill through the pieces and the bucket and attach it all with a stainless steel nail, which I then bend. The nail is not the only thing holding it on, the lid snaps down also.



I used stone columns to support the flume. It was a lot of hard work, but cheap. They cost me one bag of cement per column since I had the stone. The easiest way is to use a hand truck with air tires