

# **AT** MICROFICHE REFERENCE LIBRARY

A project of Volunteers in Asia

## New Nepali Cooking Stoves

by: Carl Johnson

Published by:

United Nations Children's Fund  
Lazimpat  
P.O. Box 1187  
Kathmandu  
Nepal

Available from:

United Nations Children's Fund  
Lazimpat  
P.O. Box 1187  
Kathmandu  
Nepal

Reproduced by permission of the United Nations  
Children's Fund, Nepal.

Reproduction of this microfiche document in any  
form is subject to the same restrictions as those  
of the original document.

**NEW NEPALI  
COOKING  
STOVES**



NEW NEPALI  
COOKING STOVES

THAT MAKE  
SMOKELESS KITCHENS  
AND  
USE LESS FIREWOOD

UNICEF  NEPAL

SEPTEMBER 1982

## FOREWORD

This booklet aims to provide information on the prefabricated household stove currently being made available to rural families through the Small Farm Family Programme. This programme is being implemented in various districts of the country by the Agricultural Development Bank/Nepal with the support from UNICEF.

The stove described in this booklet is presently being manufactured in limited numbers by skilled potters in Bhaktapur and Thimi. It is planned to increase the availability of the stove by expanding production to other sites throughout the country.

In Nepal a considerable amount of effort has gone into the design, testing and distribution of various models of an improved household stove. The most notable individuals associated with this work are the late Rev. B.R. Saubolle, S.J., H.R. Baidya and B.K. Sharma, although valuable contributions have been made by many others.

Ready-made cooking stoves made of clay are a traditional product of Bhaktapur and Thimi. The new attempt of introducing prefabricated stoves was initiated by the HMG/UNDP/FAO Community Forestry Development Project and the Research Center for Applied Science and Technology, Tribhuvan University.

The particular model presented in this booklet is certainly not the final answer to achieving an inexpensive, simple and appropriate fuel-efficient stove for Nepal. However, it has proved to be an acceptable design to rural families who have discovered, through experience, that the stoves are economical on firewood and greatly reduce the amounts of smoke normally found in rural kitchens.

**C O N T E N T S**

\*\*\*\*\*

<b>Introduction</b>	
<b>Concept</b>	<b>5</b>
<b>Prefabricated Stove Set</b>	<b>6</b>
<b>The Choice of the Site</b>	
<b>Installation</b>	<b>7</b>
<b>Chimney Pipes</b>	
<b>Fire Hazard</b>	<b>8</b>
<b>Cooking</b>	
<b>Maintenance</b>	<b>9</b>
<b>Fuel Efficiency</b>	<b>10</b>
<b>Sketches</b>	<b>11</b>
<b>Information on Stoves</b>	<b>18</b>

## INTRODUCTION

In Nepal about 80 percent of the 15 million inhabitants are using firewood and straw for cooking and heating. With the increase of the population it has become difficult and costly to get firewood for many families, and the burden on healthy ecology is increasing to an alarming level. Aforestation and the more efficient use of wood, through fuel-saving and smokeless stoves, are essential remedies.

The collection of fuel wood for cooking is a task usually undertaken by women. The demand for energy for domestic purposes is such, that in many parts of the country, wood is exceedingly difficult to obtain and the task of gathering and fetching it to the village has become a time-consuming burden on women and children.

Another aspect of the 'firewood crisis' is that sundried animal dung cakes are being widely used in communities where wood is no longer available. In the confined space of a village house this fuel produces black acrid smoke, a hazard to eyes and lungs. Further, the use of animal dung as an energy source deprives the farmer of valuable manure.

## CONCEPT

The stove is designed for improved wood burning cooking, to make kitchens smokeless and to use less firewood.

The stove design corresponds very much with the traditional known cooking facilities in many Nepalese houses. The stove has two cooking holes; the fire is under the front cooking pot and the second pot is being heated mainly with hot air.

The smoke will be taken out of the house through the attached chimney pipes. The stoves and pipes are prefabricated at potters places. This proves to be a good means of technology transfer, as in this way the crucial measurements are being made by trained potters. The installation of the different parts can then be done quite easily by those villagers who have had an introduction in this new technique.

### PREFABRICATED STOVE SET

A complete stove set consists of five pieces and the chimney pipes.

- 1) **Stove:** The stove and the appliances are made of fired clay. They are fitted together at the site by simply using clay as a bonding material.
- 2) **Mouth Piece:** This piece is fixed to the entrance of the stove. It serves mainly as a supporting piece, to carry the top layer of clay.
- 3) **Connector:** This small pipe of square shape connects the stove and the chimney pipe. It has a slit to house the metal damper.
- 4) **Damper:** This flow-adjusting device is made of sheet metal. It serves as a draft regulator, thus reducing the hot air flow through the chimney pipe.
- 5) **Bottom Piece:** This piece connects the stove with the chimney pipe. The bottom holes are for the cleaning purposes; there are two holes for either right or left-hand access. The hole at the wall site will be closed permanently with clay and the front with a stone sealed with clay.

This clay will be removed every three to four months in order to get rid of the accumulated soot.

### THE CHOICE OF THE SITE

Stoves are especially useful for medium-sized families, (five to eight people), where wood is being used as fuel. The choice of the site has to be discussed and agreed by the houseowner and the cook. The cook must also decide upon the height of the stove (often people prefer to raise the stove by one brick's height). For proper site selection the direction has also to be considered: in some societies it is crucial to have the axis correctly oriented; the fire wood to be put in the stove either east or west-wise.

Daylight is required for convenient cooking, preferably with the light directed towards the firebox opening.

The chimney pipe takes the smoke out of the house. It is recommended to have the pipe installed inside the house, for warmth and draught. The height of the pipe should be at least three meters and if possible go above the roof level.

### INSTALLATION

The installation of prefabricated stoves and chimney pipes is quite easy. The time required is two to three hours, provided the materials are at the site (stove set and pipes; binding wire, wall hooks, (nails); red mud (*rato mato*); water; bricks or stones and some tools).

For moderate and warm climate: use dry material (rubble) to fill the hollow gaps between the stove and the surrounding walls. This acts



as an insulator and reduces the heat transfer.

For cold climate: use good clay and work on proper bonding with the stove. This acts as heat mass and provides some warmth to the room. The chimney pipe should be inside the rooms, except of the last exit pipe. This way the functioning of the draught will be better and more warmth will be available inside the house.

It is important that the pots sit snugly on to the stove, for efficient heating and to stop the smoke getting into the room.

### CHIMNEY PIPES

The length of chimneys should be three meters in height, at least, and go, wherever possible, above the roof.

It is not recommended that the pipes should go straight through the roof, as they cannot easily be made watertight from rains; bends and pass-through walls as shown in the sketches should be used.

Where chimney pipes are replaced with stone or brick structures, the foundation must be very strong and that the inside measurement should be twenty by twenty cm. The surface should be smooth. The bottom must have an opening, for regular cleaning.

Metal pipes are not recommended, for reason of cost, corrosion and safety.

### FIRE HAZARD

Chimneys must be a certain distance from wooden or other burnable materials (15 cm at least). The chimney pipes have to be fixed in such a way, that sockets are not inside the ceilings or walls and they are at least 20 cm or more from ceilings.

Chimneys need to be cleaned regularly (every three or four months). For this the top pipes have to be removed and the bottom opening used for cleaning. The cleaning can be done with a brush or cloth fixed to a long stick.

Where the chimney pipe exit is near a thatched roof a piece of fly screen can be fitted; this prevents sparks from getting out of the pipes.

### COOKING

The first cooking on a newly made stove should be delayed for some days of its completion; where a new stove is started before the clay is fully dry, the surfaces will crack!

The beginning of cooking demands a new system. Small wood pieces are required, the cooking process needs a little patience in the first few days.

To start the cooking the damper near the chimney has to be opened fully. Once the fire is burning properly, the damper should be lowered until smoke comes out; then open it a little again. In this way the fuel efficiency can be further increased.

After the cooking is completed, remove the wood and the remaining charcoal from the firehole and extinguish it with water.

### MAINTENANCE

Improved stoves can be maintained as traditional stoves. They can be cleaned normally and red mud added for neat appearance. Regular chimney cleaning is essential!

## FUEL EFFICIENCY

Greater efficiency can be achieved by paying attention to the following points:

- Make sure that the cooking pots sit snugly on to the cooking stove.
- Keep the damper closed as much as possible
- Use small pieces of wood
- Use dry wood
- Keep the fire small and cook slowly
- Keep covers on the pots
- Use metal pots, and where possible pressure cookers
- Keep doors and windows closed on cold climate
- Remove charcoal and wood when the cooking is finished and extinguish them with water
- Close damper after cooking to keep the stove warm;  
(where warmth is required)
- Clean chimney pipes regularly for fuel efficiency and safety.

# NEW NEPALI CHULO

ISOMETRIC AND EXPANDED VIEW ON  
PREFABRICATED STOVE PARTS BE-  
FORE THE INSTALLATION IN A HOUSE

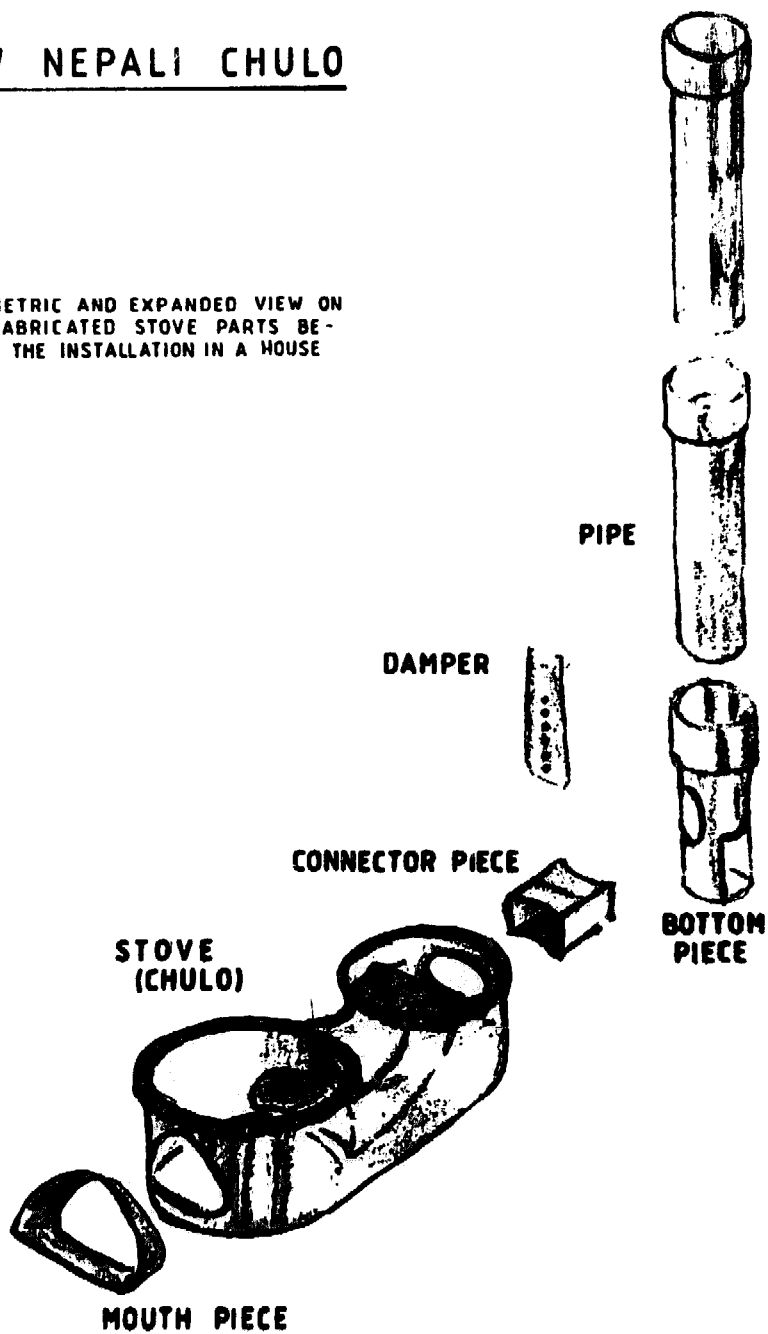

## NEW NEPALI CHULO

ISOMETRIC VIEW ON A STOVE INSTALLATION BY USING PREFABRICATED STOVE PARTS

TOP PIECE  
WHERE SPARK PROTECTION IS  
REQUIRED INSERT FLY SCREEN

CHIMNEY PIPES NEED  
TO BE CLEANED EVERY  
3 TO 4 MONTHS

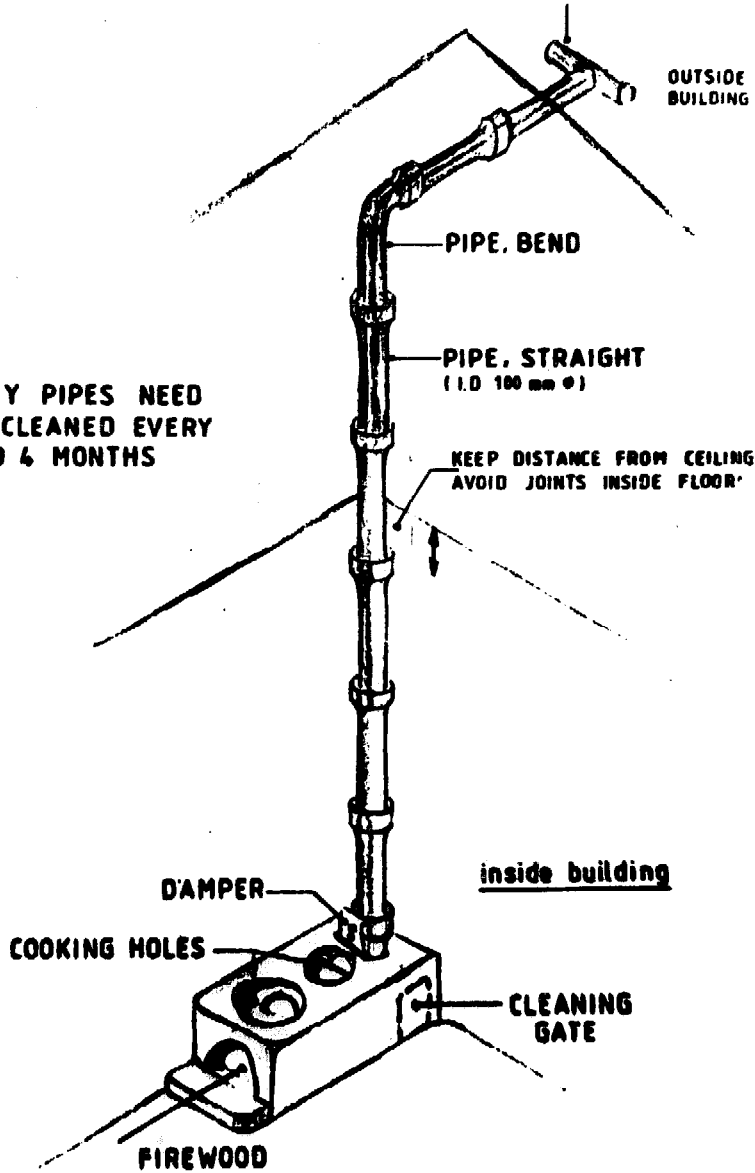

7/82

# NEW NEPALI CHULO

ISOMETRIC VIEW ON A STOVE INSTALLATION BY USING PREFABRICATED STOVE PARTS

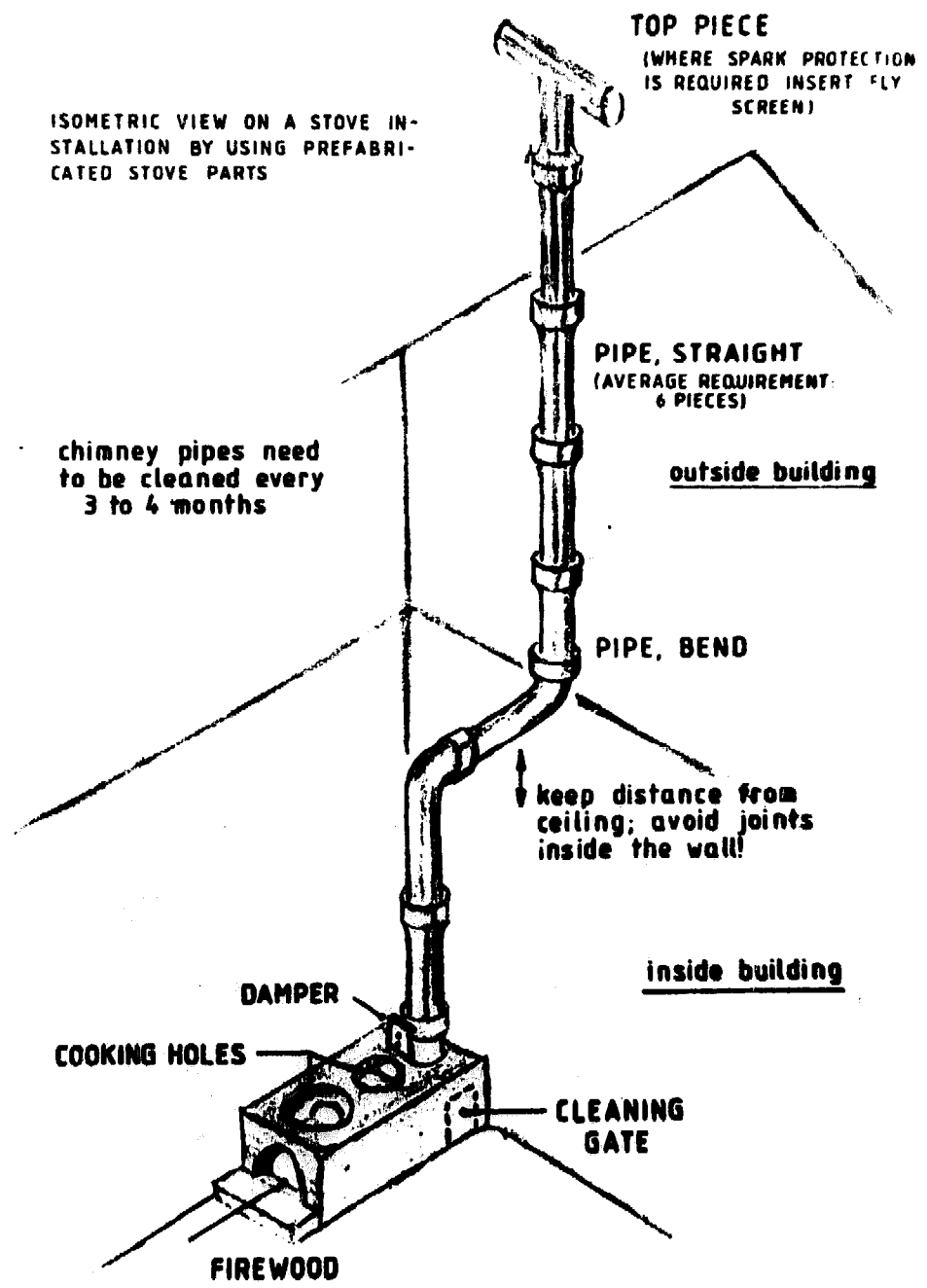

**TOP PIECE**  
(WHERE SPARK PROTECTION IS REQUIRED INSERT FLY SCREEN)

**PIPE, STRAIGHT**  
(AVERAGE REQUIREMENT: 6 PIECES)

outside building

**PIPE, BEND**

keep distance from ceiling; avoid joints inside the wall!

inside building

**DAMPER**

**COOKING HOLES**

**CLEANING GATE**

**FIREWOOD**

6/82

FRONT

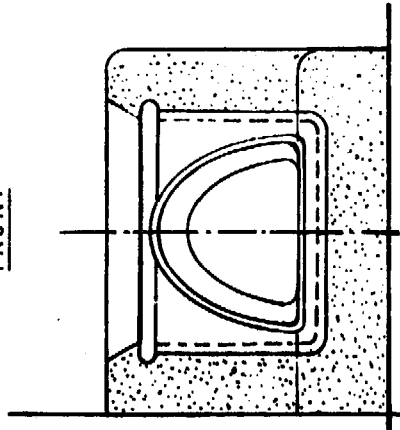

TOP LAYER (3 CM) - CLAY

▬ FIRED CLAY

▬ BRICKS OR STONES

**NEW NEPALI CHULO**

(MODIFIED "MAGAN" SYSTEM)

MEASUREMENTS IN CM

24/6/82



SIDE

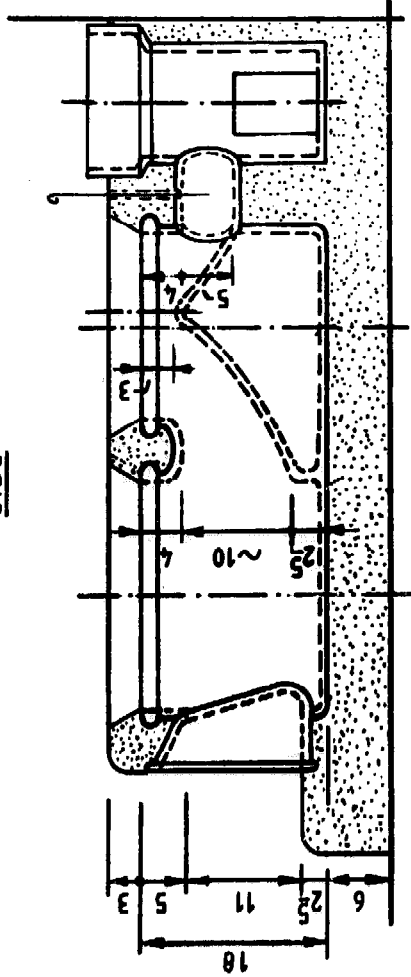

TOP

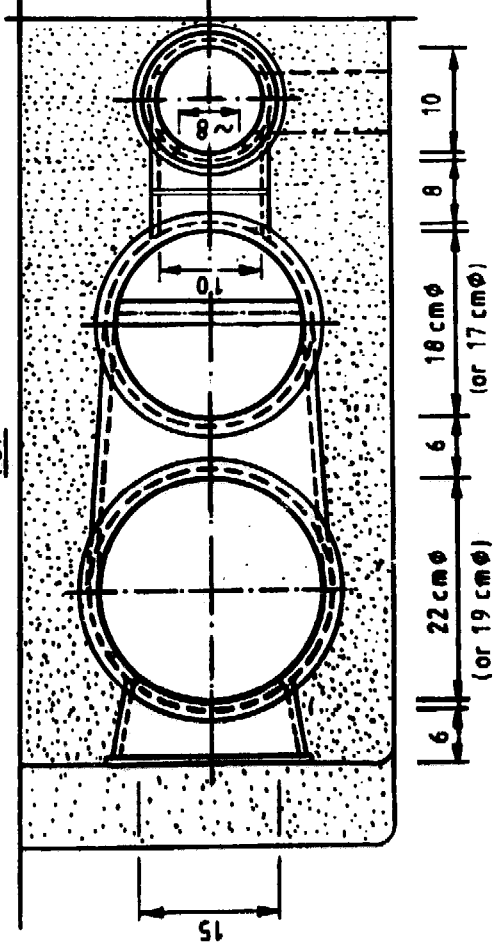

NEW NEPALI CHULO / STOVE ONLY

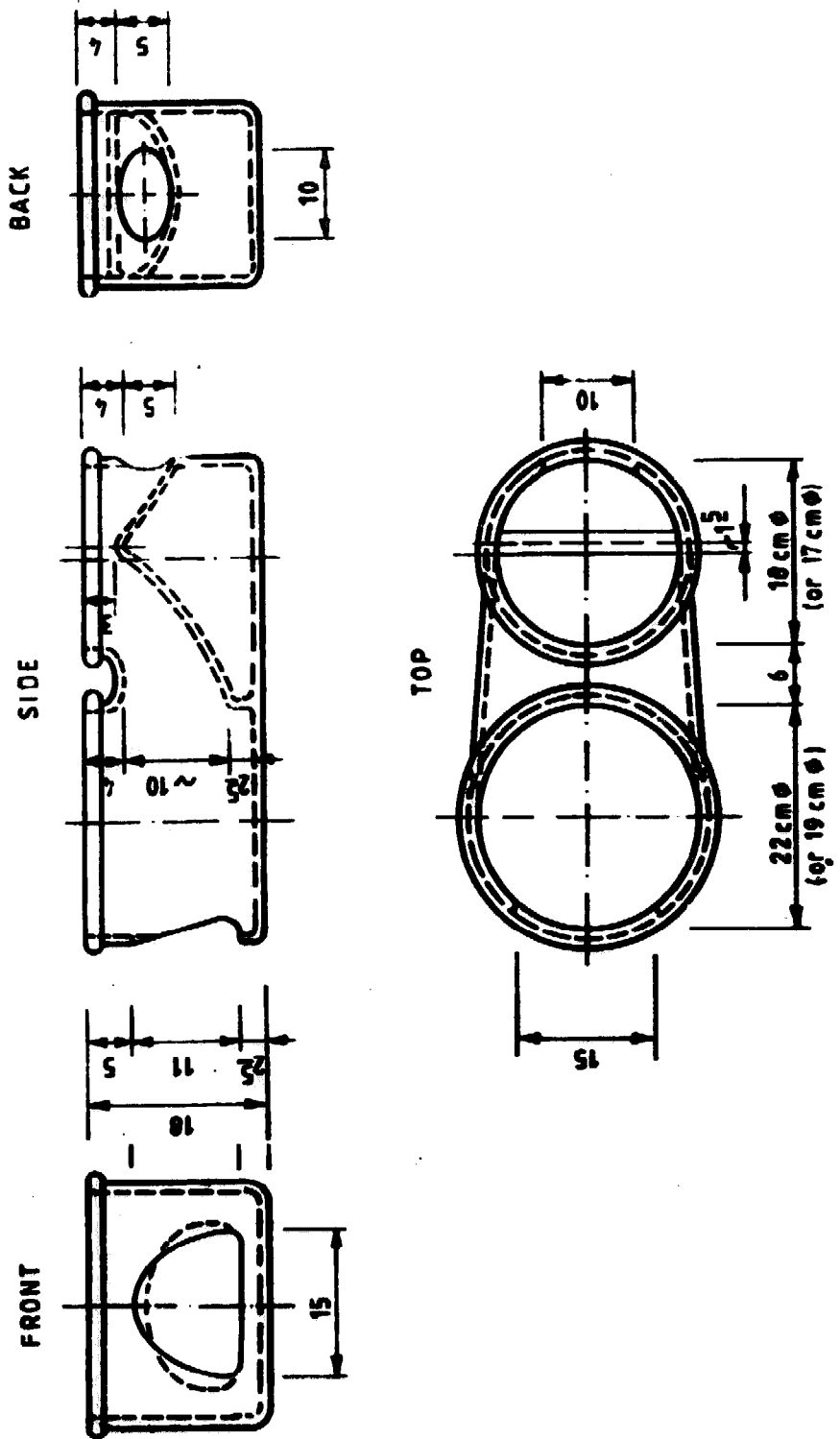





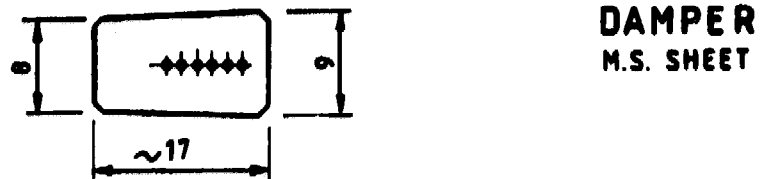
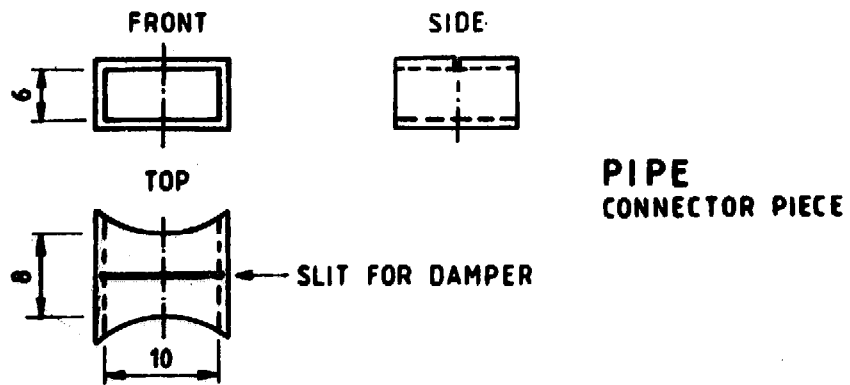
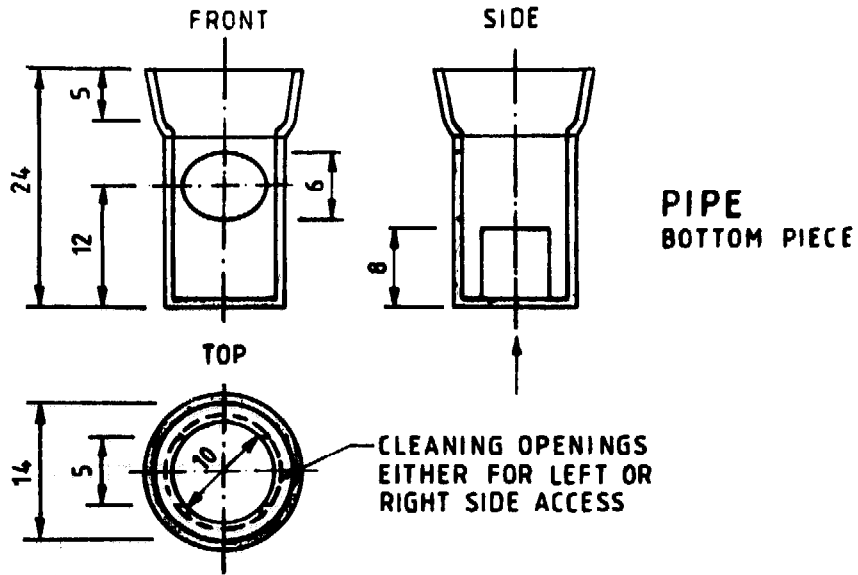



### NEW NEPALI CHULO / SINGLE PARTS

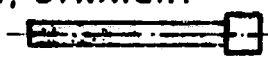
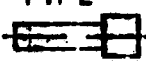

NOT SHOWN MOUTH PIECE

MEASUREMENTS IN CM  
25/6/82 202

MATERIAL REQUIREMENT ( AVERAGE )  
FOR ONE STOVE INSTALLATION

<b>NEW NEPALI CHULO</b>			
FOR: _____ (NAME / PLACE)			
TYPE ORDER DELIVERY NOTE RECEIPT			
MATERIAL	UNIT pcs/set	AT Rs EACH	TOTAL Rs
STOVE SET (4 PIECES) 	1		
PIPE, STRAIGHT 	6		
1/2 LENGTH PIPE 	1		
PIPE, ELBOW 	2		
TOP PIECE (TEE) 	1		
DAMPER 	1		
HACKSAW BLADES	1		
NAILS / WIRE	16p/16m		
TOTAL RS.			
NAME _____	DATE _____		
PLACE _____	SIG _____		

INFORMATION AVAILABLE ON IMPROVED COOKSTOVES

- |   |  |
|---|--|
| 1) SIMPLE SMOKELESS CHULA<br>by B.K. Sharma | World Neighbors<br>P.O. Box 916<br>Kathmandu   |
| 2) NEW NEPALI CHULO                         | Research Center for Applied<br>Science and Technology<br>Tribhuvan University<br>Kathmandu |
| 3) Brochures,<br>by H.R. Baydia             | Peace Corps Office<br>Lal Durbar<br>P.O. Box 613<br>Kathmandu                              |
| 4) Information                              | Community Forestry Development<br>Project, Hattisar, Naxal<br>P.O. Box 107<br>Kathmandu    |

REGULAR INFORMATION AVAILABLE

- |                   |   |
|-------------------|---|
| 1) COOKSTOVE NEWS | The Aproveco Institute<br>442 Monroe<br>Eugene / OR 97402 / USA                                   |
| 2) VITA NEWS      | VITA, 1815 North Lynn Street<br>Suite 200<br>Arlington / Virginia 22209/ USA                      |
| 3) BOILING POINT  | ITDG Stoves Team<br>Applied Research Section<br>Shinfield Road, Shinfield<br>Reading, Berks, U.K. |

INFORMATION AVAILABLE ON PREFABRICATED STOVES

- |  |   |
|--|---|
| 1) MAGAN CHULO<br>(Smokeless Cooking Oven)<br>by T. Kalluppatti (1955) | Gandhiniketan Ashram<br>T. Kalluppatti<br>Madurai Dt. / India   |
| 2) SARVODYA  | Sarvodya<br>77, de Soysa Road<br>Moratuwa / Sri Lanka   |
| 3) DIAN DESA   | Dian Desa<br>Appropriate Technology Org.<br>Jl. Kaliurang km7<br>Jurusan<br>P.O. Box 19, Bulaksumur<br>Yogyakarta / Indonesia |
| 4) RECAST  | Research Center<br>for Applied Science<br>and Technology<br>Tribhuvan University<br>Kirtipur Campus<br>Kathmandu / Nepal      |
| 5) ITDG STOVES TEAM  | ITDG Stoves Team<br>Applied Research Section<br>Shinfield Road<br>Shinfield, Reading, Berks, / U.K.                           |

CAST IRON STOVE PARTS

- |                       |  |
|-----------------------|--|
| Top plate, with rings | KATHMANDU METAL INDUSTRY<br>12 / 514 Quadon, Nagal<br>Kathmandu / Nepal  |
| door                  |  |
| grate                 | NATIONAL STRUCTURE<br>AND ENGINEERING COMPANY<br>Patan Industrial Estate<br>Lagankhel, Lalitpur<br>Kathmandu / Nepal |

UNICEF, P.O. BOX 1187,  
KATHMANDU / NEPAL