

AT MICROFICHE REFERENCE LIBRARY

A project of Volunteers in Asia

Shelter II

by: Lloyd Kahn

Published by:
Shelter Publications
P.O. Box 279
Bolinas, CA 94924 USA

Paper copies are \$10.00.

Available from:
Home Book Service
P.O. Box 650
Bolinas, CA 94924 USA

Reproduced by permission of Shelter Publications.

Reproduction of this microfiche document in any form is subject to the same restrictions as those of the original document.

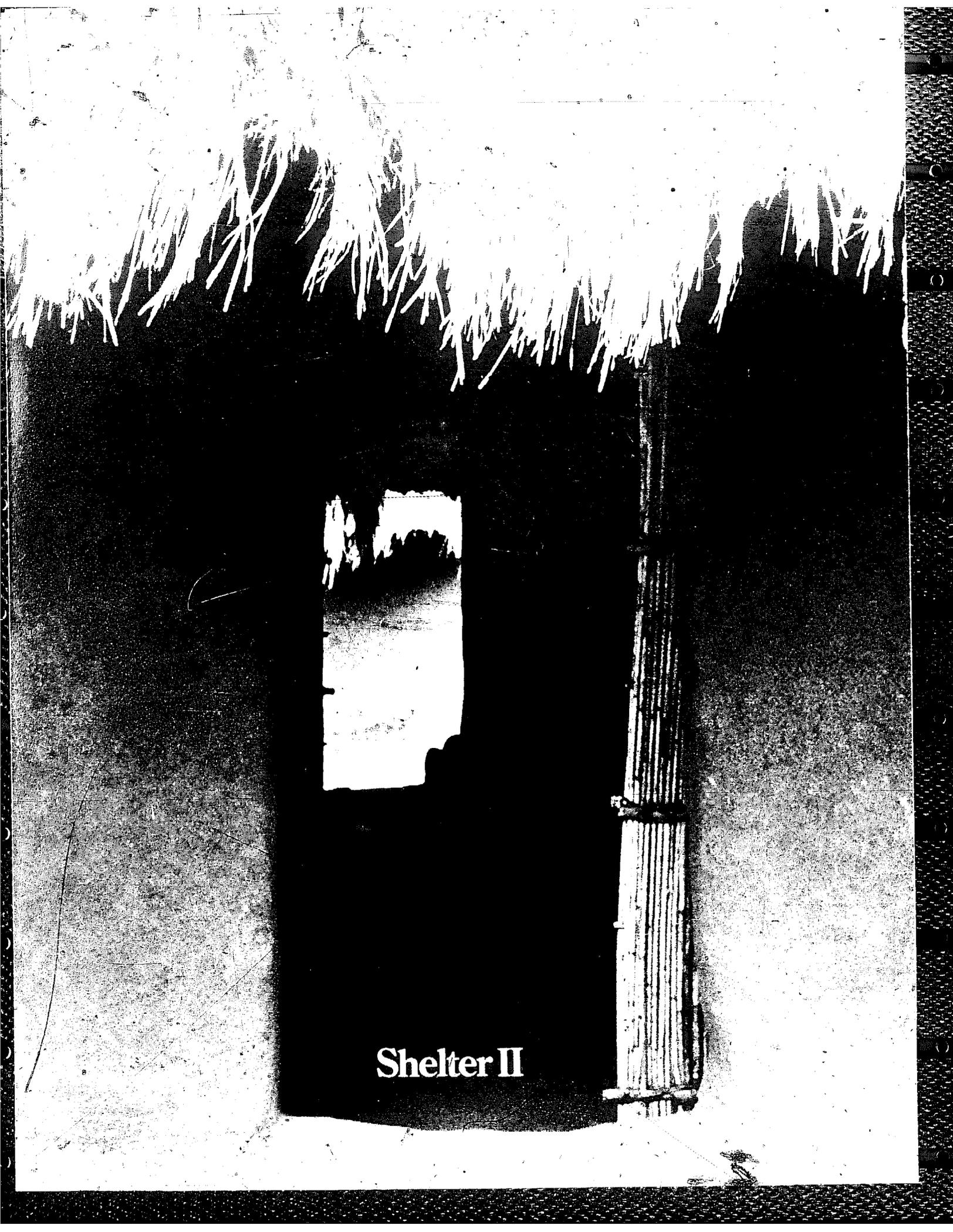

Shelter II



From *Trattato di Architettura*, 1464, Antonio Averlino Filarete.

Contents

Indigenous Builders 4

Ghana	Paul Marchant	6
Rendille	Anders Grum	10
East Africa	Jack Fulton	12
Disaster Housing	Ian Davis	14
New Guinea	Ajit Mangar	18
Urus	James Warfield	20
Pacific Islands	D. Stafford Woolard	22
Menorca	Regan Bice & Josep Mascaro	28
Turkish Yurts	Suba Ozkan	30
Mongolian Yurts		33
Tents	Suba Ozkan	34
Greece	Aris Konstantinidis	36
Plains Towns of Northwest Italy	John Hamilton Doyle	40
Celtic Dwelling	M. Pierré Gac	42
Les Maisons Paysannes Francaises	Roger Fischer	44
English Cottages		46
Ireland		48
Gypsy Van	Denis E. Harvey	49
Kickapoo	Peter Nabokov	50

North American Houses and Barns 54

Sod	Roger Welsch	54
Old Texas Buildings	Burton Wilson	56
Country Buildings		60
Nova Scotia		62
Mississippi		63
California		64
Barns		65
Bungalows		70

Design 74

Climate, Site, Planting	76
Design Checklist	78

Flows	80
Toilets	81
Alternative Energy	82
Local Energy	83
Cold Climate	Ned Cherry 84
Thermal Mass	Michael Gaspers 85
Building Costs	86

Small Buildings 87

Flat Roof	88
Shed Roof	90
Low Gable	92
High Gable	94
Saltbox	96
Gambrel	98
Hip Roof	100
Gambrel Barn	102
Greenhouses	104
The Building Codes	Rob Tballon 105
Building Inspector	Herb Wimmer 108

Construction 111

Foundations	112
Floor Framing	119
Wall Framing	120
Roof Framing	122
Roofing	125
Windows	126
Doors	127
Siding	128
Insulation/Vapor Barrier	129
Sheetrock	130
Stairs	131
Plumbing/Wiring	132
Metal Chimneys/Safety	133
Nailing	134
Glossary	134
Working	Studs Terkel 135
High School Carpenters	136
Earthquake	Peter Yanev 138

Materials 140

Basic Adobe	P. G. McHenry 140
Bamboo	142

Rigid Frame	Ole Wik 144
Log Octagon	Don Gesinger 146
Idaho Log Cabin	148
West Virginia Log Cabin	Pete Lundell 149
Building with Stone	Lewis & Sharon Watson 150

Homes 152

Orkney Islands	Ruth Wheeler 156
Hoedad Yurts	Charles Crawford 158
Sod Roof	Robert Stowell 160
Vermont Cabin	Robert Stowell 161
Starting Over	Ian Jagersoll 162
Color	164
Tent Top	Ole Wik 166
Back to the City	George Abernathy 170
Interiors	172

Cities 174

Homeowners' Rehab	176
Homesteaders in the Bronx	Ned Cherry 182
Amsterdam Houseboats	Paul de Leenbeer 188
Norfolk Street Victorians	190
Ohmega Salvage	Vito San Joaquin 194
House Inspection	George Hoffman 196
Termites	George Hoffman 198

Industrialized Housing 200

Domes	200
Dome Letters	202
Foam Domes	Suba Ozkan 204
Polyurethane Foam	206
Sunbeams from Cucumbers	207
Space Colonies	208
Letters	214
Bibliography	220
Credits	222
Index	224

Shelter II

Copyright (c) 1978 by Shelter Publications, a non-profit California corporation. All rights reserved. No part of this publication may be reproduced or transmitted in any form or by any means, electronic or mechanical, including photocopy, recording, or any information storage and retrieval system without the written permission of the publisher.

Distributed in the United States by Random House and in Canada by Random House of Canada, Ltd.

Individual copies of this book available by mail; see p. 222 for details.

Shelter Publications
P.O. Box 279
Bolin, Calif. 94924 USA

Shelter Publications is a non-profit educational corporation formed for the purposes of providing research, design and education in the fields of housing and the building crafts; cataloging and preserving traditional as well as innovative construction techniques; maintaining a network of contributors; and disseminating information to the public by publication of directly related literature.

Library of Congress Cataloging In Publication Data
Main entry under title:

Shelter II

1. Dwellings 2. House Construction. I. Kahn, Lloyd.
TH4812.S53 728 78-57133
ISBN 0-394-50219-1
ISBN 0-394-73611-7 pbk.

We are grateful to authors and publishers of the following books for permission to reprint copyright material:
CALIFORNIA LIVING MAGAZINE of the San Francisco Sunday Examiner and Chronicle, September 19, 1976; copyright (c) 1976, San Francisco Examiner. Reprinted with permission.
FUNDAMENTALS OF CARPENTRY, VOLUME 2, PRACTICAL CONSTRUCTION (Third Edition) by Walter E. Durbahn and Elmer W. Sundberg, copyright (c) 1964 by American Technical Society. Reprinted with permission.
PIONEER TEXAS BUILDINGS, Clovis Heimsath, University of Texas Press, 1968; copyright (c) 1968 by Clovis Heimsath.
PRIMITIVE ARCHITECTURE AND CLIMATE by James Marston Fitch and Daniel P. Branch; copyright (c) December 1960 by Scientific American. Reprinted with permission.
SCIENCE YEAR - THE WORLD BOOK SCIENCE ANNUAL; copyright (c) 1975 Field Enterprises Educational Corporation. Reprinted with permission.
A SMALL HOUSE IN THE SUN; copyright (c) 1971 by Samuel Chamberlain, permission by Hastings House Publishers.
WORKING: PEOPLE TALK ABOUT WHAT THEY DO ALL DAY AND HOW THEY FEEL ABOUT WHAT THEY DO, by Studs Terkel; copyright (c) 1972, 1974 Studs Terkel. Reprinted by permission of Pantheon Books, a division of Random House, Inc.

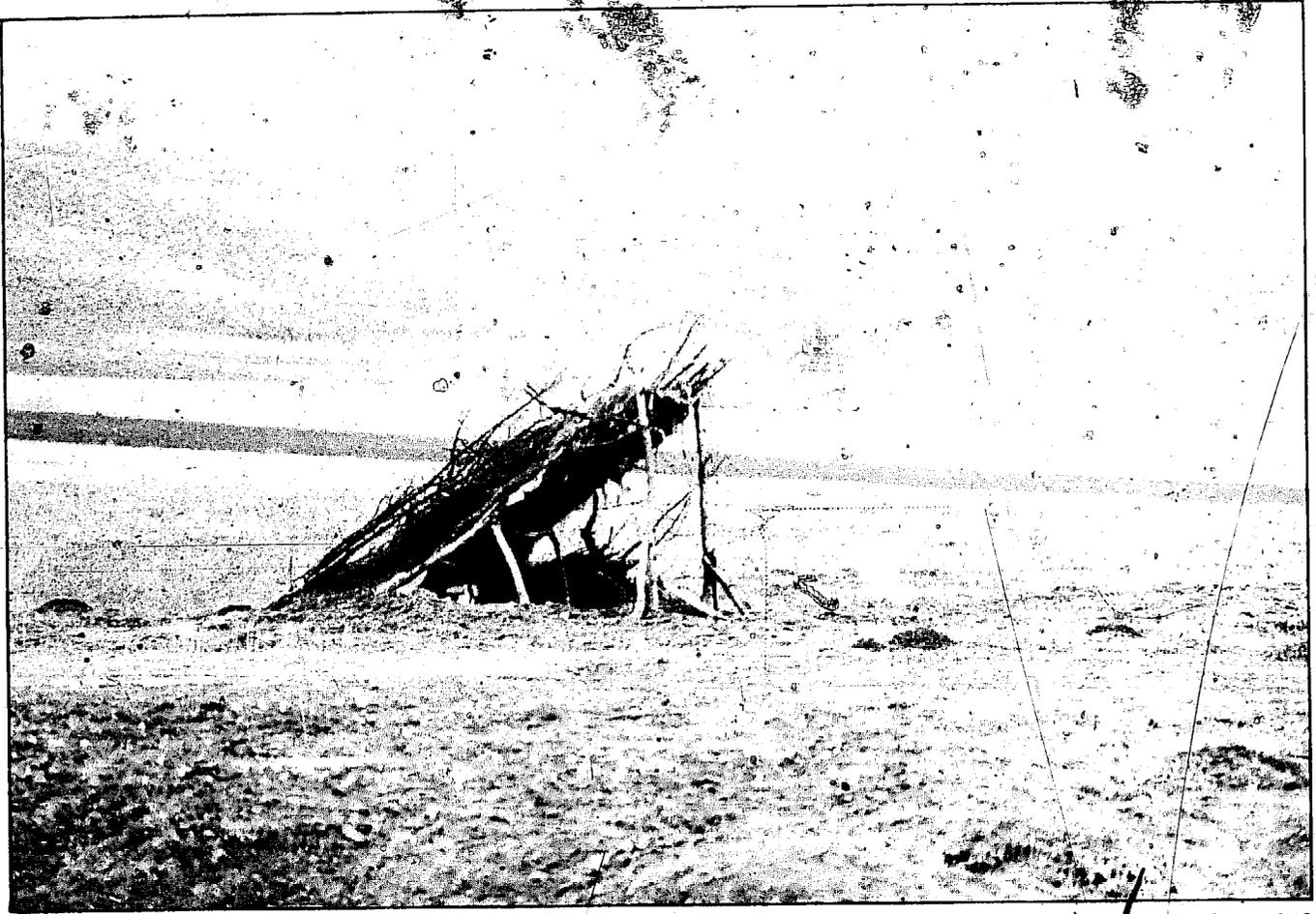

A shepherd's refuge from the wind, Akchir, Turkey, 1978.

Introduction

Shelter II is the second in a series of books about people building their own homes in different parts of the world. *Shelter*, a scrapbook of building ideas, was published five years ago and since then, housing costs, land, building materials, real estate, rents have increased dramatically. The principles outlined in *Shelter* seem even more important today: re-learning the still-usable skills of the past, finding a balance between what we can produce for ourselves and what we must buy, and doing more hand work in providing life's necessities. *Shelter II* goes on with a review of world-wide housing techniques, provides a basic manual of design and construction for the first-time house-builder, and covers self-help housing projects now underway in large cities.

The book begins with simple shelters still being built and lived in by people with minimal resources. They can be viewed either for historical or anthropological interest, or as sensible—even instructive—examples of efficient construction by those who lack the choices available in industrialized societies. We can also learn from the farm and country buildings of North America—still-standing reminders of an era of practical design and straight-forward construction, practices: siting to minimize wind exposure, roofs shaped to shed rain or snow, shady porches for summer coolness.

Stud framing has been the most common housebuilding technique in this country since sawmills began turning out 2x4's and 2x6's in the mid-nineteenth century and is shown next as the most practical form of house construction in most situations today. There is an introduction to the principles of design, framing drawings of seven roof shapes, and a 24-page abbreviated construction manual for building a small home.

In some cities, abandoned buildings are being cleaned up and rehabilitated, older houses repaired and maintained. People are working to create their own living space and learning new skills in the process; derelict neighborhoods are revitalized, and housing is provided where it is needed most. Some more recent developments are also examined: dome housing, and America's current program to establish colonies in space are reviewed and commented upon.

There are also personal accounts and seasoned advice from builders in different climates, with a variety of design approaches, construction techniques, and building materials: adobe in New Mexico, log cabins in Washington and Idaho, a family-built stone house in California, homesteading on a Scottish island, floating summer tents in Alaska, and houseboats in Amsterdam.

Throughout, there are consistent elements. Practical builders, wherever they live, work with simple techniques and what is most readily at hand: earth, thatch, stone, milled lumber, or abandoned city buildings. Weather, purpose, materials govern design. Tradition, experience, practice determine building technique. Individual initiative and hand labor by owners can decrease spiraling costs and reduce or eliminate life-time mortgage obligations.

In the past century, industrial-technological progress has been rapid. Yet basic human needs are still much the same. Shelter has always meant a roof overhead, protection from the elements, a refuge. A home is still a place for working, resting, sharing, healing, dreaming... some things haven't changed that much.

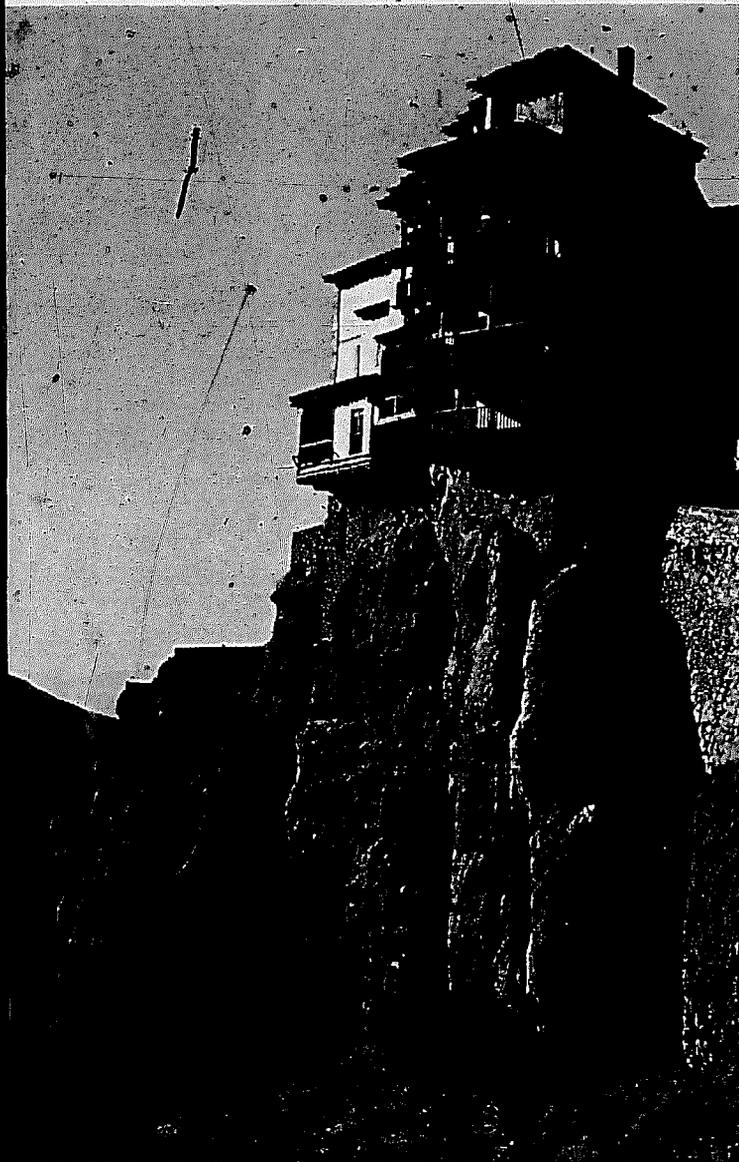

At left: *cliffside residence, Cuenca, Spain.*
 Below: *fish nets drying on the island of Janitzio, Lake Patzcuaro, Mexico.* Bottom: *stone house under construction in Nepal.*

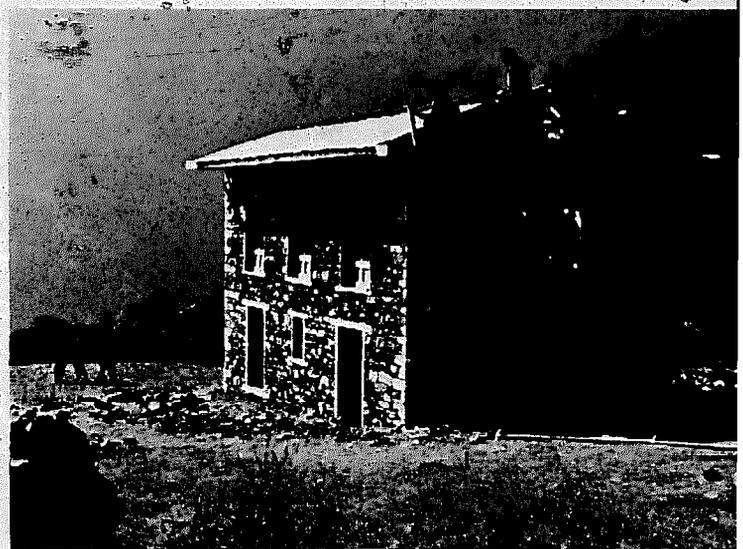
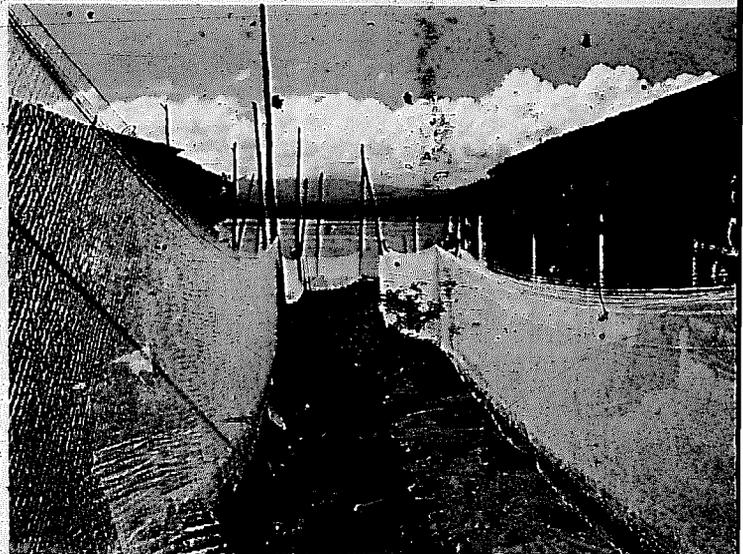

Indigenous Builders

In much of the world, homes are still built with a minimum of machinery, electrical energy, and processed materials. Mud, woven grass and straw in Africa; reeds, ivory nut leaf, bamboo in the South Pacific; stone, mortar and whitewash in Greece. No plywood, sliding glass doors, butyl caulk or skilsaws.

People build this way when there is no other choice: the economics of necessity. These buildings blend with their surroundings because they are products of those same surroundings. Design is based upon close observation of weather patterns, changing seasons, and available materials. Construction is often a community affair, with tools and techniques worked out over generations.

There is much to learn from indigenous builders, past and present. Not that we will suddenly return to the bamboo grove, or begin building huts of mud and thatch. But in an

era of diminishing resources and rising prices the "primitive" solutions of indigenous builders can be instructive in planning to provide our own shelter needs — having less resources requires greater resourcefulness: breezes, rather than air conditioners for summer cooling; sensible siting to minimize wind exposure; rock that is cleared from the fields for farming used to build the walls of the farmhouse; design based upon available materials and minimal consumption rather than abstract concepts or architectural frivolity.

On the following fifty pages are photos, drawings, and descriptions of low-cost, energy-efficient structures from around the world, from the Nabdam family compounds of Ghana to the tule mat lodges of the Mexican Kickapoo. Homes built with few of the benefits of mechanical industry, yet with great economy, skill and beauty.



At left: farmer's house, Lambwe Valley, Kenya, Africa. Below: thatched roof interior of hotel in Twiga, Kenya, Africa; approximately 90 foot diameter.

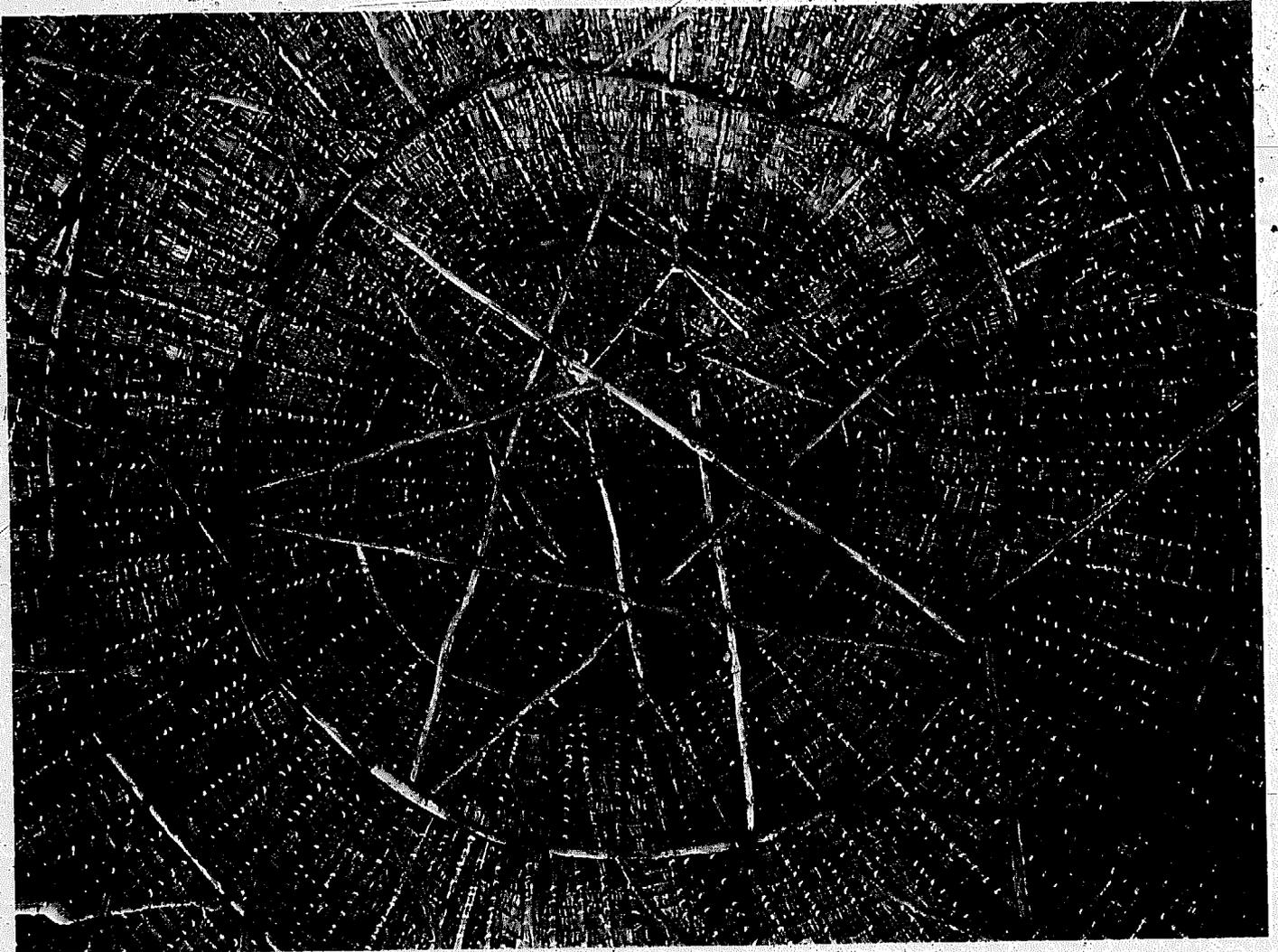

Ghana

by Paul Marchant

David is a Nabdam tribesman, a native of Ghana. We met in the silent white-hot glare of late November's noonday sun. The heat fanned by the dust-laden Harmattan wind prematurely withered all life before it. David stood in a group of boys and old men who waited with suspicious eyes while I explained my interest in their picture decorated houses. I presented a customary gift of cola nuts wrapped in a leaf, asking permission to visit their compound and photograph the beautifully drawn crocodiles and birds. The expressions of doubt which had contorted these aged yet youthful faces of the earth began to ease. As we started to move around the compound David became the vehicle of an oral tradition unbroken for at least 300 years, and began to describe the remote origins of his people.

In olden times there was once a fairy who lived in a thick grove of trees. This gave him shelter and protection as he didn't know how to build a house. The fairy was a farmer with great knowledge of the plant and animal kingdom, and had supreme contact with the earth spirits.

One day a hunter, emerged from the bush, exhausted after the long pursuit of game.

He eyed the fairy's activities with great surprise, unable to believe that anyone could survive by eating grass-seed and plants.

The fairy explained his craft and the hunter was so pleased that he implored the fairy to teach his villagers.

The fairy went with him and spent a year in the village so that the people would know the complete farming cycle.

The hunter was delighted and gave the fairy his youngest daughter for a wife.

The fairy returned to the grove and his new wife showed him how to build a house and live in it with a wife.

Their sons and daughters became the Tendaanas (High Priests) of the Land.

David asked me if I wanted to watch his uncle — a soothsayer — beginning work on a new house, across the fields. We would visit his father, Kapeon's house on the way. . . . We picked our way along a narrow time-frodden path. On either side, spiky stubble protruded from the rippling heaps of soil moving away from a compound at their centre. A few weeks before, guinea-corn and millet had been a vivid green barrier ten feet high, obscuring the houses and small trees. Now the strewn remains of the crops burned yellow and brown in the strong heat, in the mid-nineties during the dry season.

Kapeon's house was typical of Nabdam family compounds, consisting of a circular chain of cylindrical cells measuring eight or nine feet in diameter and connected by screen walls. A single entrance opened into the internal livestock yard, separated from the living courtyards and sleeping rooms at the far end by a major dividing wall containing the granary. Indigenous materials make optimum use of environmental potential: all walls were laterite





Wall at which dangerous food is cooked.



Lamsin

David with friends.

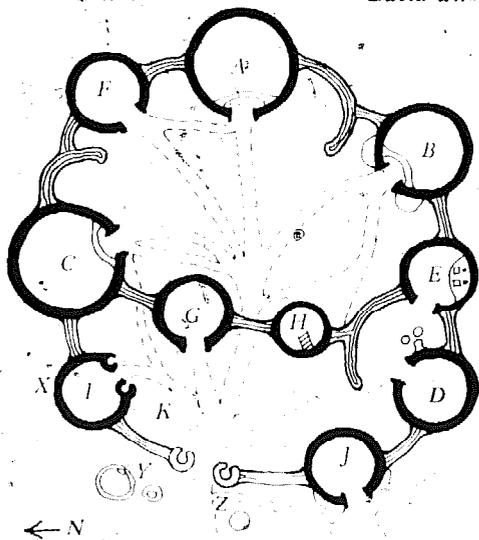

Nabdam compound near Zuarauigu. About 50 feet in diameter. A. compound leader; B. wife; C. children; D. kitchen; E. grinding room; F. store; G. fowls; H. granary; I. goats; J. guard room; K. hen coops; X. ancestors' door; Y. & Z. ancestors' shrines.

(red earth) rendered with cow dung/clay; roofs were conical thatches or flat; even household implements (including calabash dinner plates and leaf food wrappings) were biodegradable, and wastage is comparatively unknown.

David's room was the only rectilinear cell in the compound; he told me the old men build these rooms for their senior sons. Kapeon and his children, who

live with him in the house, form the basic social unit of the Nabdam, the minimal lineage. The maximum lineage, which is the basis of clan structure, consists of men and women descended in an unbroken line from a single male ancestor. The clan unites one or more families in the worship of common ancestors, symbolised as an animal totem in their myths of origin.

At the end of a five-minute walk from Kapeon's house, we entered a clearing and greeted David's uncle Lamsin, the soothsayer, at the new house site. He was a tall lean figure with well-formed features framing wise, bright eyes. He and his helpers were completing a course of the walls. Two courses were laid, one at the beginning and one at the end of the day. It was now approaching siesta-time and the builders would soon retreat to the tree shade of a local beer bar till the evening cool . . .

I asked David, "What does a man have to do in order to acquire land and start a house?" With the help of an Elder, David related that a man . . . is eligible to build a house if he is the first born of a householder and has a wife with children. The implementation of this right constitutes initiation into an advanced state of manhood.

Lamsin first acquired land from the Tendaana, which was confirmed by the chief. He then began the preliminary rites by going to visit the soothsayer with an elder (even though he was a soothsayer himself). The soothsayer divined whether it was propitious for him to erect the dwelling, and the ancestors

answered to grant permission.

The second step was to clear the site. It is customary for friends and relatives to help the new house-owner, their numbers depending on his good reputation. Lamsin led a large work force of 20-30 men. Certain relatives must help on the first day of building, after which all helpers are rewarded with food and Pito (local beer fermented from guinea-corn).

Elders were informed about the day of gathering at the new house site; once they were together in their circle, the third step was to "try out" a fowl. A pot contained the roots of certain auspicious trees and water. A shallow dome lid was fitted creating a rough sphere. The bird was then sacrificed over this round. Its blood and small breast feathers were smeared on the lid and the body cast groundwards for its death struggle. The encircling audience waited in anticipation for its final resting position. If the fowl came to rest facing the sky then God and the ancestors were pleased and it was the correct site. If the fowl lay face downwards the site was wrong. The sky is synonymous with the patrilineal clan and the earth or "blood" with the female clan.

Lamsin got a negative result from the first trial and hurriedly consulted another soothsayer. He was told that his father, who had been a powerful soothsayer before him, still had a living influence over the village although he died in 1968 . . . The soothsayer concluded that the Juju must be exhibited at the new house site so that the people would see who was responsible for Lamsin's

continued

move to the new building. This was carried out and another fowl was sacrificed, producing the desired result.

A day was then selected for the women to fetch water for making mud bricks used in wall construction. The women started carrying water on the fourth day after the gathering of the Elders. The young men assisted in mixing the soil, which was left in mounds for the following day. On the day when house building commenced, the young men came out early in the morning to start turning the soil in preparation for the arrival of the Elders. The Tendaana accompanied them and laid the foundation by making his mark on the ground. He called on God and the ancestors, asking for a good beginning and a good end to the building and long and healthy lives for its occupants.

The mason (in this case Lamsin, or another mason if he had been unskilled) marked the plan of the first circular cell: without a compass he "dances" in a circle furrowing the ground with his toes. He made apparently perfect circular plans: when measured the plans

were highly accurate. The Elders debated the size and position of the room and the plan was erased and danced again until agreement was reached. Lamsin's room was first to be built, the next was for his wife, followed by those for his children and animals.

The granary, the most vital cell (its grain contents fluctuate from sufficiency to starvation level) symbolised the unity of the family. It was also the most beautifully formed cell, utilising material of superior elasticity — special clay mixed with cow dung, straw and okra sap.

Before the "wet" bricks were laid for the first room, Lamsin sprinkled protective water from the sacrificial pot into the furrowed circle. He and his helpers formed round lumps from the mixed laterite mounds positioning them round the circle. They began at about a foot in diameter and decreased with each subsequent course. The wall tapered from a foot at the base to between four and six inches at the top. The courses measured 12", 15". Lamsin showed that a pitched roof required

six courses and a flat roof seven, producing walls between seven and eight feet high, kept vertical by hand and eye alone. When struck, after drying, they resonated with the pure timbre of a well made pot. The walls were plastered with a mixture of cow dung, clay and vegetable juices, worked with wooden trowels, then sized with an extract boiled from Dawa Dawa pods. The finish was a reddish-brown colour, providing the ground for wall decorations of animal proverbs. These paintings, executed in the local earth paints of red, white and black, are usually made by a man's wives in competition for his valued praises. The finished wall lasts between two and three years.

A pitched roof (average gradient 1:1½) was erected on the mud cylinder, first using a half octahedron constructed with four main rafters. Their forked ends were thrust into the drying mud at the eaves and bound at the crown with rope. Lamsin judged their position and filled in the conical frame work between the rafters of the original pyramid. The added struts were placed at 18" centers



Above: mixing the mud. Below: Lamsin "dances" the circle. At left: the first circle, with sacrificial pot and feathers in foreground.

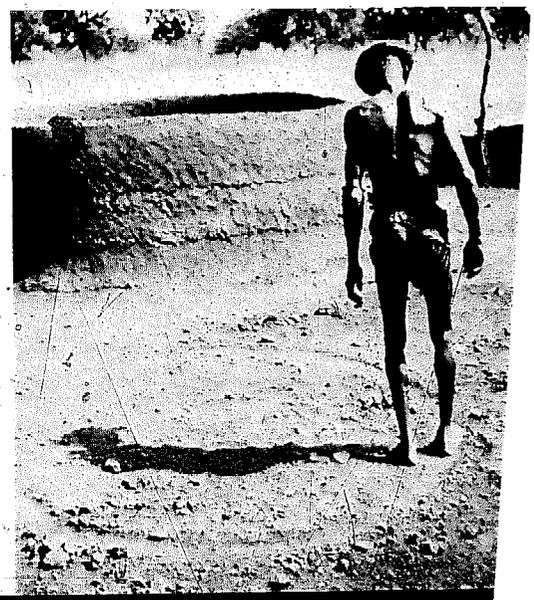



Above: Lamsin working. Below: forming ben coops at goat house.

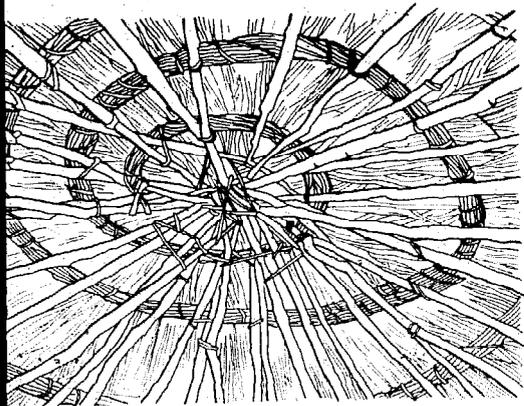

around the top circumference of the earth drum. A rope was laid in a spiral over the rafters and lashed down to form a purlin support for a covering of thatching mats four inches deep. These were rolled on, tied back to the rafters and finished at the top with a woven grass knot or a broken pot. A good roof lasts for about three years.

Flat roofs were made with a basic structure of six inch diameter joists supported on forked timber columns equally spaced around the inside of the earth drum. . . . The columns carried the roof weight independently of the walls. A layer of two-inch joists placed over the base joists in the opposite direction were topped with twigs and bark, covered with laterite mud and a crust of laterite gravel. Laterite also makes immaculately smooth floor surfaces. Gargoyles to drain rain water were let into a parapet wall rising about a foot above the rooftop.

The first two rooms built had small shield walls attached to them. The first food was cooked here by Lamsin's wife. This T.Z. (millet gruel) is called dangerous food (sage bee). It was eaten in private by the cook and her husband. The food symbolised that he was now a man who could look after himself and guide his family through all life's hardships. Once the first two rooms were standing, the goats, sheep and cattle were confined well away from the area. If they had strayed onto the site and slept there before Lamsin and his wife, he would have broken down the construction and rebuilt it next year.

The house was fortified against such animal influences when the first room was cut open and Lamsin and his wife spent the night there together.

When the compound was completed Lamsin held a feast for all who helped raise it. He directed the Pito be brewed and himself slaughtered several guinea fowl. Young and old came together in the cool of evening-time and sat down to a special T.Z. containing meat (which is rarely eaten). The party soon became loud and joyful - children lithely danced and chased one another, lovers looked on, decked out in their brightest print clothes and old boys grated their cola-nuts on perforated sardine cans. The ancient Elder stood up. Calming the raucous enjoyment he turned his face to the failing light in the sky. He called on God to be present and grant riches and long life to Lamsin's family and all those who had toiled in the earth to make the new house.

On the day David and I parted we visited Bolgatanga market together, where he helped me buy a local smock. He told me that he studied at Agricultural college and expressed a desire to travel abroad and learn poultry farming to help his people - I believe he will probably do this. Perhaps soon, irrigation projects will bring water to this area making cash crops a possibility and subsistence farming culture will recede into the past. Hopefully a few 'traditionally' educated young men like David, who are not afraid of their culture, will help humanise 'modern progress.'

Farming

Farming, along with other human activity, is totally regulated by the climate. Dry season hoeing and weeding begin in early February and manuring (with highly prized animal droppings) carried on through the hottest months of March and April. Then the rains break in mid-May, with torrential burst and sporadic electric storms, violently cooling the unbearable humidity preceding them. The Volta basin becomes waterlogged five hundred feet below the well-drained fertile plateau farmed by the Nabdam. Here the Savannah woodland landscape of wizened trees uniformly dotted on monotonous plains of stunted, bleached grass tufts, explodes into lush greenery. Grasses that will eventually grow shoulder high are dotted with the colors of flowering trees. Early millet is now sown, followed by other high protein cereals (such as guinea corn, sorghum and maize) which are interplanted with various beans and Fra Fra potatoes.

Other crops include okra, ground-nuts, sweet potatoes, gourds, melon, tomatoes and hibiscus. Further weeding continues through June, July and August; harvest time follows, with the cessation of the rains, from late September to mid-November. . . . every hour from sunrise to sunset is devoted to farming. After harvest the pace of life relaxes. Some of the young men go south to work in industries such as timber and cocoa; the remainder spend their leisure time dancing at harvest festivals or hunting with the old men. □

Rendille

The Rendille are nomadic shepherds of northern Kenya who travel with sheep and goats and carry their belongings on camels. In 1975, architect Anders Grum and his family lived and moved with the Rendille for seven months, photographing and documenting their life, "... in particular from a mobility and shelter point of view." These photos show the Rendille arriving at a new camp, unloading, and setting up their portable shelters.

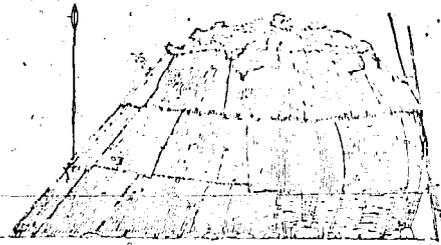

Side elevation

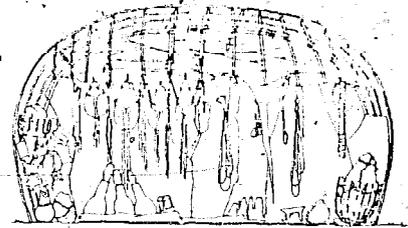

Longitudinal section

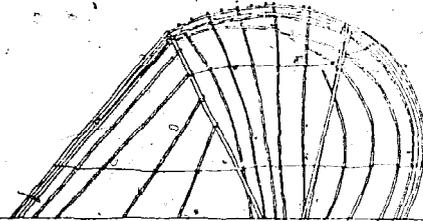

Cross section structure

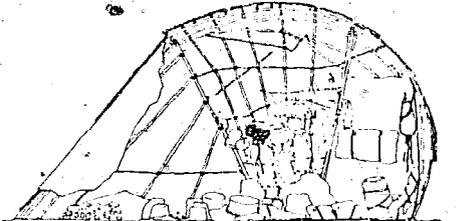

Cross section

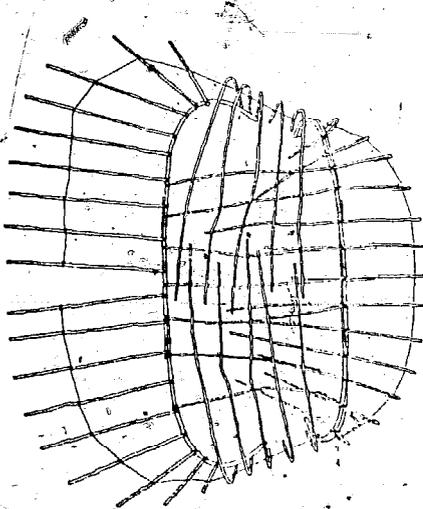

Plan of structure

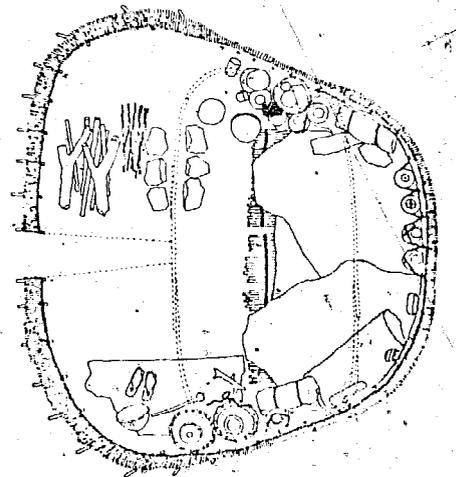

Floor plan

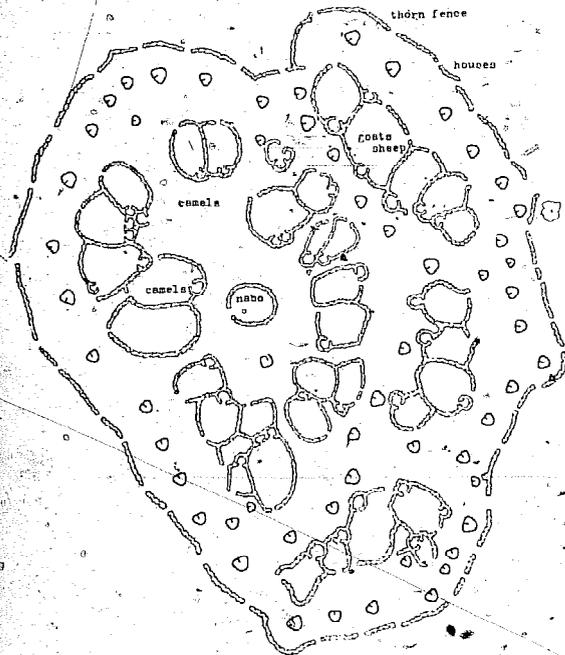

Plan of Gob Wambile - nomadic settlement of the Rendille

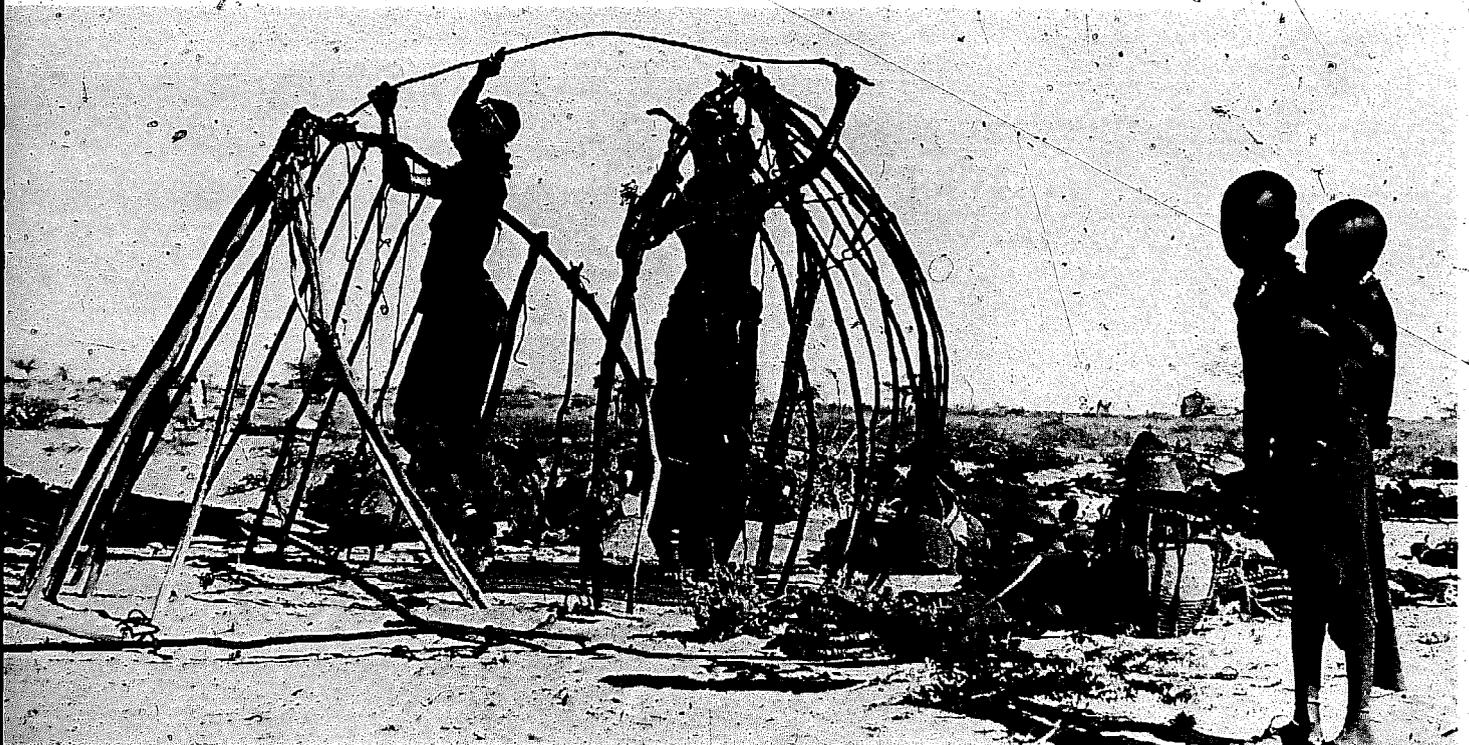

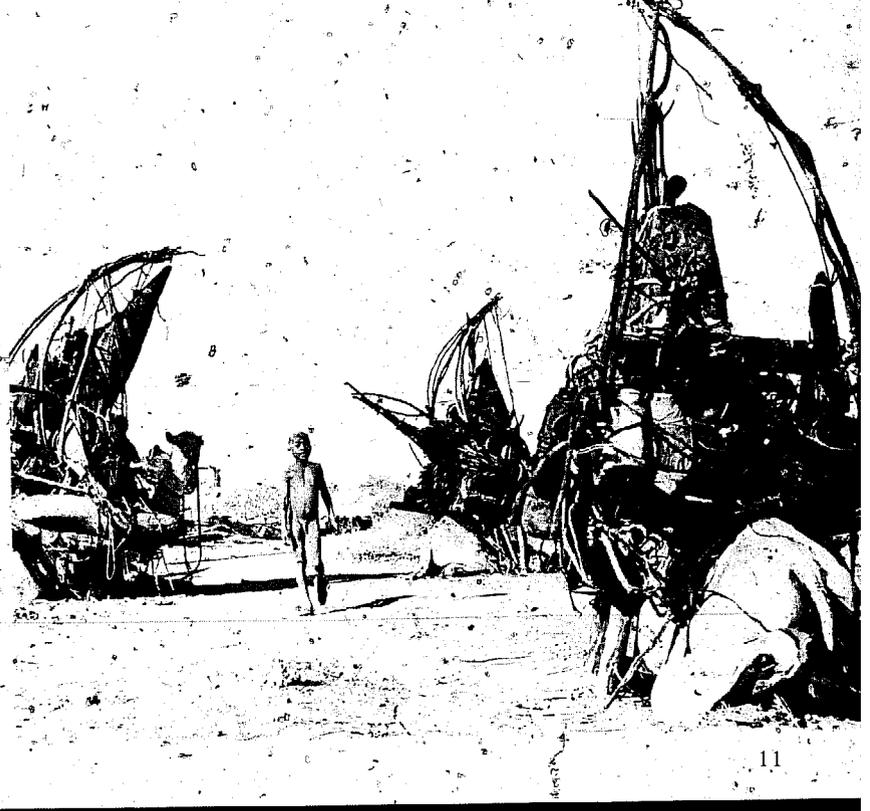



East Africa

by Jack Fulton

Top left: granaries for corn and vegetables in family compound in Lambwe Valley, Kenya. At left: home in village, Mwsambweni, Kenya. Below: structures of El Molo tribe, Lake Kenya.





Above left: *Mwasambweni, Kenya.* Above right: *Lambwe Valley, Kenya.* At right: *school building under construction, Kwale, Kenya.*

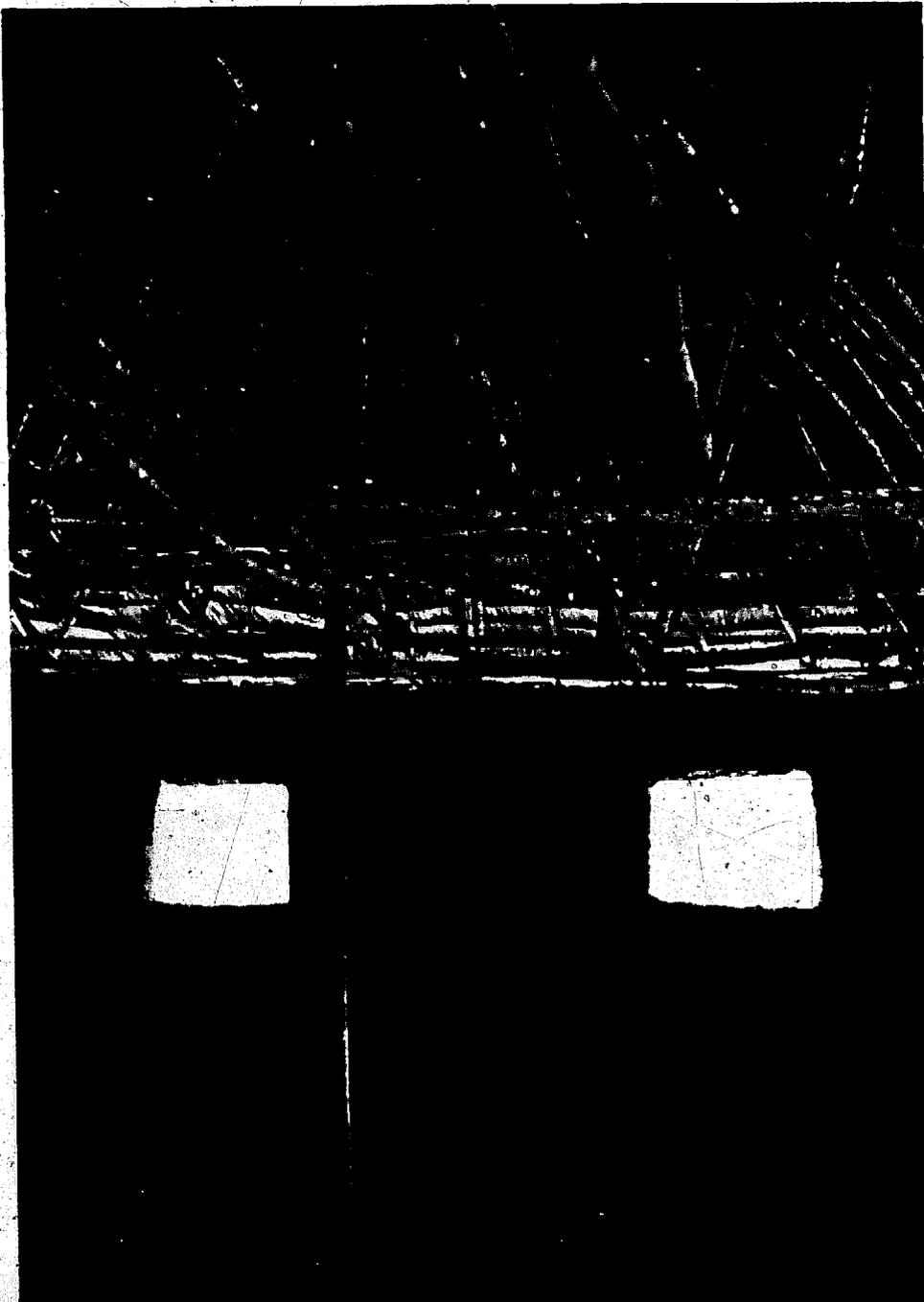

Disaster Housing

by Ian Davis

Whenever a natural disaster takes place (and it is a frequent occurrence since one takes place every 85 days somewhere in the world), the media refer to the problems facing "homeless" victims. Then, in a major disaster, the public responds with their gifts to relief agencies and within a matter of hours jet transports are en route for the disaster scene. Inevitably there will be tents and possibly other forms of "temporary shelters" on board along with foodstuffs and medical supplies.

Recent research that has been undertaken for the United Nations Disaster

Relief Co-ordinator (UNDRO) has revealed that there are rarely, if ever, "homeless victims." Despite the fact that their homes may be on the ground following some earthquake, or washed away in a flood, the victims of natural disasters show high levels of initiative in rapidly providing shelter for their families. This may involve moving in with friends or relatives, improvising a simple shelter out of anything at hand (probably rubble from ruined buildings) or the rapid reconstruction of their shattered home. Or it could involve all three activities.



Above: improvised housing in Peru following the earthquake of May 1970.

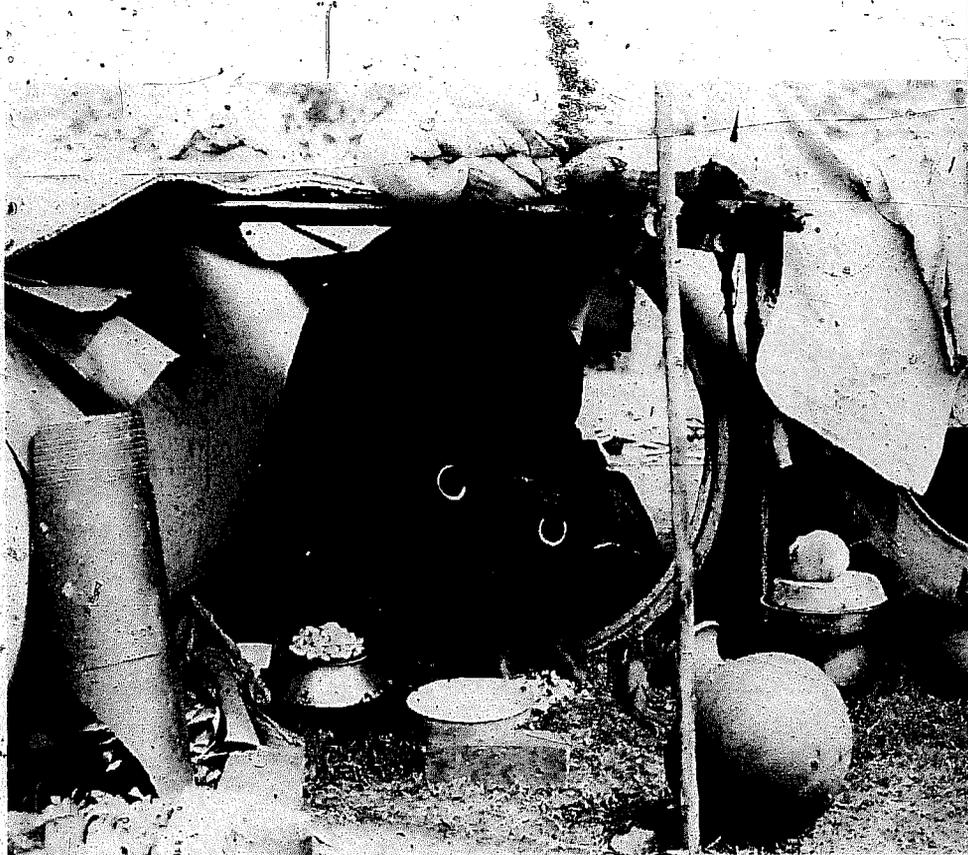

At right: improvised shelter at a refugee camp near Calcutta following the mass migration of refugees from Pakistan in 1970. These sewer pipes provided temporary shelter for 12,000 refugees.



At right: the Amdanga refugee camp was set up in a temple courtyard in India, during the Bangladesh disaster. 30,000 refugees stayed here in simple A-frames with thatch covering.



At left: improvised housing in Sudan following migration to search for food during the drought of 1973-75.

Below: a yurt-type shelter in the Republic of Djibouti, Africa in 1977. These refugees were displaced in the war in Ethiopia.





House reconstruction six days after the 1976 Guatemala earthquake.

In February 1976, within 24 hours of the Guatemala earthquake, it is estimated that 50,000 of these shelters had been erected in the city streets and parks. Their form varied, some were made from rubble, others from normal city refuse—packing cases, scrap metal, etc. Their functions were to provide shelter for a family, a staging point for future action, a place for animals and surviving possessions. In November 1976 Turkey suffered its worst winter earthquake for 40

years. There were fears that the surviving population would die from exposure in sub-zero temperatures. However, despite considerable hardship there is no evidence of deaths from exposure. Some families interleaved several tents inside each other, thus providing a cellular protection from cold. Other families dug into the ground and put simple roofs over their holes, thus obtaining warmth from the soil below frost levels.

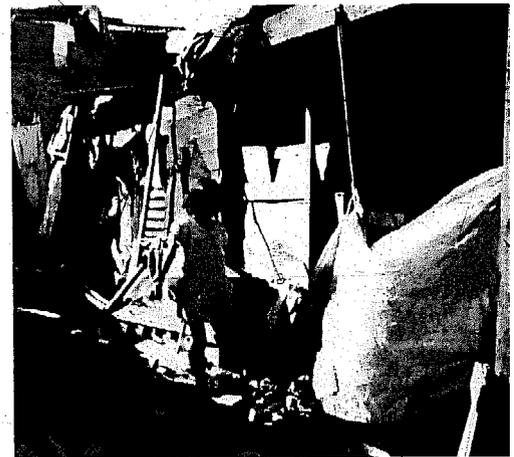

At left: a relief parachute over an abandoned bus to form a temporary home in Dhekelia, Cyprus, 1975.

Iquitos, Peru. When the river Amazon floods, which is an annual or biennial event, these houses built on wooden rafts ("Noah's Arks") float to the surface.
Right: dry season; below: during flood.



These basic improvisational skills are a normal part of life within the Third World. In some instances these skills are used to prevent disasters from destroying homes, such as the "Noah's Arks" of Iquitos, Peru. Periodically the river floods and up float the homes!

These skills are crucial factors in recovery after a disaster. Western aid givers can learn to avoid placing obstacles in the way of these innovative skills. Such

obstacles include: forcing survivors of a disaster to move to a new location away from their ruined homes and belongings; the burning or bulldozing of rubble (on the false assumption of disease risk) — thus destroying the essential building materials that families need for rebuilding; and finally free handouts — thus destroying local initiative which is a highly therapeutic process following the trauma of a disaster. □

New Guinea

by Ajit Mangar

Located between the Australian and Asian continents, Papua New Guinea occupies the Eastern part of the island of New Guinea and the surrounding smaller islands to the East. . . . The individual family is the basic unit for gardening and care of children, but kinship groupings still play a very important role in the daily lives of the people. The tribal laws, public opinions, mutual obligations, and religious beliefs control the overall behaviour of the society.

Except near the town centres, houses are built of local timber, grass or palm leaves. The design and the construction techniques vary from place to place, some dwellings are round, some rectangular, some are built on stilts and

some on the ground, which is used as the floor. The structures are light, earthquake resistant, climatically cool, and the walls and openings are ideal for ventilation, especially in the coastal areas.

Most structures decay due to weather and insects. The fire hazard is also great and large scale destruction of villages is often recorded.

The attitude towards houses varies greatly in different parts of the country. Some remain temporary huts while others are elaborate and skilfully constructed. In some areas no attention is given to the decoration, whereas in others it is considered as essential, and the artists and craftsmen are the most respected people in the community

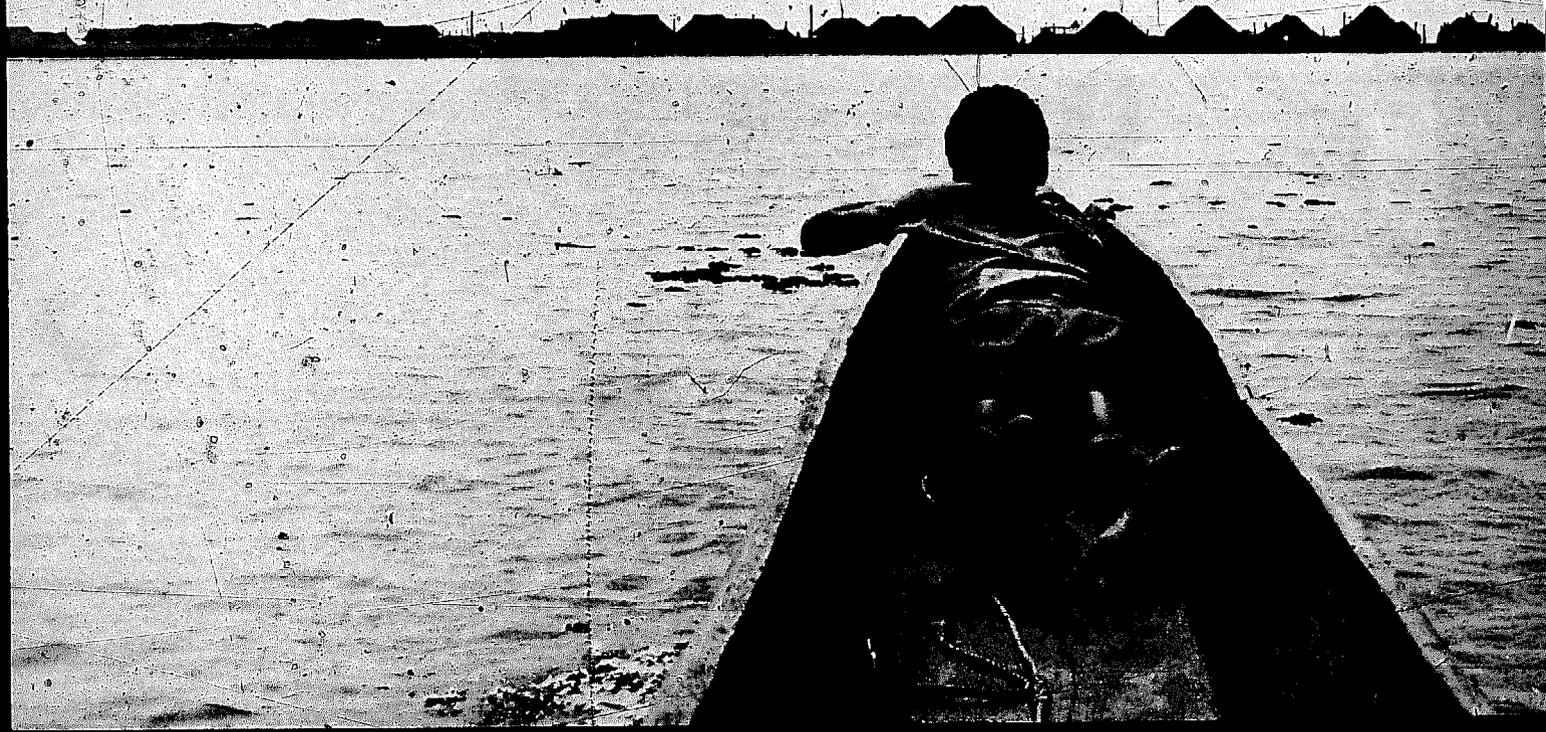



Papua New Guinea is a nation of separate villages rather than a closely knit community with a national consciousness such as might be expected in any Western nation. The fragmentation exists because of the difficult topography, a great diversity of physical types, a total of 700 interrelated languages, self-sufficient traditional village economy, and warfare between the neighbouring tribes, which keeps people separate. Presently the society is living through a period of very rapid social change. For some groups, who have been exposed to the Western way of life for almost one hundred years, this has meant a drastic change in their way of life and attitudes. In other cases, because contact has been recent, very little has changed and the people live very much as their forefathers did.

Self government was achieved just over a year before independence in September 1975. All current development policy is guided and inspired by a set of aims approved by the Government in March 1973, popularly known as the eight point plan. The aims highlight the urgent need for decentralization, equal distribution of economic benefit, rural improvement and self-reliance. Within the context of this policy an urban housing programme was launched which covers a broad range of social, economic and geographical conditions. □

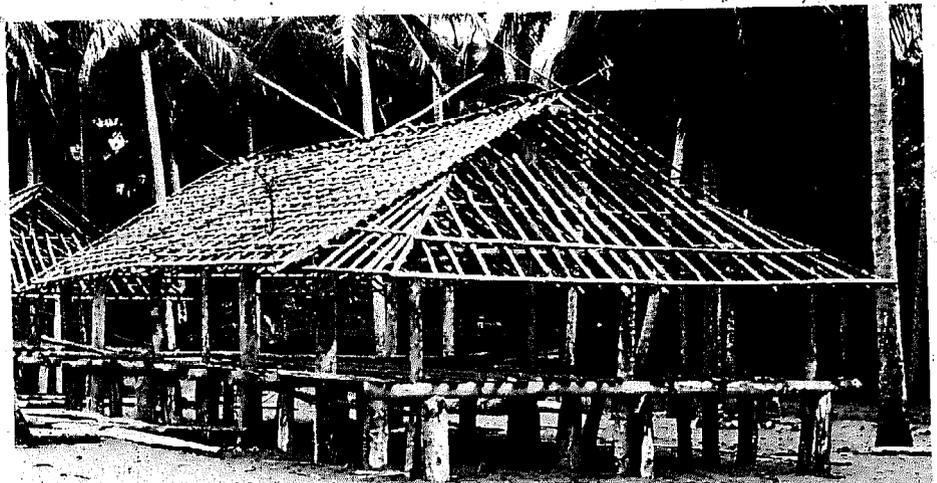



Floating Islands on Lake Titicaca

Urus

by James P. Warfield

The Urus Indians live some 12,500 feet above sea level on Lake Titicaca near the town of Puno, Peru. The Urus rely upon the use of one building material, *totora*, a reed which grows in the shallow areas of the lake. The Indians of this entire region of the high plains use *totora* to build *balsas*, reed boats made from bundles of reeds bound together. The reeds are often also used for sails. But the Urus are unique in that, having chosen to live on the lake, they utilize *totora* to build immense islands, which initially float on the water's surface.

Reeds are cut near the shoreline and towed in large piles to the island site. Eventually, a spongy surface is formed, capable of supporting weight. Shelter is built, also utilizing reed, and in time, earth is hauled from the mainland to create "fields" on the islands so that potatoes and other crops may be cultivated. Maintenance of the islands is a continual community effort, for as the reeds become water-logged, they sink. Thus, surface reeds must be renewed in order to maintain the island above water level. □





Pacific Islands

by D. Stafford Woolard

Despite limited resources and a low level of technology, traditional houses are often more efficient resource converters and climatic filters than modern structures. In many places, including the Pacific Islands, these techniques and skills exist today.

Can any developing country afford to ignore this great potential for housing solutions? As general energy sources decrease and the cost of imports from the developed world increase, the potential of the total local resources in housing will assume more importance.

On these pages are photos of housing in the Solomon Islands, the Fiji Islands, and the Gilbert Islands.



Solomon Islands



The Solomons consist of high islands and low atolls. The climate is hot and humid, with regular winds and rainfall. There are two main housing types: the bush house, with low walls of vertical split timber, is found inland and in high areas; the coastal house, the most common, has woven wall panels, a veranda, and raised floor.

The house frame is constructed of timber, split from the bush. Wall and roof elements, as well as the house plan, are laid out on a one-fathom (1.8 m) scale measured with outstretched arms. The house is generally built using prefabricated elements in about ten days as a community project. A conventional structural frame is built, then sheathed

The coastal house has a raised floor, built of split timber, laid round side up, thus sand and dirt fall through, and breezes are drawn through the floor for cooling.

Walls are lashed to the framework with gine and, in many cases, are designed to blow off in cyclones, thus protecting the main house from destruction.

The beautifully detailed roofs are made of ivory nut leaf, folded over and stitched along a bamboo rib. The panels are dried and lashed to the structure; the closeness of the panels determines the quality of the roof, the distances being measured with the fingers. Many roofs are replaced in ten years, but a well built roof can last 25 years.



Fiji Islands

Fiji's climate is temperate, with high temperatures and consistent trade winds. House forms relate to the three main island climates. In the coastal, wet zones, with high rainfall and humidity, and small diurnal temperature range, houses are lightweight, well ventilated, with well insulated roofs. In the coastal dry areas, with continuous trade winds, average rainfall and humidity, houses have more insulation in the walls. In the highlands, with varying rainfall and large temperature variations, the houses have thick walls and roofs, with little ventilation. The construction of a

traditional Fijian house is undertaken as a concentrated effort involving many people over a short period of time. Once completed, the structure is sealed and a fire lit inside which forces smoke into all parts of the thatching as a deterrent for bugs and beetles. The main structural frame of these houses is heavy logs, with bamboo used as secondary material, resting on a stone base. The earth floors are built up above the surrounding ground with stone retaining walls, and covered with grass mats. The walls in early houses were very low,

sometimes to the ground. In coastal areas walls are woven split bamboo to allow breezes to penetrate. Other wall materials are woven reed or grass, and reeds and bamboo compacted into a dense material. The steep roof pitch not only sheds water well, but allows only the ends of the thatch to be exposed, thus increasing the roof's durability. With regular maintenance and smoking, the roof will last 20 years. An important part of the Fijian roof is its free form rafter, which protrudes from each end of the ridge.

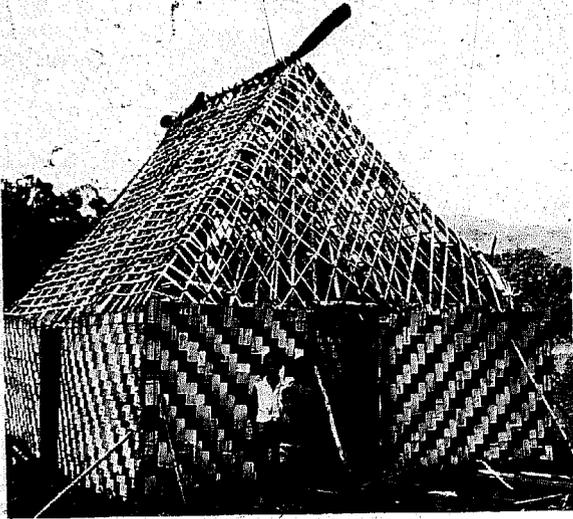



Pacific Island structures place most emphasis on the roof. Most time, effort and thought is given to that part of the house that excludes the climatic extremes of sun and rain.

Gilbert Islands

Located on the equator, the Gilbert Islands are comprised of 16 atolls, which have a maximum height of five meters above sea level. The climate is warm and humid with frequent trade winds blowing. Rainfall is seasonal with long periods of drought.

Traditional house forms are consistent throughout the islands; the basic house consists of three parts: sleeping, storage and cooking areas. The most important part is the sleeping area, which has a raised floor, minimal walls, and low roof. There is no internal subdivi-

sion of space and no internal furniture or fittings.

The traditional Gilbertese house is largely prefabricated, with specialist completing each component. The pieces are then assembled on site quickly. The main structure is of pandanus timber with subsidiary members of split coconut and coconut mid rib. Walls are usually woven panels hung on strings from the roof structure. The most substantial part of the house is the roof structure which is prefabricated on the ground then lifted on to the four-corner posts. Roof pitch is about 45° and there are small ventilating areas built into the ridge. The roof form is hip ended.

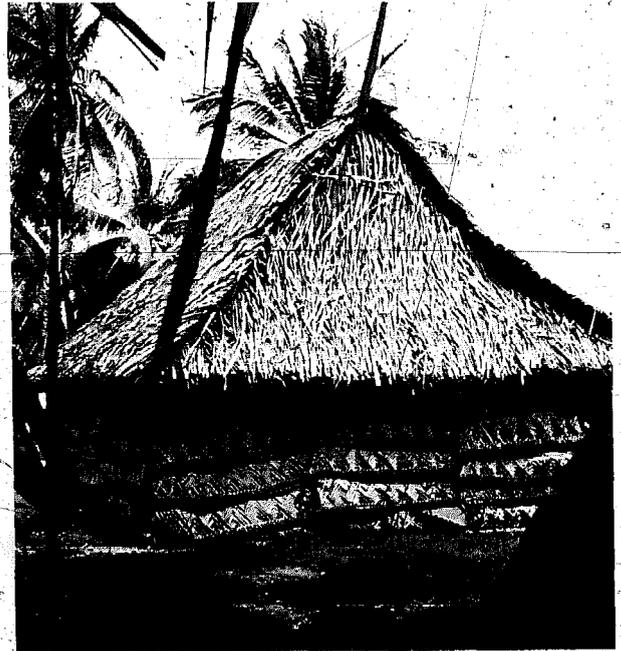
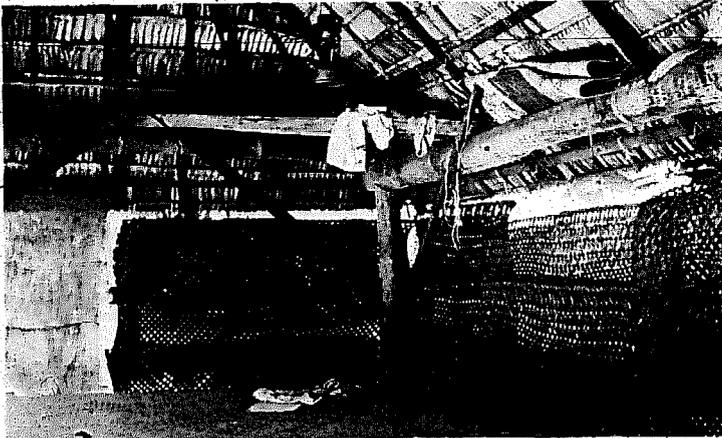

Conclusion

In all cases described the houses have been constructed from renewable local resources which were available at no cost. All houses seem particularly well suited to the climate, the living patterns of the people and skills developed through time.

In fact traditional houses are often more advanced in technical concepts and thermal comfort than the designs which are replacing them. These modular houses are constructional systems and are independent of the house plans. As people become urbanised and desire an urban subdivided form of lockable dwelling, these would be quite feasible using traditional techniques. □

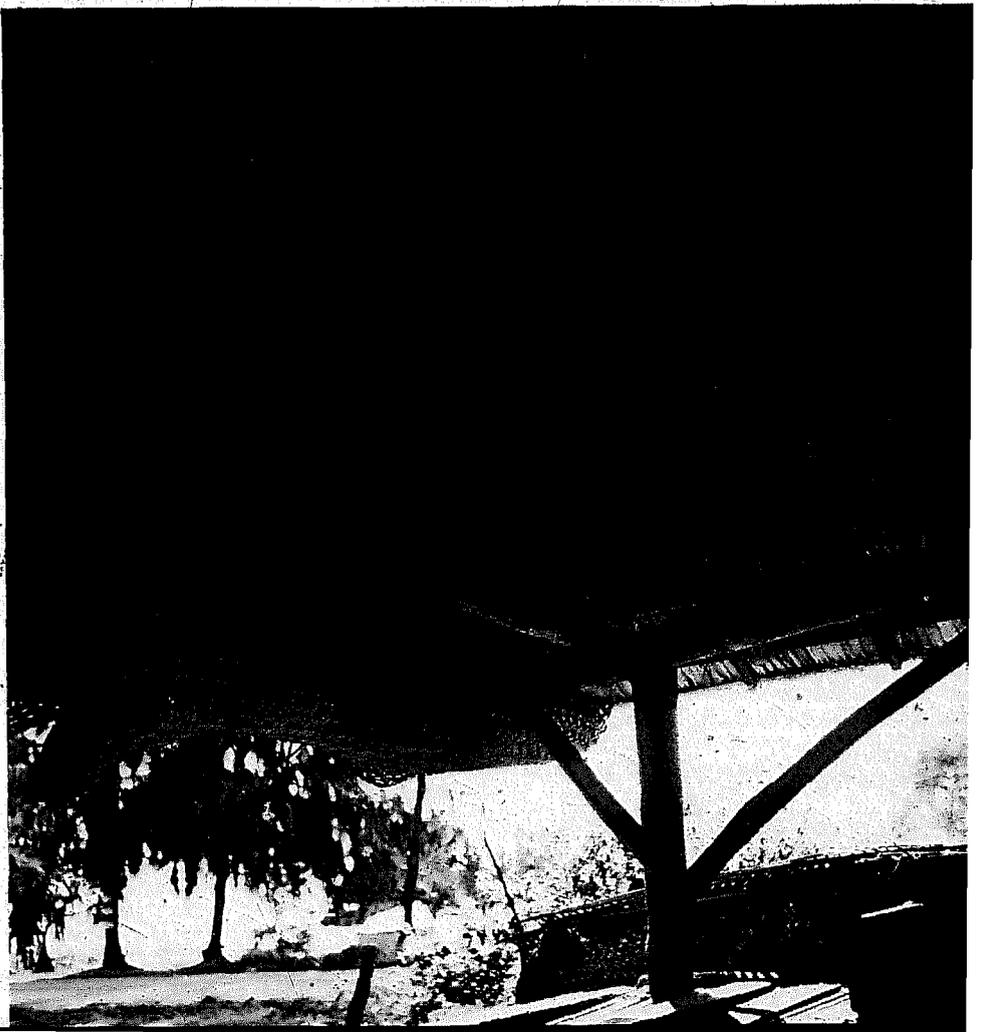

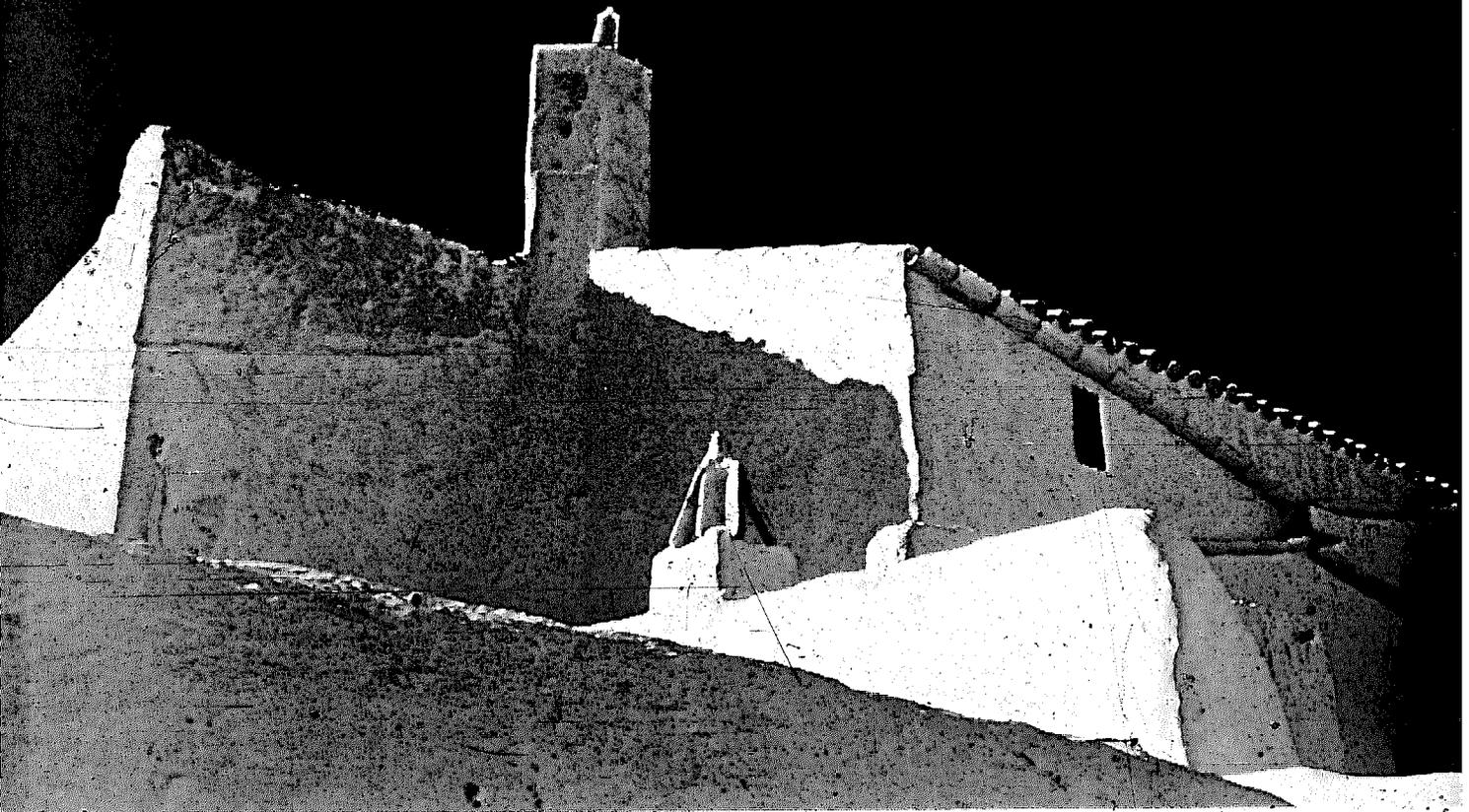

*Sloping gutters on wall channel water
into underground storage cisterns.*

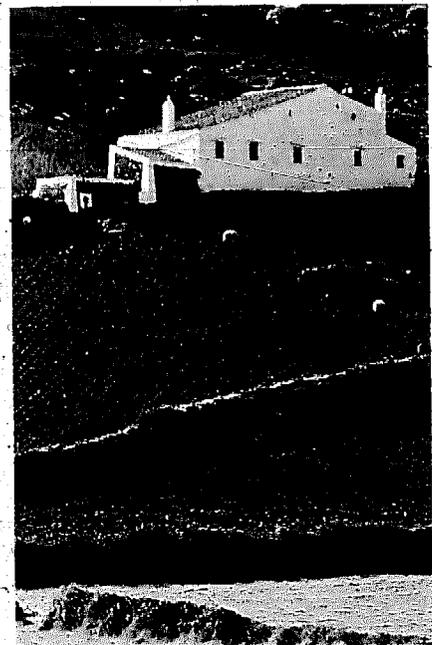
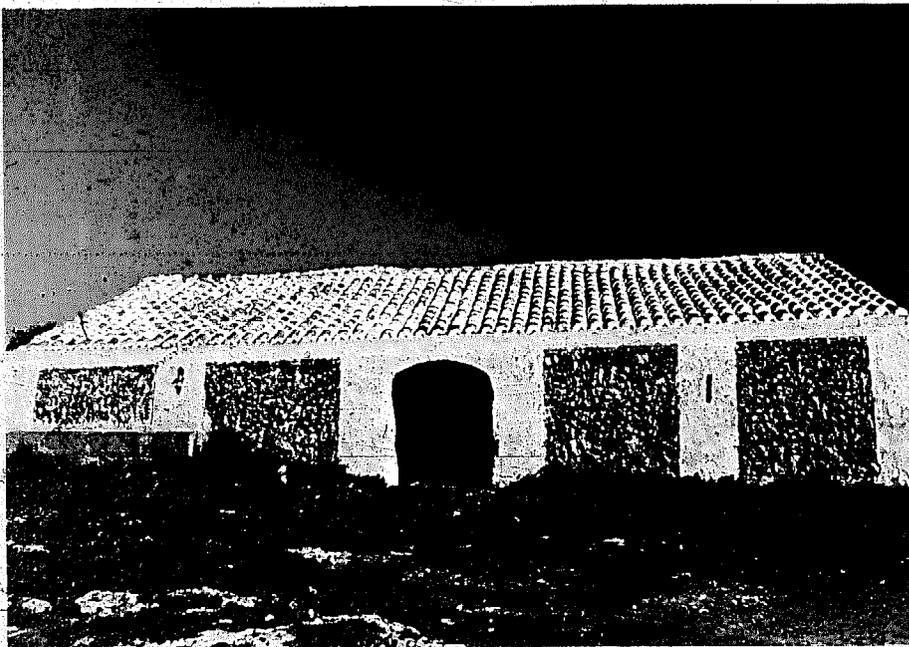

Menorca

Photos by Regan Bice and Josep Mascaró

On Menorca, one of the Balearic Islands off the coast of Spain, is a unique collection of old farmhouses, built in phases over long periods of time. Since wood was scarce on the island, building materials were rubble rock, quarried limestone, ceramic tiles for roofs and floors, and limited amounts of wood for ceiling beams, door, and windows. Exterior and interior walls and ceilings are whitewashed annually to protect the masonry.

Due to a shortage of water, rain water is collected from the roofs and funneled into underground cisterns. Sloping gutters are built into the walls, or inverted roofing tiles are mortared together, circling the entire house to direct water into the cisterns. Farmers often block the first rain of the season, so that the roofs and gutters are cleaned before water is collected. The cisterns are often small quarries, having supplied the limestone for building the house. They hold up to several thousand liters, enough to last a family through the dry summer until the next rainy season. □

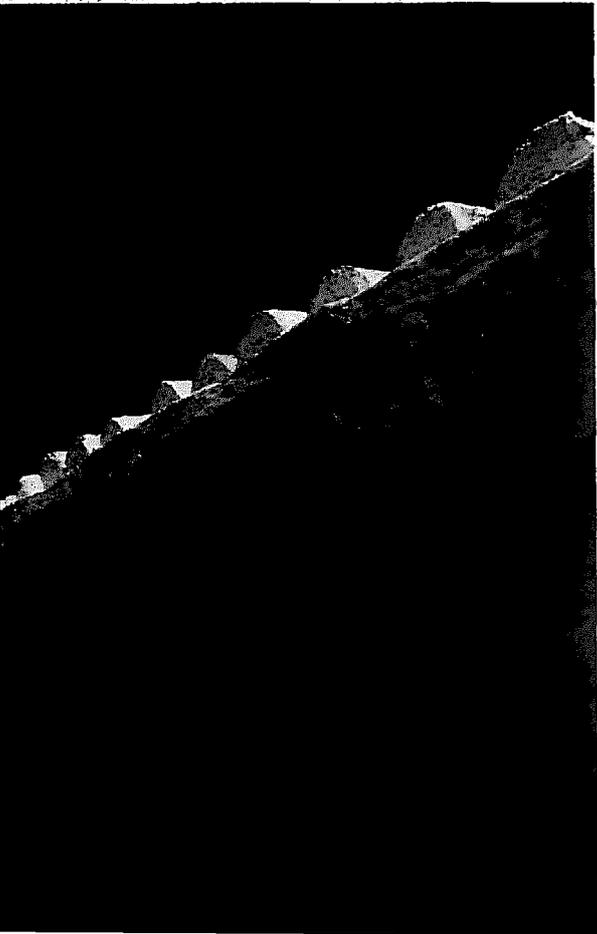
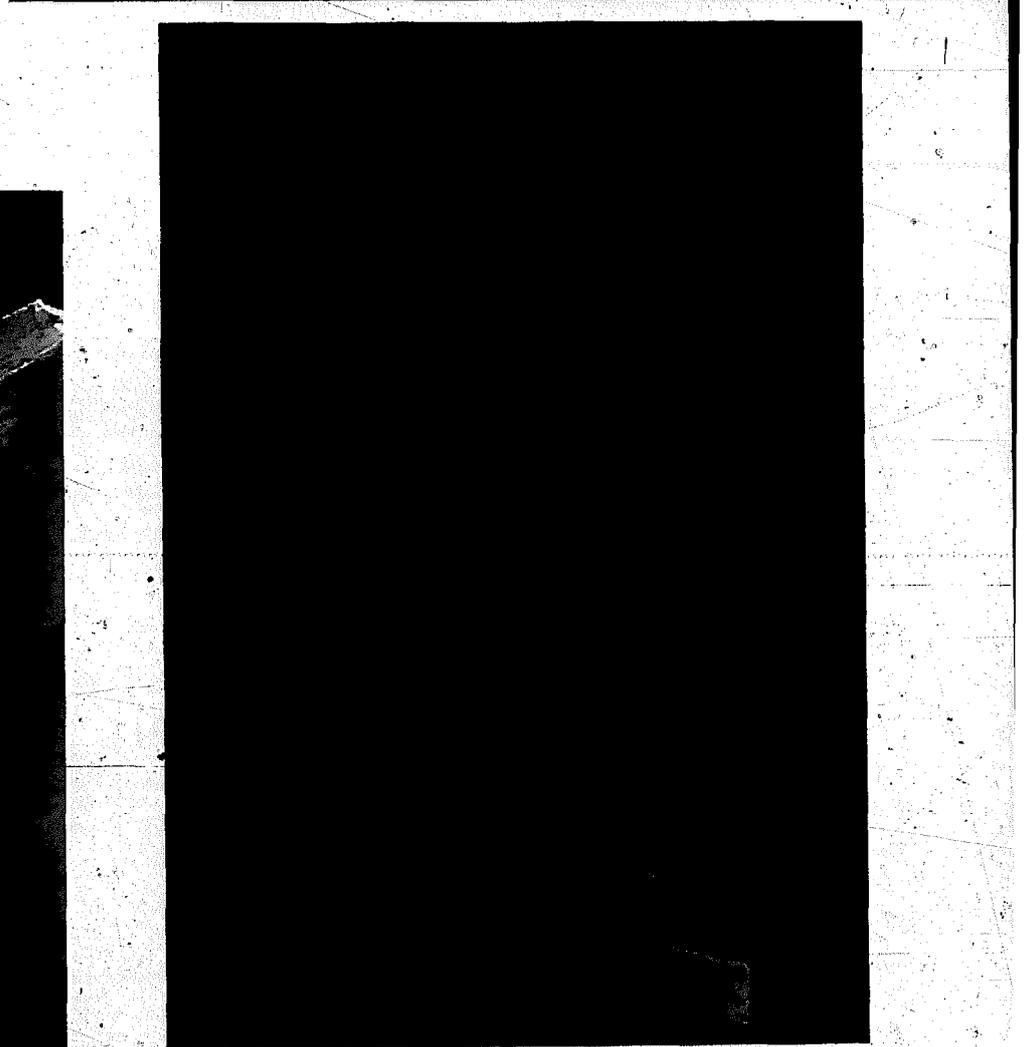
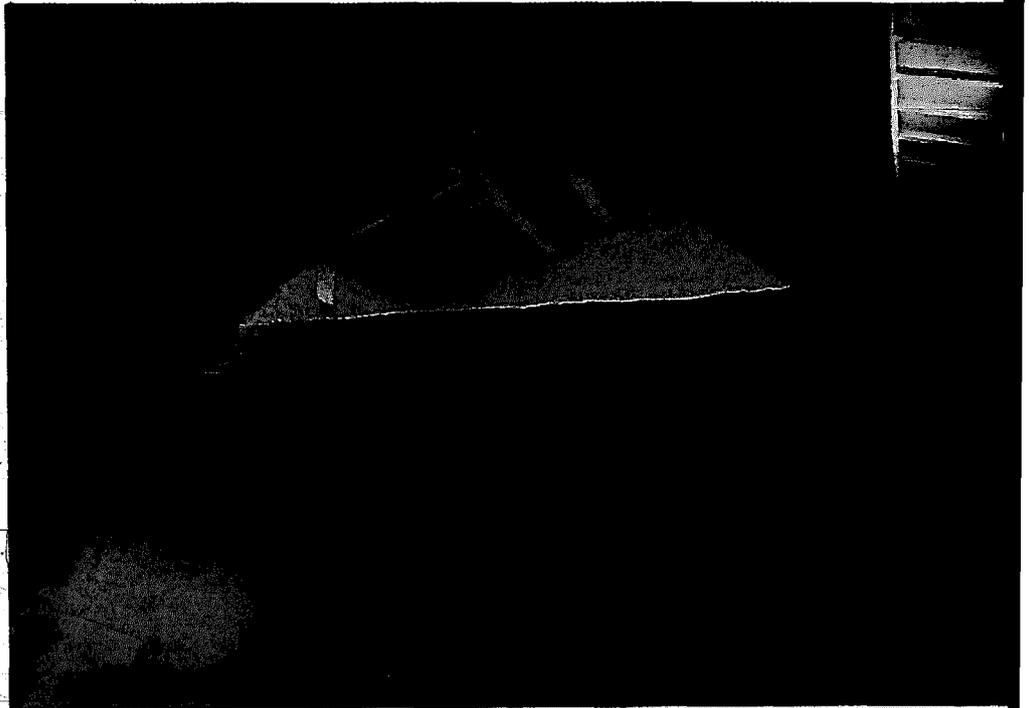

Turkish Yurts

by Suba Ozkan

There are two main types of mobile shelters of the nomadic Turkish communities. One is the black tent (*karakadir*) a tension structure of goat hair fabric and ropes supported by three or more posts. These tents can be seen almost anywhere in Anatolia. The other type structure, now rare and limited in number is the dome shaped tents with ribbed wooden framework and felt covering, known in the Western world as *yurts*, and in Anatolia today called *alaciks*.

Throughout history the *alacik* has been utilized extensively by both Turks and Mongols, with the general consensus being that the shelter is of Turkish origin. Different Turkish communities give it the same name with some differences in pronunciation. In Anatolian vernacular the word *alacik* is sometimes used as a general reference to shelter.

Archaeological traces of *alaciks* go back to the Huns of Asia. And one can even today observe yurt type shelters, almost identical to those in the 16th century miniatures and battle scenes.

The *alacik* was adapted to Central Asian climatic hardships. The need to search for fresh pasture required mobility, the extremes of hot and cold called for alternate insulation and ventilation, and strong winds of the steppes necessitated structural stability. The ribbed skeleton and domed structure with multiple layers of felt and varying venti-

lation possibilities, makes the *alacik* ideal for this climate, and for nomadic existence. *Alaciks* are the mobile shelter type in the Turkish states in the Soviet Union like Uzbekistan, Turkestan, Kirghizistan; in Sin-Kiang in China; in Northern Afghanistan, Iran, and Anatolia.

There are two basic types of *alaciks*:



- *catma ev* (frame house): the primitive version, with elliptical or circular ribbed-cage skeletal structure. Its wooden sticks are curved into U-shapes, and both ends planted firmly in the ground to form the basic structure.

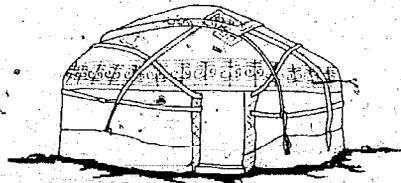

- *topak ev* (round house): miniaturized version of Central Asian yurts. The frame of one type consists of

20 vertical and 20 horizontal ribs of flexible juniper wood, the ends sharpened for driving into the ground. Horizontal ribs are tied to verticals with hair rope or leather thongs, making a rigid lightweight structure. This is covered with several layers of felt, then tied around with ropes for the winds. To prevent wind uplift of the felts, stones are hung from a skirt attached to the circumferential ropes.

The nomadic *topak ev* dwellers do not carry the *alacik* ribs with them when travelling: each family has two sets of sticks. One is hidden in the highlands, the other in the Mediterranean lowlands. This eliminates the major burden of moving.

The north side of an *alacik* is generally the storage area, with the entrance opposite, to the south. The material stored to the north provides insulation on the coldest side. Milk or dairy products are stored close to the entrance, away from the fire. There is usually an opening at the apex of the *alacik*, opened and closed alternately for ventilation or heat retention.

The more advanced *topak ev* type *alaciks* are now almost extinct in Anatolia. They are used by Turks who immigrated from Central Asia, as summer dwellings while grazing.

In structure, the *catma ev* is a doubly-curved framework, while the *topak ev* is more like an umbrella.

Central Asian weather changes are adapted to by having a single felt layer in the summer, five to eight layers in the winter. In today's surviving *alaciks* polyethylene is sometimes used for weatherproofing, with inner layers of felt.

An *alacik* with a circular plan in Korkuteli, Anatolia (Catma Ev).

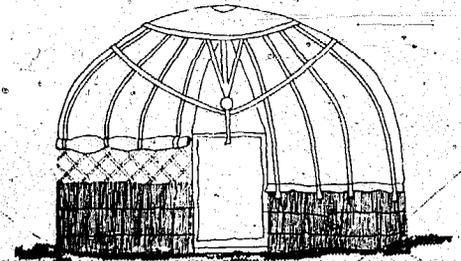

Turkmen (Afyon, Anatolia)

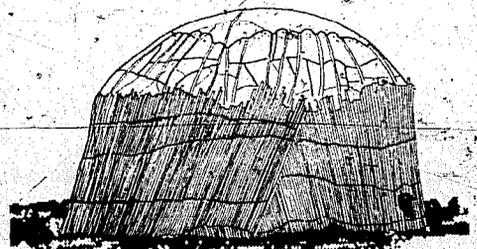

Turkmen (Ulukisla, Anatolia)

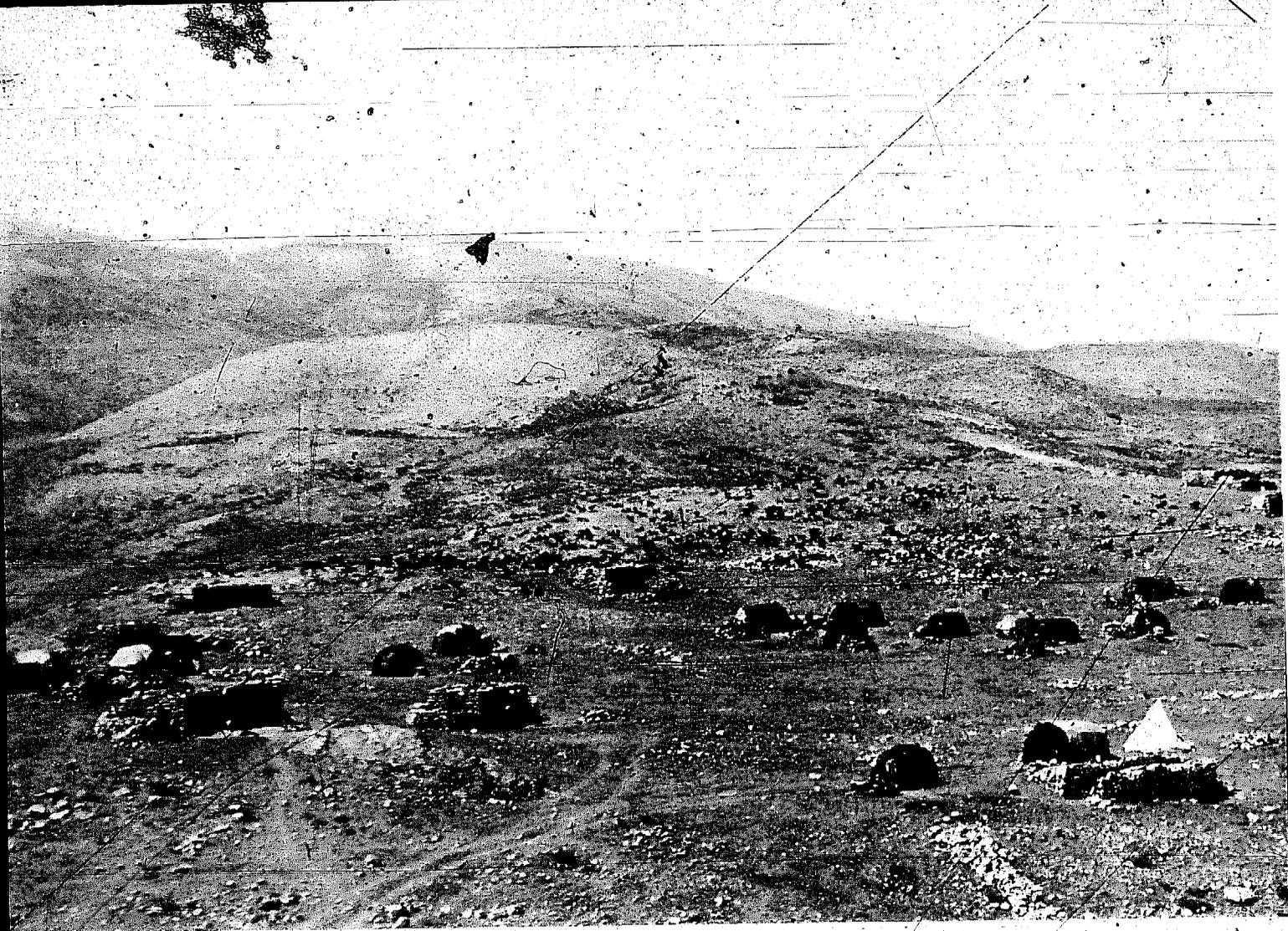

Nomadic community of alaciks camped on Bey Mountains, Anatolia (Catma Ev type). Stone shelters built for livestock are permanent.

Erection of topak ev type alacik:
 stretching the *keregu* gills
 placing *keregu* to form cylindrical base
 erecting center post
 putting *dugnuq* (roof structure) on top of post
 inserting *aq* sticks to *keregu*
 tensioning wooden skeleton by tying with horizontal and diagonal belts
 covering with layers of felt
 placing top leather piece with radiating belts
 connecting these belts to bottom circumferential rope

This process takes about 25-45 minutes. When the shelter is moved it never exceeds one camel or mule load.

For summer ventilation the layers of felt are rolled up and tied so the sides are open, or they are maneuvered so there is cross ventilation between the sides and the top opening. Reed mats (*ciq*) are usually wrapped around the open alacik framework in summer as insect barriers while a steady flow of air is maintained.

The wooden skeleton of the *topak ev* lasts about 20-25 years while the felting must be renewed every 6-7 years.

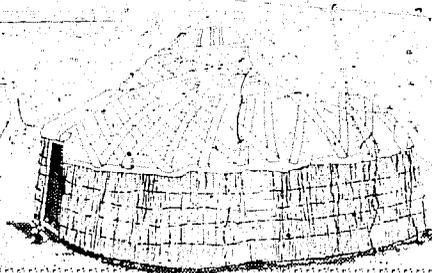

Uzbek (Kaitak)

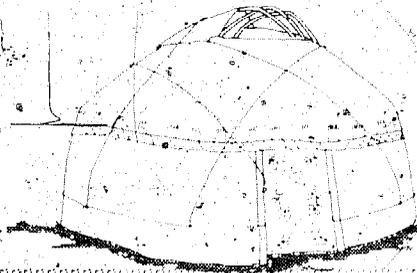

Kirghiz (Southern Kirghizistan)

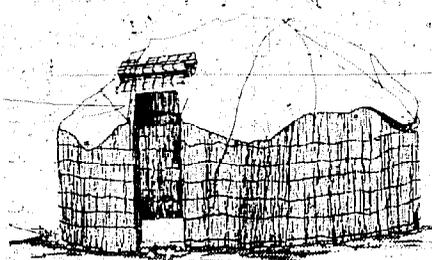

Turkmen (Northern Afghanistan)

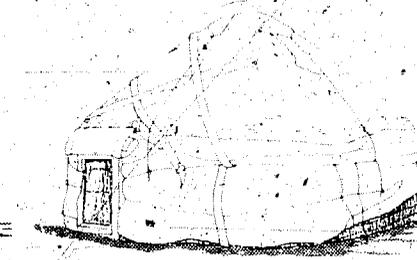

Kazakh

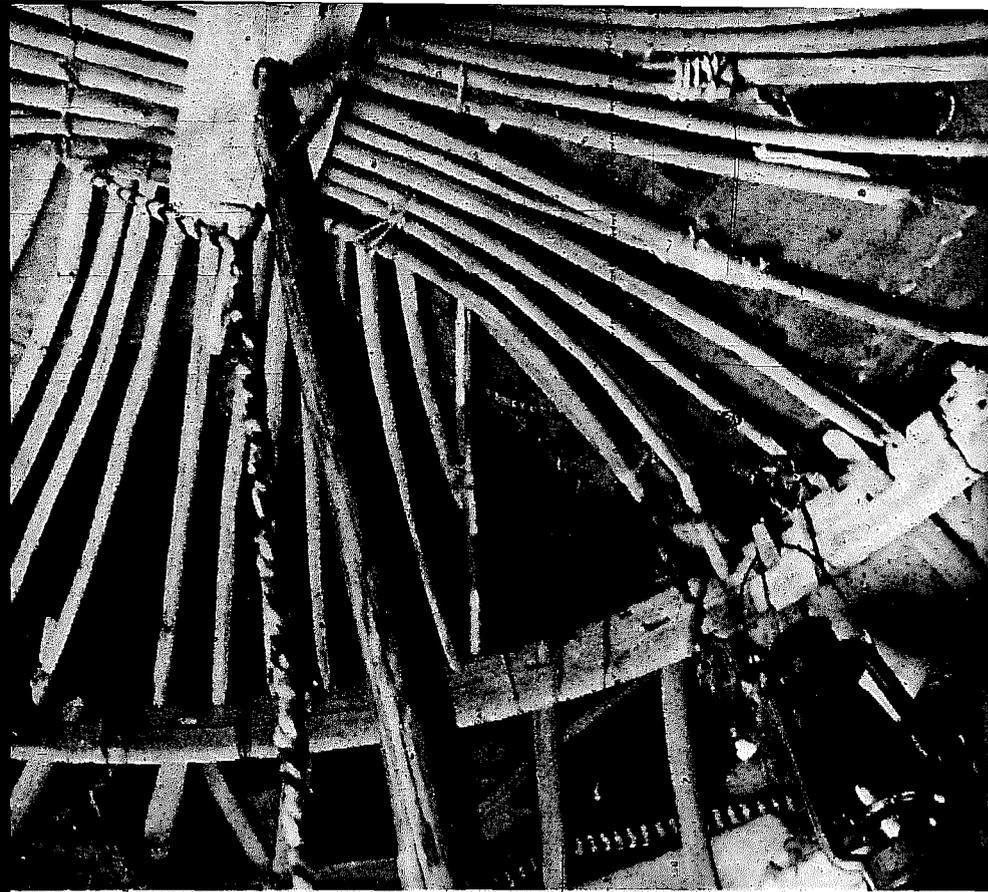

Topak ev type alaciks are prestressed structures: vertical tensioning is provided by a central post supporting the weight of the roof (dogruk) and a rope tie-down for wind uplift. Flat curved sticks radiating from center are ug sticks.



Connection of ug sticks to kerege.

The family structure of alacik dwellers differs from that of the Eastern Anatolian nomads who live under "multi-poled black tents". Whereas the tent-dwellers live in extended families, there are independent nuclear families living in alaciks. In the tents a whole tribe will occupy only a few shelters; livestock are kept in the same tents but in different cells. The dominating and old people occupy the centermost cells, surrounded by the younger members. The tents are divided by vertical hangings. The arrangement of animals, young and old has these advantages:

- the elders and rulers are farthest away from invaders.
- the successive concentric chambers form heat barriers so the middle is warmest.

By contrast, alacik dwellers do not share interior space with their animals, but sometimes build them covered enclosures.

Socially each alacik symbolizes a family. After marriage, a new alacik is built for the new family. With live-

stock donations from both bride and bridegroom's families a new economic and social unit is formed. The independence of each family is highly respected, yet this does not preclude communal life. Families join for cultural and social activities, and move together. A community of independent families, each a sufficient production unit, means a community with no landlords or oppressive order. Problems are solved at the family level.

Centuries of use of this type shelter has made them acquire symbolic content and value. The spherical form signifies the sky. The old Turks used to believe the column of the sky was Polaris (*universalis columnu* in Greek and Roman cultures). The Turks' concept of the universe was similar to that hypothesized by Ptolemy, except they conceived of Polaris in the center, instead of the earth. At the time when their religious belief was Shamanism, the shaman's climb up the center post to reach oculus symbolized a climb to the sky to reach heaven. □



Turkmen children



Mongolian Yurts

Many changes have taken place in the lives of nomadic Mongols since the socialist revolution of 1921. One area of life where changes can be easily seen is in the family dwelling, the round felt tent, called a *ger*, which is still used by most of the population. A young Moscow-trained Mongolian ethnographer, G. Tserenxand, recently charted these alterations over the past couple of generations in central Mongolia.

Until recently, the family was not only the main unit of ownership and production in herding, but it also organized its life in an exceptionally rigid and formal manner, closely tied to the old social conditions. Categories of age, sex, genealogical seniority, wealth, and religious status were maintained by explicit rules and prohibitions within the domestic circle. The round tent was virtually the only dwelling known in Mongolia, apart from Buddhist monasteries, and it was the focus for relationships between people

widely separated by daily occupations. It provided a space in which every category of person or object in the nomad's world could be located, and so became a kind of microcosm of the social world of the Mongols.

The space within the tent was basically divided into four sections, with the fireplace being the cut-off point. Half of the *ger*, from the door (facing south) to the fireplace, was the area of lower status; that behind the fireplace was the more honored half. These halves were then further broken down by sex: the male, or ritually pure area, to the left of the door, and the female, or unclean quadrant, to the right of the door. This spatial sectioning, in turn, determined the placement of the various household furniture etc. around the perimeter of the *ger*.

In spite of the fundamental changes that have occurred since the revolution, people still live in family groups in felt tents.

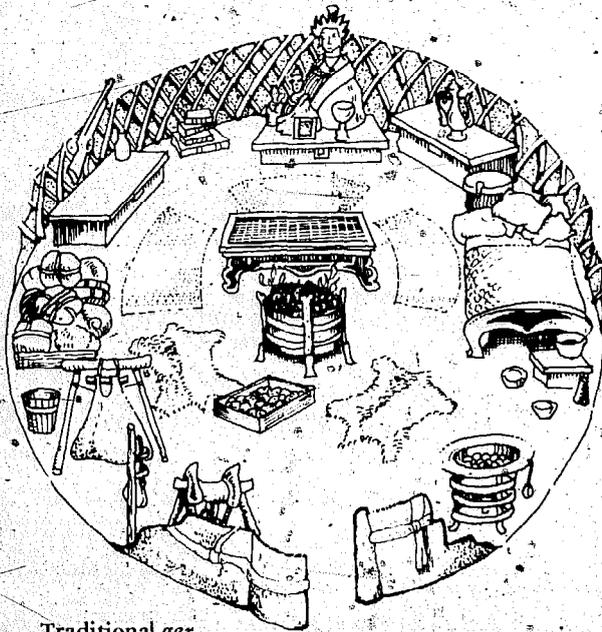

Traditional ger

Clockwise around perimeter, from door: saddle, bridle and halter hanging on post; sour mare's milk banging in leather bag; area for storing felts, skins, blankets, bought food; chest belonging to master of household; gun or other weapons; Mongolian and Tibetan books; Buddhist altar on chest which contained money and other precious items; wife's chest, hat box; marital bed (young children might be at lower end in a pen); eating utensils, cooking pot.

In center: brazier, surrounded by felt mats and skins; low wooden table for serving tea and food.

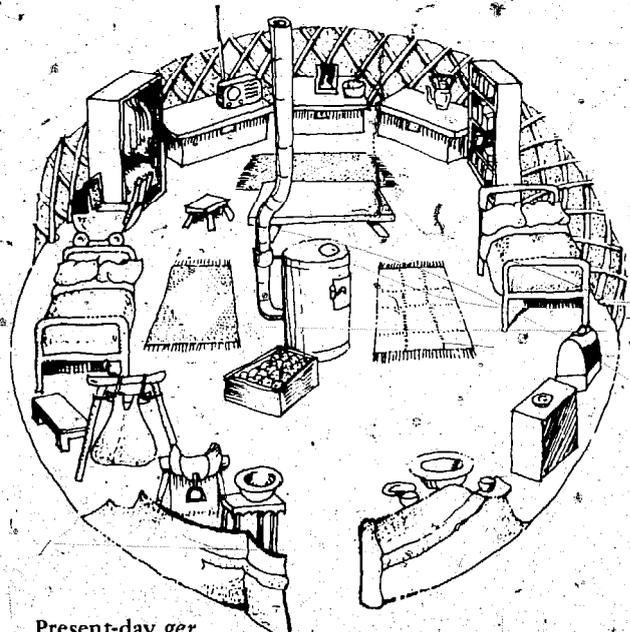

Present-day ger

Clockwise around perimeter, from door: washstand; saddle; sour mare's milk banging in leather bag; children's bed; baby carriage; wardrobe; chest for master of house with radio on top; chest for valuables; chest for women's clothes; bookcase; marital bed; portable sewing machine; cupboard with china crockery; cooking utensils.

In center: iron stove with door facing east (towards wife's place); wool rugs; low table for tea and food; stool for guests.

Adapted from an article in *New Society* magazine, October 31, 1974, by Caroline Humphrey; drawings by John Storey.



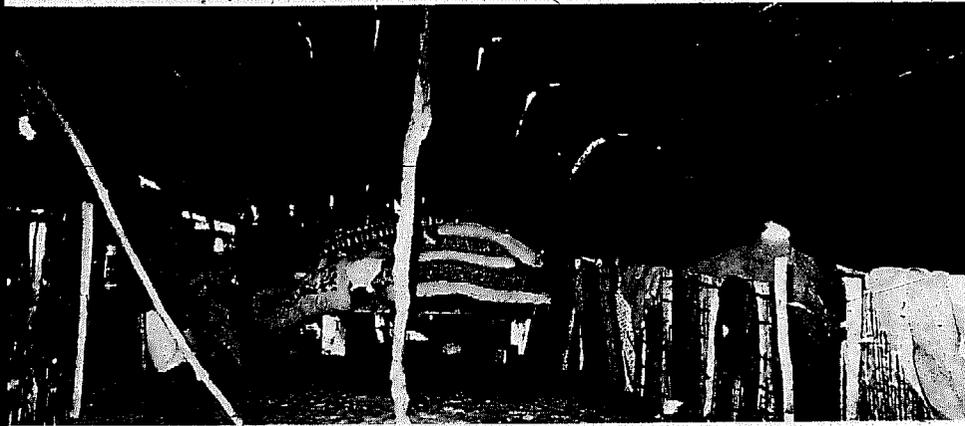
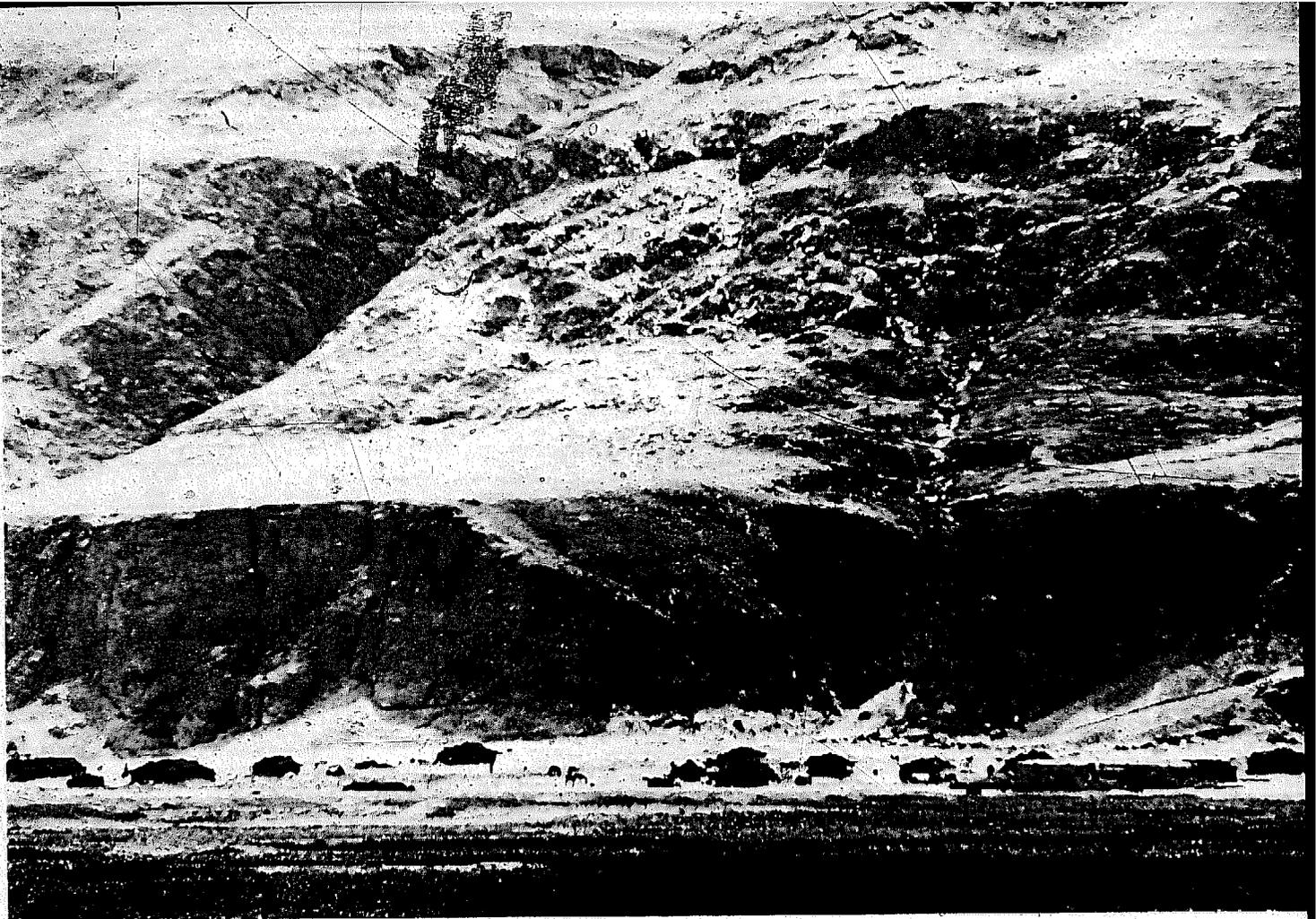

Syria

Syrian nomads, who travel with flocks of sheep and goats, call their tents *Beit Charr*, translated: *House of Hair*. They weave either goats' hair or sheep's wool into unit webs about two feet wide and the length of the tent. Ten or so of these webs make up the tent, which is usually of two colors: black and brown. They are laced together, reinforced by narrow tension bands, propped up by poles and staked to the ground.

The tent walls are stitched at the sides of the main tent with steel pins. On the leeward side of prevailing winds it is left open during the day; thus the enclosure is protected from wind and dust by walls on three sides. These are usually one-family tents, divided internally into two areas, men's and women's, by setting up reed mats; each of these areas contains a fire pit—one for coffee making, the other for cooking. Sleeping is provided by laying mattresses on the carpets which cover the ground.

Daytime use shows the unique character of a Bedouin's concept of living space. With the entire length of one wall usually open, the people enjoy the shaded semi-open space, and the exterior area becomes a part of the living and working space. □

Tents

by Koji Yagi

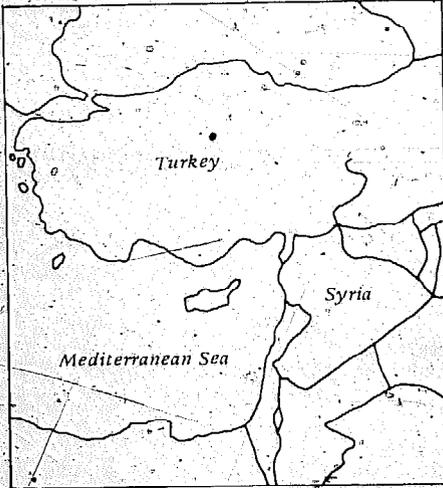

Turkey

Three-poled black tents in Bey Mountains, the highlands of Antalya, Turkey.

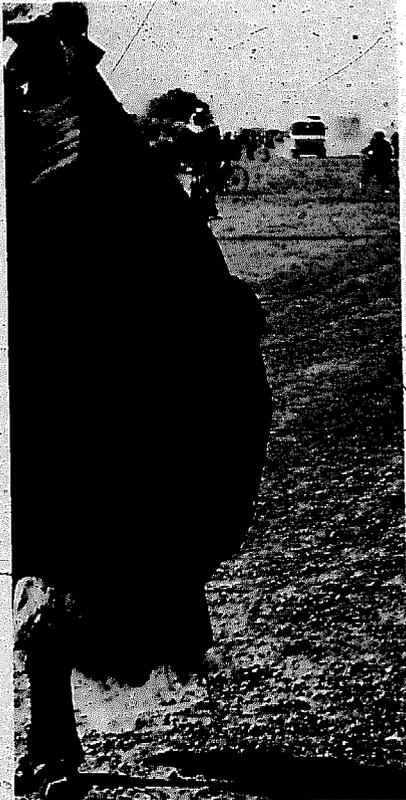

Syria



Greece

by Aris Konstantinidis

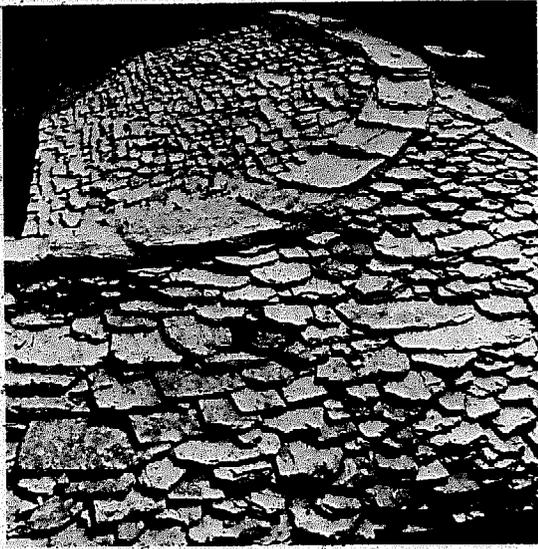

“...there is only one starting-point: the soil, the stones, the water and air of Greece. From there you must begin...”

Kazantzakis



And gradually, as each new coat of white-wash covers the previous one, these surfaces seem to acquire a soft, warm, human-like skin, you can lean against it and touch it and feel it breathing.

The Greek light, that gives such a brilliant aspect to every constructed surface. The Greek light, “that transparent, weightless light, full of spirit; that clothes and unclothes all things.”

Kazantzakis



In summer, when the sun is high, the open roofed area or colonnade stops the rays from penetrating into the closed inner space or rooms, and helps to retain a measure of coolness inside the house, as well as to keep out the blinding light. Conversely, in winter, when the sun is low, its rays slip through the open-roofed area or colonnade into the inner space, thus bringing warmth and abundant light; provided of course that the roofed area faces south, for in Greece this is the most favourable position for any type of living quarters

. . . in a country like Greece (and in other countries with similar climates), people indeed spend most of their time (both leisure and working time) under colonnades or covered verandahs, i.e., in semi-outdoor, intermediary areas





Consider the beauty of this ceiling. . . . The insulation of flat-roofed structures from heat and cold, which modern builders achieve by means of artificial materials, was done equally well by builders of the past with natural materials. The ceiling's beauty has much to do with the linear patterns of the roof-beams, and that 'breathing' quality which we find again, strangely enough, the pattern made by the steps of a village street in another island. How true, then, that no matter what material a civilized craftsman (in the true sense of the word) takes into his hands, he will consistently produce shapes and forms expressing a similar spirit, possessing the same simple and noble quality.



In the Greek landscape of today, we often come across buildings that are modelled with amazing closeness on the monuments of ancient Greece; as if they had been erected on the soil thousands of years ago The dovecots of Mykonos . . . now stand forgotten and derelict, as if their form were slipping away irretrievably, now that they have apparently outlived their function.

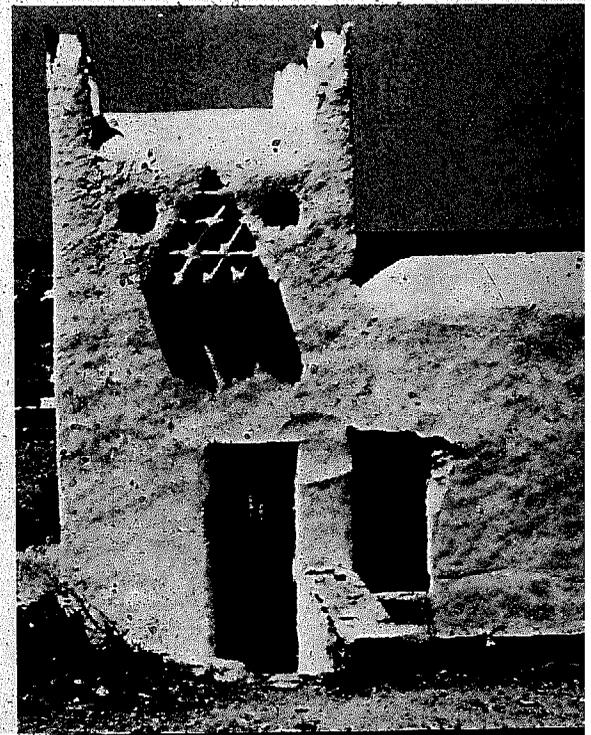
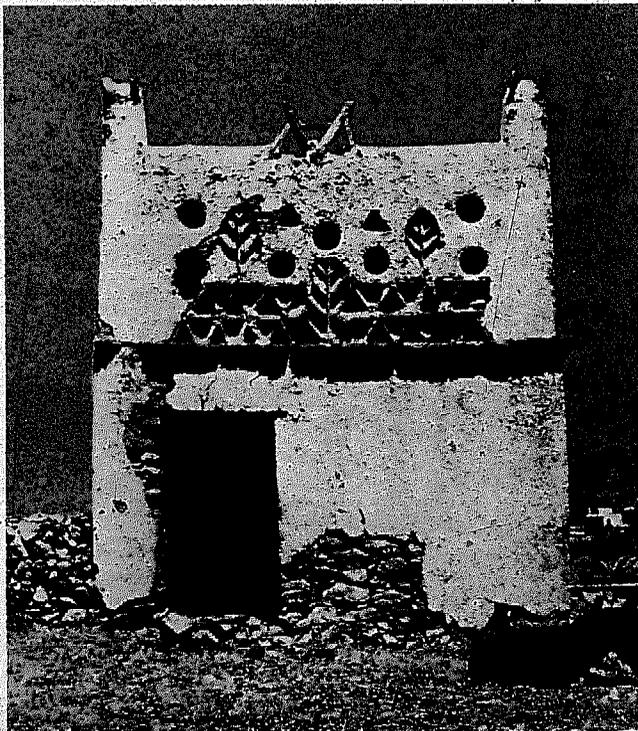

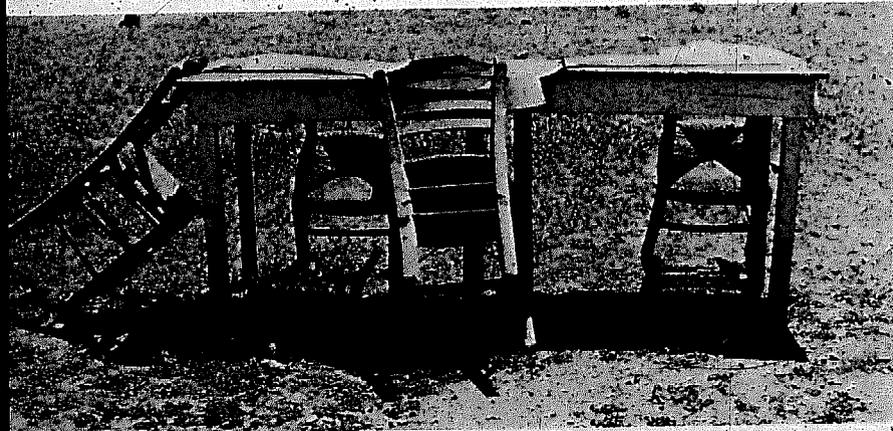
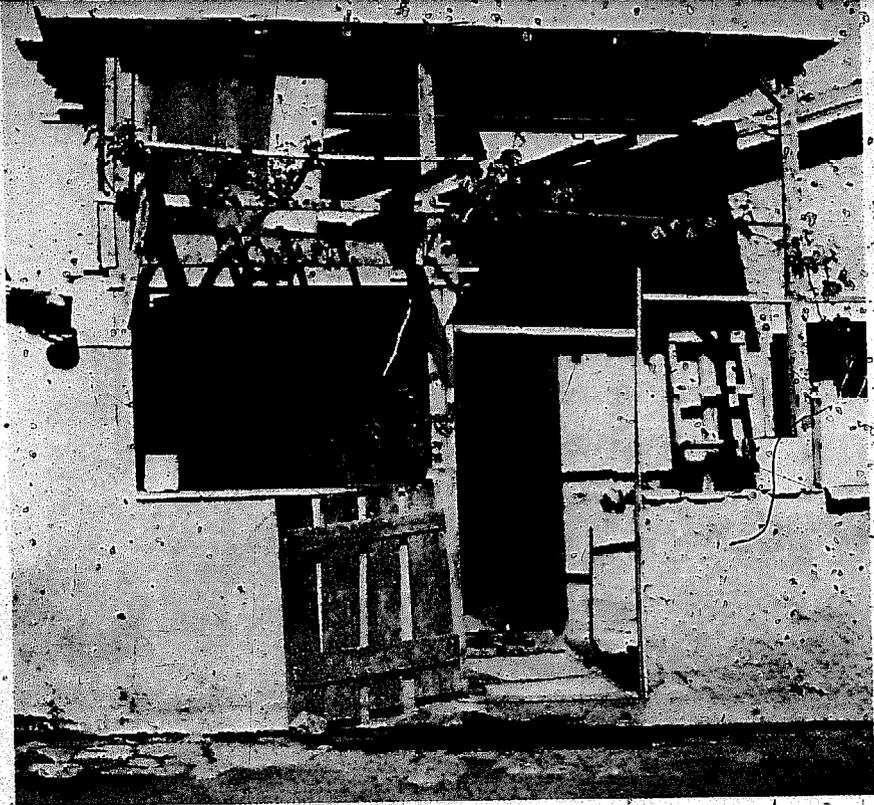
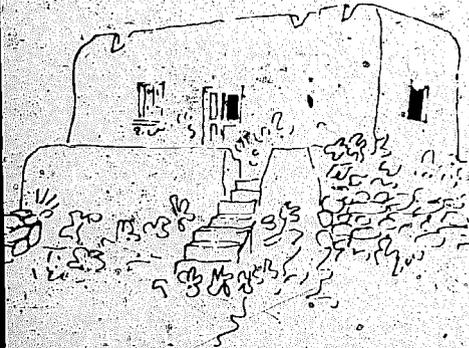

These threshing-floors, spread across the mountain slopes — are they not reminiscent of ancient theaters?

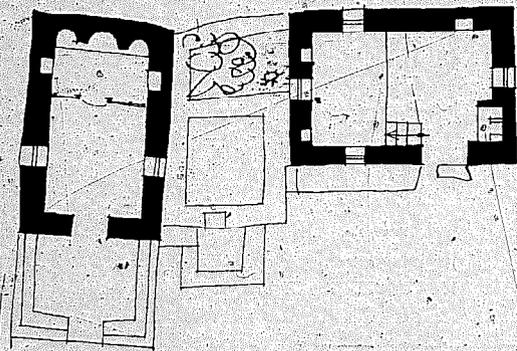

Photographs, drawings and notes from *Elements for Self-knowledge* by Aris Konstantinidis (see bibliography). □

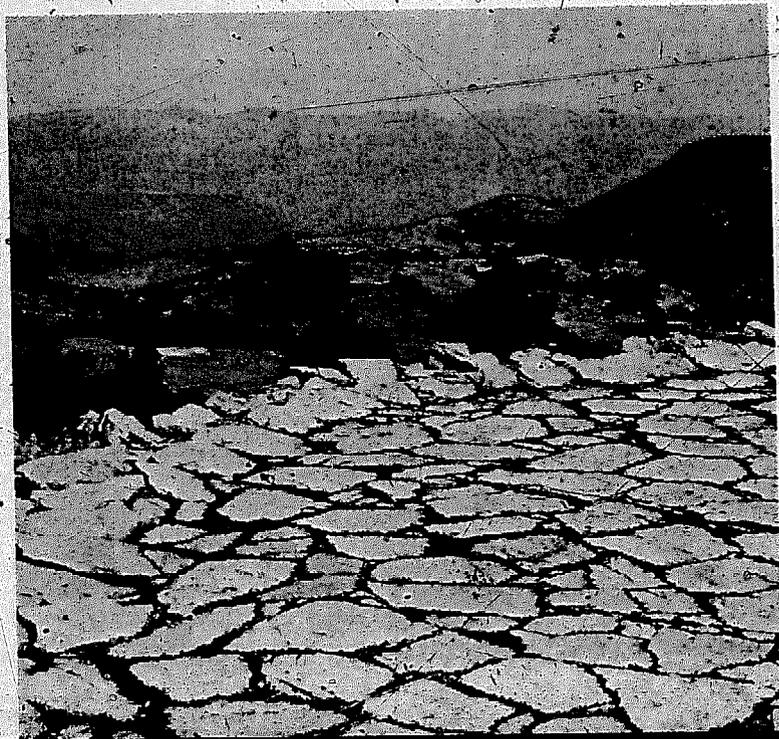

CARAMAGNA P.
TOWN PLAN

3 EXPANSION
NUCLEI, c. XVI-XVIII

ORIGINAL
NUCLEUS
(FOUNDED
AFTER 1028)
FULL CHARTER
GRANTED 1435



Plains Towns of Northwest Italy

by John Hamilton Doyle

The hill towns of Italy are so renowned they quite unjustly overshadow the many plains towns in the Po valley and elsewhere. These are just as remarkable, if less picturesque (being more difficult to appreciate from the ground), and although the peasant society and culture which created and sustained them for over 700 years has all but disappeared, they still offer valuable lessons today. They can be likened in several ways to a modern urban squatter settlement, especially the medieval new towns of 1200 to 1350 A.D.

1. The economy of scarcity, or lim-



Above: typical north-south street.
Below: typical east-west street.



ited surplus, made it imperative to be economical with land and materials. This was a fundamental principle behind the form of these settlements.

2. To make a new settlement a success it had to quickly become a viable community. To attract settlers, the founders offered benefits such as free land, a town charter, citizens rights, etc. These plus the "negative" stimulus of outside threats to safety (like police opposition to squatter settlements) all contributed to the community's cohesion and identity.

3. Any internal dissent which would have risked the new town's success had to be avoided. This was important in the distribution of land, which had to be done fairly. This, plus the primitive surveying tools available, dictated a regular orthogonal layout, employing circles and the like would have led to intolerable

levels of approximation.

4. Later expansion of the town also followed this type layout because the fields around the original nucleus were organized in the same way. The actual perimeter of the town varied frequently in shape - imposed by topographical features of the site. No two towns are identical.

5. Land was distributed according to the needs and size of each founding family. Within the town each lot was cut from the long E-W oriented blocks typically 25-30 metres deep which ran off the main N-S street like the teeth of a comb. As population increased the original nucleus, hemmed in by its walls, grew more and more crowded and today the original clarity is often lost, modified also by changes in function.

6. How economical and sensible these illiterate peasants often were is shown

by the way they built and placed their houses in rows (see sketch).

7. These people built their own housing, just as squatters do now and just as millions will continue to do; their own solution to the housing problem! Starting with a sort of "invasion shack" this was gradually converted into a permanent home.

8. The layout and housing, though not without problems, is generally valid for living today, accommodating our modern services (bathroom) and machines (cars) easily enough. Modern building codes and zoning regulations often seemed weighted against them (ceiling height minimums, etc.) and people now want individualistic and isolated villas, so the tendency is towards their abandonment, which is a pity, considering their efficiency and good sense. They still serve as a lesson today. □

**Typical house
Piedmontese
rural society
c. 1200 - 1900**

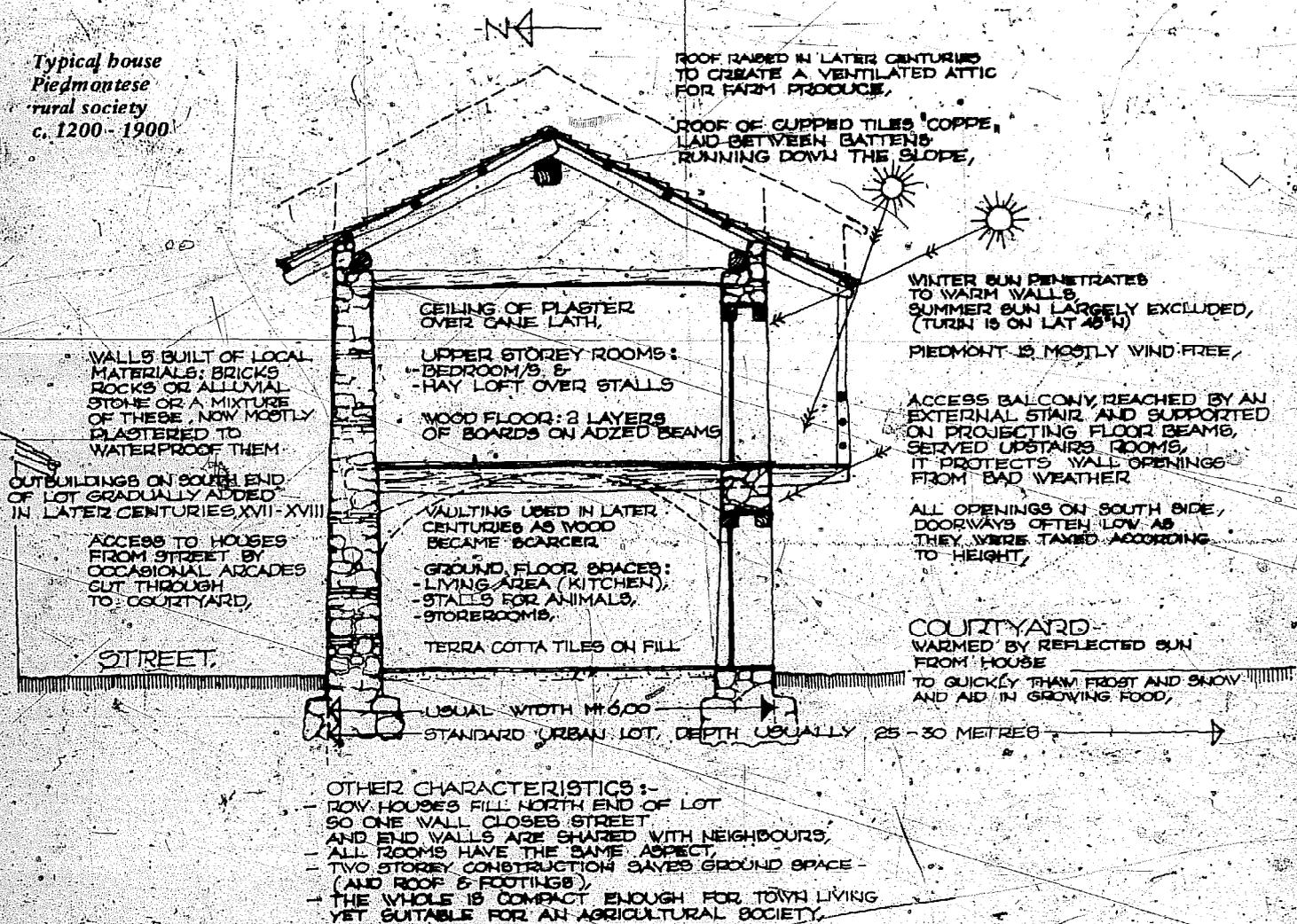

- OTHER CHARACTERISTICS :-**
- ROW HOUSES FILL NORTH END OF LOT SO ONE WALL CLOSES STREET
 - AND END WALLS ARE SHARED WITH NEIGHBOURS,
 - ALL ROOMS HAVE THE SAME ASPECT,
 - TWO STOREY CONSTRUCTION SAVES GROUND SPACE (AND ROOF & FOOTINGS),
 - THE WHOLE IS COMPACT ENOUGH FOR TOWN LIVING YET SUITABLE FOR AN AGRICULTURAL SOCIETY.

Celtic Dwelling

by M. Pierre Gac

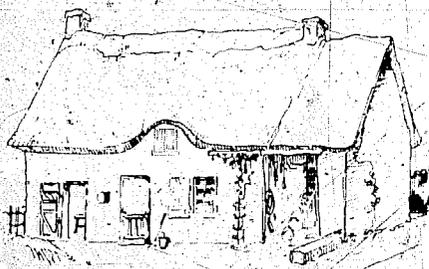
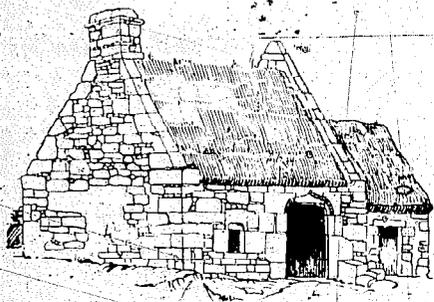

The people of Brittany, descended from the Celtic civilization, developed a type of dwelling (called *ti* in Breton language), which was found in various parts of Brittany. This farm dwelling was built to resist severe weather conditions and for centuries has been the House of Life for people living in harmony with their natural environment, cattle and poultry. The Breton farmers were not affected by any foreign influences and had achieved a certain serenity through the natural rhythms of their lives, and hard work. Their dwellings were scattered in detached clusters throughout the land.

The *ti* was composed of two ground-floor rooms, separated by a corridor and a granary where corn, vegetables and appliances were stored. The floor was of bare earth. Since hospitality was a sacred rule there were no locks for the doors. The room shown above was the heart of the house; the other room was for animals who provided heat. The main room was kitchen, chamber, parlor and pantry. Everything was stowed in traditional positions. The fireplace was the center of everyday life, and used for cooking (pots were either hung from a hook or

set on a tripod), heat and often the only light. It was the center of attraction at the winter evening meetings, when the grandfather sat on a bench under the chimney and told tales to the children while the parents were preparing the candles or spinning the hemp.

The common room was partitioned by the box-bed, which had sliding doors that could be closed. It was built this way because of the danger of pigs or chickens (which roamed freely in the room) injuring or killing babies while the parents were at work in the fields. A cradle could be hung inside the box-bed and the doors closed. There was no mattress, but a *paillasse* made of broom, straw, reed or sea-weed. An oat-chaff filled feather bed was laid upon the *paillasse* and the whole was covered with rough hemp sheets and green blankets.

In front of the box-bed was a chest-bench, used as a seat, for bread storage, a step ladder, or a bed if needed.

From *La Maison Bretonne and Logis et Menages*, Editions d'Art, Jos Le Doare, Chateaulin, France.

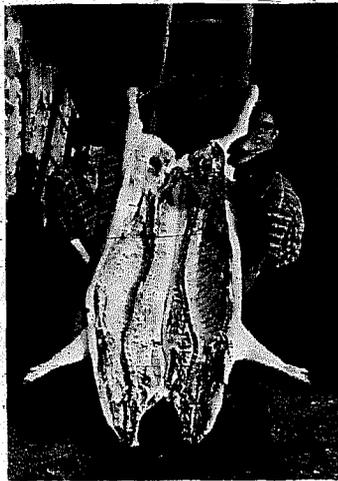
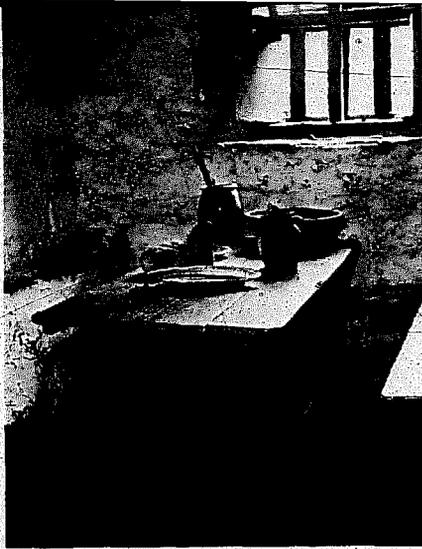

Everyday life was punctuated by a series of fests and customs which corresponded to the collective work: the construction of a building, or the harvest were opportunities to kill a pig and drink a lot. Or the ground ceremony: when the mud floor became too uneven or muddy, people from the surrounding farms were invited on a Sunday. A mixture of clay, ashes and cow manure was spread upon the ground to harden it, and the dancing and stomping packed the floor for the next year. □



Ar C'havel.

Le Berceau

The Cradle

Les Maisons Paysannes Françaises

L'Art de Restaurer une Maison Paysanne par Roger Fischer (voir bibliographie) est un ouvrage impressionnant au sujet des maisons de campagne. Le livre commence par un avertissement qui plaide pour une restauration sensible, et non pas une fausse restauration dite rustique, qui détruit le véritable caractère de ces maisons.

Il y a plus de 500 excellentes photographies de bâtiments paysans, avec des exemples de toutes les régions du pays. Les éléments dont les maisons et leurs abords sont composés sont montrés en détail: clôtures et barrières, murs et toitures faits de divers matériaux, fenêtres, portes et volets, balcons et galeries et intérieurs.

Ce n'est pas une livre à propos du métier de restaurer; il n'y a pas de détails de construction. Le sujet est l'intégrité et l'esprit des maisons paysannes, des exemples qui existent déjà, et les possibilités de préserver ce riche héritage culturel.

Ci-dessus: escalier extérieur d'une chaumière du Morbihan.
Ci-dessous: il n'est plus temps que quelqu'un vienne sauver cette humble maisonnette: le bulldozer y est passé. Aux habituels caractères percherois, elle joignait la noblesse de sa toiture haute aux pans curieusement assemblés. La maison percheroise "pousse" volontiers dans tous les sens, par adjonctions de laiteries, bûchers ou étables, et tire souvent de cette imbrication de murs et de pans de toiture une véritable beauté architecturale.



Ci-dessus: baie intérieure ouverte entre deux pièces. Sa réussite est due à sa simplicité, et à l'emploi de pièces de bois provenant d'une charpente ancienne.

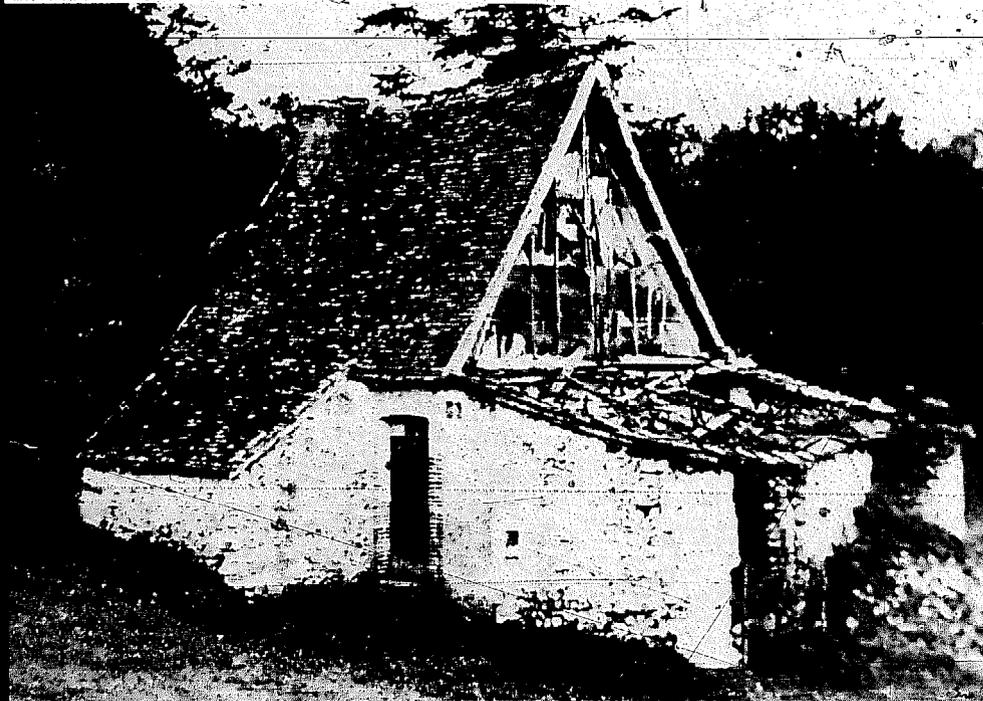

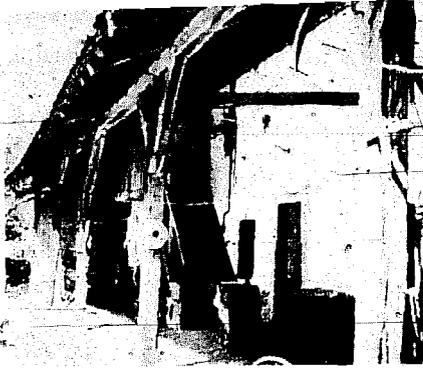

Ci-dessus: en Bresse, galerie extérieure "au sol," caractéristique de cette région.
 Ci-dessous: rampants à "pas de moineaux" constituant de véritables marches d'escalier, couramment utilisées pour l'entretien du toit (Bigorre).

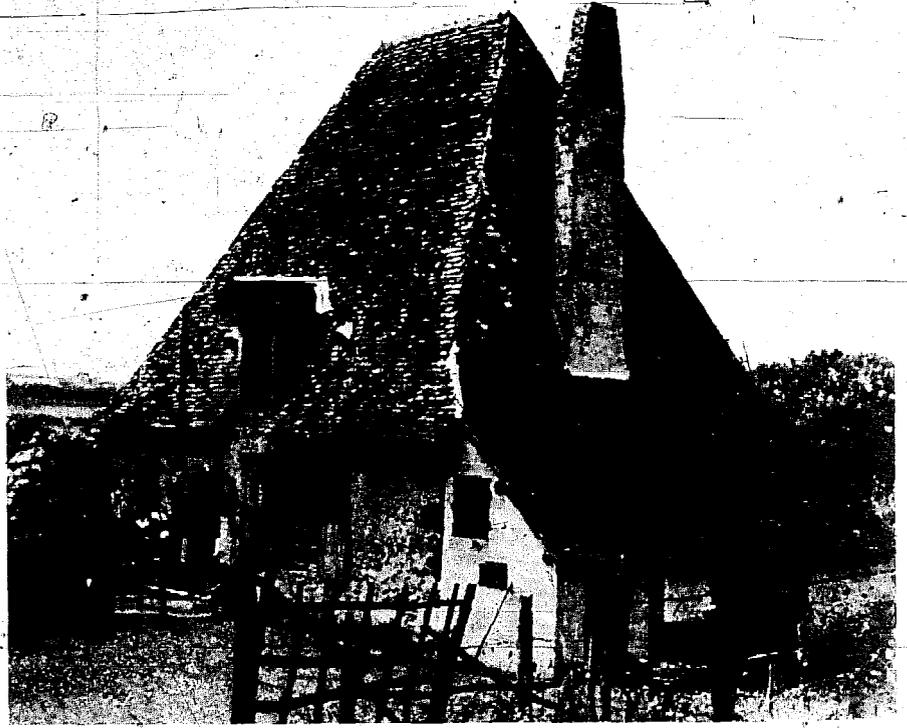

Ci-dessus: haute cheminée prenant assise à la base du toit, dans l'Orne.
 A droit: charme particulier des toits de laves imbriqués sur cette grosse ferme des Causses.
 Ci-dessous: une triste maison paysanne d'aujourd'hui, elle garde tout son caractère et même son four à pain; mais est abandonnée au bétail et tombera bientôt en ruine.



Ci-dessus: petite porte donnant accès au grenier d'une maison de Corrèze.
 Ci-dessous: rive grossière de chaume sur un mur de pisé (Bretagne).



English Cottages

Drawings by Sydney R. Jones

There is probably no object so much a natural part of the English landscape, nor which makes such a direct appeal to the heart and imagination, as the old country cottage. In every part of England, in the village and on the outskirts of the town, in the hamlet and standing on the lonely moor, there still remain these beautiful witnesses to the vitality, freshness, and pride of the village mason and carpenter. Passing from district to district the wonder grows at the many types, and that half a day's journey from cottages of stone there are cottages of cob and thatch

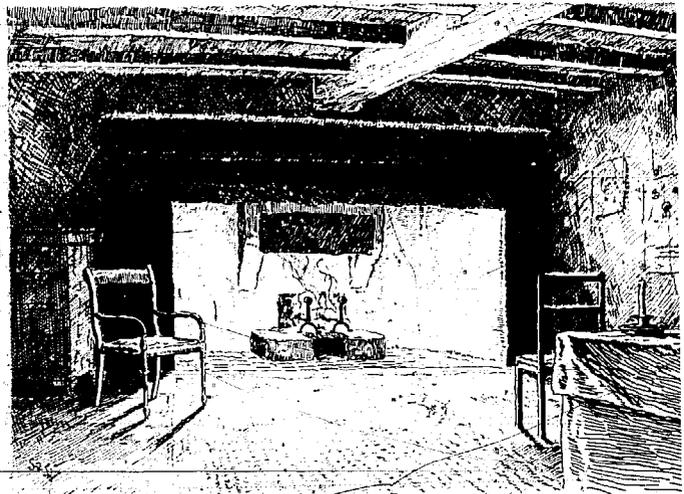

The craftsman with more imagination than his fellows gave a new turn to the mouldings, finished a gable with a finial of a fresh pattern, or added another variety of walling; one carried through his work a little in advance, and one remained a little behind, but the work as a whole was customary and usual, and the following on of what their fathers had done before them. Each gave of his best, his quota of simple and direct workmanship, using the materials that were to hand, sometimes wisely and well, sometimes badly, but always inspired with a fancy and invention as natural as they were unconscious. The way they built and the way we build are essentially different. With them the tendency was to add gradually new methods of doing things, slowly increasing their store of ideas, from which they drew, as they drew water from the well on the village green



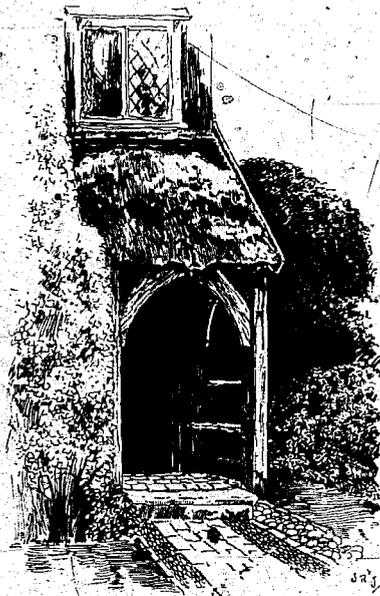

The plan seems to have had an origin quite distinct from that of the circular hut. At first it was merely a copy of the simple rectangular structures erected for the housing of the oxen. It was built in bays to accommodate what was called a long yoke of oxen, that is four abreast, and the bays divided by two pairs of bent trees, in form resembling the lancet-shaped arches of a Gothic church, and placed at 16-foot intervals . . .

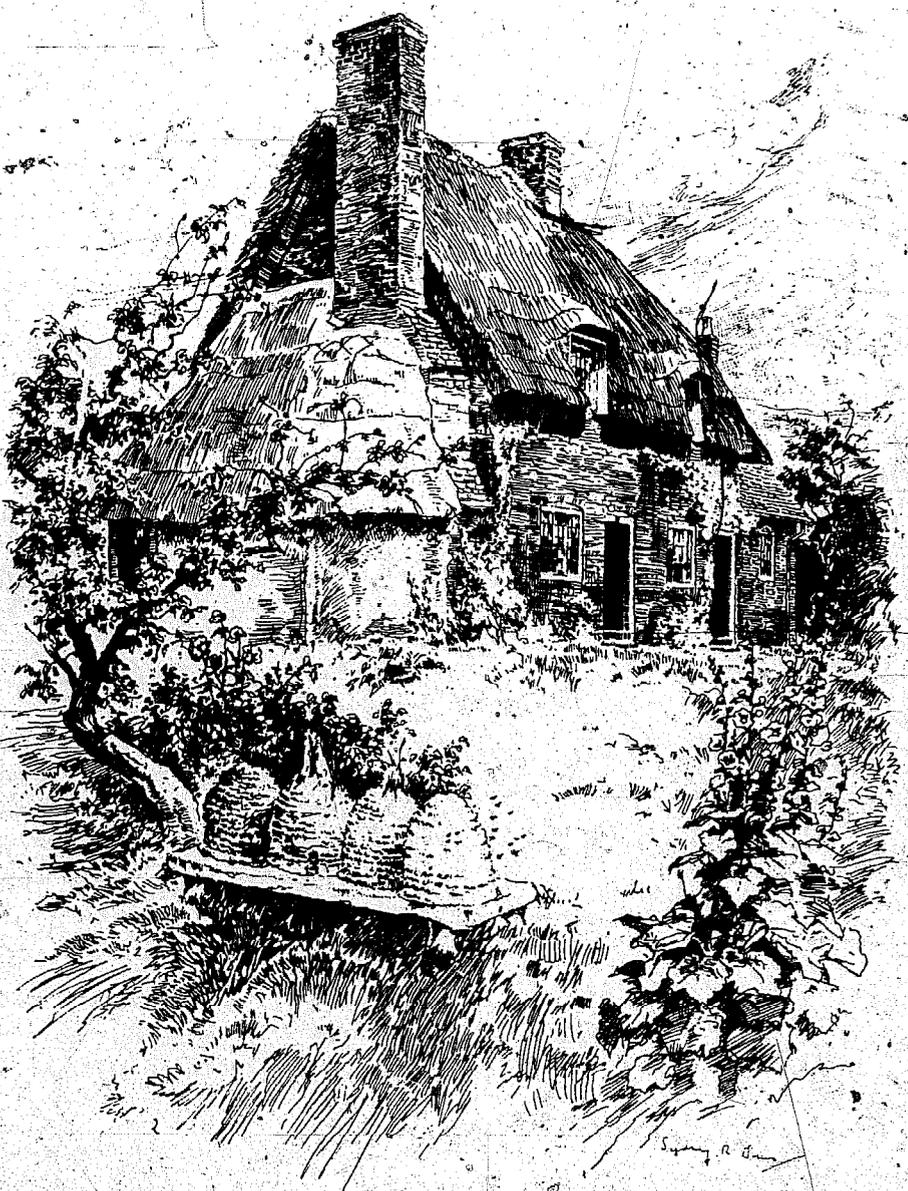

In the arrangement of materials, whether of one or of many, the village workman displayed a happy knack of doing the right thing in the right place, but in putting them together he was not always so successful, and seldom satisfactory from the sanitary expert's point of view. The rain was allowed to drop from the eaves without any means to collect it, the water to sink into the foundations, and walls were sometimes badly built; but in spite of these drawbacks, and possibly partly owing to them, the appeal of the country cottage is universal . . . □

From Old English Country Cottages, edited by Charles Holme; published by The Studio, London, 1906.

Ireland

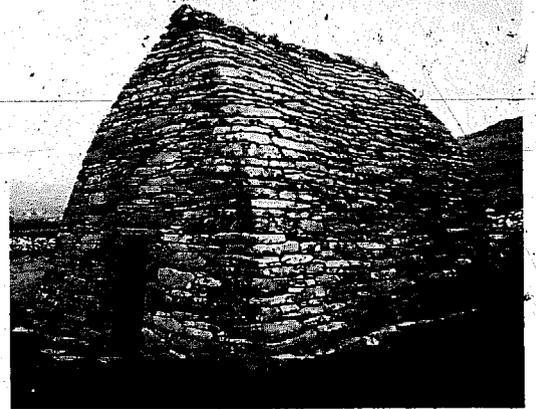
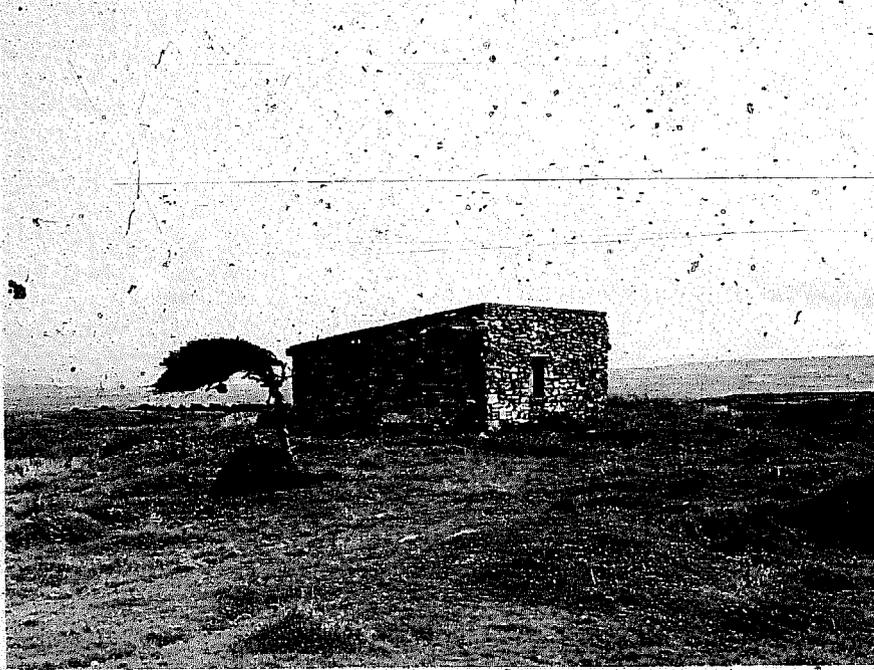

Gypsy Vans

by Denis E. Harvey

Denis Harvey is co-author and illustrator of *The English Gypsy Caravan* (see bibliography). The book is the result of 25 years research by the authors. The Wright bow-top van described here is "... the most typical and highly evolved spin-off from the gypsy scene in England. ... These vans were superbly designed and a few highly-prized survivors are still in use in the old style by horse-drawn travelling people. ..."

The domestic solution for Gypsies in Britain from the late nineteenth century onwards was this Bow-top Living-wagon designed and built by William Wright & Sons, of Leeds, Yorkshire, England. Bill Wright's bow-tops became the type of van most favoured by horsedrawn travelling people other than Showmen due to its functional elegance, easy maintenance, and under-body clearance combined with a low centre of gravity.

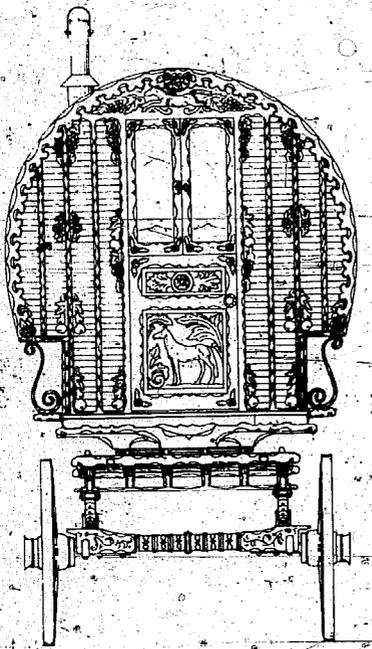

Front

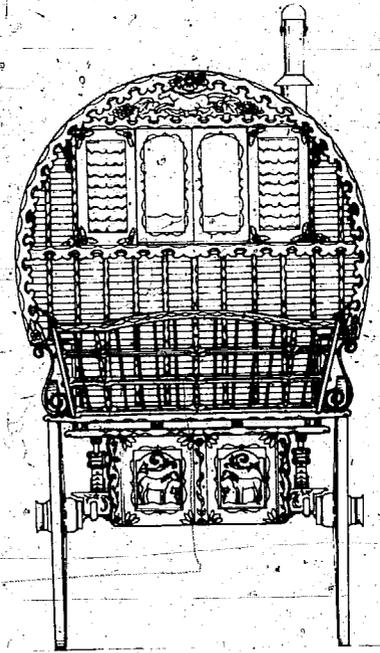

Rear

Bow-top Wagon

Wright c. 1906

11 feet long
10 feet high

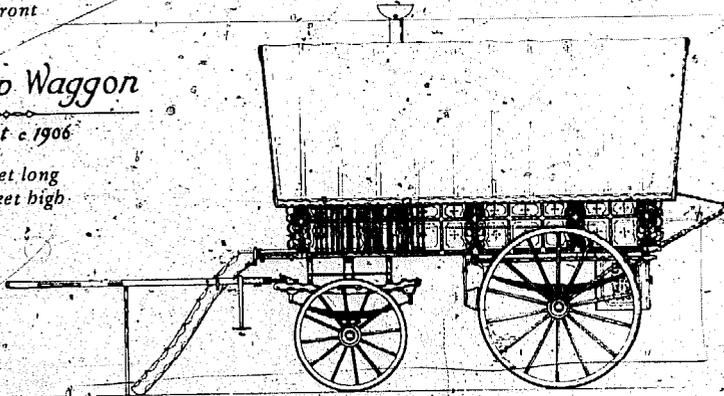

Side

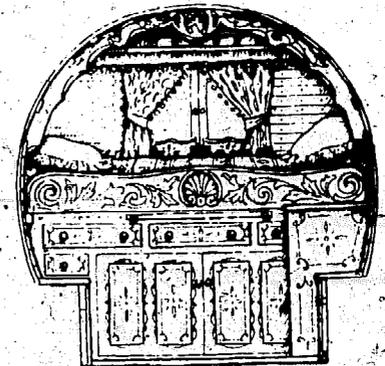

Interior facing bed

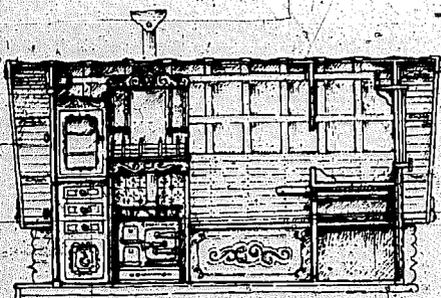

Interior left side

Cooking & Sleeping: These wagons would be used by Gypsy families in conjunction with 'bender-tents' and 'accommodation' carts. Although they contained cast iron cook-stoves, cooking was mostly done on a stick fire outside with pot, kettle and skillet hung from kettle-props (see photo) — one of the most efficient and economical ways of cooking for those who become familiar with it. □

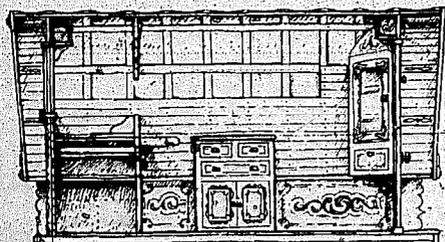

Interior right side



Kettle props, roadside fire

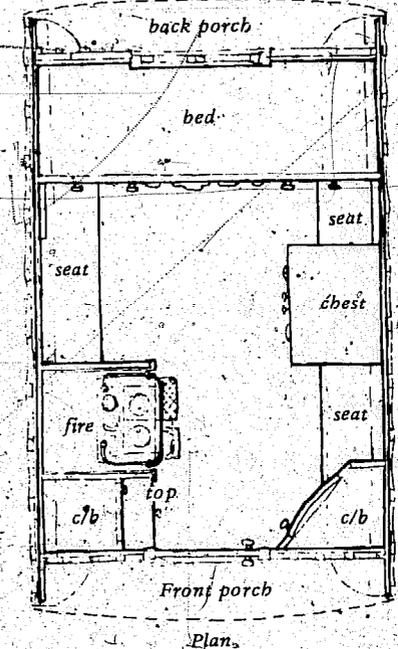

Plan

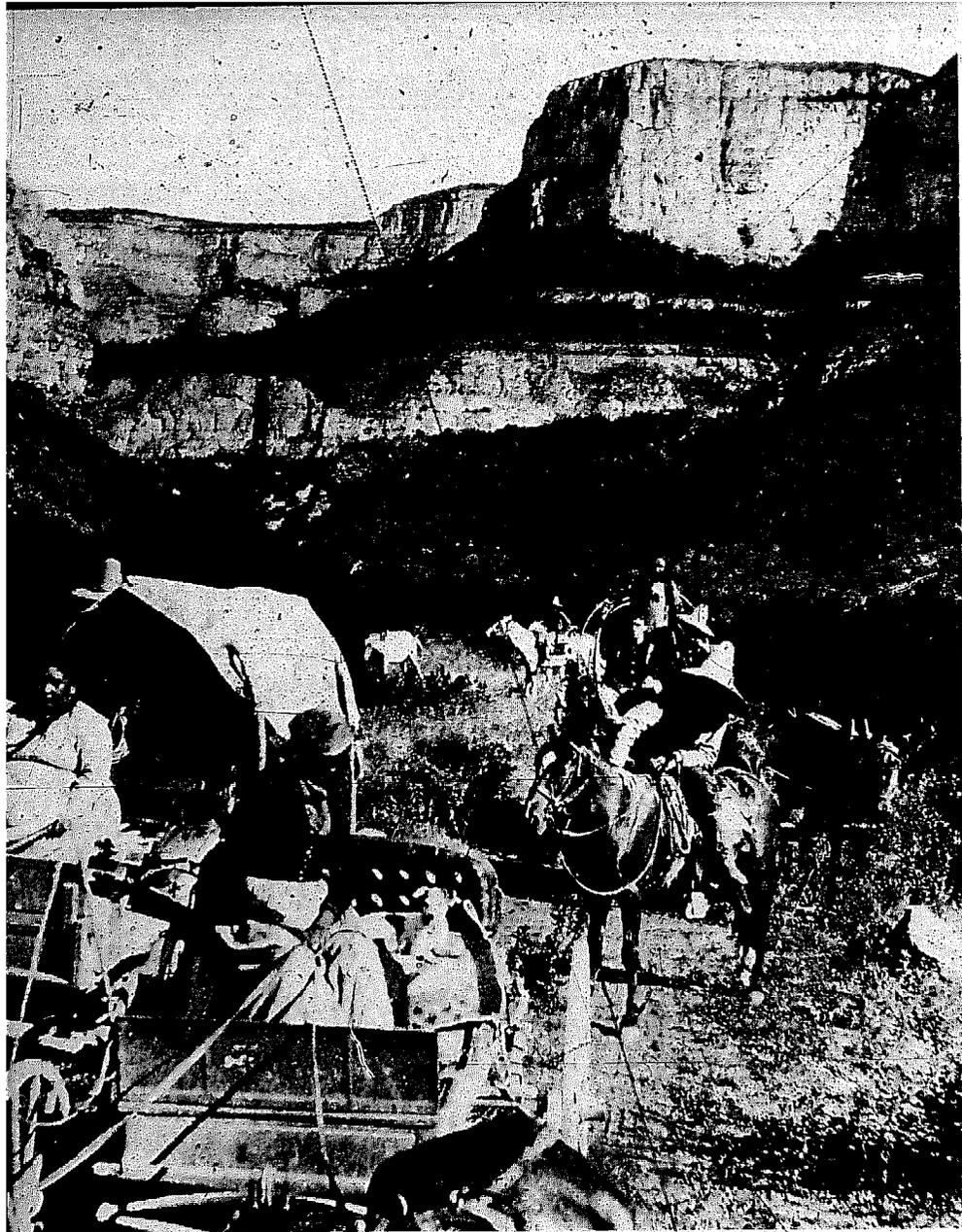

Kickapoo Indians migrating to Mexico (date unknown).

Kickapoo

by Peter Nabokov

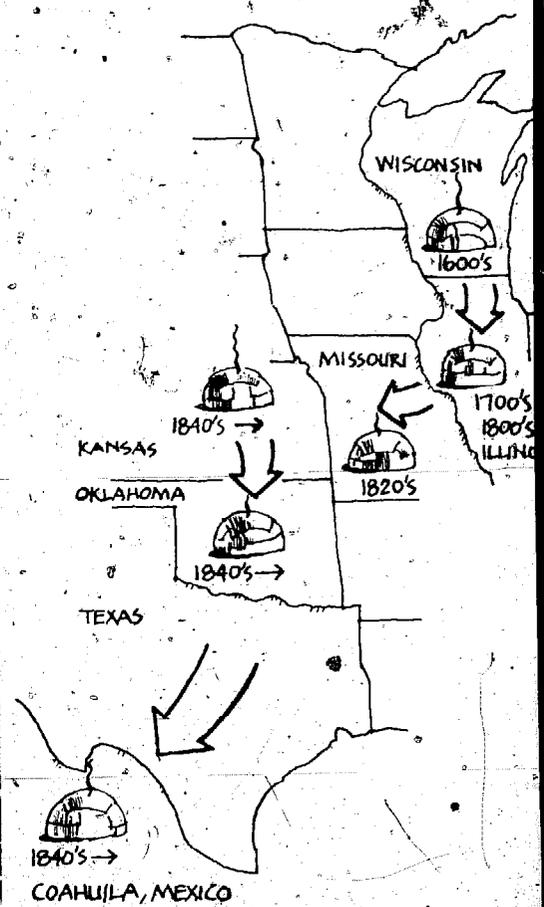

Dispersal of Kickapoo housebuilding tradition.

In the beginning, the Mexican Kickapoo believe, their all-creator, *Kitzibiat*, lived in the prototype *wikiup*, the Kickapoo winter house, and the prototype *odanikani*, summer house. He showed his son, *Wisaka*, the Kickapoo "culture hero," the materials and techniques, rituals and taboos for building, consecrating and living in these houses. In turn *Wisaka* taught them to the remarkable Indian tribe whose name would fit their peripatetic history: *Kiwigapawa*, meaning "He Moves About," simplified to Kickapoo. Wherever the Kickapoo wandered thereafter, the maintenance of these house-building customs and codes was essential to tribal integrity.

Throughout three centuries of migration down 1,500 mid-Western American miles from the Great Lakes to Mexico, the Kickapoo have preserved to this day their traditional house forms as the most vivid, visible badge of their fierce adherence to old ways. It is common for house forms to undergo drastic changes during times of cultural stress or relocation — not so with the Kickapoo. Despite adaptations to radically different climates, they have kept up their semi-annual change of dwelling pattern, their old customs regarding female owner-

ship and building houses, the consecration ceremonies and house-use customs.

Originally the Kickapoo lived west of Lake Michigan, but early distaste for white culture prompted them to migrate southward in the late 1600's. First they built their lodges in Illinois, next in Missouri and Kansas. Shortly after they moved south again to Indian territory, and some small bands meandered into old Mexico. In 1842 the Mexican government formalized their hands-off policy toward the Kickapoos by granting them 40 square miles south of the Texas border in the state of Coahuila. Other American Kickapoos in search of cultural freedom joined their Mexican kinsmen in 1863, until today the unlikely desert area boasts the last pocket of 19th century Woodland Indian lifestyle left in North America.

Today the Mexican Kickapoo still build their tule or cattail mat lodges — photographed in 1952 by two Wisconsin anthropologists who were allowed a rare, two-week sojourn before being booted out. Long a legend in anthropological circles, the tribe has, however, made a few accommodations to their Mexican surroundings. Here and there a "jaçal"



Mexican Kickapoo settlement in Coahuila, Mexico. 1952.

(cornstalk or saguaro cactus Mexican rural house) joins the Winter house, Summer house, Cookhouse and Menstrual hut which comprise the shelter grouping. And the family cluster resembles the traditional Mexican "solar," or family compound.

Crossing the border at Eagle Pass, Texas, the Mexican Kickapoo enjoy a unique status. They are allowed through customs without green cards or tourist visas as they undertake yearly trips to visit Stateside Kickapoo communities in Kansas and Oklahoma. Their reputation for hostility towards outsiders — particularly those bearing note pads, cameras, and tape recorders — is notorious, but a generous couple named Mr. and Mrs. Lewis Cuppawhe kindly invited us on a tour of their winter lodge and summer house frame. A hundred yards from an Interstate, Mrs. Cuppawhe demonstrated the sewing of cattail mats using a cow rib needle, and a mile from the Shawnee, Oklahoma supermarkets, she showed how she ground dried corn in a homemade oaken mortar.

continued

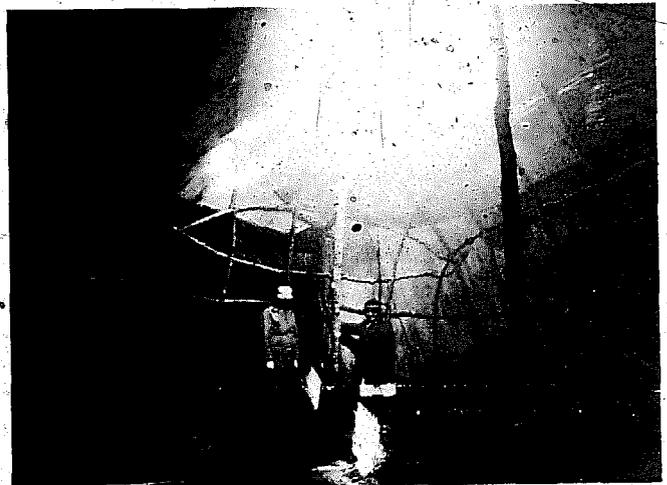

Mr. and Mrs. Lewis Cuppawhe, 1976

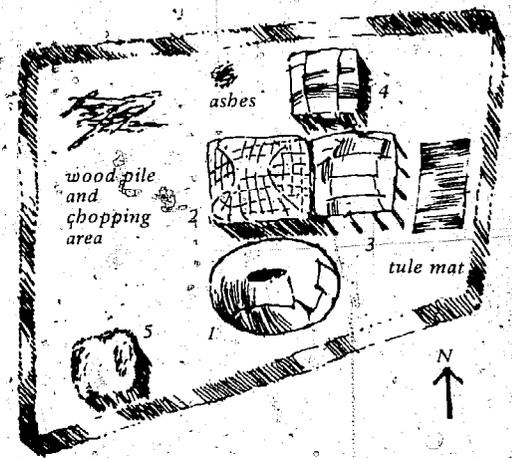

The typical Mexican Kickapoo compound encloses within its barbed wire fence five traditional structures: 1) the haystack-shaped winter *wikiup*, with its double-thick mats battened with outside stringers and laid so rain will run downward; 2) the peaked summer *odanikani* with its vertical walls — made from sotol flower stalks — and two mat layers, the one laid in an east-west position, the other north-south; 3) the shade, or *ramada*, with free-standing work benches, open on all sides and connected at the western eave to the summer house entrance; 4) a 12 foot-square cook house with tough framing of

juniper (like the summer house), roofed with hard Beaked Yucca; 5) toward the compound rear, a menstrual hut where women live during the time of their period, about six foot square and containing bedding and implements used here exclusively.

Around the living space the ground is of tamped earth, frequently sprinkled. While the dwellings themselves are individually owned, the compound space is the property of the entire village; occupants have lifelong rights there so long as they observe the house- upkeep code.

Winter house (wikiup)
October to March occupancy
 20' long x 14' wide x 9' high woven frame

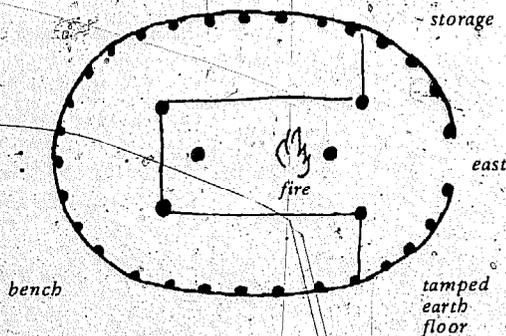

Interior Furnishings:
Bedrolls: Quilts and blankets on benches
Trunks: for bedding storage during the day
Crude chairs
Treadle sewing machines
Flashlights, mirrors, hanging from inner frame
Bench: dyed and woven cattail mats on sapling frame raised off earth floor 4"



The *wikiup* frame is made of hackberry, Montezuma bald cypress, or sycamore saplings bent over a rectangular support of four sycamore posts buried in the tamped-earth floor. The horizontal pieces are then tied to make a framing lattice-work — all joints tied with *pita*, shredded and wound yucca-like fibers.

The cattail or tule mats are first wrapped — with stalks up and down for rain run-off — around the base of the *wikiup* frame, then laid over the top to leave a six-foot long smoke-hole slit. Smoke-darkened and worn mats are put on the exterior while newer mats face the inside. Finally the mats are battened down with stringers.

Summer house (odanikani) with ramada
 March to October occupancy. 16-18' long x 15' wide x 11' high. Hipped roof on vertical walls.

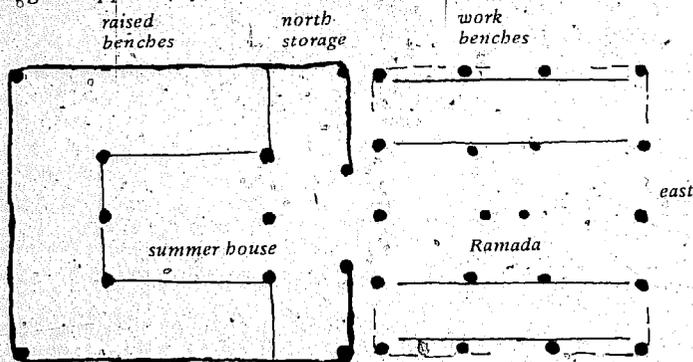

Interior furnishings:

Workbenches for sewing, basketmaking, visiting, lounging, sleep.

Earthenware jar for water, covered in gunnysack, hung on Ramada west wall with enamelware mug.

Wire or sotol baskets; eggs, vegetables, dried ceremonial corn.

The standing of a Kickapoo woman is bound up in her role as house owner, builder and maintainer. Houses belong to the family's oldest woman; it is her responsibility to call upon family and clan folk to help her during the New Year ceremonial enlargement of the wikiup, or during the fall and spring dedication rites when the roofing mats are ceremonially transferred and new fires lit.



These mats are sewn together from cattails which grow nearly 200 miles away from their Mexican village. First the Mexican Kickapoo cattail gatherers say prayers and burn Indian tobacco before harvesting. At home, the bundles of cattail leaves are thinned so only nine foot lengths remain; these are then soaked and laid on the ground beside each other. Teams of women work to sew the 18 by 9 foot mats with long needles, iron or bone, with pita (yucca-like fiber) or commercial hemp. Bench mats for sleeping and sitting are hand-woven from dyed and softened Sotol leaves.

This material is excerpted from the forthcoming book Native American Houses, by Peter Nabokov and Bob Easton, published by Oxford University Press.

Sources for information appearing in this article: The Mexican Kickapoo Indians, by Felipe A. and Dolores L. Latorre (University of Texas, Austin, 1975) and The Mexican Kickapoo, by R. E. Ritzenhaler and F. A. Peterson (Publications in Anthropology, Public Museum of the City of Milwaukee, No. II, 1956).



The summer house frame is constructed of one-seed juniper or desert willow. The walls are vertical, the roof frame lattice is hipped and extends about two feet beyond the sotol cane walls. The first two mats laid at the ends run north-south, while this second layer runs east-west.

The completed summer house has no smokehole; the smoke seeps through the sides and eaves. Since these women are building early in the season, canvas covering is added to assure warmth.

Cookhouse

12' square

Framing and construction similar to summer house

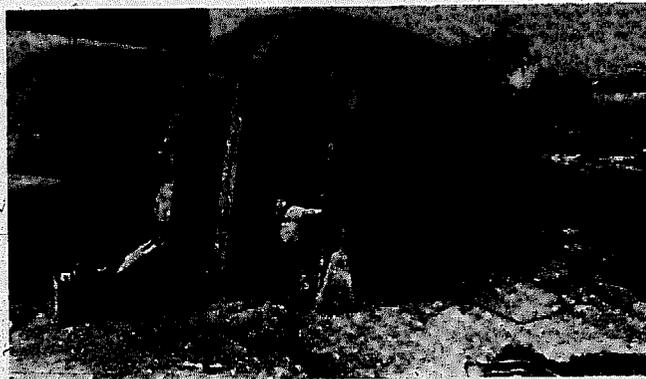
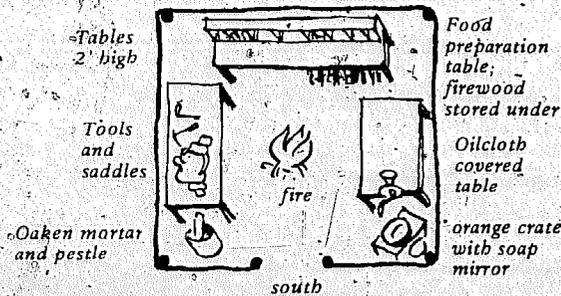

Cardboard wikiups beneath the international bridge at Eagle Pass, Texas in 1978, built by a 600-member Kickapoo tribe that has asked the U.S. federal government for a \$1.5 million grant to establish a reservation where they can practice their religious rites and educate their own children. □

UPI Telephoto

North American Houses and Barns

Sod Houses

by Roger Welsch

For thirty years the standard on the plains was the sod house. (How sod came to be used as a building material is uncertain. The settlers may have borrowed the idea from the Mormons, who began building with sod in the mid-1850's. The Mormons, in turn, probably got the idea from the earth lodges of the Omaha and Pawnee Indians.)

Today we make every effort to design houses that bring the out-of-doors indoors and take the indoors out-of-doors. Patios serve as dining rooms, large windows provide the illusion that we are outside when we are inside. We open the house walls and break down barriers. But for nineteenth-century plains dwellers, perceptions were different. After a day of being squeezed between sky and

earth, of being exposed to the withering sun or a razor-sharp wind, there was little desire on the part of the pioneers to bring the environment into their houses.

The house was meant to be a fortress, a bastion for shutting out the outside. The thick walls, the few small windows, and close rooms were not seen as disadvantages — as they might be now — but rather as an integral part of the sod house's advantages. Far from being discomforted by the cramped quarters, plains settlers sought the closeness of family members in the evening hours, after a day spent out of sight and hearing of each other or, for that matter, of any other human being. The close contact and association with the family took on a very special, desirable quality.

Many women, singly or in groups, homesteaded during the 1800's. Shown here are the Chrisman sisters, Custer County, Nebraska.





John Curry sod house near West Union, Custer County, Nebraska, 1886.

*My house it is built out of national soil,
The walls are erected according to Hoyle,
The roof has no pitch, it is level and plain,
But I never get wet—unless it happens to rain.
From a Pioneer Plains Folksong.*

The simplest form of sod house; built low to the ground, with no windows.



... As a familiar plains' line goes, "Living in Nebraska is a lot like being hanged: the initial shock is a bit abrupt but once you hang there for a while you sort of get used to it." In the demise of sod houses, the forbidding mystery of the plains had dissipated to the extent that inhabitants no longer felt the need for the physical and psychological security that these dwellings offered.

Sod houses still dot the plains. Some are still lived in, but most are just derelicts—abandoned, their roofs overgrown, their door and window frames sagging. These ghosts, however, are more than merely abandoned houses. They are reminders of the grip the plains had on their early settlers. Behind their dark sod, these houses offered protection from a lonely and inhospitable land. They also offer another reminder— their abandonment and replacement by wood frame houses are symbolic of a reversal in attitude. Now, it appears that plains dwellers have a grip on the land instead of the other way around. Thus the sod house was as much a product of the impact of the plains on the human mind as it was a product of the geography of the plains.

A farmer friend of mine commented a short time ago, "We seem to forget that we may have made this land what it is, but first it made us what we are . . ."

Reprinted from *Natural History* magazine, May, 1972. □

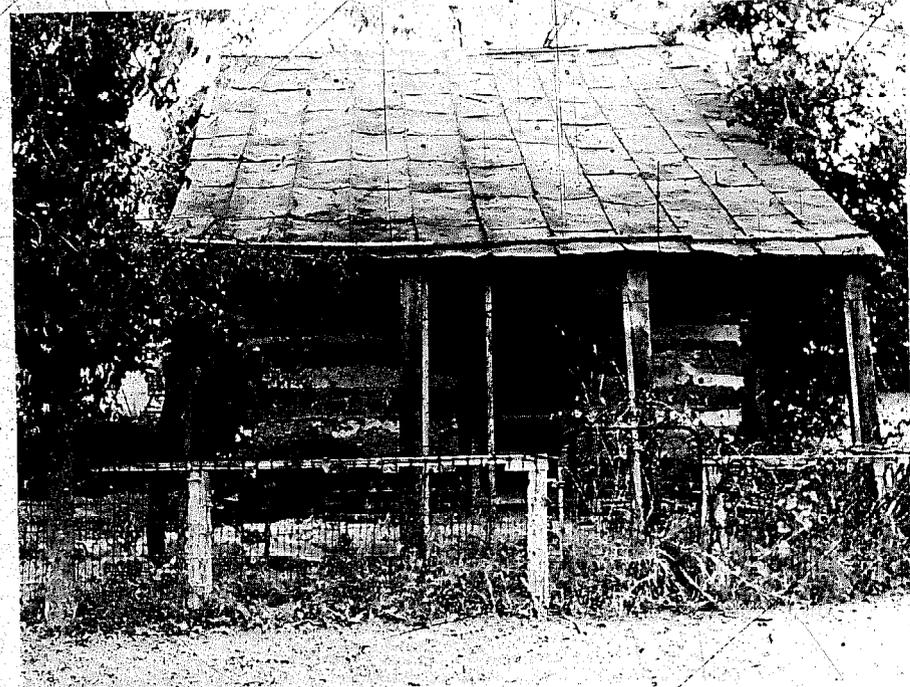

Old Texas Buildings

by Burton Wilson

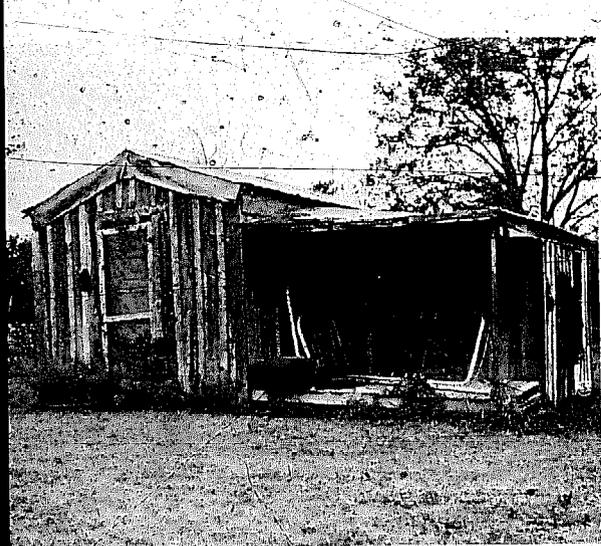

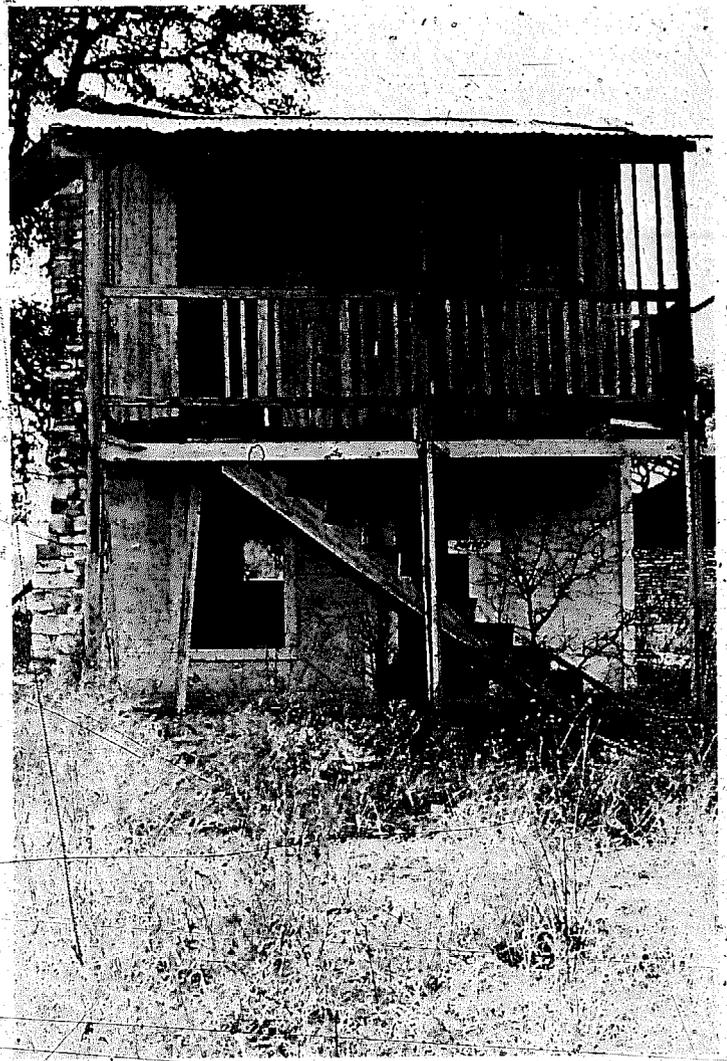
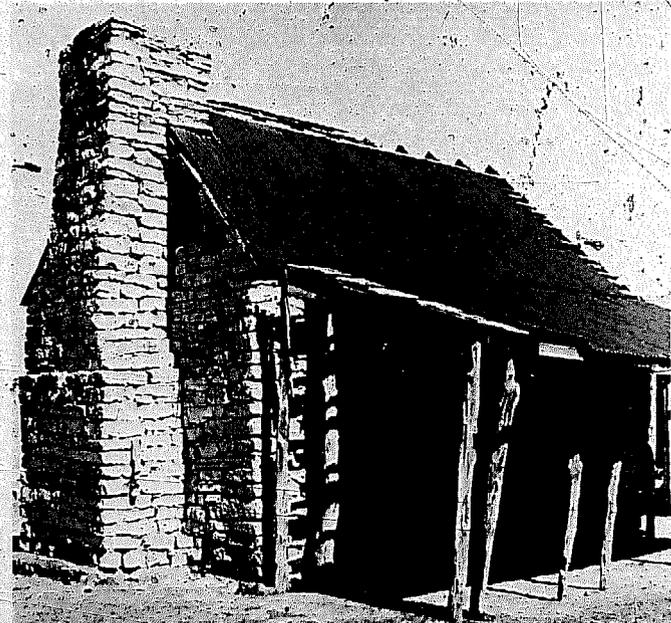
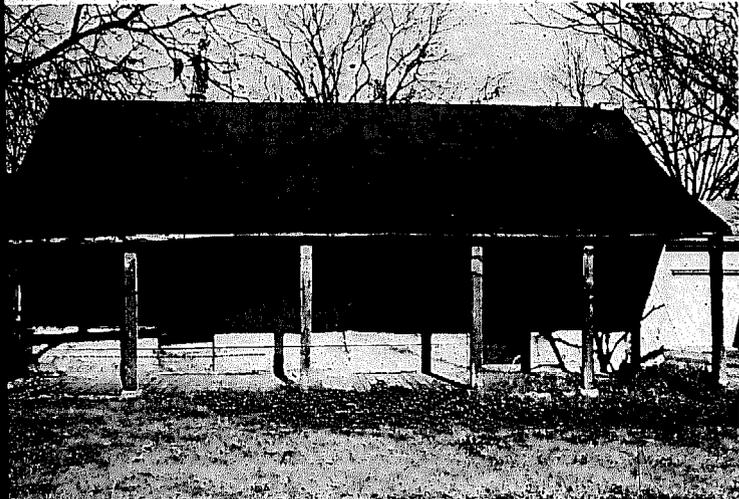

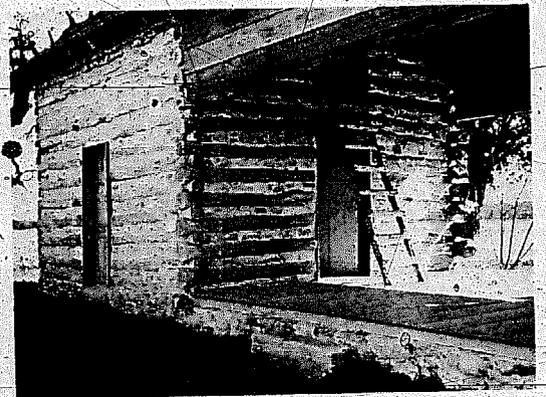
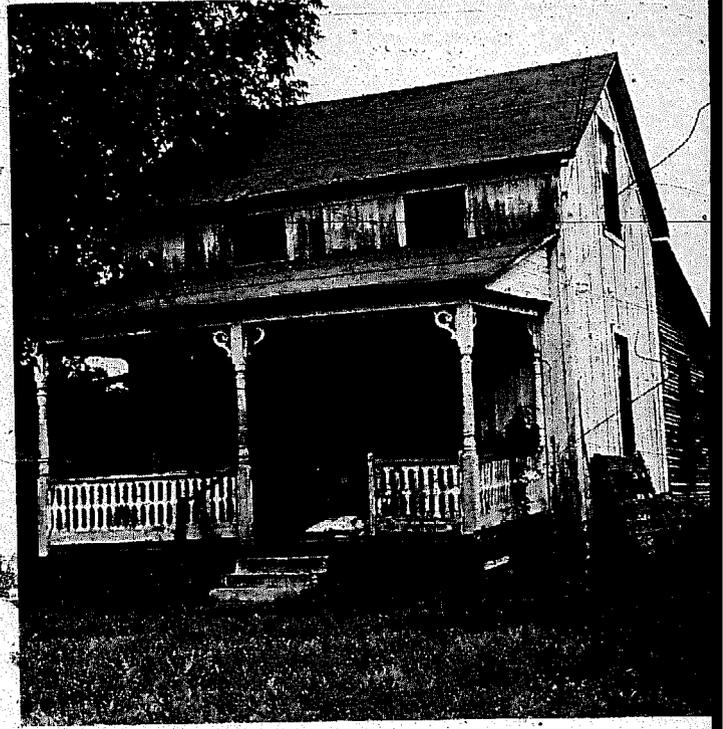
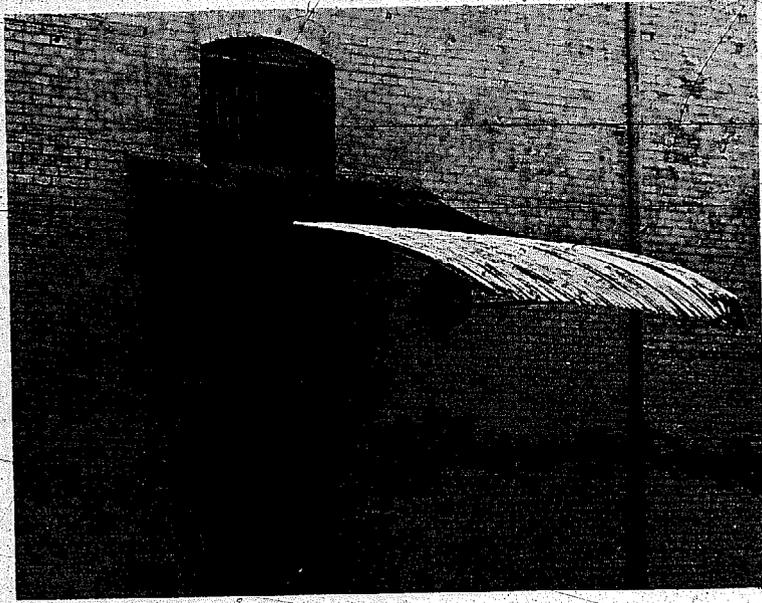

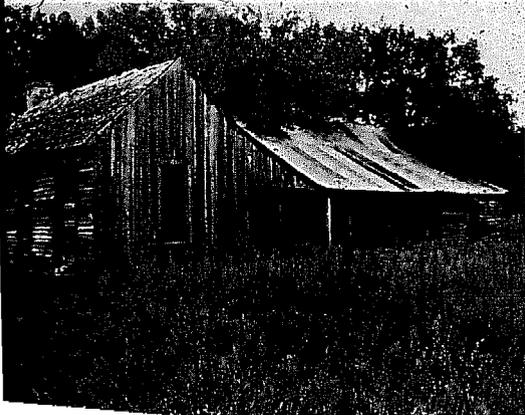
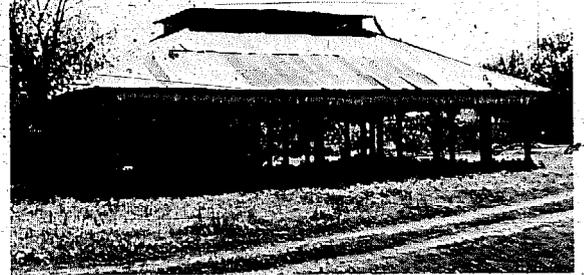
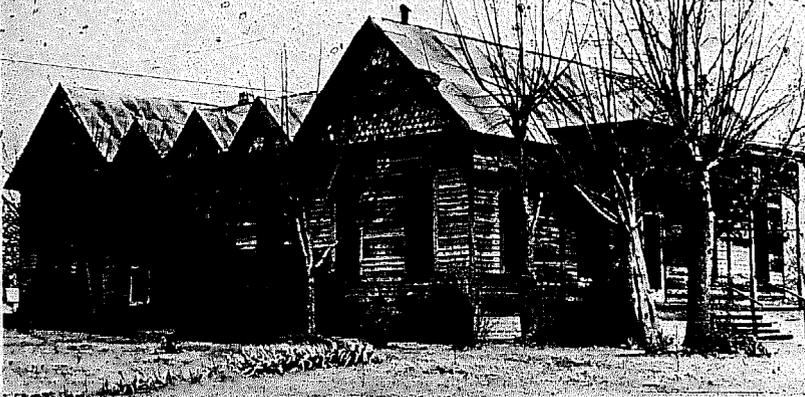

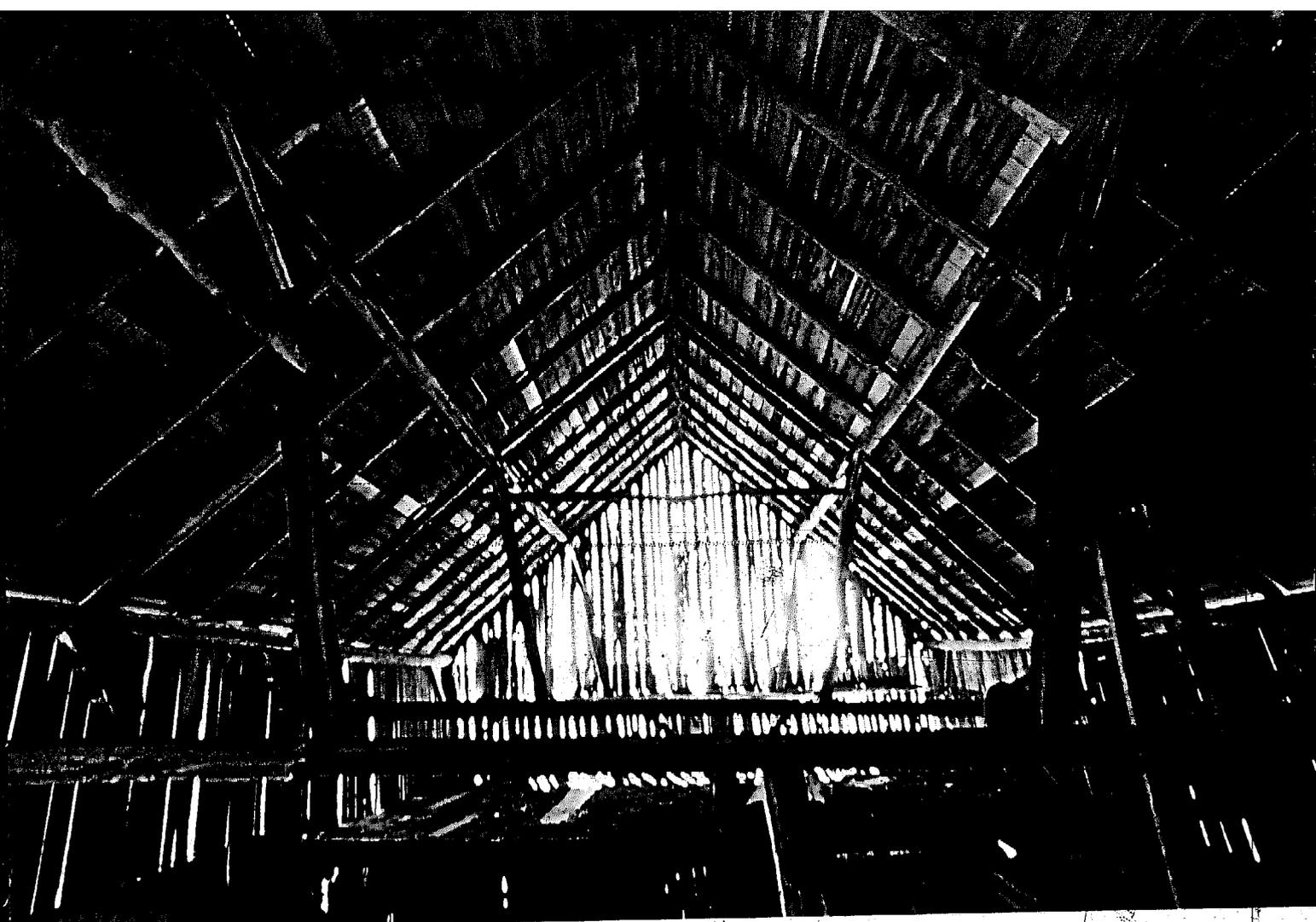

Washington

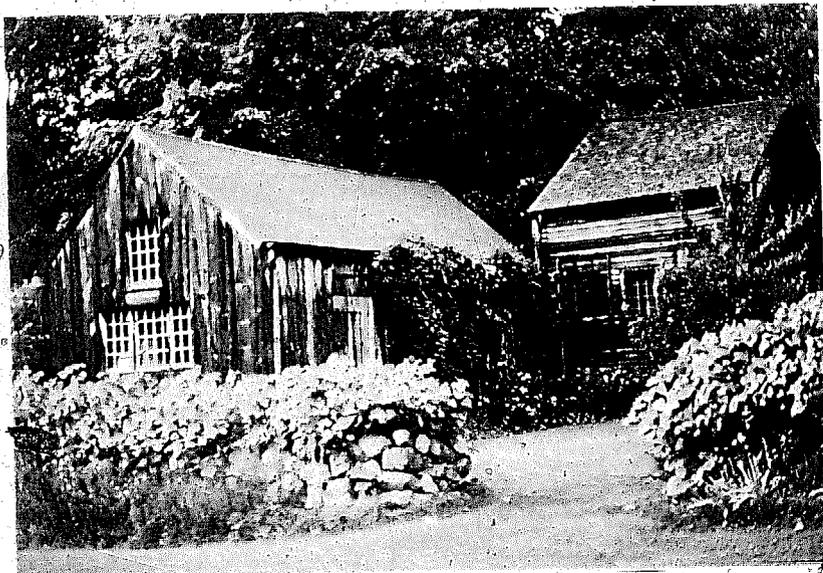

Washington

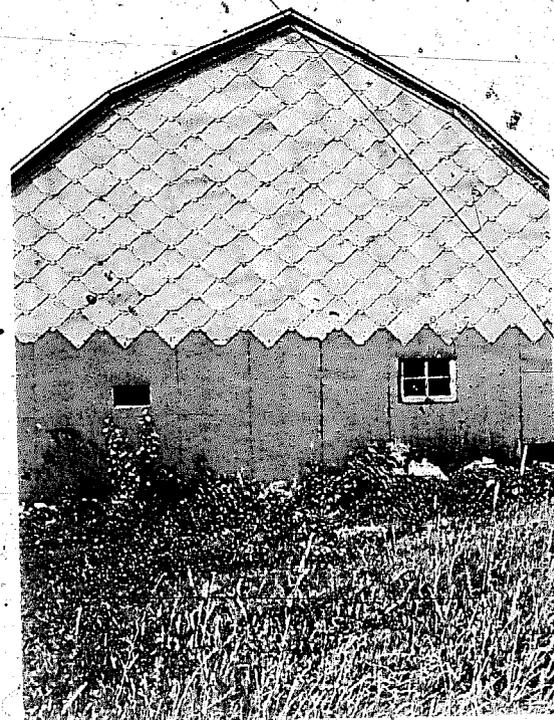

Country Buildings

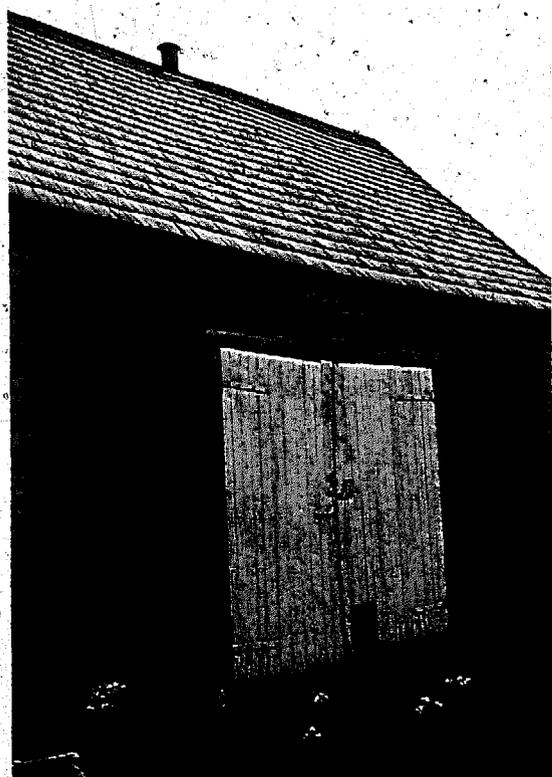

Novg Scotia



Kentucky

Connecticut



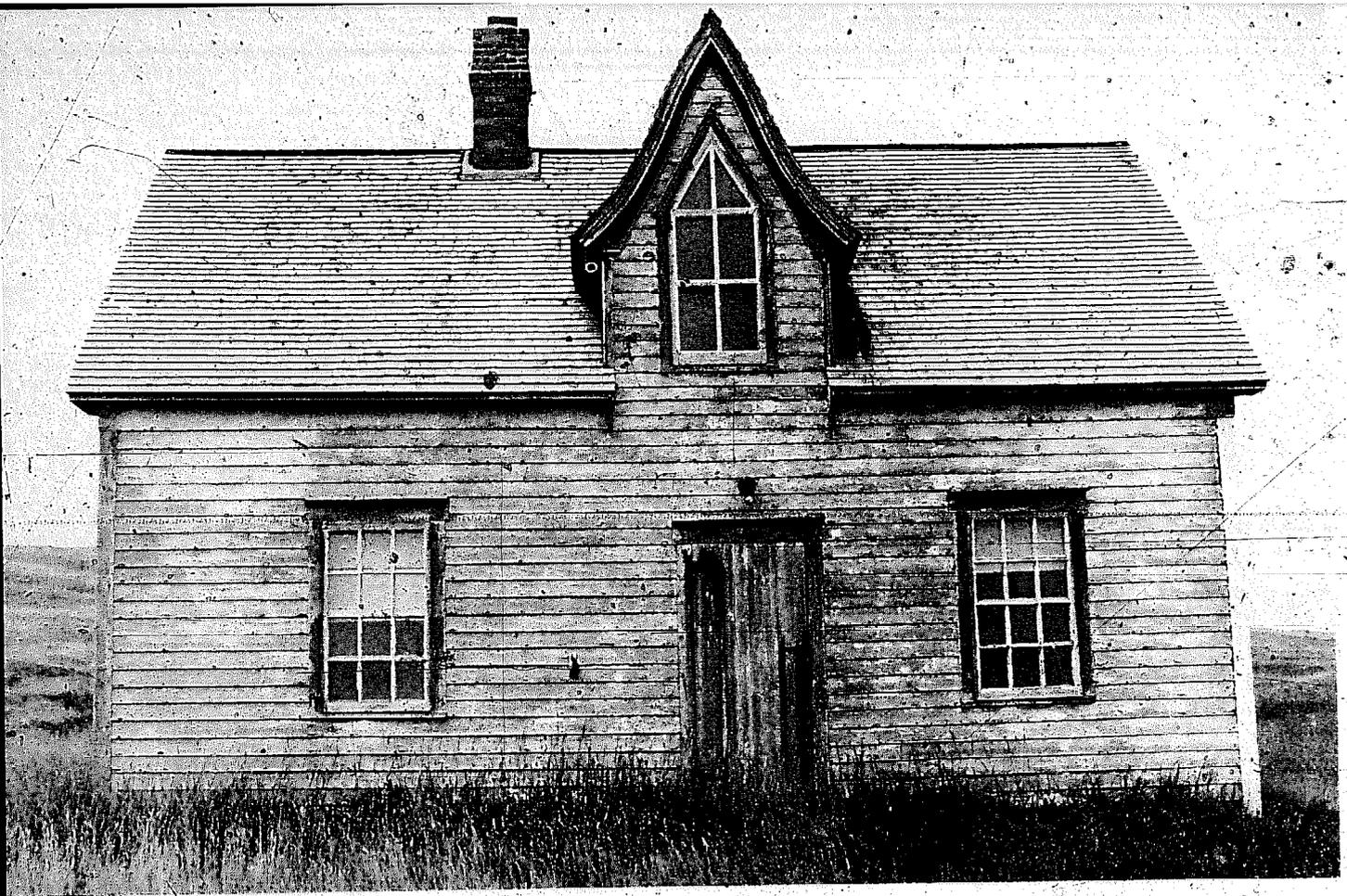

Nova Scotia

Mississippi

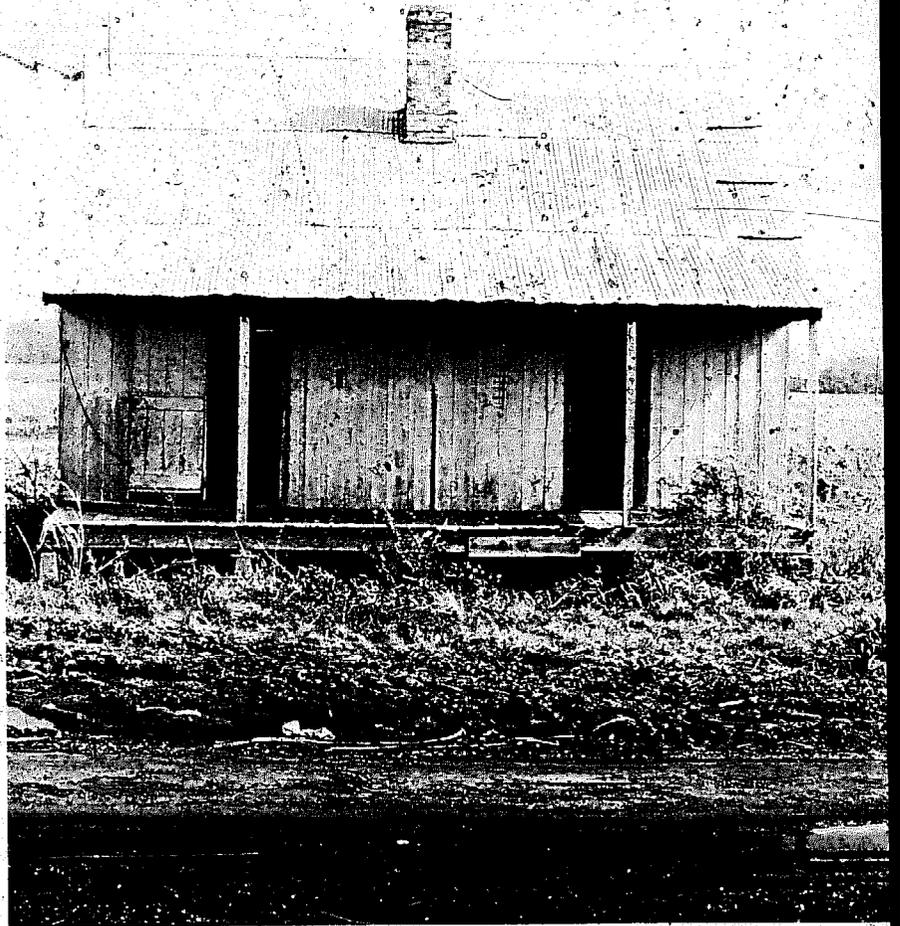
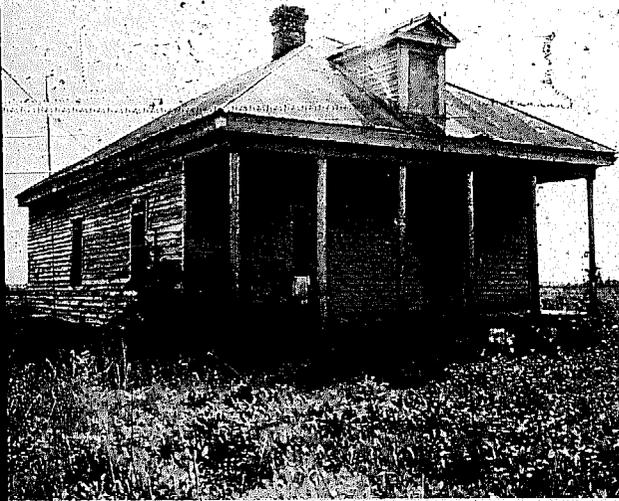

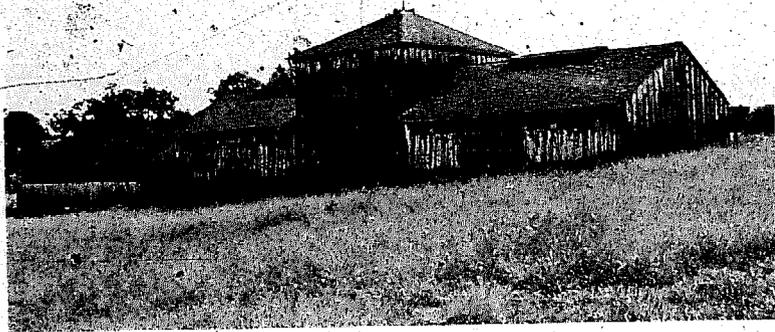

California



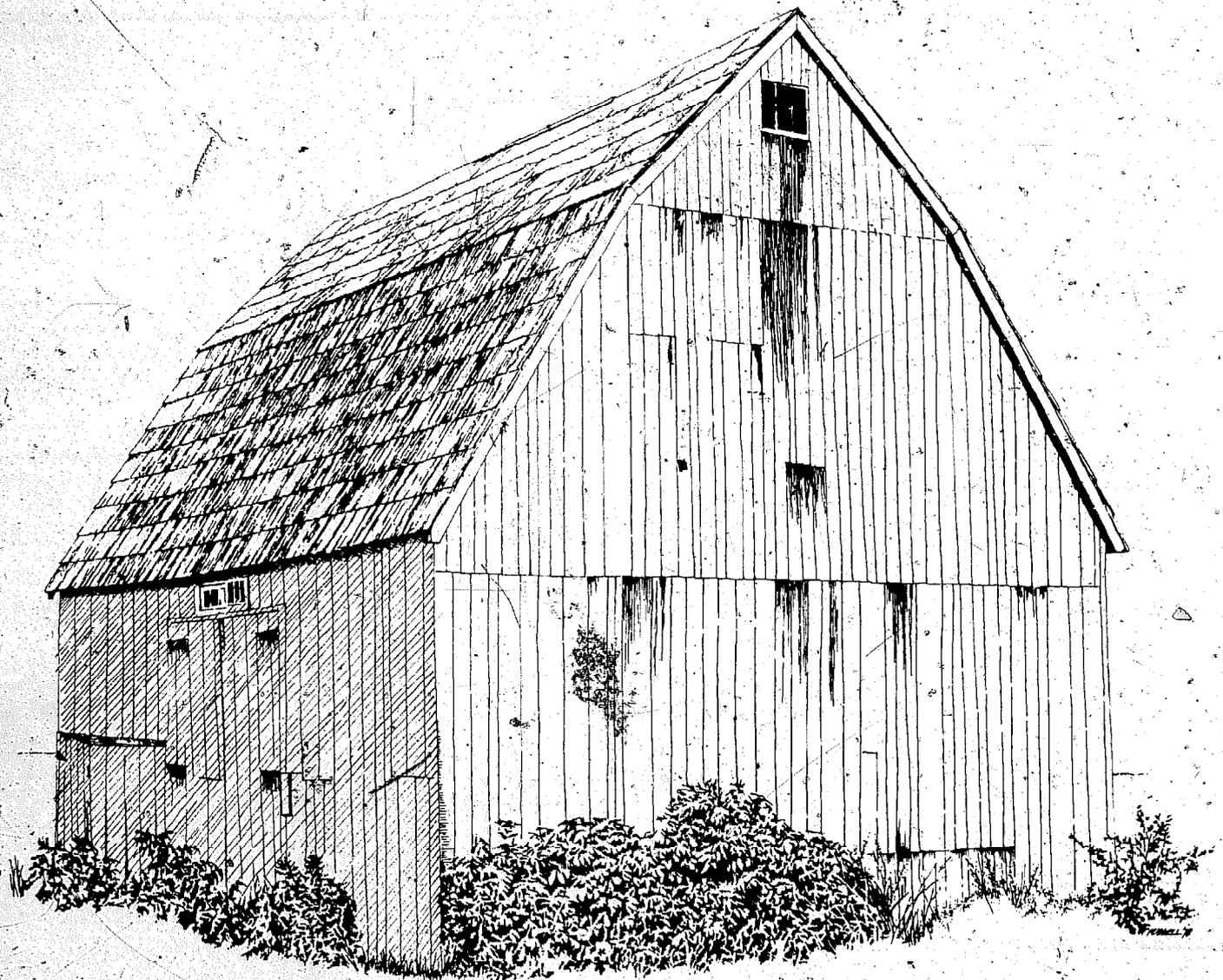

Barns

The barns of North America are a simple, practical expression of a way of life, the land, and the people who built them. They are living examples of the type building that occurs whenever efficiency, economy and durability are the influences shaping design.

The barn builders were anonymous farmers and carpenters who heeded local weather conditions, understood siting requirements, built with available materials, and let practical purpose rather than style govern design. Often the owner, designer, builder and user were the same person.

Few barns are being built in America these days. Feed is seldom raised and stored on the farm, but is now shipped in from other areas. Barns are going the way of the family farm, which is unable to compete with the (short-term) cut-rate prices of mechanized chemical agriculture. Many are either falling apart, or being burned or torn down. Yet those that do remain, that are maintained by their owners, are graceful and harmonious examples of functional design, of the days of a land-conserving and energy-efficient American agriculture.

continued



This Washington barn, built in 1925, is 75 feet long, 55'-6" wide, and 45 feet high at the gable. Rafters are 50-55 feet long, full length cedar poles from old growth, high-altitude

trees, chosen for high strength and light weight. The roof is of hand-split shakes. The entire barn, with the exception of wall siding, was built without the use of a sawmill.

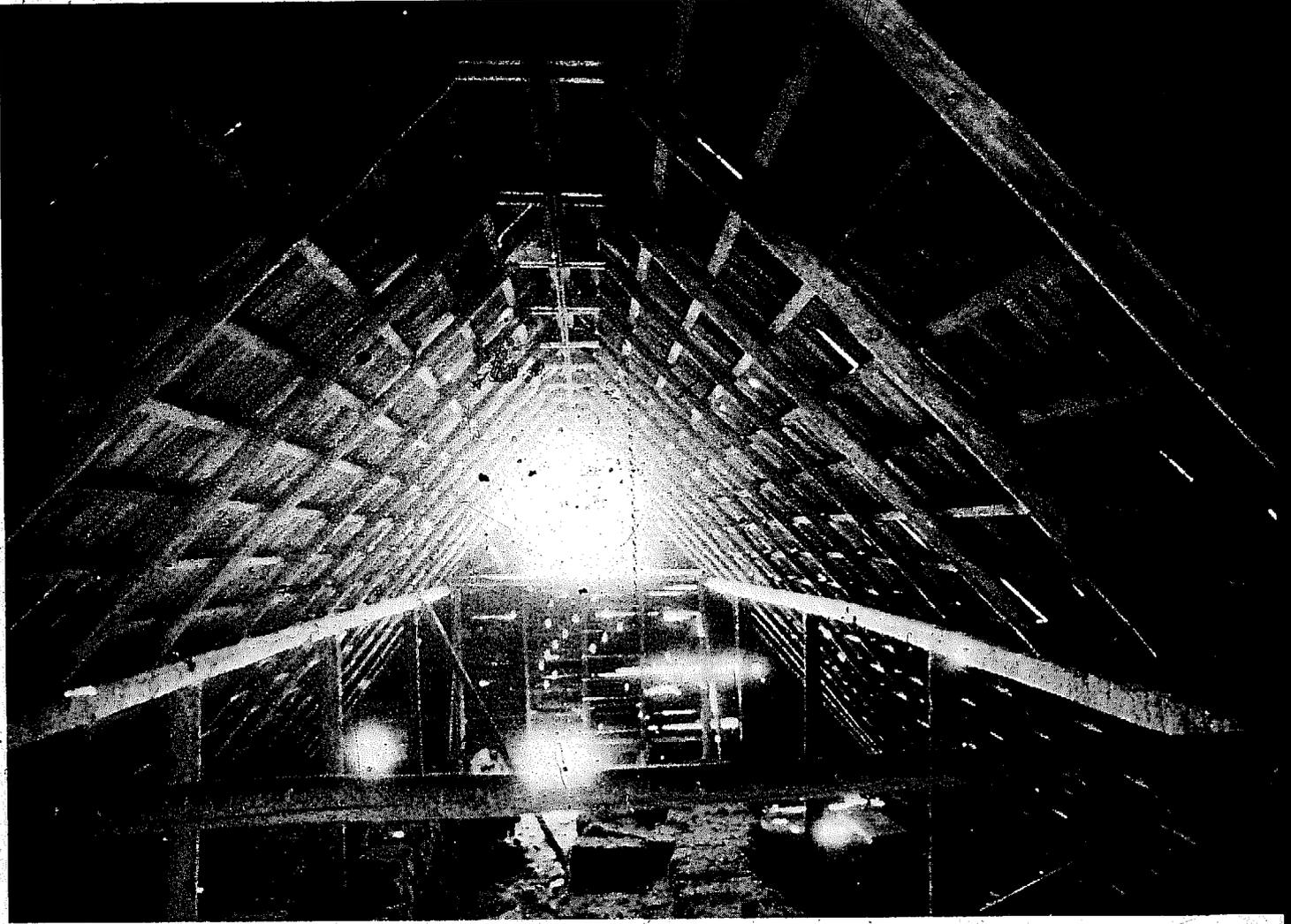

These large barns in the state of Washington show the same "aisle and bay-divided" structural framework of the great European barns (see *Shelter*, pp. 30-32). Roof rafters do not span from

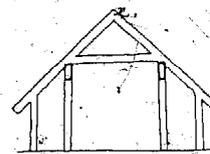

wall to ridge; rather, there are two interior rows of posts with beams that provide intermediate rafter support.

Incidentally, this type roof structure is what shelters most of Europe's Gothic cathedrals (over the vaulted stone ceilings).

As the European settlers moved west in North America, they framed their barns this way. On the west coast, with light snow loads, large barns were built with milled lumber and on a weight-per-square-foot basis, are among the world's lightest weight buildings.

This barn was built in 1912 on the farm of Willis Chambers near Port Angeles, Washington. Francis Chambers, who was a boy at the time, recalls working on the barn, that the head carpenter was a man named Hartlett, and that it took about three months to complete the building. The barn is 80'-6" long, 76'-8" wide and 43 feet high from ground to ridge. The framing is of all clear cedar.

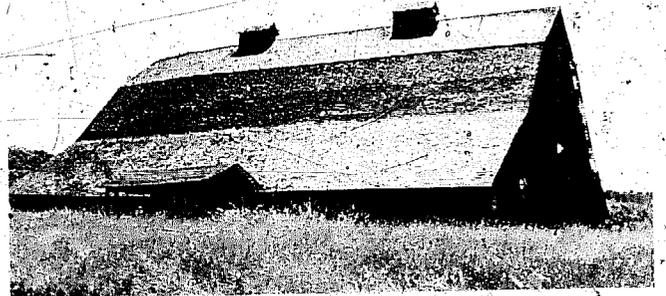
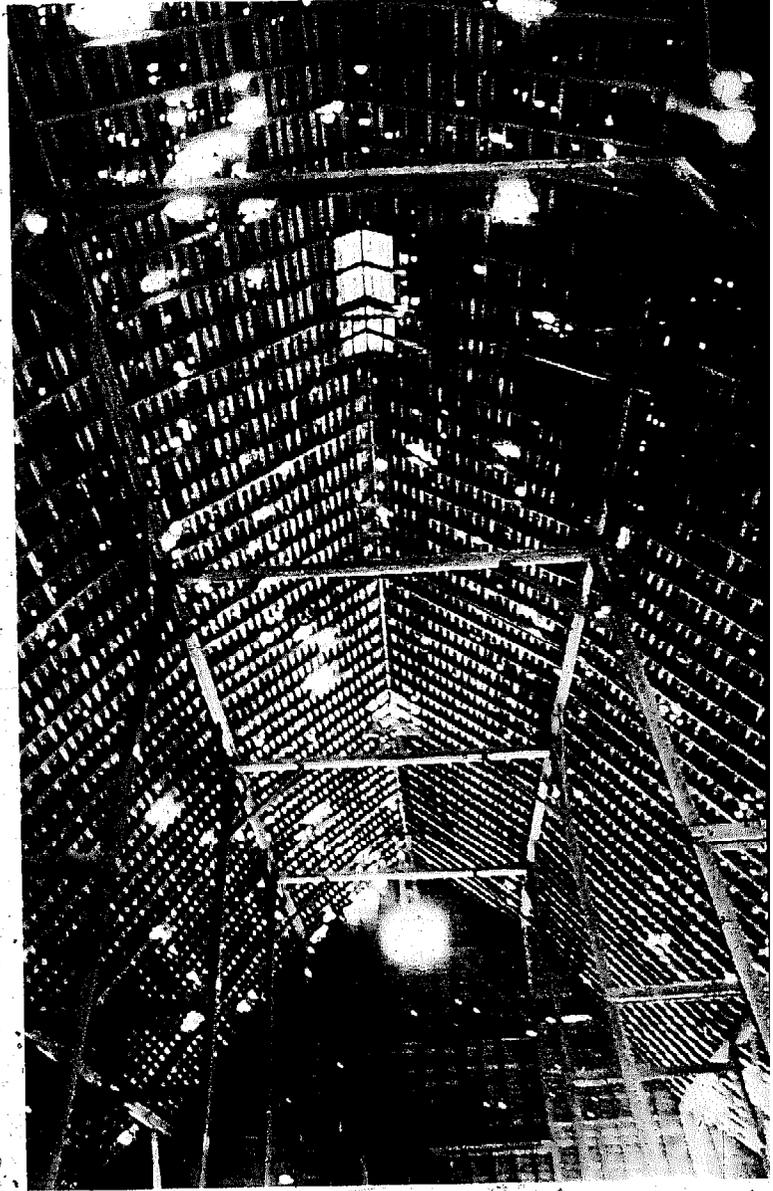
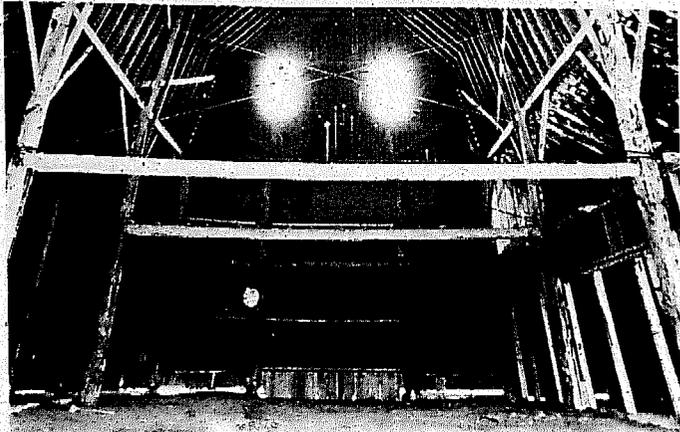
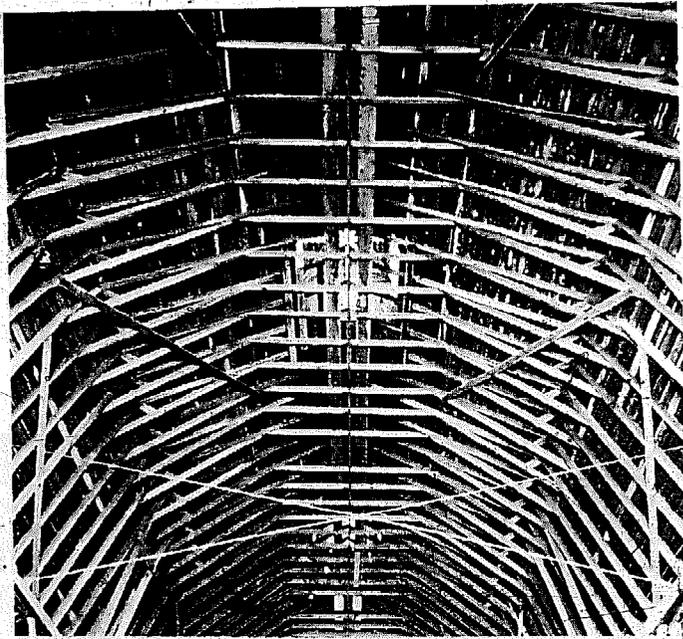
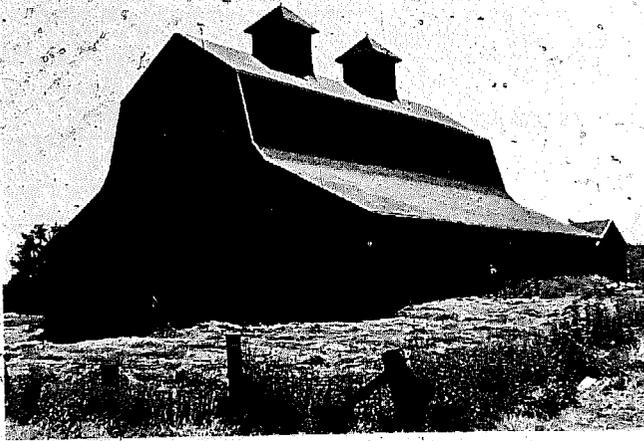

The large barn, above, down the road from the Chambers barn, is falling apart. When we were looking at it an old man came out, said "What good is it?" Large barns were formerly needed for hay storage in this rich agricultural valley, but modern feedlot livestock practices have made them obsolete.

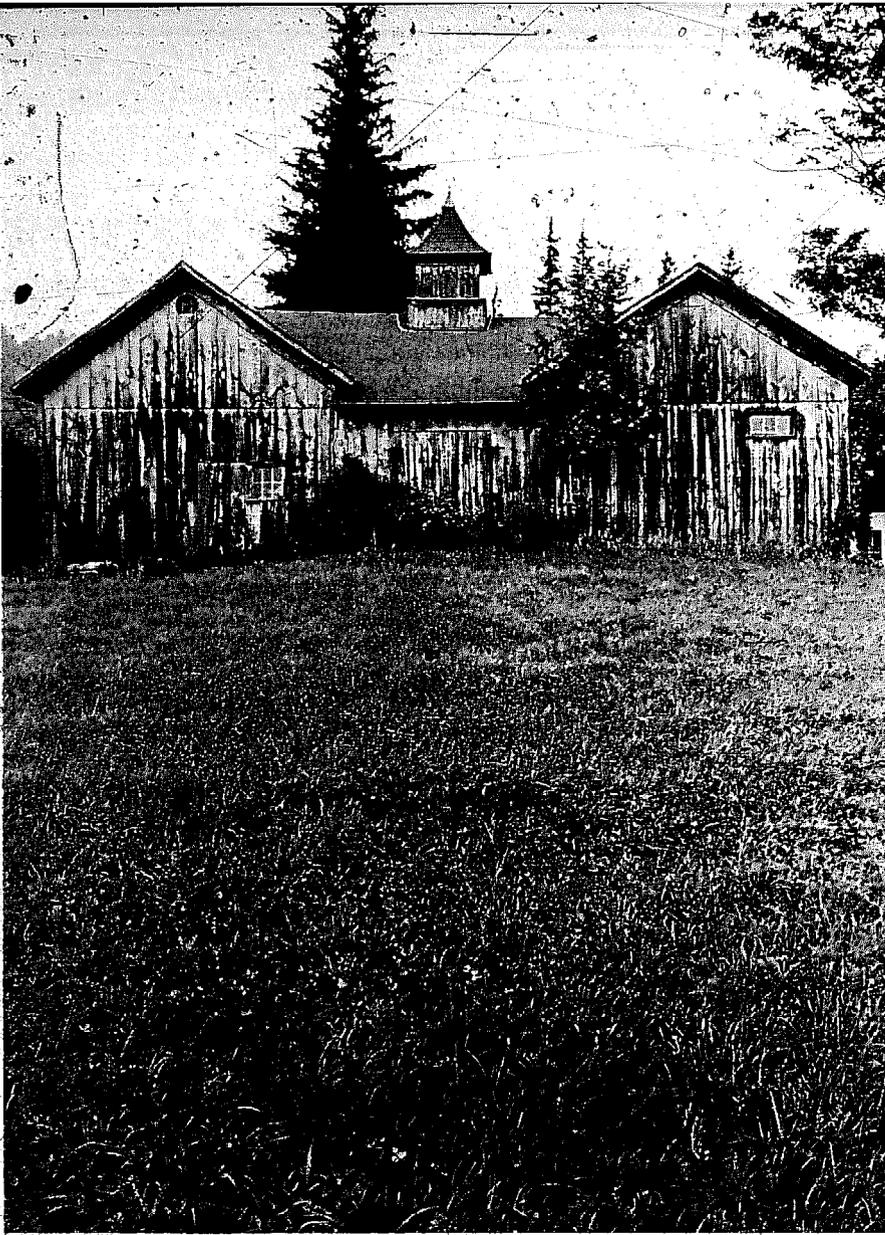

Connecticut

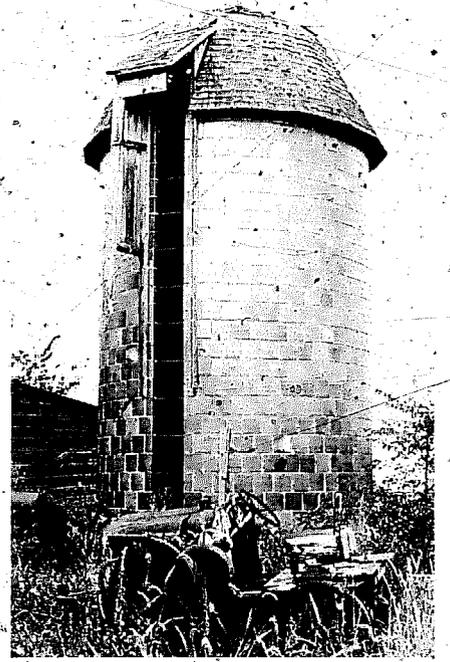

Silo in Connecticut

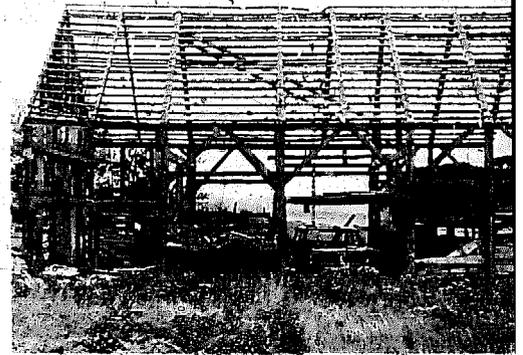

Mortise and tenon barn frame, Nova Scotia



Above and right: bay barn in Washington





Nova Scotia

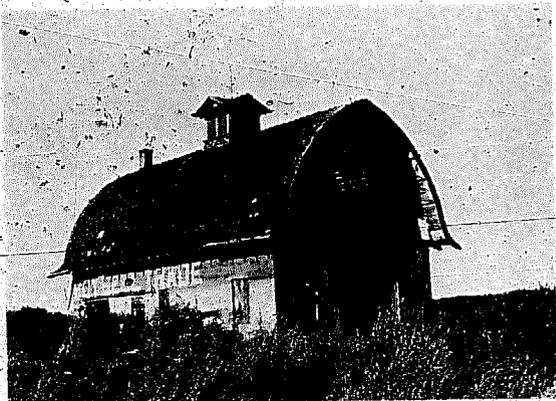

Washington

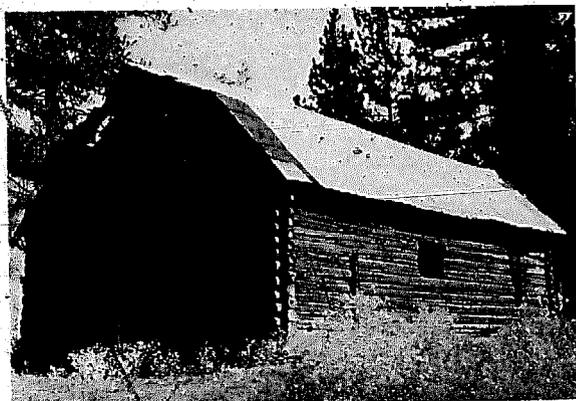

Log barn, Washington



Washington

Bungalows

by Renee Kahn
Photographs from David Gebbard



The term *bungalow* comes from the Hindustani word "Bangla" (literally - from Bengal) and signifies a low house surrounded by porches. These houses were not typical native dwellings, but were the "rest houses" built by the English government in India for the use of foreign travellers. Rambling one storey structures, they were designed to withstand the heat of the Indian climate, and had wide overhanging eaves, stone floors, and long, breeze-filled corridors. Deep verandahs (another Indian word) provided additional shade. The word *bungalow* was brought back to England by retiring civil servants, and eventually came to describe any modest, low-slung residence of picturesque lines.

In the United States, the term *bungalow* supplanted the word *cottage* and was popular because of its euphonious sound and exotic connotations. During its heyday prior to World War I, thousands of bungalows were built . . .

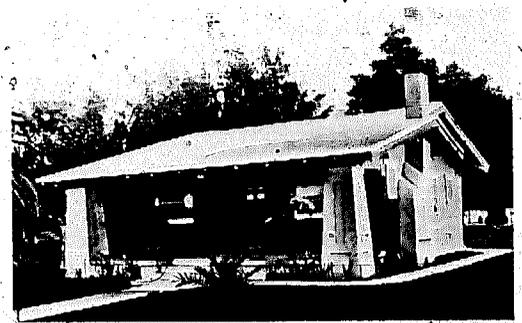

Despite wide variations in style, cost and location, the bungalow had certain, almost universal characteristics. Its lines were low and simple, with wide, projecting roofs. It had no second storey (or at most a modest one), large porches (verandahs); and was made of informal materials. It was primarily for use as a summer, or resort house, except in the warm California climate, where it was easily adapted to all year round use. . . .

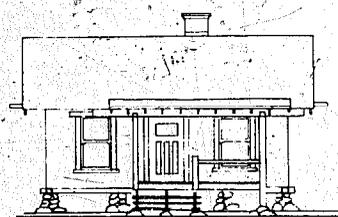
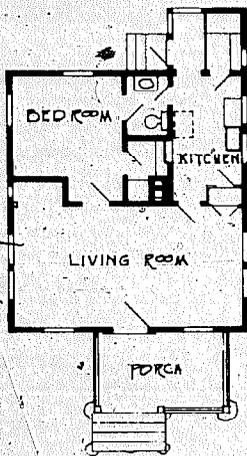

Small speculative house designed by Charles and Henry Greene, California architects, in 1906.



Floor Plan of No. 2009

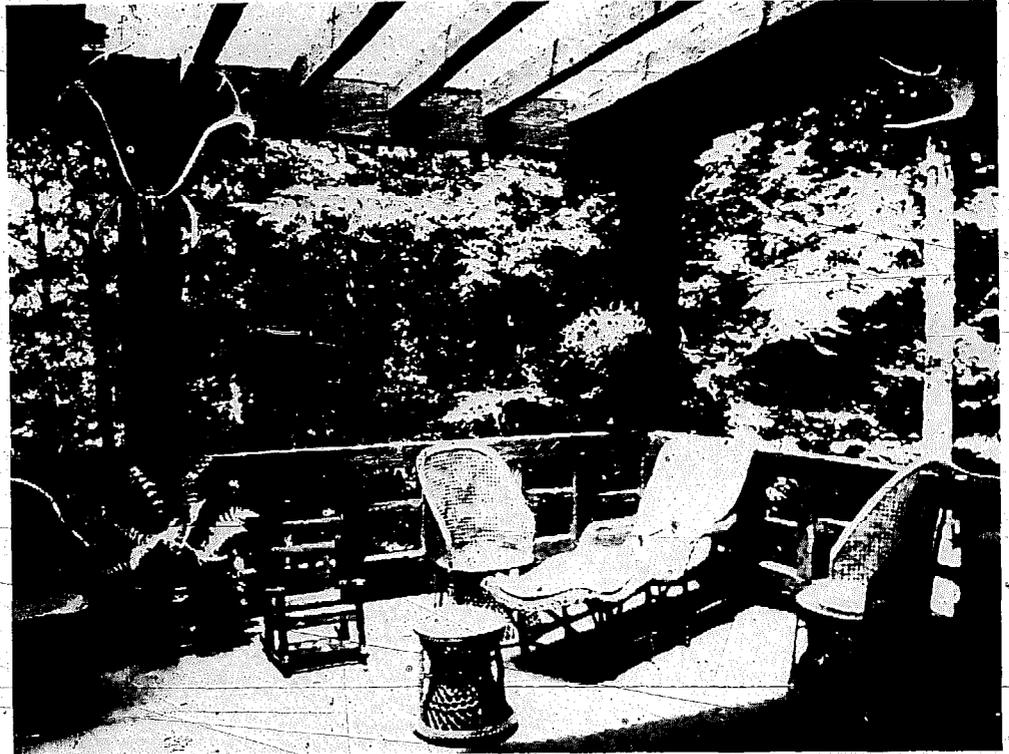

Bungalow Design No. 2009

Price of Plans and Specifications \$5.00



• Porches were an essential part of the bungalow style, but unfortunately, they were designed for sunnier climates, and darkened the interior of the house. This was often overcome by constructing the porch with an open roof, like a trellis, which could be covered by vines or an awning. Porch roofs frequently echoed the gable of the house, but were placed off to one side. Posts were made of boulders, or covered with shingles, contributing to the desired "natural" look. This natural look also extended to the outside wood finish which was either left plain, or stained, sometimes with a lump of asphalt dissolved in hot turpentine.

Full and complete working plans and specifications will be furnished for \$5.00. Cost of this bungalow is about \$900, according to the locality in which it is built.



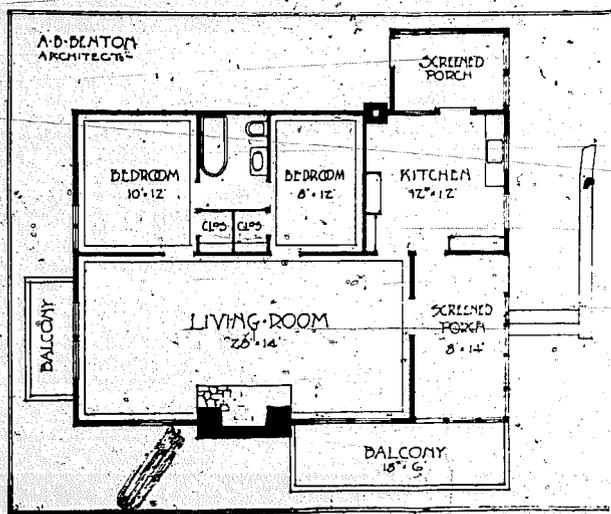
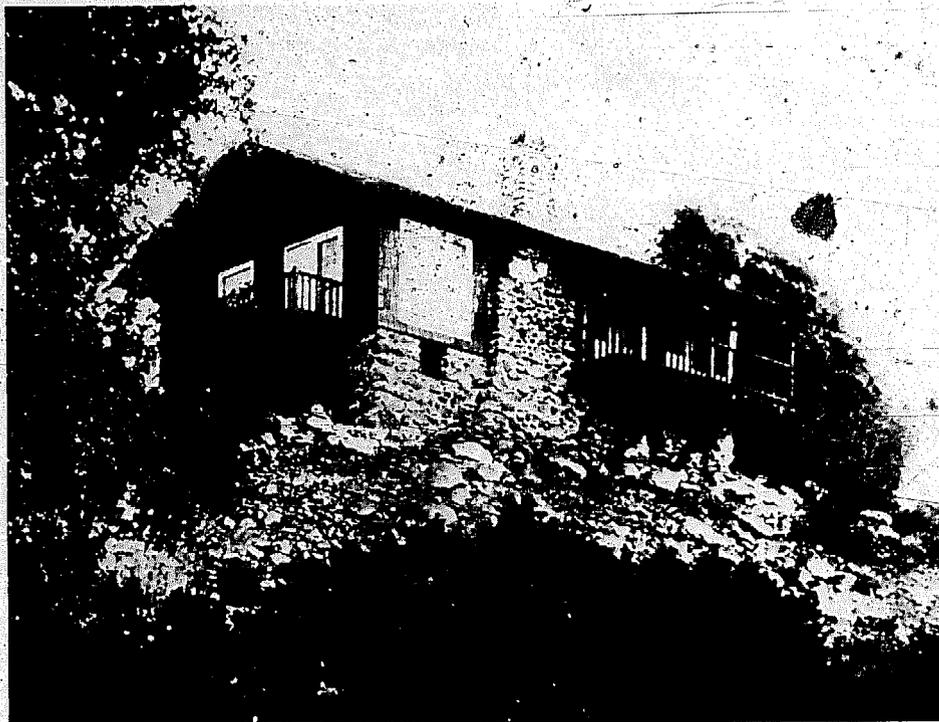

The flood of literature after the turn of the century brought much advice on how to furnish the bungalow. Simplicity, and lack of pretension were the main goals. Gustav Stickley, the furniture maker, was also editor of the magazine "The Craftsman," and was one of the major promoters of the bungalow style, which he referred to as "Craftsman Homes." In 1909 he wrote: "When luxury enters in, and a thousand artificial requirements come to be regarded as real needs, the nation is on the brink of degeneration."

Stickley, a disciple of William Morris, was also responsible for the sturdy oak furniture commonly known as "Mission." These comfortable, handcrafted pieces were considered appropriate for the bungalow, as were the plainer versions of wicker and rattan. Easy-to-care for leather or canvas covered the seats. No pretty bric-a-brac lay about, only sturdy art pottery and brass or copper bowls. Matting and shag rugs were suggested for the floor; however, Orientals were "never out of place." Surfaces were simple, and covered with natural looking stains. . . .

Bungalow Design No. 2001

Price of Plans and Specifications \$5.00

Floor Plan of No. 2001

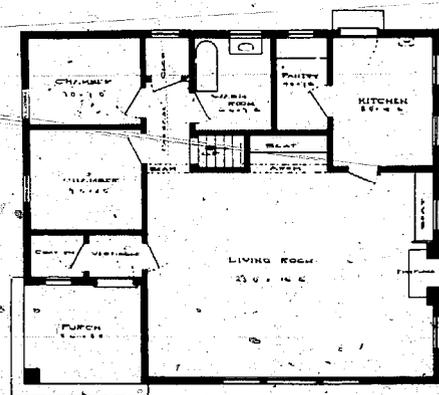

Full and complete working plans and specifications will be furnished for \$5.00.
 Cost of this bungalow is about \$700, according to the locality in which it is built.



It seems ironic that the bungalow originally had its greatest impact upon the intellectual upper middle class who valued it for its "honesty" and "practicality." Despite its lofty aspirations and exotic sources, the style ended up sloppily imitated in thousands of tacky boxes. It has come to represent both the best and the worst in American architecture from the turn of the century until the 1920's.

It did, however, make positive contributions to the American home with its lack of pretentiousness, its use of natural materials, and its effort to integrate the house with its surroundings. Its direct descendant, the ranch house, a somewhat characterless version of the bungalow, remains today one of the most popular forms of domestic architecture.

Stickley saw them as "the kind of houses that children will rejoice all their lives to remember as 'home,' and that give a sense of peace and comfort to the tired men who go back to them when the day's work is done." □

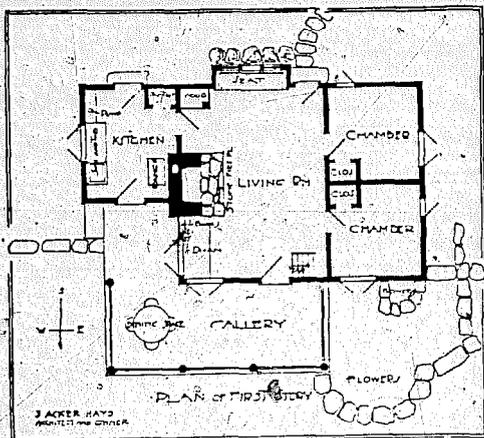

Text reprinted from *The Old House Journal*, September, 1977.



Design

In most situations, the stud frame house is the most practical way to build in North America today. Other forms of building — adobe, stone, logs, post and beam, etc. — may be more appropriate where the materials are available, and time plentiful. But in most cases, conventional stud construction of a small building will be the quickest, cheapest and most durable way to build a home.

In the pages that follow we present a survey of the design and construction of small stud frame buildings. The *Design* section (pp. 74-110) includes information, hints and advice on design of a small building, from siting, climatic and planting considerations to a discussion of basic roof shapes, floor plans, and additions and variations to these basic shapes. The *Construction* section (pp. 111-134) is an introduction to construction of a small wood-frame building, from foundation to roofing, as well as interior finish and miscellaneous building tips.

This is not a complete design manual, nor a thorough treatment of construction practices. Rather it is an introduction to some of the principles and practices of design and building of small homes.

Advantages of Stud Construction

- most building materials are manufactured for this type construction, and are commonly available.
- rectangular floor plan, vertical walls makes expansion easy.
- conventional roofing materials are cheap and durable.
- stud frame is easy to insulate.
- lends itself well to used materials.
- easy to take apart, reuse materials.
- complies with building codes.
- quickest form of conventional construction.

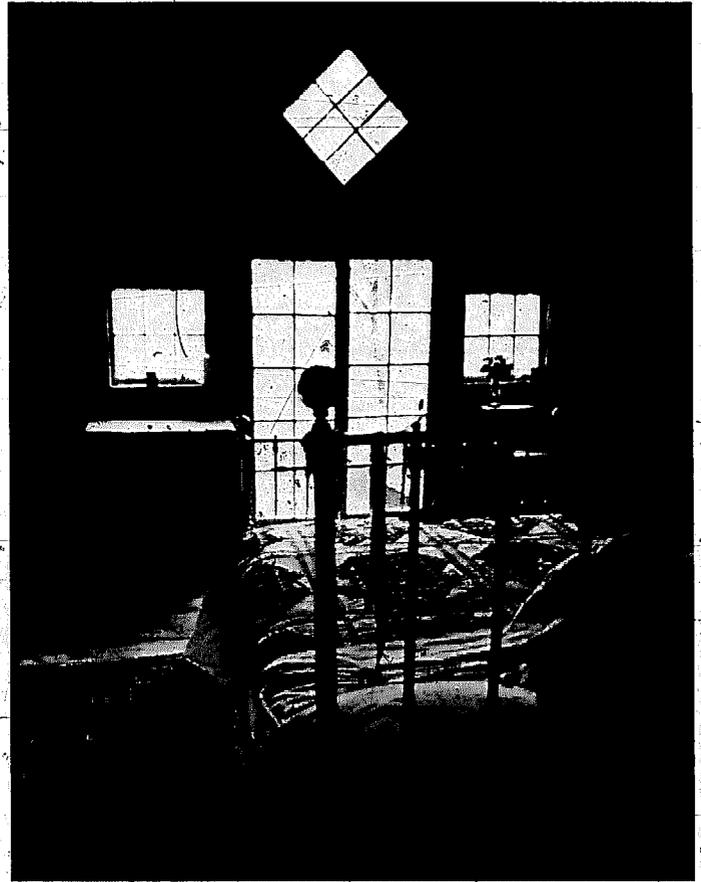
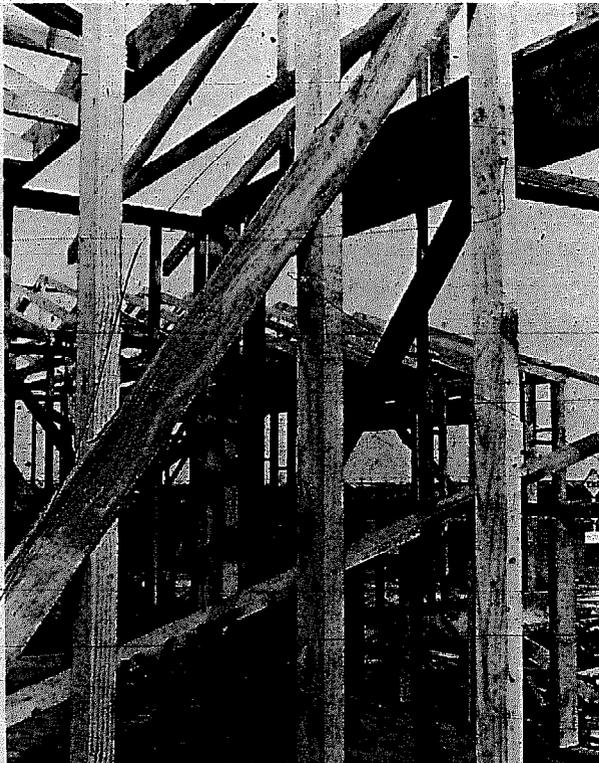

The Abstract Concept vs. The Hard Reality

Building a house is most likely the biggest thing you will ever attempt — in sheer size, money invested, hours spent, energy exerted. In recent years, a great many first-time builders have made the mistake of building a home from an abstract concept — a dome, a sculptural structure, a primitive or vernacular model — rather than from tried and tested building techniques. Many of these projects took more time and money and were far less practical than they might have been: the reality turned out to be quite different from the initial concept, and with something as large as a building, the mistakes can't be thrown away.

Builders are not fools. If polyhedral shapes were practical, the building industry would have converted to dome construction years ago. If post and beam had not been superseded over 100 years ago by the cheaper, more efficient stud construction, builders would still be putting up frameworks of heavy timber.

In these times, you've got to build your house while earning enough money to live on (few people can take a year off). You can't afford to take forever, to injure your health, or to end up with an expressive or modernistic assemblage that promises nothing but continual discomfort and/or maintenance.

Better one's house be too little one day than too big all the year after.

Thomas Fuller: Gnomologia, 1732

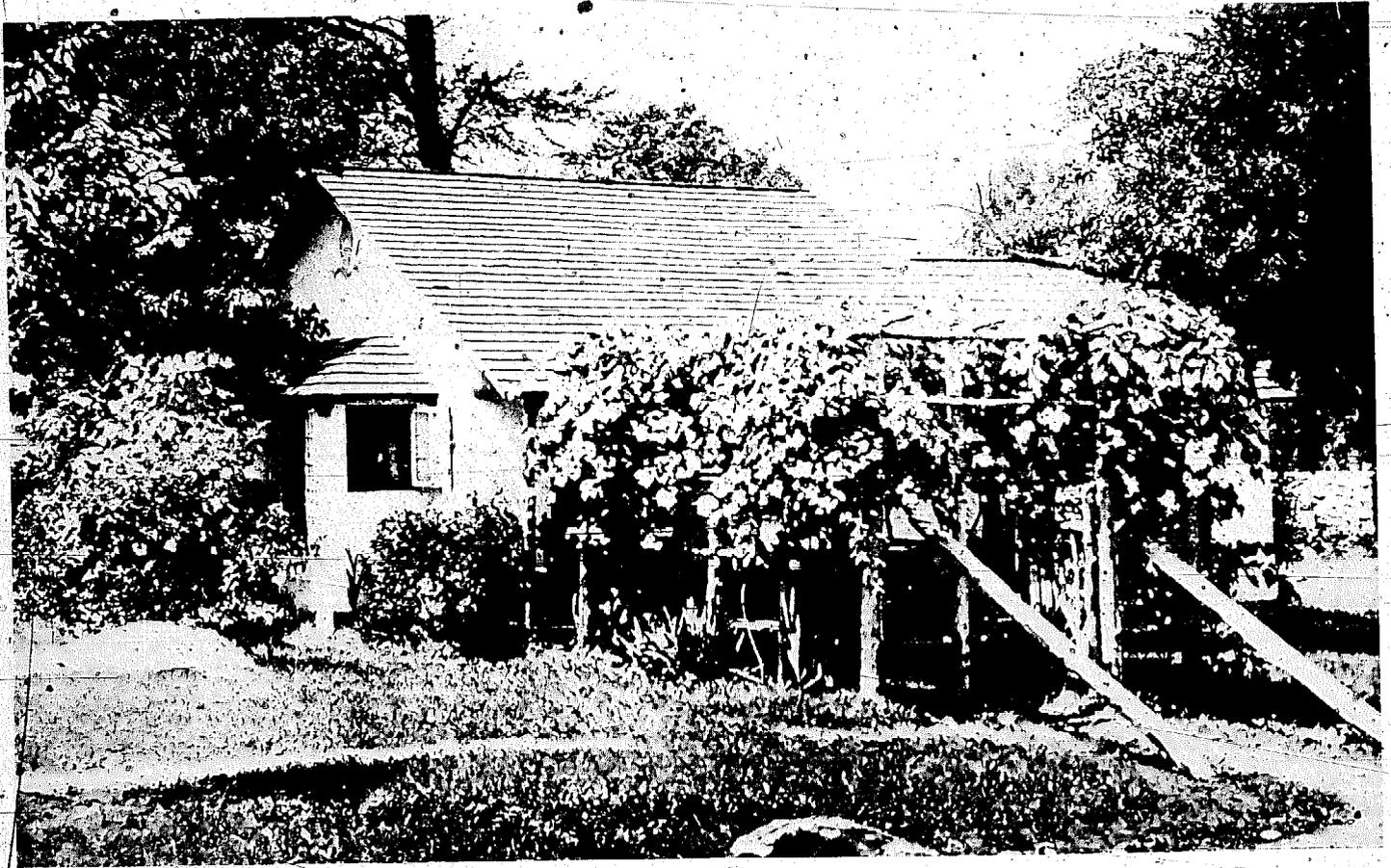

A very small house is legal under most building codes. You could build a 300-400 sq. ft. house, with kitchen and bathroom back-to-back (for easiest plumbing). Then when you have more time and money, you could add on. One story, short spans, simple to build, well insulated, easy to heat.

Even though you build in stages, it's good to plan as much in advance as possible. Should the addition be to the north, the south...? what about roof lines...? how will it tie in...? etc.

To check out a proposed floor plan: draw it out with chalk on a schoolyard or pavement. Include interior partitions, kitchen, furniture. Walk around within it to get a feel of the space. □

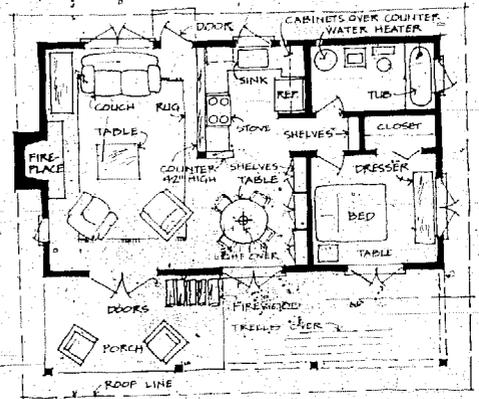

Climate Site Planting

A thorough understanding of your site will help you in making sound decisions in placement and orientation of a building. It would be ideal (though not usually possible) to live on the site for a year in a trailer or small shed and watch the changing of seasons, the wind force and direction, the variations in sunshine and rainfall, and temperature fluctuations before you build. In lieu of a long period of on-site observation, there are many factors that can be observed and researched that will help in good design. On these two pages are some very brief notes on siting, climatic and planting considerations. This is not a complete list by any means (books are written on each of these subjects), but rather a few basic ideas of these aspects of the design process.

Climate

Temperature

- consider daily as well as annual fluctuations.
- determine if there are any likely heating or cooling problems.

Rainfall

- determine rainfall through the seasons.
- what is direction of wind-blown rain?
- drainage around house.

Frost

- footings should be below frost line.
- will pipes freeze in winter?

Snow

- snow loads require heavier roof and foundation.
- snow insulates.
- eave design is important for shedding snow (see p. 123).

Winds

- there are daily and annual variations, often with a regular pattern.
- protection of outside sitting area and garden from strong or dusty winds.
- using pleasant breezes to cool interior spaces.

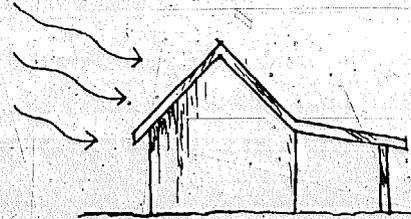

Sunlight

- indirect sunlight (as from the north) provides an even source of light.
- direct sunlight is useful for warming rooms or solar heating water.
- sun is low in the sky in winter, strikes south walls strongly, penetrates deeply into rooms through south-facing windows.
- sun is high in sky in summer, strikes roofs strongly.

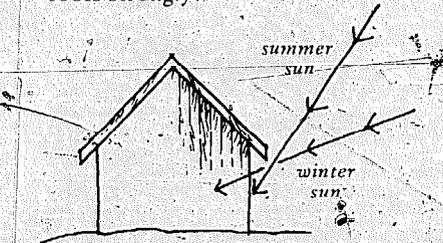

Site

Microclimate

Whereas *climate* generally refers to the conditions distributed over a large area, *microclimate* refers to the particular climate of one small location: "... at ground level multifold minute climates exist side by side, varying sharply with the elevation of a few feet and within the distance of a mile. ..." * Microclimate can be as important or more important on the site than climate. Microclimatic conditions change faster than climatic. Microclimate is often man-made, especially in cities. *Design with Climate, Victor Olgyay.

Orientation of slope

- south slopes are warmest; north are darker and cooler.
- eastern slopes get the morning sun; western get afternoon sun, are usually warm from daily heat build-up.

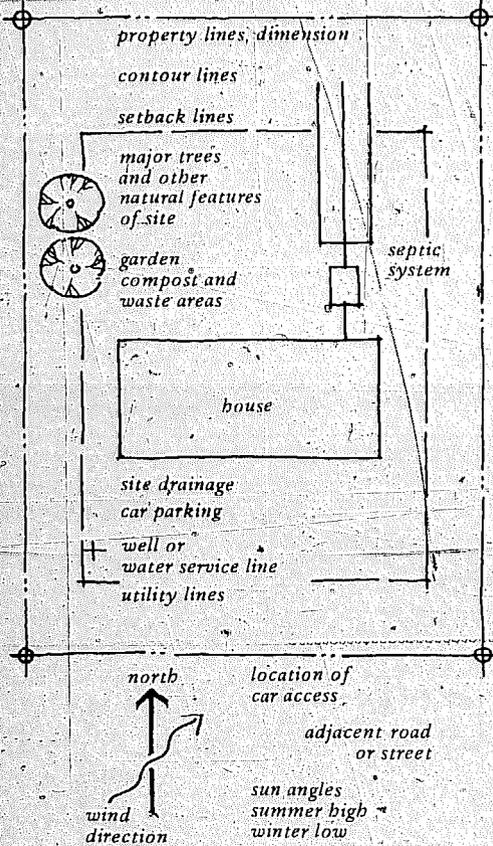
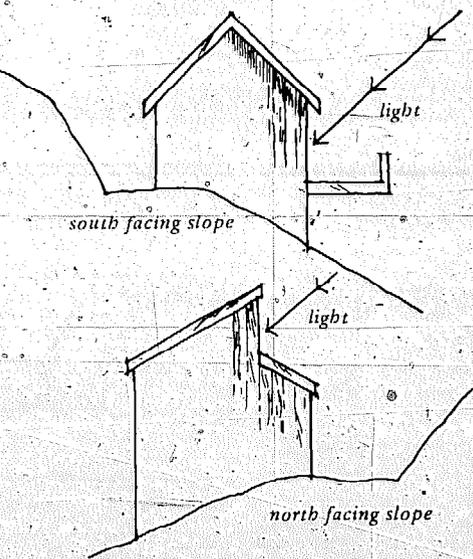

Site Plan

scale

A site plan drawn to scale will help determine location of house, septic system, trees, garden, etc.

Existing vegetation

- provides clues to soil, rock and water conditions.
- large trees can disturb foundations, may fall in storms, can provide (welcome) shade from hot summer sun, (unwelcome) shade for vegetable garden.

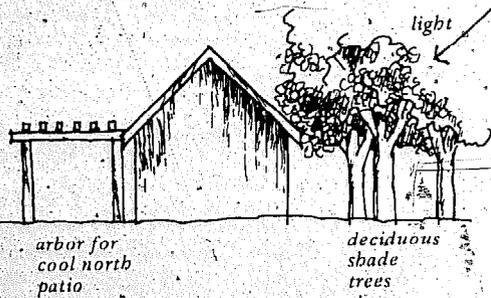

arbor for cool north patio

deciduous shade trees

Soil stability

- condition of soil at surface does not tell you what it is like 4' - 6' under. Dig a hole and see. Look for signs of unstable conditions or slides. If any doubt, consult a soils engineer.

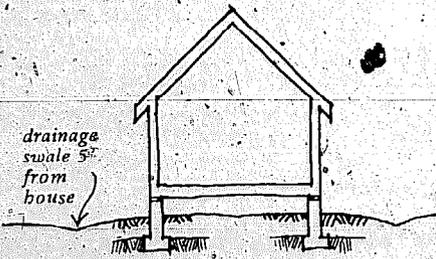

drainage swale 5' from house

foundation must bear on firm, undisturbed soil.

Drainage

- site building for dry footings.
- septic tank should drain away from house, never be above water supply.

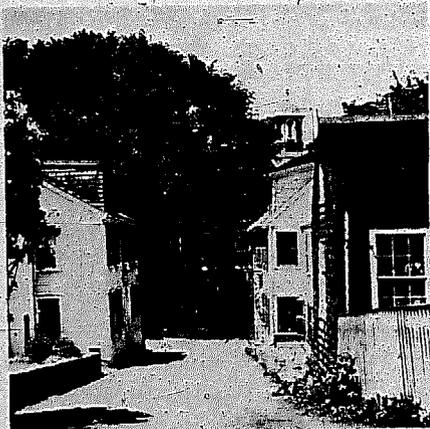

View

- windows can afford panoramic or framed view.
- You can make a view with patios or planting.

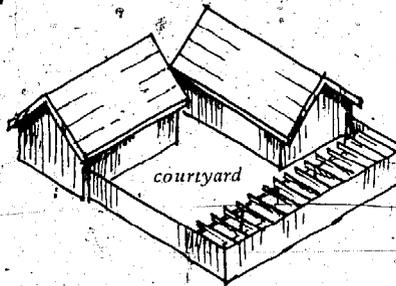

courtyard

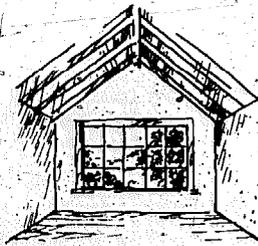

Privacy, noise, access

- plan for maximum privacy by orientation of building, placement of doors and windows, etc. For example, it is better to face a picture window towards the backyard than towards a busy street.
- consider noise from neighbors and traffic.
- allow for pedestrian and auto access.

Legal requirements are important: local ordinances, setbacks, front yards, easements, parking requirements, etc.

Utilities: check if they are available and if so, where they enter property. Cost of utilities is often high at a remote site.

Local traditions: ask old-timers.

Local architecture: Look at the small buildings near your site, those that were built 30 - 50 - 75 years ago: barns, sheds, coops, older homes. They were generally built with the economy of necessity, of local materials, suited to local weather. Notice roof pitch and overhang, building shape, orientation, siting, materials, details.

Planting

Plants can provide shade, privacy, wind protection, fencing, fruit, foliage, bird and wildlife protection, etc.

- deciduous trees will provide shade in summer, allow sunlight in winter.
- dwarf fruit trees can produce fruit in three years, can be planted 6' - 8' apart but need more care and feeding than full-size trees.
- evergreens (pines, firs, etc.) can be planted on north side for winter wind break.

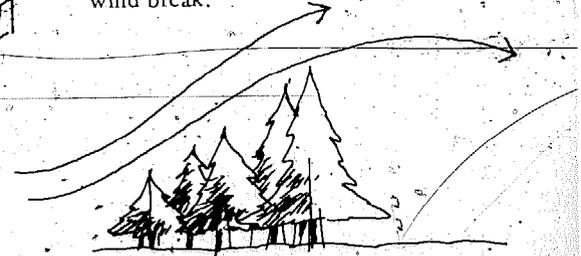

if a vegetable garden is planned, consider its placement in relation to kitchen.

- plants absorb sound.
- a good book on planting: *Plants/People/And Environmental Quality* (see bibliography).



Design Checklist

Checklist of Needs

These are ideas from people who have built their own homes—a random assortment of pre-design thoughts based upon occupants' needs and desires. As with the preceding two pages, this is not a complete list, yet these examples may give you a start in preparing a list for your own individual situation. To begin, we suggest you imagine yourself in a house: going through daily activities, looking out of windows, working in the kitchen, walking from one room to another, etc., as an aid in making up a checklist of your own needs and desires.

Early houses generally had one room for all activities; the fireplace was used for cooking, heating, and evening light. Later, in the industrial age with more abundant materials and fuel available, houses were partitioned into separate rooms for kitchen, dining, living, and sleeping. Now, in an era of dwindling fuel supplies, the earlier design of a one-room kitchen-dining-living space may be an efficient model to consider. A wood-burning stove can cook food while heating the room and its occupants. Cooking on a gas or electric stove will send some heat into the room, and the oven door can be left open after use to catch the remaining heat in the room rather than lose it through the flue. Warm blankets instead of heaters in sleeping rooms. Other rooms for daytime work need less heat if you are moving around, and warmly dressed.

Arrangement of rooms

- small houses are often one big room. Think in terms of areas for related activities rather than individual rooms and of activity centers rather than shuffling tiny rooms around. A small house isn't simply a scaled-down big house.
- see pp. 88-101.

Main room

- you can start small, building one main room with a kitchen. Later, as time allows, and finances permit, other rooms can be added. The main room can be basic living space, a base of operations for finishing the job. Thus it is important to plan as much as possible before you begin, considering the site and future additions in relation to this first phase.

Circulation

Crossing a room at a diagonal wastes space; try to have circulation along the perimeter.

Either minimize circulation space, or exploit it by enlarging somewhat to accommodate another activity.

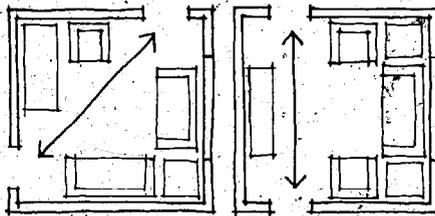

diagonal circulation makes room difficult to use.

perimeter circulation creates quiet, "dead-end" space.

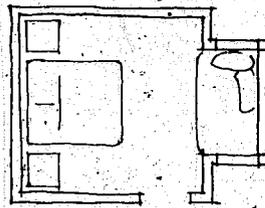

extend floor and roof for window seat

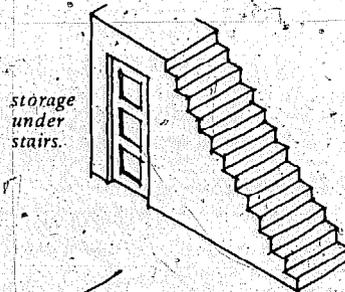

storage under stairs.

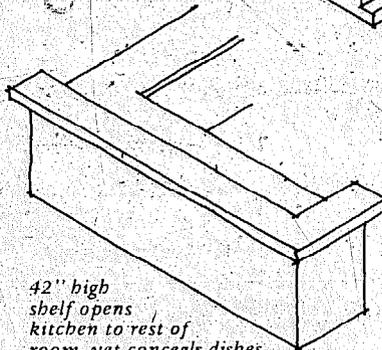

42" high shelf opens kitchen to rest of room, yet conceals dishes on counter from view.

Kitchen

- enough counter and storage area.
- sloped drainage counter so dishes can drain into sink.
- good working relationship between sink, stove, refrigerator.
- toe space under counters is important.
- counter height: standard is 36", but many kitchens have lower counters for kneading bread or chopping food.
- morning sun on kitchen table (S.E. window for low winter morning sun).
- counter height electric receptacles.

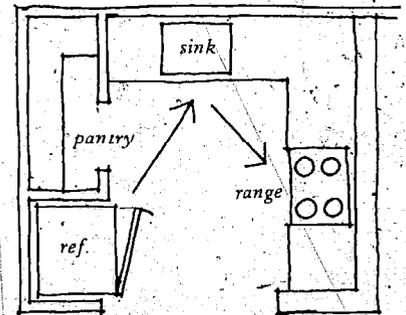

the kitchen triangle: food storage to sink to range.

Utility room

- a small room off the kitchen can be used for removing wet or muddy clothes or boots, or can be utilized for food storage, or for a washing machine.

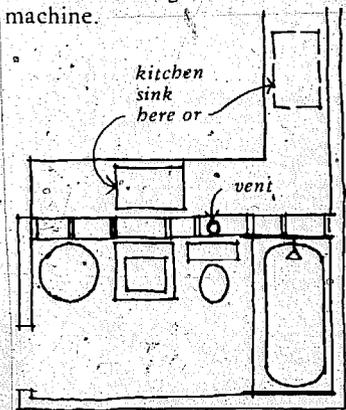

4" dia. vent in shared 2x6 stud plumbing wall.

Bathroom

- fixtures aligned in row on 2 x 6 stud wall is most efficient.
- hot water heater in bathroom helps heat room, is good place to dry towels over.
- best plumbing arrangement is with bathroom, kitchen back-to-back.

Sleeping

- bedrooms use a lot of space, which may be more useful elsewhere in the house.
- children spend more time in their rooms than adults; maybe they should have larger rooms than parents.
- sleeping areas in lofts, alcoves off the living room, or merely a corner of the main room.

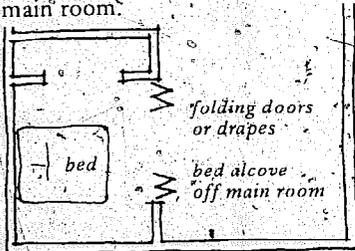

Storage

- some storage should be more accessible than others.
- closed storage areas for less frequently used items, open storage for items in daily use.
- roofed-over outside space for firewood, bicycles, etc.
- porch or mud room for shedding muddy boots, rain gear before entering house.

Basements

- cool space for storage.
- should only be built on sites with low water table and/or good drainage.

Workshop

- for home maintenance, tools, etc.

Doors

- doors generally open inwards; if door swings out, hinges are on outside and pins can be removed to break into house.
- porches or overhangs protect exterior doors from rain and wind.
- try not to place doors on windward side of house.

Let all the principal chambers of *Delight*, All *Studies* and *Libraries*, be towards the *East*: For the Morning is a friend to the Muses. All Offices that require heat, as *Kitchens*, *Stillatories*, *Stoves*, rooms for *Baking*, *Brewing*, *Washing*, or the like, would be *Meridionall*. All that need a coole and fresh temper, as *Cellers*, *Pantries*, *Butteries*, *Granaries*, to the *North*.

The Elements of Architecture,
Sir Henry Wotton, 1624

Windows

- view.
- ventilation: screened openings keep out flies.
- light.
- sitting areas that receive sun at different times of the year.
- windows so you can see someone approaching house before they arrive, for keeping an eye on children at play.

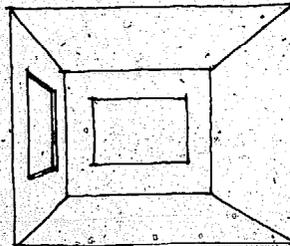
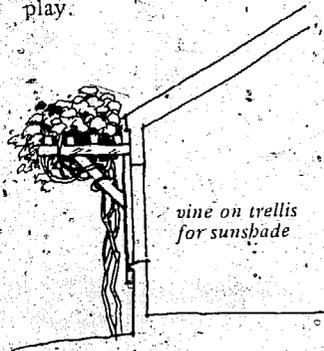

windows on two walls
balance light, help
ventilation.



Porches

- south facing porch for winter warmth, north facing for summer shade.
- large porch by main entrance provides storage for firewood, place to hang clothes, stay dry while opening door.

Noise

- bathroom between bedroom and living room.
- closets, bookshelves between rooms.

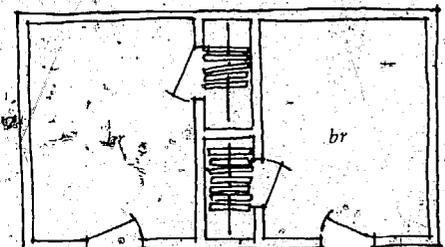

Closets between bedrooms

Heat source

- heat source in relation to living pattern: for example, plan nighttime living area close to heat.
- small rooms heat easily.
- large rooms generate drafts.

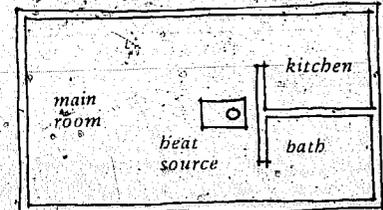

locate heat source
near center of building

Available materials

Many of the decisions about house design, and construction will be based upon the materials available locally. Used lumber, doors, windows are usually for sale in or near cities. In the northeast U.S. new Spruce is available from nearby sources. In the Pacific Northwest Douglas Fir is a local material. Many areas have stone; adobe or rammed earth is suitable in dry regions. A careful analysis of locally available materials is an important factor in house design. A study of materials used in nearby buildings can provide helpful guidelines. □

Flows

In the past few pages we have considered the physical characteristics of a house — its shape, placement on the site, relation to the elements — as well as functions and use of interior space. Now we will look at another group of characteristics about a home: the *flows* that move through a house.

Clean water flows in, waste water flows out. Cold and hot water are moved around in the house. Fuel comes in; heat circulates, as do breezes. Food is brought in, compost, garbage and human wastes move out. Dirt and dust come in and are taken out. Smells move about. Electricity flows in and is converted to heat, light and power.

These movements of liquids, materials, warm and cool air, and energy are all important to consider in the planning and design of a home. What to do with wastes, where to place a heat source, where the food comes in, how and where food scraps are disposed of, where electricity or gas and water come in, how natural breezes can cool the house.

Following are a few brief ideas on some of the flows through a house:

Ventilation-cooling

- *air flow*: windows, dormers, belfry, porches, balconies can help carry heat out.

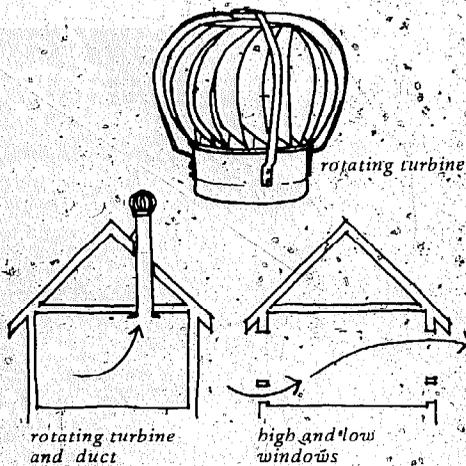

- *buffer rooms*: porches, mudrooms, verandas modify heat gains and losses.
- *shading*: overhang, trellises can keep summer sun out.
- trees can deflect air currents around a house, or can be sited to increase wind flow towards a house.

Heating

- plan winter living near heat source.
- drapes, shutters, storm windows can help conserve heat. *Portieres* are heavy drapes hung in doorways to retain heat.

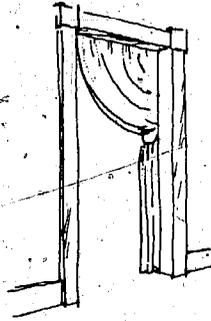

- orientation of windows (southern exposure) allows heat energy to flow in; sunshine is a "fuel."
- weatherstripping around doors and windows keeps cold out, warmth in.
- insulation; see p. 129.



Water Heating

- hot water accounts for a great deal of the average household's energy use.
- locate heater close to fixtures (kitchen and bath).
- pressure relief valve on hot water heater is important; can prevent explosion.
- conserving hot water: a) turn thermostat down b) insulate tank and pipes with fiberglass.

Waste Water Out

- waste water contains soap, grease, food particles etc. that can damage plants, compact soil, destroy micro-life when applied directly to soil.
- reclaimed "grey water" (drain water only) can be used for irrigation if properly filtered, or digested in small septic system to produce clear effluent.
- boron is destructive to plants.
- bathtub water is fairly clean for use on plants.

Odors

- windows, hood, or pop-up vent over stove will exhaust cooking odors directly.
- openable window next to toilet.

Garbage

- area to separate glass, paper, metals for recycling.

Food In and Out

- consider where vegetables from garden, groceries will be brought in, how they will be stored (crock, tins, jars, etc.).
- food scraps can be kept in plastic bucket, emptied every few days, or smaller container, and emptied each day.
- compost can be worked into compost pile, or buried in trench.

People In and Out

- an entry porch can be a place to take off wet rain gear, muddy shoes.
- door mats — rubber on the ground level, fiber on the doorstep — can help keep out dirt.

Drying Clothes

- outdoor clothes line close to washing machine.
- indoor clothes drying: hang nylon strings 8" apart behind fireplace, stove, furnace or in loft for drying clothes on damp days. □

Toilets

Human Waste

Flush Toilets Type	Water Usage	Approx. cost 1979
standard flush	5-7 gal.	\$80-100
water saver	3½ gal.	\$75-100
water/comp. air*	2 qts.	\$265†

* For gas stations, public restrooms, etc. Shown here as indication of design advances in flush toilets.

† Plus air compressor.

Conventional toilets use a great quantity of clean drinking water for flushing; unless a septic tank is used, water-borne sewage is expensive to treat and often environmentally destructive. However, there are definite advantages: they are easy to use, can be located anywhere in the house, feces are not exposed to insects, and even pathogen-carrying feces are safely disposed of.

Biological Toilets, Composting Privies

Where municipal sewage systems are not available, development has been limited to sites where soil percolation allows for septic tank disposal of domestic wastes. Small communities as well as large cities are now required by federal regulations to "sewer up," or upgrade existing facilities. These factors, plus water shortages, have led to heavy criticism in recent years of water-borne systems.

Several types of waterless toilets have recently come to public attention. One type is the biological toilet; best known is the Clivus-Multrum, a large fiberglass chamber used as toilet and for food scraps disposal. There are ventilating pipes inside, and gradual decomposition in the downward sloping chamber is supposed to eventually produce clean compost. Another type is the composting privy, such as the Farallones Composting Privy: a concrete block structure with two four-foot square chambers. Sawdust is added after each use; when one chamber is full, the other is used. Piles are usually turned with a pitchfork.

The theory of a composting toilet is that human wastes, along with a carbonaceous material such as wood shavings will eventually be converted into a rich compost of 10-20% its original volume when placed in a well-ventilated chamber. These toilets rely on aerobic (with oxygen) decomposition, unlike outhouses. Like compost piles, the process must be a living system, with balanced food, air, moisture and warmth.

Problems with composting toilets and privies:

Epidemics such as hepatitis, cholera, typhoid fever, and dysentery have been caused from viruses of human waste origin. The spread of parasites such as hookworm, whip worm and Ascaris is also possible. Thus, health agencies have been reluctant to approve these units for wide usage. Both the Clivus and the Farallones Privy have had problems. Fruit flies (via food scraps) and manure flies have been known to infest Clivus toilets; once established they are difficult to get rid of. Several tropical parasites (including hookworm) were recently found in a California composting privy after a six months composting period.

Specific problems:

- temperatures must reach 160° for a sustained period to kill parasitic ova; this is often not the case.
- lack of carbonaceous material makes the pile solid, does not allow the necessary ventilation. Or, clogged air intakes or ducts or insufficient up-draft prevents aeration.
- fly infestation, which can cause spread of pathogens.

In a recent research report on compost toilets prepared for Rodale Press, Patti Nesbitt concludes:

Disposal of wastes in a contained tank, even if the wastes do not undergo the decomposition necessary to inactivate all enteric organisms, is still a step forward in terms of water conservation and the reduction of water pollution.

These systems, though, should not be advanced for their potential to create soil conditioner. It is likely that, for a few years to come, most composting toilets will produce contaminated humus. Even if the center of the pile reaches 160°, the fringes may not. It is recommended that the compost . . . be buried twelve inches down for two years to insure its purification . . .

It is possible that compost toilets may never be applicable for every home; they are most suitable (especially the large tank units) in low-density areas with sufficient space for the tank and burying the humus . . . We are concerned about the lack of rigor and the jump-on-the-bandwagon attitude being taken by some in drought-stricken California. The creation of potential health hazards is not a step in the direction of solving the problem of sewage treatment and disposal. It is time to admit openly the present limits of these alternative systems and to begin serious work to make them viable and more generally applicable.

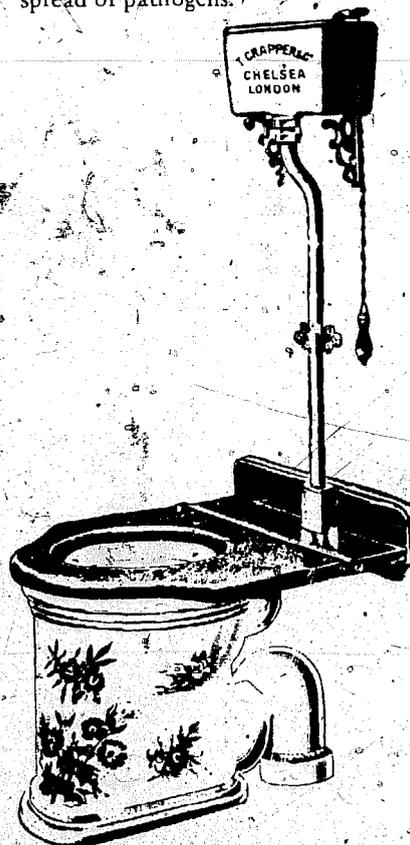

Water and Waste Information:

Building Your Own Compost Toilet and Greywater System, by Zandy Clark and Steve Tibbitts. \$3.00 from Alternative Waste Treatment Association, Star Rt. 3, Bath, Maine, 04530. Best publication on compost toilets.

Residential Water Conservation, Report No. 35, 1976, California Water Resources Center, UC Davis, Davis, Ca. Good review of conservation devices and where to get them.

Small Scale Waste Management Project, by Robert Seigrist, Dept. of Environmental and Civil Engineering, U. of Wisconsin, Madison, Wis. Send \$1 for list of publications. Excellent design papers on mounds, slow sand filters and greywater. □

Alternative Energy

We want to believe in breakthrough solutions. We would rather hear about solar heaters or wind generators than about reducing wasteful consumption; about revolutionary housing design instead of making better use of conventional construction methods. We would like to believe there are *alternative* sources of energy to maintain the present American standard of living.

In the last decade, especially since the oil embargo, we have seen increasing interest in what are popularly called alternative energy devices: solar heaters, wind generators, methane digesters, etc. Almost all the media coverage — newspapers, magazines, books, television — has been optimistically favorable. Do all these devices work as well as we are being told? Can we rely on the accuracy and objectivity of all the books now available on solar heating, or claims made by inventors in articles on their own discoveries? Our guess is no, and that although many of the devices are useful, even inspiring, a lack of critical analysis by reporters and writers, as well as by inventors and promoters, is not giving the public an accurate picture. A few examples:

Solar space heating (as opposed to water heating): many homeowners are being sold high-priced, complex pieces of hardware to replace oil furnaces; or a conventional heating system is installed along with an active solar system for long cloudy spells — saving on fuel bills, but requiring a high investment for two heating systems. In many cases, building a small house, remodeling, landscaping, wearing warmer clothes indoors, insulation, window alterations, storm sash, could save more energy than buying new, expensive hardware.

Wind generators are expensive, high maintenance machines that produce very small amounts of power in proportion to their cost.

Methane digesters require large amounts of manure; sludge handling is a major problem; they often show a net energy loss, and have been known to explode.

We are not qualified to analyze any of these devices. Nor do we wish to imply that none of them are useful. Yet we believe there is a need for more critical evaluation by the press, more objective analysis and disclosure by inventors and promoters, and a more watchful eye on

the part of the public. It could well do more harm than good for people to believe and invest in devices purported to save fossil fuels or conserve electrical energy, only to find later that the devices fail to perform as expected, or that there are hidden costs or high maintenance requirements.

What is a Kilowatt hour?

Every electric appliance is rated in watts; this is usually found on the name plate of the appliance.

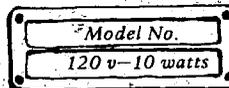

1000 watts = one kilowatt (KW). To find out how many kilowatt hours (KWH) each appliance uses, the formula is:

$$\frac{\text{watts} \times \text{hours used}}{1000} = \text{KWH}$$

For example: 100 watt light bulb in use for 10 hours is:

$$100 \times 10 = 1000 = 1 \text{ KWH}$$

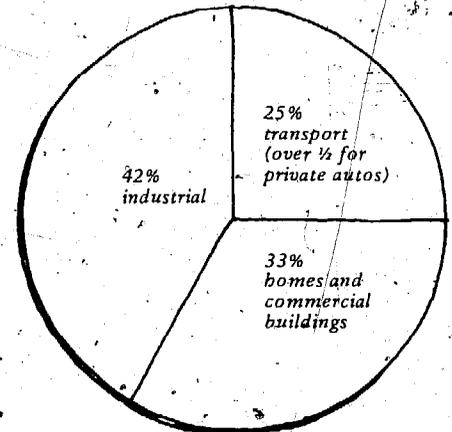

U.S. energy use

Own Your Own Power Company

Vigilante Electric Cooperative, Inc. in Dillon, Montana is an electric company owned by its customers. A non-profit cooperative corporation, Vigilante is typical of many rural electric co-ops in the U.S., with no profits going to pay stockholder dividends or for utility company advertising. For more information: National Rural Electric Cooperative Association, 2000 Florida Ave. N.W., Washington, D.C. □

Working with the Sun
Sun's Angle
Altitude of Noon Sun in degrees (°)

Latitude	winter solstice	spring equinox	summer solstice	autumn equinox
	Dec. 21	March 21	June 21	Sept. 21
25° N (Miami)	41	65	88	65
33° N (Phoenix)	35	57	81	57
42° N (Boston)	25	48	71	48
47° N (Seattle)	19	43	66	43

South-facing windows
Eaves or awnings can be designed to screen summer sun, admit winter sun. In warm southern climates, more overhang is required to prevent mid-day heat build-up in spring and fall.

East and west-facing windows
Hot summer afternoon sun strikes west-facing windows. Protection can be provided by trellises, porches, vertical screens, trees, or hedges. East windows can also be a problem in hot summer areas with early morning heat build-up. Hedges away from the house allow more breezes to enter than porches.

Local Energy

The key to having a sufficient supply of energy is to detach one productive process after another from the corporate power network, and restore them to the identifiable human communities capable of actively utilizing sun power and plant power, man power and mind power . . . Lewis Mumford

Local energy as opposed to alternative energy or world game strategy. *Hométown energy.* Community or neighborhood energy. Production of basic necessities — food, shelter, heat/power/mechanics — as close to home as possible as a means of increasing our efficiency, our freedom, our independence from centralized control.

Self-sufficiency is a direction, not a goal. Obviously no one can be completely self-sufficient. We all rely on the complex interrelationship of people, organization, production, goods and services to live our lives. But this is no reason not to continue working toward *increased self-sufficiency*: providing an ever-greater share of our own needs. In this quest we begin first with ourselves, then our families and/or friends, then neighbors, then others in our community . . .

Improve Upon What Exists:

- insulate.
- add southern glass, eliminate large areas of northern glass.
- heavy drapes in doorways and windows.
- weatherstripping of windows and doors.
- double glazing of storm windows.
- use wind and sun for drying clothes instead of electric dryer.
- dress warmly inside; keep winter temperature as low as possible.
- use natural ventilation instead of air conditioning.
- water-saver shower head cuts water flow from six to three gallons per minute.
- insulate hot water heaters. Feel the side of the tank; if it is warm, insulation will help. Special blanket insulation is made for this purpose.
- hot water pipes can be wrapped with flexible insulation (available at hardware stores).
- turn off pilot light on gas stove; use welder's sparker to start burners.

What Can Be Done to a Suburban Tract House:

- Many of these houses were hastily built for medium cost housing, but the basic cores are often sound — foundation, electrical and plumbing hookups, etc.
- add porches, buffer rooms, trellises for wind control, solar shading, privacy and aesthetics.
 - add sunroom or greenhouse.
 - remove grass, plant vegetables; plant fruit trees; plant grapes on arbors.
 - suburbs are good places to organize cooperative schools and food buying, work projects, community gardens.

Hidden Costs of Country Living:

A remote site in the country often involves considerable hidden costs: a well, graveled roads; electric power; difficulties in getting materials to the site, etc. Further, you usually must be a jack-of-all-trades and maintain a lot of machinery in order to survive. Living in a community, on the other hand, whether it be city neighborhood, suburb, or small town, saves energy by being close to services, jobs, markets, schools, and other people.



Lowered roof and latticed arches shade west-facing deck from direct sunlight, improve house appearance.

Some definitions

- en.er.gy/n* . . . 1: vitality of expression. 2: the capacity of acting. 3: power forcefully exerted. 4: the capacity of doing work.
- self-suf.fi.cient/adj* . . . 1: able to maintain oneself without outside aid; capable of providing for one's own needs . . .
- econ.o.my/n* . . . thrifty use of material resources . . . the efficient and sparing use of the means available for the end proposed . . .
- in.dig.e.nous/adj* . . . produced, growing, or living naturally in a particular region or environment . . .

Indigenous Efficiency

We can learn from the Indians, or from other indigenous people who did (do) not have the vast resources of the industrialized nations (see pp. 4-53). Not that we must migrate with camels, live in wickiups, or till the fields all day. But we can learn much that will be useful in our present lives by observing how efficient people can be when they stay in one place (or migrate along the same routes), when they must work with what is available, when they must heed weather, growing seasons and local traditions. □

Cold Climate

by Ned Cherry

There are a great many factors to be considered when thinking about the provision of shelter in a cold climate. Having spent most of my adult life in the relative comfort of urban apartment houses with each unit usually surrounded, top, bottom and each side by other heated apartments, I was rarely inclined to worry about heat. But two years ago, my family and I moved to an old farmhouse in upstate New York where we have just completed two of the most severe winters in recent memory. Trial by ordeal has a way of forcing one to think in the most basic of terms and living in a previously uninsulated 1840 wooden frame house, relying primarily on wood heat, being exposed on all sides to the elements, has been the cause for considerable thought along with the question: why? Having been formally educated in architecture in an urban setting at a time when too much thought about isolated single family private dwellings was considered socially irresponsible, one didn't really give much thought to the problems faced by people living this way. But the fact is, most Americans, rich and poor alike, live in such dwellings, and it is apparent that in most cases little consideration has been given to responding to year-round weather conditions. Following are some thoughts on design and building a home in an area with sub-zero winters; this is not intended to be the definitive word on the subject but rather some ideas based on experience, fact, hearsay and common sense to stimulate further thinking.

Orientation

If you take into account sun orientation and prevailing wind direction from the outset of a building project, half of the problem has been dealt with. Knowing the orientation of winter sun and utilizing it to maximum advantage, and minimizing exposure to cold winter winds by proper siting of the building should be obvious. Yet it is amazing how many houses are affected by view, relationship to road, insensitive building and zoning codes and the like. Proper orientation with regard to the severest anticipated winter conditions is of primary importance and is a decision that should be made before all others. Of course, in acquiring an existing house, one can usually make alterations or improvements. Reducing or eliminating northern facing



windows, adding more windows to a south wall, planting trees for windscreens are some possibilities. Even building a wall, an outbuilding, or garage can provide a shield from prevailing winter winds.

Insulation

Insulation is currently a subject of controversy among the building trades with someone finding fault in nearly all the available materials. Fiberglass insulation, although relatively effective in performance, can be irritating to work with and may cause harmful side effects if not handled properly. It has an "R" value of a little over 3 per inch; 6" in walls and 10" in ceilings should prove adequate in most dwellings. Blown cellulose (shredded newsprint blown under pressure) is attractive ecologically, but recently there have been some problems with its flammability. It is fireproofed with boric acid which is now in short supply, may have a tendency to disintegrate in time (depending on application) and will eventually settle, thus reducing its efficiency. Its "R" value is something over 4 per inch. A relatively new foam product called ureaformaldehyde is claimed to have an "R" value of 5 per inch, but is said to shrink in time, thus causing leaks; it is also known to emit noxious fumes in a downward direction after a while, thus rendering its use in ceilings or attic spaces questionable. There are also many types of rigid foam insulations available, the most popular being urethane with an R5 per inch rating. It is, however, derived from the petrochemical industry and produces poisonous gases when exposed to fire. Bearing in mind the shortcomings in each, I tend to prefer fiberglass insulation provided that a good face mask and gloves are worn during installation.

Many builders in the east are begin-

ning to frame wood houses with 2"x 6" studs at 24" on center instead of 2x4's at 16" on center in order to provide the extra space for wall insulation. This is probably a good idea but makes one wonder why frame all walls to the same thickness when it might make more sense to use 2x8's or even 2x10's on northern facing walls and 2x4's on south facing walls where insulation is not as critical. This idea goes back to the question raised a few years ago about the rationale of glass skyscrapers with all four walls of the same construction. At any rate, I believe that the whole field of building insulation is in about the same area of conjecture as that of selecting the right type of solar heating system or collector panel. It may be too soon to effectively evaluate the adequacy of any method. In the meantime, piling up snow or hay bales around the base of a house is an age old remedy for reducing cold and draft penetration.

Windows

Having experienced these past two winters, I would be inclined to discourage anyone from installing windows in a north facing wall and encourage the use of as many southerly facing windows as economically and aesthetically feasible. There's nothing nicer than a bit of winter sun coming into a room, and a south facing window will allow this to happen about 6-8 hours per day even in December. "Thermal pane" windows or windows with two pieces of glass separated by a vacuum or an airspace for insulating value are very effective but expensive, if factory made. Storm windows are a must and I have found that even adding an additional sheet of glass over a fixed window when an odd sized storm window was not available was a big help in keeping out the cold drafts. Obviously, heavy curtains or drapes, along with

Thermal Mass

by Michael Gaspers

shutters, can be effective in keeping in the heat at night as well as cutting down on drafts. And there is nothing like well caulked windows and storm windows to help reduce drafts and heat leakage. With respect to fabricating your own double or even triple glazing, I have not seen too much problem with condensation, at least not so much that it won't usually dry out in the next day's sun.

Roofs

The proper pitch for a roof in a cold snowy climate is 5 in 12, that is 5" vertical for every 12" horizontal. This pitch will allow proper drainage of rain and snow in most cases. Some people prefer the placement of a 24" strip of metal at the edge of a pitched roof so snow will slide off and ice will not accumulate at the edge, causing an "ice dam" and forcing moisture back up underneath the shingles. Others prefer a roof with less pitch, thus allowing snow to remain on the roof throughout the winter and acting as an insulator. This is fine until a midwinter or spring thaw comes, increasing the possibilities of a leaking roof. The old New England "salt box" design with a long sloping roof and short wall facing north to minimize the effects of severe north winds, and a high south facing wall with minimal roof for maximum sun exposure was a sensible cold climate design.

The short north wall could be used for closets to insulate from the north cold. The north-facing sloped roof usually retained the snow for insulation, and the higher south-facing wall could have maximum fenestration to allow the winter sun to naturally warm the house.

Foundations

The important thing in foundation and footing design in cold climates is to be sure your footing is below the frost line, that is, the depth at which the ground ceases to freeze. This point varies from area to area but in most northeastern states it is around four feet. Setting the footing just below this level will insure that your foundation will not move when the ground above freezes, thaws and consequently heaves, thus knocking your foundation all out of alignment. There are various ways to insulate and protect a foundation wall. Most foundation walls these days are built with concrete or cinder blocks and can either be lined on the inside with rigid cellular glass insulation or the cores of the blocks can be filled with either a pre-

molded filler or loose insulating material like "zonalite." Any crawl spaces in the house should be insulated between the joists or beams and some sort of vapor barrier should be put over the ground in the crawl space to help keep moisture out of the wood structure above, as well as reducing cold.

Heating

The correct choice of heating systems these days is really up in the air. Anyone currently building a house should be skeptical about getting tied into or over reliant on oil, natural gas or LP gas. On the other hand, I wouldn't recommend too much reliance on solar heating yet either, except perhaps for domestic hot water use. There are various ideas being developed using passive solar heating techniques such as heat walls, heat windows, sophisticated petrochemical type products, etc. Combination wood-oil furnaces seem fairly good, though expensive, thus allowing some flexibility. I would recommend circulating hot water over forced hot air in any case for a more comfortable, evenly distributed heat supply. Combination wood-coal burners might be the best bet at this point. Heating solely with wood is a nice idea if you've got the wood lot and a dependable chain saw. That's quite an investment. There are still areas in the east where you can buy a face cord of wood (4' x 8' x 12, 14 or 16") for under \$20, in which case it still pays to buy it. There are many good wood stoves available now with excellent combustion design. Just make sure it's made with either cast iron or heavy gauge steel. If you're thinking of building a fireplace, make sure you design it to bring in outside air so you're not using heating room air for combustion. Heaters, circulating water loops through your fire box, etc. are all good concepts if installed and designed correctly. If a house is really designed properly in terms of orientation, is insulated adequately and built well with minimal air leaks, is sensibly fenestrated with more regard to the sun and less to views and aesthetics, heating this dwelling should almost be of secondary importance. This may sound somewhat idealistic, but it's really true. Too little thought has gone into these problems in the past and heating costs have rarely been the major consideration in this country that they are now. All of this seems in retrospect to be just common sense and this is what it takes. □

Thermal mass refers to the potential heat storage capacity of bulk materials. Dense or heavy materials usually store more heat than light ones. The following table shows some common building materials, densities, and heat storage capacities.

Material	Density lbs./cu. ft.	Specific Heat*	Storage Capacity**
Water	62	1.00	62.5
Iron	490	0.12	59
Concrete	140	0.23	32
Stone	170	0.21	36
Adobe	100	0.22	22
Sheetrock	50	0.27	13
Wood	30-40	0.30	9-12

* Btu/lb./°F

** Btu/cu. ft./°F

Note: Btu = heat required to raise one pound of water one degree Fahrenheit.

Water stores more heat by weight or volume than any common material. Concrete and stone are next best, followed by adobe, sheetrock and wood, which stores the least heat.

All of these materials are poor insulators (resistance to heat flow) except wood, which is a moderately good insulator.

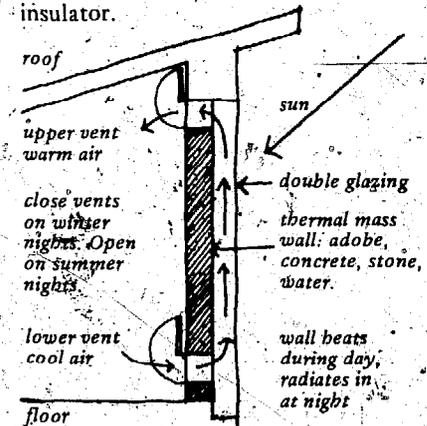

Trombe Wall — cross section from Homegrown Sundwellings

A thermal mass has the effect of absorbing heat as the house warms up, releasing heat as the house cools, thereby smoothing out or regulating room temperatures. Also, these masses soak up and store excess heat, which would normally be vented out of a house and wasted.

Thermal mass can be effectively utilized in home design by building a well-insulated shell with thermal mass (concrete slabs, stone fireplaces, stone floors, water containers, etc.) inside the insulated shell. A house thus built requires less heat input, and will maintain more

continued

Building Costs

Thermal Mass *continued*

constant temperatures through the day/night cycle. Some good traditional examples of houses with large thermal mass are the adobe buildings of the Southwest, and the sod houses of the Prairie.

One simple way to utilize thermal mass is to construct an insulated masonry floor (concrete, stone, brick). For best heat absorption, the floor should be a dark color and exposed to direct winter sun through an adequate amount of south-facing glass. Night heat loss through the glass is prevented by double glazing, tight shutters, or an insulating cover.

Another approach is to make the south wall a large thermal mass, such as concrete or stone, covered with glass (the Trombe wall), or stored water (55 gallon drums or water-filled culvert pipes). Again, these walls must be double glazed or provided with moveable covers.

Thermal mass has also been placed in roofs with insulating covers which allows for both heating and cooling of the rooms beneath, depending on whether the covers are removed during the day or at night.

These designs utilize integral parts of the house to achieve solar heating without the use of expensive, complex, mechanical and electrical equipment.

Caution: Building walls of concrete, stone, adobe, or any massive material can be dangerous in earthquake zones. Be sure such structures are designed accordingly.

So-called "active" solar heating systems also use thermal mass as the heat storage medium. The heat storage material (rocks and water tanks are most common) is placed in the basement or under the floor. Heat is transferred to the storage material from a separate solar collector by circulating air or water. If the collector is above the storage, as on the roof, pumps or fans with associated controls are required. If below the storage, as on a south-facing slope, heated air or water in the collector will thermosiphon up into the storage medium. Active systems are usually more complex and expensive than passive types, but have the advantage of storing heat longer and being able to release heat only when needed.

A good source of information on thermal mass and sun-tempered houses is *Homegrown Sundwellings*, by Peter Van Dresser (see bibliography). □

Borrowing vs. Pay-As-You-Build

Borrowing money from a lending institution to either purchase a home or finance construction involves a total expenditure many people are not aware of. For example, a \$50,000 home, with a \$10,000 down payment and a 25 year loan on the balance at 9% interest, means monthly payments of \$335.00. Over the 25 years, the borrower will pay back \$100,500 on the \$40,000 loan. (By the time you add taxes, maintenance and insurance, the monthly figure will be closer to \$600, or \$180,000 over the 25 year period.)

Since the cost of a building is generally equally divided between labor and materials, the costs for this \$50,000 house are, roughly:

- materials: \$25,000
- labor: \$25,000
- bank interest: \$60,000

One might well ask what the lending institution has done to deserve more money than the cost of both labor and materials. Surely the processing of a loan does not involve nearly as much labor as the carpenters, plumbers, electricians and other workers contribute. Nor does the handling of a loan seem to consist of such real value as the manufacture and delivery of the tons of concrete, wood, roofing, appliances, plumbing and wiring fixtures that make up the house. One might ask further if such a disproportionate share claimed by banks might not be one of the primary causes of the escalating housing problems in America today.

One obvious way to escape such a long-term financial obligation is to pay for a home as it is built. If loans are necessary, they will cost less if they are in small amounts, for short time periods.

To pay for a house as it is built, it is necessary to carefully estimate costs of each phase of construction in advance. Since money will most likely be available in increments, it is well to plan where to stop building when the money will run out. Two phases of construction seem ideal: completion of the foundation work and concrete pour, and the framing and roofing of the structure. At each of these points, work could stop until more money becomes available. An example of a bad place to halt construction would be with the floor on, no roof, and winter rains coming.

Paying for a home as you go will involve sacrifices in the early years; often working at a full-time job with all spare

time devoted to building. Later, it may mean camping in an unfinished shell, sawdust and sheet rock tracks in your living space, and months, even years of finishing up bit by bit. Yet in the long run, the freedom from an enormous obligation to a bank may be well worth the hardship and inconvenience.

Acting as Your Own Contractor

A contractor performs many valuable functions during construction of a house: attending to necessary permits, negotiating with subcontractors, and assuming responsibility for performance and completion of the job. Many people may find it worthwhile to engage an honest contractor to either assist or supervise their home-building project.

But if you do not have the money, and/or want to be as closely involved with all phases of the job and perform as much of the work yourself as possible, you may want to act as your own contractor.

A contractor solicits bids from subcontractors for various phases of the job. You may want to do this for certain difficult jobs, such as foundation work, plumbing, or electrical installation. Always get at least three bids. Try to check on the quality of work and dependability of the subcontractors.

Prevailing Union Wages in U.S. in 1978 (Cost to Employer)

Carpenter	\$16.24 per hour
Electrician	16.32
Laborer	12.29
Painter	14.79
Plumber	17.23
Tile Setter	15.77

Used Materials

Used materials and free materials such as stone or adobe save money, but take time. Used wood requires more time than new lumber; if it does not have to be de-nailed, it generally must be cleaned (especially if used inside), and it will take more time to utilize the varying sizes than new lumber, which can be purchased any length.

The amount of free or used materials to be utilized is generally a matter of finding the right balance among time available, money to be spent, and how quickly your home must be built. □

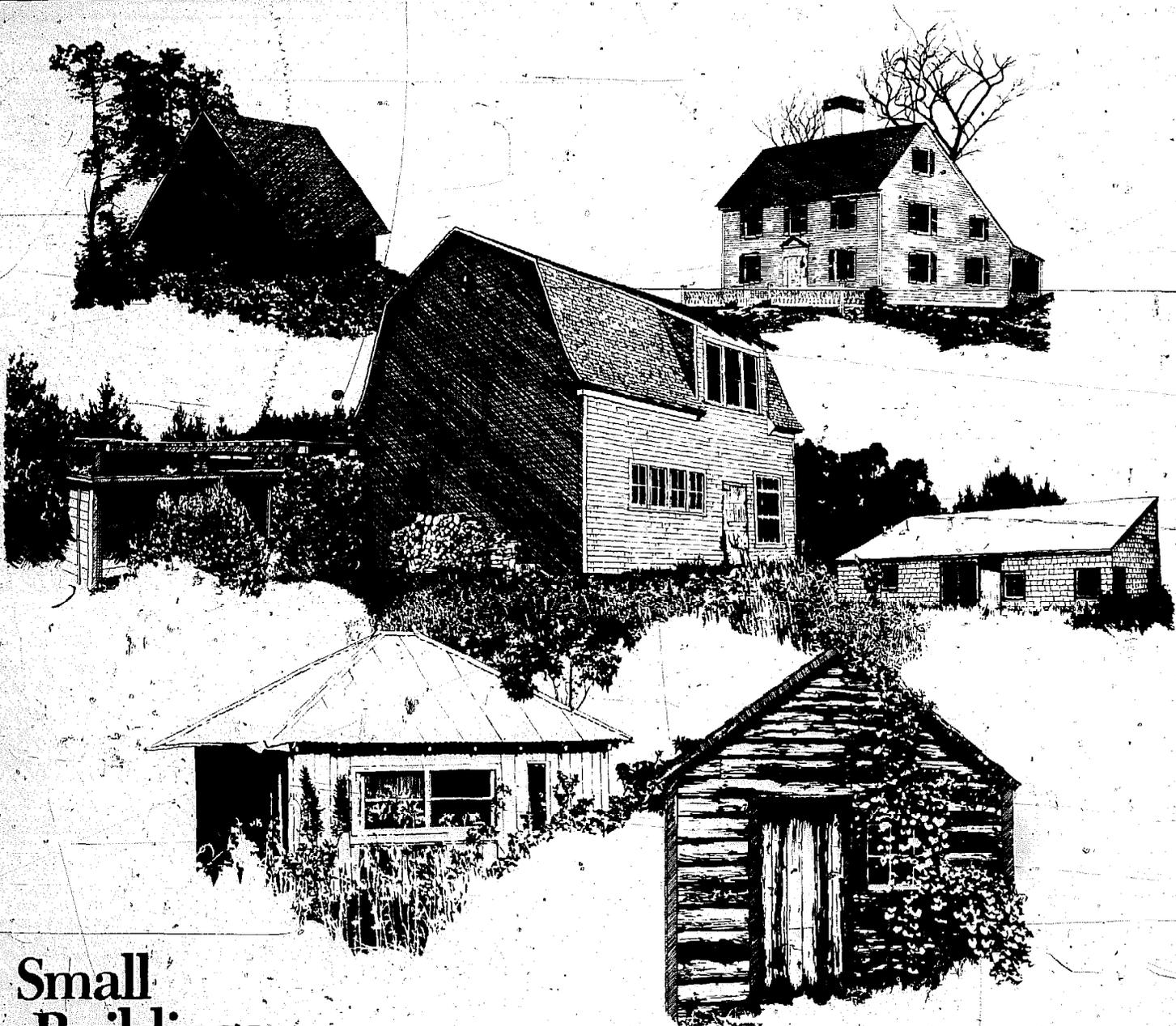

Small Buildings

Each part of the country has special characteristics that favor particular roof shapes. Snow, rain, heat, cold, available materials, practical usefulness, and local experience all contribute to determining the final shape of a building. There are flat roofs in New Mexico, steep gables in Washington, "saltbox" shapes in New England, gambrel roofs in Nova Scotia and hip roofs in Mississippi.

A flat roof is usually found where there is little snow and low rainfall, often on adobe buildings. A *shed* shape is a flat roof tilted up, still one plane; it sheds water better than a flat roof. The *low gable* is the most common shape in America today, the most practical shape for areas with medium rainfall and light snowfall. A *high gable* sheds rain and snow better and affords more loft and storage space. A *gambrel* ("Dutch barn") shape provides more headroom and stor-

age space than a gable. The "saltbox" is usually found on America's east coast: a steep gable with a shed extension on one side. The *hip* roof is often built in areas of high rainfall; the four sloping sides of the roof protect all walls from falling rain.

Choosing a roof shape involves many factors, some covered in the preceding pages on design considerations: study of climate and site, practical use of the building, analysis of other buildings in the area, energy considerations, etc.

On the following 14 pages are framing drawings (by Bob Easton) and photos of seven basic roof shapes: the most common shapes used throughout the world for rectangular buildings. A small floor plan is shown with each shape; the floor plan is keyed to the roof framing, showing how floor plan and framing (as well as foundation) are interrelated.

The drawings are intended as visual guides, not as plans to build from. Local conditions such as wind force, snow loads, earthquake potential, dampness, etc. should be carefully considered before choosing a roof shape, and will be instrumental in adapting these shapes to your particular site and needs. We suggest consulting the local building inspector as to the structural requirements of your area. Even if a permit is not required, the codes will most likely be adapted to local conditions and will tell you things these drawings do not. And in most cases, the building inspector will be willing to offer advice. It would also be wise to talk to a local builder.

The roof shapes shown are not only for stud frame walls. They can be adapted to other types of wall construction, such as adobe, stone, or masonry.

Flat Roof

Buildings with flat roofs are generally found in areas with light rainfall and moderate snowfall, such as the desert. Adobe buildings are typically built with flat roofs, and the shape is often used where people spend much of their time outside, in patios, gardens or courts. A flat roof is probably the easiest shape to add on to.

A flat roof can be the first stage in construction of a two-story house, with the following conditions:

- foundations for a two-story building must be poured.
- roof rafters should be floor joist-size.
- roof must be constructed level, with no slope for water run-off.

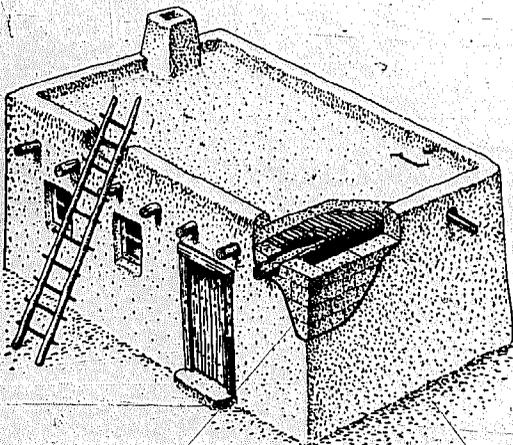

Adobe house

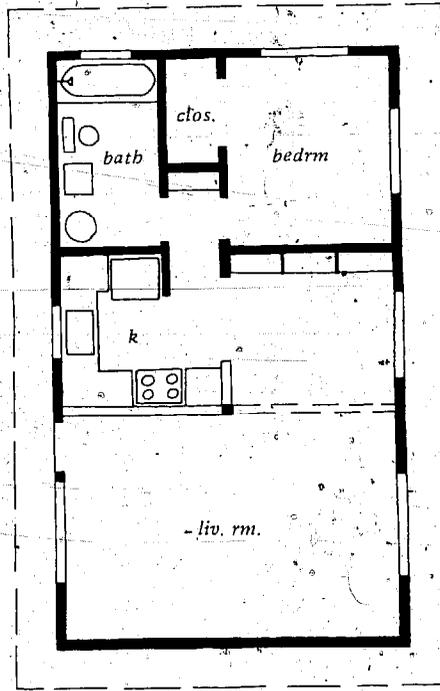

Floor plan

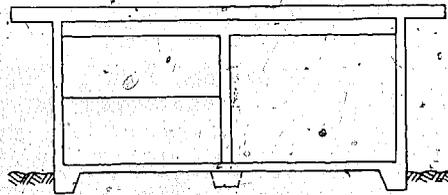

Cross section

For water run-off, pitch roof minimum 1" per 10'. (Can be done by adding 1 or 2 2x4's to one plate.) If not pitched, roof will sag, water will puddle in middle.

Consult local codes for lumber species, grade, and allowable spans.

Add footings under wall betw. liv. rm. and bedroom and under post.

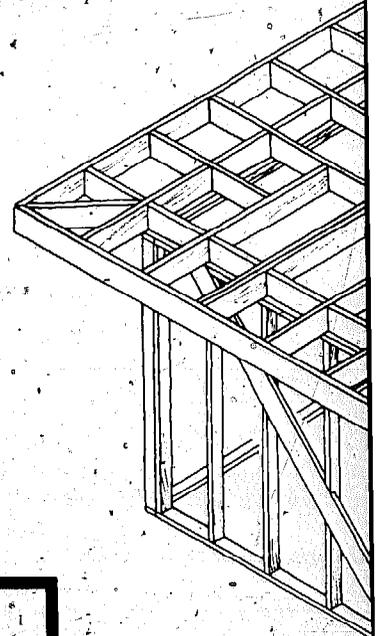

Floor plan and cross section at 3/32" = 1'-0" scale. This scale is on triangular rulers available at drafting supply stores.

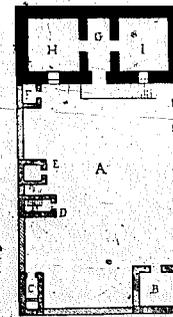

plan

- A—small garden
- B—pantry
- C—privy
- D—dovecotes
- E—chicken house
- F—oven

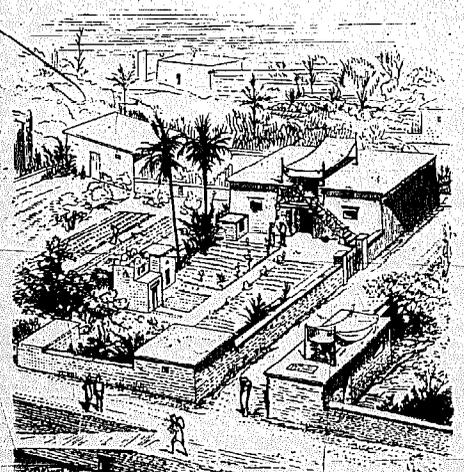
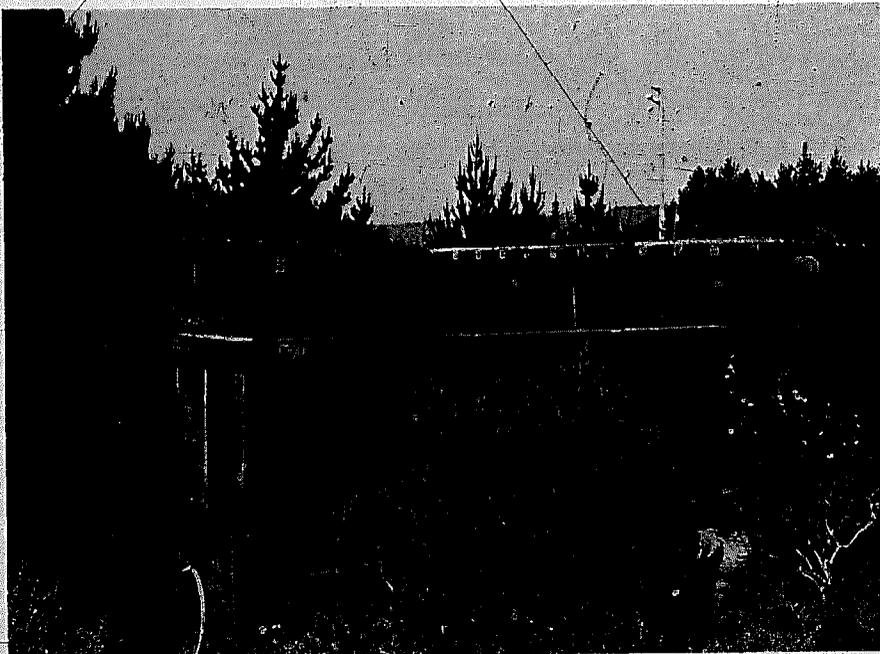

Egyptian rural dwelling

Studs and rafters
at 24" on center,
rafters must align
directly over studs

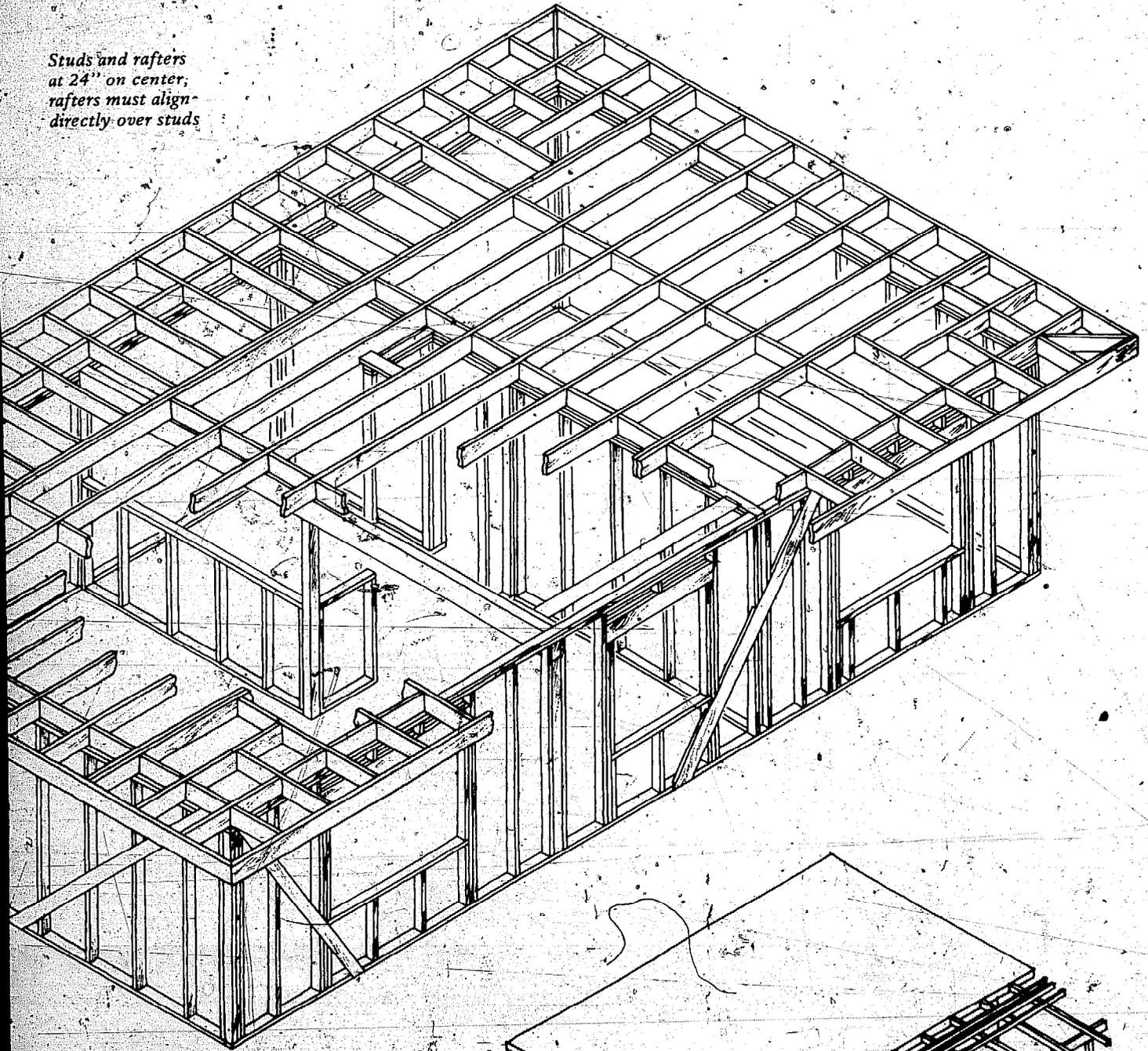

Framing
scale 3/16" = 1'0"

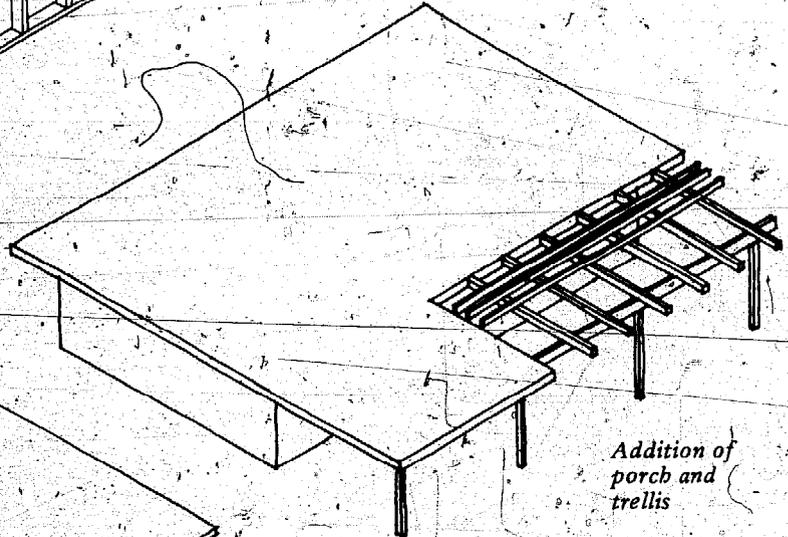

Addition of
porch and
trellis

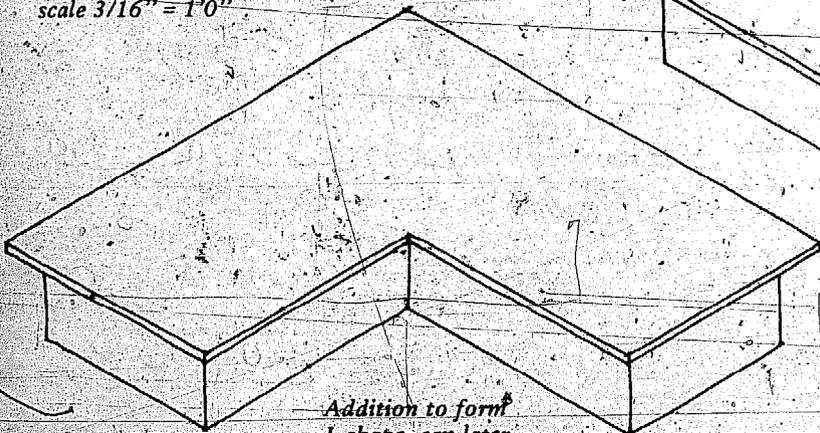

Addition to form
L-shape; can later
add third wing to
make courtyard.

Additional notes

- heavy framing is required for snow loads; snow will slide off steeper roofs.
- hot-mopped tar and gravel is the best roofing for a flat roof. Roll roofing should not be used.

Shed Roof

A shed roof is a simple shape to build, sheds water and snow better than a flat roof, and is a good shape for later additions or extensions. It is also a good shape for adding to an existing building. Clerestory (high) windows are often installed on the high side of a shed roof building, allowing high light to enter without the waterproofing problems of skylights.

Shown here is a small shed building with a six foot wide loft. The smaller drawings show additions to the shed shape. When building overhang on shed, nail securely with 4-16d the rafters to top plate.

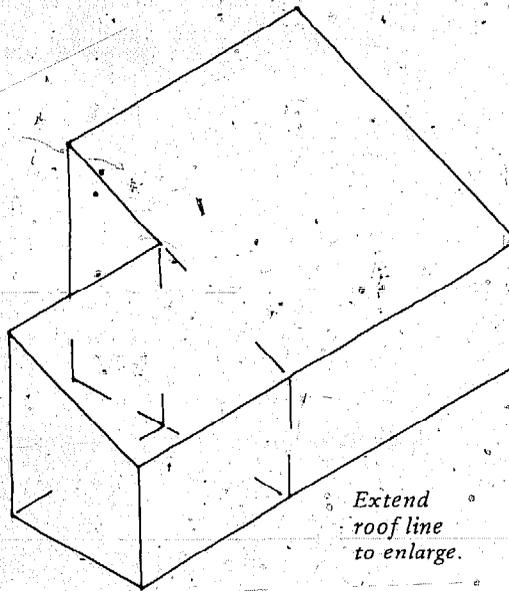

Extend roof line to enlarge.

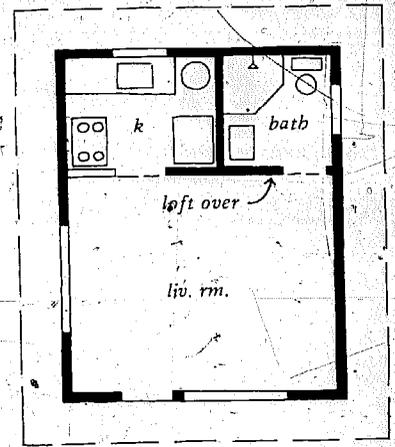

Floor plan
Scale: 3/32" = 1'-0"

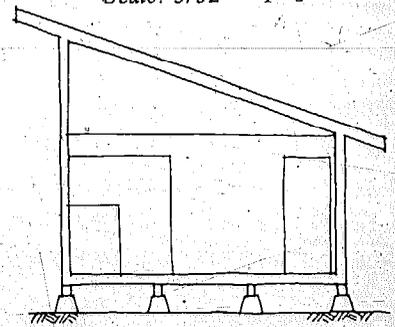

Cross section

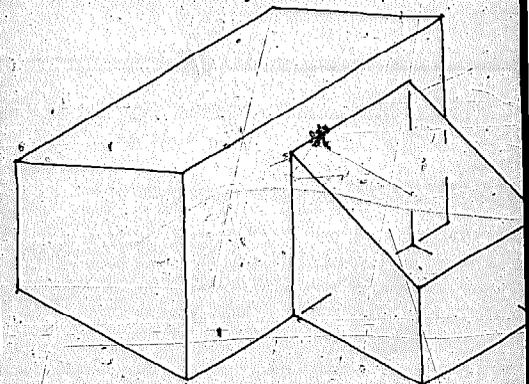
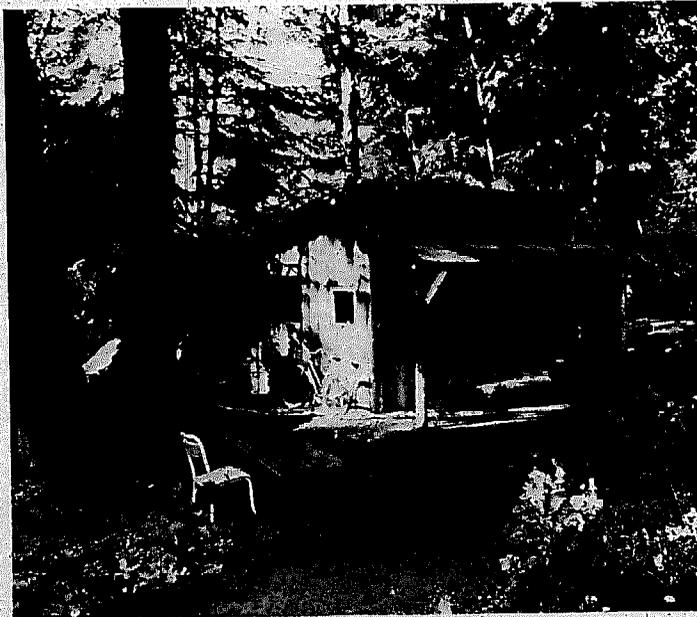

Add smaller shed to high side.

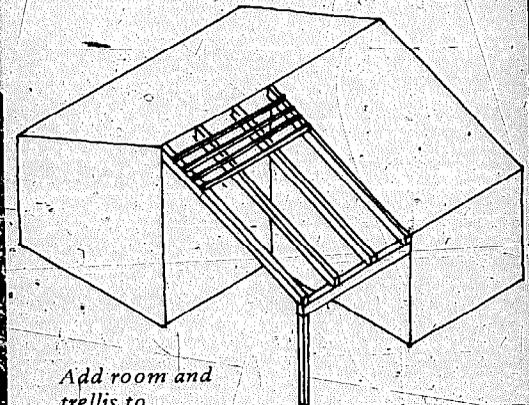

Add room and trellis to main room.

Frame walls full height for maximum strength. Add bevelled nailing plate to top plate on high wall.

Minimum 4:12 roof pitch for installation of asphalt shingles.

Outriggers to support rake fascia board.
fireblock

Walls framed higher than 8'-0" must be fireblocked horizontally at 8'-0" high.

Seat rafters with birdsmouth on low wall plate.

Studs and rafters at 24" on center. Rafters must align directly over studs.

Framing scale 3/16" = 1'0"

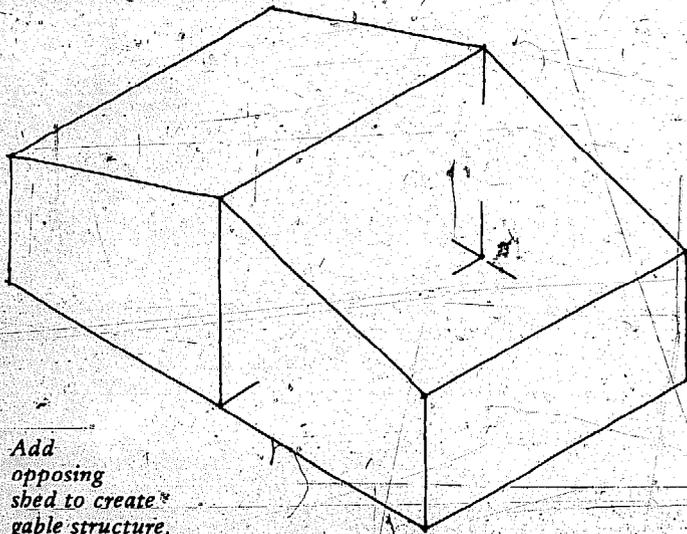

Add opposing shed to create gable structure.

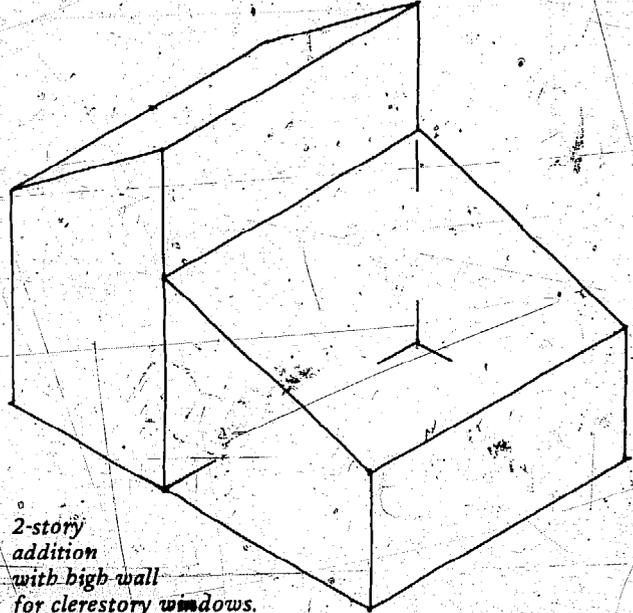

2-story addition with high-wall windows for clerestory windows.

Low Gable

The low gable is probably the most common roof in America. It has the advantage of using shorter, thus smaller sized, roof rafters than either a flat or shed roof. If secured properly with ceiling joists or cross ties, it has the structural stability of a triangle.

It can have flat ceilings or open, or a combination: flat over partitioned rooms (bathroom, bedroom, etc.), open over living room.

Use trusses for longer spans than shown here. Building codes require engineering for spans over 24 feet.

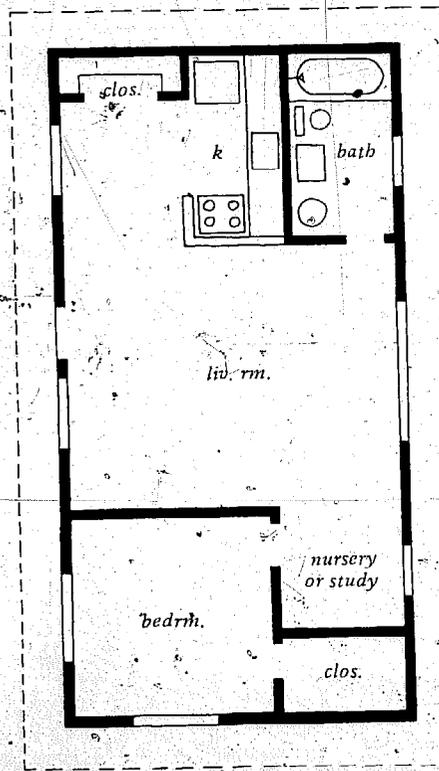

Pour footing under wall between bath and kitchen; will function as bearing wall.

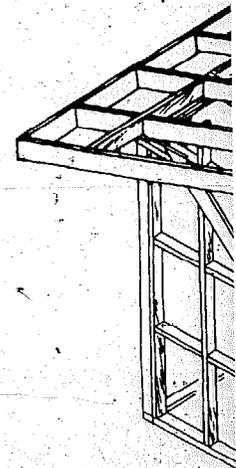

Floor plan scale: 3/32" = 1'-0"

Install 2 rows horiz. blocking if vertical siding is used.

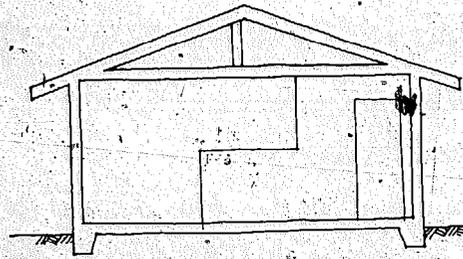

Cross section

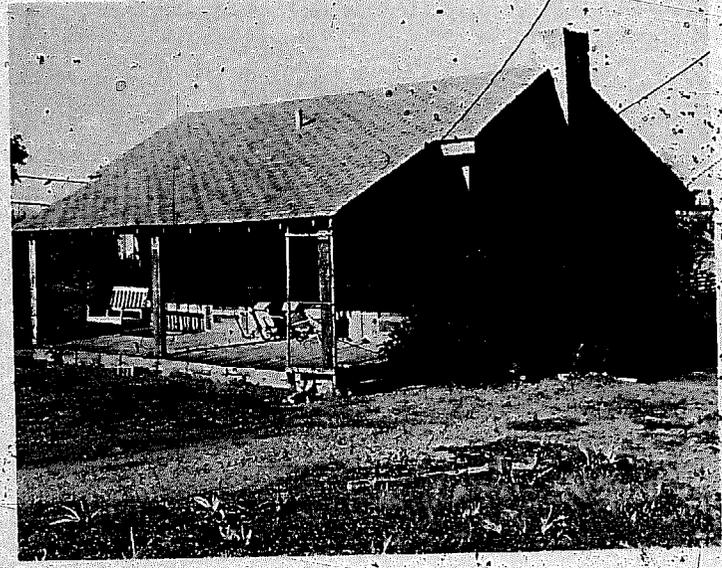
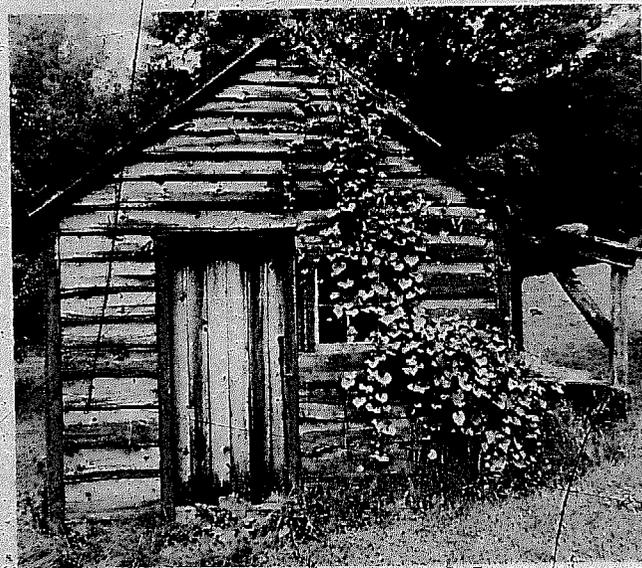

Minimum 4:12 roof pitch
for asphalt shingles.

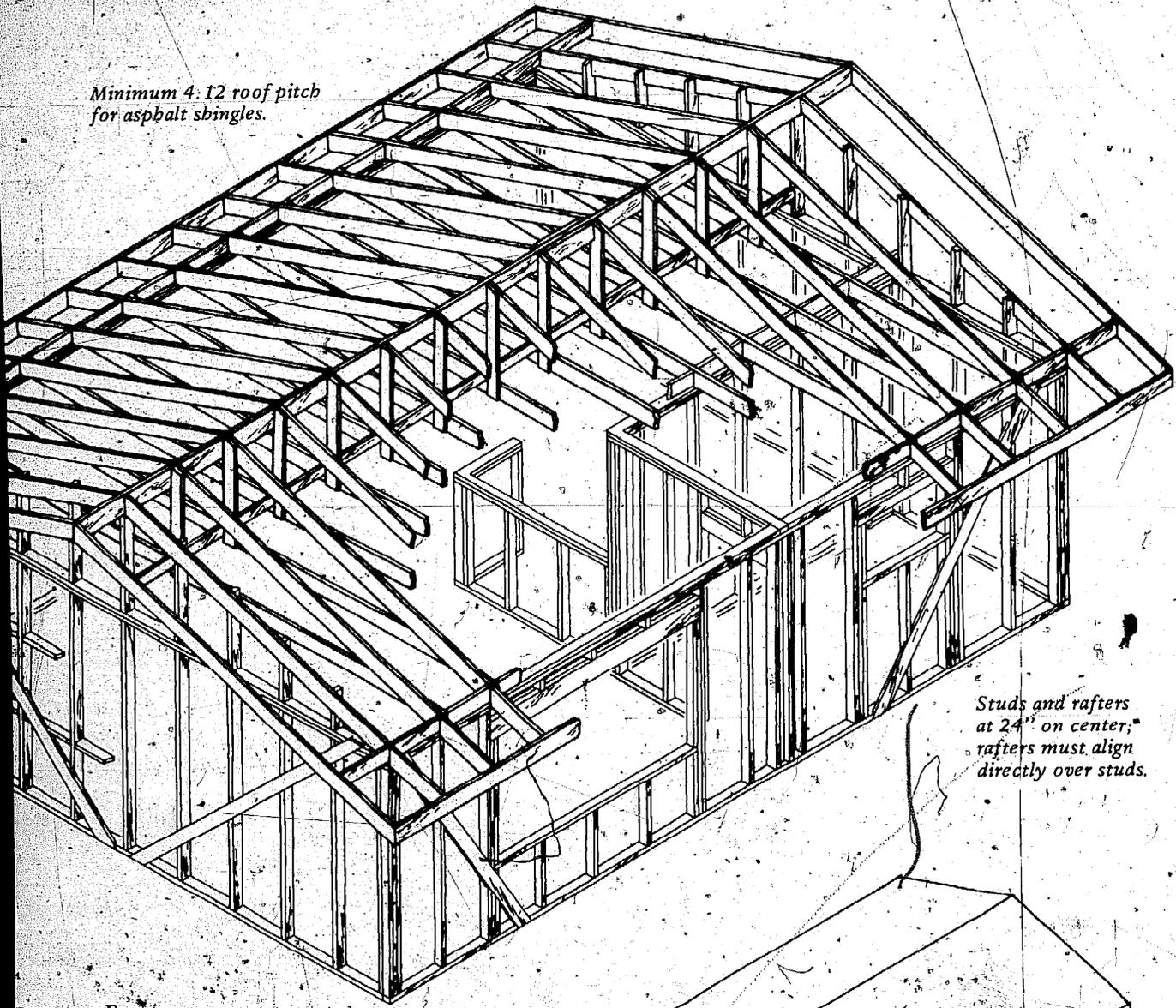

Studs and rafters
at 24" on center;
rafters must align
directly over studs.

Framing
scale 3/16" = 1'0"
(Drawing does not include
bedroom shown on floor plan.)

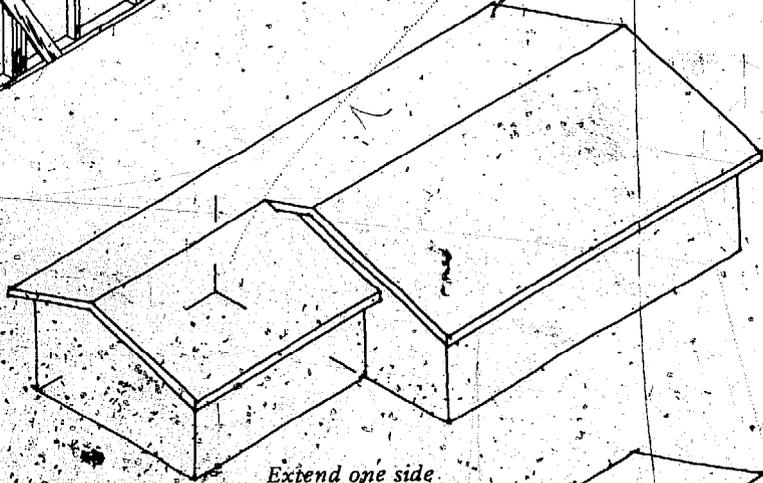

Extend one side
of gable roof
for small room.

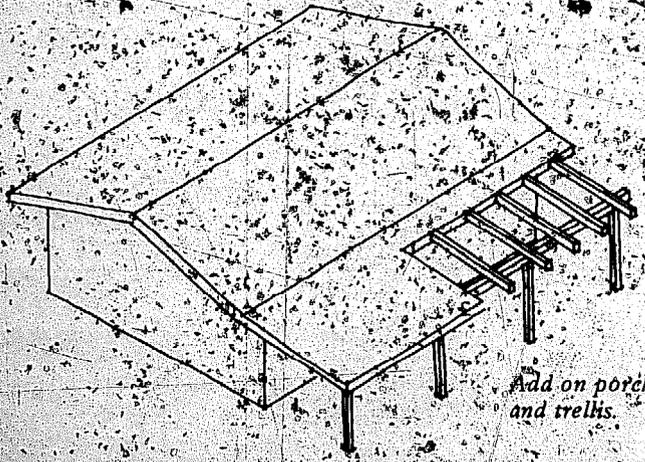

Add on porch
and trellis.

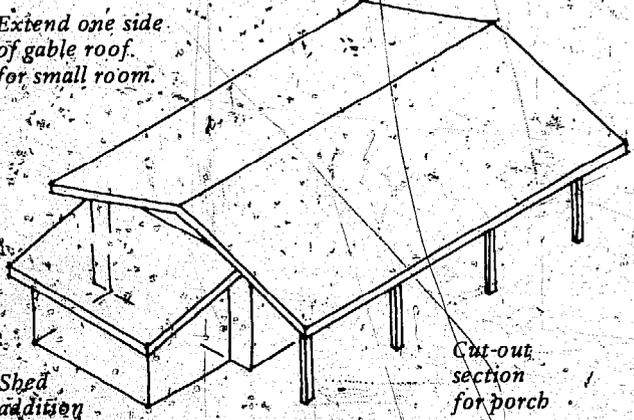

Cut-out
section
for porch

High Gable

A steep gable roof is often used in areas with moderate to heavy rainfall or heavy snowfall. The steepness helps to shed water and snow and allows enough space for storage or a loft above the plate level.

Although the framing drawing here shows an open ceiling and loft (framed with ridge beam), the more traditional high gable is framed with a ridge board and joists at plate level (see p. 93):

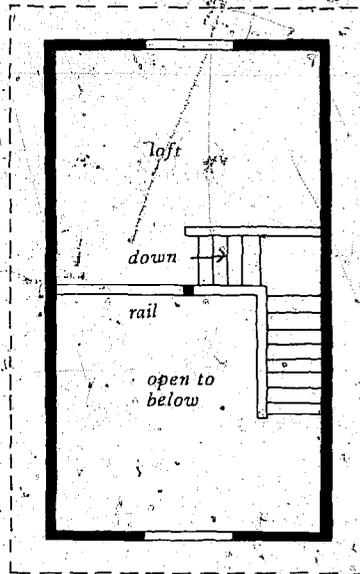

Loft plan

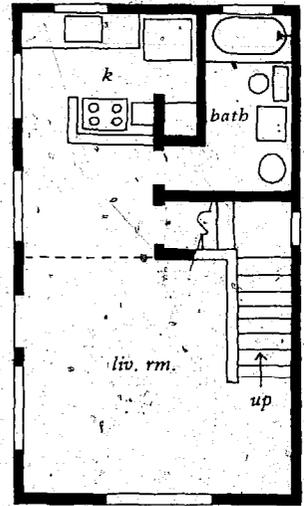

Main floor plan
scale: $3/32'' = 1'-0''$

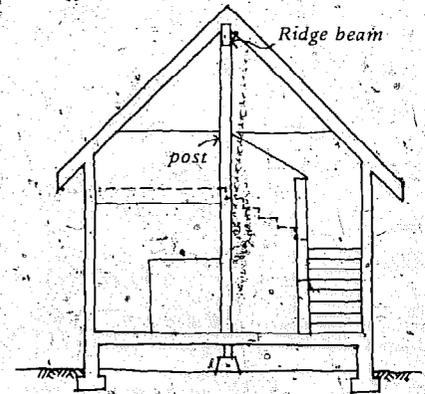
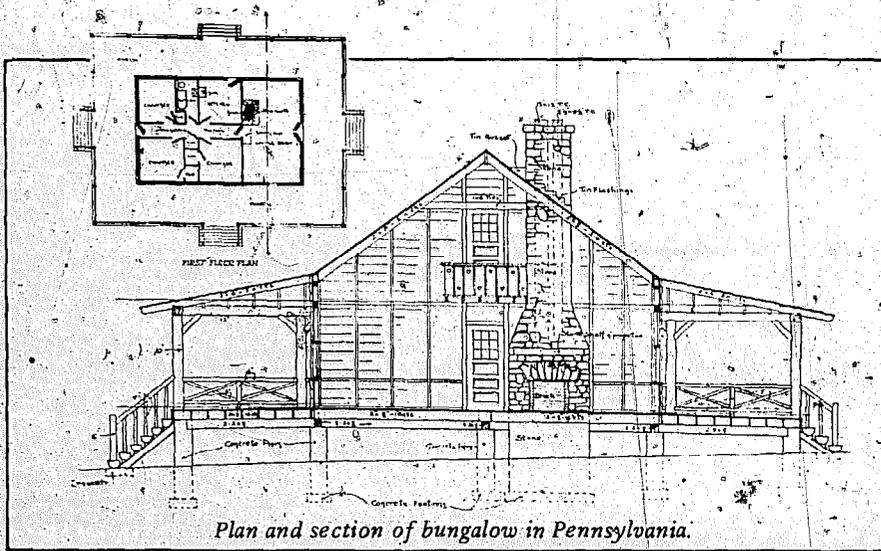

Cross section

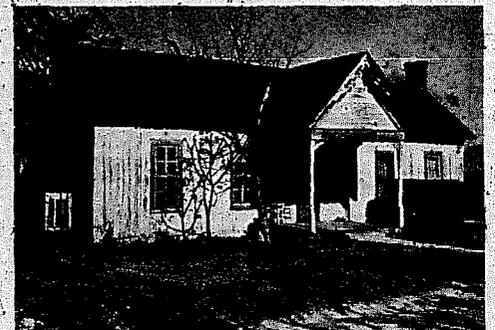

Two basic ways to frame a gable roof

1. With ridge beam as shown here, which allows for open ceiling, or that ceiling joists may be dropped below plate level (both shown here). Ridge beam should be sized, by engineer or checked by bldg. inspector. With ridge beam system, end walls must be rigidly braced - plywood is best. Carpentry must be accurate, joints tight, nailing adequate.

2. With ridge board (see p. 122) and ceiling joists at plate level. See low gable roof, p. 93. With loft floor, ceiling joists must be sized as floor joists.

Frame plate level all round - locate fireplace at end wall or near center to avoid tall unsupported chimney.

12:12 roof pitch.

Studs 16" on center,
rafters 24" on center,
cross ties 4'-0" o.c.

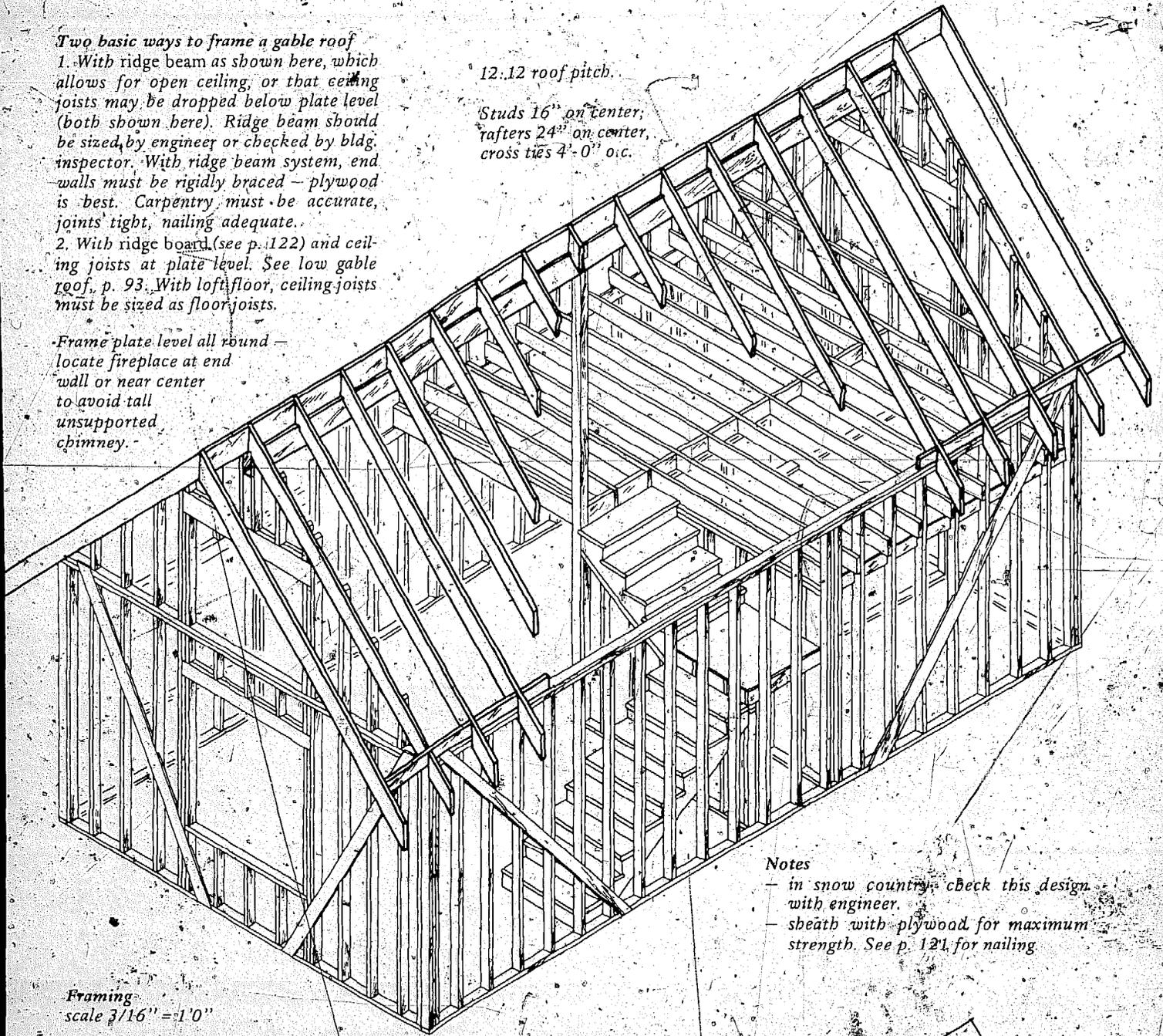

Notes

- in snow country, check this design with engineer.
- sheath with plywood for maximum strength. See p. 121 for nailing

Framing scale 3/16" = 1'0"

Dormers provide space and light for upstairs bedrooms.

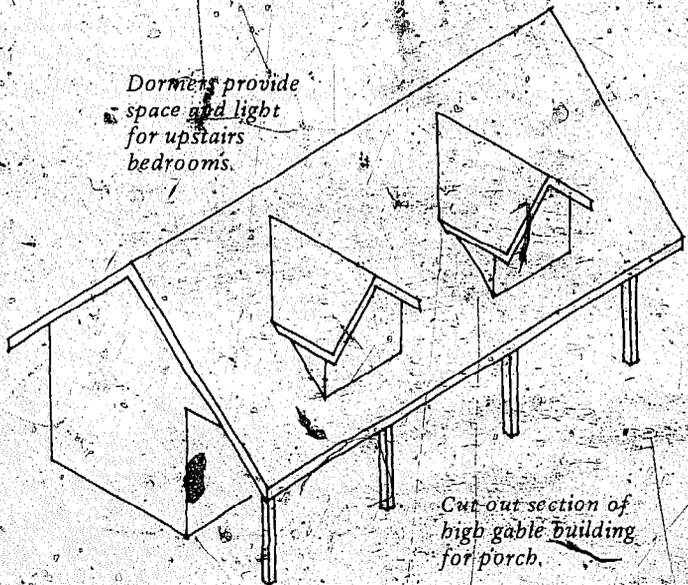

Cut-out section of high gable building for porch.



Saltbox

The saltbox shape is generally associated with the New England states and severe winters. They are often oriented with the high side to the south, the low side to the north. This allows winter sun to hit the high side, and snow (a good insulator) to accumulate on the lower, shallower roof to the north. Snow or bales of hay are often banked against the north side in winter for insulation.

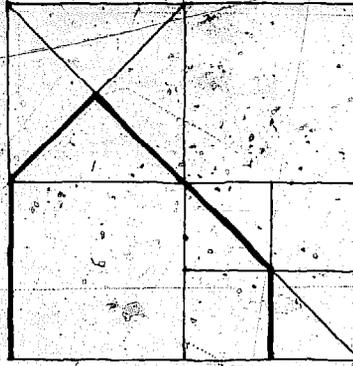

Classic New England saltbox profile, ca. 1690. After drawing by Eric Spang.

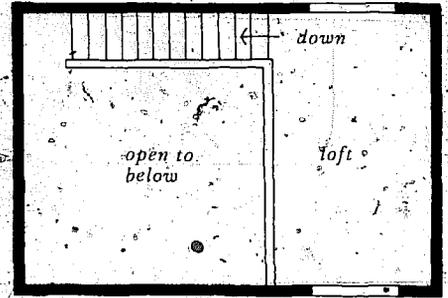

Loft floor plan

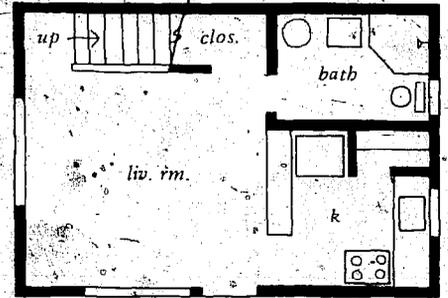

Main floor plan
Scale: 3/32 = 1'-0"



Saltbox farmhouse published in *The Craftsman*, January, 1909.

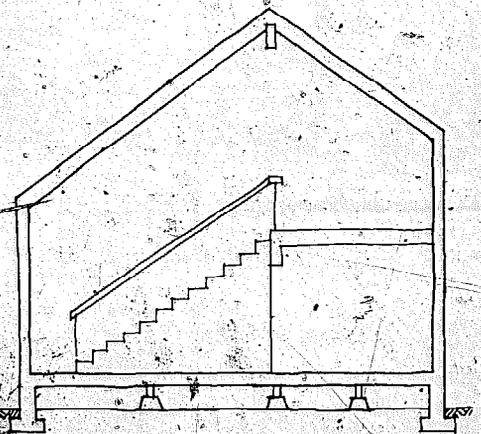
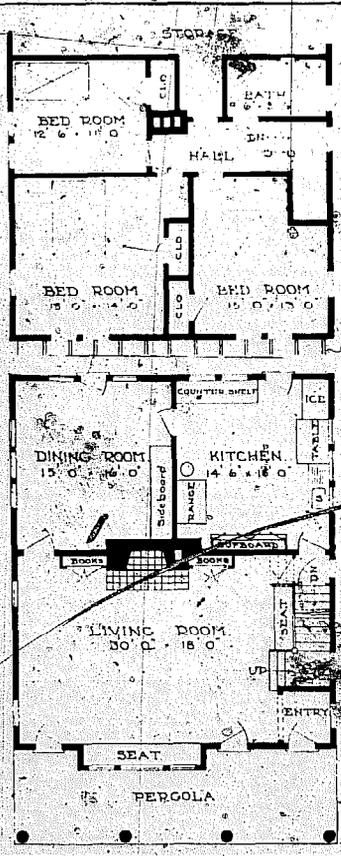

Cross section



9:12 roof pitch.

Studs at 16" on center,
rafters at 24" on center.

Frame living room side
walls full height and
put up (see pp. 120-121);
frame walls at loft in two stages.
Install flooring on loft before
framing upper walls.

Alternate framing method
run rafters same direction
as loft floor joists;
double rafters
at ridge.

Sheath with
plywood for
maximum
strength.

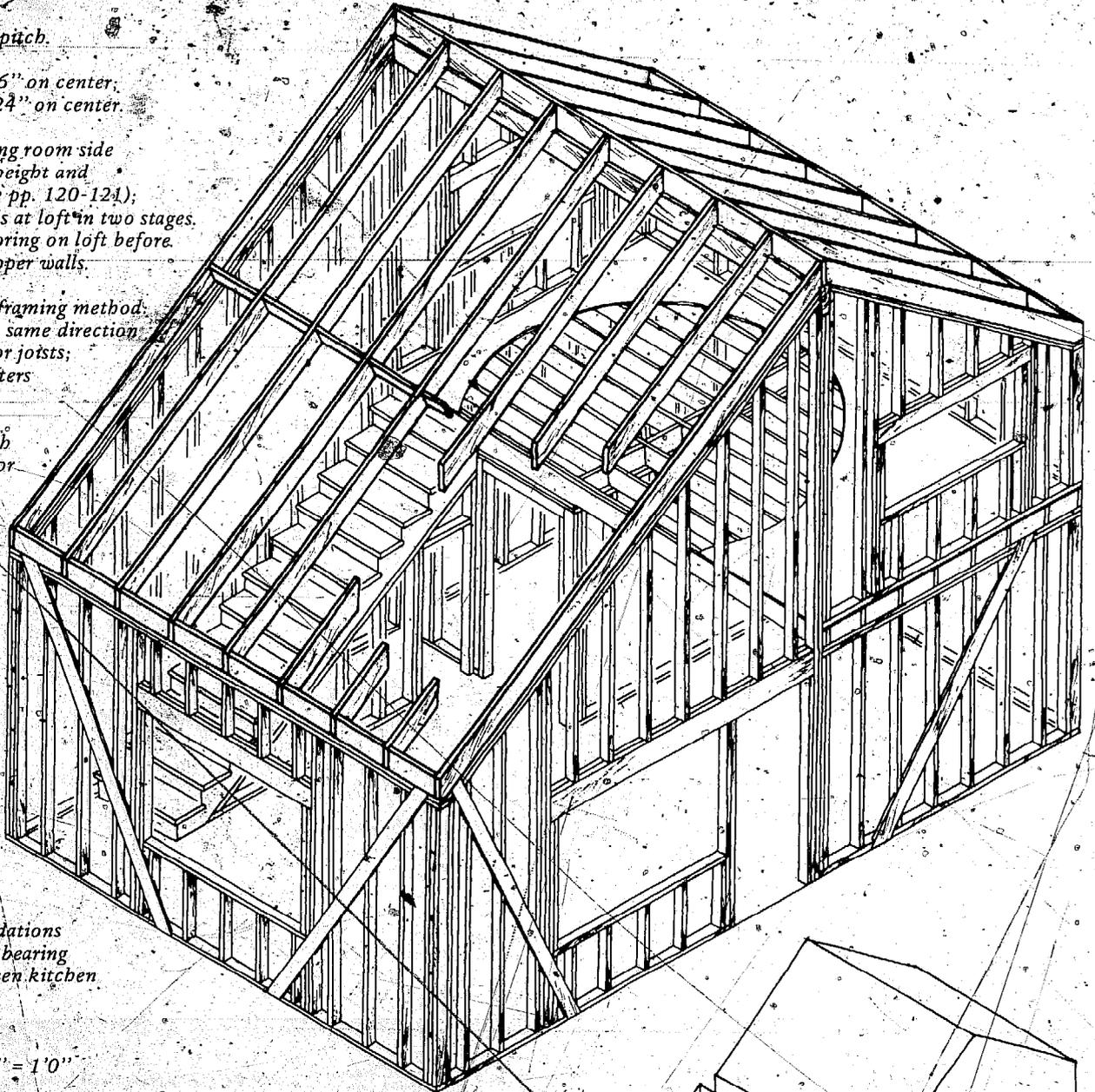

Pour foundations
under loft bearing
wall between kitchen
and bath.

Framing
scale $3/16" = 1'0"$

Note: in snow country,
check with engineer
or bldg. inspector.

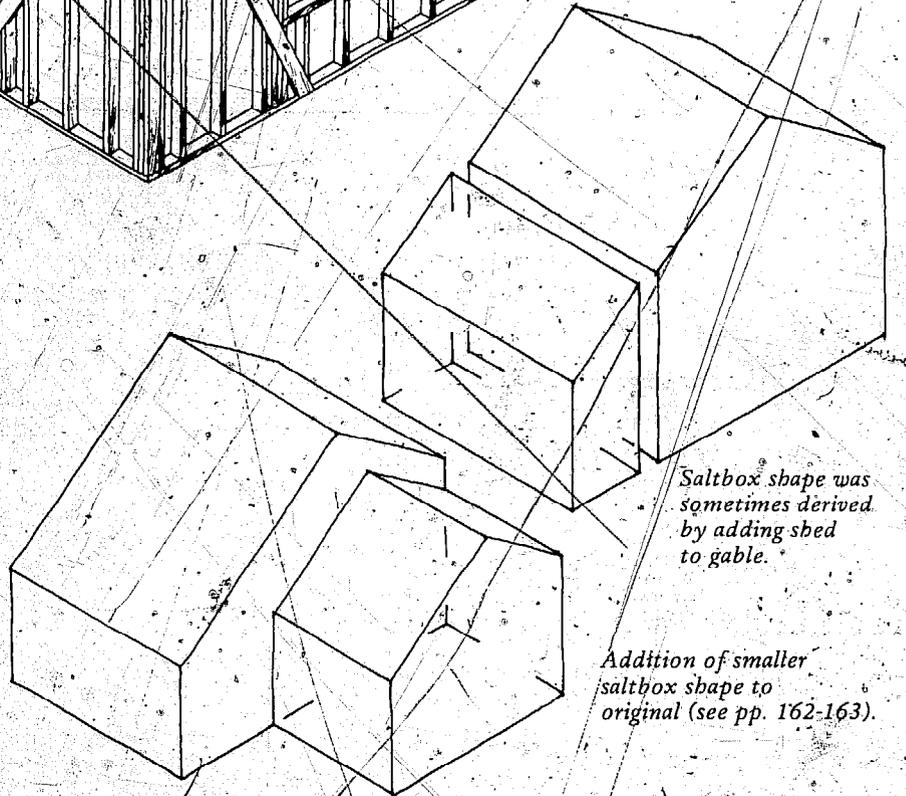
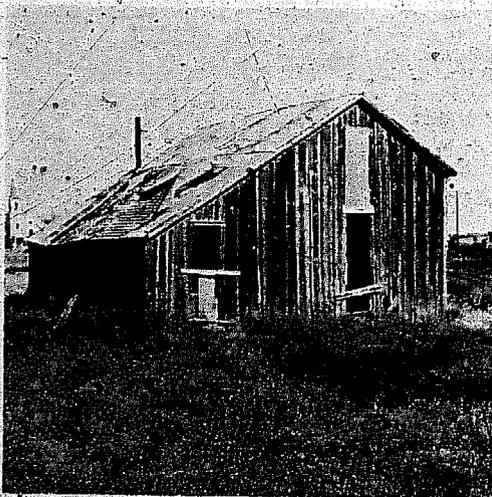

Saltbox shape was
sometimes derived
by adding shed
to gable.

Addition of smaller
saltbox shape to
original (see pp. 162-163).

Gambrel

Gambrel roofs are most often found in the eastern part of the United States and Canada. The word derives from the hock (bent part) of a horse's leg, also called a gambrel. The lower part of the roof is a steep slope, the upper part shallower. The break-in-roof line allows head room in the loft space, and is useful in barns for hay storage (see pages 102-103 for gambrel barn plans), as well as in homes for rooms above plate level.

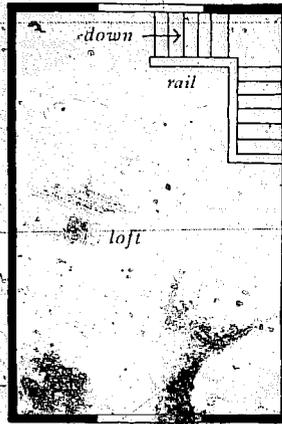

Loft plan

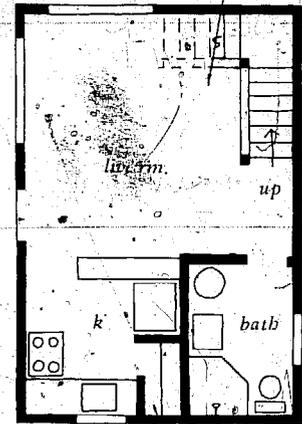

Main floor plan
scale: 3/32" = 1'-0"

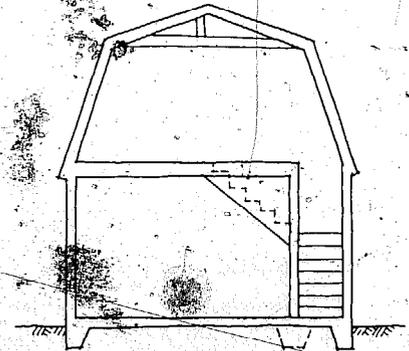
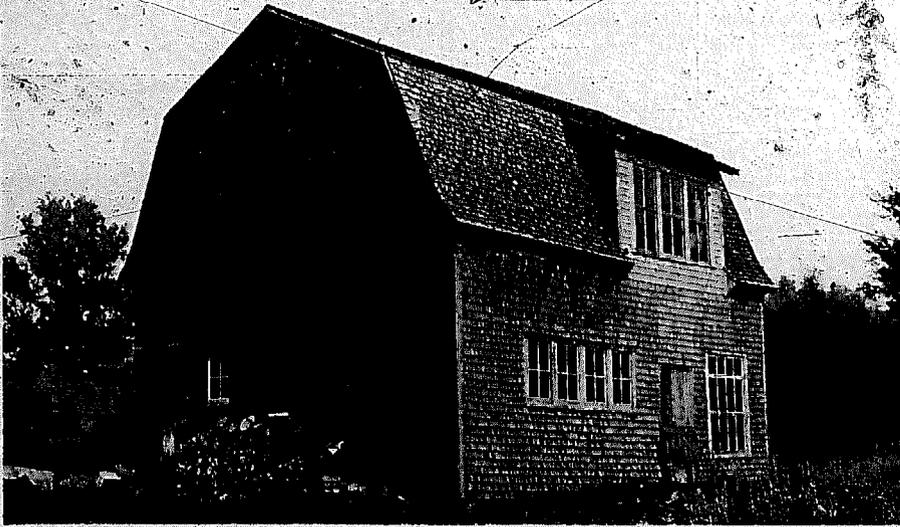

Cross section

