

AT MICROFICHE
REFERENCE
LIBRARY

A project of Volunteers in Asia

Construction Reference Manual

by Donald Batchelder et. al.

Published by:

The Experiment in International Living
Kipling Road
Brattleboro, Vermont 05301
USA

Available from:

same as above

Reproduced by permission.

Reproduction of this microfiche document in any form is subject to the same restrictions as those of the original document.

CONSTRUCTION REFERENCE MANUAL

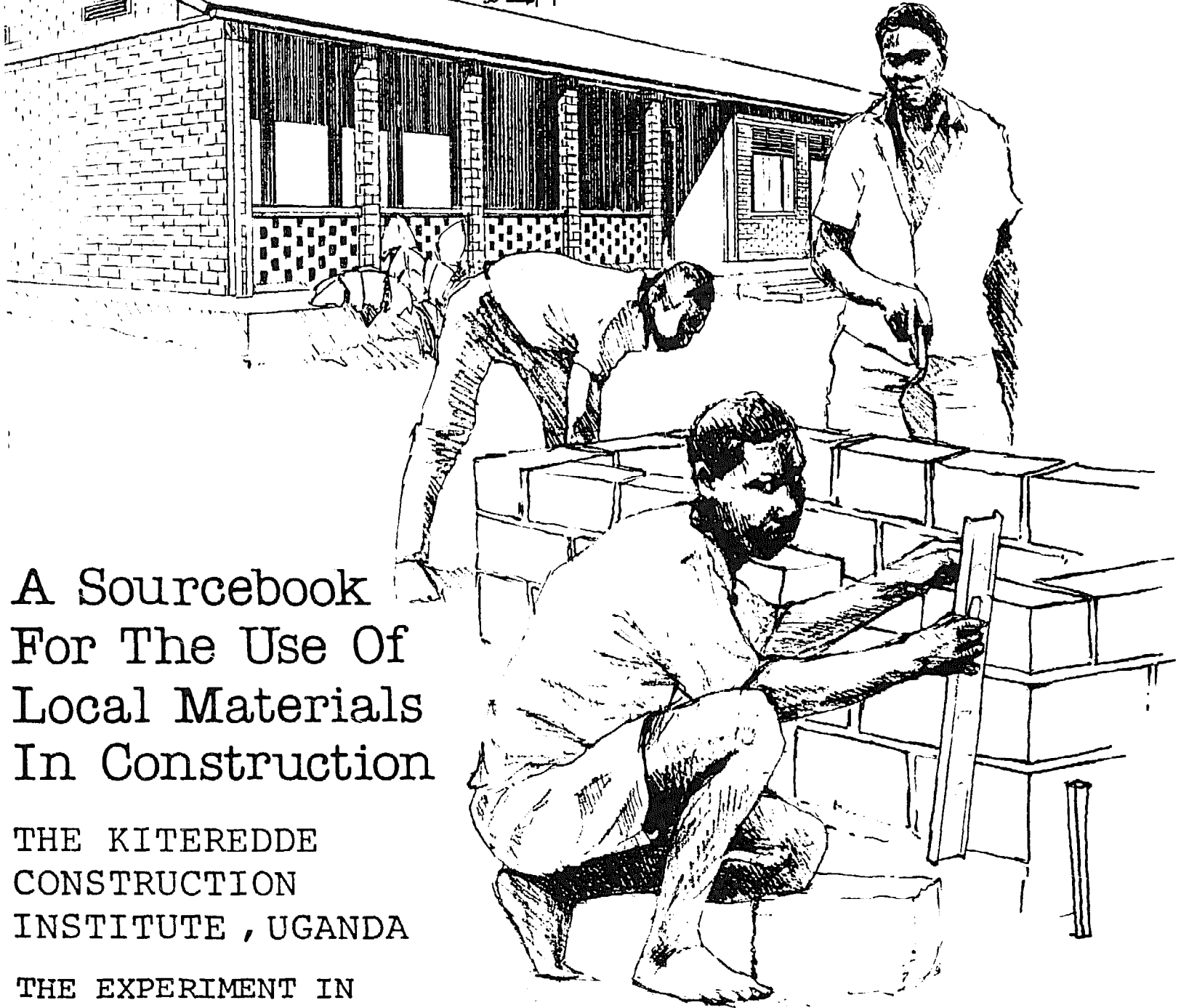
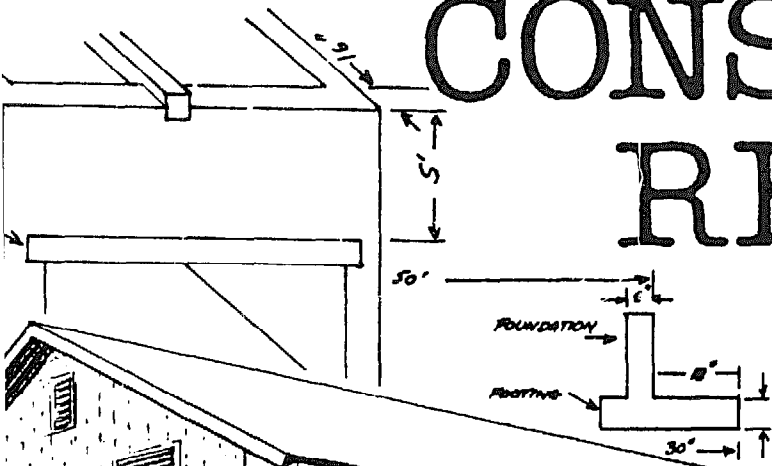

A Sourcebook
For The Use Of
Local Materials
In Construction

THE KITEREDDE
CONSTRUCTION
INSTITUTE , UGANDA

THE EXPERIMENT IN
INTERNATIONAL LIVING

DONALD BATCHELDER ROBERT E. CAIOLA STANTON W. DAVENPORT

CONSTRUCTION REFERENCE MANUAL

A Sourcebook For The Use Of
Local Materials In Construction

Copyright © 1985
by The Experiment in International Living
Kipling Road
Brattleboro, Vermont, 05301
U.S.A.

Grant assistance was provided by the Australian High Commission,
Nairobi, Kenya; the Canadian High Commission, Nairobi; and
Catholic Relief Services.

CONSTRUCTION REFERENCE MANUAL

A Sourcebook For The Use Of
Local Materials In Construction

THE KITEREDDE CONSTRUCTION INSTITUTE

and

THE EXPERIMENT IN INTERNATIONAL LIVING

KITEREDDE, UGANDA

DONALD BATCHELDER, ROBERT E. CAIOLA, STANTON W. DAVENPORT

THE EXPERIMENT PRESS

1985

TABLE OF CONTENTS

INTRODUCTION.....	1
CHAPTER I LOCAL BUILDING MATERIALS.....	4
Mud Bricks.....	5
Raw Materials.....	5
Clay for Brick-Making.....	6
Testing of Clays.....	7
Clays in Southern Uganda.....	8
Digging Clay for Brick-Making.....	9
Processing the Clay.....	10
Bricks.....	10
Brick Sizes.....	10
Moulds.....	11
Calculating Brick Quantities.....	12
Table Method of Hand-Moulding Bricks and Blocks.....	12
Drying and Stacking Bricks and Blocks.....	14
Burning of Bricks in a Country Kiln.....	15
Large Country Kilns.....	15
Small Country Kilns.....	15
Kiln Construction.....	17
Kiln Operation.....	18
Kiln Fuels.....	20
Selection and Identification of Wood and its Usage.....	20
Wood for Special Purposes.....	21
Timber Species Most Commonly Used in Uganda.....	21
Softwood Identification.....	21
Hardwood Identification.....	21
Wood Treatment.....	22
Drying and Stacking Wood.....	22
CHAPTER II BASIC BUILDING COMPONENTS.....	25
Introduction.....	25
Foundations.....	25
Laying Out a Foundation.....	27
Concrete Perimeter Foundation.....	28
Excavating, Pouring, Forms.....	29
Pouring Concrete.....	30
Concrete Slab Floors.....	31
Cast in Place Concrete Piers.....	32
Wood Poles.....	33

BASIC BUILDING COMPONENTS (continued)

Types of Walls.....	34
Mud or Adobe Brick.....	34
Mud Block.....	35
Burned Bricks.....	35
Concrete Block.....	35
Stone Walls.....	36
Corrugated Iron.....	36
Veneer Walls.....	36
Pise or Rammed Earth.....	36
Common Mud Walls.....	36
Thickness and Height of Walls and Gables.....	37
Bricklaying: Solid Walls and Joints in Brickwork.....	39
Importance of Mortar.....	39
Meaning of Brickwork.....	39
Size of Mortar Joints.....	39
Bond in Brick.....	40
Types of Bond in Brickwork.....	40
Terms Used in Bonding.....	41
Roof Framing.....	42
Instructions for Building a Gable Roof.....	42
Eaves.....	44
Flat Roof.....	44
Roof Trusses.....	45
Roofing Materials.....	46
Windows and Doors.....	48
CHAPTER III ALTERNATIVE BUILDING MATERIALS AND TECHNIQUES.....	53
Introduction.....	53
Local Material Mixes.....	54
Concrete Foundation Using Local Materials.....	54
Mortar Cement.....	54
Damp-Proof Course.....	54
Foundation Mortar.....	54
Interior Plastering.....	54
Exterior Plastering.....	54
Concrete for Ring-Beam.....	55
Concrete for Floors.....	55
Mixing Alternative Cements.....	57
Anthill Kiln and Anthill Clays.....	57
Locally Available Paints and Paint Colours.....	60
Local Paint Brush.....	61

CHAPTER IV BASIC MATHEMATICS FOR CONSTRUCTION.....	63
Fundamental Ideas in Geometry.....	63
Formulas and Examples.....	64
Summary of Formulas.....	67
Concrete Mixes and Calculation of Cubic Yardage.....	68
Calculating Strength for Wooden Beams.....	70
Symbols and Abbreviations.....	74
Useful Numbers.....	74
Weights.....	74
Weights of Substances.....	75
Linear Measurement.....	75
Area Measurement.....	75
 CHAPTER V PLANNING AND MANAGEMENT.....	 77
Introduction.....	77
Securing Authority.....	77
Planning.....	78
General Building Calendar.....	78
Policy.....	79
Seeking Advice.....	79
Selecting a Site.....	79
Business Detail.....	80
Orders.....	83
Contracts.....	83
Accounting.....	84
Care of Materials.....	84
Labour.....	85
Labour Agreements.....	86
Labour Relations.....	86
Supervision of Labour.....	88
Calculating Simple Interest.....	89
 CHAPTER VI BASIC SKILLS AND OCCUPATIONAL PROFILES.....	 91
Introduction.....	91
Occupational Profiles.....	91
Performance Standard Key.....	93
Masonry Task Listing.....	93
Carpentry Task Listing.....	97
Cabinet-Making Task Listing.....	99
Drafting Task Listing.....	100

APPENDIX I GLOSSARY.....	103
APPENDIX II REFERENCES AND ACKNOWLEDGEMENTS.....	111
ENDLEAF.....	113
The Kiteredde Construction Institute.....	113
The Experiment in International Living.....	113

INTRODUCTION

Housing and shelter are fundamental needs throughout the world, and each country and cultural group attempts to meet its own needs by designing structures which are appropriate to the climate, conditions and materials available. In modern times, the advent of mass production, long-distance transport and vigorous marketing systems have made possible, in some cases, the importation and movement of housing and building materials from one region or continent to another.

In many cases, however, the surplus capital for the purchase of manufactured products and processed building materials does not exist, and many countries cannot afford to expend precious foreign exchange on imported cement, steel reinforcing bars, metal roofing sheets and other materials for construction, in view of the many pressing needs in agriculture, health, education, industrial development and other important sectors.

At the same time, many of these same countries do not have the raw materials, capital or capacity to produce sufficient quantities of building materials for national needs and at prices which are within the reach of ordinary family budgets.

Many excellent sourcebooks and technical manuals have been published on the subjects of low-cost housing, the use of local materials for buildings, the design and step-by-step construction of houses, clinics, schools and public and commercial structures, as well as agricultural sheds and storage facilities. It is not the purpose of this small book to duplicate the good work which has already been done by others, but rather to take a look at a specific area of the world, and to address actual construction issues from the perspective of several years of direct hands-on experience, and perhaps most important of all, from a slightly different premise.

Simply stated, the premise underlying this volume is that a significant gap exists in construction literature, which is that most of the technical manuals we have studied assume a certain level of availability of manufactured materials. The purpose of this manual is to provide a basic understanding of the ways in which clean, durable structures can be built with local materials and in the total or near-total absence of manufactured materials.

Expanding populations require additional housing far beyond the capacities of many countries to provide. It is estimated that in some African countries, the number of housing units will have to double by the year 2000, simply to stay even with the demand. While this may be good news for the construction industry, it places enormous strains on financial reserves, policy makers and natural resources of a nation. It appears likely that few developing nations will have the financial strength in the next two decades to enable them to provide adequate housing for their citizens, unless a coordinated effort is made to promote self-help housing construction, to learn how to make good use of locally available materials, and to support the technical training of youth and adults in basic building techniques and the practical elements of extracting, adapting and using local materials. The customary system of importing manufactured products

and processed materials will not solve the problem of providing adequate housing for the vast numbers who need it now, and for the masses of children currently growing to adulthood who expect to have families and homes of their own.

In 1979, The Experiment in International Living, a private voluntary organization, and the Bannakaroli Brothers, an African Catholic order, with headquarters in Kiteredde, Rakai District, Uganda, jointly planned a vocational training center which was specifically designed to train young men and adults in construction skills using locally-available materials.

The Kiteredde Construction Institute (KCI) was established in 1980. Initial funding support was provided by the Congress of the United States, and administered by the U.S. Agency for International Development (USAID) (1979-81). Additional support was provided by the Canadian International Development Agency (CIDA), the Australian High Commission, Catholic Relief Services, and The Experiment in International Living. Land, work space and start-up facilities were provided by the Bannakaroli Brothers.

Training specialists from The Experiment worked side-by-side with the technical and construction personnel of the Bannakaroli order in all phases of planning and implementation of the project, from the design of the curriculum to the actual construction of classrooms, dormitories and work spaces. From the beginning, the emphasis of the program was on practical skills development, learning by doing, the preparation of trainees for jobs in the construction industry and in public works departments, and the placement of each in wage-earning employment immediately upon graduation.

Were this volume intended to be a history of the Kiteredde Construction Institute, it could include development-related narratives about the philosophy of the educational program and its impact upon attitudes towards craftsmanship, standards and work; it could describe the training of young men in the elements of small business management, and the subsequent formation of a number of small-business firms by graduates, which are now carrying out useful construction projects in Uganda; it could speculate on the possible socio-economic ramifications of the fact that KCI has over 500 applicants for the 25 spaces in each entering class; it could mention the increasing volume of requests for KCI to provide outreach, extension and training services for others; it could include a description of the technical assistance KCI personnel have provided to other development programs in Uganda, such as well construction and basic skills training; or it could tell about the progress made in opening up new farm acreage to move the institution towards self-sufficiency; or could try to explain why employers in public works offices and in the construction industry request more graduates to fill jobs than the institution can provide.

But perhaps the single most relevant component of the program which requires mention here is the Bannakaroli Brothers' knowledge of the use of local materials for construction, their experience in practical applications, and in training others how to use them.

New construction and the building of new houses came to a virtual standstill in Uganda in the 1970s. The construction industry lacked materials, and the state of the economy forced people to reach back to all but forgotten materials and methods.

The Bannakaroli Brothers had worked for a number of years with the excellent clays and other materials available in southern Uganda, and had employed them in the construction of their own buildings, and in carrying out construction assignments for others. This knowledge of brick, tile, block and clay moulding; of efficient kilns and appropriate firing techniques; of masonry and carpentry; of tropical building design; of the use of local materials to make mortar, paints, plasters and other necessary elements of construction, in the absence of manufactured and imported materials, form the basic components of the training program at the Kiteredde Construction Institute, and the basic contents of this manual.

CHAPTER 1

LOCAL BUILDING MATERIALS

Introduction

There are many problems plaguing the building industries in Africa and in other developing regions, in view of growing populations and demand for housing. The high costs of importing materials, and of producing high-quality building materials domestically, are perhaps the major constraints to progress. In addition, local production of building materials in many areas cannot keep pace with demand, particularly in rural areas where there is limited access to urban factories and where transportation facilities are limited.

A practical response to these problems is being carried out in southern Uganda through the use of locally available materials. The contents of this chapter provide introductory information about the techniques and materials being used by the Kiteredde Construction Institute, local area contractors and residents in building affordable houses and other structures.

Construction techniques in the area are primarily masonry-based, because of the excellent clays which are readily available. Houses are generally built with light-weight metal roofing (corrugated sheets) and conventional aperture treatments, with typical electrical and plumbing installations.

Not all problems have been resolved. Work is being done to address the chronic lack of durable, light-weight roofing, made from local materials, which will eliminate the expense of metal roofing. Locally produced cement in Uganda, as in many other countries, is often of poor quality, and lime as a bonding substitute, or as a supplement to save on the volume and cost of cement, is rarely used, despite the availability of lime deposits in many areas. This is primarily due to the cost of the equipment needed to produce lime from extraction, and the systems to make it available in local markets at reasonable prices.

In general, the use of local materials needs to be supported and reinforced to produce sufficient quantities of materials of adequate quality to withstand the effects of climatic conditions which range from humid rainy seasons to extremely hot dry seasons. Mud structures, mud and wattle buildings, and locally produced bricks and blocks do not endure for many of these seasons, and must be constantly patched and repaired.

A recent socio-economic study of four districts of Uganda offers some insight into the general condition of housing in representative areas: Kigezi, Masaka, Teso and Busoga. Of 2702 households surveyed, 258 were grass huts (9%); another 900 were round mud-and-wattle construction with thatched roofs (33%); another 740 dwellings were rectangular mud-and-wattle construction with thatched roofs (27%); there were 679 houses of mud-and-wattle, rectangular in shape, with iron roofs (25%); and 117 rectangular houses made of brick and block construction with iron roofs (4%).

Without going into a detailed analysis of these figures, it is safe to state that a great volume of sub-standard housing exists in Uganda as elsewhere, particularly in rural and village areas.

In response to the need for better housing at reasonable cost, this chapter offers techniques of clay extraction and preparation; testing for clay plasticity; basic standard brick and block sizes; moulding, drying, stacking and storage of air-dried bricks and blocks; kiln construction; fuels and firing techniques for kilns; wood identification and treatment; and the uses of different kinds of woods in construction.

Clearly, the emphasis on clays, and brick and block construction, in this chapter is not entirely suitable for builders in regions where clay is not readily available, but the approach to identifying and making good use of the materials at hand may be useful. Chapter III deals with alternative building materials.

Finally, it is hoped that readers will be able to employ the techniques outlined in this chapter, or adapt them to their own situations and materials, to build more attractive and durable structures, at lower cost, and with lower repair and maintenance costs over the years. It is also hoped that over time, contractors and the building industry in general will begin to make better use of local materials to reduce construction costs and to help bring clean durable housing within reach of everyone.

LOCAL BUILDING MATERIALS

Mud Bricks:

One of the world's most widely used building materials is burnt brick. Many countries have deposits of suitable clay, and good sources of local fuels, so that no foreign exchange is needed for the production of this well-proven building material.

Although highly mechanized production methods are used successfully in many countries, these may be uneconomical where the rate of production is low, and may be inadvisable where spare parts, maintenance and service are difficult to obtain.

Thus in many developing countries, labor intensive production methods are more appropriate, and if care is taken in production, can produce satisfactory bricks.

Most bricks made in developing countries are moulded by hand, using traditional techniques which in some instances may have been in use for hun-

dreds of years, although machinery is also employed. Increasingly, local builders and markets have indicated a need to improve the quality of bricks in many areas, and the growing demand for housing construction has called for new production facilities. The most important areas of improvement in order of priority are:

Improved hand-moulding systems to shape bricks more accurately in areas where slop-moulding is traditional;

A simple mixing and screening system for raw materials;

The development of a small-scale kiln for firing the bricks.

Raw Materials:

The principal raw material used in brick-making is called clay. Pure clay has a property called **plasticity**, which means that it is a mate-

rial which can be made into a variety of shapes by applying pressure. When the pressure is removed, the plastic material retains much of its new shape.

Dry clay is **not** plastic. It must be first mixed with water. When the wet clay has been formed into a specific shape, such as a brick, and then is allowed to dry, it once again becomes hard and non-plastic. If, however, the dry brick becomes wet again, the clay becomes soft once more, and running water or rain will gradually wash it away.

But clay has another important quality. If it is heated until it becomes red hot, it loses its ability to become plastic (or to soften and wash away in the rain) when it becomes wet. It is this last property that makes burnt clay bricks so important for building houses, grain stores and other agricultural structures, drainage ditches, factories, and office, commercial and other buildings.

Finally, the other most important property of clay is that if it is heated to a high enough temperature, and then cooled, the strength of the material increases until it is much stronger than the original unburnt clay.

The clays used in brick-making are not pure. They vary, not only in the types of clays present, but also in the types and amounts of impurities that are present. The degree of purity, and kinds of impurities, vary from one place to another, and also vary according to the nearness of the clay to the surface or its depth below the surface of the ground.

The type and amount of clay present, and the type and volume of impurities in it, determine whether or not good quality bricks can be made. These factors, the amount and kind of clay,

and the degree of purity/impurity of the sample, determine the kinds of problems one may encounter in trying to manufacture strong durable bricks. Variations in the quality of the clay determine the proper water mixtures, and affect the moulding and drying process, as well as the proper firing temperature and kiln-time needed in order to produce high-quality bricks.

Thus, it is most desirable that clays be tested for suitability and purity, unless reliable testing has already been done, or unless their properties are well known from direct experience and successful production. It is particularly important that reliable testing be carried out regarding both the quality and quantity of the clays available, if someone is planning to establish a brick-making business, or to invest money in clay extraction or brick production.

Clay For Brick-making:

Clay for brick-making must satisfy a number of requirements:

1. The deposit must be easily available, which means there must be access to the deposit so the clay can be excavated using the facilities at hand. At the same time, the clay deposit should be located within a reasonable distance of the people who are going to buy or use the bricks.

2. The clay must be suitably plastic when mixed with water, and such mixing must be easily done using the facilities available.

3. The plastic clay must be able to hold its shape when moulded into a brick, and must not warp, distort or crack during the drying process.

4. The dried brick must be strong enough to withstand whatever handling is required during the production process. For example, bricks at the ground level under the weight of the

stack of bricks above them in the kiln, must be able to withstand the weight and pressure of the bricks in the settings above.

5. The clay should be free from harmful impurities such as limestone, large stones and soluble salts. Limestone can cause the brick to burst around the limestone particles after it has been fired. Stones can cause cracking in the bricks. Soluble salts can cause harmful and unsightly deposits on the bricks after they are fired. Limestone particles are usually white to grey in color, and may be as small as a pin head in size to as large as a groundnut. Larger particles of limestone can be picked from the clay, if there are not too many of them. Soluble salts can usually be seen as a fine sugar-like or crystalline deposit on the clay as it dries.

6. The clay should have the two qualities of (a) forming into an adequately durable brick as a result of the firing process, and (b) not distorting or warping during firing. It is important to know that different clays require different temperatures for adequate burning, and that different fuels, firing methods, and kilns produce different temperatures. Higher temperatures for hotter firing require more fuel, and are therefore more costly.

Wet clay shrinks as it dries, and the shrinkage is in direct proportion to the amount of water present in the clay. Different types of clay require lesser or greater amounts of water to make the clay plastic for moulding, and to produce suitable bricks for firing and use.

This quality of shrinkage during the drying process is important to bear in mind when making a brickmould, or in having one made, because the size of the mould must always be slightly larger than the size of the final burnt brick, in order to allow for

this shrinkage. A small amount of shrinkage also takes place during the firing process.

A brick made from a clay mixture with less water is usually more dense and stronger than a brick made from a clay mixture with more water. During the firing process the dense brick, with less water in the clay, has more surface particles of clay touching one another, than is the case with wetter clays. These pieces fuse together more readily, and tend to form a stronger burnt brick.

Testing To Discover The Amount of Clay In A Soil Sample:

1. The Shine Test:

Take a small handful of soil, and add water to make a stiff mud. Then mix thoroughly in the palm of your hand. Open your hand and make a flat cake out of the mixture. Slowly close your hand around the cake, and watch the mixture closely. The cake should shine as your hand begins to close and apply pressure. If not, add more water and try it again. If the shine disappears when you open your hand, it means that the soil may have too much silt or sand in it. If the shine does not go away when you open your hand, it should indicate that your soil sample contains a high proportion of clay. (Figure 1.)

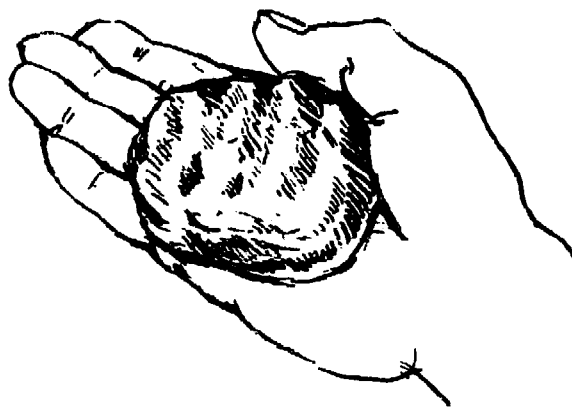

Figure 1

2. The Worm Test: (Figure 2.)

Wet a soil sample until it becomes a stiff mud, moist but not watery. Roll the stiff mud into a worm shape about the thickness of a pencil, and about 10 cm long. Use the palm of your hand to roll out the sample on a flat hard surface. Carefully pick up the worm of stiff mud with two fingers holding it at one end. Hold the worm parallel to the ground. If the worm breaks off from its own weight, it contains silt and sand. If the worm bends or sags, but does not break, it contains a good proportion of clay.

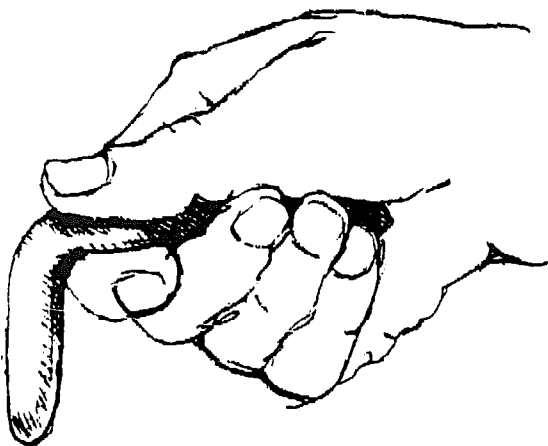

Figure 2

Clays in Southern Uganda:

Clays most common in Uganda are River Bank Clay, Swamp Clay and Ant Hill Clay.

River Bank Clay: (soft clay)

Color: red to whitish to grey.

Depth: one to five feet below the surface, i.e., below grade.

Moisture: semi-moist, easily manipulated or squeezed by hand, this is the most commonly used clay in the region.

Location: it is usually found in low-lying areas, and generally accessible.

Swamp Clay:

Color: red to whitish to grey.

Depth: one to three feet below the surface.

Moisture: very moist. Water can be squeezed out by hand. During the rainy season it is usually not accessible due to high water table and flooding. However, if buildings or wattle houses are being constructed near the river or wet area, this clay can be used to spread on the walls.

Ant-hill Clay:

Color: brown to reddish.

Depth: Depending on the size of the ant-hill, clay can be up to ten feet about the ground surface, and down to ten feet below ground level.

Moisture: very dry.

Using ant-hill clay can serve several purposes:

1. The clay extracted from the ant-hill can be made into excellent bricks and blocks, and also into roof and floor tiles.

2. The ant-hill from which the clay is extracted can be dug further and shaped into use for a kiln; i.e., the extracted clay can be moulded into bricks and put back into the three-sided opening and burned.

3. No transportation costs from moulding site to kiln.

4. The ant-hill kiln, with three well closed sides, will save fuel and fuel costs, since it will hold the heat longer and more efficiently than conventional country kilns made of loosely piled bricks.

Earth in many tropical and sub-tropical countries has properties, which combined with hot sun and dry air are favorable to making durable mud bricks, blocks and mud walls.

Clay and sand are essential. Clay by itself shrinks and cracks; clay mixed with sand in proper proportions will reduce shrinking and cracking. Too much sand in the mixture weakens the clay and makes it too soluble. Thus no more sand should be added to the clay than is absolutely necessary. If the best bricks you can make without cracking are too weak, one solution is to add plenty of chopped grass, straw or hemp to the mixture, and mix very thoroughly.

Digging Clay for Brick-Making: Brick clay should be dug early in the dry season because it is much easier to handle, due to the moisture content of the soil, and requires the addition of less water to make mud.

The builder has a simple device for determining and maintaining the proper proportions, mixtures and moisture content, and that is the device of Cosma's Clay Pit, designed by Brother Cosma of the Kiteredde Construction Institute. It is a hole in the ground with a technical purpose.

First, the builder clears away all the shrubbery and extraneous material from the plot of earth he intends to use. He then digs a pit with two or three vertical walls running across its width or length. (See Figure 3). As he digs, he cuts through two layers of soil, one of sand and another of clay. He maintains one depth for the length of the channel created by the first vertical dividing wall, and tests the clay produced at that level. He then digs a slightly deeper channel across the clay pit to test a different mixture, as shown in the drawing. Eventually through this procedure the builder will reach the balanced mud mixture he is seeking. When the testing proves that the proportions are correct, he should always dig his clay pit at the same depth. It may take from three to five different testing channels to find the proper depth and mixture but it is worth the time and effort if the purpose is to make bricks of good quality. In some cases, the blend of sand and clay is so ideally balanced that once the proper depth is known, it can be dug and used indefinitely.

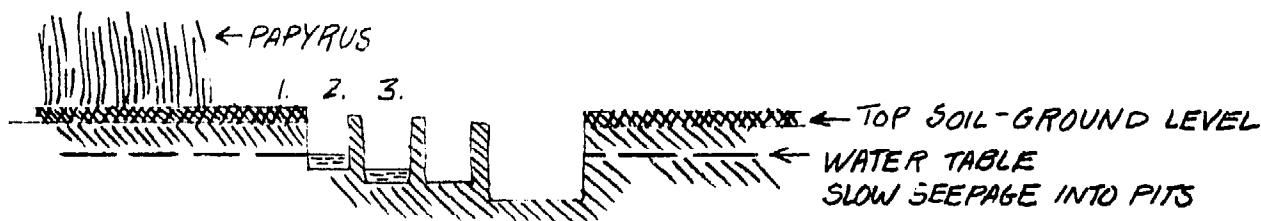

1. CLEAR PAPYRUS.
2. DIG PIT. AFTER SEVERAL HOURS OF DIGGING, WATER MAY SEEP IN. CONTINUE TO EXTRACT CLAY AND WATER UNTIL WATER IS SEEPING IN FASTER THAN CAN BE BAILED. ABANDON PIT.
3. DIG NEXT PIT, CONTINUE PROCESS OF EXTRACTION.

Figure 3

Processing the clay: The builder digs and mixes the mud about six to ten days before he wants to start making bricks or start building with it. First, he prepares a mat of banana leaves upon which to build the mud pile, because the leaves will help to retain the necessary moisture in the clay.

As the clay is dug out of the pit, it is piled on the mat of leaves near the pit. It should be mixed around by one's feet to detect visible impurities, and these should be taken out. (Figure 4B). The clay should be piled in three to five foot stacks.

Once the clay becomes sticky with a constant consistency in these preliminary stacks, it is ready to be piled in a mound about five feet high and five feet across at the base. The

next step is to make a hole two feet deep by six inches in diameter in the top of the pile, and fill it with water. Cover with a matting of grass about 6 to 12 inches thick, and then moisten the grass once in the morning and once in the afternoon.

After two or three days, remove the grass and mix the clay again with feet and hoes. Rebuild the stack and let it continue to cure for several more days. After 6 to 10 days from the first stacking it will be ready for use. If the clay is too sandy, additional sticky clay can be added. It is very important to mix the clay well each time it is used. No large lumps or stones are permissible in brick mud, although small stones of not more than 1/4" in diameter are not objectionable and may be useful. (See Figure 4A and 4B).

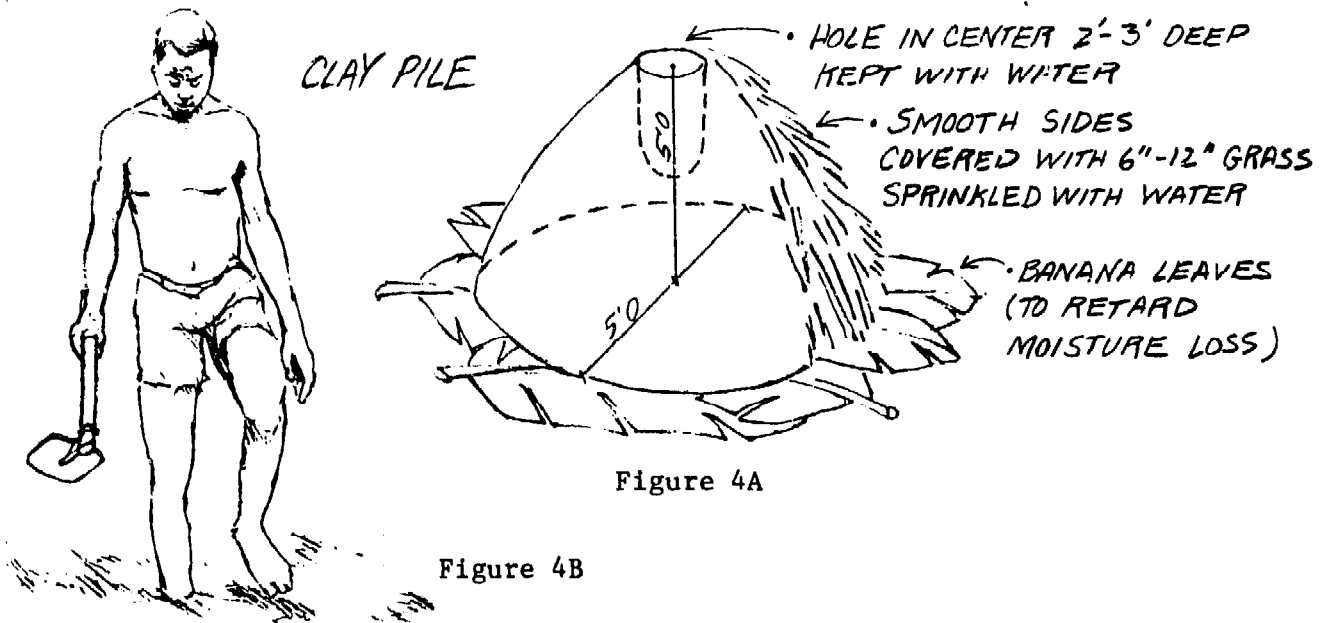

Figure 4A

Figure 4B

Brick sizes: It is good practice to follow some tested method in brick sizes. Bricks require a certain depth in proportion to their length so that they will not easily break in two. The length of a brick should be in harmony with building measurements and the width of a brick should always be slightly less than half its length. The builder should carefully plan his brick sizes if he does not follow standard sizes.

The brick sizes which have been found most practical in eastern Africa are:

Unburned moulded bricks 9" x 4" x 3" when fired, produce burned bricks ready for construction:
8.5" x 3.5" x 2.5".

Unburned moulded blocks 12.5" x 6.5" x 5.5" when fired produce burned block ready for construction:
12" x 6" x 5".

Moulds: In constructing a mould for shaping bricks or blocks, hard wood should be used. The pieces of wood must be straight, and either sanded or planed smooth. This is to ensure smoothness and perfect moulding on all sides of the brick or block. Care taken at this stage will help to produce an attractive, marketable product. (Figure 5).

The general thickness of wood used for making the mould is 1/2". Moulds made from hardwood should produce up to 75,000 bricks or blocks before replacement is necessary. If hardwood is not available, a strip of light metal (tin) can be run along the top edges of a softwood mould to prevent wear as the striker moves over the edge to shear off excess mud.

When manufacturing bricks, have as many as four moulds on hand, if there are that many skillful men available, and enough labourers to keep them busy and supplied with clay.

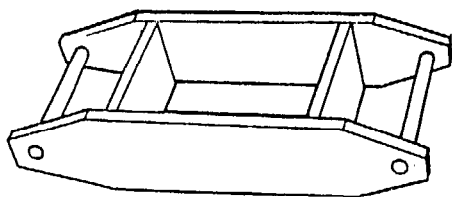
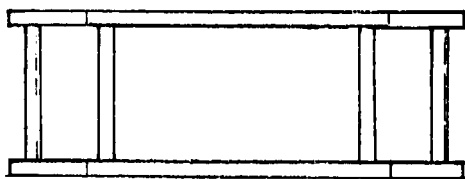
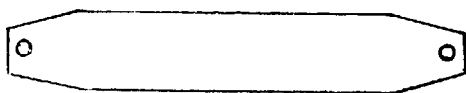

Figure 5A



TOP VIEW

Figure 5B



SIDE VIEW

Figure 5C

Bricks with Special Shapes: It is possible without extra cost to improve masonry by the use of rounded corners. One benefit of the round corner is its durability, in contrast to conventional sharp corners which are easily damaged, particularly if made with mud plaster. (Refer to this for openings and parapets).

A slotted brick for use against all doors and window jambs is a virtual necessity. The slot accommodates the strip on the frame so that the frame will not shake loose in the wall. (Figure 6).

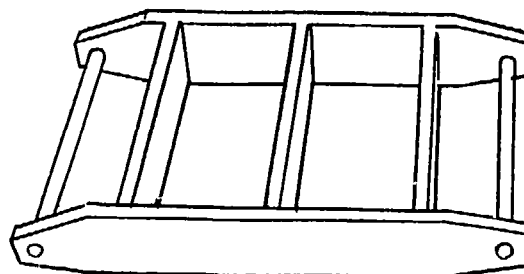

MULTIPLE MOULD

Figure 6A

MOULD FOR ROUND CORNER (BULL NOSE) BRICK.

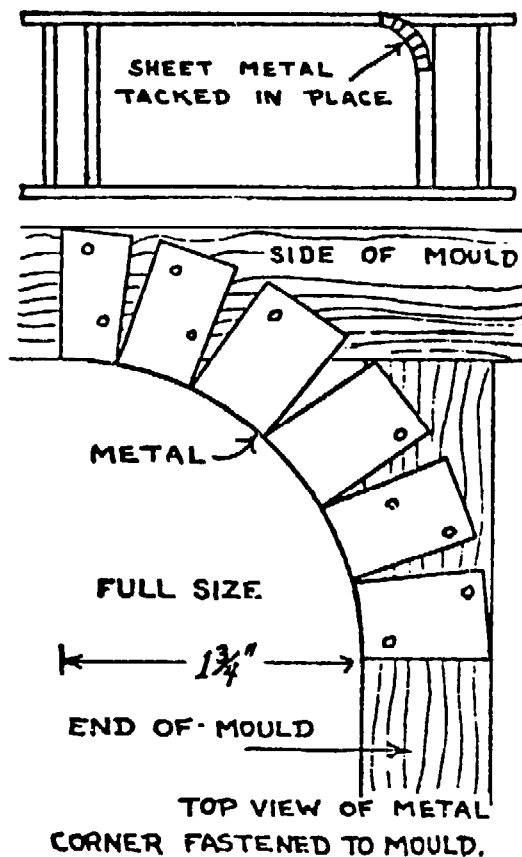

Figure 6B

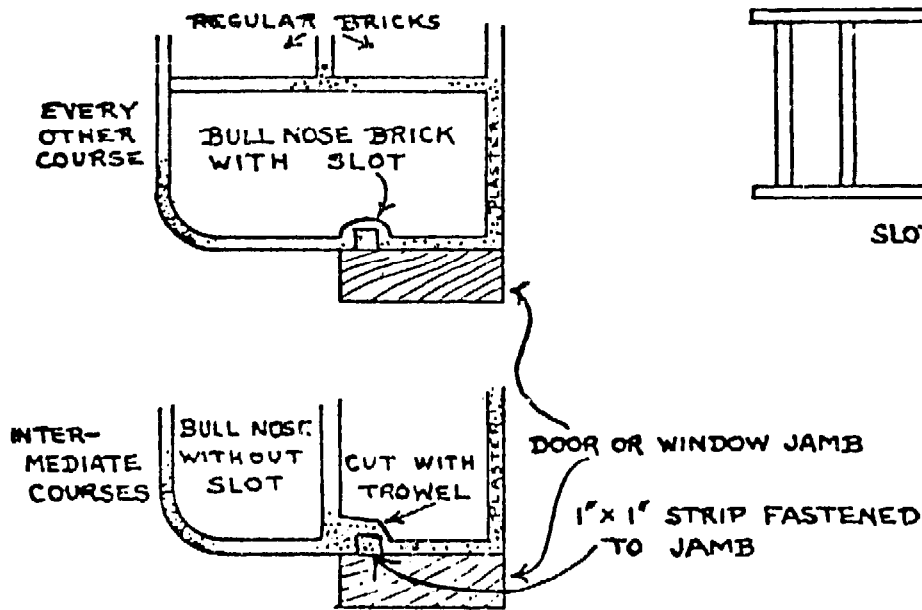

Figure 6C

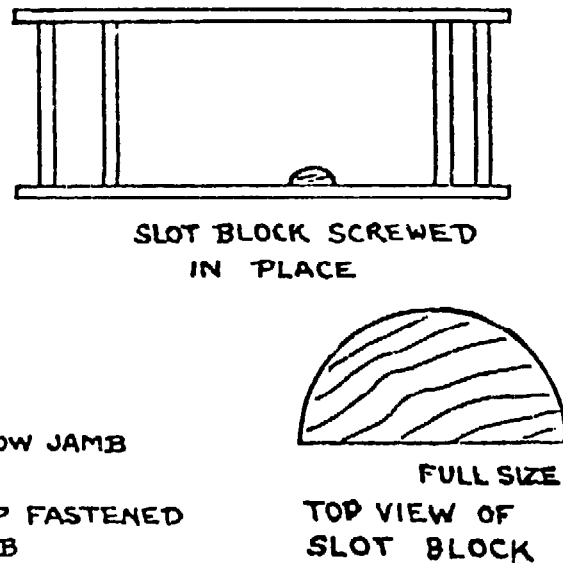

Figure 6D

Calculating Brick Quantities:

Calculate the total area of all the walls in the building you are planning by measuring the total linear feet (length) of each wall, and multiply by the height. There are six standard bricks to every face square foot of wall. A simple set of calculations will reveal the number of bricks needed for the job.

The area of a gable is the width multiplied by one-half the height. The total area of two identical gables is their width multiplied by their height.

In estimating brick quantities, do not deduct for openings, such as windows and doors, unless there is a special reason for doing so. Extra bricks are always useful, and a surplus over and above actual needs allows one to select the best bricks and to discard those which are less well moulded. As a general rule, if one has sufficient time and money, it is worth it to make a few thousand extra bricks.

Table Method of Hand Moulding Bricks and Blocks:

Table or slop moulding is the most common moulding practice used in Uganda today. There are generally three workers involved: the moulder, the layer, and the helper who assists both. The procedure is as follows:

- 1) A simple table is made by using a 2" by 8" board nailed to two 6" x 6" wide poles, which are driven at least two feet into the ground. The table surface should be at the level of the moulder's waist. (Figure 7).
- 2) The drying ground must be very smooth for laying out the moulded bricks, otherwise the bricks will be badly shaped after drying.
- 3) The clay mixture should be slightly wet.
- 4) The moulder stands near the table. At his right hand side is a small pit for holding water, or a bucket of water. At his left hand side is a pile of prepared clay.

5) He takes a clean mould from the water pit or the bucket, and places it in front of him on the table.

6) He takes a piece of clay from the clay pile and quickly forms it into a rough shape equal in size to about one and one-quarter of a brick, that is, slightly larger than a brick.

7) The piece of wet clay is raised in both hands and thrown with some force squarely into the mould on the table. (Figure 7).

8) The moulder takes the striker or straight stick, and holding it at an angle, smooths off the top of the brick. The excess clay from the top is thrown back on the pile.

9) The brick in the mould box is passed to his left side to be taken away and layed out on the drying ground. **Caution:** water is used as the release agent to help slide the brick from the mould. Very wet bricks

are easily damaged or knocked out of shape. Very wet bricks at this stage of the moulding process produce poor surfaces, and after firing, are generally not as strong as dryer bricks, and usually sell for a lower price.

10) After sliding the brick out of the mould, the brick should be covered by a handful of grass to prevent the sun from drying it too quickly, and to keep rain from changing its shape.

11) The moulder repeats the process.

It is worthwhile to note that the brick moulder and brick carrier are two very important people in the brickmaking process. The moulder can tell if the quality of the clay is good or poor as he works with it, and the carrier because he must make sure that the bricks are properly carried to the drying ground and carefully laid out with no damage or loss of shape.

The same procedures are used for block making. It is important to remember that blocks take several days longer than bricks to dry out.

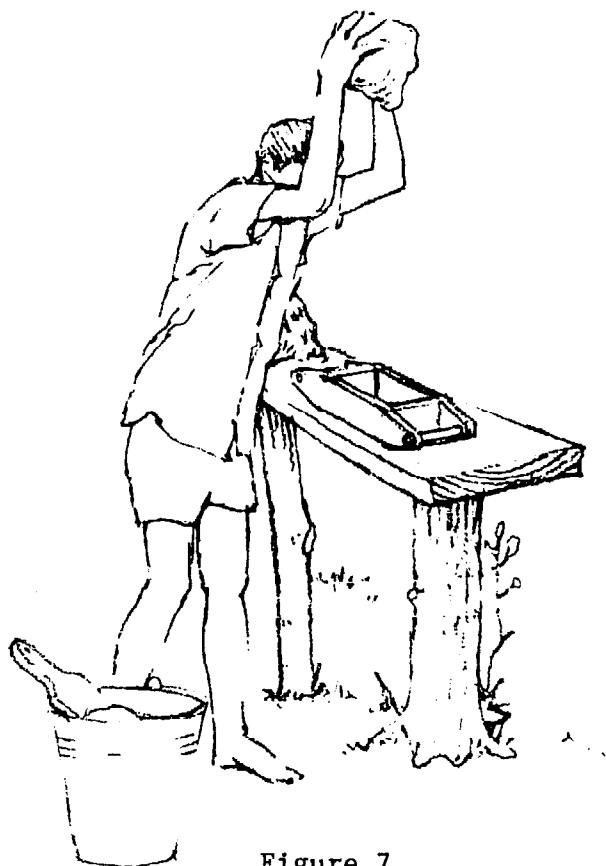

Figure 7

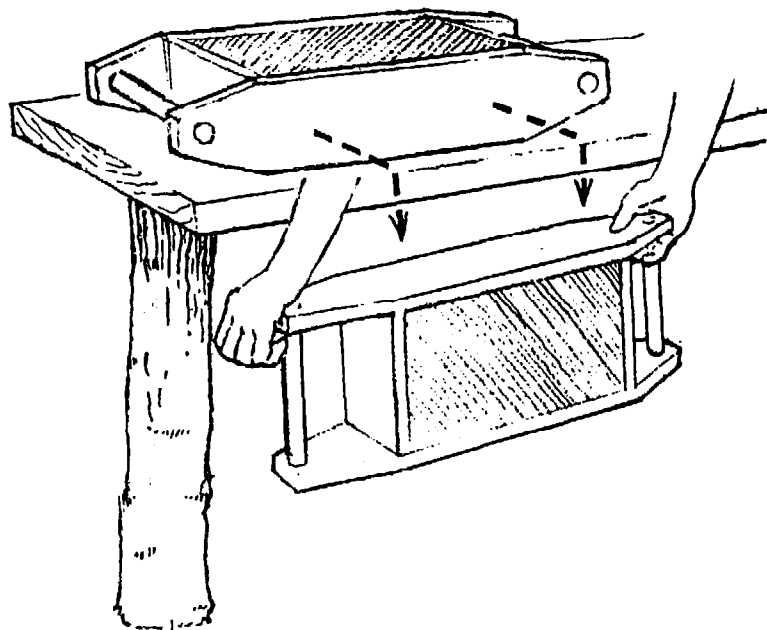

Figure 8

Drying and Stacking Bricks and Blocks

The drying ground must be very well prepared so that it is smooth and free from small holes, bumps, stones and grass. It is preferable to cover the drying ground with either sand or sandy loam, which is then smoothed off. It is a waste of effort and time to locate, dig up and prepare good quality clay, to make first class bricks, and then spoil them by laying them on badly prepared, rough drying ground.

When bricks are carried from the moulder's table to the drying ground in the mould, the layer takes the mould and turns it upside down on the ground and lifts the mould from the bricks. Sometimes a slight shaking of the mould box is required, but this must be done gently so the bricks will not lose their shape. Although the bricks are laid close together, care must be taken to prevent damage caused by pushing newly made bricks against or into those already stacked on the drying ground.

As soon as the bricks have been laid out, they should be covered with grass, and the grass should be dampened with water. This prevents the bricks from drying out too quickly and keeps them from cracking. (Figure 9).

STEP I

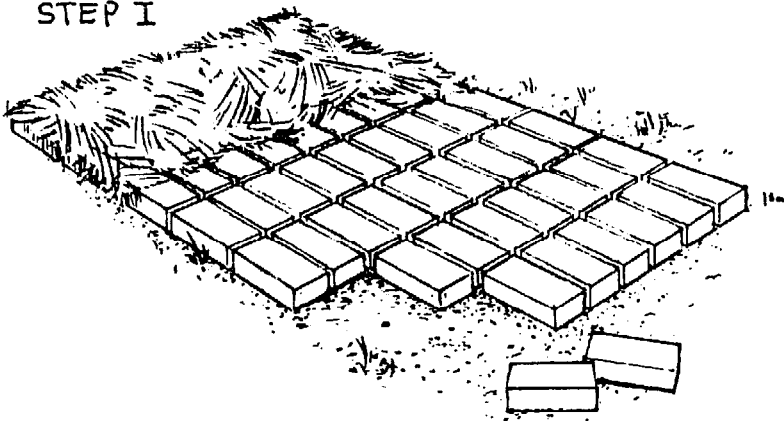

Figure 9

Within two days after being laid out, the bricks can be turned on their sides and covered again with grass. After another several days, the bricks should be turned again and placed on end.

STEP II

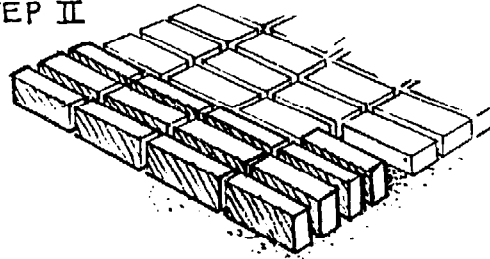

Figure 10

After one week to ten days, bricks can be stacked up in an open setting, or in a covered shed which is open on the sides. If the bricks are stacked in the open, then the lines of drying bricks should run from north to south so that the sun is able to cover both sides of the stacks. When stacked in the open, grass can be applied over the top for protection, particularly in the rainy season.

STEP III

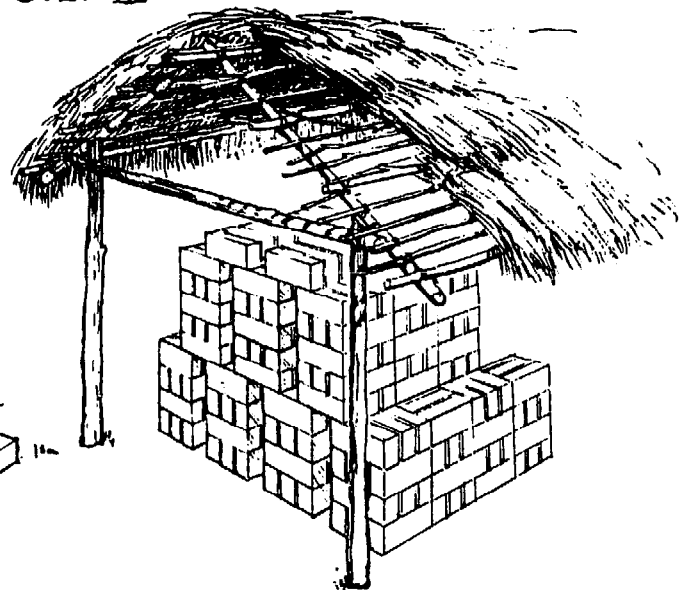

Figure 11

Reasons for Bricks Cracking:

- 1) Clay not mixed well with water.
- 2) Clay mixture not left long enough in the clay pile to age.
- 3) Bricks stick to soil of uneven drying ground.
- 4) Too much sand in the clay mixture.
- 5) Bricks are not covered soon enough after being laid on drying ground.
- 6) Drying too quickly.

The Burning of Bricks in a Country Kiln.

Due to specific economic conditions in Uganda, and the universal economic conditions in many developing countries, mechanized transport costs rise rapidly with higher fuel costs, and it becomes less practical for building materials, such as bricks and bags of cement, to be transported for long distances.

The large brickworks located on the outskirts of large towns, for example, find it less economical and profitable to supply potential customers in the distant rural areas. Rural builders must therefore seek local suppliers of basic materials who have been able to find and utilize suitable sources of raw materials that exist in the locality.

Opportunities will arise for the village cooperative or local entrepreneur to carry out the small-scale production and marketing of fired clay bricks and tiles. The same is true for the production of cementing and mortaring materials, when suitable local deposits of clay, limestone, pozzolanas and other raw materials are available.

In the more remote regions, it may be quite impractical to import even those materials with which to build a permanent brick kiln. Anyone who intends to make fired clay bricks in a remote location needs to know how to construct a kiln in which to fire the initial batch of bricks. Such a kiln may also be the convenient and practical way to test the quality of the clays from selected deposits in the area for the manufacture of ceramic products.

Large Country Kilns:

Large country kilns have been used in many parts of the world, and although they are not as efficient as permanent kilns, millions of bricks have been produced in them. Fuel consumption has been a problem, since many country kilns are inefficient and waste precious wood. Properly designed, however, their efficiency can be raised considerably, and their fuel consumption can be maintained at or near the levels reached in more modern firing systems. The relative lack of controls on burning, compared with other production methods, as well as the fumes emanating at ground level, have often made these kilns unpopular when located in or near residential areas.

Small Country Kilns:

At this point in history, small kilns are very useful in Uganda. A small kiln is suitable for use by the small contractor to fill his building needs or by a farmer to supplement his income while his crops are growing. A small kiln can be the first stage of development of a small brick factory, and in fact is a small factory.

The design and performance of a small country kiln are interesting, due to the well-insulated walls. Their design not only effects savings in fuel

consumption, but also promotes a uniformity of firing in the bricks, as is evident when such a kiln is dismantled.

A small country kiln can have a capacity ranging from 2,000 to 10,000 bricks. For a kiln designed to produce 4,000 bricks, the external dimensions are 2 meters long by 1.5 meters wide, and a maximum height of 2 meters, equal to 20 layers of bricks placed on edge. A single firehole runs the length of the base of the kiln, though it is open at one end only. This firehole is approximately 500mm wide at its base by 400 mm high, or in other words, two brick lengths wide by four brick widths high at the middle.

The bricks of the first five layers are laid with their stretchers across the kiln (length-wise). Above this, the bricks have alternating direction, that is, either laid parallel to the length of the kiln, or across it. Up to the twelfth layer, length and width are constant. Above that, the kiln tapers in a pyramid shape to the twentieth or topmost layer.

Surrounding the kiln on all four outer sides, up to the twelfth layer, are other sun dried bricks. These form a double cavity insulating wall. The inner cavity is continuous, and filled initially with coffee or rice husks, sawdust and woodchips, or other agricultural residue. These are heaped on the other parts of the kiln, as well, to provide additional insulation. Eventually the residue burns during the firing process, but by that time it has served its purpose, and the resulting ash continues to conserve the heat in the kiln.

Woodlogs are burned in the firehole. The amount of fuelwood consumed is approximately 60 to 75 meters for every 20,000 bricks. To reduce the cutting of standing timber, it should

be possible to add sawdust/woodchips, coffee/rice husks or other agricultural residues, to supplement fuel requirements and reduce the volume of firewood which must be burned to maintain adequate heat levels.

The fire is built up slowly while the remaining moisture in the bricks is being expelled, in what is known as the "water smoking" period. After this the intensity of the fire is increased. The addition of fuel lasts for approximately two to four days, and then the firehole is blocked off. The kiln is allowed to burn itself out and to cool down.

During firing the sides of the kiln feel only slightly warm, demonstrating the effectiveness of the insulation. Heat escapes only from the top. Obviously, the bricks forming the cavity walls are not properly fired, but they can be used again for the same purpose, or else placed inside the kiln to be fully fired the next time the kiln is used.

Usually the kilns have the disadvantages of lack of control over the firing. In windy conditions, the burning may be too fierce and cause partial melting or slagging of the bricks. A remedy for this is plastering the exterior with mud to prevent drafts, and this is fairly common, but this means that the "plastered" exterior bricks are ruined and not worth refiring.

The country kiln is usually so well insulated that once the operator has learned, by experience, how much fuel to use, the burning proceeds uniformly in any kind of weather conditions. During the rainy season, a roof can be added above the kiln. Simple pole frame construction with palm or banana leaves, papyrus or thatch will make an adequate roof.

Apart from items such as a simple

roof, little or no capital investment is needed, which is a main advantage of the country kiln. The process, from moulding the bricks to unloading finished bricks from the kiln, need take no more than three weeks for a 4,000 to 10,000 brick kiln.

For those responsible for small-scale projects in remote areas, once a source of mouldable clay of low shrinkage has been located, the most convenient means of completing an evaluation of the local raw materials may be simply to fire some brick in a country kiln. It is an appropriate means of getting production started when the capital for construction of a proper permanent kiln is lacking, as it often is.

Kiln Construction

Firing the kiln is the end-point of the brick-making process, and is the component which governs whether or not the bricks will be durable and strong. At the point when firing begins, money, time and effort have been expended to making bricks of good quality, and therefore it is very important to remember three main points: (1) fire only good bricks, not cracked or badly shaped bricks; (2) use good quality fuels for burning; and (3) build an efficient kiln.

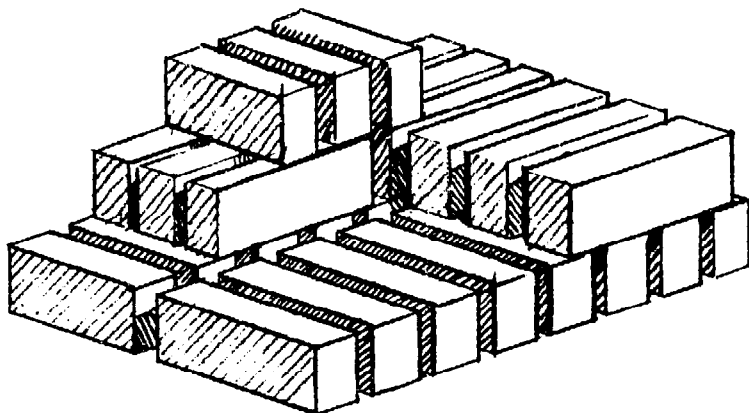

BRICKS BEING PILED IN THE KILN.
LEAVE AT LEAST $\frac{1}{2}$ " SPACE AROUND
EACH BRICK.

Figure 12A

In constructing a kiln, begin with well drained, dry ground. A fired brick foundation can also be used as a base for the kiln. A brick base is effective as an insulator. It can be leveled easily, and avoids mud and excess dampness in wet weather.

The overall length and size of the kiln depends on the number of bricks to be fired. The width of a country kiln should never be greater than 15 to 20 feet, mainly because fuel consumption increases with the size of the kiln, and size increases labor, costs and construction time. In Uganda, the width of an average kiln of this kind is 8 to 12 feet, once again depending on the number of bricks to be fired.

A country kiln consists of three parts:

- 1) The legs, which form the lower section around the fireholes;
- 2) The main setting or body, which forms the bulk of the middle section of the kiln, which is built by alternating rows of headers and stretchers (bricks laid lengthwise and endwise on alternating rows), with spaces between the rows of headers. (Fig 12C).
- 3) The outer cladding or shell, which is made by bricks set close together around the outside and the top of the kiln, and sealed with mud. This forms an insulating casing around the main body of the kiln.

GROUND PLAN OF BRICK KILN

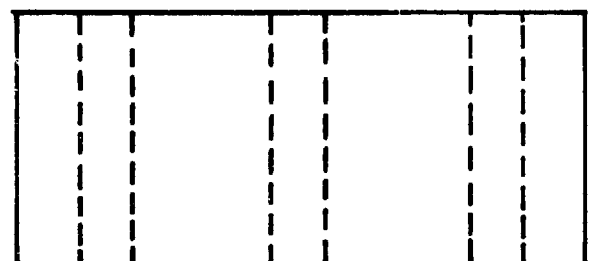

FIRING CHAMBERS

Figure 12B

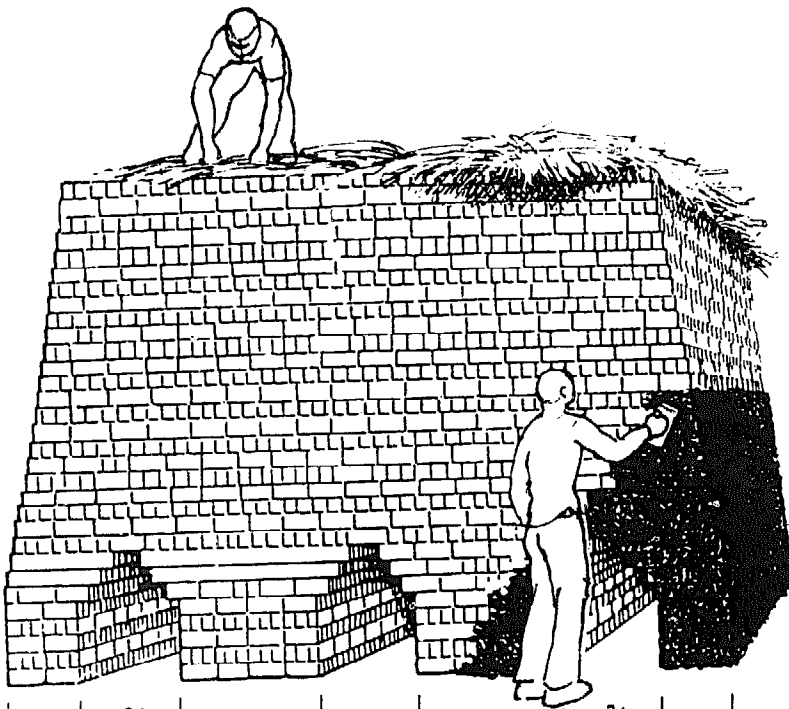

Figure 12C

2	2 ² / ₃	4	2 ² / ₃	4	2 ² / ₃	2	← Width in brick lengths
18"	24"	36"	24"	36"	24"	18"	← Maximum width, in inches
457	610	914	610	914	610	457	← Maximum width in millimetres

Construction of the kiln is started by setting out the first 5 layers or courses for the legs, beginning with a stretcher, breaker, stretcher, and breaker until the 5 courses are completed.

The next 3 courses are corbelled (see figure) to form arches over the tops of the fireways.

From the 9th course up to the last 2 courses, each row of stretchers and headers has a 1/2 inch space between the bricks. Each alternate course from the 9th row up is set at right angles to each other, which has the effect of making a checker-work of bricks allowing heat to pass through and keeping the bricks in good shape. The last two courses are set closer together to help hold the heat, but in such a way that they are not too air tight, keeping heat from flowing properly upward.

A basic height for the kiln is 12 to 15 courses, but can be built higher to accommodate a larger number of bricks.

The outer casing or layer is built of old bricks and mud, and can include coffee and rice husks, or sawdust or chips mixed with the clay and mud.

Kiln Operation

In a large country kiln, while burning 10,000 or more bricks, the dry bricks are stacked on edge about 2" apart in rows so that the fire and heat can reach all the bricks and as evenly as possible. According to the number of bricks required, one or more firing chambers are formed by arching the dry bricks to make a tunnel about 30" wide and from 15 to 20 feet long. The bricks in the kiln should be spaced so that there is at least 1/2 inch of room between the end and sides for circulation.

The firing of the kiln should be done well in advance of the planned construction job. The bricks must all be thoroughly dry before being inserted into the kiln. The mud plaster which is coated on the outside of the kiln should be quite dry before the kiln is fired. After firing, the kiln will take some time to cool, even after the plaster is removed.

Gather plenty of firewood to avoid the possibility of running short of fuel during the firing period. Care should be taken to try to locate the driest fuel. During the actual firing period, one person will have to be on duty all night. Four days may be sufficient for the burning of 20,000 bricks, but a larger number of bricks may take longer. The variables here are (1) the number of bricks being fired; (2) the efficiency of the kiln and the fuel; and (3) the uniformity and intensity of heat in the kiln. A certain amount of trial and testing is necessary to establish suitable timing. The openings to the fire chamber should remain fairly well closed except when the fires are being stoked.

To begin the firing process, fill the fireholes or fireways with kindling wood at the bottom, and add heavier fuelwood as you build to the top of the firehole.

The fireholes are lit at both sides of the kiln, except in the case of anthill kilns, which are only open on the front side. As soon as the fire is burning freely, the openings are bricked up, leaving a small hole in each fireway for air flow. (Larger air holes are required in anthill kilns to allow sufficient oxygen to feed the fire evenly, and for circulation).

During the first 24 hours of the firing process, it is very important to burn the fuel slowly. This is done by using kindling, medium-sized wood and wood pieces, plus coffee and rice husks. The purpose of initial slow burning is to cause the remaining moisture in the bricks to evaporate at an even rate rather than rapidly to avoid cracking and damaging the bricks.

After this stage, when steam and vapor is no longer escaping from the

kiln, open the fireways and add major firewood to the bed of coals, seal up again with bricks (leaving air vents open for necessary air flow), and allow kiln to burn vigorously.

This process will take from 2 to 4 days, with fuel being added as needed night and day. The objective is to keep a strong fire and high temperature at all times, and to bring each brick to a level where it is red hot for an extended period of time. The actual length of this intense burning process depends on kiln size, type of fuel and its degree of wetness or dryness, weather conditions, and the efficiency of the kiln.

After this intense firing process, the fireholes are sealed up with bricks and mud and the kiln is left to cool down gradually for about 36 hours.

After the burning process, remove plaster when it is cool enough to be handled. When the bricks are cool enough to be touched and handled, be sure they are carefully sorted out. The best burned bricks are used for the outer faces of the main walls, and the least well burned bricks are for partition walls. If burned bricks are made for exterior walls only, the best ones are used for the lower part of the wall, or that part which is most exposed to water. Generally, the upper part of the exterior wall is protected by the overhang of the roof.

Burned bricks are often more brittle and fragile than unburned mud bricks. Therefore they must be handled carefully. When the time comes to start building the walls, burned bricks should be drenched with water just before being laid in the wall, particularly when cement mortar is being used, because a dry brick soaks up the water in the mortar mix and causes the mortar to harden and set too quickly.

Kiln Fuels:

Wood (timber): Eucalyptus is very commonly used in East Africa; wood chips from a local sawmill are also very useful. The size of the timber should be 4" to 8" in diameter, and the wood should be dried for 3 to 4 weeks before being used as a kiln fuel. Dryer fuel wood will provide hotter temperatures and more efficient burning.

Coffee husks: Can be used to start the kiln fire. This is a good source

of fuel if you own the coffee husks and do not have to pay for them, or for the transportation of them. The husks provide a fast heat, but not for a great length of time, and thus build up coals quickly.

Papyrus: Can be used in burning, as in the case of coffee husks, if the kiln is in a region where papyrus is plentiful. Papyrus burns quickly, and is not economical to transport. However, it can be used satisfactorily to begin the firing process along with wood chips and coffee husks.

Selection and Identification of Wood and its Usage

The selection of timber and lumber for construction depends largely on the character and quality grade of materials carried in stock by local dealers, or upon the materials which the builder may be able to obtain by his own means. Nevertheless, a basic knowledge of the best kinds of wood for special purposes will be very useful, particularly when important work is being undertaken, and the best results are desired.

Light framing material is usually selected from woods that are plentiful and cheap, while heavy framing, whenever possible, should be made from timber which has both strength and durability in the highest degree.

Since the exterior trim of buildings is subjected to extremes of temperature, and to wind and rainstorms, a durable material that is easy to work with and is least influenced by these changes should be selected. The

fibers should be firm and elastic, without being brittle, sufficiently tough to avoid splitting when being nailed into place, and to avoid warping and cracking after being erected.

Where wood is embedded in concrete or masonry, or is buried wholly or partially in the ground, the primary consideration is durability.

For floors which will be subjected to heavy work and traffic, the durability and wearing qualities are primary considerations.

When interior finish is to be painted, any sound material that will hold glue or wood finish, and stand up well may be used, but where the wood is to be finished in its natural color, by varnishing or waxing, its color, texture and quality of grain will usually govern the selection.

Wood For Special Purposes: The following list will serve as a guide in selecting and specifying the different kinds of wood for special requirements. These species are specific to Uganda, and are ranked in order of preference based on durability. (Other countries or regions can fill in each category with local species).

Light framework, small trusses and scaffolding: EUCALYPTUS, ENKAGO.

Heavy framework, large trusses: EMPERWERE, MUSIZI.

Long timber, i.e., flagpoles, pole beam for a jig hoist: EUCALYPTUS.

Exterior trim: MUSIZI, PODO.

Posts and sleepers in concrete or in the ground: MAWASA, EUCALYPTUS.

Piles: ENZO, EUCALYPTUS.

Solid framed doors, sash and wainscoting: NKOBA, OMWASA, MUSIZI.

Parquet flooring: MUGAVU, NKOBA.

Interior trim: ENKAGO.

Furniture: NKOBA.

Counter and table tops: NKOBA.

Timber Species Most Commonly Available and Used in Uganda: (Other countries or regions can match local species in the various categories).

Hardwoods:

MWASA -	plentiful
EMPEWERE	plentiful
EUCALYPTUS	plentiful
MUGAVU	plentiful
ENZO	plentiful
NKOBA	available but not plentiful
OMWASA	plentiful

Softwoods:

ENKAGO	plentiful
MUSIZI	plentiful
PODO	plentiful
MUSENENE	plentiful
MUTUBA	plentiful, used for bark cloth

Softwood Identification: In most of the varieties, look for:

- 1) Needle shaped leaves
- 2) Evergreen
- 3) Trees bear pine cones for seeds
- 4) Smaller in diameter, 300-450mm.

Hardwood Identification:

- 1) Broad leaves
- 2) Shed leaves once each year
- 3) Trees bear acorns, nuts
- 4) Larger in diameter, 750-1800mm.

As Processed Timber or Lumber:

Softwood:

- 1) Light in color
- 2) Light in weight
- 3) Easy to work with, plane, shape, carve.
- 4) More elastic
- 5) Relatively cheaper to buy
- 6) Mainly used for carpentry work and general joinery.

Hardwood:

- 1) Dark in color
- 2) Heavy in weight
- 3) Difficult to work, plane, shape, carve.
- 4) Less elastic
- 5) More expensive to buy than softwood
- 6) Used as much as softwood in many cases for joinery, due to beautiful natural appearance.

Wood Treatment: to stop termites, and woodrot caused by damp weather: (local treatment of timber without importing expensive materials).

Heat treatment for piles/poles:

Put the lower part of the log or pole that is to be buried in the ground into hot coals until the outer bark is hard and turns a black color. Continue to rotate the log until it is finished on all sides. This process should only take 2 to 3 hours in dry weather.

Used engine oil:

Bury a 200 liter drum 3/4 of the way into the ground. Fill the drum with used crankcase oil. Lower the log or pole into the drum and let it soak for several hours. If a drum is not available, simply paint or rub the used oil onto the log or pole with a rag or a local paint brush.

Drying and Stacking Wood:

In many parts of the world, dry, well cured lumber is seldom available, particularly in rural areas. In parts of Uganda, for example, one must travel over a wide area to procure sufficient standardized lumber of good quality for construction. A builder should plan well in advance, procure sufficient lumber for his needs early and dry it properly.

There are two characteristics of moisture and evaporation in newly processed timber, which the builder should know:

1) Fibre Saturation Point: After cutting and drying, the timber still has 25% to 35% moisture in the cell walls. This moisture tends to stay with the lumber for many years.

2) Equilibrium Moisture Content: refers to moisture in the wood due to atmospheric conditions. In the rainy

season, the wood will tend to draw in additional moisture. During the dry season there will be less moisture in the wood.

Drying lumber (timber) is the removal of water from the timber. Most builders know that it needs to be thoroughly dried before it can be transformed into a useful product. The twin goals of drying are:

- 1) Reducing moisture content (M.C.) to a level consistent with the atmosphere within which the finished lumber will be used, and,
- 2) To avoid damage to the material during the drying process, such as cracking, warping and splitting.

The objective is to allow wood to do its shrinking and drying before it is used in construction or framing, rather than after the woodworking or manufacturing process.

In stacking and storing lumber, there needs to be plenty of air circulation. The following drawings illustrate proper ways to stack lumber for drying and for storage.

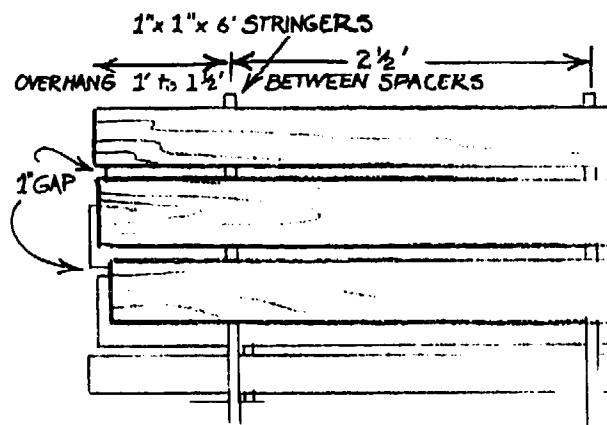

Figure 13A

1" x 1" x 6' stringers are placed between each layer of boards to allow air circulation. Bottom layer is placed across evenly planed logs to protect from ground moisture.

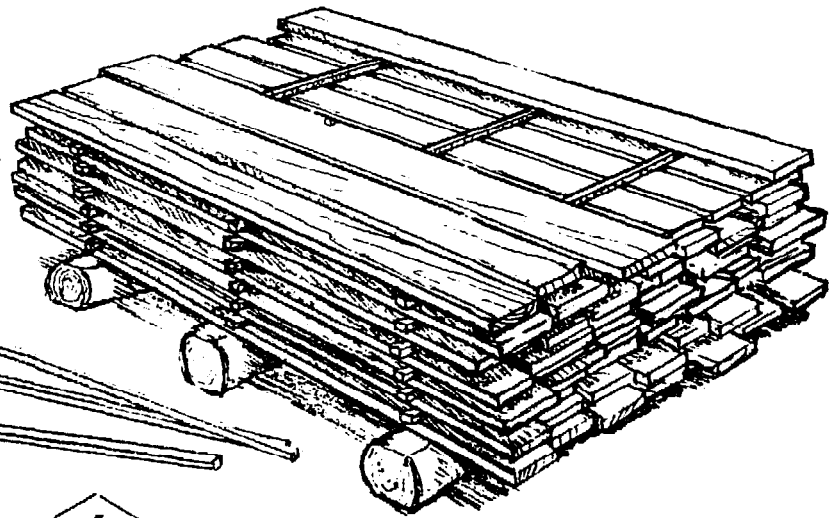
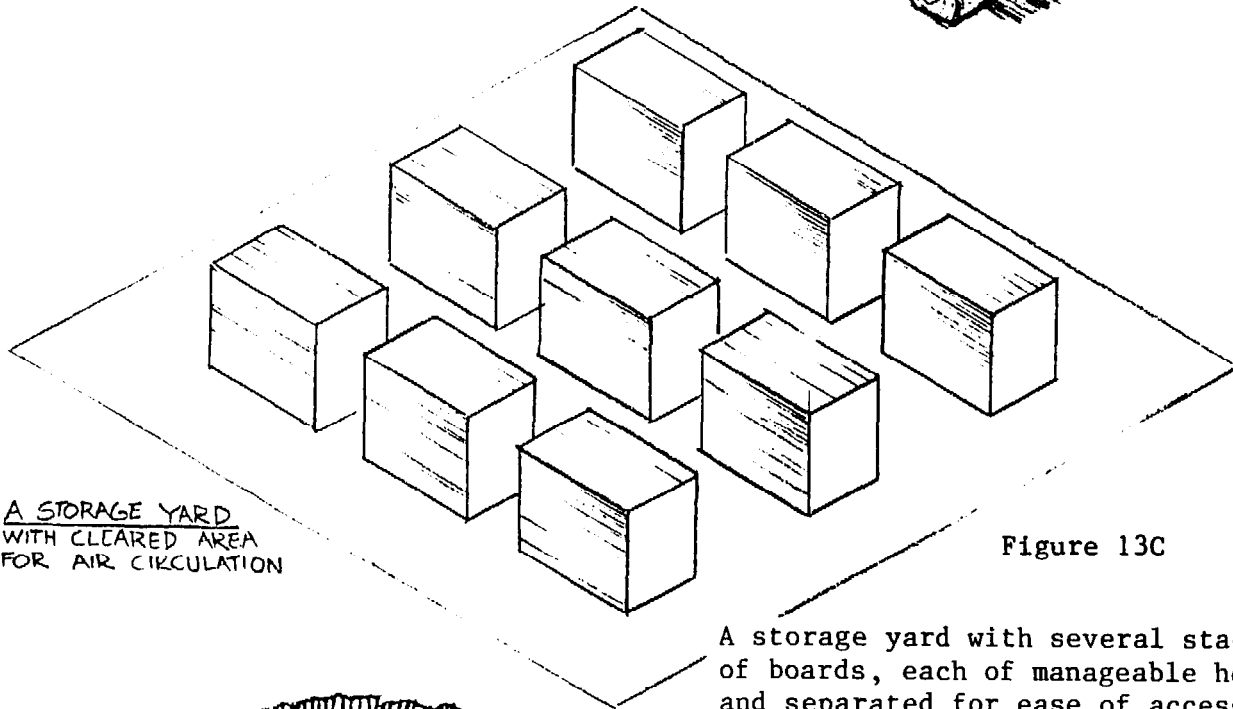

Figure 13B



A STORAGE YARD
WITH CLEARED AREA
FOR AIR CIRCULATION

Figure 13C

A storage yard with several stacks of boards, each of manageable height, and separated for ease of access and for adequate air drying and sunlight.

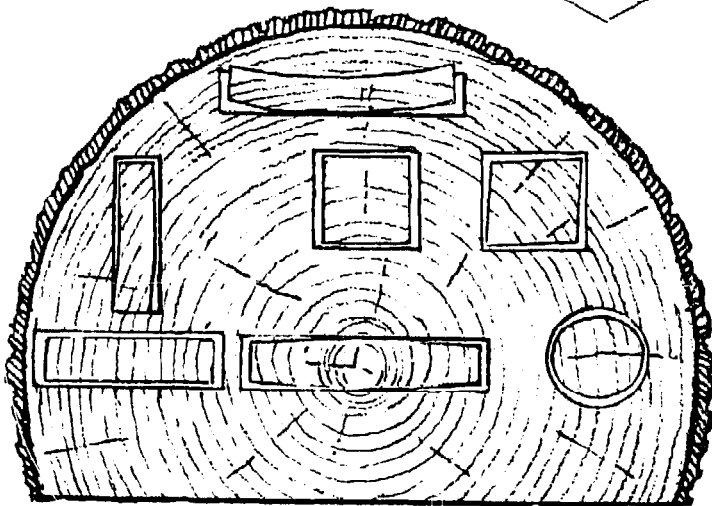

Figure 14

Characteristic shrinkage and distortion of flats, squares, and rounds as affected by the direction of annual growth rings. The dimensional changes shown are somewhat exaggerated. (From Air Drying of Lumber: A Guide to Industry Practices, Agricultural Handbook No. 402).

CHAPTER II

BASIC BUILDING COMPONENTS

Introduction

A house which is satisfactory on one site may not be as practical, useful or appropriate in another setting. Therefore it is unwise to make final decisions on building design until the actual site has been secured, and all its important features are known. A builder should gather information about the conditions on and around the housing site in all seasons, with respect to its suitability in these categories, among others:

1) Health: Temperature, humidity, altitude; the timing, value and direction of winds; soil erosion; swamp; rainfall; the prevalence of disease; proximity to unsanitary conditions over which the builder has no control; depth of soil; the presence of large masses of rock which radiate heat; the presence and value of trees; whether the site is on a hill, or in a plain or valley; its proximity to other buildings, and the character of those buildings; the availability of safe drinking water, and also health and medical care.

2) Work: Accessibility to and from other people, centres of population and appeal; proximity to place of work, or to other work opportunities; government favour.

3) Building conditions: Inquire about supplies, labour, weather, the building by-laws, restrictions, and the plans for future developments in the area. Occasionally a site or area is found which is quite unsuitable for building a house or a compound, for one or several of these reasons.

4) Environment: This is particularly important in areas where many houses and buildings have been built already. The builder, when planning for a site, should take into consideration the proximity of the site to congested areas, and such factors as noise, traffic, fumes, and general cleanliness and sanitation; roads, rivers, nearby institutions, schools, and public transportation are also to be considered.

Once these issues and the necessary legal or title documents are worked out with the appropriate authorities, the builder can begin. The following pages describe some of the basic elements of construction, making use of locally available materials.

FOUNDATIONS

The choice of foundation type depends upon the nature of the site, soil, climate, style of the building, the local construction codes, the available materials, the skills of the builder. Some types of foundations:

Concrete Perimeter: (Figure 15).

Advantages:

- 1) Conforms to most local codes
- 2) No engineering required
- 3) Monolithic, solid, resists tremors
- 4) Crawl space protected from weather and debris
- 5) Good in most soils
- 6) Good on level sites

CONCRETE PERIMETER (WOOD FLOOR)

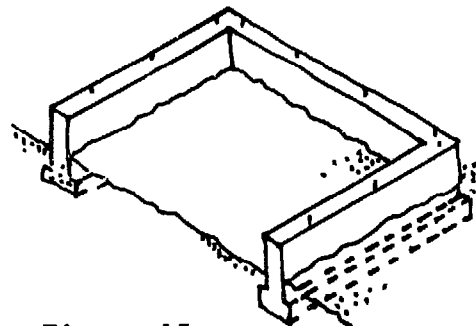

Figure 15

Disadvantages:

- 1) Careful framework essential
- 2) Considerable excavation needed
- 3) Requires volume of on-site concrete mixing

Concrete Piers: (Figure 16).

Advantages:

- 1) Minimal excavation and formwork
- 2) Good on sloping or steep sites

Disadvantages:

- 1) Leaves underside of house open
- 2) Engineering often required for codes.

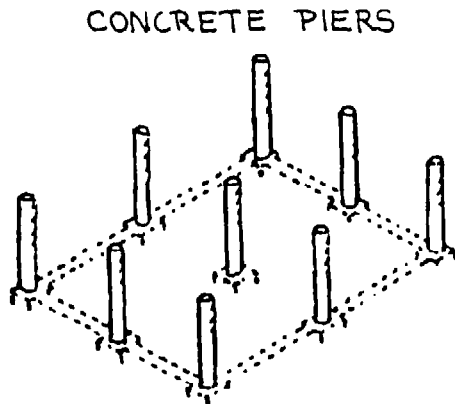

Figure 16

Concrete Slab: (Figure 17).

Advantages:

- 1) Same as concrete perimeter and piers, plus,
- 2) Floor close to ground level
- 3) No floor or foundation rot
- 4) Water will not damage floor, easy to wash

Disadvantages:

- 1) Not adaptable to steep site
- 2) Damp and cold if improperly built
- 3) Requires fill where high water table exists
- 4) Requires considerable on-site manpower and skill to mix, pour and finish.

CONCRETE SLAB

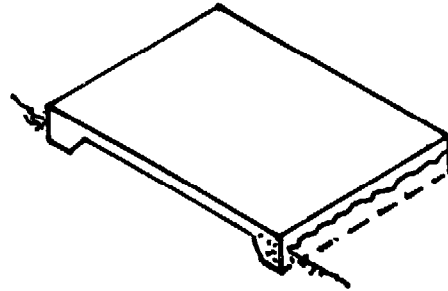

Figure 17

Wood Poles: (Figure 18).

Advantages:

- 1) Good on slopes and steep sites where no cement is available
- 2) Does not require excavation or disturbance of site
- 3) No cement forms needed
- 4) Practical in remote areas

Disadvantages:

- 1) Poles will rot eventually, but can last up to 75 years with proper treatment
- 2) Not good in soft, wet soils
- 3) Deep holes may be difficult to dig, depending on site, sub-soils
- 4) Leaves underside of house open.

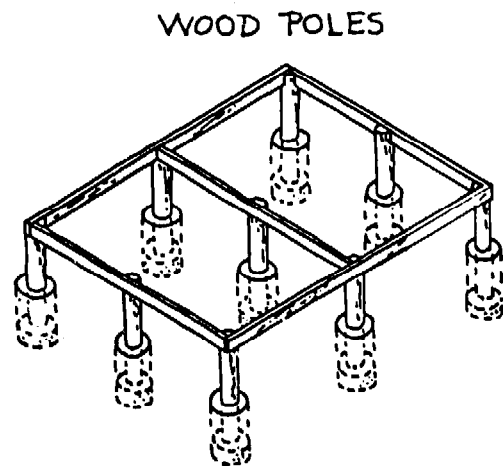

Figure 18

The following section provides information about each of the four types of foundations mentioned here.

LAYING OUT A FOUNDATION

The diagrams below illustrate some of the important aspects of accurately laying out a foundation.

Shown in the diagrams are batter boards. These are set back about 4' from the building lines to support the strings which provide the accuracy in layout which is essential in order to avoid problems later on. The strings can be removed when working, digging, and building forms, and then reset to check measurements.

Procedure:

Using a 3-4-5 (6-8-10) triangle to get right angles, lay out a rough outline of the building with corner stakes.

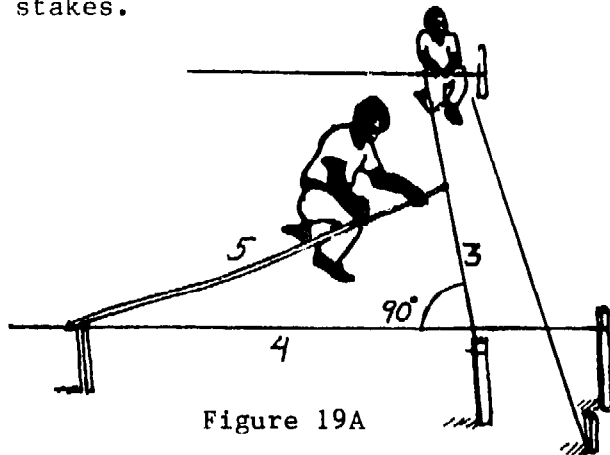

Figure 19A

Drive three stakes about 4' back from the corner stakes for batterboards, as shown in the diagram. With a level, water level, or line level, mark the stakes all at the same level.

Nail boards (1 x 4s) onto the stakes at the level marks, and brace all boards to prevent movement.

Lay out exact measurements of the building, using nylon string, if available, or other string, with loops stretched between nails on the batter boards. Use 3-4-5 triangle to get four strings in place, and then check diagonals, adjusting the

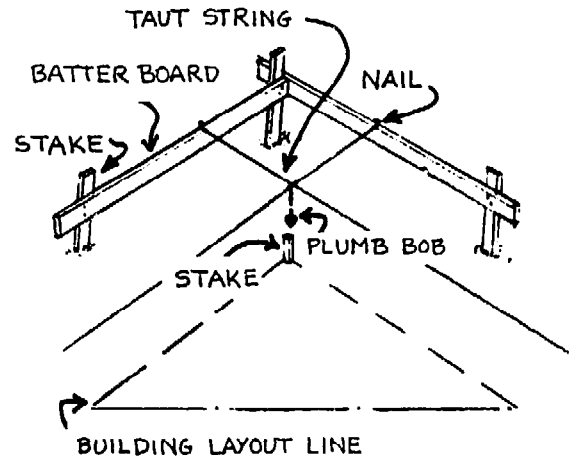

Figure 19B

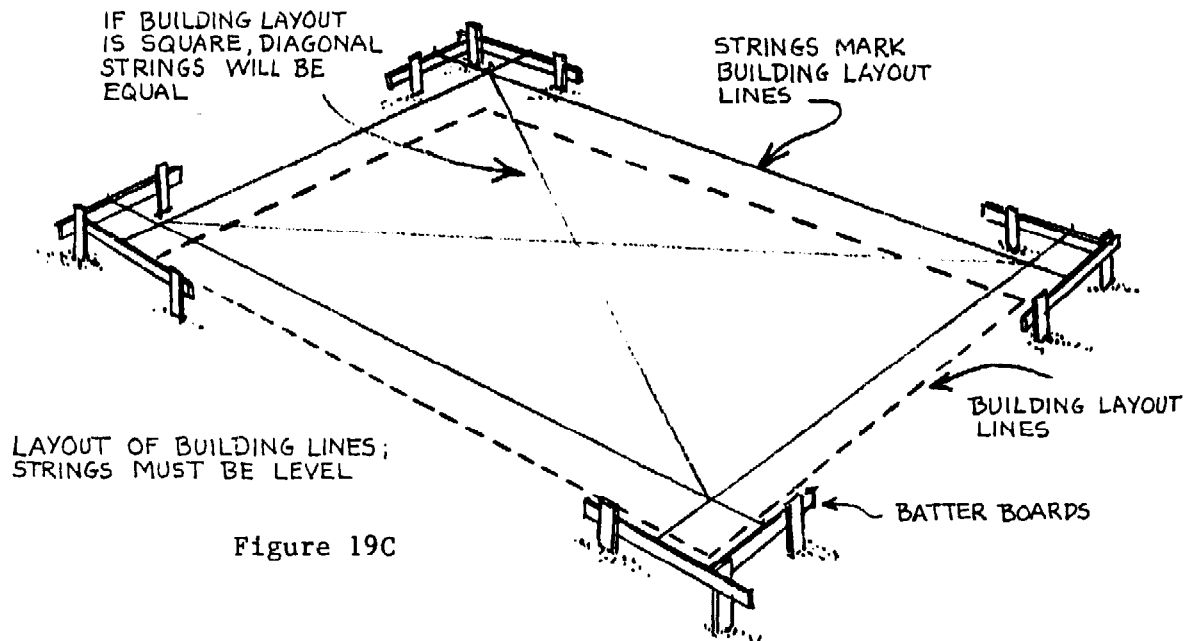

Figure 19C

strings until measurements are accurate. On sloping building sites, the batterboards will need bracing.

Water level: Use a length of garden hose, with a short section of clear plastic tubing taped onto each end (it must not leak). Cap one end when moving the hose. Ends must be open when reading level. The water in the hose will seek its own level and will give accuracy readings to within 1/16" in 100 feet. (Figure 19D).

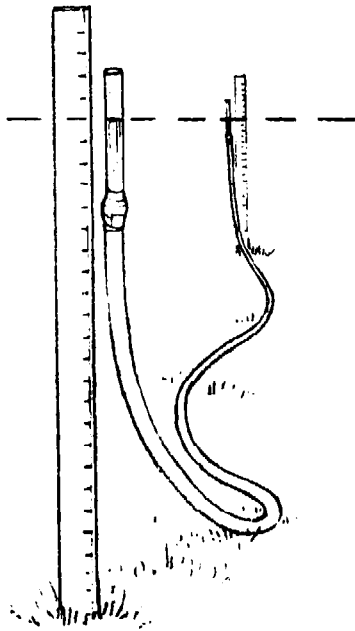

Figure 19D

A. Concrete Perimeter Foundation

The basic parts of a perimeter foundation are the footings, which spread the weight of the building uniformly over the ground and the stem wall, which supports the floors and walls above the ground level.

Note: interior weight-bearing walls which support the weight of the roof must be supported by continuous footing with stem wall and mud sill, or pre-cast piers, girder or beam.

No. of storeys	1	2	3
----------------	---	---	---

Thickness of foundation wall in inches	6	8	10
Width of footing-inches	12	15	18
Thickness of footing in inches	6	7	8
Depth of footing below grade(surface)-inches	12	18	24

Inexperienced builders may find it easier to first pour the footings, then build forms for stem walls on top of the footings, after the concrete has set. Experienced builders usually pour footings and stem walls at the same time.

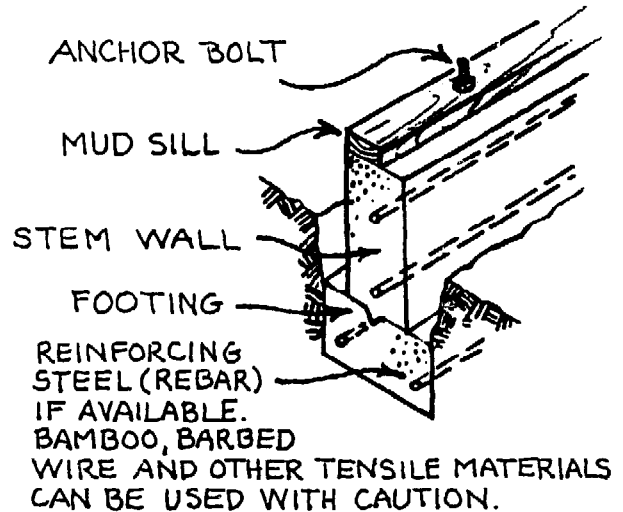

Figure 20A

HILLSIDE SITE: FOOTING AND STEM WALL ARE STEPPED.

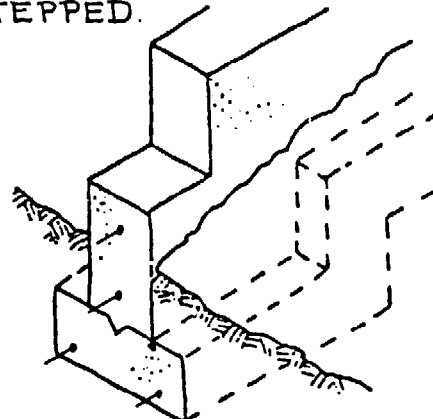
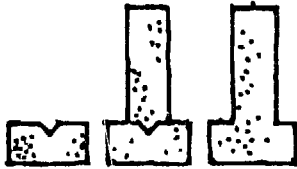
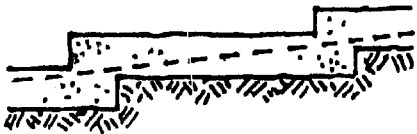

Figure 20B



LEFT: FOOTING WITH KEY
 MIDDLE: STEM WALL POURED
 ON TOP OF FOOTING
 RIGHT: FOOTING AND STEM
 WALL POURED SAME TIME

Figure 20C



REINFORCING STEEL:
 SHALLOW STEPS, AS ABOVE;
 STEEPER STEPS, AS BELOW.

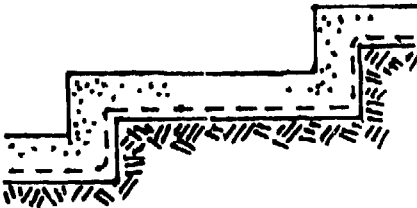
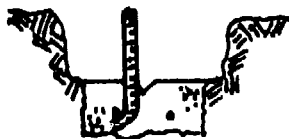
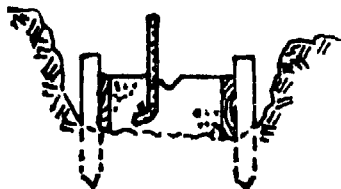

Figure 20D

FOOTINGS MUST BEAR ON
 UNDISTURBED FIRM SOIL



FIRM SOIL: NO FORM BOARDS
 REQUIRED. POUR CONCRETE
 DIRECTLY IN TRENCH.



LOOSE SOIL: FORM BOARDS
 REQUIRED. A 2x2 IS PRESSED
 INTO THE WET CONCRETE
 TO FORM KEY.

Figure 20E

Excavating, Pouring, Forms:

Using strings, mark lines on ground for digging, with lime or powdered chalk. Careful digging can save concrete. Throw the dirt well back from the building lines to leave ample room for working. Be sure the bottoms of the trenches are level by checking with a carpenter level placed on a board or 2" x 4".

Pouring: Reinforcing steel, if available, or old fencing wire or other metals should be in place about 3" above the bottom of the trench, at least 2" from sides of wood forms. Wet the earth in the trench before pouring concrete so that the dry soil will not draw moisture out of the concrete.

After pouring, smooth off and level the top of the footing (upon which the form wall will rest). Put a two by two on edge in the wet concrete for a key to level. Be sure there is vertical steel (hooks under horizontal steel) every 18 inches.

Building forms:

The forms for the stem wall are built on top of the footing, which has a key and vertical steel, to tie footing and wall together. Forms are filled with concrete to the top. Thus forms must be accurate in height as well as horizontal measurements. The 2" boards commonly used for form lumber, are later stripped away from the forms and used as joists.

Steel form ties are commonly used to hold forms together while forms are under pressure from concrete. They remain under the concrete after it sets. The ends are broken off after forms are stripped away. Wire or wood batts can also be used to hold the forms in place.

Procedure:

- 1) Using strings, build outside forms first. Use builder's level or water level to make sure the forms are level all around. Use blocks or stones to raise forms if necessary.
- 2) Check diagonals; adjust if necessary; accuracy is important here.
- 3) Insert steel ties, wire or wood batts.
- 4) Bend horizontal steel and lay in place before adding inside to form.
- 5) Build inside forms.
- 6) Raise and tie steel as forms are built.
- 7) Suspend anchor bolts in place.

Reinforcing Steel: Depending on wall height, two or more 1/2" bars of reinforcing steel (rebars) are hung inside forms with the wire from the steel ties. (Figure 21A and 21B).

**BUILDING FORMS ON TOP OF
ALREADY POURED FOOTING**

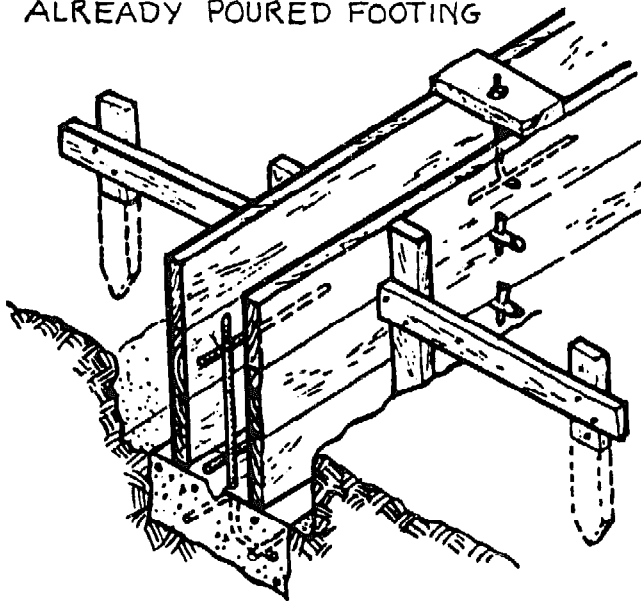

Figure 21A

**BUILDING FORMS WHERE
FOOTING AND STEM WALLS TO
BE POURED AT SAME TIME.
(FOR BUILDERS WITH SOME FORM-
BUILDING EXPERIENCE.)**

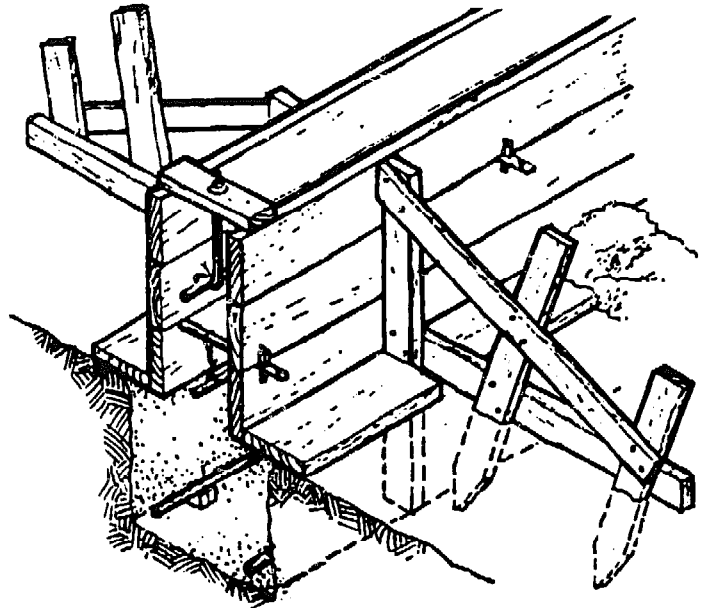

Figure 21B

Pouring Concrete:

Formula when mixing it yourself: 3 parts gravel; 2 parts sand (sea sand is best); 1 part cement. The less water, the stronger the concrete. Keep it stiff.

Procedure:

- 1) Have 3 or 4 helpers with as many shovels. Rubber boots and wood floats are needed, and a large wheelbarrow is very useful.
- 2) Spray or sprinkle the ground and forms with water just before concrete is poured.
- 3) Pour in layers. Pour bottom of the form all the way around first. This gives it time to set up, and minimizes pressure and leaks.
- 4) If concrete starts oozing from the forms, it can often be stopped by shoveling dirt against the side of the form that is leaking, and pouring at some other point along the form for a while.

5) Tamp or puddle concrete in forms with a 1 by 4 to ensure good fill and to eliminate spaces.

6) Tap side of forms with a hammer for smooth surface.

7) When form is full, trowel off the top smoothly. The mud sill will rest here. Check anchor bolts for right height and vertical angle.

8) Clean off all tools immediately.

9) Strip form after 24 hours. Keep concrete covered and damp for three to five days.

Openings in Concrete: An opening in a concrete wall must be blocked out in the formwork before the pour. These are usually rectangular openings with stringers left in. Vents and apertures can have many uses, and use determines the size needed: crawl space to allow one to get under the building; vent opening for good ventilation to help minimize termite and dry rot damage; vents for plumbing and wire openings.

GIRDER SUPPORTS

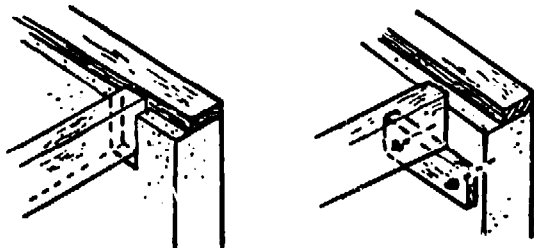

LEFT: POCKET FORMED BY BLOCKING OUT INSIDE FORM.
RIGHT: ANCHOR BOLTS HOLD TREATED WOOD SUPPORT.

Figure 22A

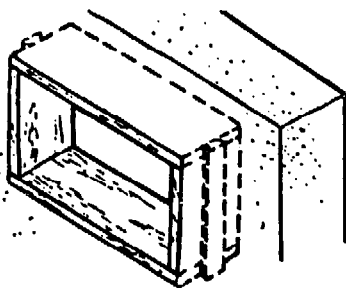

Figure 22B

B. Concrete Slab Floors

If well built, a concrete slab floor need not be damp and cold. Concrete has a high heat storage capacity and can be built to avoid dampness.

Procedure:

1) First build a standard footing and stem wall up to a desired height. Omit all vent and crawl space openings, but allow for sewer, water and electrical lines, which must be installed in the floor and/or foundation wall before concrete is poured.

2) Remove all organic material from the floor area.

3) Put down 4 to 6 inches of one and one-half inch gravel.

4) Roll out 6" by 6" welded wire mesh, or place 3/8" rebar 18" on center each way, if available.

5) Install any plumbing, wiring or pipes where they should be in the concrete.

6) Set anchor bolts.

7) Set wood screeds either temporarily or permanently.

Note: Interior bearing walls on slab floor must be supported by footing the same size as exterior footings.

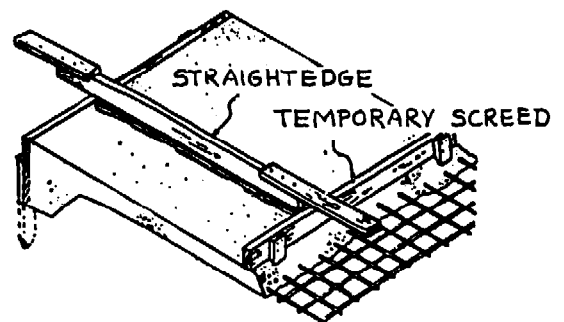

TEMPORARY SCREED IS STAKED ABOVE SLAB LEVEL FOR EASY REMOVAL AFTER POUR. MAXIMUM EFFECTIVE LENGTH FOR STRAIGHTEDGE IS 10-12 FEET; USE TEMPORARY SCREED AS ABOVE WHEN POUR IS WIDER.

Figure 23A

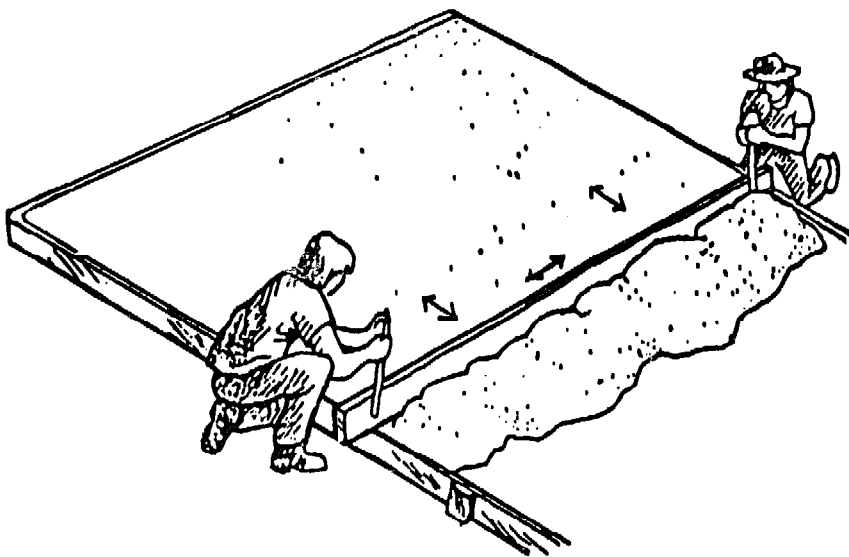

STRAIGHTEDGE IS WORKED BACK AND FORTH TO BRING CONCRETE TO ROUGH FINISH LEVEL. AFTER THIS, USE WOODEN FLOAT, THEN STEEL TROWEL TO FINISH. PULL MESH UP DURING POUR (IF AVAILABLE).

Figure 23B

The Concrete Pour (Brief Instructions):

- 1) Pour 3 and 1/2" finished floor.
- 2) Rake off level with a 2 x 8 resting on screeds.
- 3) Smooth off with large wood float. A film of water will rise to the surface. When this evaporates, the slab is ready for the steel trowel.
- 4) Continue trowelling until surface is smooth and hard.
- 5) In hot weather, shade your newly poured concrete if possible.

C. Cast in Place Concrete Piers

The main advantages of piers are the minimal formwork necessary, and their suitability to sloping sites. There are three ways to utilize them:

- 1) With regular footing, if height of the concrete pier is less than three times the diameter of pier, and if piers are spaced six feet apart.

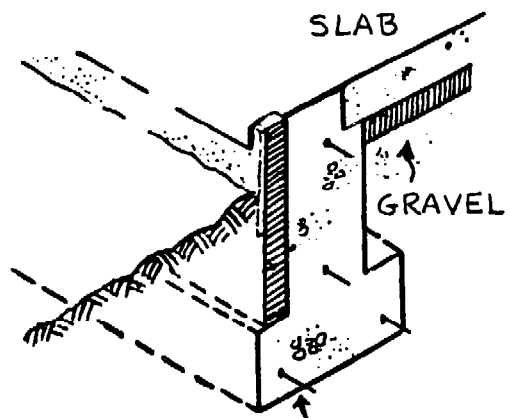

REINFORCING BARS - TYPICALLY STEEL, HAVE USED BAMBOO AND BARBED WIRE.

Figure 23C

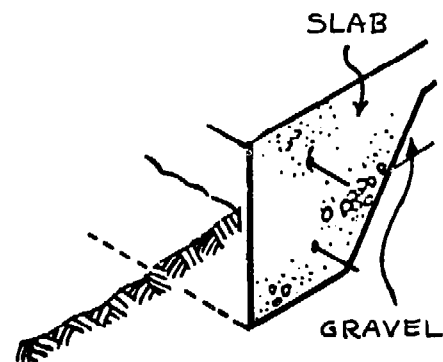

Figure 23D

- 2) With a grade beam, that is a steel-reinforced concrete beam at ground level that acts as a bridge to tie all the piers together.
- 3) With deep holes and no connecting footing or grade beam. In this case, the weight of the building is partially supported by friction of the soil around the piers. Holes are usually six feet to twelve feet deep depending upon soil conditions and the height of the pier above ground. It may be advisable to get some help from an engineer in this case.

The following is a simplified system for using concrete pier foundations:

- 1) Check with local builders regarding footings, footing sizes and depth needed.
- 2) Dig footing trenches.

3) Enlarge footing trench around each concrete pier. If the site is flat, forms are probably not needed. If the site is steep or sloping, stepping may be required. (Figure 20B).

4) Lay 2 pieces of steel in trench, supported about 3" above ground.

5) Wire 4 pieces of vertical steel in each pier area. (Figure 24B).

6) Pour trenches.

7) The next day, place forms over pier locations. Plumb them at the desired height, and brace with 1 x 4s if necessary.

8) Insert vertical steel with 2" at top for the insertion of anchor straps for posts or girders.

9) Throw some dirt around the base.

10) Fill with concrete. Be sure to puddle with sticks to eliminate spaces.

CAST-IN-PLACE CONCRETE PIER FOUNDATION

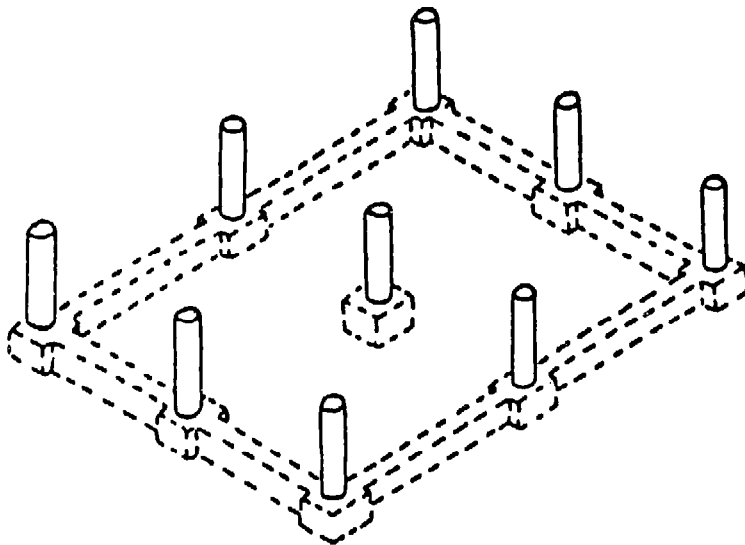

Figure 24A

TYPICAL CAST-IN-PLACE COLUMN

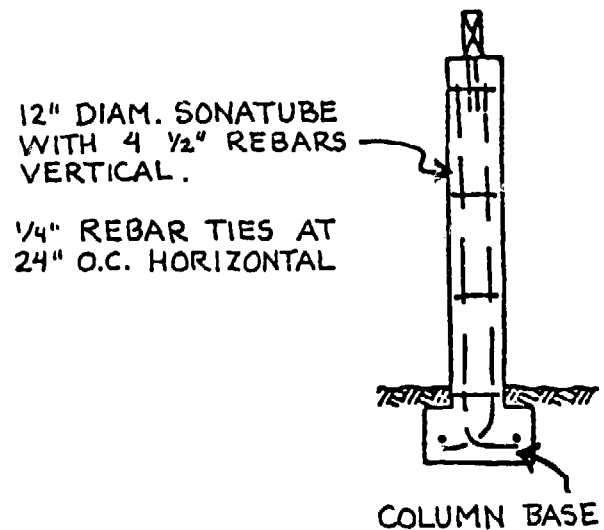

Figure 24B

D. Wood Poles

Wood pole foundations are especially suited to sloping sites where concrete work is difficult, or in inaccessible sites. Also, in terms of affordable, low-cost construction, pole foundations may be the most practical solution for many builders.

In some areas, properly treated poles are said to last from 50 to 75 years without rotting.

The number, size of poles, depth below ground and spacing are determined by soil conditions, and of course, the size of the building.

The same procedures described for other foundations, particularly for measuring angles and leveling, are appropriate here.

A typical pole foundation treatment

would have a 6 foot hole with an 8" concrete footing at its base to support the pole. After the pole is installed, the rest of the hole is filled with tamped sand. (Figure 25A and Figure 25B).

WOOD POLE FOUNDATION

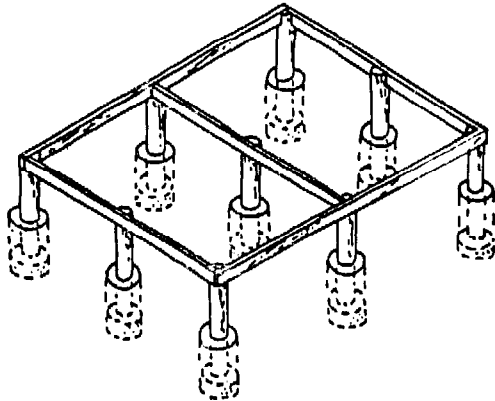

Figure 25A

TYPICAL POLE

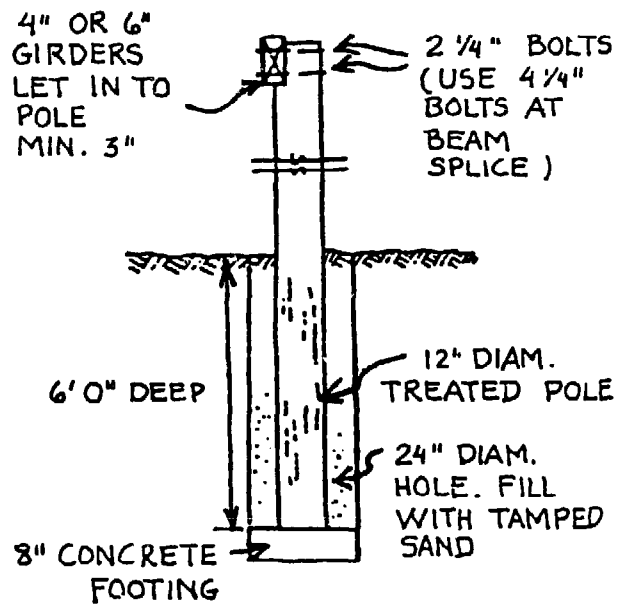

Figure 25B

TYPES OF WALLS

Economy demands that one make the best use of materials, local or imported. It may not always be wise to build with the cheapest materials available, if the objective is soundness and durability. It is worth devoting time to inspecting a variety of buildings and the materials used in them to see which ones withstand the test of time. It is possible that by gathering such information, one will be able to discover materials in the locale which will provide durability at reasonable expense.

A few suggestions are offered here in this section about different types of walls. An examination of various types may be useful in determining the kind of wall best suited for the building being planned.

Mud or Adobe Brick

Mud or adobe has been found to be one of the most practical types of wall construction, where the clay is suitable, and where there is enough dry, hot weather to bake the brick.

Mud bricks are adaptable to almost all building requirements, except where conditions bring about constant washing or splashing of water. Mud bricks lend themselves to corners, jambs, arches and other awkward wall work, as well as straight wall work. On a proper foundation, mud bricks may be classed as sound and permanent construction.

The greatest drawbacks are their inability, more in some locations than in others, to withstand rain, and their complete vulnerability to the

ravages of the termite or white ant. The first problem has been overcome in some areas by waterproofing the mud plaster with cotton seed tar, which, when dried, will hold cement wash, which in turn is a satisfactory base for lime washes.

In some instances, a weak cement plaster has held to the mud brick as a protective coating, but this seems to be the exception rather than the rule. The different rates of expansion and contraction of mud brick and cement plaster causes the latter to peel away from the face of the brick.

Brick sizes are provided in the chapter on brickmaking. (Chapter I).

Mud Block

Many builders prefer mud block to mud bricks. They lay faster and on a good foundation may be regarded as permanent construction. They require special bonding at the corners to give strength, and they are definitely not as satisfactory as mud bricks in respect to odd measurements, awkward corners and special features.

Burned Bricks

These have been used where cement plaster was considered a requisite, or where the mud was considered to be of such poor quality that mud bricks were not satisfactory, or where good clays are abundant. Considerable time and skill are needed to produce good fired bricks, they take longer to make than mud bricks, and often have to be transported for some distance from the clay source and kiln to the building site. In main house walls, their size involves a three brick wall, which is thicker than the standard mud brick wall, and such walls are obviously more expensive. Burned bricks are not always completely waterproof. It seems likely that

clay lacks the properties necessary to be an absolutely impervious material.

Concrete Block

It is hardly necessary to list the advantages of this type of construction. Concrete block is indestructible as far as water and rain are concerned. It is ant proof, clean and strong, and is always acceptable to the authorities and to building codes. It is, or ought to be, very attractive and esthetically pleasing.

Another great virtue of concrete block is that it can be used for construction anywhere at any time. But it has the significant drawback of high cost. Particularly in regions and locales remote from railways, roads and centers of production, the cost of the cement alone is invariably prohibitive.

Block-making machines are available, but they are not without their drawbacks. Very few workers care to make a block mould. They are very heavy, and the process requires scores of metal pallets, further adding to the expense of the operation. The lay up is also expensive, if the work is to be done neatly.

Despite these disadvantages, some builders have learned by hard experience that the desire to save money by using other materials has resulted in so much continual patching of walls made from other materials, and related problems, that a concrete block building might have been more economical and better from many perspectives. This does not apply to all buildings, of course, but particularly schools and public buildings, which should be soundly and attractively built at the outset. In such cases, the initial cost of concrete block might represent a savings over a long period of time.

Stone Walls

In many places, stone is the most practical material for footings and foundation walls. At the same time, it has not always been recognized as a very expensive material for walls. It does not lend itself to fine measures, jambs and special features. It is costly to lay up properly, and must be pointed up with cement, which is another costly item.

If cement plaster is used on the inside, there is the added expense of filling in large cavities with costly cement. Stone walls must be thicker than mud brick walls to provide the necessary stability.

On the other hand, a well built stone wall is permanent, attractive and substantial. It may be a necessity where mud is unsatisfactory, where good clays are not available, and where stone is relatively inexpensive and plentiful.

Corrugated Iron

This type of wall is not commonly used for dwellings, but for certain other types of structures it is often the most practical. It has some unique properties. It can be built in a day or two. It is waterproof, and when fastened into place, never requires attention or repairs. It is durable and can be used at a later time for a different purpose. It can serve as a dwelling house wall very acceptably for a year or two if it is backed up by mud, which in turn is plastered. As in the case of concrete blocks, this type of wall can be put up anywhere at any time. If skilled labour is not available, one can do it alone, since installation does not require heavy work.

Veneer Walls

The same principle mentioned in relation to corrugated iron walls, that of backing the iron with mud, applies to burned brick and to concrete block walls. It is possible and permissible to build a thin outer course of waterproof brick or concrete block with a thicker backing of mud brick or mud block. This is a veneer wall and is strongly recommended as a solution to many problems. It is important to mention that one of the essentials to good construction of this kind is to provide frequent and adequate ties between the veneer and the backing, either by iron, or by the more satisfactory method of headers or cross blocks and bricks.

Pise or Ramed Earth

In this method, slightly damp soil is used as a removable form or mould. When the form is full, it is taken down and set up to be filled again. The chief factors in determining whether this type of building construction should be adopted are: builder's preference; climatic conditions; the presence of the right soil; shrinkage; the scarcity or complete lack of bricklayers; the ability to make and properly handle the mould; cleanliness and reduced handling (as contrasted with bricks).

Common Mud Walls

This type of wall is remarkably durable in some locations. Although it is not recommended for the walls of permanent dwellings, it should not be ignored as a possible material for the walls of other kinds of structures. It makes a practical wall if built upon a solid foundation, such as stone, and if it is adequately waterproofed. The greatest difficulty would seem to be that of

persuading the builder to keep the walls plumb and straight. If houses and buildings must be constructed of mud, they could be made more permanent and durable by putting in stone footings, foundation walls, and ant proof coursing. None of these features requires great expense, and would save repairs and rebuilding in the long run.

Thickness and Height of Walls and Gables

Thickness and height must be considered in selecting the type of wall for a building. Gables, two storey buildings, and high walls require very special care in design. The following is recommended as a safe procedure in most cases.

In all of these designs, it must be understood that a base of firm, undisturbed earth is essential, and that thorough waterproofing inside and outside, with adequate stiffening or bracing at every storey height are absolutely essential contributors to the stability of every masonry wall.

The drawings themselves may not make it sufficiently clear that mass is an essential constituent of masonry durability. In some of these examples, if not all of them, the thickness of the wall may be quite inadequate due to the presence of unusual stress factors such as weight or vibration. Masonry walls, including partitions, must be massive enough to withstand external forces, and to resist cracking due to above-ground conditions. (Figure 26A).

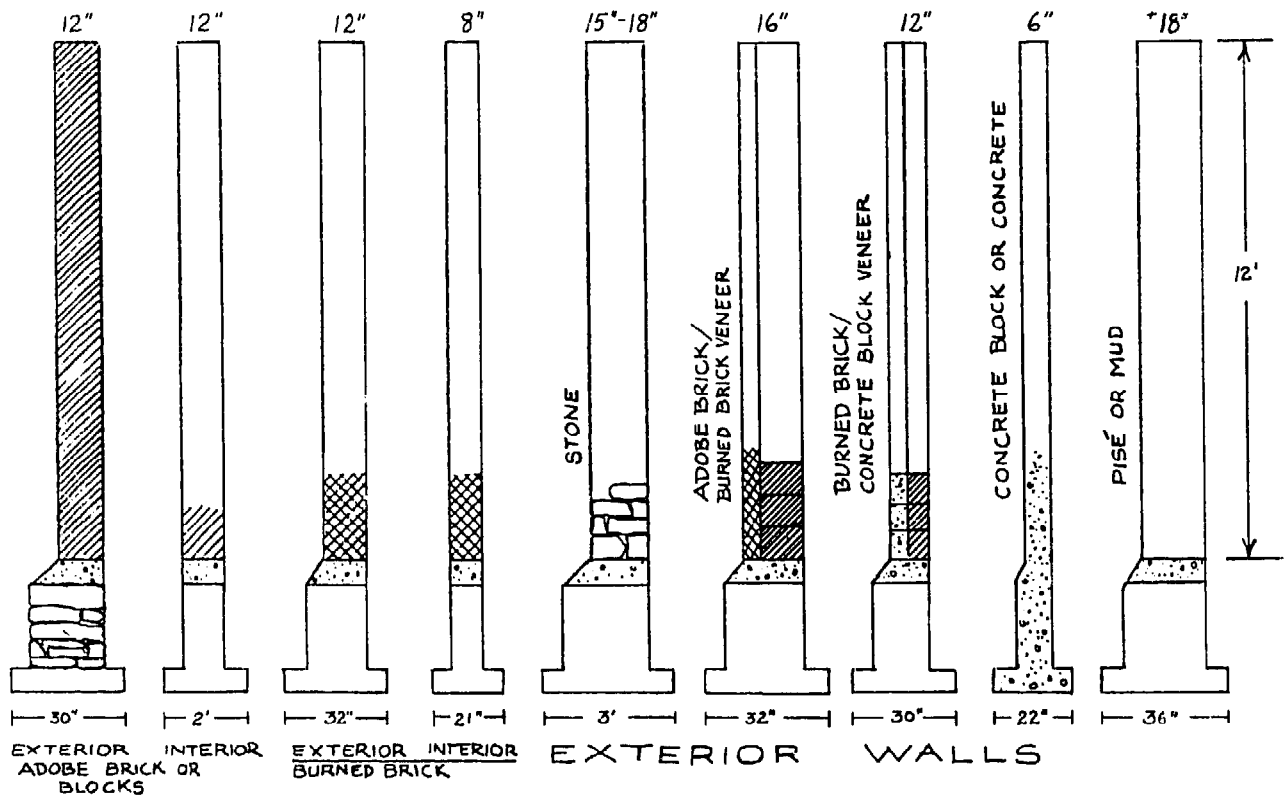
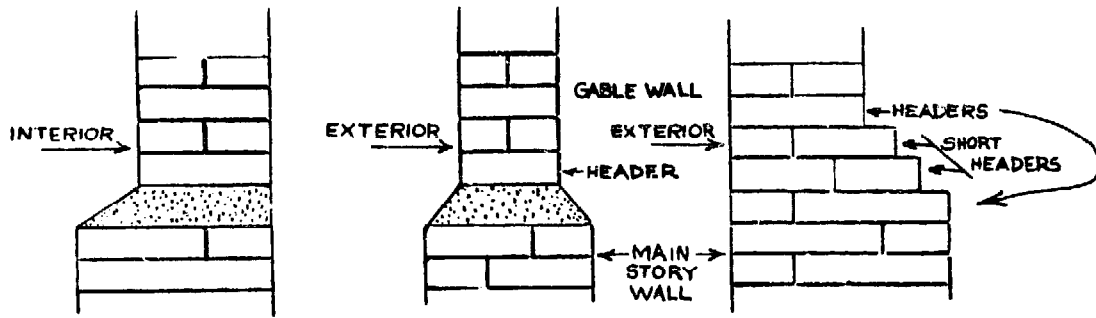

Figure 26A



Three types of base for gable walls

Note that in the figures on the left and in the center, the concrete course provides a solid base for the gable, even though there might be a plaster failure through which water might find a way. In the figure on the right there is no vulnerable spot.

Figure 26B

Thicknesses of gables and their supporting walls.

Neither scaffold nor any other kind of stress should be borne by high gable walls. Unless there are a pair of buttresses, there should be a rigid stay to the top of the main wall, and a stay for every ten feet above it. These stays should not be removed until all heavy work, including roofing, is completed and the frame which is to hold the roof permanently is in its final place. Movement in a green, unsupported masonry wall is dangerous. In a house wall there are usually cross walls to stiffen the end wall supporting the gable. Leave the masons' scaffold in place until the roof frame has been secured to the gable wall.

Figure 26C

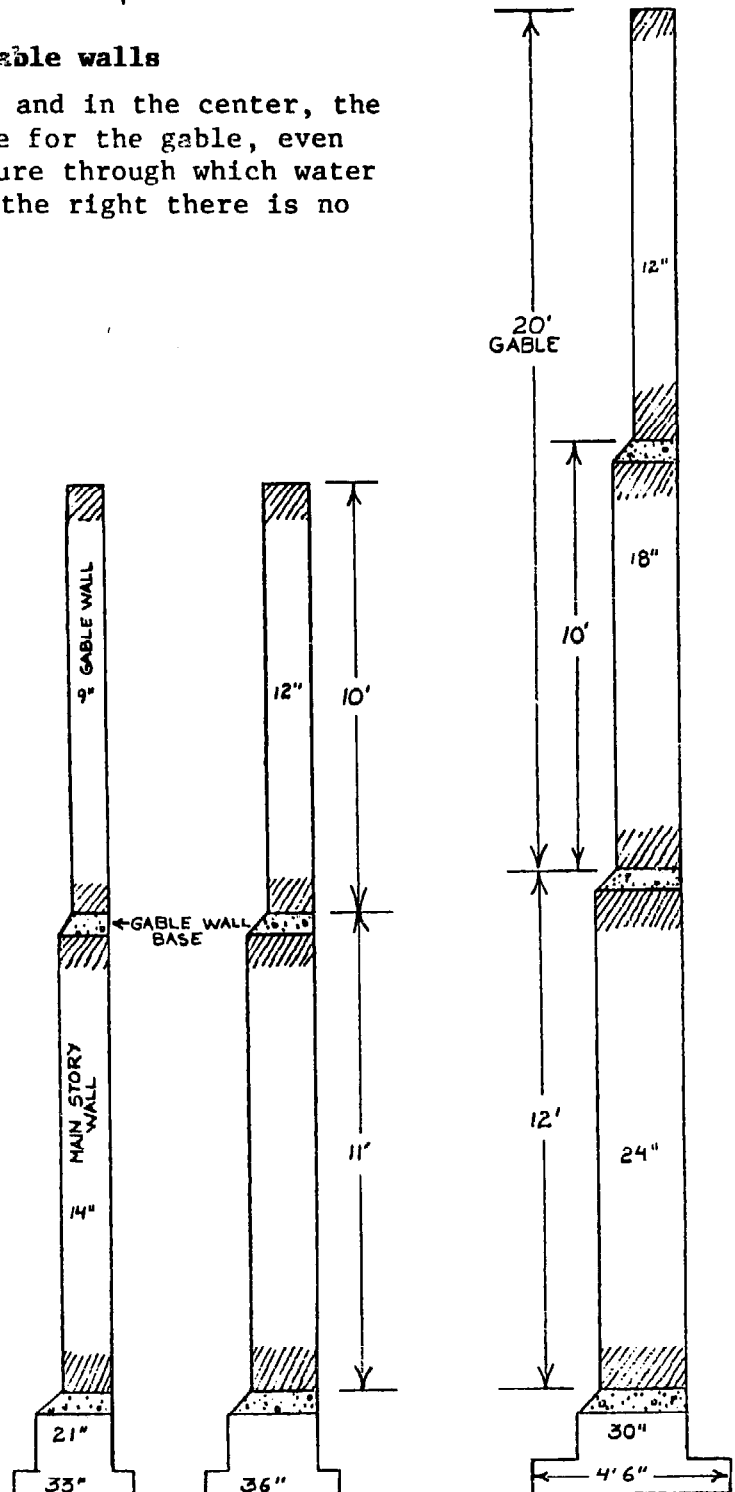

Bricklaying: Solid Walls and Joints in Brickwork.

Importance of Mortar:

In laying bricks, it is customary to bed the bricks in mortar. The mortar serves several purposes, two of which are it has the effect of making the wall waterproof and air-proof under ordinary conditions. Of course, an ordinary brick wall is never absolutely impervious to water or air, but mortar joints prevent rain or wind from entering a house in such large quantities as would be the case with walls laid up without mortar, or dry, as it is called.

Another advantage in using mortar in the joints of brickwork is that a wall thus becomes one solid mass, which increases its strength and stability. An important consideration often overlooked is that mortar gives a certain amount of elasticity to the wall. Lime mortar is more elastic than brick, and by having a light bed of mortar between each brick course or layer, many bricks are protected from cracking due to settling or other causes. (See Figure 27A).

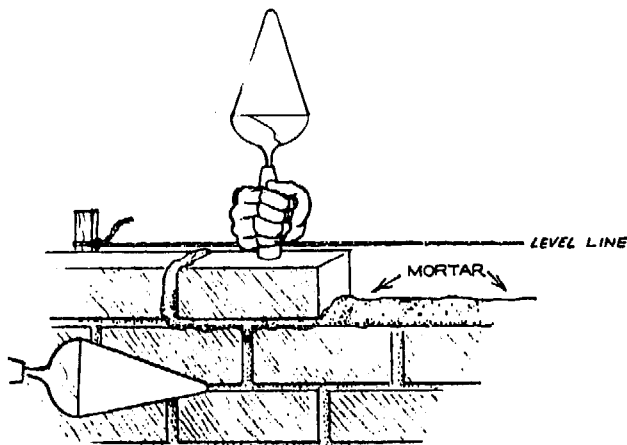

Figure 27A

Meaning of Brickwork:

The term "brickwork" refers not only to the bricks themselves, and working with them, but also to the mortar in the joints. It can be readily seen

that the strength of brickwork cannot be dependent on the strength of the bricks alone. Other factors influence strength, such as the quality of the mortar and the method of laying up and bonding the bricks. Therefore, the value of a good brick, as far as strength is concerned, may be decreased by the use of inferior mortar, or by being laid by a bricklayer who does not understand his trade.

Size of Mortar Joints:

When building a wall, sufficient mortar should be used to fill all the spaces. Lime mortar, which is the kind often used in the construction of houses, is not as strong as the brick, and it is recommended that a bit more mortar than that simply needed to fill the spaces should be used.

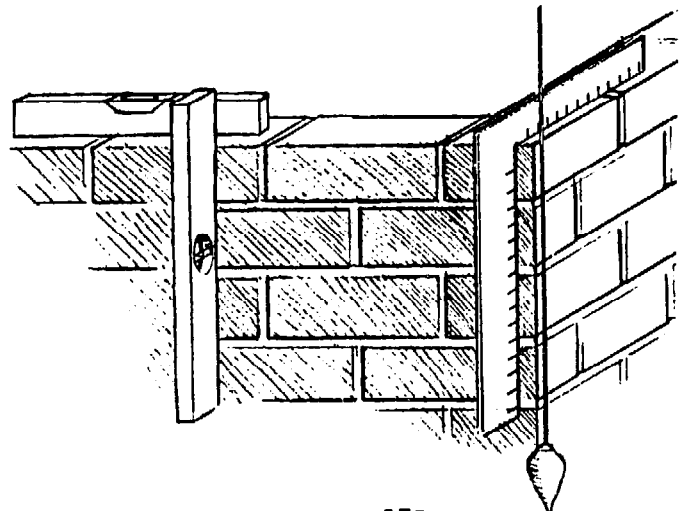

Figure 27B

Another consideration is appearance. Thick joints in brickwork present an unsightly appearance. In proper brick laying, a layer of mortar is first spread over the preceding course. Then each brick is laid in place on the bed of mortar, and tapped with a bricklayer's trowel until sufficient mortar is squeezed out to make a joint of the required thickness. To force a brick down until it touches the brick beneath is not good practice, because it forms thin joints

without sufficient strength. If a special brick is made with a "frog" on one side, an indentation or rise for special fittings, it is laid with the frog side facing up.

The more regular the surface of the bricks, the closer they can be laid together, and the smaller will be the joints. With ordinary brickwork, the joints should average not more than 1/4" in thickness. In working with machine manufactured bricks (pressed bricks), the joints can be made smaller, probably 1/8" to 3/16" being the usual thickness, because the bricks are smoother and have no irregular projections.

Bond in Brick

Lime mortar is not as strong as brick, at least for some time after it has set. It can easily be seen that if each brick in a wall were placed directly on another brick, any great weight imposed might cause the vertical mortar joints, which would all be in a row, to split open. There is something more to be considered in laying up a brick wall than simply placing each brick upon a bed of mortar. A brick wall, if it is built correctly, must be tied together in a way that utilizes all the potential strength of the bricks and the mortar.

In bricklaying, all corners and joints should be carefully plumbed; the courses (layers) of brickwork should be kept perfectly horizontal, which requires uniform application of mortar; and all aspects of building a good wall must be complied with. The merit or quality of the brickwork must be judged by the thoroughness of the bond observed in every portion of the wall, both lengthwise and crosswise. The bond must be maintained by having every course perfectly horizontal, both longitudinally and transversely, as well as perfectly plumb vertically. Aside from the qualities and characteristics of the

basic materials (brick and mortar), the bonding of a wall constitutes most of its strength.

Types of Bond in Brickwork

FLEMISH GARDEN WALL BOND

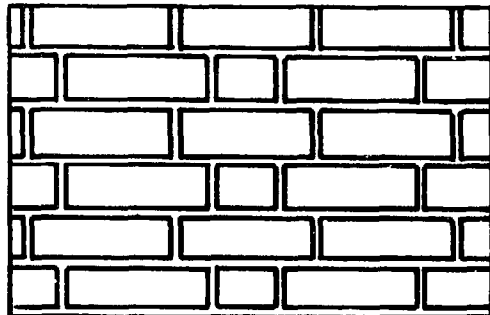

FLEMISH BOND

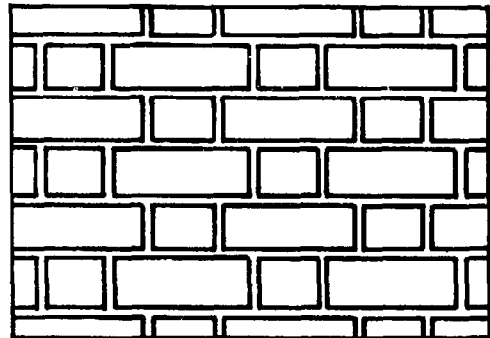

DUTCH BOND

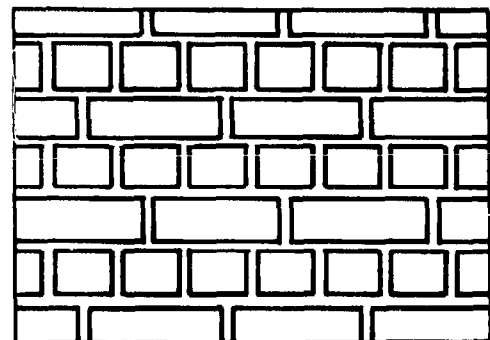

ENGLISH BOND

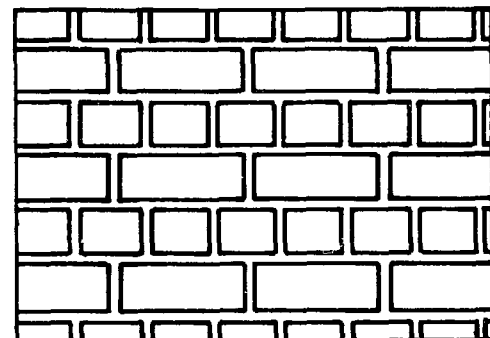

Figure 28

Terms Used in Bonding

Bonding brickwork means the process of laying bricks across one another so that one brick rests on parts of two or three other bricks below it. This amounts to the same thing as breaking the joints. When built in this manner, it is difficult for a wall to fall without actually breaking the bricks.

When the bricks are placed lengthwise on the face of a wall, they are termed **stretchers**. When they are placed crosswise, and only their ends are exposed to view in the face of a wall they are called **headers**.

A **course** refers to the thickness of a brick and a mortar joint.

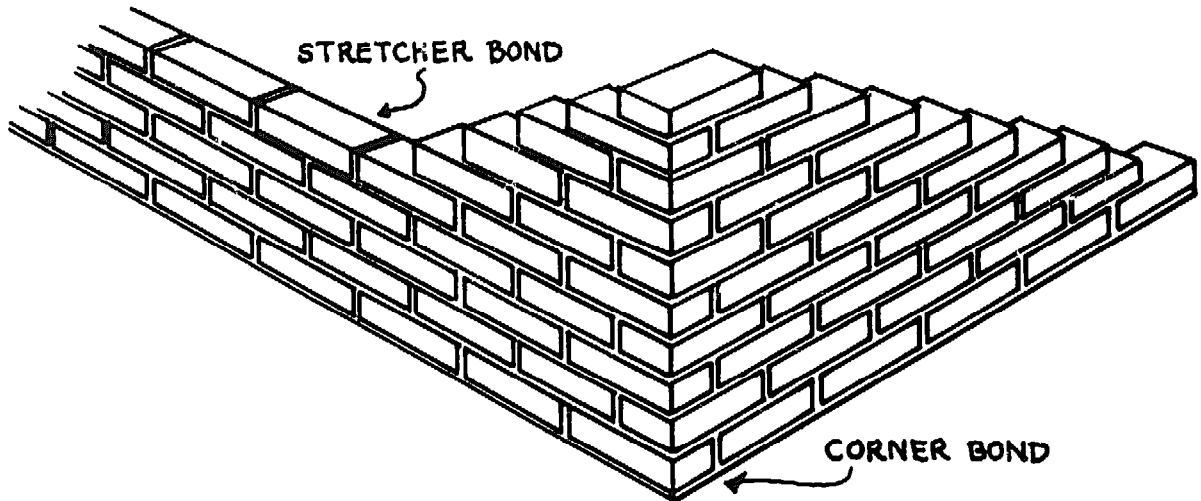
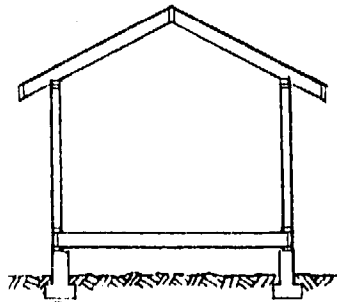

Figure 29

Roof Framing

Choice of shape of a roof depends on weather conditions, overall size of the building, the materials available and the skills of the builder. The following figures illustrate three basic types of roof: gable, shed, and flat roof.



GABLE
SHORTER SPANS THAN
FLAT OR SHED; CAN
HAVE LOFT OR 2ND STORY.

Figure 30A

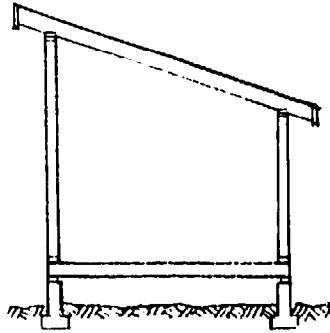

SHED
SIMPLE, CAN HAVE
1/2 LOFT ONE SIDE.

Figure 30B

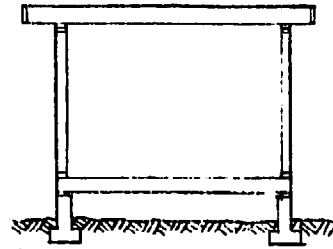

FLAT
SIMPLE, LOW PROFILE,
CAN ADD 2ND STORY
LATER.

Figure 30C

Instructions for Building A Gable Roof

It is assumed that in most rural areas, builders will have a framing square, but squares and other tools may not be available everywhere, due to high prices and the state of the hardware and tool-making industry. By all means, if a square is available, it should be used.

The following instructions are for framing without the use of a framing square. (See Figures 31A, 31B, 31C).

- 1) Support ridge board temporarily.
- 2) The measurements on both sides from the ridge board to the plates should be equal.
- 3) Tack the rafter in place and mark "plumb cut" at ridge board and "birds mouth" at plate.
- 4) Make ridgeboard and birdmouth cuts on rafter. Hold pieces in place to check fit.
- 5) Using this piece as a pattern, mark and cut a second rafter.
- 6) Check all along length of ridgeboard with these two sample rafters opposite each other.
- 7) If the fits are satisfactory, use one as a pattern and cut the other rafters.
- 8) Mark rafter location along both sides of the ridge board, and both plates.
- 9) Install rafters.

10) Attach ceiling joists at 2'-0" on center, or cross ties at 4'-0" on center, and collar ties at 4' on center. This braces the roof frame and gives it strength.

11) Rafters should be placed at 24" spacing to provide for the maximum strength for purlins and roof covering.

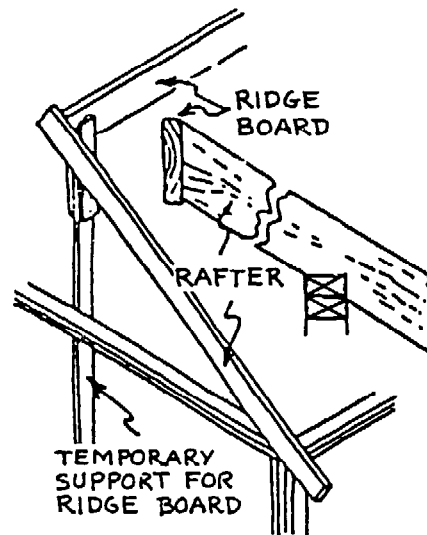

Figure 31A

NOTE: FIREBLOCKING REQUIRED EVERY EIGHT FEET.

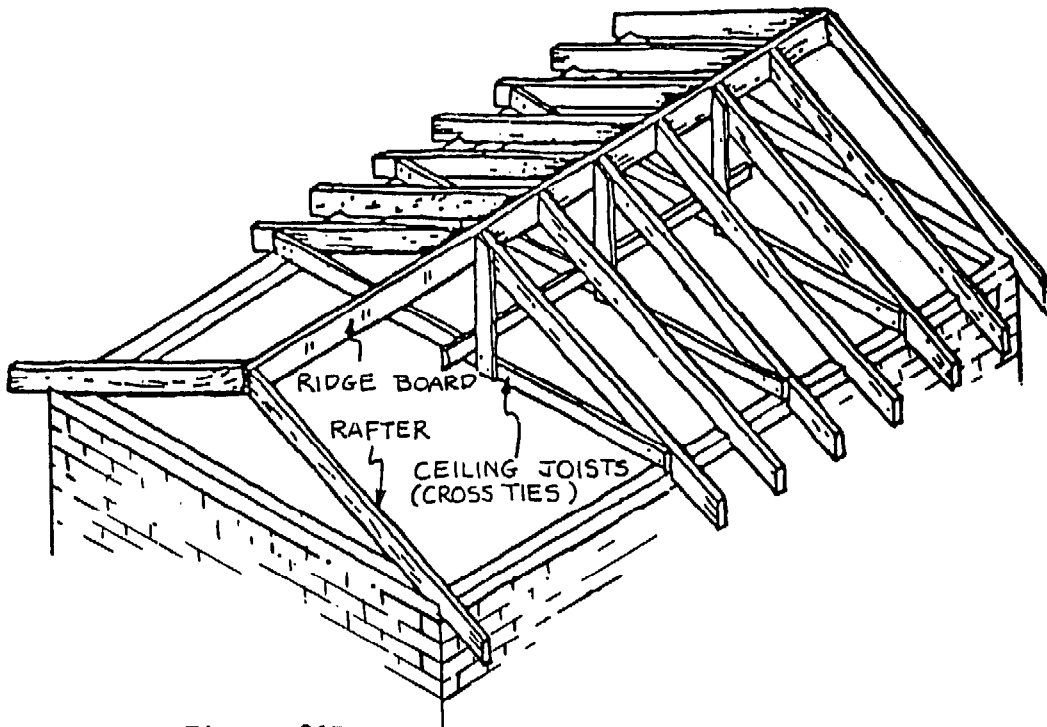
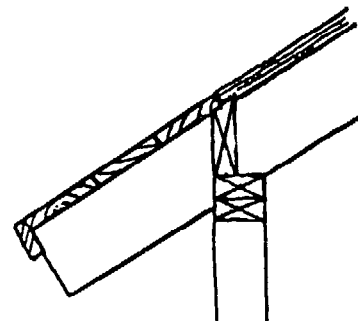

Figure 31B

Rafters at 24" spacing can be sheathed with 1/4" lumber. Sheathing over open cornices should be boards, or can be plywood over roof. In this way, no ply exposed to weather or visible from underneath.



Sheathing
Figure 31C

Eaves

A builder may wish to consider three types of eaves: open cornice, closed cornice, or boxed cornice.

1) Open cornice: Rafter overhang is exposed, and blocking is vented and screened. If a gutter is desired, cut rafter end plumb.

2) Closed cornice: No rafter overhang and cheap and fast to build. Good for heavy winds but has the disadvantage of no rain protection for walls and no overhang protection for vent holes.

3) Boxed cornice: Rafter tails are boxed with screen vent in soffit. The vents should not be directly over doors, or within 3' of windows or doors.

OPEN CORNICE

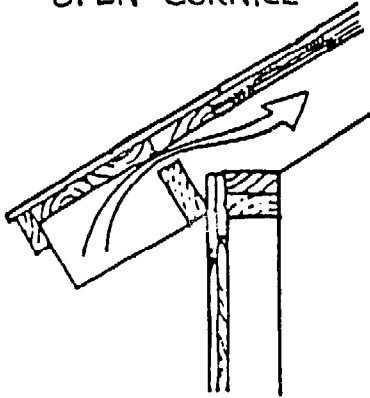

Figure 32A

CLOSED CORNICE

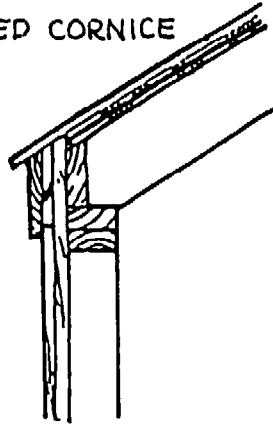

Figure 32B

BOXED CORNICE

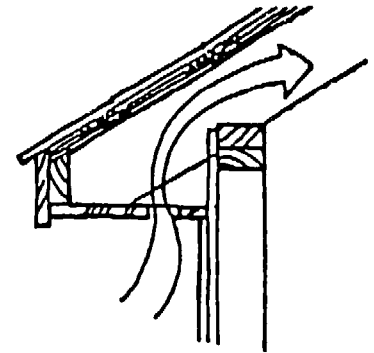

Figure 32C

Flat Roof

An advantage of the flat roof is the possibility of adding a second story later on, if the weight-bearing walls are built with sufficient strength. Use floor joist-sized rafters, and cover with whatever good roofing material is available. If no second story is planned, it is a good idea to give the roof a slight angle or pitch. This can be done easily by adding an extra plate to the wall on one side, which gives the roof about a one and one-half inch slope.

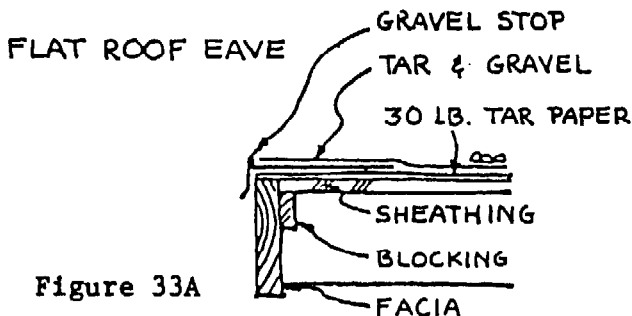

Figure 33A

OVERHANG FRAMING

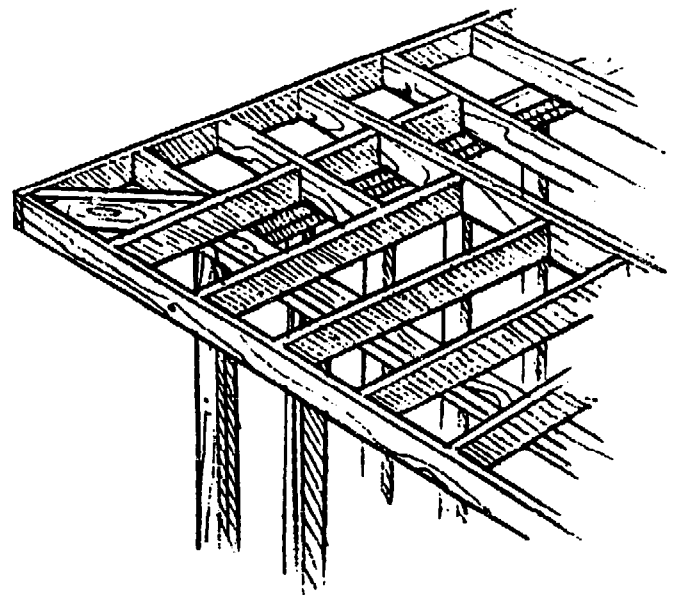

Figure 33B

Roof Trusses

Trusses are designed to span greater distances using smaller wood or steel sections, through the use of geometric configurations (triangulation).

Trusses are built on the floor or on level ground outside, and then raised into place by two or more people. The

outside walls are constructed first to support the roof, and then the trusses are set in place. The roof is then covered or sheathed. Trusses must be built accurately for a good fit, and must be strongly supported by cross-members which are properly placed and tied in well.

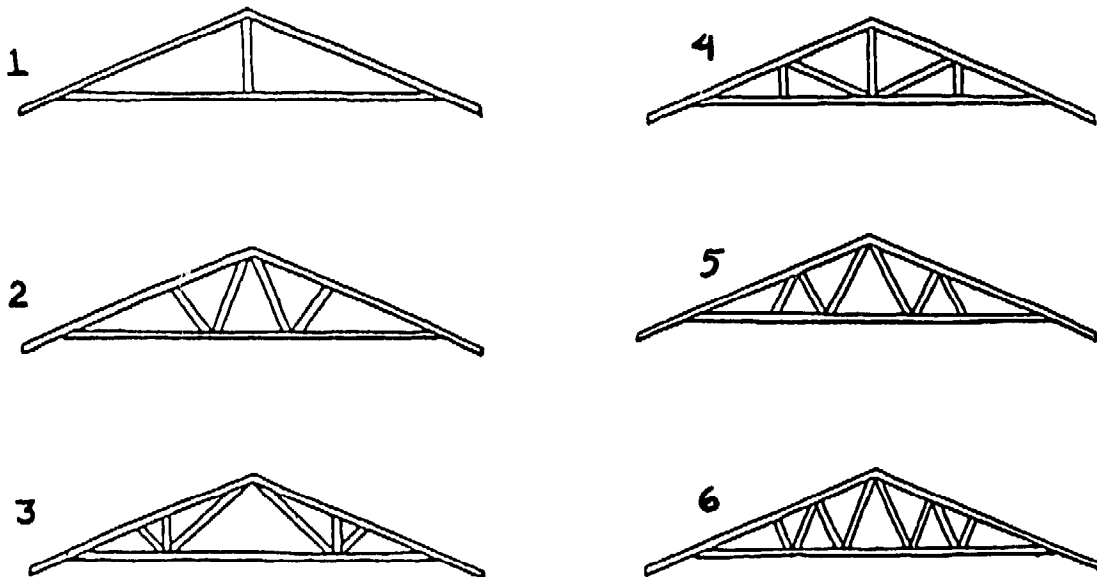
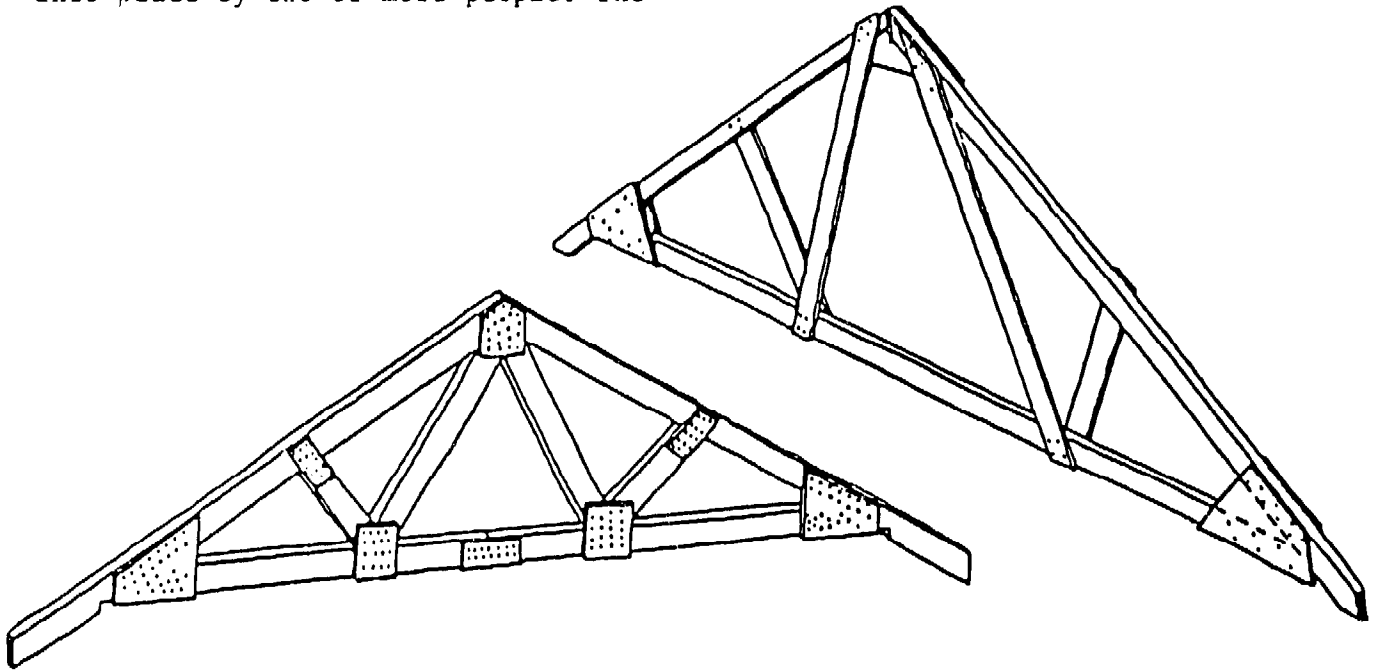

LIGHTWEIGHT TRUSSES NUMBERED IN APPROXIMATE ORDER OF STRENGTH.

Figure 34

Roofing Materials

Manufactured roofing materials such as rolled roofing, asphalt shingles, and wood shingles are generally very costly or unavailable in rural areas. The most common materials are likely to be tiles of clay, ceramic or concrete, corrugated iron sheets, grass thatch, or papyrus or other reeds.

Corrugated iron: In the construction of buildings or sheds, corrugated sheets or roll plate are frequently used. Usually these materials are made of galvanized iron or aluminum. It is good practice to buy the sheets in widths 2' to 6', and their length may vary from 6 to 10 feet.

When corrugated sheets are laid for roofing, the edges are overlapped. This overlapping, known as side-lap, is usually at least one and one-half corrugations or grooves, or approximately 4". The top sheet is laid with the side edge turning downward towards the ground.

In addition to side-lap, the ends must overlap as well. A flat roof requires a greater degree of end-lap. It is also important to know that the point where two pieces of metal overlap will require additional roof framing and support. A good rule to follow is:

12" rise per foot, use 6" end lap

6" rise per foot, use 9" end lap

1" rise per foot, use 12" end lap

Calculating number of sheets:

The following is the procedure for calculating a pitched roof with a 6 inch rise per foot, with a total surface area of 20' by 40'. This problem is for calculating for sheeting in terms of **vertical distance**.

2 ten foot sheets will not cover from ridge to eave and allow 6" for end lap.

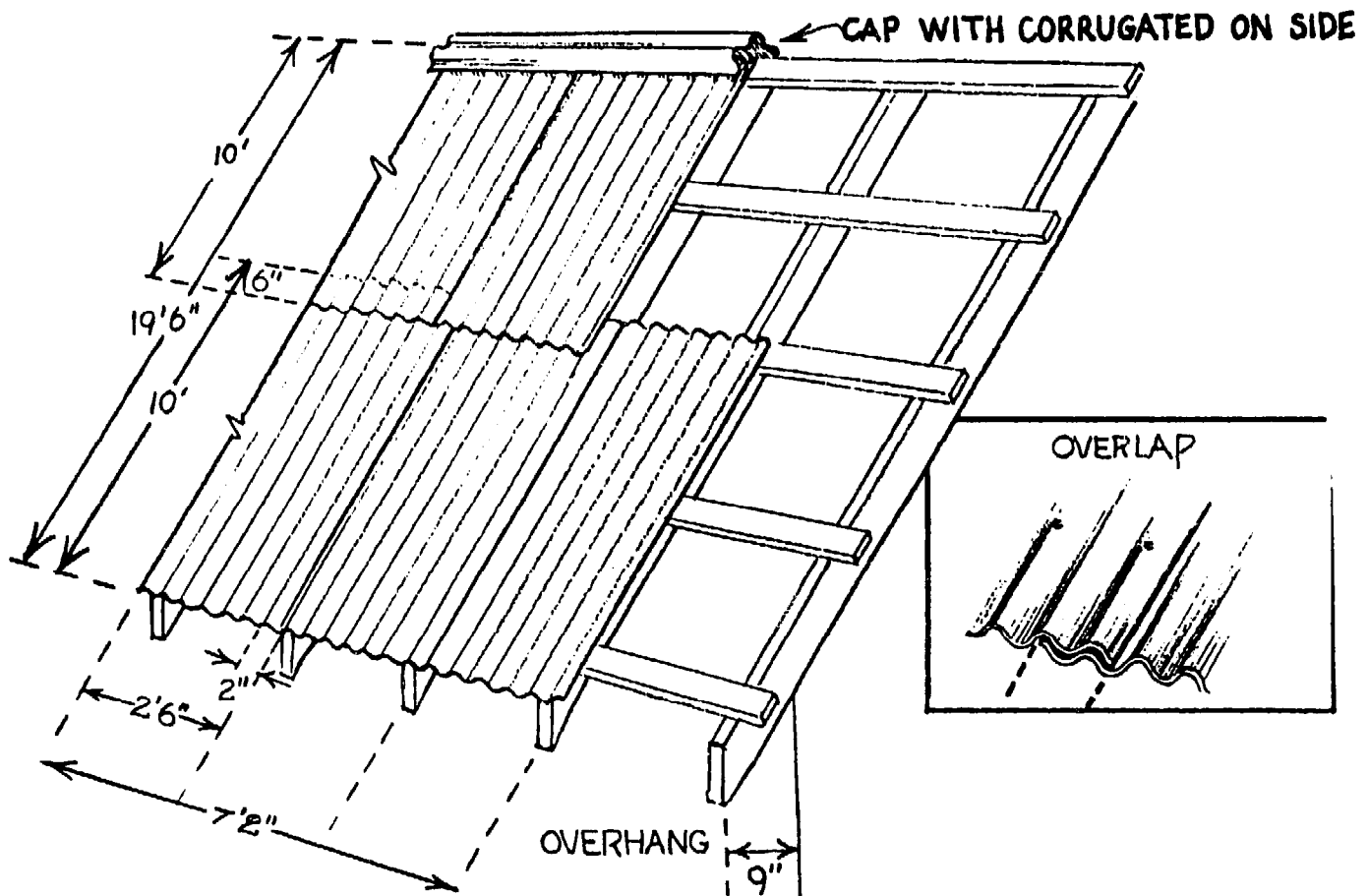

Figure 35

3 sections with two end laps are required ($20' + 6" + 6" = 21'$).

Judge which combination of sheets will provide 21 feet of vertical distance. A good combination would be $9' + 6' + 6'$.

Each vertical row would require one 9' length of sheeting, and two 6' lengths.

Calculating sheets for horizontal distance:

Allow 4" for side-lap, which means that each 2' by 6" row actually covers 2' and 2" of roof area.

Papyrus Reed

Mature reeds must be selected which are at least 8' in length and 1/2" in thickness. The reeds should be dried for several weeks, on racks off the ground if at all possible, and turned several times during the process to insure thorough drying. The length of the drying time depends on weather and dampness. When ready for installation, bundles of reeds should be tied into 8" to 10" pieces and securely attached to roof purlins. The life span of papyrus roofing can be up to 20 years if properly cared for.

Thatch Grass

Clean tall grass at least 3 feet in length should be used for the typical shed or roof covering. The thickness of each bundle can be measured by the handful. After cutting, the grass requires 1 to 2 weeks of drying time, depending on the season. Before installing the bundles and setting them into place on the roof, soak them in water, and lay with the butt ends from the eaves up. The water treatment helps to pack the bundles in laying them onto the roof structure. The bundles should be tied to the purlins downward and then upward, always rotating each line. The life-span is up to 8 years if properly cared for and patched several times per year.

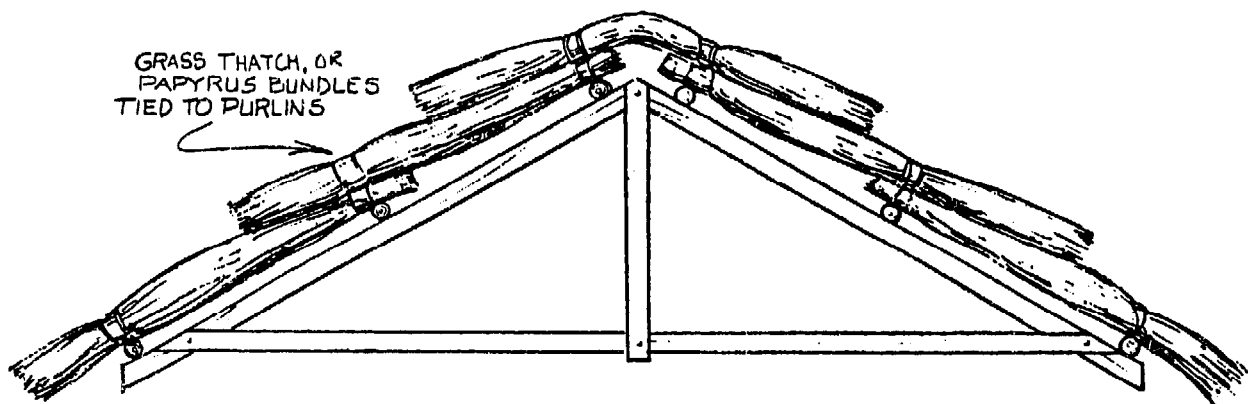

Figure 36

Windows and Doors

Wood windows:

Advantages:

- 1) good looks
- 2) small panes, cheap to replace if broken
- 3) are often available used (from other buildings) and at a good price.

Disadvantages:

- 1) must be maintained with putty and paint
- 2) require time to install, build
- 3) more likely to leak than pre-fabricated windows, sashes.

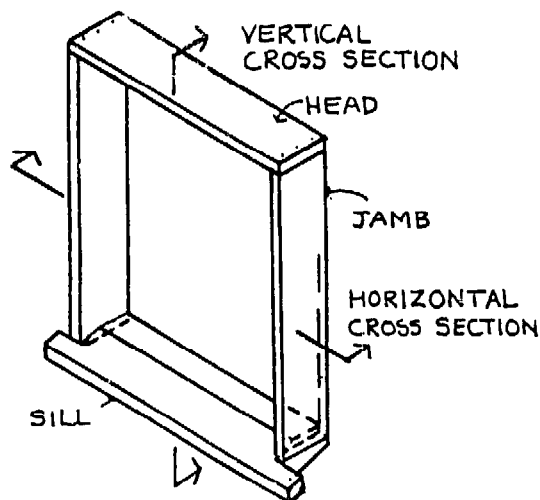
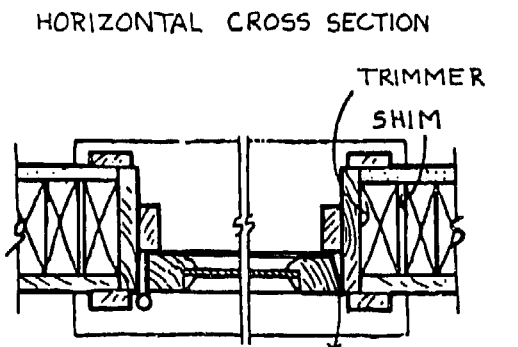

Figure 37A



WHEN USING 1" FRAME,
NAIL FRAME TO TRIMMER,
THEN SHIM.

Figure 37B

Building frames and sills for windows

- 1) Use clear, dry wood
- 2) Make inside of frame at least $3/16$ " larger than the actual dimensions of the sash, to provide clearance to install sash, and room to open window if it is to have hinges.
- 3) Use 2 x 8 clear stock for sills
- 4) Use 1 x 6 jambs
- 5) Cut out parts and assemble with nails and glue. (Use waterproof glue if available).
- 6) Completely assemble frame before installing.
- 7) Place frame in opening, shim tight with shingles or wedges.
- 8) Check diagonals and nail through jamb into studs.
- 9) Add stops, stool, apron, trim last.

Exterior Trim:

The following figures illustrate some of the principal issues in the design and construction of trim for window assemblies. The most important point is that the installation must be made correctly, and properly sealed to avoid leaks. (Figure 37).

VERTICAL CROSS SECTION OF WINDOW ASSEMBLY

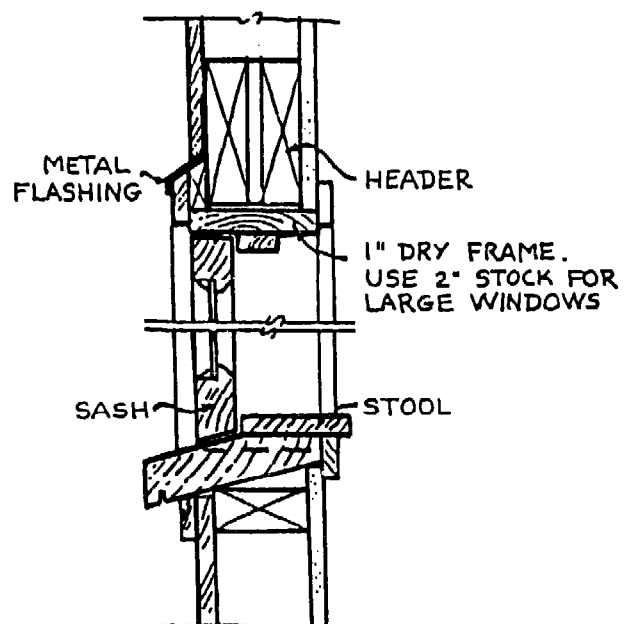
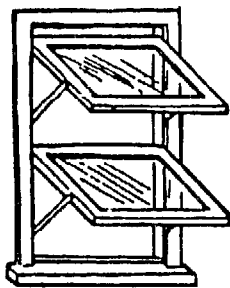

Figure 37C

TYPICAL WINDOW FRAME ASSEMBLY



AWNING

Figure 37D

CASEMENT

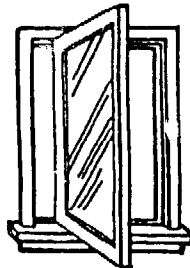

FOR CASEMENT WINDOWS, HINGE MOUNTS ON HEAD AND SILL, SASH OPENS AWAY FROM HINGE JAMB.

Figure 37E

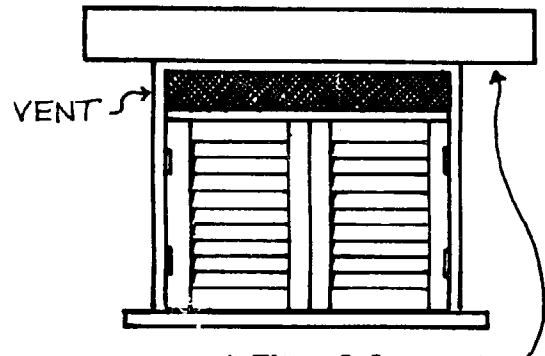

LINTEL OF RINGBEAM CONCRETE OR WOOD

Figure 37F

Doors

Weatherproof homemade wooden doors must be made so that they will not sag or warp. They must be properly designed and built of good materials. (See Figures).

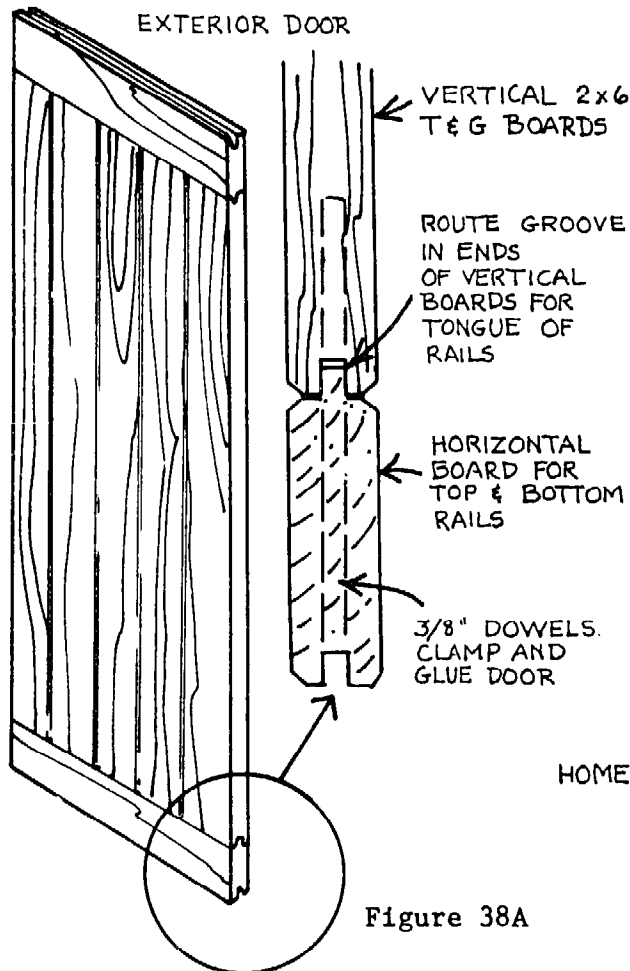

Figure 38A

HOMEMADE DOORS

INTERIOR DOOR

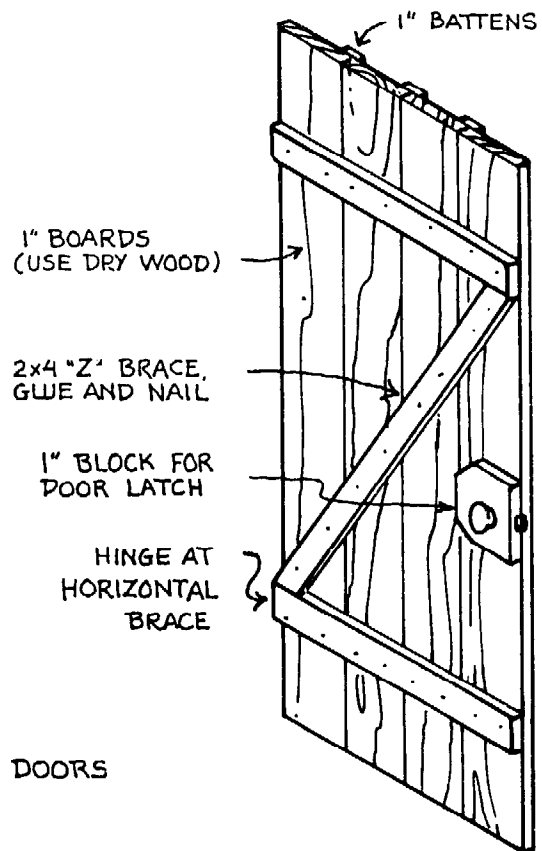

Figure 38B

Jambs

Two of the more common types of jambs are:

1) rabbeted: good for heavy doors, and exterior doorways; weatherproof. (See Figures 38C and 38F).

2) component jamb: weatherproof, durable (Fig. 38C "nailed on stops").

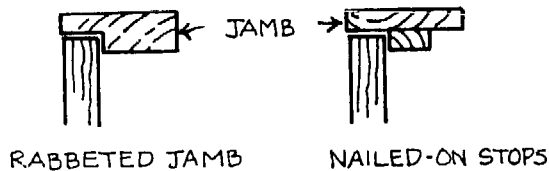

Figure 38C

Procedure for Hanging Doors

1) Before making jambs, take the time to inspect a properly hung door; note the hinge positions on door and jamb.

2) Use solid, dry material. Cut to correct width, and if making a rabbeted door, rabbet with a saw to form tongue and groove.

3) To install hinges, lay out on door first.

4) Using the hinges as a pattern, mark with sharp knife.

5) Mortise out the bed for the hinge with a sharp chisel.

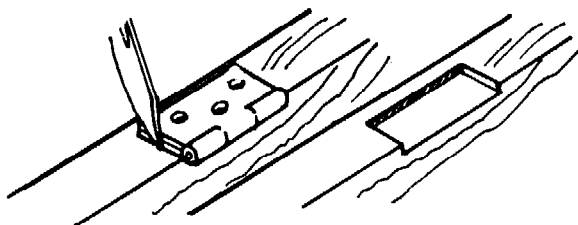

Figure 38D

6) Lay hinge in mortise, mark screw holes, drill holes for screws. The size of the drill should equal the size of the shaft of the screws.

7) Screw hinges to door.

8) Lay jamb next to door and mark jamb for correct placement of hinges. Allow 1/8" clearance between top of door and head jamb.

9) Mortise the jamb, screw jamb and screw hinges to jamb.

10) There should be 1/8" to 3/16" clearance between door and head.

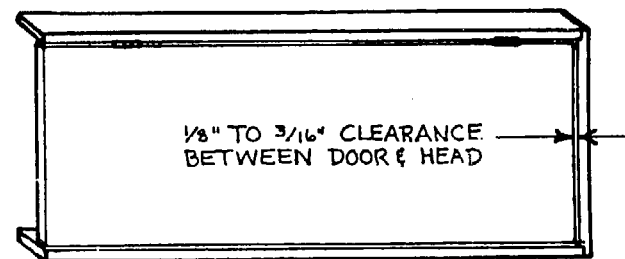
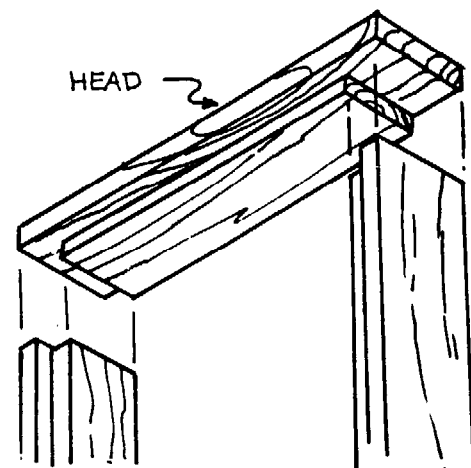

Figure 38E

11) Assemble jambs on floor; nail and glue; allow to dry for 24 hours.

12) Assemble door and jambs. Check for fit and clearance.

13) Remove hinge pins; lay door aside



ASSEMBLY OF RABBETED JAMBS TO HEAD

Figure 38F

14) Before finally hanging door, bevel edge on door handle side about 1/16".

15) Shim jamba in rough opening using shingles or wedges to adjust. Use a level, carpenter's square, tape measure to check for plumb and square.

16) Nail through jamb with finish nails. Nail only hinge side first.

17) Hang door once again; check for fit.

18) Adjust jamba for 1/16" clearance and then nail all jamba into place.

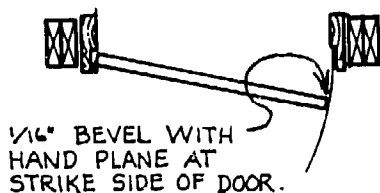
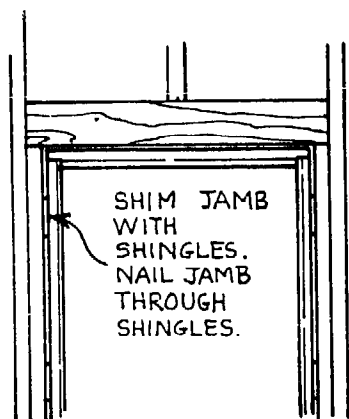
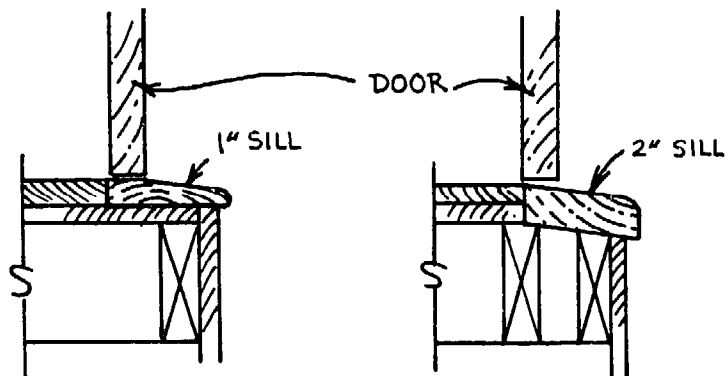

Figure 38G

HARDWOOD DOOR SILLS



DETAILS INDICATE WOOD CONSTRUCTION. BASIC ELEMENTS AND PROCEDURE ARE APPLICABLE TO MASONRY CONSTRUCTION.

Figure 38H

CHAPTER III

ALTERNATIVE BUILDING MATERIALS AND TECHNIQUES

Introduction

The local alternative building materials industry should be reinforced to produce materials that are affordable to most people, and particularly for home builders in African countries. Due to either the high costs and/or scarcity of typical building materials, there are serious constraints affecting the construction industry in Africa generally. Thus while a respectable volume of building activity is evident, it is not nearly sufficient to meet the needs for appropriate housing in the region.

A certain volume of imported materials will continue to be brought in for many years, because of the desire for manufactured and processed materials, and because local industries are not producing building materials of adequate quality and in sufficient volume. A broad effort towards upgrading and encouraging the production of building materials from local raw materials would save money over the long term, and would create gainful employment and business opportunities for local people. Above all, it would bring the cost of building materials within reach of the large numbers of people who want and need improved housing for their families.

In Uganda, construction projects over the past several years have progressed by fits and starts, due to the shortages of materials. Techniques have been used to stretch cement as far as possible, ultimately affecting the quality and structural integrity of the structures. Further scrimping or lack of adequate materials have left structures unfinished for months at a time, thereby leaving buildings

open to the destructive elements of climate, and further reducing the integrity and quality of the buildings. Protracted delays caused by shortages have, in many cases, made a mockery of efficient construction procedure, management techniques and cash flow principles.

In terms of long range planning, national governments and their district-level public works and construction authorities should be encouraged to support the testing and production of alternative building materials by local builders and entrepreneurs. As an example, if government adopted less strict regulations for rural building codes, rural builders would be encouraged to develop and use local materials, thus cutting the costs of transport, labor and the volume of materials which needs to be imported.

In recognition of the need for alternative building materials, and the very real potential for local materials to help overcome shortages and to generate construction activity at local levels, The Experiment in International Living (EIL) and the Banakaroli Brothers have been working together at the Kiteredde Construction Institute (KCI). A major focus has been on improving the traditional techniques and mixes for brick and block making, alternative mortars and concrete, local plaster mixes, the use of anthill kilns, and the production of local paints from soils and plants in the area.

This chapter describes some of these techniques and mixes, and also includes a section on the basic mathematics needed for construction. It should be clear that some of the mixes and formulas would vary from one area to another, depending on soils, vegetation and other factors, but the basic approaches employed can be adapted to other areas, raw materials and conditions.

Local Material Mixes

The following mixes have been tested and improved over the past five years in a number of different building projects in Uganda. Structures such as houses, school classrooms, storage and work sheds, dormitories, toilets, cook houses and food storage facilities and farm buildings have been constructed at a very reasonable cost as compared with building with Portland cement, iron roofing sheets and other imported or manufactured materials.

The use of these local materials in actual construction projects proves their viability, and economic suitability for many or most African settings. In addition, the resulting buildings are just as attractive and structurally sound as most of the structures built in rural areas and small towns.

The clay that is used in the following mixes is the same clay used for brickmaking, and should be prepared for these mixes in the same manner, described earlier, before being applied to the mixes. Following these recipes is a section on **Mixing Alternative Cements**, which provides the information needed on techniques.

Concrete Foundation Using Local Materials

- 1 Gallon of purified cow-dung liquid
- 2 Karai* of wood ash (see Figure).
- 4 Karai of pure clay.
- 6 Karai of sea sand.
- 8 Karai of 3/4" stones.

Anthill clay, if available, can be substituted for regular clay in this recipe, and 2 karai of anthill clay added to the above mixture will provide a very strong concrete. Anthill clay and its uses are explained on page 57.

* 1 Karai = 10 Liters or 4.5 U.S. gallons.

Mortar Cement

- 1 Gallon of purified cow dung liquid.
- 2 Karai of wood ashes.
- 4 Karai of pure clay.
- 6 Karai of sea sand.

Damp-Proof Course

- 1 Gallon of purified cow-dung liquid.
- 1.5 Karai of wood ash.
- 4 Karai of pure clay.
- 6 Karai of sea sand.

Foundation Mortar (from footer up to the damp-proof course).

- 1 Gallon of purified cow-dung liquid.
- 2 Karai of wood ash.
- 4 Karai of pure clay.
- 6 Karai of river sand.
- 2 Karai of anthill clay can be added.

Inside Plastering

- 1 Gallon purified cow-dung liquid.
- 1.5 Karai of wood ash.
- 2 Karai of pure clay.
- 5 Karai of river sand*
- * can also use a combination of 2 sea sand and 3 river sand.

Outside Plastering

- 1 Gallon purified cow-dung liquid.
- 2 Karai of wood ash.
- 2 Karai of pure clay.
- 6 Karai of sand (3 sea sand, 3 river sand).

KARAI

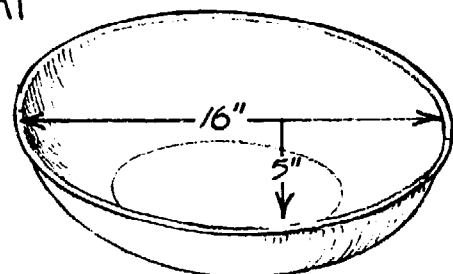

1 KARAI = 10 LITERS OR 4.5 US GALLONS

Figure 39

Concrete for Ring-Beam (Lintels)

- 1 Gallon purified cow-dung liquid.
- 3 Karai of wood ash.
- 4 Karai of pure clay.
- 6 Karai of sea sand.
- 8 Karai of 1/2" stones.

Cowdung Preparation Pits

The following drawings depict a cow dung preparation pit for the making of purified cow dung liquid.

Concrete for Floors

- 1 Gallon purified cow-dung liquid.
- 3 Karai of wood ash.
- 4 Karai of pure clay.*
- 6 Karai of sea sand.
- 6 Karai of 1/2" stones.
- * Can also add 2 Karai anthill clay.

The cow dung liquid is screened. In pure liquid form when mixed with wood ash and clay, it reacts chemically and hardens within a 24 hour period.

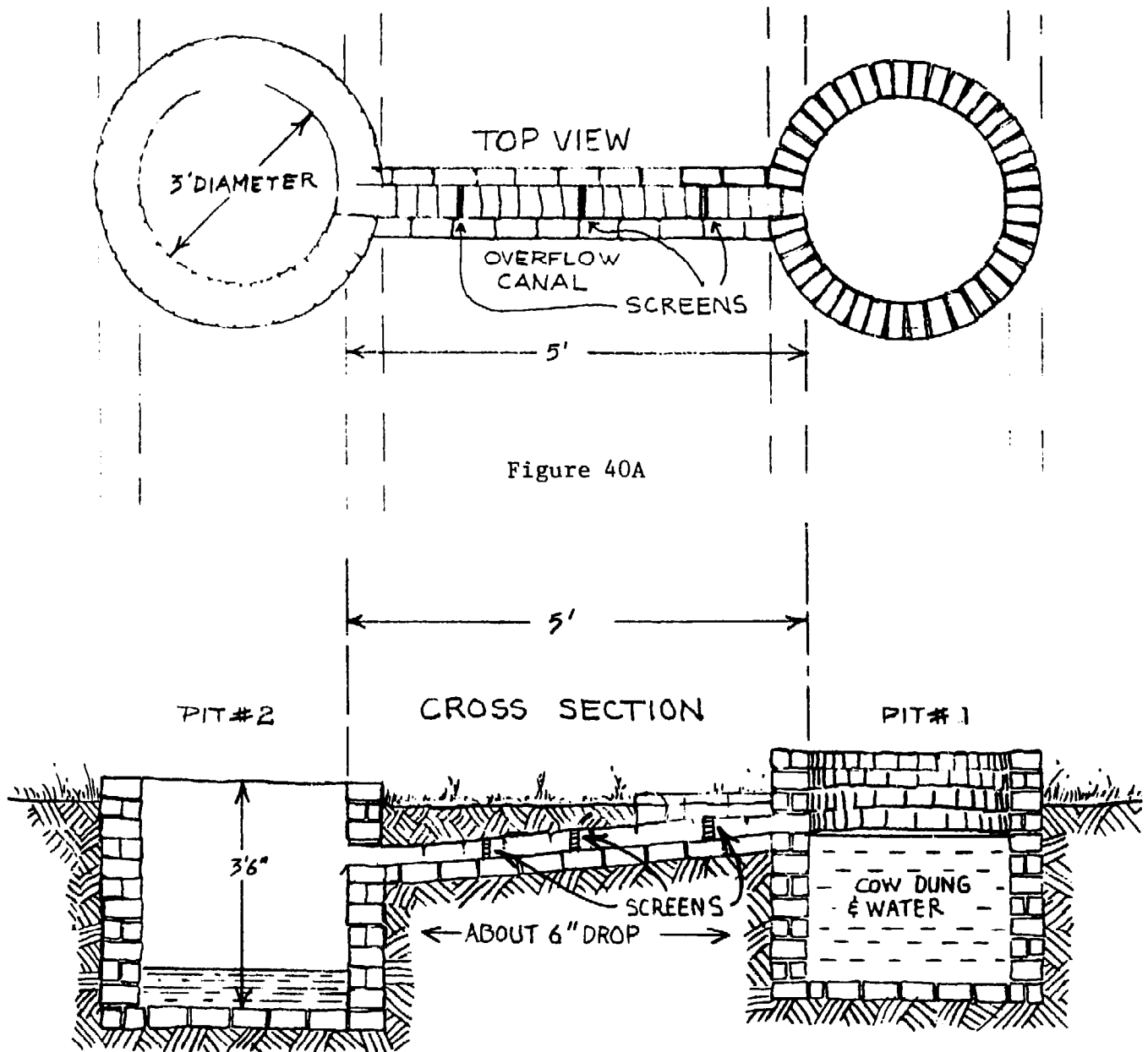

Figure 40A

Figure 40B

After constructing the pits, cow dung is put into the top pit to a depth of several feet. Add water and stir. Be sure to take out all impurities such as grass, sticks and other matter. The water level in the top pit should be close to the level of the screens. After several days, more water and dung are added, and the stirring is repeated. After collecting the purified liquid dung from the bottom pit, it can be used in clay and mortar mixes.

The advantages to using these alternative materials:

- 1) Locally available.
- 2) Little or no transport cost.
- 3) Low cost if one has to purchase.
- 4) Easy to use with some training.

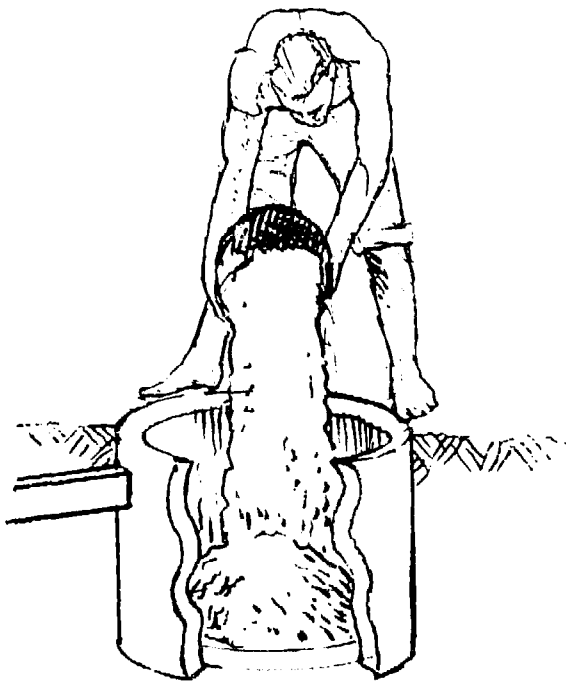

Figure 41

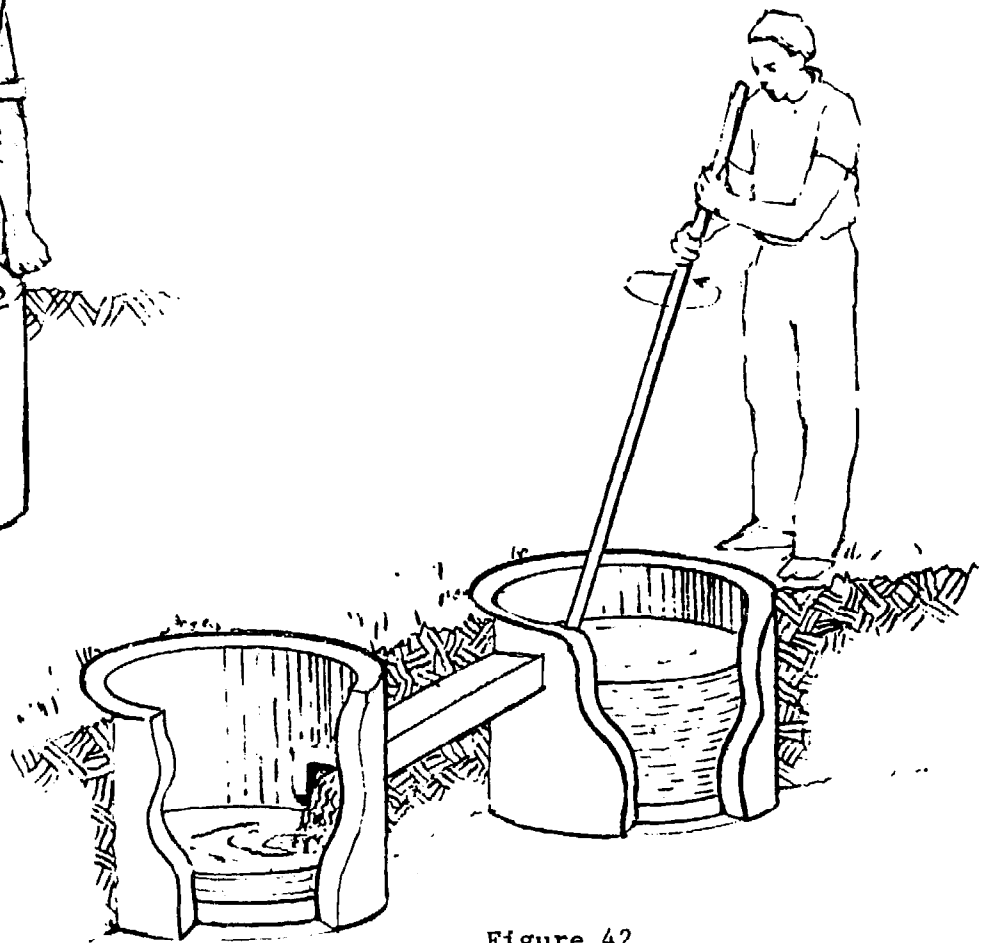

Figure 42

- 5) Attractive looking finished product.
- 6) Durable if properly constructed, and care in maintenance observed.
- 7) Adheres well with clay, wood ash, sand and water; strong mortar.
- 8) Labor intensive, employing many people.

Disadvantages are variable, depending on skill level, technique in processing, and means of applying the material in building.

- 1) Variable clay qualities and how thoroughly mixed.
- 2) Direct sunlight at the time of application can cause the mixture to dry too quickly, which can result in surface cracking, and weakness in the application.
- 3) Excessive rain or other water running directly on the materials for extended time periods may cause some deterioration.

Mixing Alternative Cements

The basic steps in mixing all the alternative cement and concrete mixes are the same. The techniques in mixing are very important. The following steps must be followed through from start to finish. In all cases, the use of clean water is critical. Sand and concrete stones have to be free of dirt and impurities. Clean water, sand and stones will adhere, bind and mix well with the clay, if all steps and procedures are followed.

Below is the mixing technique which should be followed for all alternative local cement mixes. Refer to specific recipes for the different mixtures and proportions.

Step 1: Prepare working area:

- a) make a level working surface in an area with an adequate water supply.
- b) free the area of roots, grass, trees, shrubs and other matter.

Step 2: Spread prepared clay on the ground in a 3 to 5 foot circle.

- a) add enough water to soften the clay and make it workable with feet and a hoe.

Step 3: Mix sand into clay by sprinkling; add anthill clay, if available.

Step 4: Add wood ash, mixing with feet.

a) should be very well mixed until all sand and the chunks of soil are well blended, smooth and sticky. When the feet are pulled from the mixture, and there is a suction sound, the mixture is ready for the addition of the cow dung liquid.

Step 5: Add cow dung liquid by sprinkling and mixing at same time.

Step 6: After the cow dung liquid is added and mixed well, add clean stones and blend in by mixing thoroughly.

Step 7: The mixture is ready for application.

ANTHILL KILN AND ANTHILL CLAYS

Anthill kilns have been known to be used in Uganda for approximately 100 years. There are various regions of Uganda, and Africa in general, where anthills are plentiful. In the wetter regions of southern Uganda, the use of anthills as a source of excellent clay and to make natural kilns has been very successful, due to the availability of water and the large numbers of anthills, which are sometimes as high as 12 feet above ground level.

The soil in an anthill is basically processed, regurgitated soil. After the ant has chewed the soil and processed it, a saliva coating is left on the particles of soil. This saliva reacts with the chemical properties of the soil, and after exposure to the sun, hardens firmly. The chewing motion and process mixes the soil as one would mix clay from a pit with one's feet, or with a hoe. This pre-mixed clay provides desirable qualities for brick and clay moulding.

Once dug, the clay will be very hard and chunky. The clay chunks should be placed on a cleared, flat surface. Water is added, depending on the dryness of the soil, until the clay becomes sticky but not soupy. Mixing with a hoe and with feet is necessary until all stones are cleared away and the soil chunks are dissolved to make a smooth mass.

The sticky clay should be placed in a pile at least 3 feet high, and from 3 to 4 feet wide. Water is added, and the sides are smoothed down.

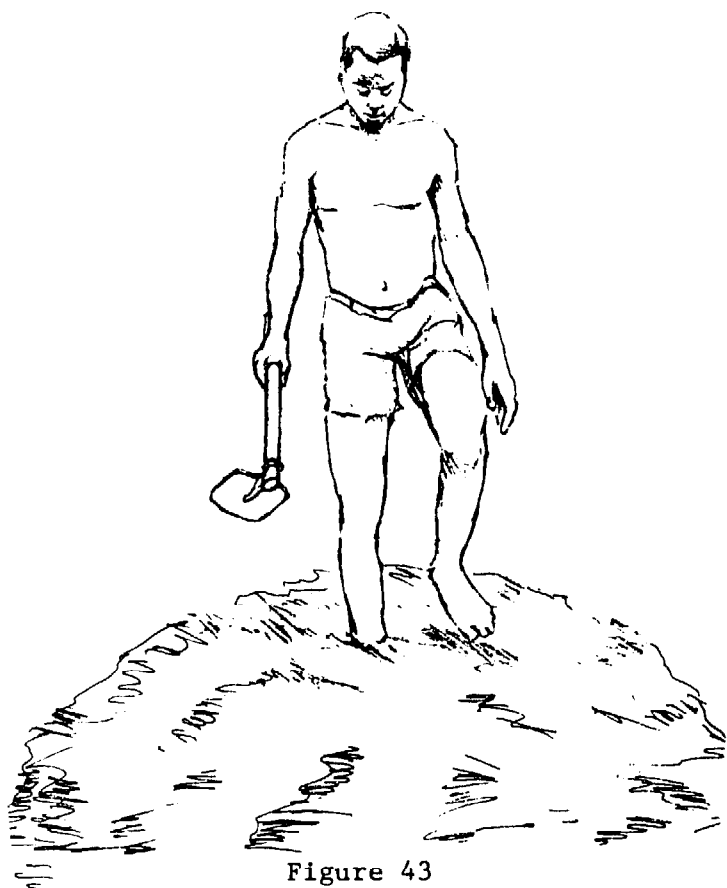

Figure 43

After smoothing down the clay pile, it should be covered with grass, and then sprinkled once again with water, depending on how hot the weather is, and also the season of the year when the work is taking place. More moisture is needed in the dry season.

The pile should be allowed to stand and to ferment for 7 to 10 days, and then broken down and mixed thoroughly again. Next, it is piled up again into the same kind of pile, covered, and allowed to ferment again for a few more days, or until one is ready to use the clay.

At this point, one is ready to set up a moulding bench and to begin the moulding process, described in an earlier section. (See page 10).

After moulding, the bricks should be dried in the sun for at least two weeks.

After drying is completed, stack the bricks in the excavated anthill,

leaving 2 or 3 fireholes, depending on the size of the anthill. The top can be mudded or plastered over, leaving space for 2 or 3 smoke vents, which are approximately 2' square.

The anthill cavity will provide space for approximately 5,000 to 10,000 bricks. The anthill can be dug out in such a way that it has three natural sides, made up of the left, right and back walls, which are from 2' to 3' thick. The front side is open. The depth, both downwards and to the back wall, will be determined by the size of the anthill and the nature of the terrain. The three closed sides act as perfect insulating walls to hold in the heat when the kiln is fired.

Advantages of anthill kilns are:

- 1) The clay is on-site; no transport costs.
- 2) Use less fuel and labor, thereby reducing cost, effort, and procurement and transport of fuel.
- 3) Bricks are thoroughly burned due to reduced heat loss, compared with man-made kilns.
- 4) Considerable reduction in labor costs for making bricks, because the pit created by digging for clay becomes the kiln.

Some disadvantages of anthill kilns:

- 1) It is impractical to make a kiln from an anthill if there is a lack of nearby water. If there is no water, there is no way to mix.
- 2) Limited volume of brick production depending on the size of the anthill (up to 10,000 bricks usually)

ANTHILL KILN

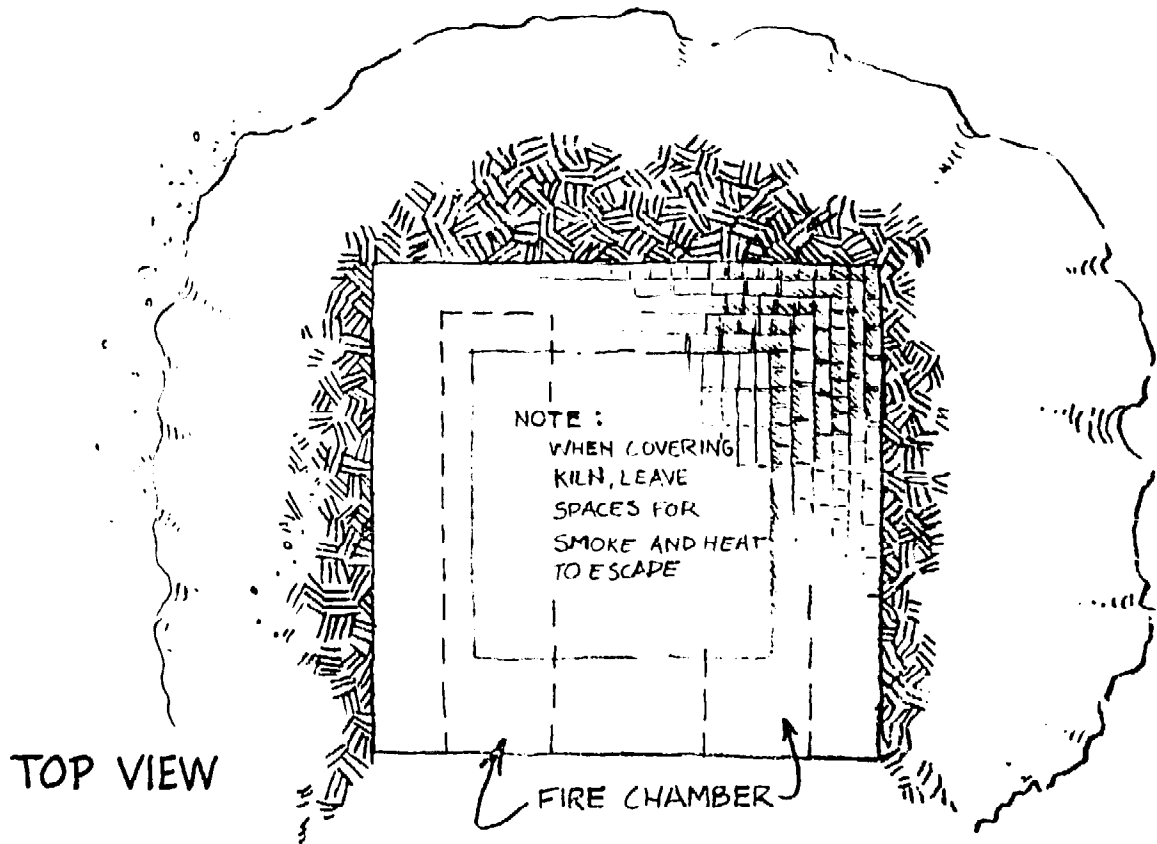

Figure 44

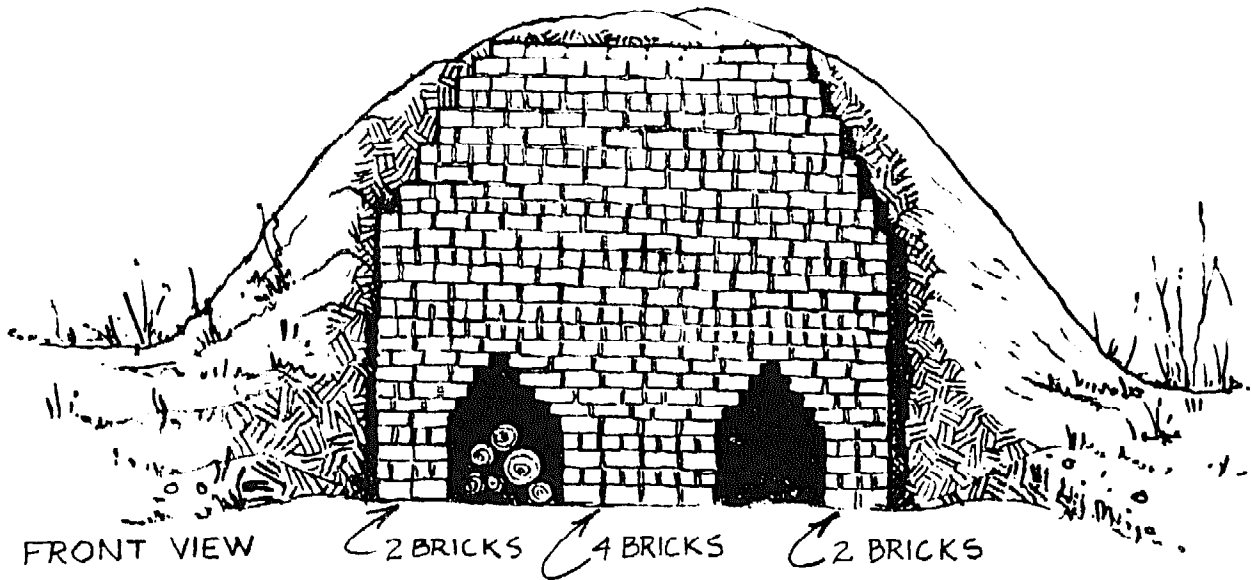

Figure 45

LOCALLY AVAILABLE PAINTS AND PAINT COLORS

Paint from the soil:

Local paints have been used in Uganda and in many parts of Africa for several hundred years. There are two ways to find, make and use local paints: (a) from the soil itself, or (b) from certain plants. However, only two plants, the sweet potato and cassava are in much use as sources of paint in Uganda today.

Most of the soil colors for paints are found in hilly, semi-arid areas. The reason for this is that the excessive moisture near rivers and lake beds makes soil color differentiation and extraction very difficult.

Yellow, white, black, pink and red are the most commonly known and used soils. These are to be found in the dryer hilly regions. Most of the desirable colored soils for paint pigments can be found at depths of from 10' to 30' underground. The top 10' or so are usually the sub-soils, sand, gravel and different variations of clays. The colored soil or soft-rock will be abundant after the digging pit has been cleaned out and the colored rock removed.

The different colors come at various levels and depths. Most of the rock will be either yellow, brownish, rust or whitish in colour. After extraction, the stone or soft-rock must be pounded in a soft, talc-like powder.

Making paint from soil:

- 1) Boil 5 gallons of clean, clear water.
- 2) Add 1 pound of salt.
- 3) Then add 2 Karai of the powdered stone and soil, the color of your choice.

- 4) Mix until the substance is a thick blood-like consistency.
- 5) Using either a hot or cold mixture, paint on surface with brushes.

Under normal climatic conditions, a coat of this paint will last several years before repainting is necessary.

Paint from plants:

As stated above, paints from cassava and sweet potatoes are most commonly used today. Both of these are root plants and must first be pulled from the ground after reaching their mature state. After they have been harvested, clean the soil from the roots and dry the plants in the sun, usually from 1 to 2 weeks.

Making paint from plants:

- 1) Crush the roots to a powder until there are no lumps.
- 2) Ready one gallon of cold or cooled water; must be clean and clear.
- 3) Add 4 kilos of the well-crushed, powdered root powder.
- 4) Bring to a boil. (Substance will be blood-thick).
- 5) After 30 minutes of boiling, add 1/3 gallon of banana juice*, and continue boiling for 15 minutes.
- 6) Let liquid cool. After cooling you are ready to paint.

***Making banana juice:**

Collect two bunches of sweet bananas, and allow them to become over-ripe. Put freshly cut banana leaves on the ground and start to crush the bananas. The crushing process should be done with a handful of green grass in each hand. The grass will collect

the juice, which can then be squeezed from the grass into a container.

The banana juice acts as an adhesive which is necessary to hold and bind the materials in the paint together. If a very sticky adhesive is desired, allow the juice to sit in the container for several days before blending it into the paint mixture.

In place of banana juice, rotten banana stems can also be used as a binder, again by squeezing to extract the juice. If there are no bananas in the area, sugar cane can be substituted. Boil it, let the juice dry, then crush and boil with water.

Local Paint Brush: Palm tree leaves can be used to make a paint brush.

- 1) Cut several green leaves from the tree. Crush with stones until the leaves are very stringy.
- 2) Put into cold water and soak for 3 to 5 days, until soft.
- 3) Take out of the water and squeeze, and then roll until it sticks together.
- 4) Wash or rinse in cold water.
- 5) After washing, dry out the leaves for several days under the sun.
- 6) After drying, form into a brush, cutting the leaves to the desired length.
- 7) Tie on to a piece of wood, which is the handle, and begin painting.

MATHEMATICS

Fundamental Ideas in Geometry:

Many of the basic ideas in geometry are used by people every day. A contractor uses geometry in dividing his site into slabs, in figuring concrete and in planning a roof. The contractor continually makes use of geometric principles. He knows that he cannot turn a five-sided nut with an ordinary wrench. He is familiar with the circle, the square and various geometric forms as they enter into tools and land usage. When he does carpentry, he uses geometry constantly. Every use to which he puts his square depends upon geometry. We see geometric forms of utility and beauty on every side, in forms of nature, in buildings and bridges and in the field. In the study of geometry we are concerned with these forms in classifying and naming them, and in applying the facts of geometry in a definite and systematic manner to practical problems that arise in our work.

Angles:

Two straight lines that meet at a point form an angle. See Figure 46. The idea of what an angle is, being a simple one, is hard to define. One should guard against thinking of the point where the two lines meet as the angle. This point is called the **Vertex** of the angle.

The two lines are called the **Sides** of the angle. The difference in the direction of the two lines forming the angle is the magnitude, or size, of the angle. An angle is read by naming the letter at the vertex and at the ends of the sides. When read in the latter way, the letter at the vertex must always come between the two others. Thus, the angle in Figure 46 is read "the angle B", "the angle ABC", or the "angle at B."

The symbol \angle is used for the word angle. In this way we write $\angle ABC$ for angle ABC and $\angle A$ for angle A.

If one straight line meets another so as to form equal angles, the angles are **Right Angles**. In Figure 47, the angles ADC and BDC are each right angles. If a right angle is divided into 90 equal parts, each part is called a **Degree**. It is usually written 1° .

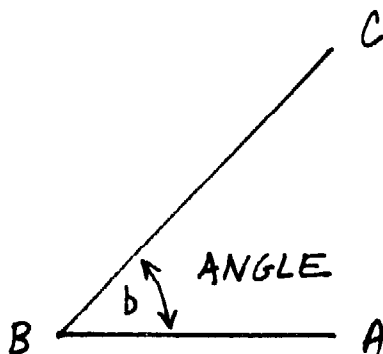

Figure 46

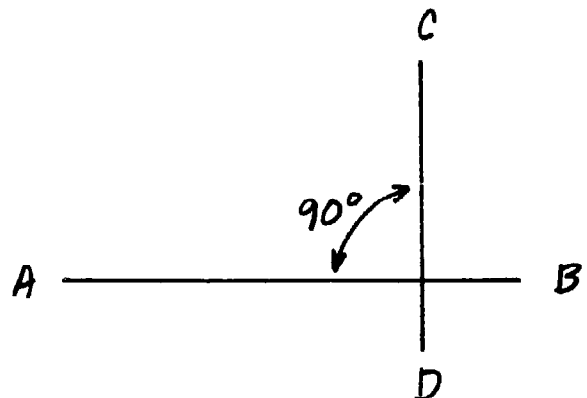

Figure 47

Applied Geometric Formula for Area and Volume:

The importance of a geometrical form in the study of practical mathematics is determined to a great extent by the frequency of its occurrence in application. In construction work, the rectangle is more frequently seen than other forms. There are also several other geometric shapes that are important. The following shapes and formulas have been identified as useful to builders.

Area of a Rectangle:

Find the area of a rectangle 6 feet x 3 feet.

$$A = L \times W$$

$$A = 6 \text{ ft.} \times 3 \text{ ft.} = 18 \text{ sq. ft.}$$

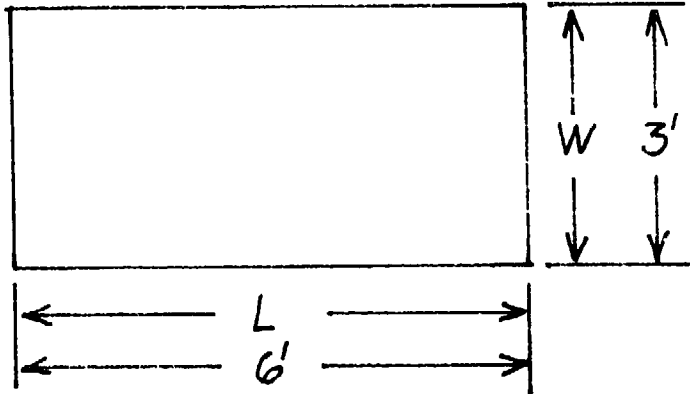

Figure 48

Area of a Parallelogram:

Find the area of a parallelogram.

$$H = 2 \text{ ft. and } L = 5 \text{ ft.}$$

$$A = H \times W$$

$$A = 2 \text{ ft.} \times 5 \text{ ft.} = 10 \text{ sq. ft.}$$

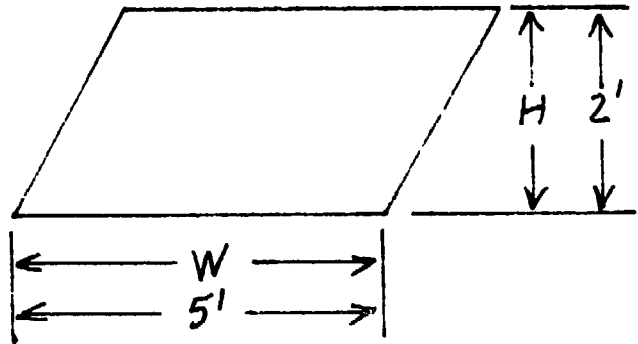

Figure 49

Area of a circle:

Find the area of a circle with a 3 ft. radius.

$$A = \text{Pi} (3.1416) \times r^2$$

$$A = 3.1416 \times 3' \times 3' = 28.2744 \text{ sq. ft.}$$

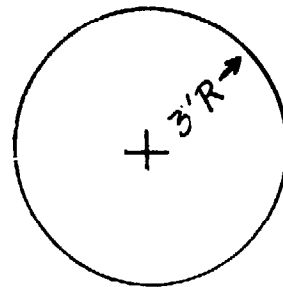

Figure 50

Surface of a Sphere:

Find the square feet of surface area on a sphere 4 ft. in diameter.

$$S = 4 \text{ Pi } (3.1416) \times R^2 = \text{Pi} \times D^2 = 12.57 R^2$$

$$\frac{D}{2} = R \quad \frac{4}{2} = 2 R$$

$$S = 12.57 \times 2 \text{ ft.} \times 2 \text{ ft.} = 50.28 \text{ sq. ft.}$$

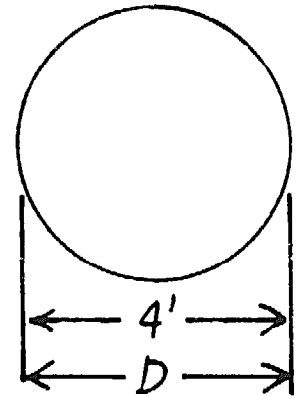

Figure 51

Volume of a Sphere:

Find the volume in gallons of a spherical water container. Inside diameter is 14 inches.

$$V = \frac{4}{3} \text{ Pi} \times R^3 = \frac{1}{6} \text{ Pi} \times D^3 = 4.189 R^3$$

$$R = \frac{D}{2} = \frac{14}{2} = 7$$

$$V = 4.189 \times 7 \times 7 \times 7 = 1436.8 \text{ cu. inches.}$$

$$1 \text{ gallon} = 231 \text{ cu. ins.}$$

$$V \text{ gallons} = \frac{1436.8}{231} = 6.22 \text{ gallons}$$

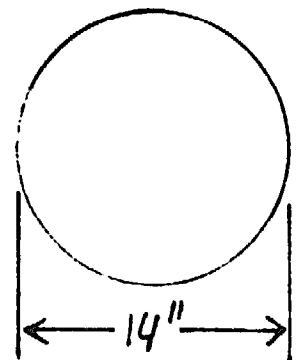

Figure 52

Find the area of a trapezoid:

5 ft. across the bottom. 7 ft. across the top. 2 ft. in height.

$$A = \frac{L + L}{2} \times H$$

$$A = \frac{7' + 5'}{2} \times 2' = 12 \text{ sq. ft.}$$

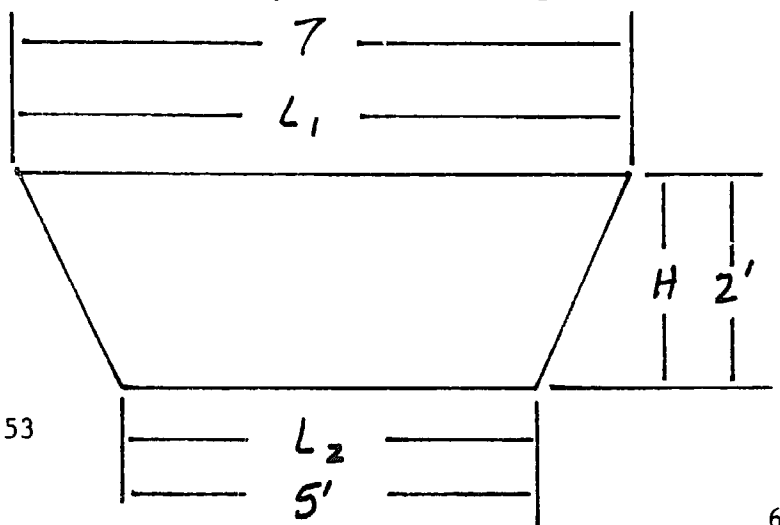

Figure 53

Area of a Triangle:

Find the area of a triangle with a base of 4 ft. and height of 3 ft.

$$A = \frac{1}{2} B \times H$$

$$A = \frac{1}{2} \times 4' \times 3' = \frac{12}{2} = 6 \text{ sq. ft.}$$

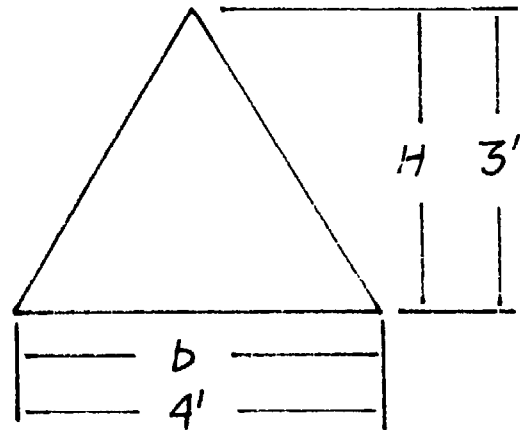

Figure 54

Volume of a Cube:

Find the volume of a cube 3 ft. on each side.

$$V = L \times L \times L$$

$$V = 3' \times 3' \times 3' = 27 \text{ cubic ft. (1 cubic yard)}$$

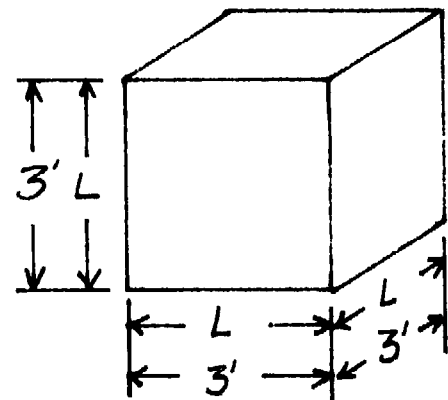

Figure 55

Volume of a Rectangular Prism:

Find the volume of a rectangular prism with a width of 3 ft., height of 3 ft., and length of 6 ft.

$$V = 3' \times 3' \times 6' = 54 \text{ ft}^3$$

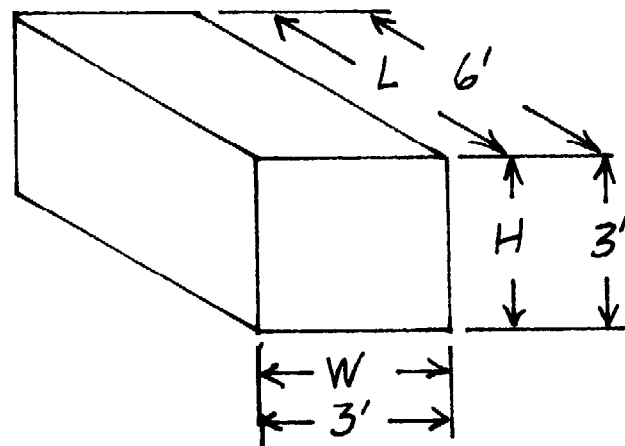

Figure 56

Circumference of a Circle:

Find the circumference of a circle with a 3 ft. radius.

$$C = \text{Pi} \times D, \text{ or } 2 \text{ Pi} \times R$$

$$C = 2 \times 3.1416 \times 3' = 18.8496 \text{ ft.}$$

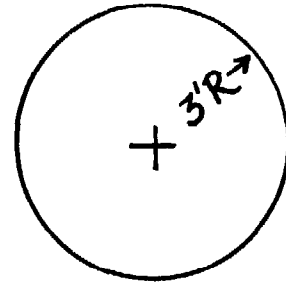

Figure 57

Summary of Formulas:

Parallelogram, Rectangle, Square:

$$A = ab,$$

$$a = A \text{ divided by } b,$$

$$b = A \text{ divided by } a.$$

Triangle:

$$A = \frac{1}{2} ab,$$

$$a = 2A \text{ divided by } b,$$

$$b = 2A \text{ divided by } a,$$

$$A = \sqrt{s(s-a)(s-b)(s-c)} \text{ where } s = \frac{1}{2} (a + b + c)$$

Right Triangle:

$$c = \sqrt{a^2 + b^2}$$

$$a = \sqrt{c^2 - b^2}$$

$$b = \sqrt{c^2 - a^2}$$

Trapezoid:

$$\frac{A}{2} = l (a + b) \times h$$

Circles:

$$C = \text{Pi} \times d$$

$$A = \frac{1}{2} Cr$$

$$d = C \text{ divided by Pi}$$

$$A = r^2$$

$$C = 2 \times \text{Pi} \times r$$

$$A = \frac{1}{4} d^2 = 0.7854 d^2$$

$$2r = C \text{ divided by Pi}$$

Segment of Circle:

$$r = \frac{(\frac{1}{2} w)^2}{2h} = h^2$$

$$h = r - \sqrt{r^2 - \frac{(1w)^2}{2}}$$

$$w = 2 \sqrt{h \times (2r - h)}$$

Ring:

$$A_r = A - a^6 = \text{Pi} \times R^2 - \text{Pi} \times r^2 = (R^2 - r^2) = \text{Pi} \times (R + r) (R - r)$$

Concrete Mixes and Calculation of Cubic Yardage

It is often necessary to repair broken concrete, to build a wall, or to apply concrete to a surface. These activities require some knowledge of making concrete, which is a mixture of cement, sand and gravel. The cement is the bonding agent which hardens and holds everything together.

A good mixture for slab blocks or sidewalk repair is 1:2:3. This means one part cement, two parts sand and three parts gravel. Concrete retaining walls which support slopes, or stem wall in subfoundations, will require a mixture of 1:2:2 (one part cement, two parts sand and two parts gravel).

The aggregate size used will depend on the type of work to be done. Generally, aggregates should not be larger than 1/4 the thickness of the concrete slab to be constructed, but normally 3/8" to 1" gravel is used.

In concrete that is subject to severe wear, to weathering or to weak acid or alkali solutions, 5 gallons of water per sack of cement should be used. For concrete that is to be water tight, or subject to moderate water and weather, use six gallons of water per sack of cement. For foundations, walls, footings and massive concrete construction, seven gallons of water for each

sack of concrete is suggested. It is assumed that the sand and aggregate are dry.

A cubic yard is the measure used for concrete. Thus, the amount of concrete required for a given job will be computed on the basis of the total number of cubic yards in the job.

A Problem to Practice With:

A foundation is to be poured for a building. The outside dimensions are to be 20 feet by 50 feet. The foundation is to be 6 inches thick, extending 18 inches above a 30 inch wide and 6 inch deep footing. As an aid against overturning, the footing can be extended 18 inches beyond the outside of the foundation.

How many cubic yards of concrete will be required? What is the maximum aggregate size that should be used?

Procedure:

1. Draw a cross section diagram of the foundation as illustrated:

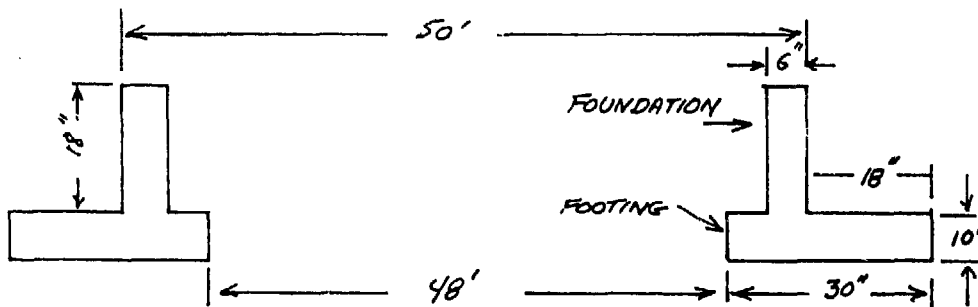

Figure 58

2. Determine the aggregate size. The thickest cross-section is six inches. $1/4 \times 6 = 1$ and $1/2$ inches. Aggregate should not exceed this size. ($3/8$ " to 1" gravel is more typical).
3. Determine the number of cubic feet in the footing section:

$$(23' + 23' + 48' + 48') \times \frac{30''}{12} \times \frac{6''}{12} = 138 \text{ ft.} \times \frac{5 \text{ ft}^2}{4} = 177.5 \text{ cubic feet.}$$
4. Determine the number of cubic feet in the foundation section:

$$(20' + 20' + 49' + 49') \times \frac{6''}{12} \times \frac{18''}{12} = 138 \text{ ft.} \times 3 \text{ ft}^2 = 103.5 \text{ cubic feet.}$$
5. Total the two sections and compute for the total number of cubic yards of concrete required:

$$177.5 + 103.5 = 281 \text{ cubic feet}$$

$$\frac{281}{27} \text{ cubic feet} = 10.4 \text{ cubic yards.}$$

Calculating Strength for Wooden Beams:

There are three classes of beams illustrated. They are **Continuous**, **Simple** and **Cantilever**.

The **Simple Beam** (Figure 59) is supported at each end by a bearing wall.

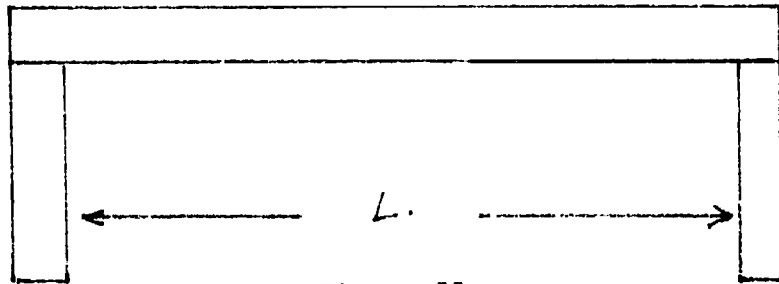

Figure 59

The **Continuous Beam** (Figure 60) is supported in its center. This type of beam is always supported at one or more places along its length.

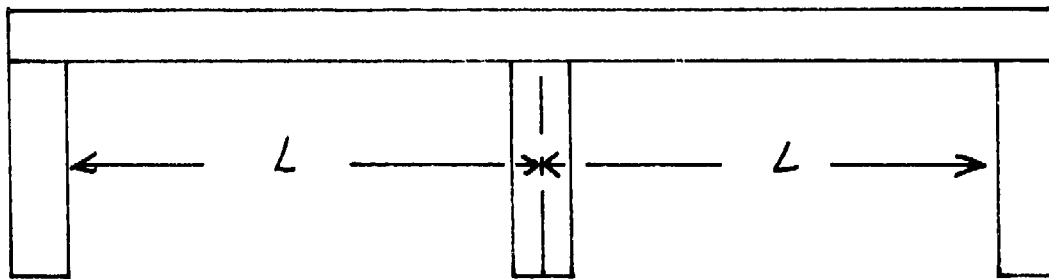

Figure 60

The **Cantilever Beam** shown in Figure 61 is rigidly supported at one end.

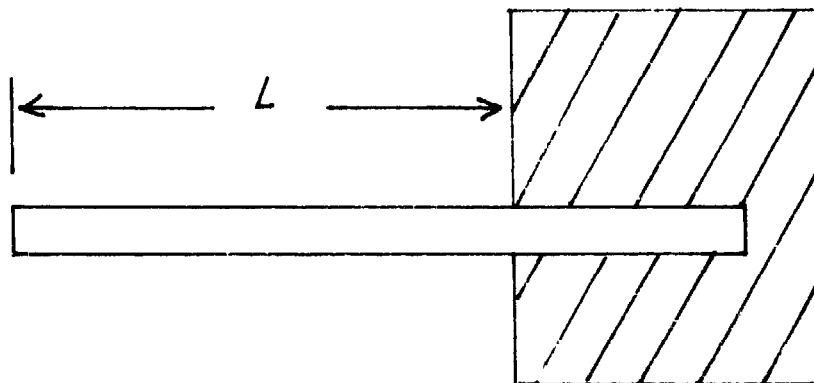

Figure 61

The strongest beam shown per foot of length is the continuous type. For each of these beams the formulas below are used to determine the correct dimensions.

Type of Span	Concentrated Load At Center of Span	Uniformly Distributed Loads
Continuous	$BM = \frac{1}{6} WL$	$BM = \frac{1}{12} WL$
Simple	$BM = \frac{1}{4} WL$	$BM = \frac{1}{8} WL$
Cantilever	$BM = WL$	$BM = \frac{1}{2} WL$

BM = Bending Moment of Span
W = Load in Pounds
L = Length of Span in Inches

Wood is of such variable quality that a safety factor of 6 is usually used. The average safe fiber stress (SFS) for most wood in use is 1200. Woods with knots and other defects would have a lower figure.

$$\frac{BM}{SFS} = SM \text{ (Section Modulus)}$$

The section modulus of a rectangular beam is $SM = \frac{1}{6} bd^2$

where b = the breadth of the beam in inches, and
d = the depth of the beam in inches.

$$\frac{BM}{SFS} = 1bd^2$$

A Problem to Practice With:

A house is built of brick. One room is left open with an 11 foot width opening. The space above the opening is enclosed in a cut stone wall 16 inches in thickness and 5 feet high. If the beam for this opening is made out of seven inch material, what is the depth thickness required?

Procedure:

- Determine the weight of the load on the beam.

$$W = \frac{16''}{12''} \times 11' \times 5' \times 172 \frac{\text{lbs.}}{\text{ft.}^2} \text{ of brick}$$

$$W = 12,607.6 \text{ pounds, or approximately } 12,600 \text{ pounds.}$$

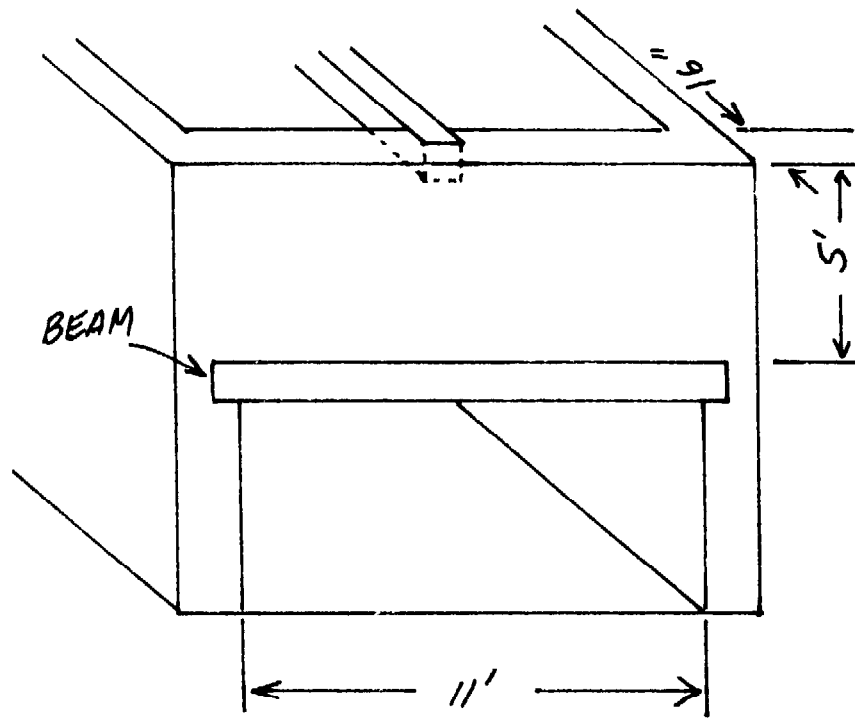

Figure 62

- Refer to formulas on preceding page; select formula for a simple beam with a uniformly distributed load and solve for BM (bending moment).

$$BM = \frac{1}{8} WL$$

$$BM = \frac{1}{8} \times 12,600 \text{ lbs.} \times 11 \text{ feet} \times 12 \text{ inches per foot.}$$

$$BM = 207,900 \text{ inch-pound.}$$

- Use 1200 for the safe fiber stress in bending for wood material. Dividing the bending moment (BM) by the safe fiber stress (SFS) for the material gives a figure from which the size and shape of the beam can be determined. This term is called the **section modulus (SM)**. This relationship is expressed by the formula:

$$\frac{BM}{SFS} = SM$$

The formula for the section modulus of a rectangular beam is:

$$SM = \frac{1}{6} bd^2 \quad (b = \text{breadth of beam in inches; } d = \text{depth in inches}).$$

$$\text{Thus, substituting in, } \frac{BM}{SFS} = \frac{1}{6} bd^2$$

$$\text{Or, } \frac{207,900}{1200} = 173.25 = \frac{1}{6} bd^2$$

Using b as $173.25 = \frac{1}{6} \times 7d^2$

$$d^2 = 173.25 \times \frac{6}{7} = 148.50$$

d = the square root of 148.50

d = 12.18 inches.

The dimensions of the beam are 7 inches width, and 12.18 inches depth.

SYMBOLS AND ABBREVIATIONS:

@ at
" inch
C degrees celsius (centigrade)
cc cubic centimeter
cm centimeter
cm/sec centimeters per second
d or dia diameter
F degrees fahrenheit
kg kilogram
km kilometer
m meter
ml milliliters
mm millimeters
R radius

USEFUL NUMBERS:

1 cu. ft. of water weighs 62.5 lbs. (approx.)
1 gal. of water weighs 8 1/3 lb. (approx.)
1 gal. = 231 cu. in.
1 cu. ft. = 7 1/2 lb. (approx.) or better, 7.48 gal.
1 in. = 25,4001 mm.
1 ft. = 30.4801 cm.
1 m. = 39.37 in.
1 kg. = 2.20462 lb. (avoirdupois).
1 liter = 1.05668 qt. (liquid) = 0.90808 qt. (dry)
1 qt. (liquid) = 946.358 cc. = 0.946358 liter, or cu. dm.
1 qt. (dry) = 1101.228 cc. = 1.101228 liters, or cu. dm.
Pi - = 3.1416 = 3 1/7

WEIGHTS:

1 pound	=	16 oz.
1 lb.	=	453.5924 grams
1 short ton	=	2000 lbs.
1 short ton	=	907.2 kilograms
1 metric ton	=	1000 kilograms
1 pound	=	0.45359 kilogram

WEIGHTS OF SUBSTANCES:

<u>Product:</u>	<u>Approximate Net Weight In Pounds per Cubic Foot:</u>
Brick Work	125
Cobblestone	150
Concrete	150
Flint Rock	165
Granite	172
Gravel	100
Gasoline (petrol)	42
Limestone (solid)	165
Limestone (ground)	82
Oil lubricating	57
Sand	110
Sand Stone	147
Water	62.3

LINEAR MEASUREMENT:

1 foot	=	12 inches
1 yard	=	3 feet
1 mile	=	5280 feet

AREA MEASUREMENT:

1 hectare	=	2.7109 acres
1 acre	=	0.40468 hectare
1 acre	=	4840 sq. yards
1 acre	=	43560 sq. ft.
1 sq. mile	=	640 acres
1 sq. mile	=	259 hectares
1 sq. mile	=	2.59 sq. kilometers
1 sq. kilometer	=	0.381 sq. miles
1 sq. kilometer	=	100 hectares

CHAPTER V PLANNING AND MANAGEMENT

INTRODUCTION

The planning of a building project, and the management of the whole construction process from the initial design to completion of the actual structure, are very important. Lack of knowledge of the elements of planning and management often lead to unnecessary problems. Accordingly, the Kiteredde Construction Institute provides course work and practical field experience for its trainees in these subjects. The entire course cannot be reproduced in this manual, but an outline of its basic components might serve as useful guidelines for builders and for other technical training institutions. The material which follows is designed for KCI trainees and graduates who are interested in or engaged in the management of their own small construction firms.

The statement was made at the start that one purpose of this manual was to serve people in areas where few if any imported or manufactured materials are available. This remains true, but it is important for KCI students and graduates to have a broader knowledge of the construction field, in addition to knowing how to use local materials well, and hence additional elements are incorporated into the curriculum and into practical work.

SECURING AUTHORITY

1. All local authorities who have any responsibility for buildings and construction should be acquainted with the project. The application to plan and build should state the purpose of the project, what the building is to be used for, why it must be built, its general size and location, and what funds or financial arrangements have been secured. Final permission

in writing should be secured on the basis of approved plans, specifications and cost estimates before any expenditure is made.

2. Be sure of all necessary government permission before entering into any financial obligations. Almost invariably this will require an official government stamp or signature of approval on the plans or in a letter.

3. Inform yourself in advance about municipal or district building laws, conditions, fees, inspections, sanitation and lighting. Consider the costs and compensation for land purchase, and the costs and requirements regarding survey fees. Paths or roadways through a site are sometimes objectionable, and the builder must be acquainted with the laws respecting the opening or closing of thoroughfares. One must also be aware of all issues regarding land titles.

4. Financial ability. Consult with those who have erected similar buildings. Compare prices and conditions. Be sure there is enough money to complete a sizeable unit of the work before bringing a crew of workmen to the job. Secure written authority for purchasing necessary materials, for wage expenditures and other costs, and written authorization for expenditures up to a specific limit or ceiling. Once authorizations and funding are secured, considerable caution needs to be exercised to keep within understood spending limits. As a general rule, actual construction activities should cease before all the money is used up, because there are many additional expenditures connected with the process of closing down a construction job.

5. Consider the reactions of associates, neighbors and others. Although they may have no legal authority to hinder the project, they may feel that the building project is offen-

sive to them or an inconvenience, and may take actions which disrupt or delay construction efforts. It is important to identify potential problems in advance, and to work out the necessary understandings prior to the start of construction.

Scanning the Future

1. One may not be able to build very much at one time. One can, however, envisage and draw up a complete set of buildings for a project, and then build permanent units, one at a time if necessary, until ultimately an organized, efficient, attractive and durable project has been developed.

2. The Unit System. It is much more satisfactory to plan a properly appointed house or building, and to build it section by section, as time and money allow, over a period of time. This is preferable to restricting the main plan at the outset by planning something inadequate, which requires additions, alterations or even abandonment, and can never be brought to perfection or satisfactory completion.

3. Permanence. Determine that every building is designed to be permanent. To this end, lay out the whole site with a 25 year perspective in mind. Sketch in every possible additional building or feature. If it is necessary to live in some smaller building until the main dwelling is erected, put up a garage, workshop, kitchen block or other outbuilding in its proper place, and of permanent construction.

Survey of Operations

Start to plan early. The planning process includes policy, the design, the method, the proper season, the schedule, the builder's arrangements, orders for materials or gathering them oneself, and many other factors.

The following calendar or schedule can be used as a guide to enable one to see at a glance the full scope of building activities, and to have all the materials, personnel and preparation ready and moving along the work path on a timely basis.

General Building Calendar

Necessity for the project to be thoroughly established.
Government approval.
Financial ability.
Conference of interested parties.
Rough sketch.
Proper drawings and specifications
Estimates.
Final authority to go ahead in writing from Government or appropriate authority.
Orders for all materials, labour and transportation.
Contracts awarded.
Lumber sawed or purchased.
Bricks made.
Work and storage sheds erected.
Make scaffold, frames, doors, windows and built-in cabinets or furniture.
Local materials gathered.
Building site cleared.
Construction begins: Layout
Excavation.
Footings and foundation walls.
Concrete mortar and coursing.
Door and window frames set in walls; arches built.
Main walls built.
Begin roof frame.
Roof frame erection.
Ceilings made and erected.
Plumbing, wiring, built-in cupboards, etc.
Inside plaster.
Doors and windows fitted and hung.
Concrete floors, verandahs, steps, foundation pointing.
Interior trim, screens.
Painting and glazing.
Grading and drainage.
Inventory, salvage, completed

records, wind up and completion of entire building project.

Policy

A wrong policy or attitude will produce trouble or difficulty in any construction enterprise sooner or later. It is suggested that a building policy be formulated, with the following as a guide:

1. Efficiency. Efficiency means that the completed structure can adequately serve the specific purpose or purposes for which it was designed. It should have sufficient room for all activity, and for furniture, equipment, special features, storage and other needs. The plan should be arranged so that all occupants will have any and all reasonable convenience. Health should be safeguarded by providing sufficient cubic air space, ventilation, shade, privacy, quiet, and protection from insects and dampness. The builder should be aware of curtailing the efficiency of a structure by overemphasizing or misapplying economy.

2. Durability. Ruskin says, "When we build, let us think that we build forever." Most of us are not in a position to build forever, but we can at least build durably. Although we may not be able to afford granite, marble, bronze, or elegant tilework, we should not on the other hand be satisfied with shacks and huts for dwellings, or inferior structures for schools or health aid posts. There should be sufficient durability to withstand weight and stress, decomposition and weather, wear and abuse, infestation by insects and invasion by animals or man. Thus in terms of structural integrity, a builder must resist the temptation to save a few shillings at the expense of the basic strength of the building. It is false economy to cut below sound construction and practical efficiency. The

objective should be to design and erect efficient, durable buildings economically.

4. Form and Finish. This means making the most out of what is available and necessary, and finishing the job as attractively as possible. Good finish work enhances the value of a building property by giving it a pleasing appearance, as well as by preserving it. Proper colours also contribute to restfulness, light, coolness and general satisfaction.

Seeking Advice

There are many costly pitfalls and problems in the planning and erection of a building. Since the construction of a house or other building is the major expenditure in a lifetime, for many of us, we should make every reasonable effort to secure the advice of an experienced builder. When we must build without the benefit of such advice, we should:

1. Carefully plan everything that we make or build.
2. Make all changes and mistakes on paper.
3. Place all the basic ideas on paper for the benefit of those who will have a part in the project, before, during and after construction.

Any building is an investment as well as a utility. By thorough planning, and the use of good materials, labour and construction methods, one can avoid unnecessary expense, inefficiency and dissatisfaction. As a general rule, mistakes in design and construction are readily visible and apparent, are costly, and tend to be permanent.

Selecting a Site.

It is unwise to make the final decision on a building design until the site has actually been secured, and all its important features are known.

A house which is satisfactory on one site, may not necessarily be as good or as acceptable on another site. One should gather and assess information about the conditions on and around the proposed site in all seasons with respect to its suitability for:

1. Health: Temperature, humidity, altitude; the time, force or value, and the direction of winds; soil erosion; swamp; rainfall; the prevalence of disease; proximity to unsanitary conditions in nearby places over which you have no control; depth of soil; the presence of large rock masses which radiate heat; the presence and value of trees; whether the site is on a hill or situated on a plain or in a valley; its proximity to other buildings, and the character of those buildings.

2. Work: Accessibility to and from other people, centres of population and appeal, government favour; proximity to places of work and other jobs.

3. Building Conditions: Enquire about supplies, labour, weather, building by-laws, restrictions and plans for future developments. On occasion an area is found which is quite unsuitable for a building or a compound.

4. Environment: This is particularly important in areas which have been built-up or which are crowded. The proximity of the proposed site to congested areas, or to institutions, roads, rivers, heavy lorry traffic, dust and air pollutants, and other features should be examined.

Business Detail

Estimates: If a completed building costs more than originally expected, it is generally due to the lack of estimates, or the lack of care or experience in their preparation. An

outline guide for estimates should include:

- I. The Compound or Site
- II. Lumber
- III. Wall Materials
- VI. Cement
- V. Roofing
- VI. General Hardware
- VII. Imported Goods
- VIII. Local Building Materials
- IX. Building Equipment and Tools
- X. General Wages
- XI. General Expenses

I. The Compound or Site

1. Clearance, grass, bush, trees, rocks, buildings.
2. Wells, digging, preparation of bottom, top, sides of well.
3. Roads, entrance to compound or site, access.
4. Grading, cutting down knolls, filling holes, terracing.
5. Drainage, ditches, culverts, bridges.
6. Equipment for digging, cleaning, hoisting, climbing, clearing.

II. Lumber

1. Production, sawmill or sawyer contract, saws, file, carriage.
2. Uses:
 - a. Temporary dwelling and furniture.
 - b. Equipment, ladders, scaffold, saw benches, brick making moulds, tables, hardware, racks for materials.
 - c. Shop, tool sheds, workbenches, material shelters.
 - d. Frames, doors, windows, wall ventilators, built-in cupboards, battens, door and window stops.

- e. Roof, posts, verandah and wall plates, rafters, ties, struts, purlins.
- f. Ceilings, joists, support beams, trap doors and frames.
- g. Doors, windows, shutters, screen frames.
- h. Miscellaneous: beams, sills, lintels, trusses, stairs and steps.
- i. Furniture and equipment.

III. Masonry

- 1. Stone for footings, foundation walls and main walls, verandah and floor.
- 2. Brick for all purposes in all buildings; manufacture and transport.
- 3. Concrete block construction. Cement, sand, water, machine manufacture or rental, contract, transport of blocks, curing.
- 4. Other types of wall, materials and labour.

IV. Cement and Lime

- 1. Floors.
- 2. Foundations, footings, pointing.
- 3. Plaster.
- 4. Miscellaneous: window sills, platforms, well tops, steps, water tanks.
- 5. Lime for plaster, whitewash, mortar.

V. Roofing

- 1. Sheet metal formant coursing.
- 2. Roofing, including ridging, gutters, down pipes, facing.

- 3. Ceiling.
- 4. Doors and windows.
- 5. Miscellaneous: stove pipes, sinks, brackets, shelves, funnels, weather strips, furniture reinforcement, ventilators, chimney caps, roof flashing.

VI. General Hardware

- 1. Common nails for equipment, tool boxes, stores, benches, brickmaking or block-making equipment, lodgings, scaffold, bracing, frames, doors and windows, roof framing, ceilings and furniture. Old nails for driving into brick walls to hold plaster. Special nails for furniture. Galvanized nails for roofing. Tacks for screens.
- 2. Screws for hinges, hasps, locks, frame ties, fittings.
- 3. Bolts for roof, roof iron, equipment.
- 4. Hinges for doors, windows, traps, screens, cupboards, hooks and eyes, door bolts and locks.
- 5. Handles and knobs for doors, drawers, shutters.
- 6. Bale or strap iron for frame ties, ceiling supports, trusses, roof ties, repairs, ladders.
- 7. Wire, mosquito screen for doors and windows, ventilators and food storage.
- 8. Water system, pipes, taps, fittings, tanks.
- 9. Expanded metal or woven wire for concrete reinforcement; thief guards for windows.
- 10. Rod iron for concrete lintel reinforcement, water tanks, roof frame pins, shutter fasteners.

11. Electrical supplies of all kinds.

12. Fire and lightning protection equipment.

13. Health and sanitation necessities.

14. Paints, oils, varnishes, stain, filler, turpentine, colours and pigments, lime, cement paint, glass, putty, tar, points, sandpaper, brushes for all purposes.

VII. Imported or Purchased Goods

1. Construction lumber, wall boards, doors, windows.

2. All house hardware.

3. Furnishings, curtains, blinds, rugs and mats.

4. Equipment, pump, building tools and garden tools.

VIII. Local Building Materials

1. Rock for foundations.

2. Sand for all purposes.

3. Water for mortar, concrete, sand washing, concrete curing, plaster.

4. Carrying receptacles for mortar, cement, water, mud.

5. Mats and poles for temporary shelters.

6. Lumber (timber) for scaffolding and roofing materials.

IX. Building Equipment

1. Picks, shovels, hammers, axes, crow bars, buckets, wheelbarrows, sand screens, trowels, level, string-line.

X. General Wages

1. Excavation fill, carriage of rock or mud from a distance, general labouring on the building, clean up.

2. Masons.

3. Carpenters.

4. Concrete work.

5. Plumbing.

6. Sheet metal work.

7. Electrical work.

8. Painting and decorating.

XI. General Expenses

1. Government fees, expropriations, survey, licenses.

2. Builder's expenses, travel, equipment, accommodations.

3. Transportation of materials and workmen.

4. Build or rent quarters for workmen.

If possible, secure a copy of cost estimates of a building similar to the one being planned. A review of these estimates and actual costs will bring out many items which should be factored into the new building plans, and which may not have been included in the initial estimates. The comments of the experienced builder regarding costs, as well as the conditions which helped or hindered the other construction job, could be

very helpful in thorough planning.

A building similar to the one being planned, or exactly the same, in a different locality or on a different site, may have cost considerably more or less. One should gather as much information as possible about actual building costs in the locality where the building project is planned.

Orders

The order is the final quantities list, giving only the particulars necessary to a business transaction in the purchase of materials.

To get the best service from your supply dealer, state for instance that 20 pieces of 2" x 6" are required for scaffold, 20 for frames, 20 for roof, 10 for doors, 10 for furniture, so that the right grade of lumber for each type of work will be supplied, if possible.

Write every order, for record purposes at least, including orders for trucking and for water, mud, stone, sand, and other materials. Then check up afterward and see that the full amount delivered is shown under the heading "materials ordered". Whether the material is ordered or not, paid for or contributed, write it down. Always keep a copy of your orders.

Contracts

Here again an experienced builder's advice is invaluable. Too many contractors are unable to give a fair figure or tender of the work. If you bid too low and one accepts your tender, there will be financial loss and bad feeling, or possibly there could be fraud and hard feeling the other way. It is poor business ethics to take advantage of an inexperienced and financially hard-pressed subcontractor or artisan by accepting a palpably low bid and trying to hold him to it.

Conversely, of course, contractors may try to take advantage of inexperienced builder-owners. Hence it is better for all parties if quantities and qualities of materials, and cubic content of concrete and masonry work are submitted to the contractor. It is also well to have at least two subcontractors bid for one job. The lowest tender is not necessarily the best. Nor is the highest bid a guarantee of good work. The best contractors are the best guarantee, and the best measure of a contractor's quality is previous work performed and the reports from his clients.

The contract, in writing, should always include:

1. The name of the final authority on the job, the one from whom the contractor takes orders and who is to interpret the plans and specifications for the owner. There should be also the name of a mutually satisfactory third party to adjudicate in case of difference of opinion between the contractor and the building superintendent mentioned above.

2. The interpretation of drawings and specifications. Generally the figures on the drawing are to be followed. State who is financially responsible if the contractor makes the wrong interpretation of two possible meanings, when two different interpretations are possible. He should seek interpretation if he is in doubt and pay for misinterpretation if he goes ahead on the wrong line.

3. The contractor's responsibility with respect to care of materials, equipment, and bad workmanship.

4. What amounts are to be paid as the work progresses, when they are to be paid, and on what basis. In this connection it is well to have the contractor's requisition for Saturday's wages in your hand on Friday night.

5. Bonus, if any, for completing the job by a certain date, and conversely, a penalty clause for going beyond a certain date.

6. Extra work. Any alteration or addition to the plan after the contract has been awarded. One solution is to agree on paying the contractor 10% or 15% on the cost of such addition or alteration. But the order for the extra work must be in writing, each party having a copy.

7. The contract may also have to include some arrangements about the kind of labour employed. Certain groups may have been found to be troublesome.

Accounting

It is excellent practice to have an account book for each building in which to record every expenditure and every item used. In other words, a record of the true cost. This record will be of assistance to yourself and other builders later on. Make remarks which will throw light on the conditions under which you carried out the project.

If all dates are properly entered, the account will show the amount of time taken for the whole job. There should be a record of how long the foundations, walls, roof, and concrete work have taken in the process.

The pay book itself may well be in duplicate, showing each man's pay day. The copy of this can be sent to the mission office. The account should show the quantities, grades and costs of all materials. Finally make a list, with costs, of all left-over materials and equipment. Complete the whole project in every detail as soon as possible and wind up all accounts.

Care of Materials

1. Lumber: Lumber should be stacked on strong, straight cross pieces about 2'6" apart so that when the pile is completed it will be held in its original straight position. If the lumber is very green it should be stacked with considerable air space, but not in such a way that the lumber will warp.

Protect the wood from sun, rain, pilfering. The ends of the sticks tend to split. It may be necessary to hang a mat or old cloth over the end of the pile and soak it occasionally.

It pays to be on hand to supervise the drawing of stock. See that wood suitable for each job component is taken, otherwise the best will be taken first, and the final tasks will be carried out with wood of lesser quality. See that the pile is left in a neat condition. If sticks get left here and there during the day, have them picked up and stacked again. They will soon warp if they are left out in the open.

2. Cement: This material is so susceptible to moisture that it is very difficult to keep it strictly dry through a rainy season. Keep it off the floor and in the driest room available. If it has to be kept over the rainy season, attempt to seal it in absolutely waterproof containers. Cement absorbs moisture from the air. A little period of exposure may not do much harm to cement in ordinary containers, but a whole wet season would be fatal. When cement granulates it deteriorates in quality, whether it can be reduced to powder again or not.

3. Hardware must be kept dry in proper receptacles. Nails should be kept sorted and under lock and key. See that the nail boxes are stocked each morning. This will help you to

keep a check on the quantity being used.

4. Door and window frames should be well braced, stacked on a level floor, or on bars, and protected.

5. Mud bricks can be made ahead of time. If there is no danger of rain, they may be neatly stacked around the building site within easy reach of the labourers serving the masons. If there is danger of rain damage, pile the bricks as compactly as possible, cover them, and drain the base of the pile by an encircling trench.

6. Roof iron is not only expensive but mishandling seriously interferes with its usefulness. Hence every precaution should be taken to have it carefully handled from the suppliers. It must not be thrown down on end, either in the bundle or in separate sheets. If carriers bring it by head load, ensure if at all possible against their stealing the banding iron, or bending the sheets double to make handy head loads. This latter practice results in distortion of the corrugations and makes a tight joint roof almost impossible.

Care in design through preparation and adequate supervision are essential in keeping down building costs. Everything that can be brought and prepared for use before the building crew comes will help to get the job off to a good start. All the lumber should be on hand. If possible, all scaffold, benches, shelters, frames, doors, windows, lintels, arch forms should be prepared by the time the workmen arrive.

If transportation is uncertain for any cause at the critical period, be sure that everything is brought to the site well ahead of time.

Make provisions for an adequate supply of water for all building

operations as needed, without fail. Lack of water as well as other materials, for even brief periods, adds heavily and unnecessarily to labour costs. If necessary secure drums or make some other provision for a constant supply throughout each day. Always have water in good supply throughout each day. Always have water in good supply before the water carriers go home each night.

Labour

Selection of Labour: The following factors should be kept in mind when making a selection of labour.

1. Season. All seasons are not equally suitable for building operations for various reasons. There are the busy seasons when labour is in short supply, the wet season when travel is difficult, and seasons when housing is scarce. At times feasts, fasts, observances and other religious customs interfere with building programs.

2. The Number Employed: This should depend upon one or more of the following: the urgency of the particular project; the amount of time at the builder's disposal; his ability to handle a work crew; distance from which a crew must be brought; the possibility of sharing this cost of transport with someone else in the more or less immediate neighbourhood; the equipment on the job to keep the men busy if they did come; and the number of local labourers available at the time of building is an item to be considered, especially in respect to supplying the masons at all times with all the materials they require. When time is not a vital factor, the work force brought from any considerable distance must be cut down to a minimum.

3. The Various Types of Labour Employed: Try to have a crew which

is accustomed to your speech and to your methods. This applies particularly to those who are kept busy building. Following this have a nucleus of at least one good mason and one good carpenter who have been with you previously. It is better to have at least four masons who can build plumb corners, and two carpenters who are experienced with doors and windows, and two who are good at roofs. Mason apprentices should be restricted to one for every four bricklayers. Carpenter apprentices are more acceptable and may be employed at a rate of one to every three or every two of the skilled men. Usually labourers are not imported but occasionally the local labourers are so unused to cement mixing and kindred jobs that one or two strong, experienced and reliable men may profitably be brought in. Ethnic group wrangling may be serious enough to restrict the labourers on any job to one group. That is, labourers and artisans on a job may be best drawn from one group, or labourers from one and artisans another.

Labour Agreements

When labour is first engaged, a fair idea should be given to the prospective workmen about the location of the job; the purpose and status of it; its estimated duration; the general wage level and hours of work; sick pay, overtime and travel pay, if any; whether or not a man may bring his wife, and on what terms; in a work crew of 5 to 6 men, it is frequently necessary and useful for one of the wives to cook for the group; the food supply issue should be addressed with the work crew, and some satisfactory arrangements should be worked out to avoid having workers upset on the job because of the absence of the kind and quality of food to which they are accustomed; rental and lodging arrangements must be worked out for all workers, and particularly when men

are already paying rent on their own homes. The best rule is to show the workmen that they can expect to be fairly treated, and make clear that they should expect to produce a quality effort in return.

Labour Relations

It is important to be well informed about the labour viewpoint, temper and climate before the job begins. One should become familiar with the labour laws of the district and the country as a whole. A misunderstanding of the regulations and customs, or the occurrence of an incident related to the job, can lead to widespread and long-lasting trouble. In many past cases, such episodes have resulted in harmful testimony, and have at times adversely affected the labour market and labour relations over a wide area, and have seriously disrupted the construction project.

Thus, it is important to be judicious and careful about discipline, such as dismissing a worker abruptly for a minor offense. It may be wiser to separate the man from the other workers by placing him in a different job for a time, and then if circumstances so indicate, release him on pay day by telling him his services are no longer needed. Be sure he receives the correct amount of pay, and if it seems advisable, he might be given a small gift on departure as a gesture of good will. One should never resort to physical force, nor lay hands on a workman if it can be avoided. In serious cases where physical restraint is necessary, let the other workmen attend to him.

In most areas it is not justifiable to set one single price for a specific trade. Wages vary considerably between trades and from one district to another. One need not pay the highest wages, but the contractor or builder nearly always loses in the

long run, in various ways, if wages are set at the lowest end of the scale, and if the poorest workmen are hired.

Remember that mixing concrete all day by hand is very heavy work, and it can be a mistake to try to force a hustling pace over extended time periods. Willing workers should be allowed to have a breathing spell occasionally.

Before work commences, some mention should be made of the conduct expected. Many of the men, if not all, will have been accustomed to very different working conditions as well as leisure time regulations. Loss and waste due to deliberate disobedience of an order should be made up, as far as possible, by the man responsible. Pay should be cut for deliberate idleness, excessive lateness and for quitting early. The incident in question should be pointed out to the man at the time, an entry made in the pay book, and a fine deducted on pay day. Since this tends to be a distasteful experience for the worker, he should be given an opportunity to make up the time through overtime work.

In a well managed project, the work day starts on time, and each day's work ends on time. Be punctual.

Absolutely no building materials should be appropriated for the private use of the workman. There is a tendency for them to pick up scraps for personal use, but such scraps are worth money and have many uses, not only during the specific construction operation, but the next one and the one after that. If one of the workers wishes to make use of scrap material, he should ask for it, and failure to do this ought to be punishable. A good practice to minimize temptation is to pick up all cuttings, nails and other useable scraps daily or as often as is practical.

Occasionally artisans at work on a project will be asked by outsiders to do piece work for them after hours. It is considered disadvantageous for an employer, (a) if the work is being done at the work site or compound, or (b) if the carpenter, for example, is sharpening his tools on employer time and using nails and other materials from the project to carry out this extra work for someone else. It is important for a manager to have some control over such practices, since it affects his project directly. The manager should request or demand that each artisan keep a clear record of all extra pay or monies received for extra work of this kind while employed on the project, from the date of hiring until finally released.

It should be made known at the start of the project that thieving and burglary will be dealt with severely. Such negative activities as fighting, gambling, drinking, quarreling with food vendors on the compound or work site, or bringing a woman to the compound, should be forbidden at the very start of the project. Also, carousing, fighting and other objectionable behavior in relation to the townspeople should be discouraged.

Discourage advance payments, or salary advances, especially after the workmen have had one pay day. Have the pay made up in advance, and have it carefully checked, so that when the wages are handed out on pay day each man will receive the correct wages for the work performed, and there will be a minimum of misunderstanding, disagreement and argument. Pay the workmen every shilling that is due to them, from the start of the project until the final payday. The arrival of pay day is an important event for the workmen, and an important moment in the life of the project. It should be carried out smoothly and well, and should be a positive, happy event.

Supervision of Labour

Proper technical direction can be a problem and needs constant attention. It is difficult to obtain satisfactory performance or results without a strong foreman or one person's full time supervision of labour. Someone in a position of responsibility and authority must be on hand to order and check on materials, to employ local labour, and to attend to all the details of correspondence, cash flow, time, wages and other duties at the work site.

Invariably the cost of wages goes up when there is inadequate supervision. This is due in part to inexperience and lack of clear insight into the whole process by members of the work force, and due in part to a natural tendency to let down when left alone. Often the artisan may not know what to do next, or may not clearly understand the instructions he has been given, particularly if working for a new employer or supervisor. In an attempt to avoid many unnecessary and costly mistakes due to misunderstanding, the following techniques have been developed and widely used with good results. They are not intended to reflect negatively on artisans or labourers in any part of the world, and in fact have the effect of improving rather than disrupting labour relations.

The Building Superintendent's Five Commandments

1. Tell the workman what is wanted several times, very plainly, and only tell him one thing at a time.
2. Show the workman what is wanted. Put your hand on the material, mark it if necessary, and demonstrate the procedure by actual example, so that there can be no question about what is intended.

3. Stand by the workman, or visit him frequently, to see if he is carrying out his instructions, or if he is unclear about exactly what needs to be done. This is particularly important if this is a new job or new procedure for the workman.

4. Avoid asking questions which can be answered by simple direct observation or investigation. An employee may tend to try to please by giving what he thinks to be the answer indicated by the question, but he may misrepresent the facts in order to try to satisfy the supervisor's question. An experienced supervisor's direct observation can save time and eliminate confusion.

5. When a component of the project or a piece of work is finished, it can be a good practice to declare it to be complete, and move the workman or team on to the next task. The purpose is to avoid wasting valuable work time by overworking a specific task, and to avoid the possibility of unintentional damage to a portion of the project which has already been declared satisfactory.

In approaching the role of supervisor it is important to state clearly, repeat again, and re-emphasize that orders given have a clear purpose and must be carried out as given. Orders should not be changed because the workmen have a different opinion. At the same time, a good supervisor will assure his workmen that if they do have a different opinion, and if they do think that an order is faulty, then they should call the supervisor's attention to it. If they are correct, and the original order is flawed, the supervisor should thank them for pointing out the problem and should revise the order. As a general rule, the piece work principle should be followed, since it tends to be mutually supportive and helpful.

Direction or Manipulation of Labour

Thorough preparation of the entire project as a whole, and for each particular component and job, will pay rich dividends in efficiency and is well worth the time and effort.

Have all equipment, materials and supplies ready for the workmen every time they come to the job site. When the workmen have made a good start on one section of the work, the next stage of operations should be thoroughly prepared so that there will be no loss of time or efficiency when they complete the first section and are ready to move ahead with the next.

Keep each artisan employed within his own skill field to the extent possible. In other words, let labourers prepare scaffolding, rather than having skilled masons do it. Perhaps one of the masons should supervise. As a general rule, do not allow a carpenter to spend time doing what his apprentice can do, and do not let an apprentice waste time doing what a labourer can do. In the same vein, it is often the case that a simple piece of apparatus can be employed to hold material that is usually held by a labourer, thus freeing the labourer's hands to carry out other tasks.

In cement work, careful forethought and constant supervision is needed to prevent confusion, delay and waste. The supervisor must keep every part of the operation moving forward smoothly and efficiently.

Calculating Simple Interest

Discussion: Interest is money that is paid for the use of money, and as a contractor or builder, one needs to know how it works.

Simple interest is usually calculated at a certain percentage rate per year. The base on which the interest is calculated is called **principal**. In reckoning interest, time has to be taken into account. The simple interest on a sum of money for one year at a certain rate is the principal multiplied by the interest rate. For a two year period, it is twice as much. For any period of time, it is the interest for one year multiplied by the number of years.

P stands for Principal. I stands for Interest. R stands for percentage Rate. T stands for Time in years. This gives us the following formula for calculating simple interest:
 $I = P \times R \times T$

Problem:

A contractor borrows \$750.00 from a money lender for two years and seven months. The money lender is charging 8% interest. How much money will the contractor have to repay?

Procedure:

1. The time period is 31 months, at 30 days to a month for 12 months.
2. Substitute values into formula:

$$I = \$750 \times 8\% \times \frac{31}{12}$$

3. Solve for I (Interest) by cancellation:

$$I = \frac{750 \times 8 \times 31}{100 \times 12}$$

$$I = \$155.00 \text{ total interest to be paid.}$$

Answer: The contractor will pay back a total of \$905.00, which is the original principal of \$750 plus the \$155 in interest.

CHAPTER VI BASIC SKILLS AND OCCUPATIONAL PROFILES

INTRODUCTION

The main objectives of the Kiteredde Construction Institute are to train young men in the techniques of construction, to place them in jobs in the construction industry and in public works assignments, and to train them in basic business and management skills to enable them to create and operate small contracting firms successfully.

The preceding chapter outlines some of the management components which are covered in course work for those trainees interested in forming small construction firms. In addition to course work, trainees are given practical experience in the field through working with small construction firms and enterprises managed by the Bannakaroli Brothers and the Kiteredde Construction Institute. These firms are comprised of trainees, recent graduates who are known as "Old Boys", and more experienced construction professionals who have worked with the Bannakaroli Brothers for a number of years. In addition, selected graduates of the program are brought back on contract as graduate assistants to manage or assist with specific building or training projects, which gives them further opportunities to enlarge their skills.

This chapter deals with the standard occupational and skill profiles which the Kiteredde Construction Institute adopted from the ILO as a base-line for skills measurement in 1980. These profiles serve as a performance-based set of criteria for the assessment of actual technical competencies, and supplement the basic vocational/technical training criteria established by appropriate Ugandan and East African education authorities.

The specific skills and profiles listed here provide a practical check-list for vocational trainers, institutions, trainees, graduates and construction supervisors. They are included in this manual primarily as a set of guidelines for KCI trainees, graduates and others, as an aid to continued learning and to encourage the continual upgrading of technical skills.

Occupational Profiles

Occupational profiles are listings of tasks and performance levels to be attained by trainees during the course of their studies at the Kiteredde Construction Institute. Under each course title is a series of code numbers and titles which refer to occupations as defined in the International Standard Classification of Occupations (ILO, Second Edition, Geneva, Switzerland, 1968).

The purpose of this reference is to indicate the occupations for which graduates of KCI's training programs would qualify as a result of the training received. Thus, the profiles serve as an important source of information to candidates for admission to the school, to their parents and to other advisors helping candidates with their plans for entering vocational training. At the time of graduation, students have a realistic idea of the occupations for which they are qualified, and prospective employers have an indicator by which to measure the suitability of the graduate for specific positions.

The profiles list tasks which are either (a) common to several different occupations, or (b) related only to one occupation. Alongside each task is a performance level which is attained as a measure of the trainee's success in meeting the performance objectives of the training program.

The tasks listed are built into the learning sequences of the training program, so that the skills, knowledge and attitudes which are required for successful performance are tested out and mastered in a logical and progressive sequence. The learning objectives for each course element are built around the detailed skills and performance criteria, and these detailed objectives provide the indicators for evaluating learning achievement. Evaluation is a measure of trainee performance of occupational tasks under the conditions described, and up to the levels indicated. Graduation from the Kiteredde Institute indicates that the trainee has met the standards of performance established by KCI in consultation with the appropriate vocational and technical training authorities of the Ministry of Education.

A certificate is attached to the graduate's diploma detailing the proficiencies achieved, and this can be presented to prospective employers as evidence of the graduate's qualifications for employment.

The profiles are reviewed annually by the staff of the Kiteredde Construction Institute, assisted by external evaluators, to examine the need for refinement and modification both in terms of changing job markets and manpower needs, and to appropriately reflect changes in the curriculum. KCI began in 1980 with a basic six month intensive training program followed by job placements. Over the past few years the program has been extended, first to nine months to conform to certification requirements of the Ministry of Education, and more recently has been extended to two years. In the current model, trainees receive nine months of instruction at KCI, and then devote more than a full year to practical on-the-job training in the construction industry, before returning to KCI for advanced course work prior to graduation. Trainees are evaluated during the working internship portion of the program by their employers and supervisors, and through follow-up visits by KCI staff.

Presently the Kiteredde Construction Institute offers course work and practical skills training in Masonry, Drafting, and Carpentry. The demand for Cabinet-Making from the nearby rural and small urban areas has led to planning for additional course work, equipment and facilities to establish a Cabinet-Making (Carpentry-Joinery) component to fulfill these expressed needs. At the present time, trainees are admitted to all of the instructional areas, rather than specializing in one, the purpose being to give each graduate a firm grounding in a range of skills and to enhance his employability through versatility. The small business management course is provided for promising trainees and graduates with specific aptitude for and interest in forming contracting firms.

Performance Standard Key

- A. Ability to perform the task under direct supervision.
- B. Ability to perform the task upon receiving a work order.
- C. Ability to identify the need for the performance of a task and ability to execute it.
- D. Ability to instruct others in the performance of a task.

Masonry

A student completing training under this profile will be eligible and qualified to apply for a position under any one of the following occupational titles:

- 9-51.20 Bricklayer (Construction)
- 9-51.40 Stonemason (General)
- 9-51.50 Tile Setter
- 9-52.30 Reinforcing Iron Worker
- 9-52.40 Cement Finisher
- 9-55.10 Plasterer (General)

General Occupational Description:

Lays bricks, hollow tiles and similar building blocks to construct walls, partitions, arches, interior fireplaces and chimneys and other structures. Builds stone work such as walls, piers and abutments; lays walks and constructs other types of stonemasonry; sets tiles to surface walls and floors. Forms and pours reinforced concrete structures. Finishes surfaces of concrete structures. Applies one or more coats of plaster to walls and ceilings of buildings to produce a finished surface.

Task Listings

Performance Standards

	A	B	C	D
1. Examines plans and other specifications of structure to be erected.				
2. Spreads mortar with trowel on building blocks and lays them in rows, designs and shapes.				
3. Taps block with trowel to align it and to embed it firmly in mortar.				
4. Checks vertical and horizontal alignment of structure with level and plumb-line as work progresses. (May fix brick or terra cotta veneer to face of masonry structure, form ornamental brickwork designs, and alter and repair existing brickwork).				

Masonry Task Listings (continued)

Performance Standards

A B C D

5. Selects cut stone and shapes it preparatory to setting with chisel, hammer or other shaping tools.
6. Spreads mortar with trowel over foundation or laid stone.
7. Sets stone in mortar bed by hand or with lifting device, and tamps into place with hammer.
8. Fills vertical joints between stones with mortar and finishes them with pointing trowel. (May specialize in a particular type of stonemasonry and be designated accordingly. May fix stone facing to structure of brick or concrete).
9. Can plan and lay out on paper the materials lists, time and labor schedules, and costs, for all of the above.
10. Calculates numbers of different tiles required.
11. Soaks tiles in water to prepare them for setting.
12. Applies plaster coat and layer of mortar to wall and sets tiles according to pattern.
13. Cuts tiles at corners and edges to complete surface to be tiled.
14. Taps tiles into place or slides leveling board over their surfaces, tapping them with board to level surface and to increase bond between tiles and cement.
15. Aligns rows of tiles, using spirit level and straight edge.
16. Wipes newly laid tile surfaces with filling materials to fill joints, and cleans surfaces.
17. Assembles or constructs shuttering, and fixes it in position.

Masonry Task Listings (continued)

Performance Standards

A B C D

18. Cuts, shapes, assembles and fixes reinforcing rods or mesh in shuttering.
19. Prepares concrete by hand or in a concrete mixer, or signals to helper to deliver ready-mixed concrete.
20. Pours concrete into shuttering, distributing it, tamping it or settling it.
21. Levels and smooths surface of concrete.
22. Removes shuttering when concrete is dry, and smooths rough edges.
23. Cuts ridges, bumps and projecting wire from concrete surface with chisel and hammer.
24. Patches holes and broken corners by wetting them, spreading cement mortar into them, and smoothing surface with trowel or float.
25. Removes blemishes and uneven parts of surface by wetting or applying liquid mixture of sand, cement and water, and rubbing with abrasive block.
26. Finishes surface by wiping with damp brush.
27. Smooths and shapes surface of freshly poured concrete with straight edge and float for fine finish, and with edging tool to shape corners.
28. Applies first coat of plaster to surface with trowel; levels and smooths it.
29. Scratches surface to provide bond for finish coat, and shapes plaster border along sides of surface to provide guide for finish coat.
30. Spreads finish coat between borders, leveling it with rod, and smoothing it with trowel; finishes corners and angles with angle float.

Masonry Task Listing (continued)

Performance Standard

A B C D

- 31. Carries out interior ornamental plastering, and plasters outside surfaces of buildings.

- 32. Cleans tools and repairs them when necessary.

Carpentry

A student completing training under this profile will be eligible and qualified to apply for a position under any one of the following occupational titles:

- 9-54.10 Carpenter (General)
- 9-54.20 Construction Joiner
- 9-54.20 Concrete Shutter
- 9-54.70 Bench Carpenter

General Occupational Description:

Cuts out, assembles, erects and repairs structural and other woodwork at workbench and on construction site. Assembles and installs wooden frameworks of buildings, flooring and other heavy-framed woodwork, such as pouring chutes and scaffolding at building sites. Builds, assembles, places in position and dismantles rough wooden structure (shuttering). Fits, assembles and installs wooden internal and external fixtures of buildings such as doors and window frames, facing and panelling. Cuts out, shapes, fits and assembles wooden parts, mainly at the workbench, both for making new articles and repairing used ones.

Carpentry Task Listing

Performance Standards

A B C D

1. Works from plans, sketches or from instructions received.
2. Selects wood and other materials to be used.
3. Marks out reference points according to pattern or plan to facilitate cutting and shaping.
4. Cuts and shapes wood by hand or machine tools, performing such operations as sawing, grooving, planing and sanding.
5. Assembles wooden parts using glue, screws nails and other means.
6. Erects and repairs prepared work pieces such as rafters, wooden floors, partitions, windows, door frames, and staircases.
7. Maintains and sharpens own tools.
8. Performs related tasks in conjunction with other trades.

Carpentry Task Listing (continued)

Performance Standards

A B C D

9. Makes concrete shuttering.
10. Marks out, cuts and adjusts wood to be assembled in shuttering partitions, or assembles shuttering from prefabricated wooden parts.
11. Assembles shuttering parts on site and screws, nails, or clamps them together.
12. Plans and lays out on paper all materials lists, time and labor schedules, and costs for all of the above.
13. Places stays between shuttering partitions to give structure necessary rigidity.
14. Aligns shuttering with bob and plumb-line.
15. Patches holes in shuttering.
16. Dismantles shuttering when concrete has set and cleans off adhering concrete.
17. Fitting, assembling, installing and repairing of wooden facing, panel fixtures, and fittings in woodwork or on site. (May assemble sections from ready-cut pieces, and may specialize in particular product and be designated accordingly).

Cabinetmaking

A student completing training under this profile will be eligible and qualified to apply for a position under the following occupational title:

8-11.20 Cabinetmaker

General Position Description:

Makes completely and repairs wooden articles such as cabinets and furniture, using hand tools and woodworking machines.

Cabinet-Making Task Listing

Performance Standards

	A	B	C	D
1. Studies drawings of articles to be made and marks off outline of parts on wood.				
2. Shapes parts by operations such as cutting, planing and turning.				
3. Trims joints to make them fit together snugly.				
4. Glues joints, fits parts together, and clamps them until glue is dry.				
5. Drives nails, dowels or screws through joints to reinforce them.				
6. Fit sub-assemblies and other parts together to form completed unit.				
7. Finishes articles, attaches trim, applies veneer, stain or polish, and installs hardware such as hinges and drawer pulls.				
8. Repairs and refashions high-grade articles of furniture.				
9. Fits, assembles and repairs wooden facing, panels, fixtures and fittings in woodwork on site.				
10. Plans and lays out on paper all materials lists, time and labor schedules, and costs for all of the above.				

Drafting

At the present time the Kiteredde Construction Institute is not providing the level of training in this skill area to qualify its graduates under the usual occupational titles of:

- 0-32.40 Civil Engineering Draftsman
- 0-32.50 Architectural Draftsman

The level of drafting skills being provided enables the students to make basic drawings for the construction of houses, sheds, agricultural buildings and other structures. The students are able to read plans, follow them, and learn to draw to scale.

General Occupational Description:

Prepares working plans and drawings for construction based on designers sketches and specifications, and prepares charts and working drawings for other purposes. Prepares drawings for the construction of houses, school buildings, farm buildings and other basic structures.

Drafting - Task Listing

Performance Standards

	A	B	C	D
1. Prepares work plans and drawings for simple buildings based on designer's specifications.				
2. Reads blueprints and translates these into working plans.				
3. Calculates dimensions, angles, beam strengths, truss strengths, walls and carrying walls and factors them into building design and drawings.				
4. Makes blueprints and drawings of designed buildings and building site based on designer's specifications.				

APPENDIX I

GLOSSARY OF TERMS

- Adobe: A sun-dried block of mud, and a binder.
- Air-dried: The condition of lumber (usually 12 to 20% moisture content) reached by exposing it for a sufficient period to the prevailing atmospheric conditions.
- Air drying: The process of drying green lumber to expose it to prevailing atmospheric conditions.
- Banana Juice (for paint): By squeezing or boiling down ripe bananas and stems, the juice can be used as an adhesive binding agent to put together traditional local paints.
- Bearing Walls: Outside walls of a building bearing the weight and stress of the roof structure.
- Binder: Adhesive characteristic of an element used to bond dissimilar materials.
- Bond: Anything that binds, ties or fastens building materials together chemically or mechanically.
- Block: A moulded rectangular rectangular prism larger than a brick; typically adobe or concrete.
- Brick: A moulded rectangular block of clay, baked until hard, or sun dried for use in construction.
- Casehardening: A condition of stress and set in dry wood in which the outer fibers are under compressive stress and the inner fibers under tensile stress, the stresses persisting when the wood is uniformly dry.
- Cell: In wood anatomy, a general term for the minute units of wood structure having distinct cell walls and cell cavities. Includes wood fibers, vessel segments and other elements of diverse structure and function.
- Cement: A construction adhesive, powdered, calcined rock and clay materials that form a paste with water and set as a solid mass.
- Check: Synonyms: Cracks, drying check, checking. A separation of the wood fibers within or on a log, timber, lumber or other wood product resulting from tension stresses set up during drying, usually the early stages of drying.

Clay: A fine-grained firm natural material, plastic when wet.

- A) Ant-hill clay.
- B) River Bank clay.
- C) Swamp clay.

Coffee husks: By-products of coffee used (when dried) for starting kiln fires and for crop fertilization.

Concrete: A construction material consisting of gravel, pebbles, broken stone or slag in a mortar or cement matrix.

Conditioning, air: In drying wood the movement of air by either natural or mechanical means.

Forced circulation: The movement of air by mechanical means.

Country Kiln: A basic brick or block kiln used in the countryside, not permanent.

Damp Proof Course: Moisture barrier substructure, typically a richer mixture of mortar.

Decay: Synonym: Rot, or the decomposition of wood substance by fungi.

Advanced (or typical) decay: The older stage of decay in which the destruction is readily recognized because the wood has become punky, soft and spongy, stringy, pitted or crumbly. Decided discoloration or bleaching of the rotted wood is often apparent.

Incipient decay: The early stage of decay which has not proceeded far enough to soften or otherwise perceptibly impair the hardness of the wood. It is usually accompanied by a slight discoloration or bleaching of the wood.

Defect: Any irregularity or imperfection in a tree, log, or lumber which reduces its volume or quality or lowers its durability, strength, to utility value. Defects may result from knots and other growth conditions and abnormalities; from insect or fungus attack; from milling, drying, machining or other processing procedures.

Degrade: A loss in adjudged quality which drops lumber to a lower commercial grade.

Density: The weight of a body per unit volume, usually expressed in pounds per cubic foot or grams per cubic centimeter. In wood, density changes in terms of moisture content.

Dipping: Process of submerging lumber in a vat containing fungicides or other chemicals, or used engine oil, to prevent stain or decay, to impart water repellency, and protect from termites, or to color the product.

Discoloration: Synonym: Stain. Change in the color of lumber due to fungal and chemical stains, weathering, or heat treatment.

Drying of Timber: Storage of processed timber. After several weeks, moisture will evaporate from the timber.

Footings and Foundation: Substructure of a building or structure on firmest possible soils to spread building weight over larger area or down to soil bearing.

Frog: Indentation in face of brick; brickmoulders mark.

Fungi: Low forms of plants consisting mostly of microscopic threads that traverse wood in all directions, converting the wood to materials fungi use for their own growth. Fungi cause decay and staining of lumber.

Grade: A classification or designation of the quality of manufactured pieces of wood, or of logs and trees.

Grain: The direction, size, arrangement, appearance or quality of the fibers in lumber. When used with qualifying adjectives the term designates the orientation of fibers and/or growth rings in lumber.

Cross grain: Lumber in which the fibers deviate from a line parallel to the sides of the piece. Cross grain may be either diagonal or spiral grain or a combination of the two.

Diagonal grain: Lumber in which the annual rings are at an angle with the axis of a piece as a result of sawing at an angle with the bark of the log. A form of cross grain.

Edge grain: Synonym: Comb grain, edge-sawn, quarter grain, quarter-sawed, rift grain, rift sawed, stripe grain, vertical grain. Lumber that has been sawed or split so the wide surfaces extend approximately at right angles to the rings, exposing the radial surface.

End grain: The ends of wood pieces that are cut perpendicular to the fiber direction.

Flat grain: Synonym: Flatsawn, plain grain, plain-sawed, slash grain, tangential cut. Lumber sawed or split in a plane approximately perpendicular to the radius of the log. Lumber is considered flat-grained when the annual growth rings make an angle of less than 45 degrees with the surface of the piece.

Straight grain: Lumber in which the fibers and other longitudinal elements run parallel to the axis of a piece.

- Green lumber:** In general, lumber just cut from freshly felled trees. In accordance with the American Softwood Lumber Standard, lumber above 19 percent moisture content.
- Grout:** Thin concrete mixture used to fill voids, such as the interior of concrete blocks.
- Hardwoods:** Generally one of the botanical groups of trees that have broad leaves, in contrast to the conifers or softwoods. (The term has no reference to the actual hardness of the wood.)
- Header:** Top framing member over a window or door opening.
- Heartwood:** The inner layers of wood in the growing trees that have ceased to contain living cells and in which the reserve materials, e.g., starch, have been removed or converted into resinous substances. It is generally darker in color than sapwood, though the two are not always clearly differentiated.
- Hoe/Gimbe:** A tool with a flat blade and a long handle used for weeding, cultivating and breaking up the soil.
- Impurities (in clays):** Small stones, grass and other natural materials naturally mixed in pure clay.
- Jamb:** Side and top members of window or door frame.
- Joint:** A point or position at which two or more things are joined.
- Joist:** Floor framing member for wooden floor. A horizontal beam set from wall to wall to support the boards of a floor or a ceiling.

Karai: A basin used in East Africa for construction purposes, 16" wide by 5" in height. Volume equals 4.5 US Gallons or 10 liters.

Lintel: The horizontal beam over the top of a door or window.

Level: A flat horizontal surface or plane at right angles to the plumb or vertical angle.

Lime: Calcium oxide used as an adhesive or binding agent in mortar mixes.

Lime Mortar: Binding agent for brickwork.

Limestone: A shaly or sandy sedimentary rock composed chiefly of calcium carbonate.

Load: A supported weight or mass.

Mabati/
Metal sheets/
Roof Iron: Standard metal sheets of various thicknesses and sizes made of galvanized iron or aluminum for roofing.

Moisture content of wood: Weight of the water contained in the wood, expressed as a percentage of the weight of the oven-dry wood.

Average moisture content: The percentage moisture content of a single sample of wood which is representative of a larger piece.

Core moisture content: The moisture content of the inner portion of a moisture content section which remains after a shell one-fourth the thickness of the section has been removed.

Determination of moisture content: The testing of lumber to determine the amount of moisture present. This is usually expressed in terms of percent of the oven-dry weight.

Final moisture content: The average moisture content of the wood at the end of the drying process.

Green moisture content: The moisture content of wood in a living tree.

Initial moisture content: The moisture content of the wood at the start of kiln-drying or air-drying.

Mortar: A mixture of cement or lime with sand and water used in brick and block laying.

Mou'd: Standard hand held wooden frame of various sizes used for moulding bricks and blocks.

Moulder: A person who physically uses the mould to make bricks and blocks.

Mudsill: Rot-resistant wood member attached to a concrete foundation wall. Floor joists rest on top of it.

Nail: A slim pointed piece of metal, often with a head, hammered into wood or other material as a fastener.

Non-bearing Wall: Inside wall of a structure not bearing any weight or stress from the roof.

On-center: Equal spacing of constructive elements, i.e., every 2" apart, or every 2" on center.

Papyrus: A tall grasslike water plant of Africa used for/in roofing material, and for wall structure in mud and wattle construction.

Parquet Flooring: Wood, often of contrasting colors, worked into an inlaid pattern.

Piles: Heavy beams driven into the earth as a support for a structure.

Plasticity: Quality of or capacity of being shaped or formed. A material such as wet clay, which can be made into a variety of shapes by applying pressure, is characterized by plasticity.

Plate: Top or bottom horizontal frame member of stud wall.

Plumb: A weight suspended from the end of a line used to determine true vertical.

Posts: Stakes, set upright in the ground to serve as markers or structural supports.

Pozzolanas: Binding agent associated with cement, lime.

Purlins: Secondary members placed on top of rafters, providing strength and area for nailing on roofing materials.

Rafter: A sloping beam that supports a roof.

Rammer or Tamp: A tool with a handle and wide head, 6" - 24" cubic inches, used for tamping/compressing soil.

Rebar: Metal bar used in reinforcing concrete structures. Reinforcing bar.

Re-inforced concrete: Concrete strengthened with steel bars or rods.

Rice Husks: Harvested rice waste, used to fire brick, and used as a masonry filler.

Ridge: The line formed by the junction of two sloping surfaces.

Ring beam: A horizontal beam at the ridge of a roof to which the upper ends of the rafters are attached.

Riser: The vertical part of a stair's step.

Run: Horizontal element of a slope.

Sapwood: The outer layers of the stem that in the living tree contain living cells and reserve materials. The sapwood is generally lighter in color than heartwood.

Screed: Grade level forms set at desired height so concrete can be roughly developed by dragging a straight edge over the surface.

Set: Fix, to put into a stable position or fixed position.

Sheathing: Various coverings or structures resembling a sheath.

Shrinkage: The contraction of wood fibers caused by drying below the fiber saturation point. Shrinkage is usually expressed as a percentage of the dimension of the wood when green.

Slope: An inclined line, surface, plane or stretch of ground.

Softwoods: Generally one of the botanical groups of trees that, in most cases, have needlelike to scalelike leaves; the conifers. (The term has no reference to the actual hardness of the wood.)

Straight Edge: A rigid object (metal or wood) with a straight edge for testing or drawing straight lines.

Stress, drying: An internal force exerted by either of two adjacent parts of a piece of wood upon the other during drying caused by uneven drying and shrinking and influenced by set.

Compressive stress: The stress that develops in the interior region of wood during the early stages of drying, caused by the shrinking of the outer shell; also the stress in the outer layer at a later point in drying caused by the shrinking of the interior.

Tensile stress: The stress that develops in the outer layers of wood during the early stages of drying when these layers are trying to shrink but are restrained by the still-wet interior region.

- Stringer: Side member of stairway that supports risers and treads.
- Stud: Vertical structural member of wall in frame building.
- Thatch: Plant stalks (mostly grass) used for roofing.
- Threshold: Piece of material over which door swings.
- Tread: Horizontal board in stairway.
- Trim (Interior, Exterior): To make neat or tidy by chipping or smoothing.
- Trowel: A flat-bladed hand tool used for shaping substances such as cement or mortar.
- Truss: A wooden or metal framework used to support and brace a roof.
- Veneered wood: A thin layer of material bonded to and used to cover a surface (finished, glass).
- Warp: Distortion in lumber causing departure from its original plane, usually developed during drying. Warp includes cup, bow, crook, twist and kinks.
- Water, bound: Moisture that is bound by adsorption forces within the cell wall; that is the water in wood below the fiber saturation point.
- Free water: Moisture that is held in the cell cavities of the wood.
- Wood: The tissues of the stem branches and roots of a woody plant lying between the pith and cambium serving for water conduction, mechanical strength and food storage.
- Wood chips/sawdust: Pieces of wood or dust from sawing or harvesting of timber that can be used to start kiln fires.

APPENDIX II

REFERENCES AND ACKNOWLEDGEMENTS

1. Building Construction, by H. K. Dancy, published by International Technology Publications, 1978.
2. Clay Moulding Manual, The Secretary for Trade, Industry and Tourism, Box 30366, Lilongwe 3, Malawi, 1976.
3. Lorena Owner-Built Stoves, Ianto Evans, Volunteers in Asia Publications, 1979.
4. Designs for Rural Construction in Pakistan, 1978.
5. Building Construction, W. B. McKay, Volume 3, 1975.
6. Village Technology Handbook, Volunteers in Technical Assistance (VITA), 1970.
7. Agricultural Handbook No. 531, U.S. Department of Agriculture Forest Service.
8. Agricultural Mathematics for Peace Corps Volunteers, Development and Resources Corporation, 1968.
9. Air Drying of Lumber: A Guide to Industry Practices, Agricultural Handbook No. 402, U.S. Department of Agriculture.
10. Daniel A. Adam, Architect, Alberta, Canada. Artist and consultant for illustrations.
11. Bannakaroli Brothers, Kiteredde, Uganda, Brother Leandro, Superior General. Brother Borgia, Headmaster, Kiteredde Construction Institute. Brother Cosma, Farm Planner and local building materials expert, Kiteredde Construction Institute. Brother Constanso, Instructor, Kiteredde Construction Institute. Brother Mpuga, Building Supervisor, Nnaluddugavu Construction Industry, Kyotera. Brother Emiliano.
12. Vincent B. Kayabula, Graduate of Kiteredde Construction Institute, Group II (1982). Art work and drawings.
13. Sigurd Hanson, East Africa Regional Representative, The Experiment in International Living, and former Headmaster, Kiteredde Construction Institute.
14. Judith and Robert Rondeau, and Betsy Ballard, Design Graphics, Brattleboro, Vermont, USA.
15. Appropriate Building Materials, Swiss Center for Appropriate Technology, (SKAT #12), Varnbuelstrasse 14, CH-1900 St. Gallen, Switzerland.
16. Appropriate Technology Sourcebook, Vols. I and II, Volunteers in Asia, Stanford, California, 1981.

The Kiteredde Construction Institute

The Kiteredde Construction Institute, Rakai District, Uganda, was founded in 1980 by the Bannakaroli Brothers and The Experiment in International Living, in a joint project made possible by initial funding from the United States Agency for International Development. It was further assisted by generous assistance from the Canadian International Development Agency, the Australian High Commission, Catholic Relief Services, and CODEL.

The primary purpose of KCI is to train young men for skilled employment in the construction industry, through both theoretical and practical training, to teach them building techniques using locally available materials, and to place graduates in jobs in the construction industry. In addition, students and graduates are given opportunities to learn the skills of small business management to enable them to form small construction firms and to manage them successfully.

In addition to training in the construction of houses, public and commercial buildings and other structures, KCI students are given practical experience in agricultural construction, including animal shelters, food storage facilities, water systems and wells, and other rural applications.

The faculty and students have built their own classrooms, dormitories and other facilities out of local materials. They have worked together to open up new farm acreage annually, and to rebuild the poultry flock and cattle herd in an effort to make the institution as nearly self-sufficient as possible in producing its own food supplies.

In its fifth year of operation, KCI is now concentrating on continuing to upgrade the quality of training and the working internships it provides for its students and graduates, and is strengthening its capacity to carry out an increasing volume of extension and outreach training for other technical schools and other communities in Uganda. The purpose of this effort is to share KCI's knowledge of clay-moulding, construction, training and the use of local materials with others.

The Experiment in International Living

The Experiment in International Living (EIL), founded in 1932, is one of the oldest and largest international educational exchange organizations in the world. It is a registered private voluntary organization, carrying out technical assistance, education and training projects, and refugee assistance programs in Asia and Africa. EIL's School for International Training is an accredited graduate and undergraduate college which specializes in preparing individuals for careers in teaching, training, program management, intercultural communications, the management of human service agencies and public and private organizations in the U.S. and abroad, and in international technical assistance.

Since 1979, EIL has participated fully in the design and development of the curriculum, training programs and approaches to training at KCI, and continues to be actively involved in the work of this growing Ugandan vocational training institution.