

Tom's Hydraulic Ram Pump

Introduction:

A 'hydraulic ram pump' is a device which uses the energy of falling water to propel a portion of the water to a higher level. It doesn't need electricity, and it pumps at a modest rate which does not exceed the capacity of a small (inexpensive) pipe. These two criteria were exactly what I was looking for when I found out about the existence of such a solution. As a bonus, it's easy to build the pump from scratch!



The proper conditions must be in place in order to deploy such a pump, and as luck would have it, my situation is close to ideal.

When I moved from California to my place in Oregon, the first of several largish projects I attacked was to overhaul my water system. Prior to this improvement, I had an electric pump which drew river water but the water is not as potable as I would like, and the electric pump was a constant hassle.

I learned quite a bit over the course of the project and with this series of pages, I hope to describe the system and some of the things I learned so that others who may have use for a similar system might benefit. I will not re-invent the wheel by describing the construction of the pump as it is a simple device and the information is

adequately covered by others (See the links page.) I will, however, elaborate on some of the behaviours I have noticed and some of my personal theories.

The most important thing I would like to stress is that one should really consider all of the pieces of the water system, of which the pump is likely to be but one part. In my case, I consider an intake system, a stand-pipe, a filter system, a pipe system (especially since I supply another party with water), a river crossing (150 foot suspension), and a tank.

[750K Movie Clip](#) of pump in operation.

[Overview Map](#) to get a big-picture view.

[Schematic](#) Shows sized and circuits.

[Stand_pipe system and intake](#) Think about this!

[pump and drive-pipe](#) The 'drive-pipe' is most important!

[Water Crossing](#) If you have the mis-fortune of needing one.

[Tank and misc other stuff](#) Filter arrangement, etc.

[Links to other ram pump sites.](#) Be sure to read sizing data!

Feel free to e-mail me with any questions of suggestions. You may want to say 'ram pump' in the subject line as I have to wade through over 100 spams/day (that my spam filter misses!) and sometimes I throw out good mails by accident.

Thanks, and have fun building a system...I did!



This is an image of a tax map upon which I've drawn (ameturishly) some non-accurate contour lines and a few other features.

Note that the intake is in a small stream called 'Shoemaker Creek' which has very good water, a very steep grade, and a decent flow even at the end of summer.

Green: (Left-to-right): Stand-pipe, Pump, River crossing, Tank.

Red: Water line. Some distances:

- Intake to Stand-pipe: 300'
- River crossing: 100'
- River to Tank: 500'
- Tank to House: 500'
- Intake Elevation (river base-line): around 35'
- Tank Elevation (river base-line): around 120'

Light Blue: River - 'West Fork of the Millicoma'

Dark Blue: My place.

Yup, I live on the wrong side of the river!
One of my next projects is to be a cable-car.

[Back](#)

I have not drawn one yet. If you have a question about sizes or circutes, e-mail me.

[Back](#)

I actually do not have my intake built yet, but just a screen to keep out leaves. I'll put an image of the intake when it's done, but for now, here is a picture of 'Shoemaker Creek' to impress upon the reader the grade. As I say, I am lucky to have such an ideal situation!



Note: I came down the hill with 1.25 line. Since the run is only 300', this is OK in my application. I get better than 7 gpm flow at the bottom of the stand-pipe, but ***this is wrong thinking!*** The head causing water to flow will be the drop between the intake and the top of column of water in the stand pipe. When they are equal, there will be *NO* flow, thus, the column will drop when the pump is in operation. This drop will be a function of the resistance in the line (length and diameter) and of the flow rate (size of the pump.) Think this one through and don't be a cheapskate like me if you have a less ideal site!

The steep grade of the river made it possible for me to run the pump with around 25' of head minus whatever drop happens in the column in the stand-pipe, hence the rather tall stand-pipe that one can see going up the tree:.



Note: Most of this stand-pipe is 4 inch which is just barely sufficient for a 1.25 drive-pipe. I cheated and used a section of 3 inch at the top because I have head to spare and an extra drop in the column (when the pump exhasts) won't hurt me to much. I only cheated here because the tall stand-pipe was awkward to handle.

By the way, it's probably worth it to **not** simply guess how high the stand-pipe needs to be and come up short like I did (twice!) I could have simply run the line up the tree until water stopped coming out to see how high I needed to make the stand-pipe, but noooo...I ended up taking it down and going to town for more sewer pipe.

This is the base of the stand-pipe.



Note_1: The intake is higher than the outflow to the pump so that if somehow air bubbles enter the intake, they will float up and not get in the pump where they have a very negative impact.

Note_2: The valve is optional, but very nice to have, at least initially when fooling with the pump.

Note_3: The isolation tube which is an auto part in my case is very important in my opinion. Even a well secured pump (as mine is as you will see) will have some movement, and it can fatigue the stand-pipe assembly.

Note_4: I have a 'rock chamber' at the bottom of my stand-pipe assembly...it remains to be seen if I will be able to unscrew the silly thing at some point in the future to clean it?

Note_5: I have a 6 foot section of 1.5 inch plastic pipe between the 1.25 inch steel drive-pipe and the stand pipe. This is not ideal, and is an artifact of my repositioning things. Try to set the pump up so that this is not necessary, and if it is, consider using something larger than a 1.5 inch pipe. You don't want it to be an extension of the drive pipe (by developing it's own water-hammer effect.) This is a source of angst for me since I basically understand how the pressure waves are supposed to behave in the drive-pipe. I thought about arranging an isolation mechanism between the offending plastic section and the drive-pipe (like, say, an inner-tube bag) but as it happens, things are working OK in the current configuration so I don't need to bother...and probably won't.

[Back](#)

The most important part of the pump is the '**drive pipe**'. Here is a view down it's 60' length. In spite of the way it looks in this photo, it's actually pretty straight. One can see a section of the 6' of plastic pipe going to the stand pipe which I mention on another page.



Note: Rigidity is the most critical aspect for good performance. I've used 1 1/4 steel pipe which was scrapped after being pulled from a well. I forgot or never knew what gauge...schedule 40 maybe? In theory (mine), it actually shouldn't matter a whole lot whether it bends or not, but a bent drive pipe will be difficult to secure and thus, should be avoided.

Note: This pump is actually quite loud. The noise is a metallic clank that seems to emanate from every point on the drive line. It got louder when I secured the pump to the block of concrete mentioned below. If the noise proves to be offensive at some point, I will bury the drive line.

Here is a picture of the pump in operation. The valve has just snapped shut. I had access to some very nice stainless steel fittings and happily, an industrial check valve that someone had obtained from Wearhauser's scrap yard 20 years ago. Almost everything you see here is stainless and of heavy gauge.



Note_1: The reason for the configuration is that I wished the check valve to be 'upside-down' so that pebbles and rocks would be less likely to screw things up and I could flush them. The upshot is that one may take liberties with whatever designs one might happen across.

Note_2: Instead of an air bleed 'snifter valve', I have put a wheelborrow inner-tube inside the bounce chamber. So far, so good...the thing isn't too critical anyway as far as dimensions go (my theory.) Even at the valve on the pump when it is cracked to produce 60 psi of back pressure, I see no indication of a pulsating delivery which surprised me.

Note_3: The valve and gauge have proven to be invaluable as it is necessary to have quite alot of back pressure in order for *my* pump to cycle. I partially close this valve and watch the gauge (so I don't blow the pump up) when starting it if for some reason the native 50 psi is not available (i.e., the line to my tank is not full.)

I do not know why my pump requires so much back pressure. I suspect it has to do with the rigidity of everything and/or the plastic at the end of the drive pipe and/or the over-sized body and too long neck to the valve and/or the hight of the stand-pipe.

Note_4 There is a huge amount of force generated by the water-hammer in the drive pipe. It made the pump jump

around alot so I welded on a mounting bracket and poured a 700lb block of concrete around a large boulder which I found under the surface of the ground. That did the trick! Also, as I mentioned, the pump got generally louder. My opinion is that proper securing of the pump is second only in importance to rigidity of the drive pipe.

Note_5 As for the preformance, I recently put over 1800 gallons of water in my tank in 24 hours, and the tanks is somewhat over 110 feet above the pump. I've not measured the waste rate, but a ratio of 1/5 is expected for an efficient pump if I recal correctly. I'm curious now, and will measure the waste flow rate when I get a chance. BTW, the cycle frequency of my pump seems to be more than once per second...download the movie clip if you like. [750K Movie Clip](#) if you like. Lengthening the drive pipe from 40' to 60' didn't change the frequency as much as I expected.

Update: I got around to measuring the waste. It's around 6 gal/min. This makes it slightly better than 1/5 at it's current state of tune and workload.

My valve design differs somewhat from other descriptions I've seen, but I'm happy with it. I had three worn out foot valves from the former (traditional) water system to choose from when making this one.:



Note_1 I replaced the valve stem by sawing off the original and carefully drilling and tapping the disk. The new stem is a high quality stud which does not have threads where it goes through the support. Under the disk, I screwed on a second nut and set the threads with a punch. I wanted plenty of weight so I left the stud long and took up the slack with a tight fitting bit of fuel line hose (which is camouflaged in this picture.) The double-nut on the top allows me to adjust how far the valve drops into the body (and thus, in theory, the water flow needed to snap the valve shut), but I've not needed to fool with it.

Update: After around 30 days of run-time, there is a noticable amoung of wear where the valve stem goes through the support. Steel-on-brass, and the brass is wearing. Apperently the stem slaps the guide as the valve seats with enough side-force that it is wearing. Next I'll try either a gas engine valve guide or a teflon insert depending on what I can fit to the valve housing...unfortunatly there is little extra material on the foot-valve bodies that I have kicking around.

Note_2 Note that the valve is actually sucked open with some force by a 'reverse wave' in the drive pipe. This creates stresses to be aware of and is a failure mode for some pumps and can cause noise. In my system, the fuel line hose slipped over the stem reduces both of these problems. The drive-pipe clank noise is much louder than the clack valve in my pump.

[Back](#)

I live on the wrong side of the river and take a raft when the river is too high to hop across on rocks. This is half the year. Sometimes it's unsafe to take a raft across in which case I stay on whatever side I'm on. Here is a nice picture of 'Shoemaker Creek' from my side of the 'West Fork, Millicoma':

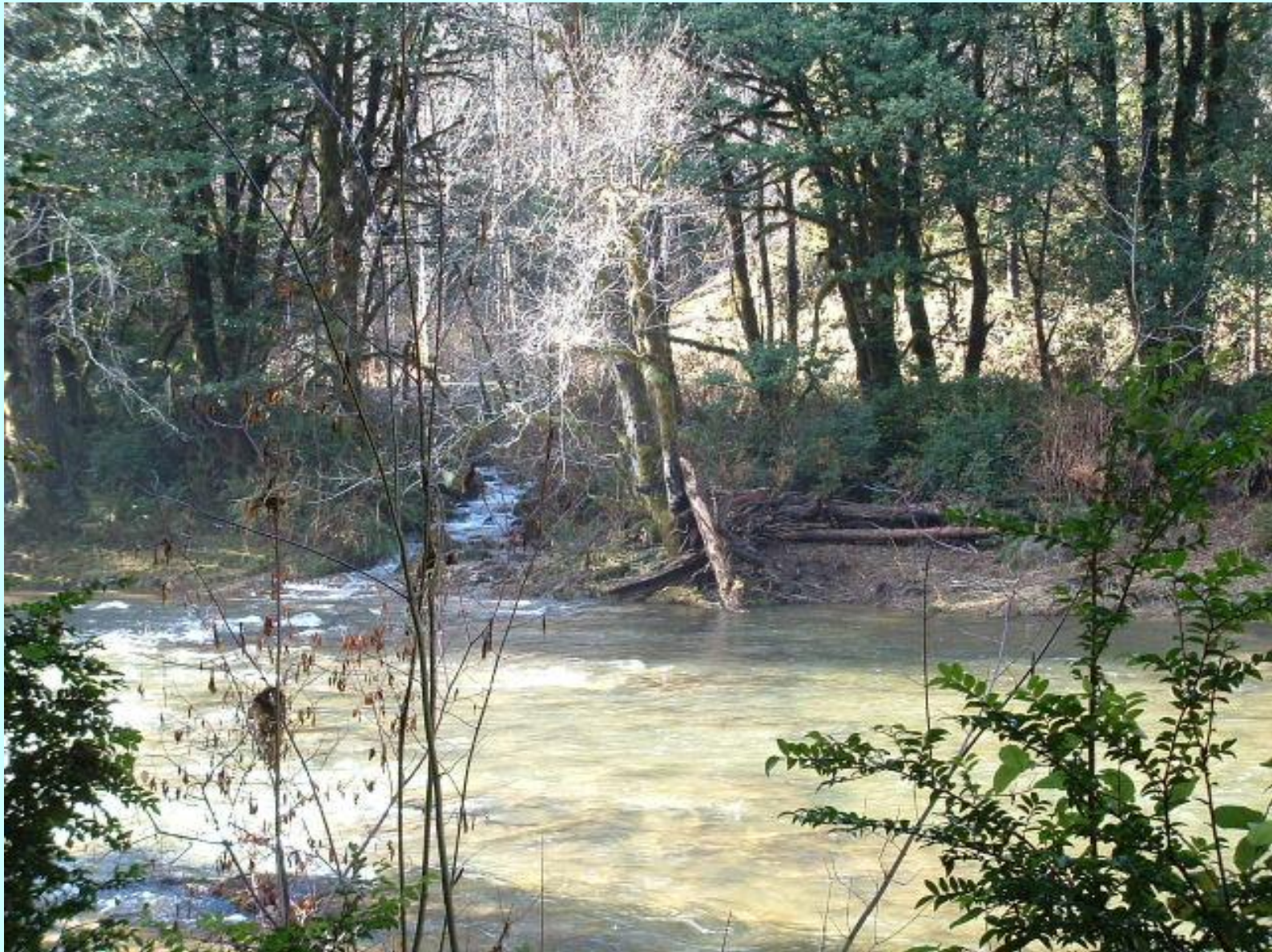

Note_1: The West Fork can rise almost to the level of the road. One option was to run a galvanized pipe under the river, but I decided against it because trees and boulders roll down the river when the water is high.

Here is a picture of the line crossing the river...about a 100' span.



Note_1: A 1 inch plastic pipe (which you see crossing the river) goes from my tank to my neighbors property at the mouth of Shoemaker creek to supply them with water. A 1/2 inch line from the pump tee's into this line. At the tank, a setup of valves allows the supply line and feed line to be the same (see tank page.)

Note_2: I used 1/8 inch cable. I was able to pull the cable and pipe (empty) by hand to this level of tension, so the forces are not excessive.

Note_3: On the road side, the cable attaches to a myrtle tree via a hole through a large branch in which I put a rod. On the other side, I put a large eye-bolt in the fir tree and attached a pulley to it running the cable to an anchor on the ground. This makes it easy for me to drop the cable. Neither tree should have been damaged in the process (although I had to [climb](#) each a number of times with spurs which probably didn't do them any good.)

I thought about how to attach the plastic pipe to the cable and this is what I came up with. It works well, and I was able to easily slide the plastic pipe one way or another, but note that there are no hose-clamps over the span...this would have changed things.



Note_1: The rings are sawed off chunks of 2 inch plastic pipe. They have tiny holes drilled in them which allowed me to wire them all together with stainless wire. Every so often, the stainless wire is stuck to the 1/8 suspension cable with u-bolts.

[Back](#)

I have a 2500 gallon tank over 100 feet (in elevation) on the hill. This provides plenty of pressure and reserve. This picture shows the filter and circuits.



Note_1: The 1.25 inch line (open valve) goes to my place. There is a check valve by the close valve in the 1 inch line. As I mentioned, water goes up the 1 inch line when the pump is running, and down the line when the neighbor is using water. The check valve keeps water from entering the tank from the bottom. It is forced up the 1/2 inch line through the filter. When the tank is full, a float valve inside shuts off and water exhausts through the other 1/2 inch line which also goes first 15' up a tree to an air break, then down to my place as a fountain and function indicator (or will one day :)

Note_2: Note that only water going into the tank is filtered...exhaust when the tank is full is not! My 20 micron filters last about 2000 gallons before they pack up when Shoemaker creek is running clean. Less during rising water (but I can shut down the pump at such times).

Here is a picture up on the hill by the tank looking out toward the pump. It's steep! It took me three days of

dilligent effort to get the tank up the hill using a come-along. I was in noticably better shape afterwards!



Down the hill at a small shed at the end of my deck (which is Several hundred feet long) the pipe changes form 1.25 inch to 1 inch, and I put a valve in for good measure.



And lastly, I tap into my house water system:



Note_1:...my hatefull nemesis and now obsolete (as evidenced by the unserimoniously hacked off pipe) electric pump!

[Back](#)

Here are some links. I've actually lost most of the ones I had, so if anyone has any other good ones, please let me know.

[From Clemson.edu](#)

[Originally from USAID?](#)

[Nice graphics](#)

[Interesting pump.](#)

[Another good site.](#) 'ncollier.com' has consolidated several articles from '[Homepower Magazine](#)' into a very worthwhile 20 page .pdf.

I'm sick of working on this web page now. I'll flesh out this links page after a while. Some of the best material I found was in PDF form. When I find it, and get permission, I'll host some of them here.

[Back](#)

Home-made Hydraulic Ram Pump

This information is provided as a service to those wanting to try to build their own hydraulic ram pump. The data from our experiences with one of these home-made hydraulic ram pumps is listed in Table 4 near the bottom of this document. The typical cost of fittings for an 1-1/4" pump is currently \$120.00 (U.S.A.) regardless of whether galvanized or PVC fittings are used.

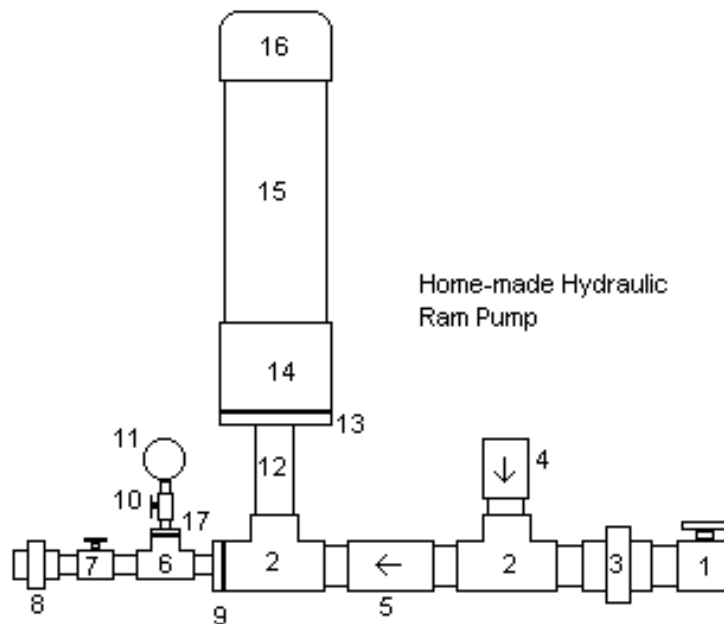

[Click here to see a picture of an old-style assembled ram pump with a threaded plug](#)
(see notes below concerning glue cap (#16) versus threaded plug)

Table 1. Image Key

1	1-1/4" valve	10	1/4" pipe cock
2	1-1/4" tee	11	100 psi gauge
3	1-1/4" union	12	1-1/4" x 6" nipple
4	1-1/4" brass swing check valve (picture)	13	4" x 1-1/4" bushing
5	1-1/4" spring check valve	14	4" coupling
6	3/4" tee	15	4" x 24" PR160 PVC pipe
7	3/4" valve	16	4" PVC glue cap
8	3/4" union	17	3/4" x 1/4" bushing
9	1-1/4" x 3/4" bushing		

All connectors between the fittings are threaded pipe nipples - usually 2" long or shorter. This pump can be made from PVC fittings or galvanized steel. In either case it is recommended that the 4" diameter fittings be PVC fittings to conserve weight.

Conversion Note: 1" (1 inch) = 2.54 cm; 1 PSI (pound/square inch) = 6.895 KPa or 0.06895 bar; 1 gallon per minute = 3.78 liter per minute. PR160 PVC pipe is PVC pipe rated at 160 psi pressure.

Assembly and Operation Notes:

Pressure Chamber - A bicycle or "scooter tire" inner tube is placed inside the pressure chamber (part 15) as an "air bladder" to prevent water-logging or air-logging. Inflate the tube until it is "spongy" when squeezed, then insert it in the chamber. It should not be inflated very tightly, but have some "give" to it. (No information is available concerning pressure chamber sizes for the various sizes of ram pump. Make one somewhat larger for larger pumps - for instance, try a 6 inch diameter x 24 inch long pressure chamber for a 3 inch ram.)

A 4" threaded plug and 4" female adapter were originally used instead of the 4" glue-on cap shown in the image. This combination leaked regardless of how tightly it was tightened or how much teflon tape sealant was used, resulting in water-logging of the pressure chamber. This in turn dramatically increased the shock waves and could possibly have shortened pump life. If the bicycle tube should need to be serviced when using the glue cap the pipe may be cut in half then re-glued together using a coupling.

Valve Operation Descriptions - Valve #1 is the drive water inlet for the pump. Union #8 is the exit point for the pressurized water. Swing check valve #4 is also known as the "impetus" or "waste" valve - the extra drive water exits here during operation. The "impetus" valve is the valve that is operated manually at the beginning (by pushing it in with a finger) to charge the ram and start normal operation.

Valves #1 and #7 could be ball valves instead of gate valves. Ball valves may withstand the shock waves of the pump better over a long period of time.

The swing check valve (part 4 - also known as the impetus valve) *can* be adjusted to vary the length of stroke (please note that maximum flow and pressure head will be achieved with this valve positioned vertically with the opening facing up). Turn the valve on the threads until the pin in the clapper hinge of the valve is in line with the pipe (instead of perpendicular to it). Then move the tee the valve is attached to slightly from vertical, making sure the clapper hinge in the swing check is toward the top of the valve as you do this. The larger the angle from vertical, the shorter the stroke period (and the less potential pressure, since the water will not reach as high a velocity before shutting the valve). For maximum flow and pressure valve #4 should be in a vertical position (the outlet pointed straight up).

Swing check valve #4 should always be brass (or some metal) and not plastic. Experiences with plastic or PVC swing check valves have shown that the "flapper" or "clapper" in these valves is very light weight and therefore closes much earlier than the "flapper" of a comparable brass swing check. This in turn would mean lower flow rates and lower pressure heads.

The pipe cock (part 10) is in place to protect the gauge after the pump is started. It is turned off after the pump has been started and is operating normally. Turn it on if needed to check the outlet pressure, then

turn it back off to protect the gauge.

Drive Pipe - The length of the drive pipe (from water source to pump) also affects the stroke period. A longer drive pipe provides a longer stroke period. There are maximum and minimum lengths for the drive pipe (see the paragraph below Table 2). The drive pipe is best made from galvanized steel (more rigid is better) but schedule 40 PVC can be used with good results. The more rigid galvanized pipe will result in a higher pumping efficiency - and allow higher pumping heights. Rigidity of the drive pipe seems to be more important in this efficiency than straightness of the drive pipe.

Drive pipe length and size ratios are apparently based on empirical data. Information from University of Georgia publications (see footnote) provides an equation from Calvert (1958) describing the output and stability of ram pump installations in relation to the ratio of the drive pipe length (L) to the drive pipe diameter (D). The best range is an L/D ratio of between 150 and 1000 ($L/D = 150$ to $L/D = 1000$). Equations to use to determine these lengths are:

Minimum inlet pipe length: $L = 150 \times (\text{inlet pipe size})$

Maximum inlet pipe length: $L = 1000 \times (\text{inlet pipe size})$

If the inlet pipe size is in inches, then the length (L) will also be presented in inches. If inlet pipe size is in mm, then L will be presented in mm.

Drive Pipe Length Example: If the drive pipe is 1-1/4 inches (1.25 inches) in diameter, then the minimum length should be $L = 150 \times 1.25 = 187.5$ inches (or about 15.6 feet). The maximum length for the same 1-1/4 inch drive pipe would be $L = 1000 \times 1.25 = 1250$ inches (104 feet). The drive pipe should be as rigid and as straight as possible.

Stand pipe or no stand pipe? Many hydraulic ram installations show a "stand pipe" installed on the inlet pipe. The purpose of this pipe is to allow the water hammer shock wave to dissipate at a given point. Stand pipes are only necessary if the inlet pipe will be longer than the recommended maximum length (for instance, if the inlet pipe were to be 150 feet in length in the above example where the maximum inlet length should only be 104 feet). The stand pipe - if needed - is generally placed in the line the same distance from the ram as the recommended maximum length indicated.

The stand pipe must be vertical and extend vertically at least 1 foot (0.3 meter) higher than the elevation of the water source - no water should exit the pipe during operation (or perhaps only a few drops during each shock wave cycle at most). Many recommendations suggest that the stand pipe should be 3 sizes larger than the inlet pipe. The supply pipe (between the stand pipe and the water source) should be 1 size larger than the inlet pipe.

The reason behind this is simple - if the inlet pipe is too long the water hammer shock wave will travel farther, slowing down the pumping pulses of the ram. Also, in many instances there may actually be interference with the operation of the pump due to the length of travel of the shock wave. The stand pipe simply allows an outlet to the atmosphere to allow the shock wave somewhere to go. Again this is not necessary unless the inlet pipe will have to be longer than the recommended maximum length.

Another option would be to pipe the water to an open tank (with the top of the tank at least 1 foot (0.3

meter) higher than the vertical elevation of the water source), then attach the inlet pipe to the tank. The tank will act as a dissipation chamber for the water hammer shock wave just as the stand pipe would. This option may not be viable if the tank placement would require some sort of tower, but if the topography allows this may be a more attractive option.

[Click here to view sketches of these types of hydraulic ram pump installations](#)

(loads in 70 seconds over 28.8 modem)

Operation - The pump will require some back pressure to begin working. A back pressure of 10 psi or more should be sufficient. If this is not provided by elevation-induced back pressure from pumping the water uphill to the delivery point (water trough, etc.), use the 3/4" valve (part 7) to throttle the flow somewhat to provide this backpressure.

As an alternative to throttling valve part 7 you may consider running the outlet pipe into the air in a loop and then back down to the trough to provide the necessary back pressure - a total of 23 feet of vertical elevation above the pump outlet should be sufficient. This may not be practical in all cases, but adding 8 feet of pipe after piping up a hill of 15 feet in elevation should not be a major problem. This will allow you to open valve #7 completely, preventing stoppage of flow by trash or sediment blocking the partially-closed valve. It is a good idea to include a tee at the outlet of the pump with a ball valve to allow periodic "flushing" of the sediment just in case.

Initially the pump will have to be manually started several times to remove all the air. Start the pump by opening valve 1 and leaving valve 7 closed. Then, when the swing check (#4) shuts, manually push it open again. The pump will start with valve 7 closed completely, pumping up to some maximum pressure before stopping operation. After the pump begins operation slowly open valve 7, but do not allow the discharge pressure (read on gauge #11) to drop below 10 psi. You may have to push valve #4 open repeatedly to re-start the pump in the first few minutes (10 to 20 times is not abnormal) - air in the system will stop operation until it is purged.

The unions, gate (or ball) valves, and pressure gauge assembly are not absolutely required to make the pump run, but they sure do help in installing, removing, and starting the pump as well as regulating the flow.

Pump Performance - Some information suggests that typical ram pumps discharge approximately 7 gallons of water through the waste valve for every gallon pressurized and pumped. The percentage of the drive water delivered actually varies based on the ram construction, vertical fall to pump, and elevation to the water outlet. The percentage of the drive water delivered varies from approximately 22% when the vertical fall to the pump is 1/2 (50%) of the elevation to the water outlet down to 2% when the vertical fall is 0.04 (4%) of the elevation to the water outlet. Rife Hydraulic Engine Manufacturing Company literature (<http://www.riferam.com/>) offers the following equation:

$$0.6 \times Q \times F/E = D$$

Q is the available drive flow in gallons per minute, F is the fall in feet from the water source to the ram, E is the elevation from the ram to the water outlet, and D is the flow rate of the delivery water in gallons per minute. 0.6 is an efficiency factor and will differ somewhat between various ram pumps. For instance, if 12 gallons per minute is available to operate a ram pump, then pump is placed 6 feet below

the water source, and the water will be pumped up an elevation of 20 feet, the amount of water that may be pumped with an appropriately-sized ram pump is

$$0.6 \times 12 \text{ gpm} \times 6 \text{ ft} / 20 \text{ ft} = 2.16 \text{ gpm}$$

The same pump with the same drive flow will provide less flow if the water is to be pumped up a higher elevation. For instance, using the data in the previous example but increasing the elevation lift to 40 feet:

$$0.6 \times 12 \text{ gpm} \times 6 \text{ ft} / 40 \text{ ft} = 1.08 \text{ gpm}$$

Table 2. Typical Hydraulic Ram specifications (Expected water output will be approximately 1/8 of the input flow, but will vary with installation fall (F) and elevation lift (E) as noted above. This chart is based on 5 feet of lift (E) per 1 foot of fall (F).)

Drive Pipe Diameter (inches)	Delivery Pipe Diameter (inches)	At Minimum Inflow		At Maximum Inflow	
		Pump Inflow (gallons per minute)	Expected Output (gallons per minute)	Pump Inflow (gallons per minute)	Expected Output (gallons per minute)
3/4	1/2	3/4	1/10	2	1/4
1	1/2	1-1/2	1/5	6	3/4
1-1/4	1/2	2	1/4	10	1-1/5
1-1/2	3/4	2-1/2	3/10	15	1-3/4
2	1	3	3/8	33	4
2-1/2	1-1/4	12	1-1/2	45	5-2/5
3	1-1/2	20	2-1/2	75	9
4	2	30	3-5/8	150	18
6	3	75	9	400	48
8	4	400	48	800	96

Table 3. Test Installation Information

Drive Pipe Size	1-1/4 inch Schedule 40 PVC
Outlet Pipe Size	3/4 inch Schedule 40 PVC
Pressure Chamber size	4 inch PR160 PVC
Pressure Chamber Length	36 inches
Inlet Pipe Length	100 feet
Outlet Pipe Length	40 feet
Drive Water (Inlet) elevation above pump	4 feet

Elevation from pump outlet to delivery outlet 12 feet

[Click here to see pictures of the test installation](#) (loads in 38 seconds over 28.8 modem)

Table 4. Trial 1 Performance Data

	Expected Performance	At Installation (5/17/99)	After Installation (with water-log) (5/21/99)	After Clearing Water-log (6/20/99)
Shutoff Head	5 to 17 psi	22 psi	50 psi	22 psi
Operating Head	10 psi	10 psi	10 psi	10 psi
Operating Flow Rate	0.50 to 1.00 gpm	0.28 gpm	1.50 gpm	0.33 gpm

Note that we used a 4" threaded plug and a 4" female adapter for our test pump (instead of the recommended 4" glue cap (#16) shown in the figure). Two days after installation the pump air chamber was effectively water-logged due to leakage past the threads of these two fittings, which was shown by the pronounced impulse pumping at the outlet discharge point. If the pump were allowed to remain waterlogged it would shortly cease to operate - and may introduce damage to the pipe or other components due to pronounced water hammer pressure surges.

The large range of expected values for shutoff head is due to the unknown efficiency of the pump. Typical efficiencies for ram pumps range from 3 feet to 10 feet of lift for every 1 foot of elevation drop from the water inlet to the pump.

Hydraulic Ram Web Sites

[Bamford Pumps](#)

[CAT Tipsheet 7](#)

[Green and Carter](#)

[Lifewater Rams](#)

[NC State's EBAE 161-92, "Hydraulic Ram Pumps"](#)

[RamPumps.com](#)

[Rife Rams](#)

[Solar Electric](#)

[The Ram Company](#)

[University of Warwick \(UK\) Ram Pump Publications](#)

[University of Warwick \(UK\) Ram pump system design notes](#)

Some information for this web page - and the initial information concerning construction of a home-made hydraulic ram pump - was provided by University of Georgia Extension publications [#ENG98-002](#) and [#ENG98-003](#) (both Acrobat "pdf" files) by Frank Henning. Publication [#ENG98-002](#) also describes the pumping volume equations for

hydraulic ram pumps.

Irrigation Home

Welcome! You are visitor

038641

since 11/28/00

Last modified on 10/06/03

*This page created and maintained by [Bryan Smith](#),
Clemson University Cooperative Extension, Laurens County.*

The Clemson University Cooperative Extension Service offers its programs to people of all ages regardless of race, color, sex, religion, national origin, or disability and is an equal opportunity employer.

Hydraulic Ram Pump

A hydraulic ram or impulse pump is a device which uses the energy of falling water to lift a lesser amount of water to a higher elevation than the source. See Figure 1. There are only two moving parts, thus there is little to wear out. Hydraulic rams are relatively economical to purchase and install. One can be built with detailed plans and if properly installed, they will give many trouble-free years of service with no pumping costs. For these reasons, the hydraulic ram is an attractive solution where a large gravity flow exists. A ram should be considered when there is a source that can provide at least seven times more water than the ram is to pump and the water is, or can be made, free of trash and sand. There must be a site for the ram at least 0.5m below the water source and water must be needed at a level higher than the source.

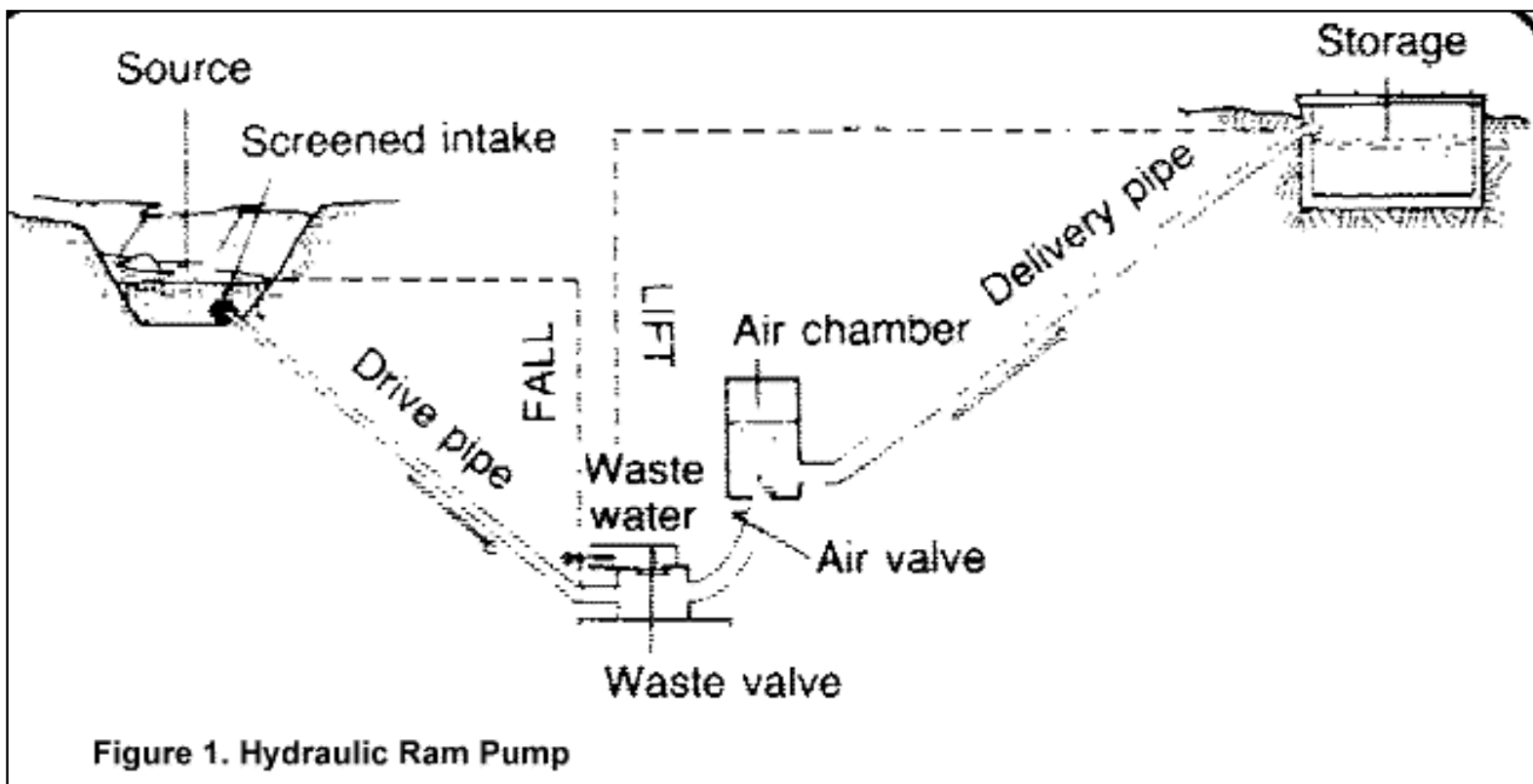

Factors in Design

Before a ram can be selected, several design factors must be known. These are shown in Figure 1 and include:

1. The difference in height between the water source and the pump site (called vertical fall).
2. The difference in height between the pump site and the point of storage or use (lift).
3. The quantity (Q) of flow available from the source.
4. The quantity of water required.
5. The length of pipe from the source to the pump site (called the drive pipe).

6. The length of pipe from the pump to the storage site (called the delivery pipe).

Once this information has been obtained, a calculation can be made to see if the amount of water needed can be supplied by a ram. The formula is: $D=(S \times F \times E)/L$ Where:

D = Amount delivered in liters per 24 hours.

S = Quantity of water supplied in liters per minute.

F = The fall or height of the source above the ram in meters.

E = The efficiency of the ram (for commercial models use 0.66, for home built use 0.33 unless otherwise indicated).

L = The lift height of the point of use above the ram in meters.

Table 1 solves this formula for rams with efficiencies of 66 percent, a supply of 1 liter per minute, and with the working fall and lift shown in the table. For supplies greater than 1 liter/minute, simply multiply by the number of liters supplied.

**Table 1. Ram Performance Data for a Supply of 1 liter/minute
Liters Delivered over 24 Hours**

Working Fall (m)	Lift - Vertical Height to which Water is Raised Above the Ram (m)											
	5	7.5	10	15	20	30	40	50	60	80	100	125
1.0	144	77	65	33	29	19.5	12.5					
1.5		135	96.5	70	54	36	19	15				
2.0		220	156	105	79	53	33	25	19.5	12.5		
2.5		280	200	125	100	66	40.5	32.5	24	15.5	12	
3.0			260	180	130	87	65	51	40	27	17.5	12
3.5				215	150	100	75	60	46	31.5	20	14
4.0				255	173	115	86	69	53	36	23	16
5.0				310	236	155	118	94	71.5	50	36	23
6.0					282	185	140	112	93.5	64.5	47.5	34.5
7.0						216	163	130	109	82	60	48
8.0							187	149	125	94	69	55
9.0							212	168	140	105	84	62
10.0							245	187	156	117	93	69
12.0							295	225	187	140	113	83
14.0								265	218	167	132	97
16.0									250	187	150	110
18.0									280	210	169	124
20.0										237	188	140

Components of Hydraulic Ram

A hydraulic ram installation consists of a supply, a drive pipe, the ram, a supply line and usually a storage tank. These are shown in Figure 1. Each of these component parts is discussed below:

Supply. The intake must be designed to keep trash and sand out of the supply since these can plug up the ram. If the water is not naturally free of these materials, the intake should be screened or a settling basin provided. When the source is remote from the ram site, the supply line can be designed to conduct the water to a drive pipe as shown in Figure 2. The supply line, if needed, should be at least one pipe diameter larger than the drive pipe.

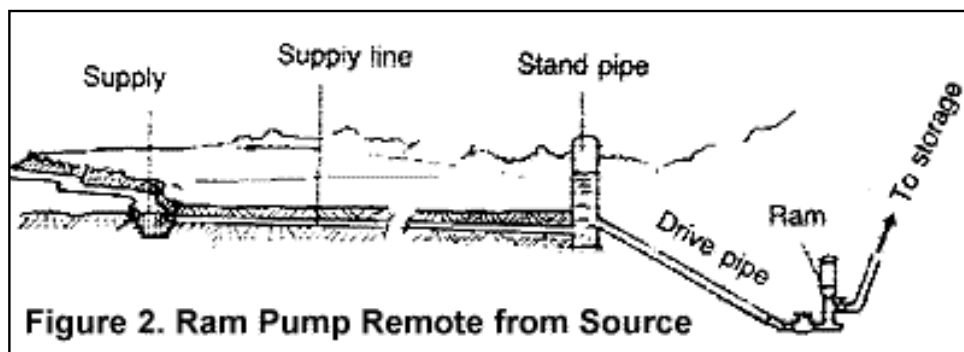

Drive pipe. The drive pipe must be made of a non-flexible material for maximum efficiency. This is usually galvanized iron pipe, although other materials cased in concrete will work. In order to reduce head loss due to friction, the length of the pipe divided by the diameter of the pipe should be within the range of 150-1,000. Table 2 shows the minimum and maximum pipe lengths for various pipe sizes.

Table 2. Range of Drive Pipe Lengths for Various Pipe Diameters

Drive Pipe Size (mm)	Length (meters)	
	Minimum	Maximum
13	2	13
20	3	20
25	4	25
30	4.5	30
40	6	40
50	7.5	50
80	12	80
100	15	100

The drive pipe diameter is usually chosen based on the size of the ram and the manufacturer's recommendations as shown in Table 3. The length is four to six times the vertical fall.

Table 3. Drive Pipe Diameters by Hydram Manufacturer's Size Number

Hydrum Size	1	2	3	3.5	4	5	6
Pipe Size (mm)	32	38	51	63.5	76	101	127

Ram. Rams can be constructed using commercially available check valves or by fabricating check valves. They are also available as manufactured units in various sizes and pumping capacities. Rams can be used in tandem to pump water if one ram is not large enough to supply the need. Each ram must have its own drive pipe, but all can pump through a common delivery pipe as shown in Figure 3.

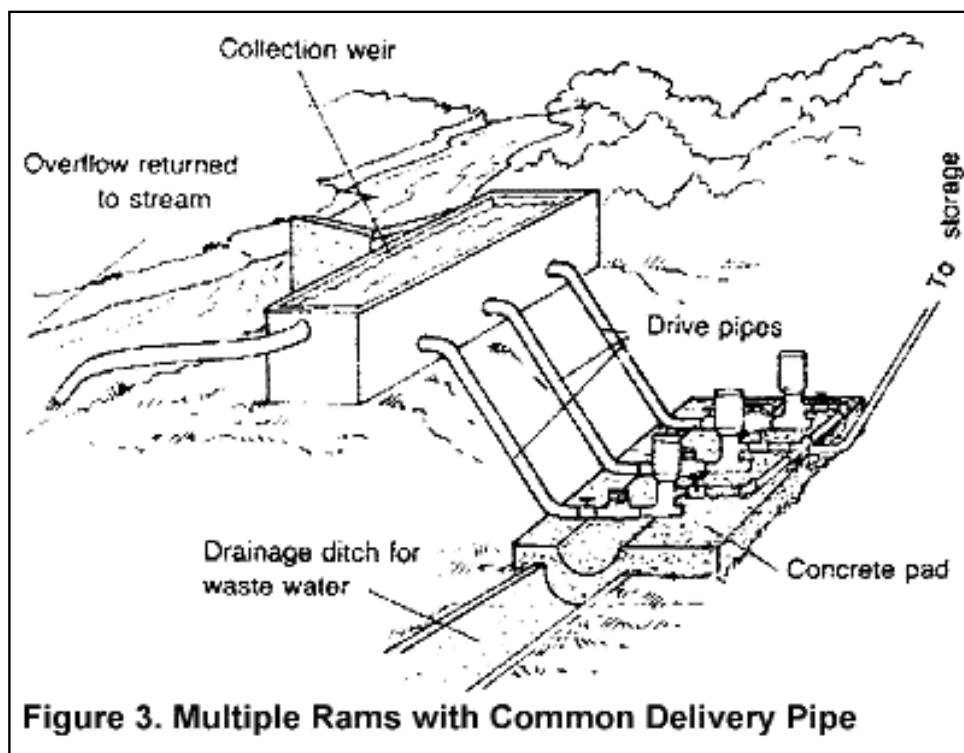

In installing the ram, it is important that it be level, securely attached to an immovable base, preferably concrete, and that the waste-water be drained away. The pump can-not operate when submerged. Since the ram usually operates on a 24-hour basis the size can be determined for delivery over a 24-hour period. Table 4 shows hydraulic ram capacities for one manufacturer's Hydrums.

Table 4. Hydrum Capacity by Manufacturer's Size Number

	Size of Hydrum									
	1	2	3	3.5	4	5X	6X	5Y	6Y	
Volume of Drive Water Needed (liters/min)	7-16	12-25	27-55	45-96	68-137	136-270	180-410	136-270	180-410	
Maximum Lift (m)	150	150	120	120	120	105	105	105		

Delivery Pipe. The delivery pipe can be of any material that can withstand the water pressure. The size of the line can be estimated using Table 5.

Table 5. Sizing the Delivery Pipe

Delivery Pipe Size (mm)	Flow (liters/min)
30	6-36
40	37-60
50	61-90
80	91-234
100	235-360

Storage Tank. This is located at a level to provide water to the point of use. The size is based on the maximum demand per day.

Sizing a Hydraulic Ram

A small community consists of 10 homes with a total of 60 people. There is a spring 10m lower than the village which drains to a wash which is 15m below the spring. The spring produces 30,000 liters of water per day. There is a location for a ram on the bank of the wash. This site is 5m higher than the wash and 35m from the spring. A public standpost is planned for the village 200m from the ram site. The lift required to the top of the storage tank is 23m. The following are the steps in design.

Identify the necessary design factors:

1. Vertical fall is 10m.
2. Lift is 23m to top of storage tank.
3. Quantity of flow available equals 30,000 liters per day divided by 11,440 minutes per day (30,000/11,440) = 20.8 liters per minute.
4. The quantity of water required assuming 40 liters per day per person as maximum use is 60 people x 40 liters per day = 2,400 liters per day.
2,400/1,440 = 1.66 liters per minute (use 2 liters per minute)
5. The length of the drive pipe is 35m.
6. The length of the delivery pipe is 200m.

The above data can be used to size the system. Using Table 1, for a fall of 10m and a lift of 80m, 117 liters can be pumped a day for each liter per minute supplied. Since 2,400 liters per day is required, the number of liters per minute needed can be found by dividing 2,400 by 117:

$$2,400/117 = 20.5 \text{ liters per minute supply required.}$$

From item 3 above, the supply available is 20.8 liters per minute so the source is sufficient.

Table 3 can now be used to select a ram size. The volume of driving water or supply needed is 20.5 liters per minute. From Table 4, a No. 2 Hydrum requires from 12 to 25 liters per minute. A No. 2 Hydrum can lift water to a maximum height of 250m according to Table 4. This will be adequate since the lift to the top of the storage tank is 23m. Thus, a No. 2 Hydrum would be selected.

Table 3 shows that for a No. 2 Hydrum, the minimum drive pipe diameter is 38mm. Table 2 indicates that the minimum and maximum length for a 40mm pipe (the closest size to 38mm) is 6m-40m. Since the spring is 35m away, the length is all right. Table 5 can be used to select a delivery pipe 30mm in diameter which fits the supply needed, 20.5 liters per minute.

This document is not copyrighted, so you are free to print and distribute it. However, we do request that any such re-distribution be on a non-commercial basis only. Kindly reference [US AID, 1982](#) as the author.

The 'ORIGINAL'

Build it yourself manual

"All About HYDRAULIC RAM PUMPS How and Where They Work"

[About the ATLAS RAM PUMP](#)

[About the book](#)

[Ordering Information](#)

[From the publisher....](#)

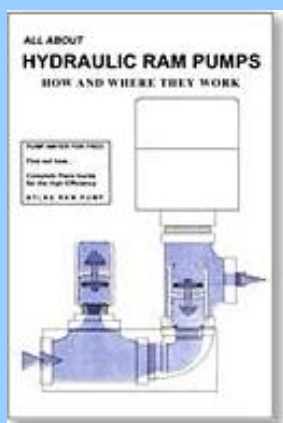

THIS IS THE ONE YOU WANT!

In print for over 20 years! Updated regularly!

DON'T BE FOOLED BY IMITATIONS! They can't answer your questions.

This is the ORIGINAL Atlas Ram Manual, for the unique and widely used Atlas Ram Pump, designed from the ground up to be easily home-built but well made.

The Author is the inventor and designer of the Atlas Ram Pump. The book has his personal e-mail inside, for answering all your ram pump

questions.

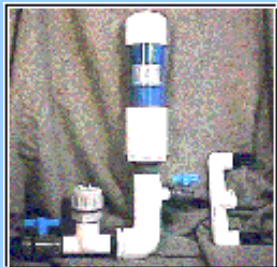



Ram pumps come in all sizes, shapes and materials.

They ALL do the same thing...Pump water for free!

They ALL do it the same way...utilizing 2 common physical laws.

'Using only the power of gravity, these ram pumps can pump water uphill. Only a portion of the water piped to the ram arrives at the end-use area (about 10%-15%) but it arrives 24 hours a day. Even a trickle can provide immense amounts of water for your use.' from 'All about HYDRAULIC RAM PUMPS How and where they work'.

- **WHAT IS A RAM PUMP?**

The hydraulic ram pump is a reliable, old-time water pump that works just as well today as ever. Often called a water ram or rampump, one of these simple devices can pump water from a flowing source of water (spring, creek, river, etc.) to any point above the source, and this without any power requirement except the force of water moving downhill, contained within a 'drive pipe'. Water can even be siphoned out of a pond, as long as the drive pipe heads downhill after it reaches the bottom of the dam.

Invented before electric water pumps and rural electrification, this rugged and dependable device is usually installed today at remote home sites and cabins that are off the power grid and would otherwise be without a water supply. Sometimes a ram is used as a backup water system, or for watering livestock, gardens, decorative lily ponds, water wheels or fountains. The simple fact that a ram uses no power opens up a world of possibilities for using water that would otherwise flow on downstream.

All that is really required is the surface water source. The water has to be moving, have a flow to it..not much, but some. The creek need not be large either - 4 gallons per minute is the minimum.

- **HOW CAN THIS BE?**

The 2 laws that allow a ram to pump water are ***inertia**, and the ***incompressibility of water**. Water flows downhill--it is moving. Contained within a pipe ('drive pipe') it is incompressable, almost as if it were solid. ***As far as physics is concerned, it is solid.***

Think of a hammer. It weighs so much...but simply laying the head on a nail does no good. Swing the hammer--it is moving. It strikes the nail with far more force than its mere weight. Inertia, object moving, stopped suddenly. Force.

Or think of the old battering ram against the castle gates. Weight of log, movement by warriors, stopped suddenly by the gate. Force. Pillage and looting.

The drive pipe, full of water, moving downhill, stopped suddenly by the 'clack' valve closing. Force against the 'check valve' (one-way valve), opens it against the pressure in the 'high pressure' side of the ram pump. A small amount of that water (about 10%-15%) gets through and eventually ends up at the end-use area.

So actually the drive pipe is where the real energy comes from, and the set of valves at the bottom of the drive pipe (usually referred to as the ram pump) is really just the tail end of the ram pump system.

The configuration of the valves makes no real difference except that valves, if laid horizontally, tend to wear out their bushings REAL fast.

There has to be a certain amount of 'fall', which is the VERTICAL distance from the water source to the ram. The minimum for this is about 5 feet. The more fall, the greater the VELOCITY the water in the drive pipe may attain. Greater velocity means more

force (pressure). Fall can be increased by the use of an 'intake barrel' or collection barrel, and source supply pipes going up to 200' upstream.

There is an optimum drive pipe length, arrived at by math, but it is generally around 100 feet in length. This can vary quite a bit; generally a longer drive pipe gives a slower rythm, but more force per cycle. A shorter than optimum drive pipe length gives a faster rythm, less force per cycle.

A typical ram pump setup (not to scale)

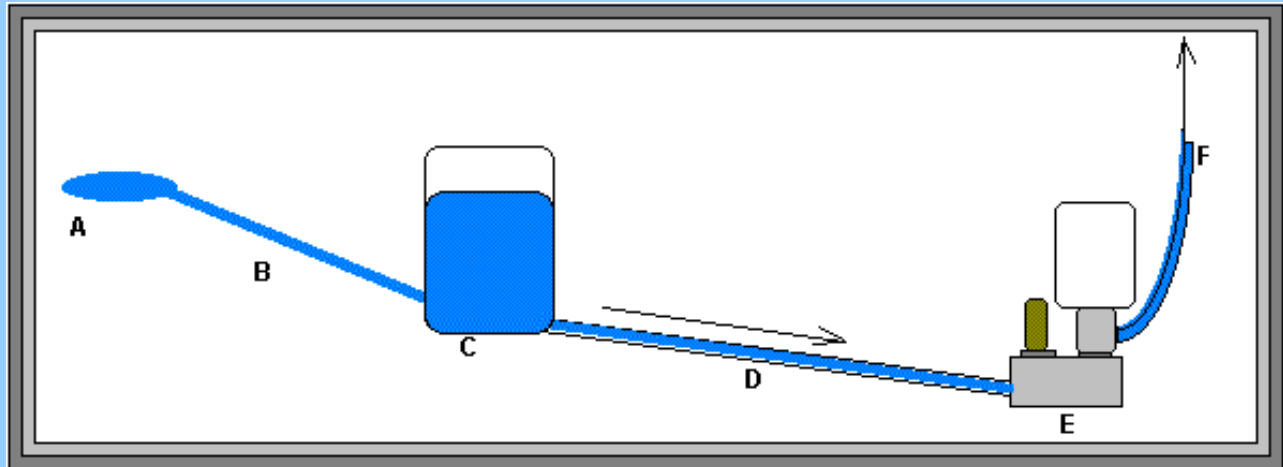

- A. Water source (can be a river, stream, spring, or pond.)
- B. Supply pipe. Goes from the source to the collection barrel downstream (below the source).
- C. Collection barrel. The water is collected here. Water level stays at the level of the source.
- D. Drive pipe. About 100 ft. long; brings the water to the pump and provides the power to the pump, somewhat like a battering ram. Probably the least understood part and most important part of the ram pump system. Typically black plastic pipe, 1" to 2" dia., generally matched to the size of the clack valve (gold colored) on the pump.
- E. Ram Pump. Starts and stops the movement of the water column in the drive pipe. Also redirects a portion of the water to the pressure tank through the internal check valve (one-way valve) This portion (about 10%-15%) leaves the pump and rises to the end use area through the...
- F. Delivery pipe. Goes to the storage tank, garden, house...wherever the water is needed. Typically of 1/2" or 3/4" black plastic pipe.

The ram pump sequence

As you can see in the diagrams below, this process repeats itself about every 2 seconds. About 10% to 15% of the water entering the pump is forced past the check valve or one-way valve into the 'high-pressure' side of the pump and on up to wherever the delivery pipe takes it...to the storage tank above the house, to the barn, pond, etc.

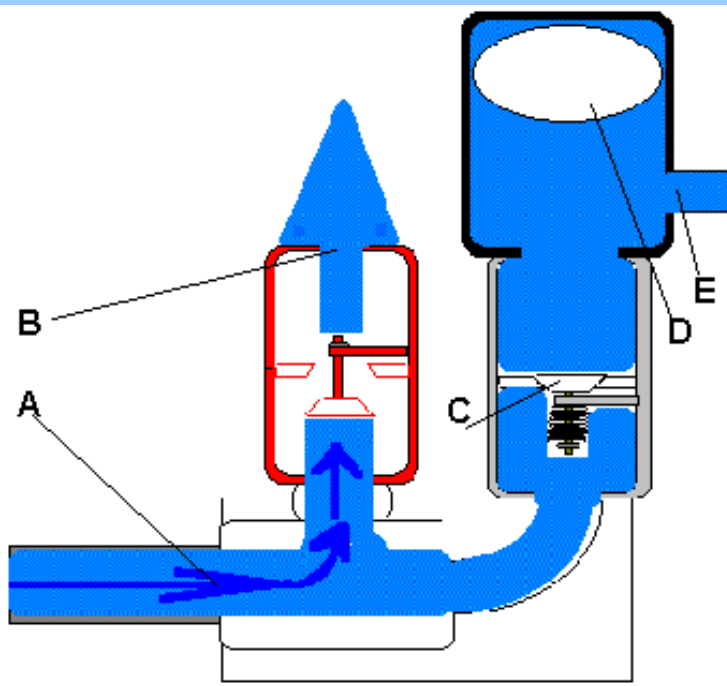

The drive water within the drive pipe enters the ram pump through the inlet (A) and exits through the Clack valve (B). The check valve (C) is kept closed by the water under pressure in the Tank (D). The air volume is not compressed and water is not moving through the water delivery opening (E), which goes to the end-use area through the delivery pipe.

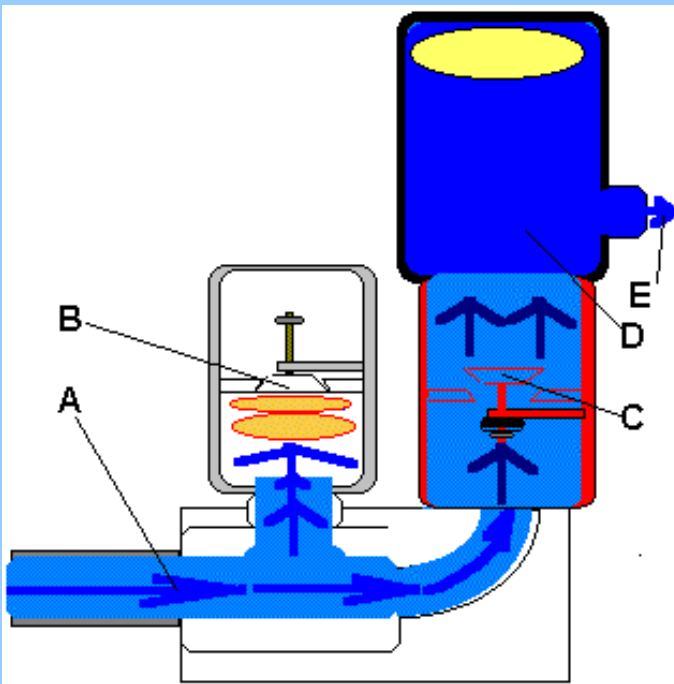

Water is entering the pump (A), but its velocity closes the clack valve (B) suddenly, and the water is for a moment under great pressure from the incoming column of water contained within the drive pipe. The check valve (one-way valve) (C) is forced open against the pressure in the tank by this momentary high pressure pulse and allows a portion of this water into the tank (D). The air volume (yellow) is compressed. Water is forced out the outlet (E) by this compressed air volume and on up the delivery pipe.

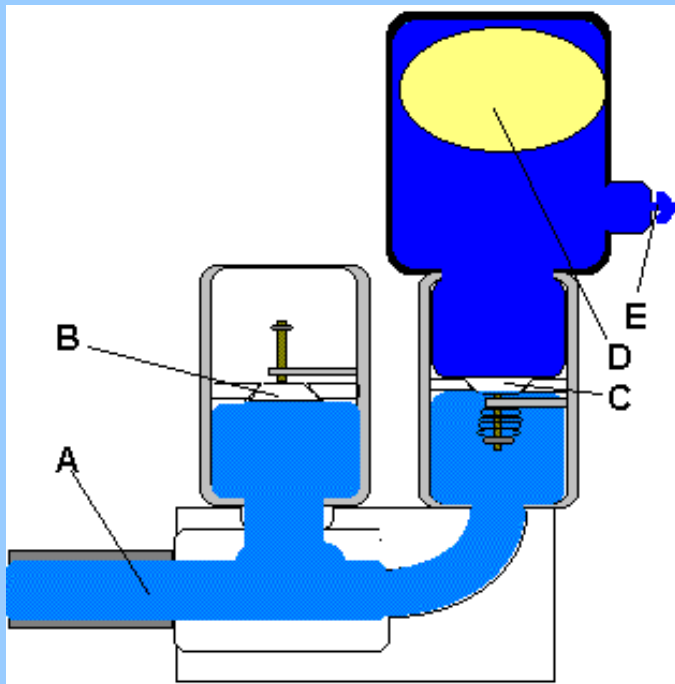

Drive water (A) is stopped; Clack valve (B) is closed; Check valve (C) is closed. Air volume (D) is expanding and pushing some water out the outlet (E) to the delivery pipe. The whole sequence starts over again-about every 2 seconds.

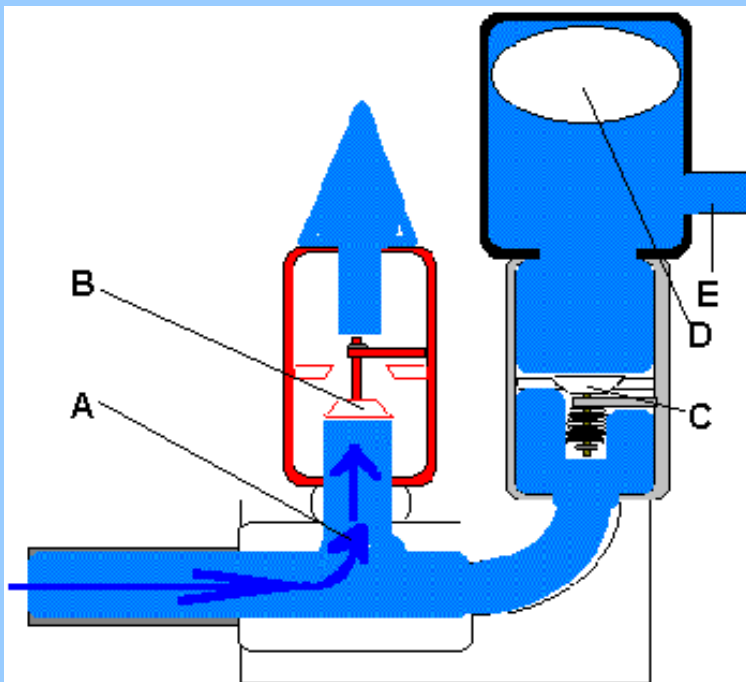

The clack valve (B) drops open, drive water (A) begins to rush into the inlet & out the clack valve. Check valve (C) is shut. The air volume (D) has re-expanded. Water has stopped exiting the outlet (E).

[About the ATLAS RAM PUMP](#)
[About the book](#)

[Ordering Information](#)
[From the publisher....](#)

Questions about the books, ram pumps, quantity orders?
E-mail at: atlaspub@hotmail.com
©2001 Atlas Publications

N. Collier, Publisher

This page started out as one of our marketing tests. It has nothing to do with publishing or the internet, but it is an interesting device of nearly forgotten technology that we use at home every day. We built the page and tried a few experiments, which resulted in thousands of hits! That was the point.

The Amazing Hydraulic Ram Pump

(Note: These days, industrial catalogs list a ram pump as a piston pump actuated by a hydraulic cylinder. Kids! These are often used for pumping pulp slurry in paper mills. That isn't what this page is about.)

Once upon a time, there was an English plumber. He was having a heck of a time with a lead pipe in an English hospital. (Lead pipe? This was hundreds of years ago and they didn't know any better!) Anyway, the pipe frequently broke when someone turned the tap off quickly. The water was coming from a cistern, so there really wasn't much pressure. The pipe kept breaking.

This was looking bad for his reputation, so the plumber determined himself to relieve this excess pressure. To do so, he ran a pipe from the faucet up the outside wall, until it was above the level of the cistern. Problem solved! NOW, however, every time the faucet was turned off, a jet of water shot up the outside wall. It didn't hurt anything, but it wasted water. The plumber extended the pipe higher, but the water still shot out. He got the bright idea of directing this jet of water into a small tank on the top floor of the hospital. Then, the upper floor had a supply of running water!

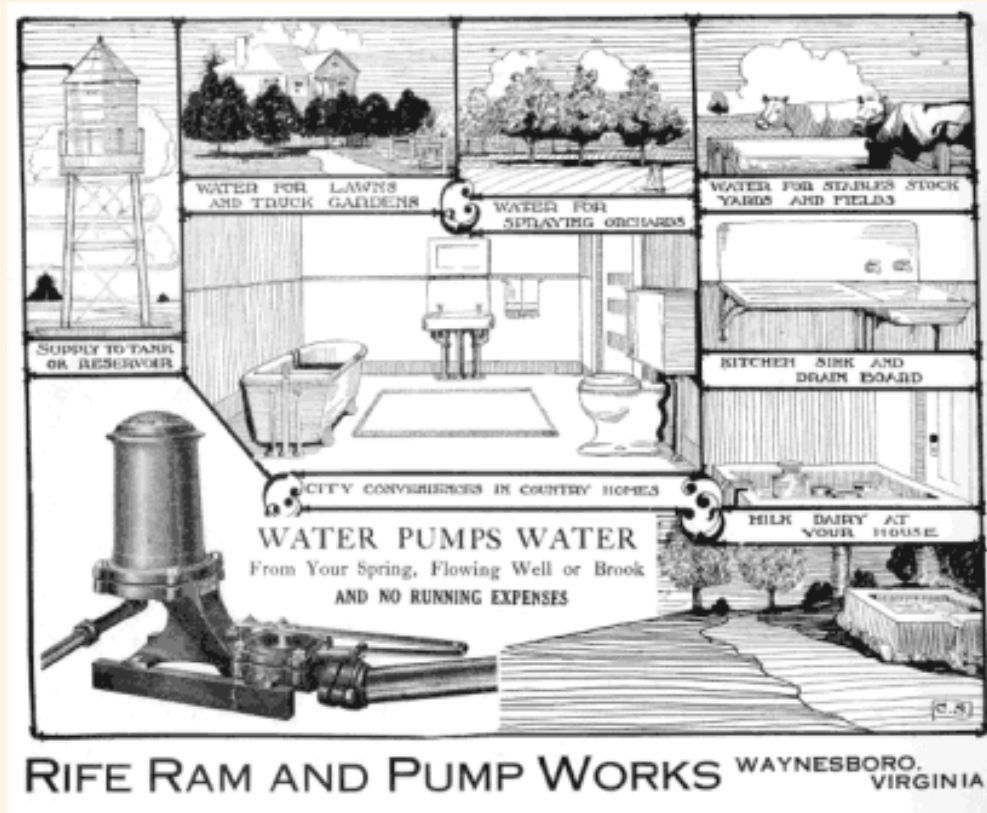

Fig. 1. We use a Rife Model 20, similar to the one above. There is none better.

Somewhere along the line, a Frenchman named Montgolfier (He and his brother were best known for being the first to send livestock aloft in a hot air balloon. It takes all kinds...) rigged up a couple of valves to automate the process. As flow developed, it would slam a ball against a seat, forcing the pressure through a check valve and into an air chamber. It looked like this:

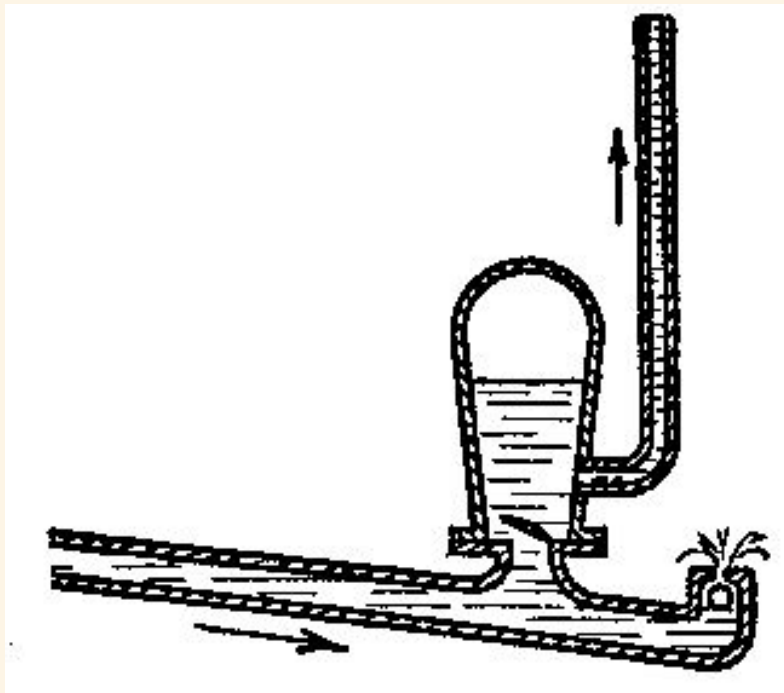

Fig. 2. Montgolfier's Water Ram

Okay, we spoke of high pressure breaking the pipe? From where did this pressure come? Let's say the level of the cistern is 16 feet above the level of the faucet. Figure about .5 psi for every foot of elevation. 7-8 pounds won't break a pipe, yet you've probably heard pipes bang when a faucet closes quickly. What's causing this?

Now, I'll get out Mark's Standard Handbook for Mechanical Engineers. They have a simpler formula than the one we posted earlier. If we ignore little things like the temperature of the water and the elasticity of the pipe, we'll save a lot of math and not give up much in accuracy. Besides, we want to see just how much damage we can do. The handbook gives the stripped down equation of $\Delta P = -P \times c \times \Delta V$. ΔP will be our change in pressure. P is the inlet pressure (let's say 8). c is the velocity of sound in water, or 4860 (this sonic shockwave is the secret source of the big numbers). ΔV is the change in velocity of the water (let's say we go from 3 feet/second to zip, for -3). Our $\Delta P = -8 * 4860 * -3 = 116640$. Don't panic, we need to divide that by 144 to get pounds per square inch. Wow! That's still 810 psi! No wonder the pipes broke! Mark's editor concludes "Water hammer can be dangerous."

Turning the valve off slowly, having an air chamber, or having pipes made of rubber would have reduced this pressure surge to manageable, or even useful levels.

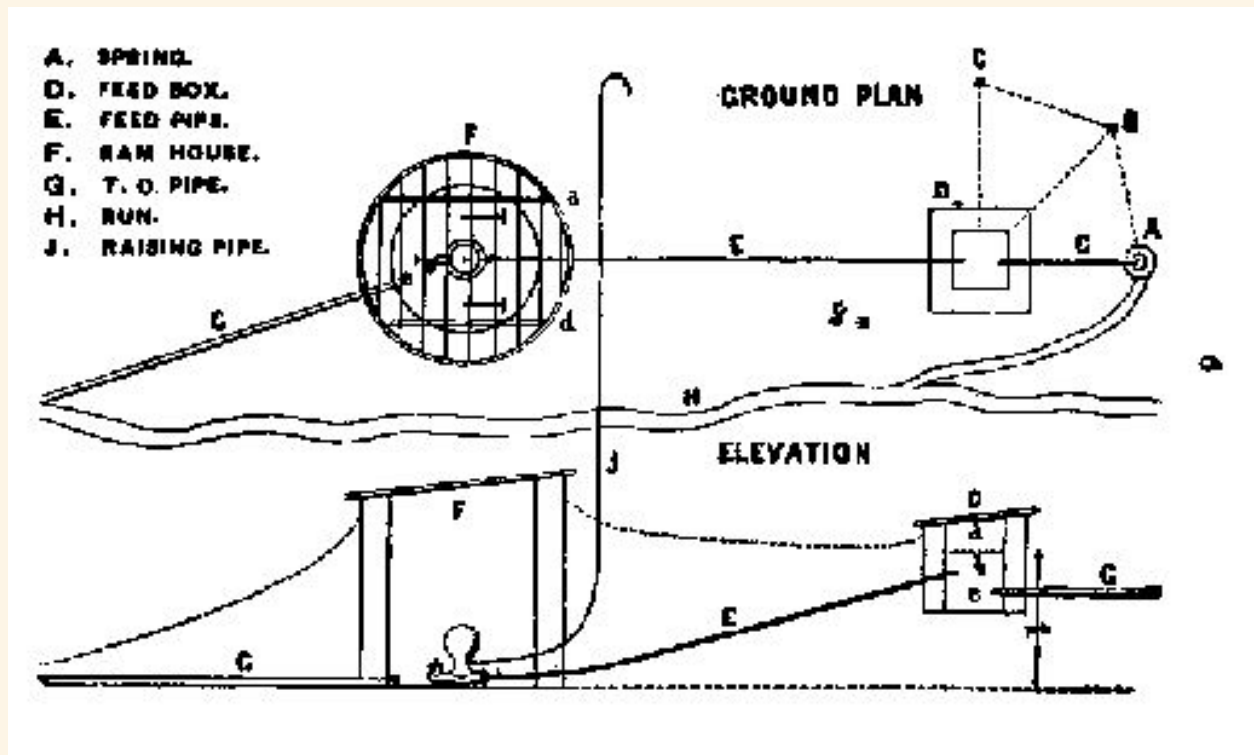
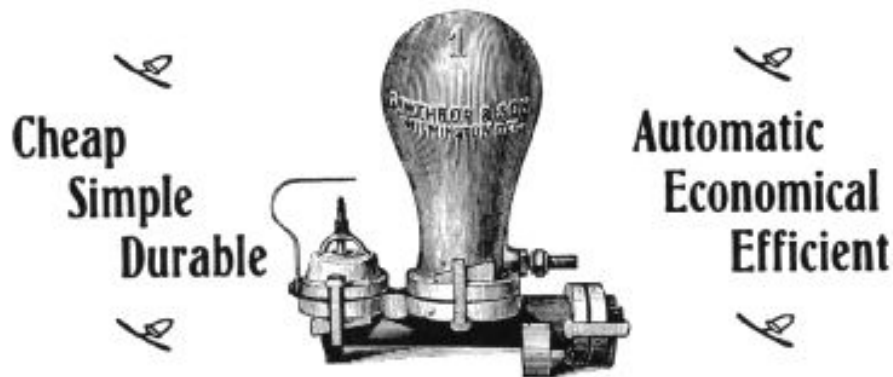

Fig. 3. This is how you lay it out.

For a more practical example, water from my spring runs down the hill in a 2 inch pipe to a standpipe. The water level in the standpipe is 10 feet. From there, it goes down a 60' 2 inch drive pipe to the ram. Anybody want to do the math? It bangs away about 80 times per minute. The pump pushes the water through the 3500 feet of pipe to my house and barn. The highest point is around 85 feet above the pump. Rather than build an elevated tower, I have the water go into pressure tanks. There is less than a gallon per minute from the pump, but the pressure tanks allow us to flush toilets, shower and do laundry all at the same time. Most of the water ends up going out a relief valve that serves two purposes: It gives my cats and armadillos drinking water and it prevents my pipes from exploding. We've been using various rams since 1986 and that is our only source of water.

GAWTHROP'S HYDRAULIC RAM



MANUFACTURED BY
ALLEN GAWTHROP, Jr.
Successor to A. Gawthrop & Son
No. 100 W. Fourth St. Wilmington, Del.

Fig. 4. It stands to figure that a cast iron machine that sits in water will get some rust on it. Getting the bolts loose is often best done with a torch. Gawthrop's pump was held together with wedges. It was assembled and disassembled with a few taps of a hammer.

You know that expensive spring water everybody pays so much for? That's what I use to wash my car and flush my commode!

fig. 1 - Cutaway diagram of Rife Model B

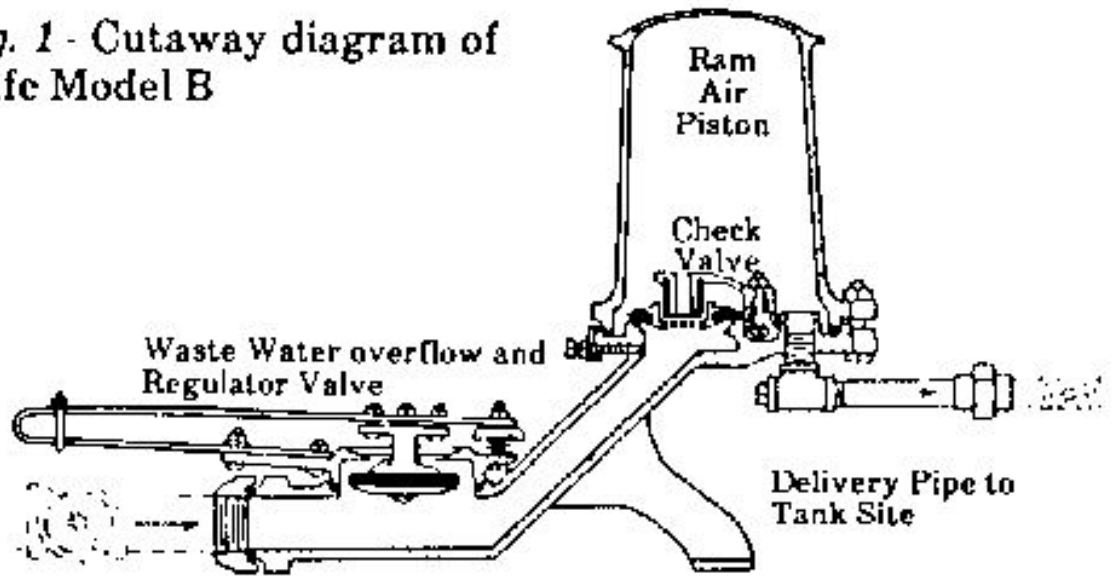

Fig. 5. Catalog cut of a pre-1919 Model. Newer ones use a hinged valve instead of the hairpin spring. Newer models also use a thick rubber disc over a grate for a check valve. Either way works fine

[HOMEPower MAGAZINE](#) is a wonderful resource. They have allowed us to use the pictures and diagrams below AND several articles in one Adobe Acrobat PDF file. If you have Acrobat Reader, go ahead and download this so you'll have it. If not, click the icon to get it. Please note that Acrobat's default setup does not always work right. If you have problems, read our [HELP](#) notice. Be sure to visit HP to download their latest issue and browse through their download section.



[DOWNLOAD](#) RAMPUMPS.PDF

(about 3 minutes)



Fig. 6. This Folk Ram looks like a solid performer. Read the article.

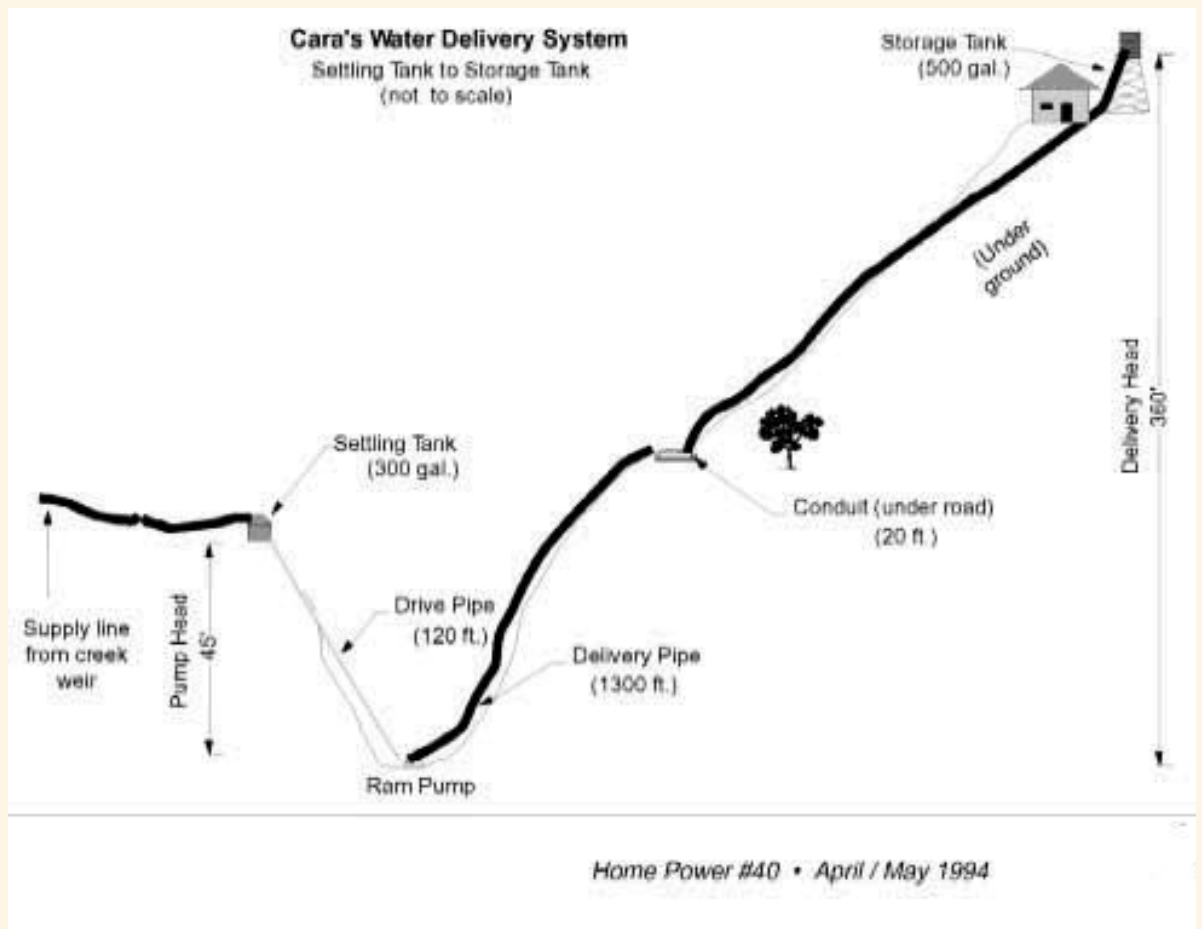

Fig. 7. A real system from Homepower Magazine

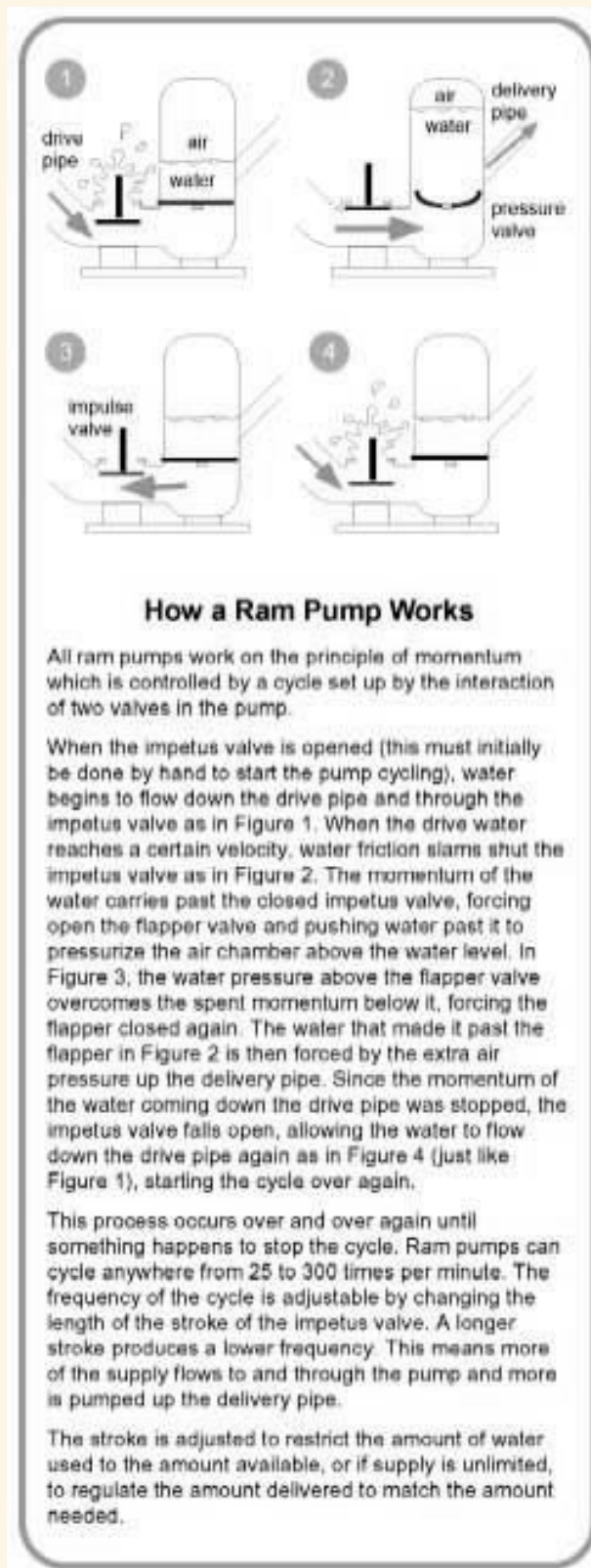

Fig. 8. Courtesy Homepower Magazine

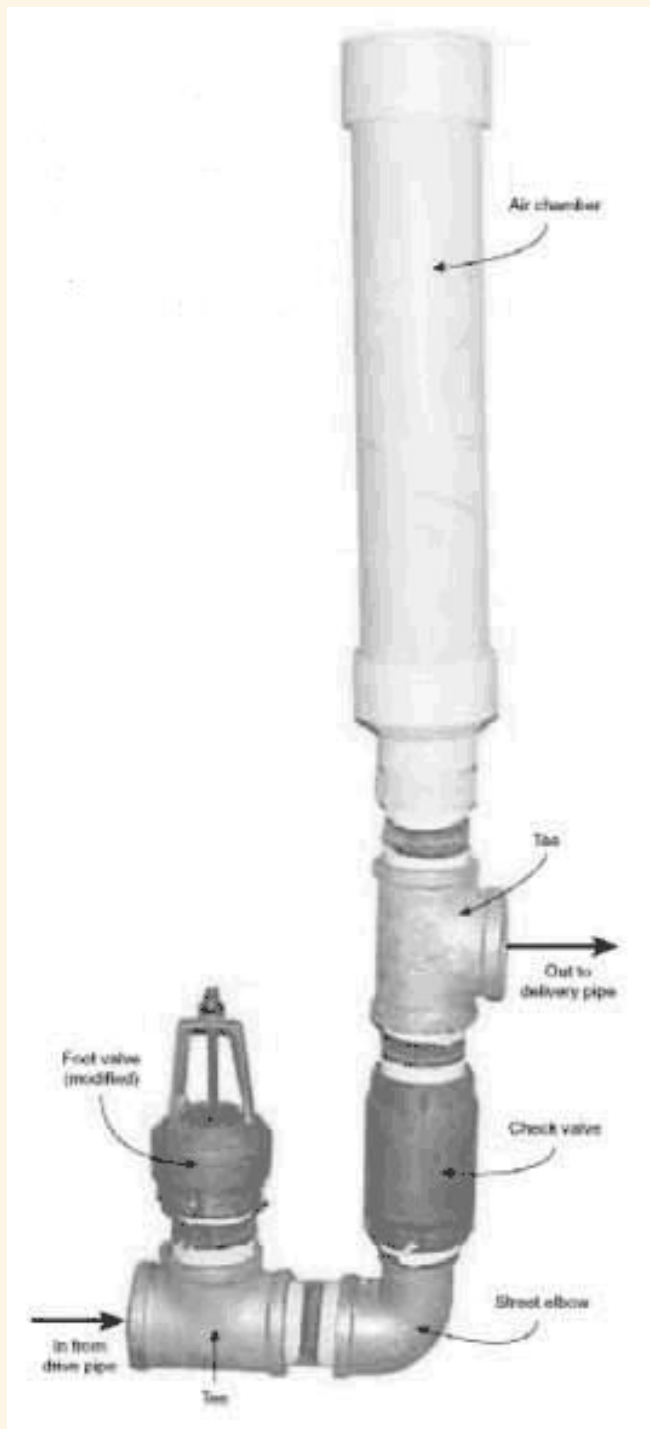

Fig. 9. We used a homebuilt pump similar to this, but it had a hairpin valve like the Model B Rife. Easy to build and dependable. Get the [download!](#)

January 28, 2005

[Home](#) | [Member Login](#) | [View Cart](#) | [Contact Us](#)

**World's Largest &
Longest Running**

16TH ANNUAL
**Renewable Energy &
Sustainable Living Fair**
JUNE 17-19 · CUSTER, WI



Site
Search:

[Magazine](#)[HP Archive](#)[Resources](#)[Education](#)[Events](#)[Advertising](#)[Links](#)[Store](#)

HP Magazine

[Issue #104 Contents](#)



[Sample Our Current Issue](#)

Welcome to HomePower.com!

Home Power magazine, the hands-on journal of home-made power, grew out of our passion for renewable energy (RE). We're concerned about a world that is increasingly polluted. We're concerned about the high energy use and waste of "developed" cultures. And we're concerned that people are dependent and unable to care for themselves when it comes to energy. Renewable energy gives people control over their energy future by using energy that is provided daily by nature. New to Home Power... [click here](#) to learn about us!

Feature Articles

Solar-Electric Basics

Perhaps what the home-scale renewable energy (RE) world needs most are ways to introduce people to RE technologies and the gizmos that make it possible. After all, even the best ideas aren't embraced until they are explained in simple terms.

So whether you are the rookie who wants to understand how solar-electric systems work, or that better describes your spouse, friend, or prospective customer, this article explains the guts and bolts of the three most common options in solarelectric systems: grid-intertied, grid-intertied with battery backup, and off-grid (stand-alone)....[more](#)

Green Building Products

Whether it's for environmental, political, or health



RE Directory

Need HELP? Locate an RE business in your area:



RE Tips

Check your battery connections for cleanliness and tightness every 6 months.

Think About It...

"Laughter is the sun that drives winter from the face."

— Victor Hugo

Poll

The renewable energy information I need MOST is....

Product pricing, comparison, and selection

Detailed instruction on how to do things myself

Explanations of how various technologies work

Real-world examples of renewable energy systems in use

[View Results](#): 3028 votes

([Click here](#) for our complete reader survey or to post other comments.)

reasons, many homeowners today are turning over a new leaf and building green. Besides producing their household's electricity from renewable energy sources like the sun and wind, many are incorporating natural, recycled, or reclaimed building products into their home's design and construction.... [more](#)

[Magazine](#) | [HP Archive](#) | [Resources](#) | [Education](#) | [Events](#) | [Advertise in HP](#) | [Links](#) | [Store](#)
[Your Account](#) | [Subscribe/Renew](#) | [Reader Feedback](#) | [Contact Us](#) | [Terms Of Use](#) | [Privacy Policy](#)
Copyright © 1987-2005 Home Power, Inc. All rights reserved.

NOTE: You must have the **FREE Adobe Acrobat Reader version 4 or above** installed to view our PDF files. Have [questions or problems](#) with our PDF files?



2,484,641 hits since 8/5/02.
1207 hits today (01/28/05).





Hydraulic Ram Pump System Sketches

Sample Hydraulic Ram Installation

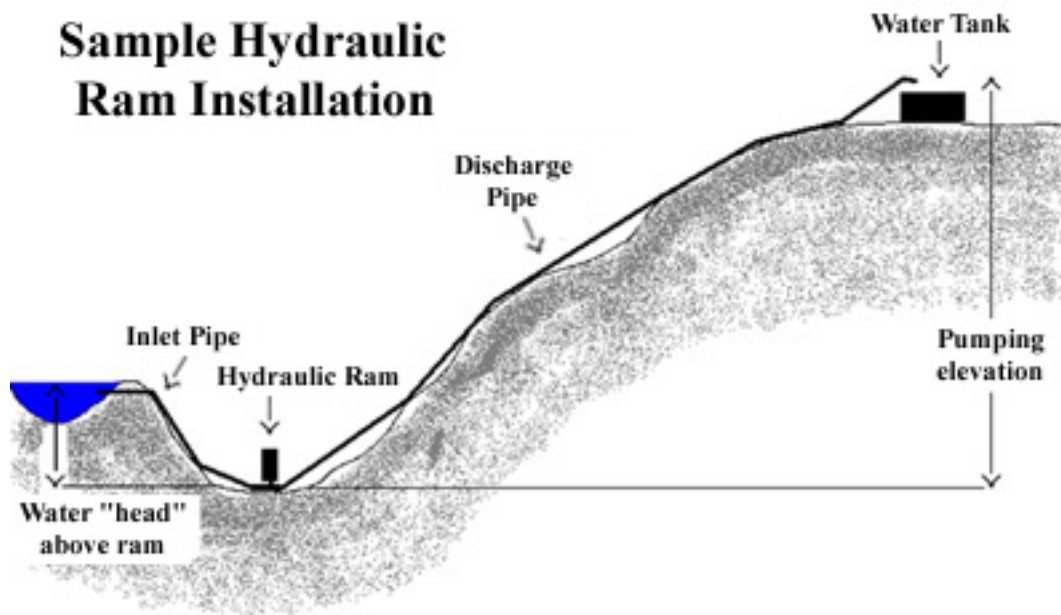

Figure 1. This installation is the "normal" ram system where the inlet pipe is less than the maximum length allowed. No stand pipe or open tank is required.

Sample Hydraulic Ram Installation

(with open tank)

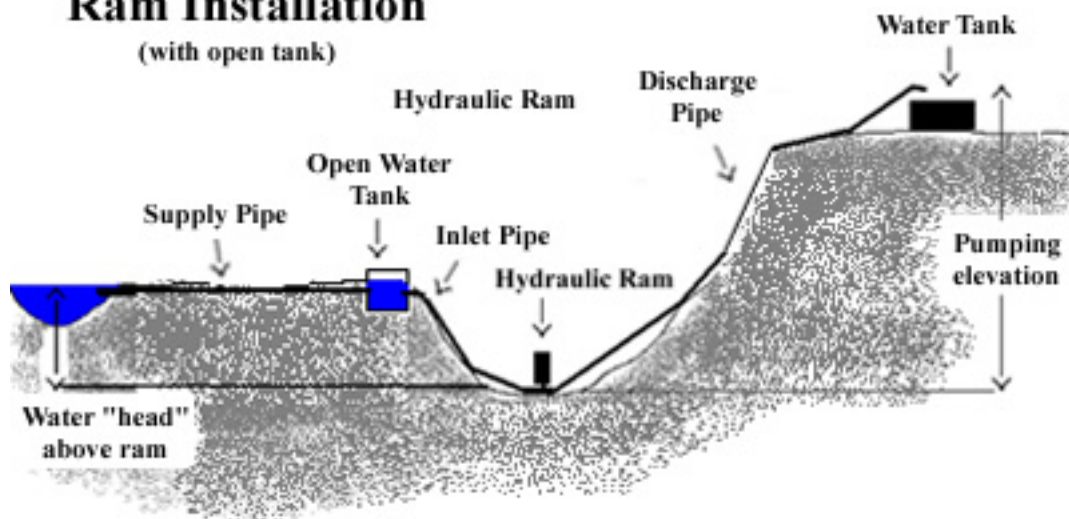

Figure 2. This installation is one option used where the inlet pipe is longer than the maximum length allowed. The open water tank is required to allow dissipation of the water hammer shock wave.

Sample Hydraulic Ram Installation (with stand pipe)

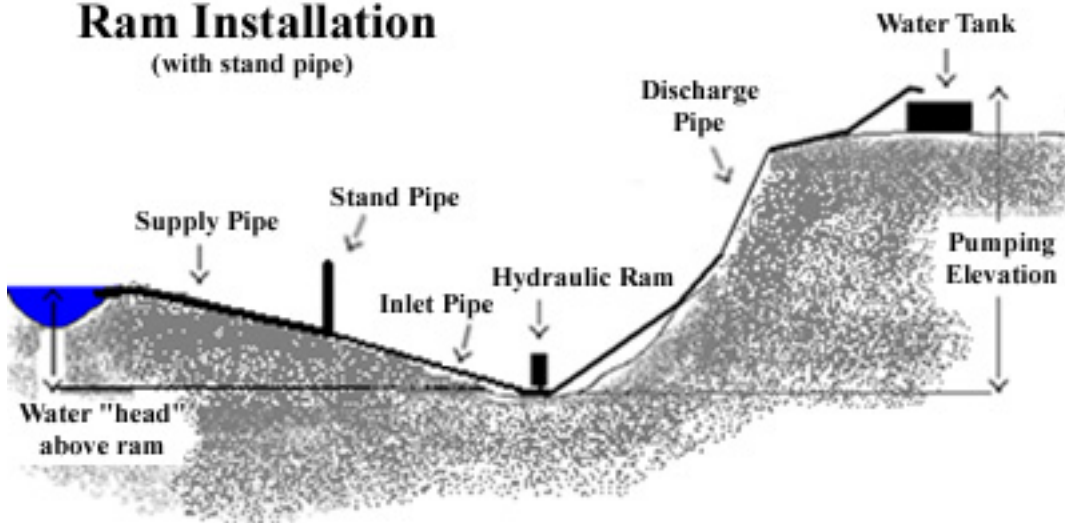

Figure 3. This installation is another option used where the inlet pipe is longer than the maximum length allowed. The stand pipe (open to atmosphere at the top) is required to allow dissipation of the water hammer shock wave.

[Back to Hydraulic Ram Page](#)



Water
Pumps
Water

Pump Water Without Electricity or Fuel !!

Rife, for over a century, has been dedicated to providing the means of pumping water without electricity or fuel. As we begin the new millennium, Rife is expanding its horizons and is adding a wide array of products for agriculture, the home, and the outdoors. Because our pumps do not require electricity or fuel and are built to last, you and your family will continue to enjoy running water for decades to come without the unnecessary costs.

Throughout the 116 years that we have been in business, Rife continues to be family run and owned, priding itself on its quality products made in the USA. Upon entering our third century of existence, we continue to retain the ideals that we have held sacred since 1884:

Customer Satisfaction • Quality Workmanship • Superior Products

[Click here to enter](#)



MADE IN THE USA

Home-made Hydraulic Ram Test Installation

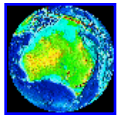

Figure 1. The ram pump installed and operating. Note the water exiting the waste valve and the rock used to hold the pump upright and anchor it.



Figure 2. The 1-1/4 inch Schedule 40 PVC drive pipe supplying the ram pump. Note the curves in the pipe due to the geometry of the stream channel. The pump worked quite well despite the lack of straightness of the pipe.

[Back to Hydraulic Ram Page](#)



The Bamford "Hi-Ram Pump"®

Introduction

[\[Introduction\]](#) [\[Latest News\]](#) [\[About the Pump\]](#) [\[Questions & Answers\]](#) [\[Prices\]](#)
[\[Pump Installation\]](#) [\[File Downloads\]](#) [\[New Applications\]](#) [\[Links\]](#) [\[Contact Us\]](#)

"Hi-Ram Pump"® - A New, Simple and Economical Pump - Powered by Water.

An Australian Invention - Australian Patent No. 741896

The pump is quiet and is operated solely by the energy in a flow of water entering from above the pump. It uses no external source of power such as electricity, petrol or diesel.



A basic version of the "Hi-Ram Pump"
(The steel pipe on the left is the drive pipe entering the pump)

Particularly in developing countries, the choices for pumping water are often limited because reliable or affordable sources of power are not available. The idea of a water pump powered by water is not new, but is very relevant in a world where energy conservation is increasingly important. The hydraulic ram pump, invented more than 200 years ago, is one such pump.

Although the principle of operation of the Bamford Hi-Ram Pump is similar to that of a traditional

hydraulic ram pump, the new pump is considerably different in its construction and operating characteristics.

As is described in the section "About the Pump", the Bamford Hi-Ram Pump uses an inlet flow of water at low pressure to pump some of that water to a higher pressure or height. The pump has a self-sustaining cycle of operation about one second long. One typical installation is where water diverted from a stream drives the pump, with some of the water going up hill to a greater height, and the remaining water going to waste back to the stream.

The basis of the pump is a new waste valve mechanism with two moving parts, both of which can be very easily removed for maintenance or to adjust the pump.

In comparison with conventional hydraulic ram pumps, some of the different characteristics of the Bamford Hi-Ram Pump are as follows:

Its performance can be quickly adjusted for different pumping conditions, by using alternative moving parts in the valve mechanism.

Although the basic pump is very simple, additional components can be used to improve its performance in special roles.

It will work against both high and low output heads, thereby covering a much wider range of operating conditions.

The pump will operate when totally underwater (but the inlet flow of water to operate the pump must come from another source above the surface of the water).

The water going to waste need not spill out around the pump, but can be piped away for further use.

Depending on the operating conditions, the pump can be constructed wholly or partly from metal, plastics or other materials.

When constructed of non-metallic materials, the pump emits little noise.

The pump can be arranged to supply compressed air (but needs an air inlet pipe if underwater).

The pump can be arranged to provide a direct mechanical output to drive other devices.

The capability of the pump to "suck in" air can also be used to suck in water so that the pump acts as a suction pump for small suction heads.

Production pumps are now available as a basic water pump of the type shown above. Additional parts for the pump to produce compressed air, or provide a mechanical output, or act as a suction pump are normally not provided. Provision of pumps for special applications needs to be the subject of a special order.

However, just in case of misunderstanding, you cannot pump water from a well or pool of water by just lowering the pump into the water - the pump must be driven by a flow of water coming from above the pump.

The Bamford Hi-Ram Pump considerably extends the usefulness of such devices for developing countries. Its ability to produce compressed air could be of particular use. Its ability to give a mechanical output could provide a means to pump clean drinking water from another source.

With reduced manufacturing costs and simplicity, the Bamford Hi-Ram Pump also has the potential to establish new roles in developed countries, and significantly increase the market for pumps using the hydraulic ram principle.

Queries from potential manufacturers or licensees are welcome.

Pumps are available for export, and more information about price and availability is shown in the "Latest News" Page.

Email hi-ram@bamford.com.au

Bamfords, Post Office Box 11, HALL ACT 2618, AUSTRALIA

Phone +(61 2) 6227 5532 Fax +(61 2) 6227 5995

Bamford Industries NSW BN97702171, and John Bamford and Associates NSW L8632225

"Hi-Ram Pump" is a Registered Trade Mark

Copyright ©Bamford Industries 1999-2004

[Home Page](http://www.bamford.com.au) <http://www.bamford.com.au>



Centre for Alternative Technology

We are sorry but the page you requested no longer exists.

**You are being directed to the main CAT
Information Page.**

**Please update your bookmarks when you get the
chance.**



CAT Information Service



[FREE INFORMATION](#)

[Frequently asked questions](#)

[Information sheets](#)

[Global enemies](#)

[How green are you?](#)

[Water-Balanced Cliff Railway](#)

Free Advice and Help From CAT

CAT is one of the very few places in the UK where you can get holistic advice covering every aspect of your energy use and environmental impact. We can help with everything from changing your light bulbs to building a new house. There are many reasons why people get in touch with us - [click here](#) to read about some of the most important ones, and to find out what you can do to make a difference.

CAT's free information service offers advice and information on all aspects of sustainable living. Every week we answer hundreds of enquiries by mail, phone and email. We can help you choose what measures are the most useful for you to take to reduce your environmental impact, lower your carbon footprint, and reduce your energy bills.

If you have a query about any aspect of sustainable practices and technologies, from solar water heating to compost making, you should first try the following steps:

- Enter a few key words or a phrase into the search box at the top of the page; this will give you a list of related information sheets, publications, courses, and more.
- Have a look at the list of our 10 most [Frequently Asked Questions](#)
- Browse through our [Information Sheets](#). These give advice on popular topics, such as energy efficiency, renewable energy through the grid, or composting toilets.

- Check out our [new CAT publications web page](#). We may well have already thought of your problem and published the answer.
- If you cannot find an answer, then [fill out a form with your query](#) and email it to us.

It costs money to answer your questions and we are a charity, so we ask if you can make a donation with your query.

[Back to top](#)

GREEN & CARTER

INVENTORS AND PATENTEES OF THE HYDRAULIC RAM PRINCIPLE IN 1774



[About us](#)

[Products](#)

[Services](#)

[Orders](#)

[Contact Us](#)

[Links](#)

Green & Carter have been manufacturing RAM pumps for over **200 years**.

The Vulcan hydraulic RAM is still our only product, consequently our knowledge on the subject is second to none meaning you can deal with us in perfect confidence.

VULCAN HYDRAULIC RAM DRAWING NO. 5



Hydraulic Ram Pumps



Low maintenance pumping of water without electricity!

Click [HERE](#) if there is no button bar on the left side of your screen!

- [Home](#)
- [Problem](#)
- [About Us](#)
- [Wells & Washrooms](#)
- [On-Line Resources](#)
- [How to Help](#)
- [Contact Us](#)
- [Links](#)
- [Site Updates](#)
- [Site Map](#)
- [Search](#)



Hydraulic ram pumps are a time-tested technology that use the energy of a large amount of water falling a small height to lift a small amount of that water to a much greater height. In this way, water from a spring or stream in a valley can be pumped to a village or irrigation scheme on the hillside.

Depending on the difference in heights between the inlet pipe and the outlet pipe, these water pumps will lift 1-20 percent of the water that flows into it. In general, a ram can pump approximately one tenth of the received water volume to a height ten times greater than the intake. A hydraulic ram pump is useful where the water source flows constantly and the usable fall from the water source to the pump location is at least 91 cm (3 ft).

Since ram pumps can only be used in situations where falling water is available, their use is restricted to three main applications:

- lifting drinking water from springs to settlements on higher ground.
- pumping drinking water from streams that have significant slope.
- lifting irrigation water from streams or raised irrigation channels.

Ram Pump Advantages include:

1. Inexpensive
2. Very simple construction and easy to install yourself.
3. Does not consume petrol, diesel or electricity.
4. Minimum maintenance.
5. Pollution free.
6. Quiet pumping 24 hours per day.

Hydraulic Ram Pump Links

- [Designing a Hydraulic Ram Pump](#) (Water for the World)
- [Ram pump History and Design](#) (Center for Alternative Technology - UK)
- [Hydraulic Ram Book - How & Where They Work](#) (Atlas Publications - North Carolina)
- [Ram Pump Technical Notes](#) (Dev. Technology Unit - UK)
- [Build Your own Ram Pump](#) (Clemson University)
- [Ramp Pump Design Specifications](#) (Institute for Appropriate Technology)
- [Highlifter Ram Pump](#) (25 page book providing step-by-step instructions on designing, making, installing and operating a hydraulic ram waterpumping system)
- [Hydraulic ram pumps Engineering Principles](#) (North Carolina Extension Service)
- [Hydraulic Ram Pump System Design and Application](#) (Research, Development and Technology Adaptation Center, Addis Ababa, Ethiopia)
- [Pictures of Ram Pumps](#) (D. Burger - UK)
- [Ram Pumps](#) (Internet Glossary of Pumps)
- [Gravi-Chek Pump](#) (Updated Ram Design)

Suppliers of Hydraulic Ram Pumps

- ["Highlifter" and Ram water pumps](#) (California)
- [Aquatic Ecosystems Inc](#) (Florida)
- [Folk Ram Pump Supplier](#) (USA)

- [York Industries \(Pennsylvania\)](#)
- [Alternative Energy Engineering \(California\)](#)

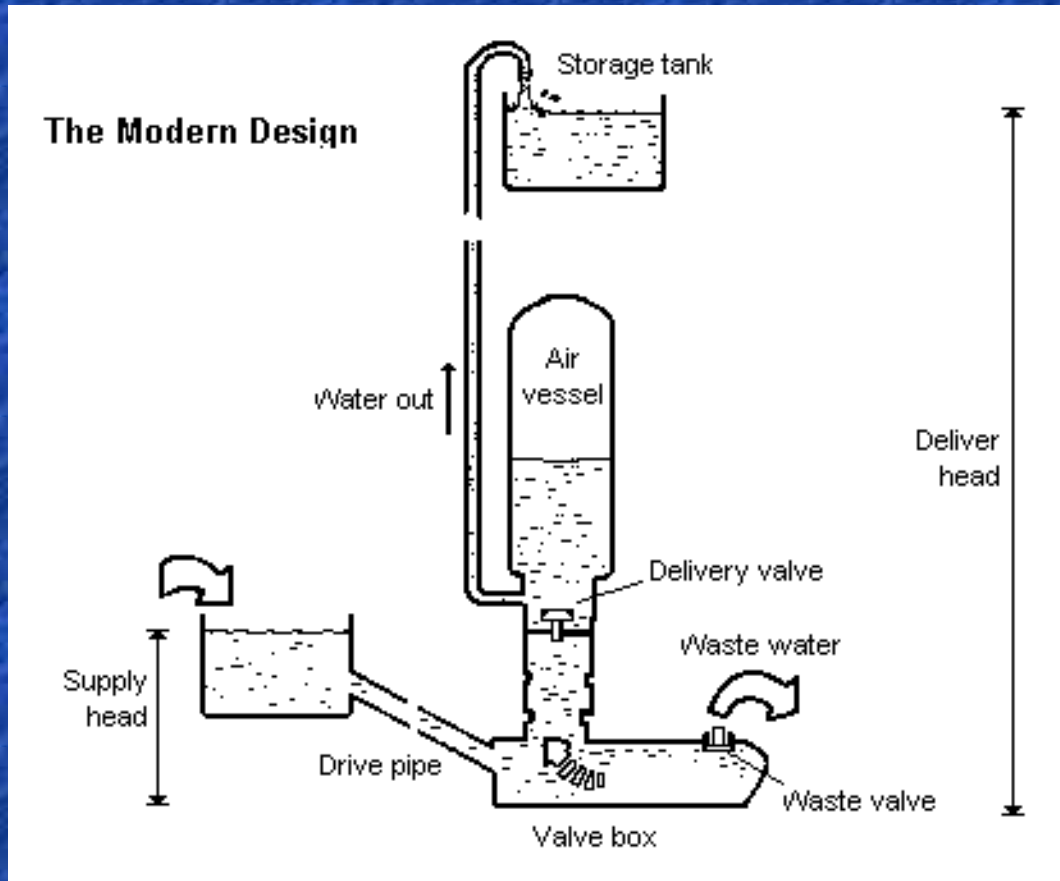

[Sling Pump Links](#)

- [Sling Pump](#)
- [Sling Pump for Agricultural Watering](#)
- [Sling Pump Fact Sheet for Agriculture](#)
- [Sling Pumps for Sale](#)
- [Rife Sling Pumps](#)

North Carolina Cooperative Extension Service



**Water Quality &
Waste Management**

Hydraulic Ram Pumps

Prepared by:

Gregory D. Jennings

Agricultural Engineering Extension Specialist

Published by: North Carolina Cooperative Extension Service

Publication Number: EBAE 161-92

Last Electronic Revision: March 1996 (JWM)

A hydraulic ram (or water ram) pump is a simple, motorless device for pumping water at low flow rates. It uses the energy of flowing water to lift water from a stream, pond, or spring to an elevated storage tank or to a discharge point. It is suitable for use where small quantities of water are required and power supplies are limited, such as for household, garden, or livestock water supply. A hydraulic ram pump is useful where the water source flows constantly and the usable fall from the water source to the pump location is at least 3 feet.

Principles of Operation

Components of a hydraulic ram pump are illustrated in Figure 1. Its operation is based on converting the velocity energy in flowing water into elevation lift. Water flows from the source through the drive pipe (A) and escapes through the waste valve (B) until it builds enough pressure to suddenly close the waste valve. Water then surges through the interior discharge valve (C) into the air chamber (D), compressing air trapped in the chamber. When the pressurized water reaches equilibrium with the trapped air, it rebounds, causing the discharge valve (C) to close. Pressurized water then escapes from the air chamber through a check valve and up the delivery pipe (E) to its destination. The closing of the discharge valve (C) causes a slight vacuum, allowing the waste valve (B) to open again, initiating a new cycle.

The cycle repeats between 20 and 100 times per minute, depending upon the flow rate. If properly installed, a hydraulic ram will operate continuously with a minimum of attention as long as the flowing water supply is continuous and excess water is drained away from the pump.

System Design

A typical hydraulic ram pump system layout is illustrated in Figure 2. Each of the following must be considered when designing a hydraulic ram pump system:

1. available water source
 2. length and fall of the drive pipe for channeling water from the source to the pump
 3. size of the hydraulic ram pump
 4. elevation lift from the pump to the destination
 5. desired pumping flow rate through the delivery pipe to the destination.
-

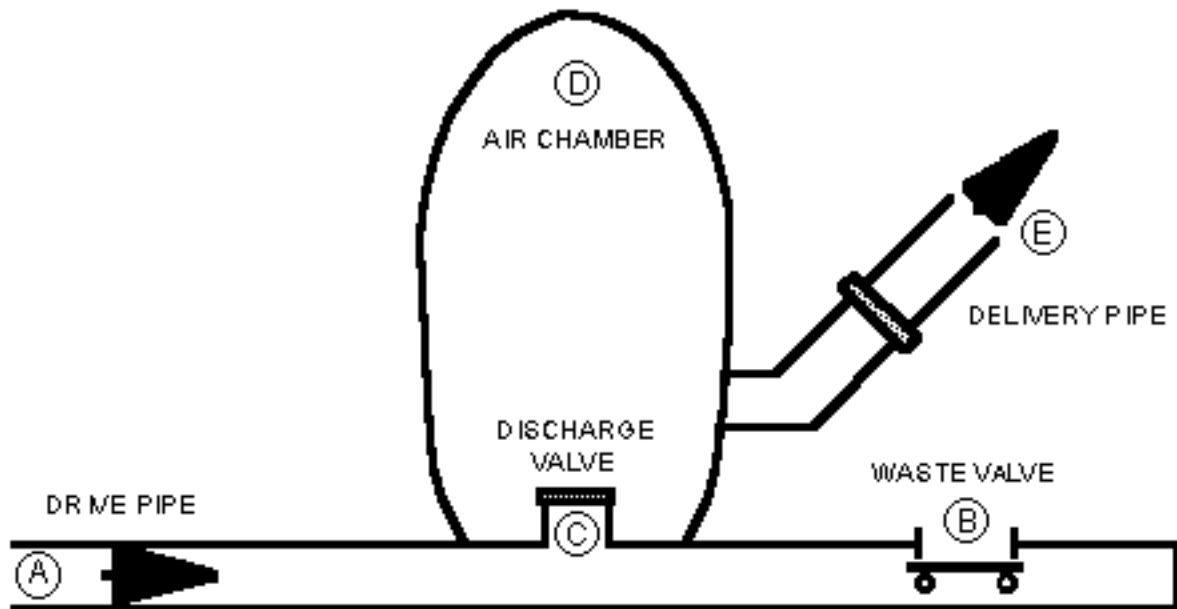

Figure 1. Hydraulic ram pump components.

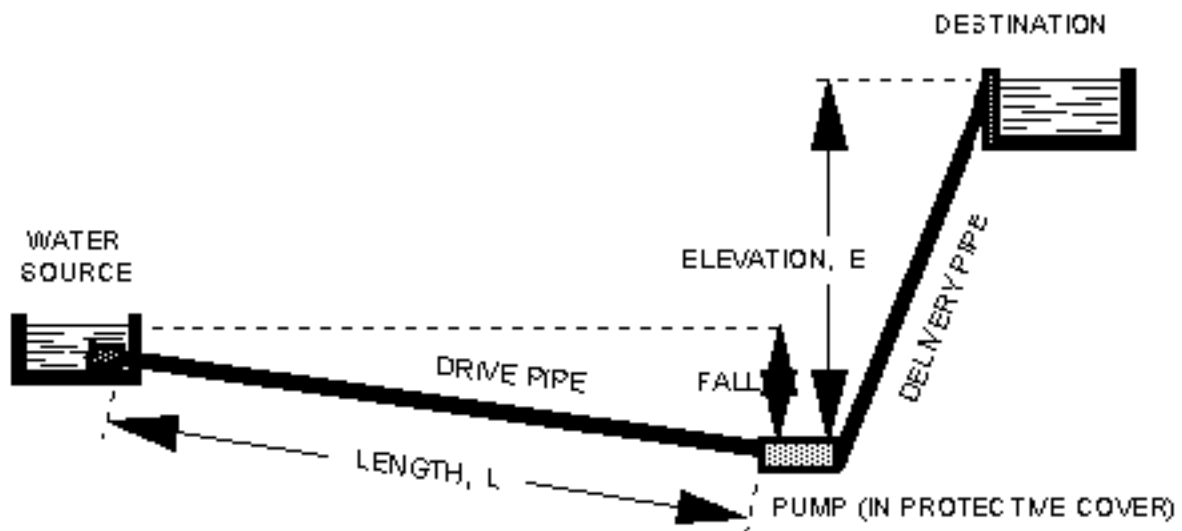

Figure 2. Hydraulic ram pump system layout

A hydraulic ram pump system is designed to deliver the desired pumping flow rate for a given elevation lift. The range of available flow rates and elevation lifts is related to the flow quantity and velocity from the water source through the drive pipe. The mathematical relationship for pumping flow rate is based

upon the flow rate through the drive pipe, the vertical fall from the source through the drive pipe, and the vertical elevation lift from the pump to the point of use. These variables are illustrated in Figure 2. Equation 1 is used to calculate pumping rate:

$$Q = 1440 \times \left[\frac{E \times S}{(L / F)} \right]$$

where:

Q=pumping rate in gallons per day (gpd)

E=efficiency of a hydraulic ram pump installation, typically equal to 0.6

S=source flow rate through the drive pipe in gallons per minute (gpm)

L=vertical elevation lift from the pump to the destination in feet

F=vertical fall from the source through the drive pipe in feet.

To convert the pumping rate expressed in gallons per day(gpd) to gallons per minute(gpm), divide by 1440. The following example illustrates an application of Equation 1.

Example.

A hydraulic ram will be used to pump water from a stream with an average flow rate of 20 gpm up to a water tank located 24 feet vertically above the pump. The vertical fall through the drive pipe in the stream to the pump is 4 feet. Assume a pumping efficiency of 0.6. What is the maximum pumping rate from the hydraulic ram pump?

In this example, E = 0.6, S = 20 gpm, L = 24 feet, and F = 4 feet. The resulting pumping rate, Q, is calculated as:

$$Q = 1440 \times \left[\frac{0.6 \times 20}{(24 / 4)} \right] = 2880 \text{ gpd}$$

The maximum pumping rate delivered by the hydraulic ram pump operating under these conditions is 2880 gallons per day, or 2 gallons per minute.

The example shows how the pumping rate, Q, is directly related to the source flow rate, S. If S were to double from 20 gpm to 40 gpm, the resulting pumping rate would also double to 5760 gpd, or 4 gpm.

The example also shows how the pumping rate, Q, is inversely related to the ratio of vertical elevation

lift to vertical fall, L/F. If L were to double from 24 feet to 48 feet, the lift to fall ratio, L/F, would double from 6 to 12. The resulting pumping rate would decrease by half to 1440 gpd, or 1 gpm.

Table 1 lists maximum pumping rates, Q, for a range of source flow rates, S, and lift to fall ratios, L/F, calculated using Equation 1 with an assumed pumping efficiency, E, of 0.6. To illustrate the use of Table 1, consider a hydraulic ram system with S = 30 gpm, L = 150 feet, and F = 5 feet. The calculated lift to fall ratio, L/F, is 30. The resulting value for Q is 864 gpd, or 0.6 gpm.

Table 1. Maximum pumping rates for a range of source flow rates and lift to fall ratios assuming a pumping efficiency of 0.6.

Lift to Fall Ratio, L/F (ft/ft)	Maximum Pumping Rate, Q (gpd)							
	Source Flow Rate, S (gpm)							
	2	5	10	15	20	30	50	100
2	864	2,160	4,320	6,480	8,640	12,960	21,600	43,200
3	576	1,440	2,880	4,320	5,760	8,640	14,400	28,800
4	432	1,080	2,160	3,240	4,320	6,480	10,800	21,600
5	346	864	1,728	2,592	3,456	5,184	8,640	17,280
6	288	720	1,440	2,160	2,880	4,320	7,200	14,400
7	247	617	1,234	1,851	2,469	3,703	6,171	12,343
8	216	540	1,080	1,620	2,160	3,240	5,400	10,800
9	192	480	960	1,440	1,920	2,880	4,800	9,600
10	173	432	864	1,296	1,728	2,592	4,320	8,640
12	144	360	720	1,080	1,440	2,160	3,600	7,200
14	123	309	617	926	1,234	1,851	3,086	6,171
16	108	270	540	810	1,080	1,620	2,700	5,400
18	96	240	480	720	960	1,440	2,400	4,800
20	86	216	432	648	864	1,296	2,160	4,320
25	69	173	346	518	691	1,037	1,728	3,456
30	58	144	288	432	576	864	1,440	2,880
35	49	123	247	370	494	741	1,234	2,469
40	43	108	216	324	432	648	1,080	2,160
45	38	96	192	288	384	576	960	1,920
50	35	86	173	259	346	518	864	1,728
60	29	72	144	216	288	432	720	1,440

60	29	72	144	216	288	432	720	1,440
70	25	62	123	185	247	370	617	1,234
80	22	54	108	162	216	324	540	1,080
90	19	48	96	144	192	288	480	960
100	17	43	86	130	173	259	432	864

Hydraulic ram pumps are sized based upon drive pipe diameter. The size of drive pipe selected depends upon the available source water flow rate. All makes of pumps built for a given size drive pipe use about the same source flow rate. Available sizes range from 3/4-inch to 6-inch diameters, with drive pipe water flow requirements of 2 to 150 gpm. Hydraulic ram pumps typically can pump up to a maximum of 50 gpm (72,000 gpd) with maximum elevation lifts of up to 400 feet.

Approximate characteristics of hydraulic ram pumps for use in selecting pumps are listed in Table 2. The recommended delivery pipe diameter is normally half the drive pipe diameter. For the system described in the example above, the available source water flow rate is 10 gpm. From Table 2, a pump with a 1-inch drive pipe diameter and a 1/2-inch delivery pipe diameter is selected for this system.

Table 2. Hydraulic ram pump sizes and approximate pumping characteristics.

Consult manufacturer's literature for specific pumping characteristics.

-----Pipe Diameter-----		-----Flow rate-----	
Min. Drive	Min. Discharge	Min. Required Source	Maximum Pumping
-----inches-----	-----inches-----	-----gpm-----	-----gpd-----
3/4	1/2	2	1,000
1	1/2	6	2,000
1 1/2	3/4	14	4,000
2	1	25	7,000
2 1/2	1 1/4	35	10,000
3	1 1/2	60	20,000
6	3	150	72,000

Installation

The location of the water source in relation to the desired point of water use determines how the hydraulic ram pump will be installed. The length of drive pipe should be at least 5 times the vertical fall to ensure proper operation. The length of delivery pipe is not usually considered important because friction losses in the delivery pipe are normally small due to low flow rates. For very long delivery pipes or high flow rates, friction losses will have an impact on the performance of the hydraulic ram pump. The diameter of the delivery pipe should never be reduced below that recommended by the manufacturer.

To measure the available source water flow rate from a spring or stream, build a small earthen dam with an outlet pipe for water to run through. Place a large bucket or barrel of known volume below the outlet pipe, and measure the number of seconds it takes to fill the container. Then calculate the number of gallons per minute flowing through the outlet. For example, if it takes 30 seconds to fill a 5-gallon bucket, the available source water flow rate is 10 gpm. The lowest flow rates are typically in the summer months. Measure the flow rate during this period to ensure that the year-round capacity of the system is adequate.

Purchasing a System

Prices for hydraulic ram pumps range from several hundred to several thousand dollars depending on size and performance characteristics. Contact manufacturers to determine prices and ordering specifications. Send the information listed in Table 3 to the manufacturer to assist in sizing your system properly.

Table 3: Information to provide to the manufacturer for sizing your system.

1. Available water supply in gpm _____
2. Vertical fall in feet measured from the source water level to the foundation on which the ram pump will rest _____

3. Distance from the water source to the ram pump in feet _____
 4. Vertical elevation lift in feet measured from the ram pump foundation to the highest point to which water is delivered _____
 5. Distance from the ram pump to the destination tank in feet _____
 6. Desired pumping flow rate to the destination tank in gpd _____
-

This fact sheet adapted from materials prepared by the California, Florida, and South Carolina Cooperative Extension Services.

A partial list of hydraulic ram pump suppliers is below:

Columbia Hydraulic Ram
Skookum Co., Inc.
8524 N. Crawford St.
Portland, OR 97203

Blake Hydram
Ar & Do Sales Co.
4322 Mt. Vernon Rd. SE
Cedar Rapids, IA 52403
Pacific Hydro Corp.
400 Forbes Blvd.
San Francisco, CA 94080

Rife Hydraulic Engine Mfg. Co.
316 W. Poplar St.
PO Box 790
Norrstown, PA 19401
C.W. Pipe, Inc.
PO Box 698
Amherst, VA 24521

Distributed in furtherance of the Acts of Congress of May 8 and June 30, 1914. Employment and program opportunities are offered to all people regardless of race, color, national origin, sex, age, or

disability. North Carolina State University, North Carolina A&T State University, U.S. Department of Agriculture, and local governments cooperating.

EBAE 161-93

Earth's
Biggest
Selection!
amazon.com.



Small Business Idea Raising Red Claw Crayfish

Crayfish Farming

[All About Hydraulic Ram Pumps-How & Where they Work](#)

Ram pump setup

Buy it Now!

Redclaw
Crawfish

[View Shopping Cart](#)

Farm Books for
Sale

Orders Processed in 24 hours

Small Business Idea

Books

Red Claw and
Crayfish Suppliers
(USA)

[Small Scale Crayfish Farming for Food and Profit](#)

Buy it Now!



[Red Claw-Raising The Giant Australian Freshwater Crayfish](#)

Buy it Now!

Windows Hosting
\$8.95/month



BOOK REVIEWS CRAWFISH FARMING.....

TL Logo
88x31

From 'SMALL FARM TODAY' by Ron Macher, editor: "Both of these booklets ('Small Scale Crayfish Farming' and 'Red Claw! Raising



the Giant Australian Freshwater Crayfish') offer inexpensive, detailed information on the possibilities of raising crayfish for food and profit on a small acreage. There are not many crayfish reference books, and these two small books pack all the information you will need into a tiny price."

Reviewer: A reader from Paintsville, KY: "This is an excellent source of information for people who want to start a crayfish farming business. It covers all aspects, including pond and tank culture, sexing, feeding requirements, and sources for crayfish".

To view your orders and their statuses. Enter the card number that was used to place the order

Card Number

Small Business Idea Crawfish Farming!

[Small Business Opportunity Crawfish Farming](#)

[Red Claw and Crayfish Suppliers \(USA\)](#)

[Farmers Turn Red Claw Pastime Into Profit](#)



All books are 8.5" X 5.5",

**3 color HD paper cover with clear coating.
Pages are all semi-gloss paper, saddle stitch,
with illustrations and photos.**

Free Shipping and Handling

Mail Order Form

**Rampumps.com
1435 Long Ridge Road
Hiawassee, Georgia 30546 USA**

Copyright ©-2005 Rampumps.com

The Ram Company

Pumping water without electricity

[[English](#) | [Espanol](#)]

The *Fleming Hydro-Ram* was developed to give people like you a cost effective way to pump water without electricity. To further this goal they have added *Solar Pumps* to their inventory. The Ram pumps have been tested and improved to pump the most water for the least cost and with the least amount of trouble. Each pump carries their name and they stand behind every one sold.



For more information check out some of the following links:

- [History of the Hydraulic Ram.](#)
- [The Fleming Hydro-Ram, how it works.](#)
- [What a Hydro-Ram can do for you.](#)
- [How much water will it pump?](#)
- [Operational Requirements.](#)
- [Descriptive picture of Fleming Hydro-Ram.](#)
- [Advantages of a Solar Pump.](#)
- [Check out our Solar Submersible Pumps.](#)
- [Or, examine complete submersible pump system packages.](#)
- [Prices and features available.](#)
- [Free evaluation upon request.](#)



The Ram Company

1-800-227-8511 (Virginia)

512 Dillard Hill Road

Lowesville, VA 22967

Email rhfleming@theramcompany.com

*This Site Designed & Maintained by Mattox & Associates
Lynchburg, Virginia
Providing Macintosh Solutions for Home and Business*



Water Lifting

The main internal publications of the DTU are **Working Papers**, **Technical Releases** and **Research Notes**. Most DTU publications are available here for download in a number of formats and hard copies of Working Papers are available free on request to the DTU. Technical Releases will also be sent free on request but only to addressees **in developing countries**.

- **Technical Notes** contain descriptions of designs/techniques for use by manufacturers, extension agents and users of equipment, written in fairly simple English to make them more accessible to technicians speaking other languages.
- **Working Papers** are used for descriptions of research findings and are written for a "professional" audience: comments are welcome. In some cases revised versions are subsequently published in outside journals.
- **Research Notes** are smaller outputs from our research, progress reports of research undertaken by the DTU but as yet incomplete, case study material, and exceptional undergraduate research reports. Often these notes form the basis of fuller Working Paper

This section also contains references to external **Papers and Articles** written by members and associates of the DTU where they are available on-line

Technical Releases

Ram Pump System Design Notes, 19pp

Basic design notes for ram pump systems, covering site selection, basic surveying, pump selection, intake design, settling tanks, Drive system and water distribution

[HTML](#)



Note: scan of the original document.

TR10a Computerised Ram Pump Calculators: A short Users Guide, 12pp

A guide to installing And running the DTU's WINPUMP, PUMPDATA and DOSPUMP freeware programmes used for calculating minimum, maximum and actual delivery water, drive flow, delivery head, drive head and pump efficiency. The programmes themselves can be downloaded [here](#) (256k zipped).

[HTML](#)

Note: scan of the original document.

TR10b Ram Pump System Calculators, 10pp

Two cardboard based calculators, the Ram Pump System Design Calculator for feed and delivery heads and flows, and the Friction Headloss Calculator for pipe friction.

[HTML](#)

Note: scan of the original document.

TR11 DTU S1 Hydraulic Ram Pump : User Instructions/Drawings, 12pp

Describes the installation and use of the DTU S1 ram pump, a steel ram pump suitable for drive heads of 2 to 15 metres and drive flows of 20 to 60 l/m. It typically yields a deliver head of up to 80m and a delivery flow of 0.5-10 l/m. The pump has been designed for local manufacture in small workshops and for ease of maintenance. A complete set of working drawings for the pump's manufacture is also provided.

[HTML](#)

Note: scan of the original document.

TR12 DTU P90 Hydraulic Ram Pump: User Instructions/Drawings, 34pp

A Description and complete set of working drawings for the DTU P90 ram pump, a plastic bodied ram pump suitable for drive heads of up to 3 metres and drive flows of 100 to 360 l/m. It typically yields a deliver head of up to 20m and a delivery flow of 3-40 l/m. The pump has been designed for local manufacture in small workshops and for ease of maintenance.

[HTML](#)

Performance data and design criteria are provided for the M3.2 a prototype of the P60 which will be of interest to designers and researchers.

Note: scan of the original document.

TR13 *New Developments in Hydraulic Ram Pumping*, 6pp

Written for ram pump enthusiasts, researchers and manufacturers. The paper describes current (1996) trends in ram pump and system design including their simplification, the use of contained air, new materials and performance improvements.

[HTML](#)

TR14 *DTU S2 Hydraulic Ram Pump : User Instructions/Making an S2 Pump/Drawings*, 44pp

Describes the DTU S2 ram pump, a steel ram pump suitable for drive heads of 2 to 15 metres and drive flows of 40 to 120 l/m. It typically yields a deliver head of up to 100m and a delivery flow of 1-25 l/m. The pump has been designed for local manufacture in small workshops and for ease of maintenance. A complete set of working drawings and instructions for the pump's manufacture is also provided.

[HTML](#)

Note: scan of the original document.

TR15 *How Ram Pumps Work*, 17pp

Describes what is happening inside working ram pump and how changes in design can effect performance. It covers such topics as the pump cycle, closure velocity, tuning, shock waves and recoil.

[HTML](#)

Note: scan of the original document.

TR16 *Introduction to Hydraulic Ram Pumps and the DTU Range*, 15pp

Explains what ram pumps are, how they work, ram pump systems, site selection and pump selection criteria. The DTU range of ram pumps is also described

[HTML](#)

Note: scan of the original document.

TR-RWH 09 - Low cost handpumps for water extraction from below ground water tanks - Instructions for manufacture, 28pp

Four low-cost handpumps are considered in this document. The document is the culmination of a summer's voluntary work by Warwick student (and qualified machinist), Vince Whitehead. The manual describes in detail the construction of 4 simple designs of handpump, and was developed as a training manual for teaching artisans in Uganda how to make the pumps.

[HTML](#)450kb

Working Papers

WP32 Potential for Non-motorised Irrigation of Small Farms in Manicaland, T.H. Thomas (1991), 27pp

The Working Paper describes the findings of two studies and records the initial test performance of two pumps (one water-powered, the other human-powered) installed near the Model Farm of CATC in Manicaland in Zimbabwe. The aims of the study carried out between mid-August and mid-September 1989 were:

- to identify major social, economic or geographical constraints on the expansion of irrigation of small plots in Communal Areas
- to develop a better specification for water-lifting devices
- to examine the agricultural options available for the use of extra water.

[HTML](#)800kb

WP33 Performance Comparison of DTU and Commercial Hydraulic Ram Pumps, T.D. Jeffery (1991), 39pp

This paper details the performance of the DTU Mark 6.4 hydraulic ram pump in comparison to commercial models run under similar conditions. Details of the performance of a number of commercial pumps tested at Delft University, Netherlands are used for comparison.

[HTML](#)700kb

Note: scan of the original document.

WP34 *The Treadle Pump*, (1991), 37pp

Using a treadle pump to lift water to a height of 5 metres it is possible for a farmer to irrigate approximately 0.25 hectares of land. The pump can be used for long periods of time because of good ergonomic design. The cost of construction is low and the pump can provide an appropriate technology for smallholders with little capital to spend on irrigation.

[HTML](#)

Note: scan of the original document.

**WP39 *The Performance Testing of Treadle Pumps*,
T.H. Thomas (1993), 10pp**

A good treadle pump satisfies many user criteria including some that can be tested under laboratory conditions. The paper describes a set of laboratory tests and suggests performance thresholds that should be reached in them. The tests relate either to efficiency or to ease of priming. Under the description of priming tests there is included an analysis of the effect of any 'dead volume' of trapped air upon the maximum suction head of a pump during priming and during steady operation.

[HTML](#)

Note: scan of the original document.

**WP41 *Algebraic Modelling of the Behaviour of Hydraulic Ram Pumps*,
T.H. Thomas (1994), 26pp**

The mathematical analysis of hydraulic ram-pumps began soon after their invention in the late 18th century. However simple models of adequate accuracy for use by system designers, pump manufacturers, installers and operators are still not available. This paper describes algebraic models of varying complexity for use by system and pump designers and by those involved in training installers and users. It argues that a pump plus drivepipe, rather than pump alone is the natural unit for modelling and for characterising performance in applications literature. Behaviour is shown to depend primarily upon three parameters. The first is λ the ratio of peak drive flow (which depends upon tuning) to the pump's maximum flow with its impulse valve locked open. The second is μ , the ratio of peak drive flow to the 'Joukowski' flow just sufficient to achieve the system delivery head. The third is R , the ratio of delivery head to drive head. The analysis shows some of the trade-offs entailed in tuning, indicates the optimum choice of drivepipe and explains certain forms of malfunction observable in the field. Several 'rules of thumb' are derived. The paper also indicates areas where the greater precision of computer simulation over algebraic modelling is desirable.

[HTML](#)

Note: scan of the original document.

Research Notes

Undrgraduate Project Report – *Development and Selection of Low Cost Handpumps for Domestic Rainwater Water Tanks in E. Africa*, V. Whitehead (2001), 65pp

This report gives details of the development and selection of a handpump suitable for use with domestic rainwater harvesting tanks in East Africa. The objective of the project was to develop a small low cost handpump, which can be manufactured, maintained and repaired with a minimum of tools and skill and that the materials can be found in most local hardware outlets and markets.









Four designs were proposed which were selected from a range of pump technologies for low head and low flow rates. From these, two were selected for their ease of manufacture, low skill level and expected reliability. The two handpumps ('Harold' and the 'Enhanced inertia') were subjected to a series of performance and durability tests.

Papers and Articles

***Economically viable domestic roofwater harvesting* Terry Thomas**

20th WEDC Conference, Colombo, Sri Lanka, (1995)



 DTU Home	 Animal Traction	 Building Materials	 Landmine Clearance	 Rainwater Harvesting	 Water Lifting	 DTU Publications
---	--	---	---	---	--	---



Hydraulic Ram Pump Research Programme



DTU

Ram Pump Programme

mp system design notes

Ram pum

[1](#) | [2](#) | [3](#) | [4](#) | [5](#) | [6](#) | [7](#) | [8](#) | [9](#) | [10](#) | [11](#) | [12](#) | [13](#) | [14](#) | [15](#) | [16](#) | [17](#) | [18](#) | [19](#)

[Next](#) 

[This Document is also available as a high resolution PDF file \(580kb\)](#)

 DTU
Home

 Animal
Traction

 Building
Materials

 Landmine
Clearance

 Rainwater
Harvesting

 Water
Lifting

 DTU
Publications

HYDRAULIC RAM MADE FROM STANDARD PLUMBING PARTS

Cooperative Extension Service/The University of Georgia
College of Agriculture and Environmental Sciences/Athens

There are a number of companies that manufacture hydraulic rams. While manufactured rams come pre-assembled and offer the highest degree of convenience and efficiency, they can be quite expensive. Fortunately, inexpensive ram pumps can be assembled from pipe fittings that are commonly available at most hardware and farm stores.

Assembly is fairly quick and easy. All that is needed is a pair of pipe wrenches, Teflon tape or other thread sealant, PVC cleaning solvent and PVC cement. Table 1. lists all of the parts shown in Figure 1. When assembling threaded fittings liberally apply thread sealant, or use 3-4 turns of Teflon tape and tighten all fittings securely to prevent leaks.

All ram pump fittings except the delivery pipe should be made of either of galvanized steel, brass, or schedule 40 or higher PVC. The delivery pipe can be made of any material provided it can withstand the pressure leading to the delivery tank. Make sure that the swing check and the spring loaded check valves are installed as shown in Figure 1. The flow direction arrow on the body of the swing check valve must point down. The valve below the pressure gauge should be kept closed except while making readings in order to protect the gauge from water hammers.

A bike, wheelbarrow or scooter inner tube serves as an air bladder for the pressure tank. Insert the inner tube into the pressure tank and fill it slightly with air (less than 10 psi). Some inner tubes may need to be folded in order to fit them inside the pressure tank casing. The sealed volume of air contained in the tube prevents either water-logged or air-logged conditions in the pressure tank.

There are several nonessential, but useful parts included in this ram assembly. The ball valves, union fittings, and gauge assembly are all optional. The ball valves on both the drive and delivery pipes are helpful for starting the ram and controlling its flow. The union fittings, also on both the drive and delivery pipes, are helpful for removing the ram for maintenance and/or repairs. The gauge assembly is useful for making

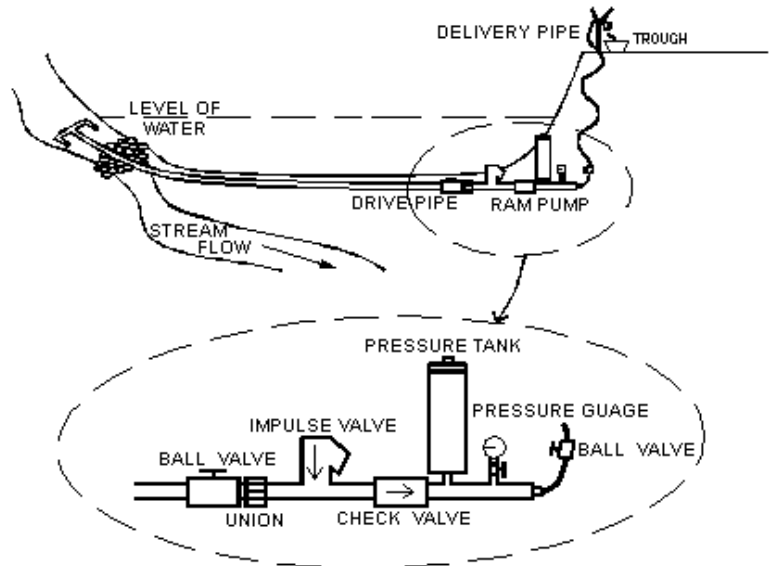

Figure 1. Hydraulic Ram Assembly

pressure readings, especially while starting the ram. Any or all of these fittings can be left out of the ram assembly without affecting pump performance. However, the absence of these parts will make it more difficult to start and maintain the ram.

With the exception of the pressure tank's air bladder, all air trapped in the drive pipe, ram assembly, and delivery pipe must be displaced with water before these rams will pump properly. A few minutes of manual operation, and several re-starts, may be required to displace the trapped air

Pumping to Low Elevations

If the discharge elevation (delivery head) is less than 30 feet, it may be necessary to install either a ball valve or an adjustable pressure relief valve on the discharge (watering trough) end of the delivery pipe. Either of these valves can be used to regulate the water flow through the delivery pipe, which in turn regulates the back pressure on the ram assembly. A back pressure of up to 10 - 12 psi (as read on the pressure gauge) may be required for proper ram performance.

Table 1. Parts List for Hydraulic Rams Made up of Standard Plumbing Parts

Metal Ram Pump

1. Screened water supply
2. 1/4" drive pipe
2. 1/4" ball valve
3. 1/4" x 2" nipple
4. 1/4" union
5. 1/4" x 2" nipple
6. 1/4" tee
7. 1/4" close nipple
8. 1/4" brass swing check valve
9. 1/4" close nipple
10. 1/4" spring loaded check valve
11. 1/4" x 2" nipple
12. 1/4" tee
13. 1/4" x 2" nipple
14. 4" x 1/4" reducing coupling
15. 4" threaded pipe 36" long
16. Inner tube (slightly inflated)
17. 4" pipe cap
18. 1/4" close nipple
19. 1/4" x 3/4" reducing coupling
20. 3/4" x 2" nipple
21. 3/4" tee
22. 3/4" x 1/4" bushing
23. 1/4" x 2" nipple
24. 1/4" ball valve
25. Pressure gauge
26. 3/4" x 2" nipple
27. 3/4" union
28. 3/4" x 2" nipple
29. 3/4" ball valve
30. 3/4" delivery pipe

PVC Ram Pump

1. Screened water supply
2. 1/4" drive pipe
3. 1/4" ball valve
4. 1/4" union
5. 1/4" slip x male adaptor
6. 1/4" threaded tee
7. 1/4" close nipple
8. 1/4" brass swing check valve
9. 1/4" close nipple
10. 1/4" spring loaded check valve
11. 1/4" slip x male adaptor
12. 1/4" slip x slip female tee
13. 1/4" male adaptor
14. 4" x 1/4" reducing coupling
15. 4" pipe 36" long
16. Inner tube
17. 4" pipe cap
18. 1/4" x 3/4" reducing coupling
19. 3/4" tee
20. 3/4" x 1/4" slip x female bushing
21. 1/4" x 2" nipple
22. 1/4" threaded ball valve
23. Pressure gauge
24. 3/4" union
25. 3/4" ball valve
26. 3/4" delivery pipe

Adjusting the Ram

These rams can be adjusted in one of two ways. The swing check valve may be adjusted by first rotating it so that its pivot is in line with the drive pipe and then twisting the valve and tee away from the vertical by as much as 30 degrees. This allows the swinging flap to partially close, which shortens the stroke period. The other way to adjust these rams is to alter the length of the drive pipe. Lengthening the drive pipe will increase the stroke period. Conversely, shortening the drive pipe will shorten the stroke period.

References

Much of the information contained in this publication is adapted from the following publications:

Rife Manual of Information. 1992. Rife Hydraulic Engine Manufacturing Co., Box 367, Wilkes-Barre, PA, U.S.A.

Stevens-Guille, Peter. 1978. An Innovation in Ram Pumps for Domestic and Irrigation Use. *Appropriate Technology*, Vol. 5 No. 1.

Watt, S.B. 1978. A Manual on the Hydraulic Ram for Pumping Water. *Intermediate Technology Publications*, Southampton Row, London WC1B 4HH, UK.

This publication (Misc Eng. Pub. # ENG98-003) was prepared by:

Frank Henning, Special Ext. Agent, Water Quality
 Mark Risse, Ag. Pollution Prevention Specialist
 William Segars, Ext. Water Quality Coordinator
 Vaughn Calvert II, Superintendent., Central GA Branch
 Experiment Station
 Joseph Garner, Sr. Ag. Specialist, Central GA Branch
 Experiment Station



South Carolina Irrigation Pages

[Extension Home](#)[Clemson Home](#)

This web site is provided to furnish information about irrigation systems, practices, management, and research in South Carolina. The information presented is garnered from work done by the Clemson University Cooperative Extension Service and many other sources. Identifying details for the source of the information are provided as the information is presented.

Irrigation Design

Basic information used in irrigation design including pipe sizing and friction loss, elevation loss, velocity head, sprinkler placement, application equations, and other items useful in designing a system. This section will not teach how to design, but will provide information that may not be readily available.

[Irrigation Management](#)

Proper management is the key to successful irrigation. This section identifies several different management schemes and how they are implemented. Also includes information and references on the water needs of various crops and monthly normal precipitation amounts for stations in SC, NC, and Georgia.

[Agricultural Irrigation Equipment](#)

Descriptions and images of many different types of irrigation equipment including pumps, filters, traveling guns, drip, and other related equipment. Also includes a listing of **Agricultural Irrigation Equipment Suppliers** in South Carolina as well as a listing of **alternative pumping systems** for livestock producers.

[Home-made Hydraulic Ram Pump Plans](#)

Plans and a list of materials for construction of a hydraulic ram pump from common items found in local hardware stores.

[Residential and Commercial \(Turf\) Irrigation Equipment](#)

Descriptions and images of many different types of irrigation equipment including pumps, filters, spray heads, sprinklers, drip, water meters, and other related equipment. Also includes a listing of **Residential and Commercial (Turf) Irrigation Equipment Suppliers** in South Carolina.

[SCDHEC Environmental Quality Control \(EQC\)](#)

[Permit Request forms](#)

Links to SCDHEC EQC Forms page as well as individual links to well drilling and dam construction/alteration forms.

Irrigation Research in South Carolina

Links and information on on-going and past research with irrigation in South Carolina.

[Irrigated Acreage in South Carolina](#)

A listing for each year of the actual acreage irrigated in South Carolina by county and irrigation method as well as by crop. This information is compiled for inclusion in the Irrigation Journal's annual irrigation survey each year.

[Irrigation-Related Sites](#)

A list of many varied irrigation sites on the web, including such sites as **Richard Mead's MicroIrrigation Forum** and **Thomas Stein's Virtual Irrigation Library** as well as many manufacturers and suppliers. Sites containing articles of interest are also included.

Check back often! Over the next few months we hope to revise many sections at this site and add many others. Our vision is that of a site that has specific sections - such as "irrigation management", "irrigation equipment", or "alternative pumping systems" - with a wealth of information and related web links located in that area.

Welcome! You are visitor

005050

since 1/28/99

Last modified on 09/08/03

This site created and maintained by [Bryan Smith](#),

Clemson University Cooperative Extension, Laurens County.

The Clemson University Cooperative Extension Service offers its programs to people of all ages, regardless of race, color, gender, religion, national origin, disability, political beliefs, sexual orientation, marital or family status and is an equal opportunity employer. Clemson University cooperating with U.S. Department of Agriculture and South Carolina Counties. Issued in Furtherance of Cooperative Extension Work in Agriculture and Home Economics, Acts of May 8 and June 30, 1914.



USAID
FROM THE AMERICAN PEOPLE



Tsunami Relief - A 9.0-magnitude earthquake and destructive tsunami has caused massive damage in many countries in South and Southeast Asia. USAID is assisting in the relief and recovery effort.

[Click Here to Donate Now](#)



Helping Rebuild Iraq - USAID has been helping Iraqis reconstruct their country since the Saddam Hussein regime was overthrown in May 2003.



Assistance to Afghanistan - USAID is helping build a safe, stable society that meets the needs of its people and eliminates an environment that breeds terrorism.



Darfur Humanitarian Crisis - Though the security situation continues to deteriorate and providing humanitarian assistance is difficult, USAID is doing all it can to help.



New Global Branding - The USAID Graphic Standards Manual sets the standards for the design of Agency communications.



Fiscal Year 2004 Performance and Accountability Report - This report outlines what USAID has accomplished and how well we have carried out our mission.



HIV/AIDS - The U.S. government is the world leader in responding to the global pandemic of AIDS and has made the fight against HIV/AIDS a top priority.



SEARCH

COUNTRY LOCATOR



USAID KEYWORD

[Browse USAID Keyword List](#)

»

IN THE NEWS ...

- 01/27/05: [U.S. Supported Lifesaving Drug Treatment for 172,000 People, During Early Months of President's Emergency Plan for AIDS Relief](#)
- 01/26/05: [Testimony of USAID Administrator Andrew S. Natsios before the House Appropriations Subcommittee on Foreign Operations - US Relief Efforts to Tsunami-Affected Countries](#)
- 01/18/05: [Remarks by USAID Administrator Andrew S. Natsios at the U.S. Chamber of Commerce Forum: Post-Tsunami Reconstruction](#)
- 01/11/05: [New USAID Mission Director for India Sworn In](#)
- 01/11/05: [Remarks by USAID Administrator Andrew S. Natsios - US Relief Efforts to Tsunami-Affected Countries](#)
- 01/10/05: Transcript and Video - [President Bush Thanks USAID Employees and NGO Presidents](#)
- 12/31/04: [Editorial: Responding to Asia's Tragedy, by Administrator Natsios](#) - Published in *The Washington Post*



Last Updated on: January 28, 2005



Search:

 [help](#)

[HOME](#)

[BUILD & EDIT](#)

[TOOLS](#)

[HOST](#)

[SMALL BUSINESS](#)

[MEMBER SITES](#)

[MY ACCOUNT](#)

[Tripod Home](#) > **Host**

Tripod: [Home](#) | [Site Map](#) | [About Tripod](#) | [International](#) | [Tripod Help](#) | [Report Tripod Abuse](#) | [Members](#) | [Angelfire Members](#)

» **Lycos.com** © Copyright 2005, Lycos, Inc. All Rights Reserved. Lycos® is a registered trademark of Carnegie Mellon University.

[About Lycos](#) | [Help](#) | [Jobs](#) | [Advertise](#)

Your use of this website constitutes acceptance of the Lycos **Privacy Policy** and [Terms & Conditions](#)



Search:

[help](#)

- [HOME](#)
- [BUILD & EDIT](#)
- [TOOLS](#)
- [HOST](#)
- [SMALL BUSINESS](#)
- [MEMBER SITES](#)
- [MY ACCOUNT](#)

[Tripod Home](#) > [Build & Edit](#) > **Blog Builder**

BLOG BUILDER



New & Improved Blog Builder

Now you can send entries to your Tripod Blog from your cellphone, PDA or pager! You can also start a Community Blog, upload your digital photos, video and audio clips, and much more. All for **FREE!**
[Sign up](#) today!

[Create & Edit Your Blog](#) | [What Is A Blog?](#) »

MOST RECENTLY UPDATED

- | | | |
|--|---|--|
| ▶ aqoonyahan's AQOONYAHAN | ▶ dns011605's The Band | ▶ elizabeth98907's openarmsnationalcrisiscenter |
| ▶ kpidesigns's Casting On | ▶ gottorah's Got Torah? | ▶ punksummers85's My Fabulous Life |
| ▶ caseybeadle08's grace | ▶ liarsociety's liarsociety | ▶ chickenhouse4's The Welch Family Christmas |
| ▶ dondegr0's Crossing the Red Sea | ▶ catepolacek's cate's blog | ▶ shorelinecambodia's The Team Blog - Jan. 19 - Feb. 2, 2005 |
| ▶ dondegr0's Exceedingly Precious Promises | ▶ keeponcruising's Dagar | ▶ dondegr0's Reading - Exhortation - Doctrine (1 Tim. 4:13) |

BLOG DIRECTORY

- | | | |
|-----------------------------------|----------------------------------|---------------------------------------|
| Autos | Hobbies | Relationships/Romance |
| Business | Home/Family | Sci & Tech |
| Careers/Education | Kids | Seniors |
| Entertainment | Men | Shopping |
| Finance | Miscellaneous | Software |
| Gambling | Movies/TV | Sports |
| Games | MP3/Music | Teens |
| Gay/Lesbian | Multimedia | Travel |
| Hardware | News & Media | Weather |
| Health | Online Games | Web Builder |
| | People/Society | Women |
| | Real Estate | |

Tripod: [Home](#) | [Site Map](#) | [About Tripod](#) | [International](#) | [Tripod Help](#) | [Report Tripod Abuse](#) | [Members](#) | [Angelfire Members](#)

» [Lycos.com](#) © Copyright 2005, Lycos, Inc. All Rights Reserved. Lycos® is a registered trademark of Carnegie Mellon University.

[About Lycos](#) | [Help](#) | [Jobs](#) | [Advertise](#)

Your use of this website constitutes acceptance of the Lycos **Privacy Policy** and [Terms & Conditions](#)



Search:

 [help](#)

[HOME](#)

[BUILD & EDIT](#)

[TOOLS](#)

[HOST](#)

[SMALL BUSINESS](#)

[MEMBER SITES](#)

[MY ACCOUNT](#)

Tripod: [Home](#) | [Site Map](#) | [About Tripod](#) | [International](#) | [Tripod Help](#) | [Report Tripod Abuse](#) | [Members](#) | [Angelfire Members](#)

» **Lycos.com** © Copyright 2005, Lycos, Inc. All Rights Reserved. Lycos® is a registered trademark of Carnegie Mellon University.

[About Lycos](#) | [Help](#) | [Jobs](#) | [Advertise](#)

Your use of this website constitutes acceptance of the Lycos **Privacy Policy** and [Terms & Conditions](#)

'The Original' Don't be fooled by imitations! 'All About HYDRAULIC RAM PUMPS'

[HOME](#) | [About the ATLAS RAM PUMP](#) | [About the book](#) | [Ordering Information](#) | [From the publisher....](#)

About the ATLAS RAM PUMP

The Atlas Ram Pump is the ram pump whose plans are contained within the book
'All About Hydraulic Ram Pumps--How and Where They Work'.

This is the Original Build It Yourself Plans for the Atlas Ram, the most efficient low Fall/Flow water ram available. The Author is the inventor and designer of the Atlas and has included his personal e-mail for answering questions about your ram pump project.

"There Are Imitators" but they have been around for too short a time to be able to help much, and some won't even answer questions!

This design was developed over years of personal research and experience both building Atlas Rams and installing them. Feedback from people building or using ram pumps have been included as well. My own cabin was the testing ground and any new developments have always been included in reprints of the book. This pump has provided all my water for over 15 years!

The Atlas Ram Pump as it stands today is a rugged, compact unit able to withstand 200 psi and pump water to a theoretical 230 feet of vertical lift. The materials are ALL easily obtained at plumbing or hardware stores, consisting of **galvanized iron plumbing fittings, brass check valves** and a PVC pressure tank (air dome).

The tank has an air bladder (no snifter valve!) which prevents a water-logged or air-logged condition within the pressure dome, thereby increasing the overall efficiency of the unit and decreasing the required maintenance. The air bladder is a 12" scooter inner tube, very common and easy to find.

The clack valve can be any size from 1" to 2", drive pipe as well. The clack valve is weight activated and adjustable, no spring to break, stretch or adjust. The unit is quiet--the valves seal with rubber O-rings. The unit is anchored by the sheer weight of a block of concrete molded around the base, although all working parts are easily

accessible. The installation is simple, reliable and almost maintenance-free.

There is a detailed site about the Atlas Ram Pump at All [About Atlas Ram Pumps](#)

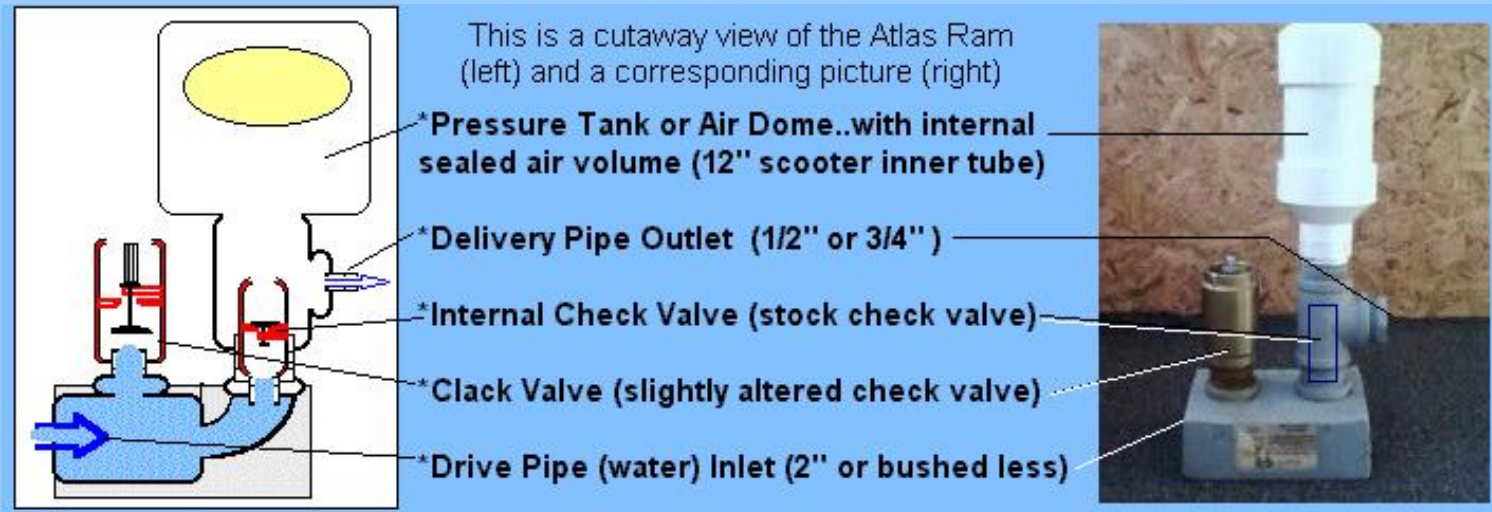

Questions about the books, ram pumps, quantity orders?
E-mail at: atlaspub@hotmail.com

©2001 Atlas Publications

The Original!

'All About HYDRAULIC RAM PUMPS'

Build your own with this book and pump water without electricity!

[HOME](#)

[About the ATLAS RAM PUMP](#) | [About the book](#) | [Ordering Information](#) | [From the publisher....](#)

ABOUT THE CONTENTS OF THE BOOK

"In Print for over 20 years!"

'ALL ABOUT HYDRAULIC RAM PUMPS How and Where They Work '

Don't be fooled by crude copies! THIS IS THE ONE YOU WANT!

The first section of the book explains in simple terms and with illustrations how the ram pump works, where it can be set up, and how to keep it working year after year with a minimum of time and energy for upkeep.

The second section gives simple step-by-step plans and detailed instructions for building a fully operational Atlas ram pump from readily available GALVANIZED and BRASS plumbing fittings. NO welding, drilling, tapping or special tools, fabrication or skills are required to put this thing together. The design has evolved to a point where low maintenance and long term reliable service is almost certain, even by a novice. Easy and fun to build, reliable and sturdy when done.

The final chapter shows how to build an inexpensive ferro-cement water storage tank of any size up to 15,000 gallon capacity. **The water storage unit is sometimes overlooked in importance.** The bigger-the-better!! It will fill eventually. Also usable...commercial plastic water tanks and (new) septic tanks.

The author and designer of the Atlas Ram has included his personal e-mail inside the book for questions from ram pump enthusiasts, as a sort of after sale service.

Try to get that from a big corporate vendor!

A great resource for self-reliant types, homesteaders, alternative energy users or anyone curious about this 'old-tech' device that has been around for so long and works so well.

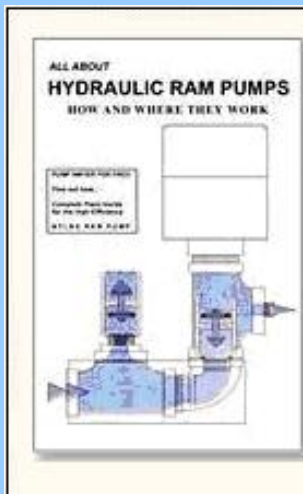

This handy little book is full of hard-to-find info about **how and where a hydraulic water ram works** and **how to build and install one.**

A ram pump will pump water from a spring or stream to a point above this source. It will even work with artesian wells and static ponds, with no other source of power needed other than falling water.

The book details how and where a ram works, but the bulk of the book contains **complete plans** for building your own fully functional rugged nationally sold **Atlas Ram Pump** from readily available galvanized plumbing fittings—for about \$60.

About the book... 'All about Hydraulic Ram Pumps' **ISBN 0-9631526-2-9.**

42 pages with illustrations and photos.

Dimensions: standard 8.5" X 5.5" format. Saddle stitch, semi-gloss pages.

3 color cover *now with 'smudge-not' clear coating.*

Price is \$9.95 + 1.00 postage US in the US. Overseas orders to amazon.com. US Orders to:

Atlas Publications, P.O. Box 265, Murphy, NC 28906

TABLE OF CONTENTS

Part 1-The Hydraulic Ram Pump

pages 1-6

About the Ram Pump

The Ram Pump Sequence

The Cistern and Drive Pipe

How Much Will A Ram Pump Pump?

Part 2-Construction and Assembly Plans

pages 7-26

About The Atlas Ram Pump

Parts List

Exploded View

construction plans follow

Part 3-Installation, Operation and Maintenance

pages 28-32

Setting Up The Atlas Ram

Startup Procedure

Troubleshooting

Overview

Part 4- Build A Ferro-Cement Water Storage Tank

pages 36-39

Additional Notes and Additions

REVIEWS from satisfied customers:

"We really enjoy the ram you helped us build. We've been enjoying the water without having to lug it uphill, for well over a year--with just our rigged improvisations of your instructions. I had heard rams were noisy, but the steady thud reminds me of a quiet heartbeat and it beats with about the same cadence. I'd hardly call that noise. Thanks again for your book and help."

Reviewer: Susan Ruth S., Millers Creek, NC.

"Great little book! I have built and bought hydraulic ram pumps. I have bought the books from England, called ram builders all over the US, and searched the net. Don Wilson's book has the clearest directions I have seen."

Reviewer: J.T. Gookin, Lander, WY

"Excellent guide for the do-it-yourself person. Not only an informative booklet on the topic of hydraulic ram water pumping, but filled with clear diagrams, part lists and sources, and thorough set-up and troubleshooting sections. Even with a minimal water flow, this pump performs! Although the price to build it in todays dollars is more than indicated, you can't go wrong with the sturdy, dependable design. I've been moving water over 1200 feet at a 100 foot rise for over 3 months, averaging 600 gallons in a 24 hour period. Highly recommended for entry into this fascinating method of pumping water without power."

Reviewer: Mark Houghton from Ephrata, Washington USA

"This is a great book! A friend of mine used this book to build a great ram pump that now pumps water up a hill that you can't even walk up!"

Reviewer: the editor of Y2Kaos.com.

"I received your book today and immediately read it from cover to cover. As a manufacturing engineer for over 30 years, I have been keenly interested in finding information on the Hydraulic Ram Pump.

I would like to thank you for your very informative book. It is well written, very well illustrated...and the best investment I have made in years!"

Reviewer: Jimmy Martin, Williamson, NY

**Questions about the book, ram pumps, quantity orders?
E-mail at: atlaspub@hotmail.com**

'The Original' (don't be fooled by imitations) All About **HYDRAULIC RAM PUMPS** How and Where They Work

[HOME](#)

[About the ATLAS RAM PUMP](#) | [About the book](#) | [Ordering Information](#) | [From the publisher....](#)

Book Ordering Information

All books are \$10.95 ppd

You may order these books (click 'from the publisher' above for more info. about these books) directly from the author/publisher by sending a check or money order for

\$10.95 ppd per book (\$3.00 postage for Canada) to :

**Atlas Publications
P.O.Box 265
Murphy, NC
28906**

Please specify which book you want. Orders are sent First Class.

Printable Order Form. Print this page (or the image alone-- 3bookorderblank2.gif), circle the book you want, and fill out the mailing label for faster service! Include \$10.95 per book, postage is included. US orders only, Overseas orders. please go to amazon.com.



All About
HYDRAULIC RAM PUMPS
How and where they work



RED CLAW!
Raising the Giant
Australian crayfish



Small Scale
CRAYFISH FARMING
for food and profit

To order any of these books, circle what you want, fill out the mailing label below, enclose \$10.95 per book, and mail to:

ATLAS PUBLICATIONS
P.O. BOX 265
MURPHY, NC 28906

I maintain a website for all three books.

There is more detailed info on these books as well as more photos and links.

[Atlas Publications](#)

There is a detailed site about the Atlas Ram

- photos and cutaway drawings -

[All About Atlas Ram Pumps](#)

Questions about the books, ram pumps, quantity orders?

E-mail: atlaspub@hotmail.com

©2001 Atlas Publications

I don't at present accept credit card payment, as that would mean raising the price of the books to cover the added fees. There are many vendors on the web who carry these books, although their prices may be higher!

The Original! "All About HYDRAULIC RAM PUMPS How and Where They Work"

[HOME](#)

[About the ATLAS RAM PUMP](#)

| [About the book](#)

| [c; Ordering Information](#)

| [From the publisher....](#)

From Atlas Publications....



Years ago, when I moved to a remote cabin in The Smokies, there was no electricity available. There was a spring nearby to get water from, but it had to be carried to the cabin. I knew this had to change, so I began to research some alternatives. This was before there were any 'alternative energy' stores or catalogs.

Eventually I found some info about 'ram pumps' which looked promising. That was many years ago and the ram I built then has gone through many changes. Feeling that there must be others with similar needs (there are!) I began to compile and draw and write. Remembering when I built the first crude improvisation of Ersa Kindel's design, there was a moment when the old light-bulb-in-the-brain went off. I got it!..saw how the ram worked. And so simple, really. Could I help others understand as well? The rest is history.

This book has been helping people with ram pumps for over 20 years, and now there are imitators....But they won't answer your questions!

This book 'The Original' All About HYDRAULIC RAM PUMPS--how and where they work contains plans for the design that evolved through trial and error. The Atlas Ram is now simpler and cheaper to build, more reliable and efficient than ever. Any new developments and user experiences are added to each reprint of the book. It just keeps getting better. A great resource for self-reliant types, homesteaders, alternative energy users or anyone curious about this 'old-tech' device that has been around for so long and works so well.



All About Hydraulic Ram Pumps How and Where They Work (ISBN 0-9631526-2-9)

The ram pump, or water ram, is a very useful 'old-tech' device that has been around for many years and is as useful today as ever. It can pump water from a flowing source of water to a point ABOVE that source with no power requirement other than the force of gravity. Invented before electric water pumps, this rugged, simple and reliable device works continuously with only 2 moving parts and very little maintenance. Typically installed at



remote home sites for domestic water supply, watering livestock, gardens, decorative lily and fish ponds, water wheels and fountains. Because it uses no power, a ram pump can be used where water would normally not be used and would flow on downstream. This book explains in simple terms and with illustrations how the ram pump works, where and how it can be set up, and how to keep it going. The second section of the book gives step-by-step plans for building a fully operational Atlas Ram Pump from readily available plumbing fittings and which require NO welding, drilling, tapping or special tools to fabricate. The final chapter shows how to build an inexpensive ferro-cement water storage tank up to 15,000 gallon capacity. The author/designer includes his personal e-mail for questions about your Atlas Ram. More about ram pumps here: [Hydraulic Ram Pumps](#)

Order book RMB, only \$9.95 plus \$1.00 First Class Shipping (U.S. funds, Canada add \$3.00).

BOOK REVIEWS

Reviewer: jtgookin@nols.edu from Lander, Wyoming: "A great little book!!! I have built and bought hydraulic ram pumps. I have bought the books from England, called ram builders all over the US, and searched the net. Don Wilson's book has the clearest directions I have seen."



From: E.J.Samson-bigbear128@juno.com Hi again. I thought I would let you know how I made out with your plans..as you can see--GREAT! I was skeptical at first & didn't see how it could work. After hooking it all up, we are pumping water 125 ft. high and over 400 ft. away..not a lot of water, but enough:



around 12 to 15 gallons an hour!

Thanks again! Sincerely, Ernie Samson.

Reviewer: Jimmy Martin, Williamson, NY: "I received your book today and immediately read it from cover to cover. As a manufacturing engineer for over 30 years, I have been keenly interested in finding information on the Hydraulic Ram Pump. I would like to thank you for your very informative book. It is well written, very well illustrated...and the best investment I have made in years!"

MORE BOOKS FROM ATLAS PUBLICATIONS



Small Scale Crayfish Farming for food and profit
(ISBN 0-9631526-1-0)

This useful book--a bare bones, how to manual--explores how to raise crayfish in a small country setting. It is a surprisingly complete (for its size) factual compilation of years of University and industry research as well as individual findings on the culture of freshwater crayfish. It is well known that farmed crayfish will grow to a much larger size than the wild

ones, and much more rapidly, if given optimum conditions. These conditions are easily reached, and are much less strict than most aquaculture species. Prepared in a number of tasty ways, freshwater crayfish are highly regarded as a delicacy both here and abroad. They are similar to lobster and shrimp in taste and texture, and are an excellent source of high quality, low-fat protein. Targeting the small farmer or backyard hobbyist, this book outlines specific guidelines for pond construction and efficiency, food and environmental needs, tank culture, egg & juvenile production for stocking, processing & sale...of the best species of freshwater crayfish for aquaculture in all areas of the US. More about crayfish farming here: [Crayfish Farming](#)



Order book CRB; only \$9.95 plus \$1.00 First Class Shipping. (U.S. funds, Canada add \$3.00)



Two of the most popular varieties for culture. Both grow to over 1 oz. in weight **in one growing season**, under ideal conditions of temp,



eration, density, turbidity and feeding!

from 'BACKWOODS HOME MAGAZINE' by Dave Duffy, editor: "This is a small but useful book..a bare bones 'how-to' manual on how to raise crayfish in a small country setting. Wilson is a clear, informative writer, and this book is in that vein..short and to the point. No fluff. I like it a lot."

From 'WHOLE EARTH REVIEW' by Kevin Kelly, editor: "Crayfish look and taste like small lobsters, but can be grown in a back lot pond. They can be raised anywhere in the 48 states, and thrive on almost any kind of feed. They require only a shallow pool of fresh water, are self-replenishing and easily caught. There is backyard gourmet protein for homesteaders here. This self-published how-to booklet will guide your crustacean dreams."



RED CLAW! Raising the Giant Australian Crayfish (ISBN 0-9631526-3-7).

The Red Claw crayfish is a new and very promising aquaculture species. The Red Claw is very similar to the native American species, except that it grows to a HUGE size--almost to that of a lobster! There are several other notable differences, such as year-round breeding, awesome fecundity... often over 700 eggs per breeder! They also have a non-aggressive nature, which allows many more Red Claw crayfish to live happily in a given space than would the native American crayfish.



This book is one of the few sources for complete information on all aspects of the culture of this lobster sized freshwater crayfish. Compiled from leading edge research direct from Australia as well as individual and University findings from all over the U.S., this book **dispels the hype and furnishes the facts** about this little known but highly prized new aquaculture species. Fish farmers have managed to become major players in this bottomless market in only a couple of years. Small scale family run operations are harvesting 'short lobsters' in less than a year, and the startup costs are relatively low. There are not many Red Claw crayfish reference books, and this book packs all the info you may need into a small price. Included in the book are photos from down under, food and feeding regimens needed to raise the Red Claw to giant size, well managed pond and tank factors, hatching and juvenile production, stocking methods, sources of supply (Spiny Fins Hatchery- Sfins1248@aol.com); processing and sale tips, and marketing recommendations.

More about the Red Claw here: [Red Claw Crayfish Farming](#)

Order book AUC only \$9.95 plus \$1.00 First Class Shipping (U.S. funds).

From 'AQUACULTURE MAGAZINE' by James W. Avault Jr., book review editor:

"This book is compiled from information from David O'Sullivan of the University of Tasmania, David Rouse of Auburn University, and several private companies growing Red Claw in America and Australia. It is developed as a manual for the crayfish farmer. It covers all of the important topics a beginning farmer would need to know. This book is easy to read and should be a help to anyone who wants a book of Red Claw aquaculture in a condensed version. David O'Sullivan and David Rouse are highly respected researchers of Red Claw."

Reviewer: Charles Showalter (charles@redclaw.com) from Pittsburgh, Penn. "First off, I would like to thank the author for writing this book on Red Claw Culture and especially for including the section on information resources. The book was able to bring a lot of great information together, and presented it in a manner that made the average 'water farmer' comfortable with Red Claw production. This must not have been an easy task, considering the lack of available information. After reading the book I decided to dig deeper and became excited with the possibilities. The book was correct in stating that this industry is in it's infancy and quite likely will grow fast. I now operate the Red Claw Crayfish Hatchery in Pittsburgh and have a very successful web site. And this book got me started!"

**To place an order for any of these books,
send check or MO for \$10.95 US per book (\$12.95 Canada) to:
(please indicate which book)**

Atlas Publications
P.O. Box 265
Murphy, N.C. 28906

Or use this handy [PRINTABLE ORDER FORM](#)

There is detailed info about these books as well as useful links at:
[Homestead Books](#)

Questions about the books, ram pumps, book quantity orders?
E-mail at: atlaspub@hotmail.com

©2001 Atlas Publications

Access Denied

Boeing has instituted temporary additional virus filtering on our inbound forward proxy servers.

- The Web Forward Proxy service is blocking in accord with: [Protecting Against Malicious Code policy](#)
- If this filtering has affected *business related data* that you are sure is not infected with a virus, you can contact the customer help center at 425-234-0911 for assistance.

GET A FREE WEBSITE! LOGIN

Get a
FREE
website!
[Click Here!](#)

NETZERO
High-Speed Internet
Dial-Up \$14.95
Internet Service \$9.95

 [Search the Web](#)

Popular Searches: [dvd](#) [airfare](#) [music](#)

All About Hydraulic Ram Pumps How and Where They Work (ISBN 0-9631526-2-9)

The ram pump will pump water from a flowing source of water to a point above that source with no other power required. A full description of how to build and install one is contained in this book

[Home](#) [Hydraulic Ram Pumps](#) [Atlas Ram Parts](#) [Crayfish Farming](#) [Red Claw Crayfish Farming](#)



WHAT IS A RAM PUMP?

The hydraulic ram pump is a reliable, old-time water pump that works just as well today as ever. **Ongoing research indicates the Great Pyramid may actually have been a gigantic ram pump..built to pump drinking water to public water fountains in the cities above the Nile flood plain! ([Pyramid Pump](#))** Often called a water ram, one of these simple devices can **pump water from a flowing source of water (spring, creek, river, etc.) to any point above the source, and this without any power requirement except the force of water moving downhill**, contained inside a 'drive pipe'. This rugged and dependable device is typically installed today at remote home sites and cabins that are off the power grid and would otherwise be without a water supply. Sometimes a ram is used as a backup water system, or for watering livestock, gardens, decorative lily ponds, water wheels or fountains. Simply because a ram uses no power opens up a world of possibilities for using water that would otherwise flow on downstream,wasted. All that is really required is the surface water source. The water has to be moving...not much, but some. The creek need not be large either - 4 gallons per minute is the minimum.

TYPICAL RAM PUMP SETUP

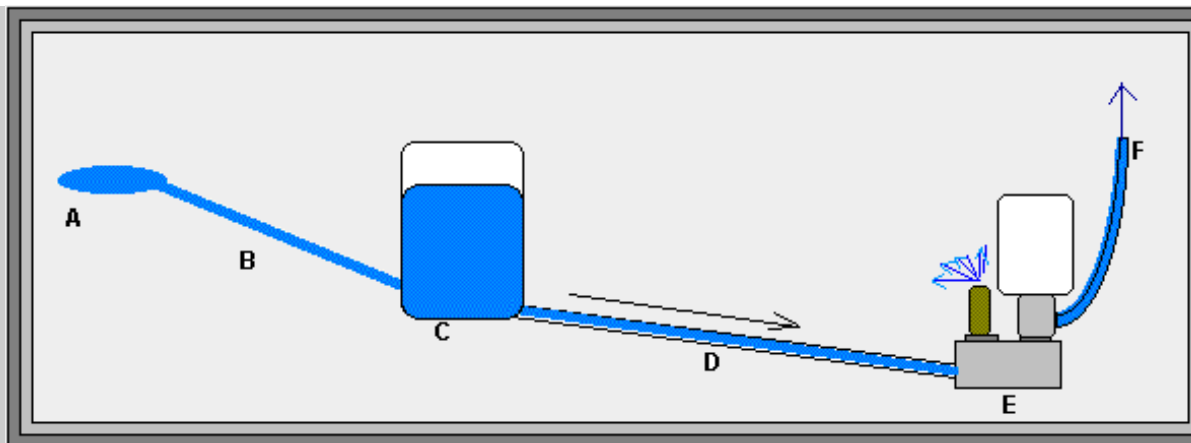

(A) Water source; can be a river, stream, spring, or pond.

(B) Supply pipe. Goes from the source to the collection barrel downstream (below the source).

(C) Collection barrel or intake barrel. The water is collected here. Water level stays at the level of the source.

(D) Drive pipe. About 100 ft. long; brings the water to the pump and provides the power to the pump, somewhat like a battering ram. Probably the least understood and most important part of the ram pump system. Typically black plastic pipe, 1" to 2" dia., generally matched to the size of the clack valve on the pump.

(E) Ram Pump. Starts and stops the movement of the water column in the drive pipe through the clack valve (gold colored). Also redirects a portion of the water (10%-15%) to the pressure tank through the internal check valve or one-way valve. This portion leaves the pump and rises to the end use area through the...

(F) Delivery pipe which goes to the storage tank, garden, house...wherever the water is needed. Typically of 1/2" or 3/4" black plastic pipe.

ATLAS RAM PUMP CUTAWAY

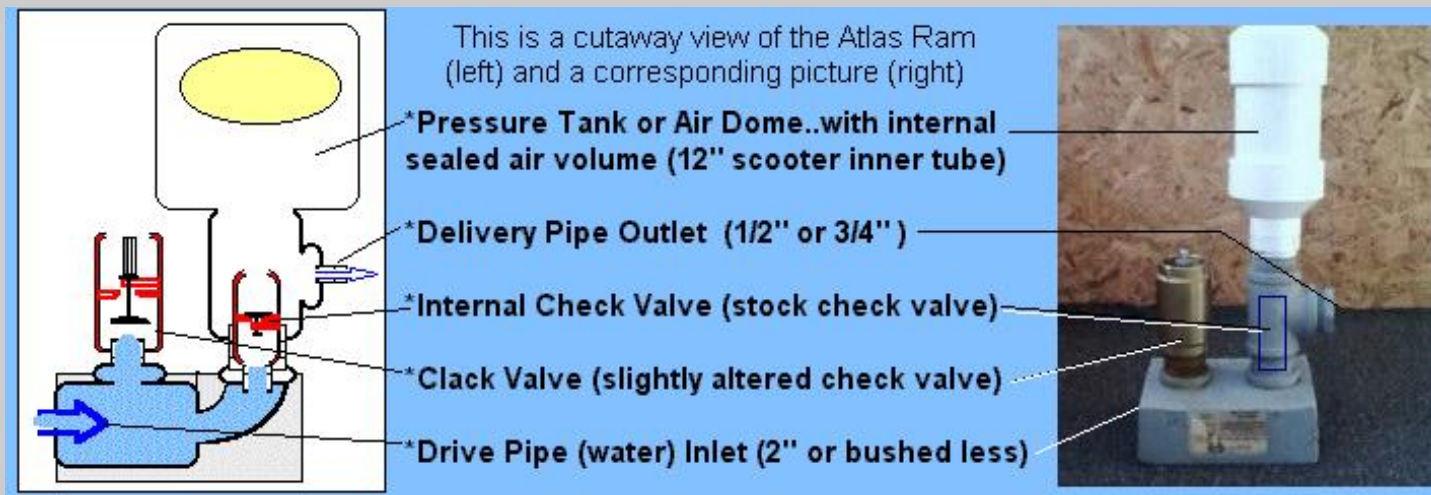

ABOUT THE ATLAS RAM PUMP



The Atlas Ram Pump is the simplest and most efficient low flow / fall ram pump available today. Designed to be simple to build-- with NO drilling, tapping or welding involved in its construction; the materials and fittings are readily available at most hardware stores. (LEFT) The Atlas Ram Pump...water enters from the right through the drive pipe, delivery out the left. 'Waste' water out the clack valve (brass). (RIGHT) The Atlas Ram is compact, rugged and easily carried.



(LEFT) The 'air dome' or 'pressure tank' removes easily to access the 'sealed air volume'. The air dome is of heavy-duty 220 psi PVC well-casing.



(RIGHT) The sealed air volume, in this case a 12" scooter inner tube, eliminates the possibility of an air-logged or water-logged condition inside the air dome. This promotes the overall reliability and efficiency of the Atlas ram pump.



(LEFT) The tank-mount 'tee' fitting removes easily to access the check valve. This is rarely if ever needed, unless to remove debris if the intake screen is breached.

(RIGHT) The clack valve removes easily for checking or maintenance, very rarely needed also.



Click here for more on [Atlas Ram Pump Construction](#)

ABOUT THE BOOK

42 pages with illustrations and photos.



This book explains in simple terms and with illustrations how and where the ram pump works, how it can be set up, and how to keep it working year after year with a minimum of time and energy.

The second section of the book gives step-by-step plans for building a fully operational Atlas Ram Pump from readily available plumbing fittings, with NO welding, drilling, tapping or special tools needed. The design has evolved to a point where low maintenance and long term reliable service is almost certain, even by a novice.

The final chapter shows how to build an inexpensive ferro-cement water storage tank up to 15,000 gallon capacity.

FROM THE AUTHOR & PUBLISHER... Years ago, when I moved to a remote cabin in The Smokies, there was no electricity available. There was a spring nearby, to get water from, but it had to be carried to the cabin. I knew this had to change, so I began to research some alternatives.

Eventually I found some info about 'ram pumps' which looked promising.

That was many years ago and the ram I built then has gone through many changes. Feeling that there must be others with similar needs (there are!) I began to compile and draw and write. The book 'All About HYDRAULIC RAM PUMPS How and Where They Work' is the result. It contains plans for a design that has evolved through trial and error. The Atlas Ram is now simpler and cheaper to build, more reliable and efficient than ever. Any new developments and user experiences are added to each reprint of the book. It just keeps getting better! A great resource for self-reliant types, homesteaders, alternative energy users or anyone curious about this 'old-tech' device that has been around for so long and works so well.

Read below what some people have said about this book...



"Don, This is a picture of the ram I made from your book. Made it for my daughter and son-in-laws place at Scaly Mountain, N.C. Haven't installed it yet, but I'll be moving up there soon and we will get it going then. I'll let you know how it works. Thanks for a real fun project." Walt LeRoy, Darien, GA.

As can be seen from the picture to the right, Walt has mounted his ram on an anchoring base of steel. The corner spikes are meant to be driven into the creek bed, anchoring the unit quite nicely. An excellent innovation, which also makes the concrete base unnecessary. Mr. LeRoy is in his 80's.

"Great little book! I have built and bought hydraulic ram pumps. I have bought the books from England, called ram builders all over the US, and searched the net. Don Wilson's book has the clearest directions I have seen." Reviewer: jtgookin@nols.edu from Lander, WY

"I received your book today and immediately read it from cover to cover. As a manufacturing engineer for over 30 years, I have been keenly interested in finding information on the Hydraulic Ram Pump. I would like to thank you for your very informative book. It is well written, very well illustrated..and the best investment I have made in years!" Reviewer :Jim Martin, Williamson, NY

"We really enjoy the ram you helped us build. Thanks for just knowing we could call if we got snagged. We've been enjoying our water without having to lug it uphill...for well over a year, with just our rigged improvisations of your instructions. I had heard rams were noisy, but the steady thud reminds me of a quiet heartbeat and it beats with about the same cadence. I'd hardly call THAT noise. Thanks again for your book and help." Reviewer: Sue Story, Millers Creek, NC

[Home](#) [Hydraulic Ram Pumps](#) [Atlas Ram Parts](#) [Crayfish Farming](#) [Red Claw Crayfish Farming](#)

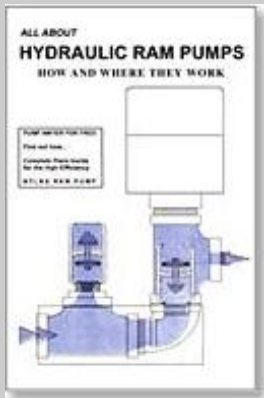

To place an order for this book,
send check or MO for \$10.95 per book to:

(please indicate which book)

Atlas Publications
P.O. Box 265
Murphy, N.C. 28906



OR use this handy [PRINTABLE ORDER FORM](#)

©2001 Atlas Publications
[E-mail author / publisher.](#)

Get a
FREE
website!
[Click Here!](#)

NETZERO
High-Speed Internet
Dial-Up \$14.95
Internet Service \$9.95

 [Search the Web](#)

Popular Searches: [dvd](#) [airfare](#) [music](#)

Small Scale CRAYFISH FARMING for food and profit (ISBN 0-9631526-1-0)

Freshwater crayfish are highly regarded as a delicacy as they are very similar to shrimp or lobster in taste and texture...high protein and low-fat.

[Home](#) [Hydraulic Ram Pumps](#) [Crayfish Farming](#) [Red Claw Crayfish Farming](#)



The crayfish is a very promising aquaculture species.

This book is one of the few sources for complete information on all aspects of the culture of large-sized freshwater crayfish. Compiled from leading-edge research direct from University and individual findings all over the U.S., this book dispels the hype and furnishes the facts about this well known and highly prized aquaculture species. Fish farmers have become major players in this bottomless market in only a couple of years. Small scale family run operations are harvesting 'short lobsters' in less than a year, and the start-up costs are low. Included in the book are photos, food and feeding regimens needed to raise crayfish to giant size, well managed pond factors, hatching and juvenile production, stocking methods, sources of supply [Crayfish Suppliers](#), sale & processing tips, and marketing recommendations. This book is easy to read, well organized, and packed with hard to find information. Targets the small farmer or homesteader.



Look at the huge crawfish to the right. That's a 5 gal. bucket they're in! How did they get so big? The answer is simple...ideal growing conditions. These are a common variety of crayfish found all over the U.S. except the South where summers are too hot for them. Given the right conditions, they can attain this size (and larger!) in a single season. After the first year, crayfish are 'self-stocking', meaning they propagate naturally if allowed to. It is more efficient to raise the young in tanks (giving a 98% survival rate), but that requires a little more effort. Careful harvesting can produce ever-larger specimens if the largest crayfish are returned to the pond to reproduce.

The best production is obtained with a combination of natural and processed feeds. Natural sources include hay, grass and other vegetation. Processed feeds include range pellets, dog food, sinking fish food, and of course crayfish feed. Stock can be obtained from existing crayfish farms as juveniles or adults, or one can capture a local variety of crawdad quite easily.



(left) This is a somewhat rare variety of crayfish (*Pacifasticus*), found in Pacific Northwest streams and lakes. It grows much larger than other varieties in the U.S.; unfortunately it takes 18 months or so to mature and breed. This makes it not too well suited for culture..except in that region.



Sometimes called a 'short lobster', this variety can be raised indoors in tanks. These can be relatively easy and inexpensive to establish and manage. Using tanks can create an extended growing season, necessary in colder climates. Other benefits of tank culture include..controlled environmental factors (turbidity, temperature, waste management), safety from predators, and controlled feed intake--all of which produce maximum growth rate, highly efficient reproduction rates, and the highest possible weight at harvest. Simple selective breeding can increase the size and disease resistance of successive generations, as in the now famous 'Super Shrimp' of Mexico.

There are over 300 species of freshwater crayfish in the U.S.A...all sizes, colors, temperments. There are several varieties that thrive in almost every environmental niche. Some are better suited for farming than others, and there is a suitable species for almost any climate in the U.S.

BOOK REVIEWS:

Reviewer: A reader from Paintsville, KY: "This is an excellent source of information for people who want to start a crayfish farming business. It covers all aspects, including pond and tank culture, sexing, feeding requirements, and sources for crayfish".

from 'BACKWOODS HOME MAGAZINE' by Dave Duffy, editor: "This is a small but useful book..a bare bones 'how-to' manual on how to raise crayfish in a small country setting. Wilson is a clear, informative writer, and this book is in that vein..short and to the point. No fluff. I like it a lot."

Reviewer: Terri Primavera: "Both this book and the Red Claw book were great! I stayed up really late perusing them last night. I'm hoping to visit a couple of local farms in the near future in the hopes to learn more about starting my own crayfish farm."

from 'AQUACULTURE MAGAZINE' by James W. Avault, book review editor & former editor of the Journal of World Mariculture: "This 45 page book is broken down into two sections, easy to read, well organized..and packed with information."

[Home](#) [Hydraulic Ram Pumps](#) [Crayfish Farming](#) [Red Claw Crayfish Farming](#)



**To place an order for this book,
send check or MO for \$10.95 per book to:**

(please indicate which book)

**Atlas Publications
P.O. Box 265
Murphy, N.C. 28906**



OR use this handy [PRINTABLE ORDER FORM](#)

©2001 Atlas Publications
[E-mail author / publisher.](#)

GET A FREE WEBSITE! LOGIN

Get a
FREE
website!
[Click Here!](#)

NETZERO
High-Speed Internet
Dial-Up \$14.95
Internet Service \$9.95

 [Search the Web](#)

Popular Searches: [dvd](#) [airfare](#) [music](#)

Red Claw! Raising the Giant Australian Freshwater Crayfish (ISBN 0-9631526-3-7)

The Red Claw crayfish is very similar to the native American crayfish, except that it grows to a HUGE size--almost to the size of a lobster!

[Home](#) [Ram Pumps](#) [Crayfish Farming](#) [Red Claw Crayfish Farming](#) [FEATURED RED CLAW FARM](#)

RED CLAW!

Raising the Giant Australian Freshwater Crayfish

The Red Claw crayfish is a new and very promising aquaculture species. This book is one of the few sources for complete information on all aspects of the culture of this lobster-sized freshwater crayfish. Compiled from leading-edge research direct from Australia as well as individual findings all over the U.S., this book dispels the hype and furnishes the facts about this little known but highly prized aquaculture species. Fish farmers have managed to become major players in this bottomless market in only a couple of years. Small scale family run operations are harvesting short lobsters in less than a year and the start-up costs are low, the reproduction rate is high and the profit is great!



From Fish Farming International- "The production of freshwater crayfish native to Australia, especially in closed systems, makes for ideal local development projects in rural communities", says Dr. Theo Ratte, an experienced international fisheries and aquaculture scientist. "Closed systems, with all the benefits they offer, can be relatively easily and inexpensively established and managed. Some benefits include safety from predators, controlled feed intake, controlled environmental factors-(turbidity, temperature, waste management) all of which produce maximum growth rate, highly efficient reproduction rates, and the highest possible weight at harvest. Simple selective breeding can increase the size and disease resistance of successive generations, as in the now famous 'Super Shrimp' of Mexico".





The redclaw is a valued aquarium species with their exotic coloration. They are not aggressive, and they reproduce rapidly and easily.

Why red claw crayfish?

The redclaw crayfish species possess qualities which make it particularly well suited for intensive aquaculture. Redclaw reproduce rapidly and grow to market size in less than a year. The meat is arguably more healthy than traditional seafood products as it is low in fat, cholesterol and salt. The species is economical to produce, is lobster-like in

appearance and compares favorably in both flavor and quality with other marine crustaceans. Redclaw are often described as having a similar flesh texture and flavor to that of a lobster. Local demand for redclaw is strong with as little as 4% being exported. Significant export potential has been identified for future production expansion.



The redclaw reproduces rapidly and easily for commercial hatcheries or farming.

Each female can produce from 500 to 1400 young each breeding cycle, depending on her size. Breeding takes place year round with proper water temperature, quality and simple feeding regimens.

There are plenty of established redclaw hatcheries and farmers offering stock and supplies for redclaw and other crayfish stock. We have a list of suppliers at this page--[Redclaw and Crayfish Suppliers](#). This page is set up to be 'printer-friendly', you can easily print this page on a single sheet, or simply

view it. Just click the blue lettering link. Updated regularly.



['Stick-Fins' Featured Red Claw Farm](#)



From Stick-Fins Fish Farm, Florida.

Here is a young Red Claw breeder. You can see the color & size of the crawfish, and the large number of eggs.



BOOK REVIEW

From 'SMALL FARM TODAY' by Ron Macher, editor: "Both of these booklets ('Small Scale Crayfish Farming' and 'Red Claw! Raising the Giant Australian Freshwater Crayfish') offer inexpensive, detailed information on the possibilities of raising crayfish for food and profit on a small acreage. There are not many crayfish reference books, and these two small books pack all the information you will need into a tiny price."

[Home](#) [Ram Pumps](#) [Crayfish Farming](#) [Red Claw Crayfish Farming](#) [FEATURED RED CLAW FARM](#)



**To place an order for this book,
send check or MO for \$10.95 per book to:**

(please indicate which book)

**Atlas Publications
P.O. Box 265
Murphy, N.C. 28906**



OR use this handy [PRINTABLE ORDER FORM](#)

**©2001 Atlas Publications
[E-mail author / publisher.](#)**

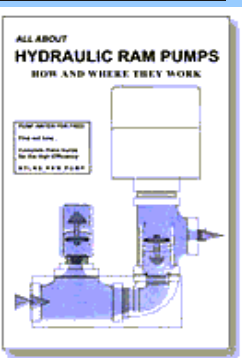

Atlas Publications offers several unique and inexpensive publications for the homesteader or anyone who may be interested in raising freshwater crayfish or Giant Australian crayfish (Freshwater Lobsters) for food and profit, as well as persons wanting info on Hydraulic Ram Pumps and / or how to build and install a simple, rugged and efficient Atlas Ram Pump and 'Pump Water For Free!' .

The books below are available direct from the author / publisher Atlas Publications.

Small Scale Crayfish Farming for food and profit
(ISBN 0-9631526-1-0)

This useful book--a bare bones, how to manual--explores how to raise crayfish in a small country setting. It is a surprisingly complete (for its size) and factual compilation of years of University and industry research as well as individual findings on the culture of freshwater crayfish. Prepared in a number of tasty ways, freshwater crayfish are highly regarded as a delicacy both here and abroad. They are similar to lobster and shrimp in taste and texture, and are an excellent source of high quality, low-fat protein.

Targeting the small farmer or backyard hobbyist, this book outlines specific guidelines for pond construction and efficiency, food and environmental needs, tank culture, processing and sale, of the best species of crayfish for aquaculture in all areas.

More about American Crayfish Farming: [click here](#)

Order book CRB, only \$10.95 ppd. Canada add \$3.00 (U.S. funds).



RED CLAW! Raising the Giant Australian Freshwater Crayfish **(ISBN 0-9631526-3-7).**

The Red Claw crayfish is a new and very promising aquaculture species. This book is one of the few sources for complete information on all aspects of the culture of this **lobster sized** freshwater crayfish. Compiled from leading edge research direct from Australia as well as individual and University findings from all over the U.S., this book **dispels the hype** and **furnishes the facts** about this little known but highly prized new aquaculture species. Fish farmers have managed to become major players in this bottomless market in only a couple of years. Small scale family run operations are harvesting 'short lobsters' in less than a year and the startup costs are relatively low.

Included in the book are photos from down-under, food and feeding regimens needed to raise the Redclaw to giant size, well managed pond and tank factors, hatching and juvenile production, stocking methods, sources of supply ([Red Claw Suppliers](#)), processing & sales tips, and marketing tips.

More about Red Claw Farming: [click here](#)

Order book AUC, only \$10.95 ppd. Canada add \$3.00 (U.S. funds).

All About Hydraulic Ram Pumps - How and Where They Work **(ISBN 0-9631526-2-9)**

The ram pump, or water ram, is a very useful 'old-tech' device that has been around for many years and is as useful today as ever. It can pump water from a flowing source of water to a point ABOVE that source with no power requirement other than the force of gravity. Invented before electric water pumps, this rugged, simple and reliable device works continuously with only 2 moving parts and very little maintenance. Typically installed at remote homesites for domestic water supply, watering livestock, gardens, decorative lily and fish ponds, water wheels and fountains. Because it uses no power, a ram pump can be used where water would normally not be used and would flow on downstream.

This book explains in simple terms and with illustrations how the ram pump works, where and how it can be set up, and how to keep it going. The second section of the

book gives step-by-step **plans** for building a fully operational Atlas Ram Pump from **readily available** plumbing fittings and which require NO welding, drilling, tapping or special tools to fabricate.

The final chapter shows how to build an inexpensive ferro-cement water storage tank up to 15,000 gallon capacity.

Order book RMB, only \$10.95 ppd. Canada add \$3.00 (U.S. funds).



**To place an order, send
check or MO to:**

**Atlas Publications
P.O. Box 265
Murphy, NC
28906**



Click on the book to
find out more about
ram pumps and this
book (authors site).

Click the book to find
out more about this
book and Red Claw.

Click on the book to
find out more about
this book and
small scale
Crayfish Farming

ATLAS PUBLICATIONS

How-to books for the self-reliant

OR: Use this handy
[PRINTABLE ORDER FORM](#)

Questions about the books or their content, ordering or quantity orders? Please feel free to...

For details on the Atlas Ram Pump (photos & drawings)
[CLICK HERE](#)



Stick-Fins Fish Farm
Redclaw Crayfish production facility.
click the picture to go there

[E-mail Me](#)



[get your own web site!](#)
[try it FREE for 30 days](#)

this site built with
homestead
your web site company

HELP WITH ADOBE ACROBAT READER

Adobe Acrobat Reader is a great way to download large, complex documents such as our catalog, IF it is set up right. However, for some inexplicable reason, it does not come set up right! If your computer locks up when you try to download, you either don't have Acrobat Reader or it needs adjusting. Don't worry, it's easy to fix.

Why use Acrobat? What is a "PDF"? When we prepare our [auction catalog](#) for the print shop, we end up with a file that would take four days to download! With Adobe Acrobat, we can convert that to a version that looks great on the screen and downloads in less than 15 minutes! The advantage of this "Portable Document File" becomes clear.

Do you have the Acrobat Reader? If you don't find it in your program directory and don't see the logo



on your desktop, you probably don't. If you click the "get reader" logo below, it should link you directly to the Adobe download page where you can get your free copy. Just answer a few questions and choose the right version for your machine. This is a big download, so it takes a while. (Netscape offers a free "smart download" program that's great with long downloads if you have problems with dropping the phone connection.) After you have it on your hard drive, click it or follow Adobe's directions to install. After it is installed, you can make your adjustments. If you have Version 4, there is no advantage in upgrading to Version 5.

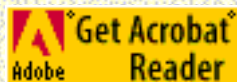

We now need to disable "web integration." Follow these steps if you are a PC user. Mac users will find the procedure to be similar, but different.

If you have Acrobat 5, open the program, click EDIT, PREFERENCES and OPTIONS. Unclick all four web browser options and gracefully make your way out of the program. That's it!

If you have Acrobat 4, open the program, click FILE, PREFERENCES and GENERAL. Unclick "Allow Background Downloading" and "Web Browser Integration." Click OK and exit the program. Things should work fine, now.

[HOME](#)

[RAMS](#)

[Skip navigation](#)

Products Solutions Support Purchase Company

🔍 Search Contact Us

Adobe Reader

Download Adobe Reader

Thank you for your interest in [Adobe® Reader® 7.0](#) — free software that lets you view, print, search, and share [Adobe Portable Document Format](#) (PDF) files more securely using a variety of platforms and devices. Commenting tools enabled by Adobe Acrobat® 7.0 Professional software let you actively participate in document reviews. Adobe Reader 7.0 features a faster launch time and real-time zooming and panning.

Linux Beta: Thank you for your interest in the pre-release program for Adobe Reader 7.0 for Linux. Due to the overwhelming response received from customers, we have closed the pre-release program. To download released versions of Adobe Reader for different platforms, please follow Step 1 below to select your platform, language and connection speed.

IMPORTANT: Please review the [system requirements](#) before downloading and installing Adobe Reader 7.0.

To distribute Adobe Reader software or place an "Includes Adobe Reader" logo on your Web site or printed material, [see details](#).

Step 1 of 2

Choose your language and platform. Your selection will determine the version of software that you will download.

Language

Platform

Step 2 of 2

The platform and language combination specified will determine the version of Adobe Reader that you will receive.

Full version: You will receive the full-featured version of Adobe Reader software. Recommended for broadband users.

Basic version: You will receive a compact version of Adobe Reader software without all available options. This version will transfer more quickly over dial-up connections.

By downloading software from the Adobe Web site, you agree to the terms of our license agreements. Please read the following license agreements before downloading:

[Adobe Reader license agreement](#)

An accessible, [text-only Adobe Reader download page](#) is available if you are using a screen reader. [An Adobe Reader archive page](#) enables you to find and download an earlier version of Adobe Reader.

Copyright © 2005 Adobe Systems Incorporated. All rights reserved.

- [Terms of Use](#)
- [Online Privacy Policy](#)
- [Accessibility](#)
- [Preventing software piracy](#)

- [Permissions and trademarks](#)
- [Product license agreements](#)





Things that Work! The Folk Ram Pump



Things that Work!
tested by *Home Power*

Michael Welch

©1994 Michael Welch

Tested by Michael Welch, Cara Smith and classmates of Humboldt State University's International Development Program (Susan Brinton, Christopher Herbst, Christine Parra, David Potter, Jon Raybourn, Dav Camras, Daniel Oros, Mike Orr, and Wallapa Wongsuwan).

The Site

Cara Smith of Fieldbrook, California had a problem. Every year in August, her spring flow reduces to a mere trickle. As the Northern California drought got worse year after year, so did her spring's ability to supply her household needs. She needed a permanent solution to her problem.

Fortunately, a nice creek crosses Cara's property, and it flows year round. But, it is 360 feet in elevation below

her water storage tank, which gravity feeds to her home. I had been looking for a site to adequately test the Folk ram pump, and this seemed like it would work. I had been attempting to test the pump on my own system at my home. While it worked well enough for me, my flow was too small to really put the pump through its paces.

So what is a ram pump anyway? Ram pumps use a downhill water pressure to pump a portion of that water even higher uphill to a holding tank. No other source of power is needed.

We enlisted the help of HSU's International Development Program to design, build and test the ram pump system. But that's a story in and of itself that we may tell in a future *HP* article. For now, suffice it to say that this academic program prepares students to help third world countries with their development requirements, and strongly emphasizes appropriate technology to meet these countries' needs.

The Pump Arrives

When I received the Folk ram, I was surprised to see that it was in pieces. Normally, Jim Folk ships his pumps completely assembled, ready to install. But, Jim knew that I was very interested in the workings of his pumps, so he sent it to me disassembled, with a labeling tag on each component explaining the why's and the how's of its design and use. I really appreciated that, but any other customer can expect the pump to arrive well-packed and already assembled.

His largest pump, however, is too heavy to ship by UPS, so it comes in two pieces easily bolted together.

This pump is heavy-duty. Its body is thickly cast and machined from high-grade aluminum alloy, and the inner components and the bolts make use of stainless steel. The internal "valves" are made of thick, bonded rubber seals.

A feature of the Folk ram not found in most ram pumps is a strong rubber diaphragm which separates the delivery water from the pressurized air chamber. This diaphragm keeps the air from mixing and exiting with the delivery water, thus eliminating the need for a "snifter valve" to replenish the air chamber.

Other features of the Folk ram pump include larger-than-usual impetus and check valves for faster reaction time and a large air dome to minimize delivery water pressure pulsations and thus decrease friction loss. The impetus valve stroke length is easily adjustable to change the frequency of pump cycles, which changes the amount of water the pump uses and delivers.

Installation

The Folk ram arrived with adequate instructions on how to install, maintain and run it, but there is some room for improvement. Jim Folk told me that he wanted to do a better and more detailed manual for the pump.

One great thing about Jim Folk is that it is as important to him that the pump works well as it is to sell the pump in the first place. If you have problems with your installation or operation, he will work with you in detail. It's just how he is, and most people can really appreciate it. For example, there was a problem with the bonded rubber the pumps used in their valves. When Jim discovered the defect, he automatically sent every pump owner a new set of valves, using improved materials, and he did it free of charge.

Long distance water pumping systems have so many variables that every installation is different. In our case, the terrain was very steep and somewhat rugged. In order to get adequate vertical drop to run the pump, we had to snake the supply pipe 420 horizontal feet from the source to a settling tank, and then go steeply down the hillside to the pump site with the drive pipe. The cost of having to run such a long horizontal distance was a reduced supply available to the pump. While Cara's creek flows at about 72,000 gallons per day, our 420 feet long, two inch diameter supply pipe with five feet of head between the creek inlet and the settling tank would make 5,400 gallons per day available to the pump.

Most installations will be more straightforward than ours, and less expensive as a result. The price of the

Cara's Water Delivery System

Settling Tank to Storage Tank
(not to scale)

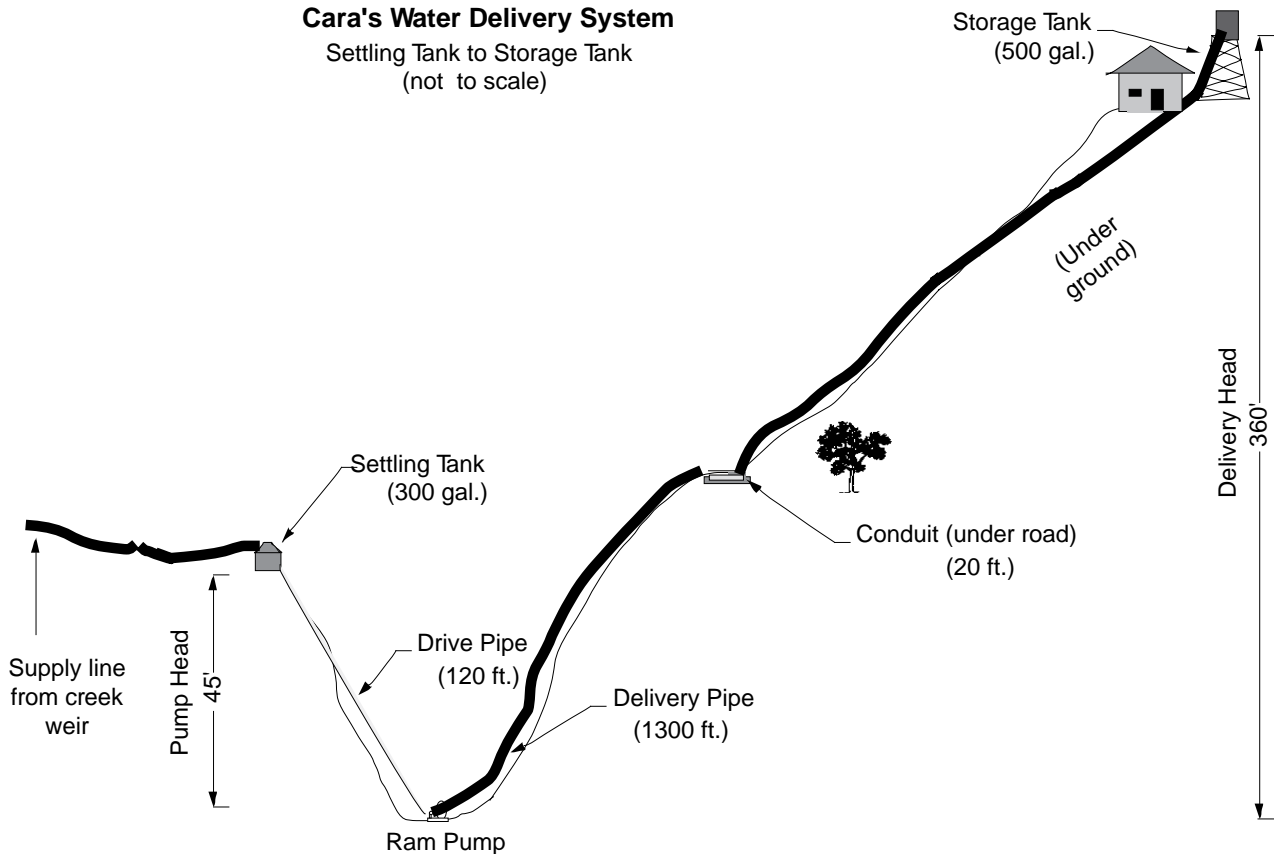

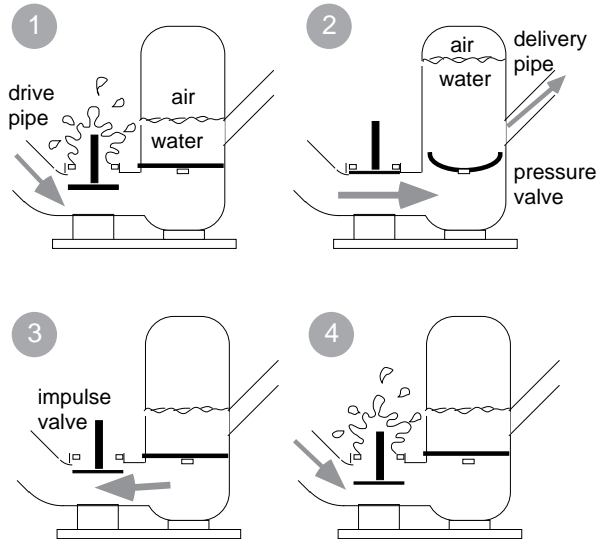

How a Ram Pump Works

All ram pumps work on the principle of momentum which is controlled by a cycle set up by the interaction of two valves in the pump.

When the impetus valve is opened (this must initially be done by hand to start the pump cycling), water begins to flow down the drive pipe and through the impetus valve as in Figure 1. When the drive water reaches a certain velocity, water friction slams shut the impetus valve as in Figure 2. The momentum of the water carries past the closed impetus valve, forcing open the flapper valve and pushing water past it to pressurize the air chamber above the water level. In Figure 3, the water pressure above the flapper valve overcomes the spent momentum below it, forcing the flapper closed again. The water that made it past the flapper in Figure 2 is then forced by the extra air pressure up the delivery pipe. Since the momentum of the water coming down the drive pipe was stopped, the impetus valve falls open, allowing the water to flow down the drive pipe again as in Figure 4 (just like Figure 1), starting the cycle over again.

This process occurs over and over again until something happens to stop the cycle. Ram pumps can cycle anywhere from 25 to 300 times per minute. The frequency of the cycle is adjustable by changing the length of the stroke of the impetus valve. A longer stroke produces a lower frequency. This means more of the supply flows to and through the pump and more is pumped up the delivery pipe.

The stroke is adjusted to restrict the amount of water used to the amount available, or if supply is unlimited, to regulate the amount delivered to match the amount needed.

pump remains a fixed cost for everyone, but the installation costs can vary widely. Because of the long supply line and the uncommonly high delivery elevation, Cara's installation costs were about double the average installation. I estimate the average to be about \$1,000 for system components including the Folk ram pump which runs about \$695. Labor is not included in these approximations.

A typical installation includes a 1.5 inch steel drive pipe from the source to the ram pump, a poured concrete foundation to secure the pump, a one inch poly delivery pipe to the household supply tank, and valves and unions to control flow and allow access to the various components of the system.

Pump Performance

Because the Folk ram's capabilities could easily outstrip our supply, we choked it back so it wouldn't run out of water. When a ram pump stops cycling, it needs to be restarted by hand. Once we had the pump properly set, it just kept running on and on for months without the need for further attention. This reminds me of a ram pump story I heard:

Friends were hiking near the New River in the Trinity Mountains of Northern California. This river is peppered with old gold mining claims. Far away from any other form of civilization, the hikers were surprised to come to an otherwise pristine spot where they heard a muffled "ka-chunk ka-chunk ka-chunk...." Taken by surprise, they were unable to discover the source of the mechanical noise until they dug down several inches through the forest humus finding a rotten board covering a hollow box. The box contained an old ram pump that had been operating on its own, unattended for as long as it took the box cover to become buried under many layers of duff.

Commercial ram pumps are known to provide years of trouble-free service. We expect that the Folk ram will furnish Cara with water for decades to come.

Even with the pump choked back for the decreased supply, we obtained delivery rates of 600 gallons per day. This is a far cry from the 2,400 gallons per day that this pump could achieve under the same drive and delivery heads with unlimited access to the creek's supply. However, it was more than adequate for Cara's needs which max out at 475 gallons per day. Jim Folk states that, under ideal supply, drive, and delivery conditions, this particular model of his pump will produce up to 5,000 gallons per day. He has a second model that will produce up to 25,000 gallons per day.

For you folks with super low flow situations, this pump may still work for you. For several months, I had this

pump installed on my own spring which was flowing at about 1,500 gallons per day, with 26 feet of drive head, and 158 feet of delivery height. This is really running the pump on the low end of its capabilities, yet it still was able to provide my home with about 190 gallons of water per day.

Conclusion

Folk ram pumps are well-made, dependable, and work as promised. While there are other ram pumps available, the Folk has features that are unique and proven. At \$695 for a pump that will likely outlast its owner, it is an excellent buy. A larger model is available that lists for \$995. These pumps are handmade in Conyers, Georgia.

Access

Author: Michael Welch, c/o Redwood Alliance, POB 293, Arcata, CA 95521 • voice 707-822-7884 • BBS 707-822-8640

Ram Pump Maker: Folk Water Powered Ram Pumps, 2770 White Court N.E., Conyers, GA 30207 • 404-922-4918



Trace Engineering
camera ready
4.68 inches wide
4.85 inches high

We Specialize

**Home & Cabin
Solar Electric & Heating Systems**

- 18 years of Cold Climate Applications —
- Design /Build or Licensed Installs —

*15% Off
These
Products
Thru Spring*

- Kyocera, Solarex, and Siemens Modules
- Trace Inverters and Ananda Power Centers
- Wir'sbo Radiant Floor Tubing
- Whisper 600 (World Power Tech) Wind Machine



SDESS

P.O. Box 36, Crosby, MN 56441

218-546-5369

**Seminar Dates in Mpls & St. Paul — Call*

WIND BARON NEO +2™

Exclusively from AMERICAN INDEPENDENT POWER

1-800-DCSOLAR

Spring Wind Blow-out! \$850 (STD)



+2 Does more! Regulates all your charging sources!
Switches to aux load at full charge. Choice of Voltage
NEO+2 w/compl wired board \$975
NEO Star (w/wired board & 1500 PowerStar \$1775)
Call for other Spring Blow-outs!!!

Energy independent, established since 1974

American Independent Power

60 Firehouse Road, Plymouth, MA 02360 • 508-759-6706

Building a Homemade Ram Pump

Scott Lee

©2000 Scott Lee

During the mid 1970s, I first encountered the hydraulic ram water pump. A friend of mine was interested in a water pump for irrigating a garden. I had also purchased some land with a stream and a nice garden spot, but no electrical service. The combination of a stream below my garden spot and no electrical power seemed to be a perfect situation for a hydraulic ram.

Three Tries

The manufactured rams back in the '70s were fairly expensive—US\$250 and up. Some publications had home-built designs. One in particular was by an organization called VITA (Volunteers in Technical Assistance). Based on the cost of the manufactured rams, I set out to construct a home-built ram pump. The first two versions of my ram were based loosely on VITA's descriptions and plans. They weren't followed

Scott Lee's ram pump in operation.

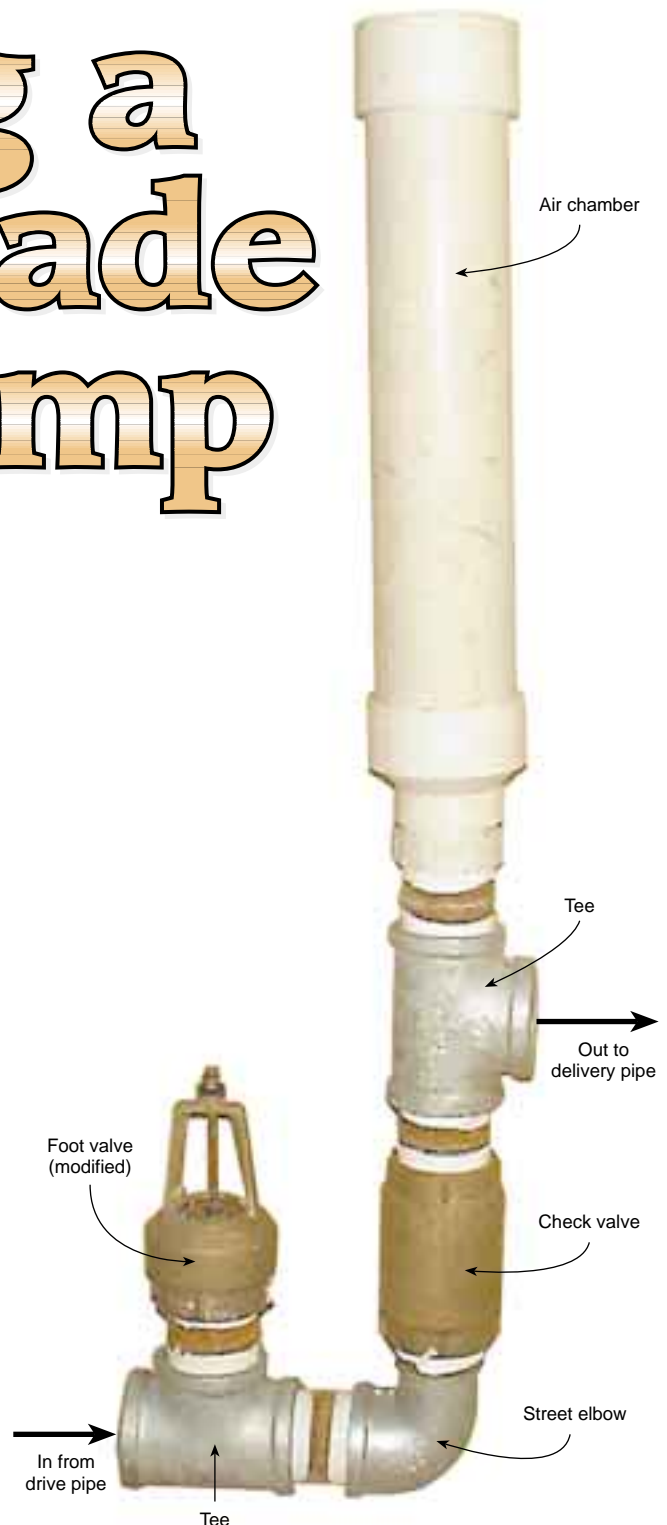

exactly, due to the difficulty in obtaining some of the parts that were mentioned.

I recently went to the local hardware store to check out the cost of these parts. The 2 inch version of my homebrew ram will cost about US\$130 (see parts list). A 1 inch ram will be cheaper, and might cost a little more than half that amount. The cost of the pipes needed to hook up the ram may exceed the cost of the ram itself.

Ram Pump Parts List

Qty	Item
1	2 inch foot valve (brass)
1	2 inch check valve (brass)
2	2 inch tees (galvanized)
6	2 inch close nipples (galvanized)
1	2 inch street elbow (galvanized)
1	2 by 1 inch bushing (galvanized)
1	1 inch close nipple (galvanized)
1	3 inch pipe cap (PVC)
1	3 inch pipe, 18 inches long (PVC)
1	3 by 2 inch reducer (PVC)
1	2 inch PVC to IPT adapter (PVC)
1	1/4 inch threaded rod (stainless)
6	1/4 inch nuts (stainless)
2	1/4 inch washers (stainless)
1	Faucet washer
1	14 gauge copper wire, 2 inches

The first version of my ram was built entirely out of galvanized steel pipe and fittings. The waste (or impetus) valve proved to be the hardest to construct. The first version's valve was constructed from a 1 1/2 by 1 inch bushing. While this valve worked after a fashion, it was very leaky. I figured that the ram would perform better if this valve would seal tightly. My second version had a valve that was constructed from a 1 1/2 inch pipe plug. The plug was bored with a 1 inch hole, and had the inside surface of the plug machined smooth. This resulted in better ram performance.

I never used the first two versions in working applications, though I did test them. Shortly after the second one was operational, an article appeared in *The Mother Earth News* (May/June 1979, #57, page 120) with instructions on how to build a ram mainly out of PVC pipe fittings. Using this design as a guide, I developed a third version. This version was also built from galvanized steel pipe fittings, with the exception of the air chamber, which was constructed from PVC pipe

and fittings. This version still required machining of a sort—cutting threads on the outside of a 1 1/2 inch hose barb, so that it would thread into a 2 by 1 inch bushing.

Although this was a workable system for constructing the waste valve, it still was not as simple as I wanted. For a time, this ram was used to pump water to my garden. The water was also used to provide showers, with the use of 200 feet (60 m) of 3/4 inch black poly pipe for a solar water heater. This pump was installed with a 4 foot (1.2 m) fall (head) to the ram, developed over the distance of 100 feet (30 m). It had a delivery lift of 30 feet (9 m) to a 3 by 12 foot (0.9 x 3.7 m) pool used as a storage tank. The point of use was 15 feet (4.5 m) lower than this storage pool.

Standpipe

When the ram was first put into service, it operated very slowly—about 15 to 20 cycles per minute. Everything that I'd read stated that rams of this size should operate at about 45 to 60 cycles per minute. I fabricated a standpipe and inserted it in the drive line about 30 feet (9 m) from the ram. This is within the recommended 5–10 times ratio of head to drive pipe length. This allowed the ram to operate in the 45 to 60 cycles per minute range. The flow of water delivered to the tank increased from 0.25 to 0.75 gallons (0.9 to 2.8 l) per minute.

Ideally, the length of the drive pipe should be in the range of 5 to 10 times the head. So for a head of 3 feet (0.9 m), the length of the drive pipe should be in the range of 15 to 30 feet (4.5–9 m).

If the drive pipe is too long, the cycle frequency that the ram can operate at will be limited to some low value. The standpipe provides a closer location for the ram pump's supply. This means that there is less resistance in the drive pipe, and the flow can reach full velocity more

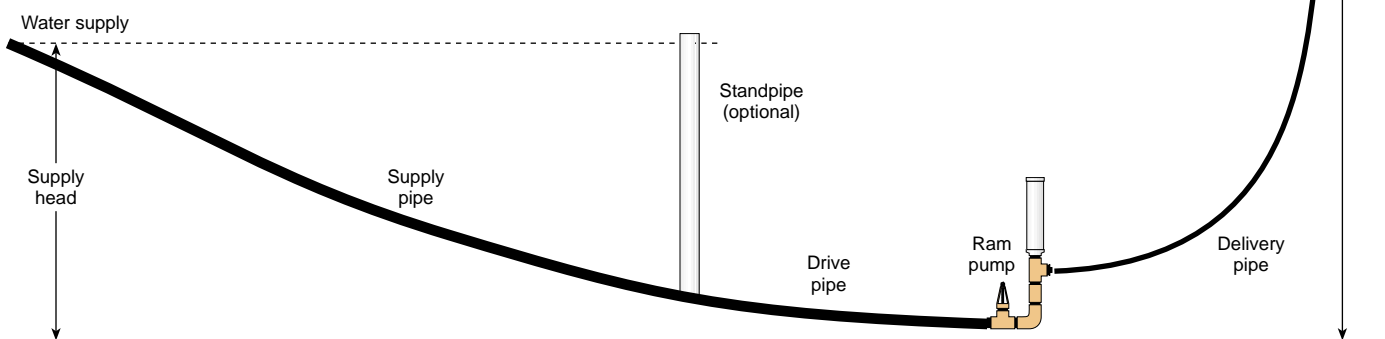

How a Ram Pump Works

The energy required to make a ram lift water to a higher elevation comes from water falling downhill due to gravity, as in all other water-powered devices. But unlike a water wheel or turbine, the ram uses the inertia of moving water rather than water pressure, and operates in a cycle.

1. When the waste valve is opened, water flows from the source, through the water inlet (drive) pipe, and out the waste valve.
2. After a short time, the velocity of the flow is high enough to force the waste valve closed. The water, due to its inertia, wants to continue moving past the valve. The pressure inside the ram will rapidly increase enough to force the check valve open. This forces some water into the air chamber, compressing the chamber's air bubble. The pressurized bubble forces that water through the delivery pipe to the point of use.

For a ram pumping one gallon (3.8 l) per minute, and cycling 60 times per minute, each cycle pumps one-sixtieth of a gallon—about two ounces (60 ml). The compressed air in the air chamber helps smooth out the flow on the delivery side of the ram, so the flow tends to be more continuous, rather than a small spurt during each cycle of the ram.

3. Soon after the check valve has opened, the pressure surge (generated by the waste valve closing) is spent. Flow will try to start backwards, but the check valve will close, preventing this from happening.

4. At about this time, the pressure in the drive pipe will be low enough so that the waste valve can open, allowing water to start flowing from the source to the ram, beginning a new cycle.

The cycle that the ram goes through can occur 30 to 120 times per minute, depending upon conditions such as head, flow, and the size of the ram.

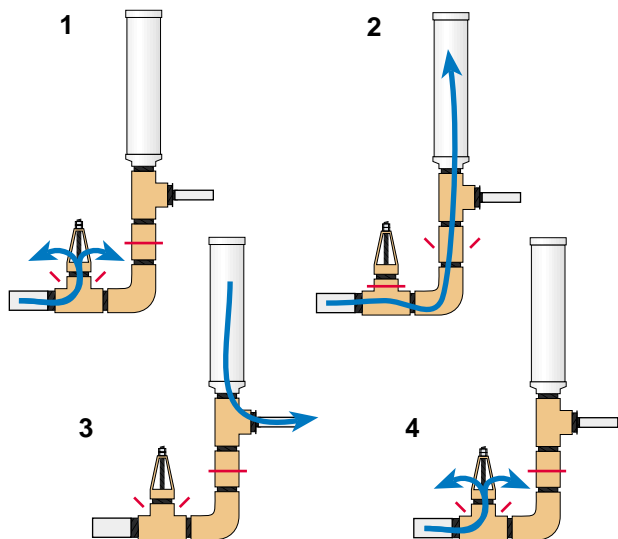

quickly than without the standpipe. Basically, a standpipe allows the ram to operate as if it had a shorter drive pipe.

The diagram on page 43 shows a standpipe inserted between the supply pipe and the drive pipe. The critical distance is now only the distance between the standpipe and the ram, not the total distance to the source of supply.

A standpipe can easily be constructed out of PVC pipe and fittings. The pipe needs to be long enough so that it is a few inches higher, in its installed location, than the elevation of the water source. Consider screening the top of the standpipe to keep out birds, insects, and detritus if you are pumping potable water.

The standpipe is usually inserted at a distance from the ram that is 5 to 10 times the supply head. This will vary from installation to installation. Since my installation had 3 feet (0.9 m) of supply head, I inserted the standpipe 30 feet (9 m) from the ram. This allows the ram to cycle properly, which results in more water pumped.

It's also important to consider the diameter of pipe on long drive runs, to minimize flow loss due to pipe friction. When in doubt, go up in size. It's recommended that the standpipe be at least two full pipe sizes larger than the drive pipe. I've used 4 inch standpipes with 2 inch rams, and 2 inch standpipes with 1 inch rams. It's also recommended that the pipe from the supply to the standpipe be one full pipe size larger than the drive pipe. This will insure that the flow to the standpipe will be able to keep up with the ram pump's usage.

Drive Pipe

This configuration operated for about six months, after which it was dismantled for the winter. It was later installed at a new location with 3 feet (0.9 m) of head and 12 feet (3.7 m) of lift. Most of the time it supplied garden soaker hoses, with an old 52 gallon (200 l) hot water tank being used for a small storage volume, operated as a pressure tank.

One day, we were operating the ram with the discharge valve shut, and we noticed that the 2 inch black poly drive pipe was actually expanding visibly with each closing of the waste valve. We concluded that a portion of the energy was being wasted expanding the drive pipe, rather than pumping water. We also noticed that the max discharge pressure was 21 psi.

So I replaced the 30 feet (9 m) of black poly pipe between the standpipe and the ram with schedule 40 PVC pipe. With this pipe in place, I noted that the maximum discharge pressure was now 57 psi. This meant an almost threefold increase in the amount of water delivered. With a 12 foot (3.7 m) lift, we

measured the flow at 2 gpm after the installation of the PVC drive pipe.

Based on these observations, I suggest that you don't use black poly pipe or other flexible pipe for the drive pipe. If you are using a standpipe, the pipe from the standpipe to the ram is the only section that needs to be rigid. The supply pipe from the source to the standpipe can be flexible. If your drive head is higher than a few feet, steel drive pipe is recommended, since high pressures can blow out plastic pipe joints.

Versions Four & Five

Although this ram was successful, it still was not completely satisfactory. The waste valve needed a lot of maintenance, and also required a pipe threading machine to make it.

In light of these shortcomings, a fourth version was built using a standard plumbing check valve for the basis of the waste valve. This worked well, but required a lot of work to cut discharge ports into the check valve.

In a matter of days after version four was put in operation, it was discovered that a foot valve would serve the purpose as well as a check valve, with very little work required to convert. This valve was built and put into operation successfully and performed well. The fifth version is still in use. I think that it was first used in 1980 or '81. This ram continues to provide irrigation for a garden, and water for keeping a compost pile moist enough for proper decomposition.

It should be noted that this is not a year-round installation. Before winter weather starts, the ram and standpipe are removed from the stream to prevent freezing. They are reinstalled the following spring. This has worked well, since there is no demand for the water during the winter.

I built and installed another ram of this size for a neighbor, to supply water from a spring to two houses. This ram was a slightly improved version. The main differences were that I used a larger check valve and foot valve, which improved the performance slightly. This ram was supplied by 4 feet (1.2 m) of head and lifted the water 30 feet (9 m) to a 1,500 gallon (5,700 l) storage tank about 1,400 feet (425 m) away.

At the storage tank, separate centrifugal pumps and pressure tanks were used to supply water to both



The foot valve on its way to becoming the waste valve—the stem is cut off the valve disc and the lower crosspiece has been cut away from the casting.

houses. The ram delivers almost 1 gpm to the storage tank, which has proved to be plenty of water for all normal household uses. This ram installation is freeze-proof, with the delivery line buried and the ram in an enclosure. The ram has proved to be superior to trekking to the spring and running a gasoline engine-driven pump every two to three days to fill the storage tank.

How to Build The Ram

All of the parts for the ram were obtained from a local hardware store's plumbing section. The foot and check valves were Simmons brand, but any other good quality valves should work as long as they are of the same general configuration.

Begin the fabrication of the waste valve by removing the screen that is supplied as part of the foot valve. Then use wrenches to remove the valve disc from the foot valve, and cut off the supplied stem from the valve.

Now take the disc and drill a 1/4 inch (6 mm) hole in the center of it.

Use extreme care in drilling this hole to make sure that it is straight and centered. Use a drill press if you can. It is possible to get this right by hand if you are careful.

Now cut a 6 inch (15 cm) piece of 1/4 inch (6 mm) threaded stainless steel rod for the new valve stem. Thread on one of the 1/4 inch nuts, far enough to allow the valve disc to be placed on the threaded rod with room for another 1/4 inch nut. Lock the disc to the threaded rod by tightening both nuts against the disc.



The valve disc is reassembled with a 6 inch long piece of 0.25 inch stainless steel threaded rod, and locked in place with nuts top and bottom.

Now take the valve body and enlarge the threaded hole in the top crosspiece to 1/4 inch with a drill. Again, use care to get this hole straight. Using a hacksaw, remove the lower crosspiece.

After these modifications have been made, take the modified valve disc and insert it up through the valve body. After you have inserted it, put on a 1/4 inch washer, a faucet washer with its hole enlarged to 1/4 inch, and another 1/4 inch washer. The faucet washer provides some cushion to help quiet the waste valve when it falls open. Then thread on two 1/4 inch nuts, adjusting them so that they allow about 1/2 inch (13 mm) of movement of the valve disc and stem within the body. This is a good starting point—further adjustments can be made later, after the ram is operating. Your assembled valve should look like the diagram at right.

Air Sniffer

The next step is to modify the 2 inch check valve by adding an air sniffer hole. This hole will allow a little air to be taken in on each stroke of the ram, replacing air in the air chamber that has dissolved in the water and gone up the delivery pipe. Loss of all the air in the air chamber can result in something breaking. I once saw the bonnet of a 2 inch PVC valve blow off. This valve was used to isolate the ram from the drive pipe. If you choose not to use an air sniffer, you must shut down the

ram every few days and drain some water from the air chamber.

Begin the construction of the air sniffer by stripping the insulation from a piece of #14 (2 mm²) copper wire. Select a drill bit that is just slightly larger than this wire. Use this bit to drill a hole in the check valve as shown in the next sketch.

Make sure that you drill this hole on the correct side of the valve seat, as shown on page 47. After you have drilled this hole, twist a small loop in one end of the wire you have stripped. Insert the straight end of this wire into the hole, and twist another small loop in the wire on the inside of the check valve. If you are building the ram for a low-head installation, you may want to remove the spring from the check valve at this time. Otherwise it can be left in place.

Air Chamber

The air chamber is the last piece you will need to assemble before the ram can be completely finished. A 4 inch diameter air chamber should be okay for up to 10 feet (3 m), while a 6 inch chamber should work for about 15 feet (4.5 m). When in doubt, it's probably better to err on the large side. The air chambers are usually about 18 inches (46 cm) plus the length of the fittings, but could be made longer if necessary.

Assembled Waste Valve Detail

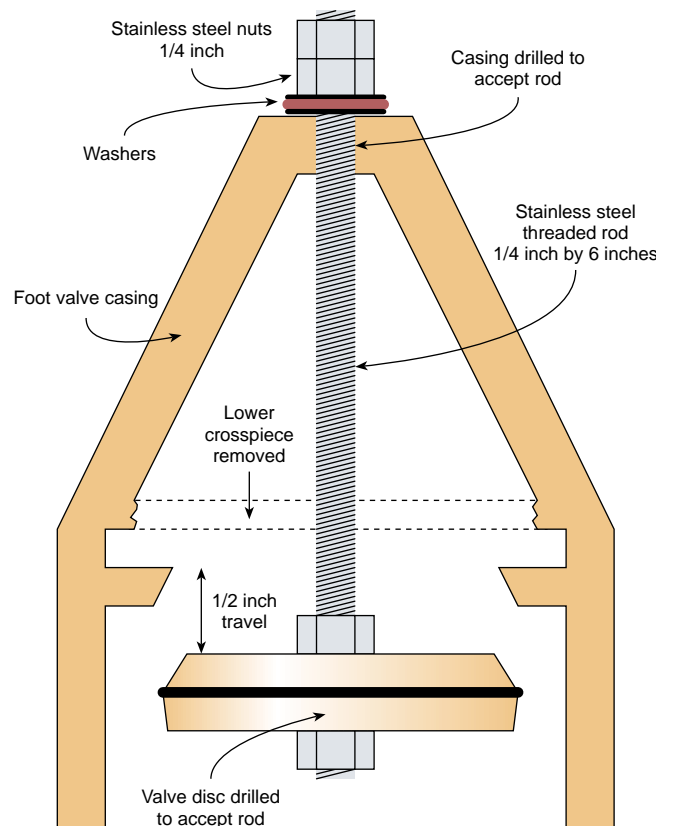



The modified foot valve ready to assemble onto the ram.

To assemble the air chamber, glue a cap to one end of the 3 inch PVC pipe. Then glue the 3 by 2 inch reducer to the other end of the pipe. After these are complete, glue in the PVC to IPT adapter. The air chamber should now be complete, and the final assembly of the ram can proceed.

Assembly

Screw a 2 inch close nipple into one of the end branches, and another into the side branch, of a 2 inch tee. Teflon tape should be used on all of the threaded connections. This will aid in any disassembly that may be required in the future. Screw your waste valve onto the nipple on the tee's side branch.

Screw the street bend onto the nipple on the end branch. Screw the check valve onto the end of the street bend. The flow directional arrow should point away from the street bend. Screw a 2 inch close nipple into the check valve. Screw an end branch of the other 2 inch tee onto the close nipple.

Screw another close nipple into the other end branch of the 2 inch tee. Screw your air chamber onto this nipple. Screw the 2 by 1 inch bushing into the side branch of

the tee. Screw the 1 inch close nipple into this bushing. Go back to the first 2 inch tee and screw in the last 2 inch close nipple.

Your completed ram should look approximately like the photo on page 42. The 3 inch air chamber size on this ram should be adequate for supply heads of up to 5 feet (1.5 m). If the head is greater than this, the air chamber should be larger.

Installation

This completes the ram pump construction, but you may find that this is the easiest part of the job. As much or more depends on a good installation. I recommend that you use a union on either end of the ram. A gate valve on both the drive and discharge lines will also facilitate any maintenance that is required on the ram itself. The diagram on page 43 is a typical ram installation, showing head, lift, supply, delivery, and the length of the drive pipe.

To calculate how much a ram will deliver, divide the head by the lift, multiply by the flow, and finally multiply by 0.6. It takes at least 5 gpm to run this ram, with at least 2 feet (0.6 m) of head. In general it is easier to pump more water with more head, so run more drive pipe to get the head you need.

The check valve with the wire poking out of the air sniffer hole.



Check Valve Cutaway

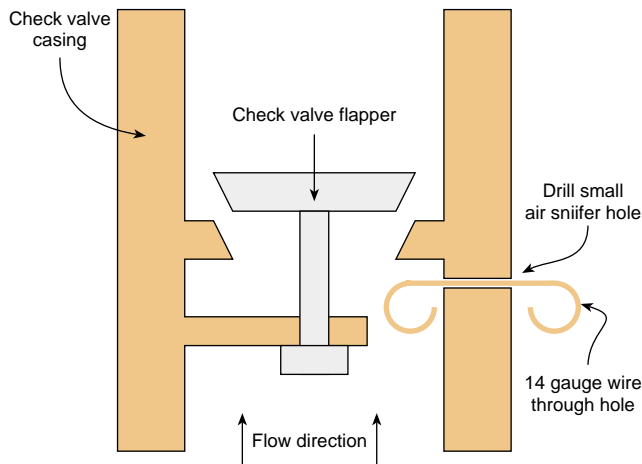

Using this equation, a site with 3 feet (0.9 m) of head, 20 feet (6 m) of lift, and a supply flow of 10 gpm would deliver 0.9 gpm. The same flow and lift, with 4 feet (1.2 m) of head, would result in 1.2 gpm delivered to the point of use. Or the same delivery could be accomplished with less supply flow. The delivered flow of 0.9 gpm could be achieved with 7.5 gpm of supply flow, using 4 feet (1.2 m) of head.

Maintenance on this ram is not very demanding. I've had to replace the faucet washer a couple of times per year. Otherwise the ram is noisy, and tends to wear the metal parts more. The O-rings on the valves will have to be replaced about every five years. The wire in the air sniffer will last two to four years.

Consider a Ram

Hydraulic rams can be very useful in providing a supply of water from a lower to a higher elevation. They can

pump in a remote location, with no other energy required besides the falling water. Don't be discouraged about the small flow of water delivered by a ram, since they can pump 24 hours a day. Remember that one gallon per minute times 1,440 minutes per day will be 1,440 gallons per day delivered to wherever it is needed. It can also be used year-round if the ram and piping are protected from freezing.

The most important step in deciding if a ram is for you is a site survey. This will ensure that you have the flow and head required to operate a ram. Once this has been determined, build a ram to supply the water. Rams are inexpensive, easy to construct, and dependable, so there's no reason not to use one, if you have a location that meets the requirements.

Access

Scott Lee, 708 White Rock Gap Rd., Covington, VA 24426 • 540-862-4377 • slee529282@aol.com

Other *Home Power* articles on ram pumps:

Hydraulic Ram Pump, by Kurt Janke & Louise Finger, *HP41*, page 74.

Things that Work! on the Folk Ram Pump, by Michael Welch, *HP40*, page 44.



Think outside the box!

Charge batteries faster & with half the fuel
with **GennyDeeCee**
the 12, 24, or now 48 volt D.C. generator

**ANNOUNCING:
Product Upgrade**

Automatic electronic charge controller. Select one of five high limit voltages. A digital timer then holds this voltage for up to 2.5 hours. When this absorption time is completed, GennyDeeCee automatically shuts down.

- Options: LPG (propane), electric start, remote muffler adapter, 3.4 Gal. gas tank, pulley/belt guard
- Heavy duty construction and powder coated for durability

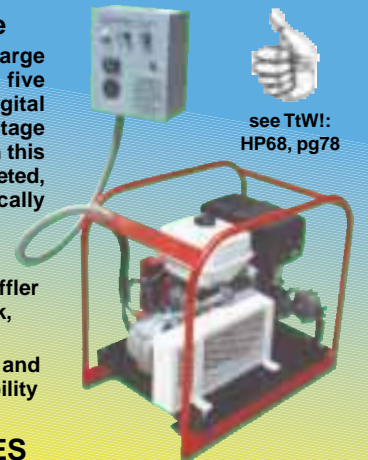

see TtW!
HP68, pg78

**DEALER INQUIRIES
INVITED**

Powered by
HONDA
E N G I N E S
Authorized O.E.M.

information:
Feather River Solar Electric
5575 Genesee Rd.
Taylorsville, CA 95983
Toll Free 888-840-0788
web: www.gennydeecce.com
email: info@gennydeecce.com

SUNWEAVER
Design and Installation of Independent & Back-up power
Serving New England Since 1985

1-800-SUNWEAVER
Route 4 Northwood, NH 03261
Phone: 603-942-5863 ~ Fax: 603-942-7730
Web: www.sunweavers.com ~ e-mail: fonature@tiac.net

Hydraulic Ram Pump



Homebrew

adapted from *A Manual for Constructing and Operating a Hydraulic Ram Pump* by Kurt Janke & Louise Finger

©1994 Kurt Janke & Louise Finger

Here's a design for a hydraulic ram pump that requires readily available materials and few tools to construct. Ram pumps are commercially available that are potentially more efficient and durable, but are also more expensive. This pump can be built for under \$75, and is capable of pushing 130 gallons per day 150 feet high, with a drive head of 20 feet.

A ram pump uses the potential energy of falling water to lift a fraction of that water to a higher elevation. (See Figure 1) Water accelerates through the drive pipe and open waste valve. Its velocity increases until the flow and upward force causes the waste valve to shut suddenly. The momentum of water produces a short-lived pressure, called the "ram", which is greater than that in the pressure tank. This causes a small amount of water to be released through the check valve into the tank. After the exerted energy is transferred into the pressure tank, the pressure below the check valve is less than that in the tank. The check valve shuts and the waste valve falls open, allowing the cycle to repeat continuously. The compressed air in the tank acts like a spring to drive the water that had passed through the check valve into the delivery pipe and on to a higher elevation.

The output volume of a ram pump is determined by the drive head, delivery head, amount of available water, and stroke length of the waste valve. The greater the drive head, the greater the acceleration in the drive pipe, and thus the potential energy at the pump. A longer stroke length also allows a greater velocity to reach the pump. Similarly, the greater the flow, the greater the mass of the moving water, and thus greater the potential energy. The greater the delivery head, the greater the energy required to pump a given volume of water.

Tools required for this homebrew ram pump are: two 24 inch pipe wrenches, two 7/16 inch wrenches, utility knife and/or circle cutter, drill and metal bits, #8 tap, and a screwdriver. For materials, see the list on right.

Waste Valve Assembly

Figure 2 illustrates the waste valve assembly. Use only half of the 1 1/4 inch union for the base/seat of the valve. It will be necessary to drill a 3/8 inch hole through the 1 1/4 inch male plug and a 5/16 inch hole in the shoe heel material. Attach the shoe heel disk to the bottom of the all-thread by securing the lock nuts and washers around it. The rubber washer at the top of the valve serves to reduce the stress induced on the adjustment nuts by the continuous pounding of the ram. The relatively soft all-thread used in the waste valve might stretch (or even break occasionally), so we recommend

Materials Required

Pump
10 liter fire extinguisher (1" thread [®])
1/2" gate valve
Two 2" tees
1" tee
2" 90° elbow
2" x 4" nipple
1" x 4" nipple
Two 1" close nipples
1/2" x 4" nipple
1/2" x 2" nipple
Two 2" x 1" reducer bushings
2" x 1/2" reducer bushing
1" x 1/2" reducer bushing
Teflon tape
Waste Valve
1/4" tee
1/4" close nipple
1/4" male plug
1/4" union
5/16" x 10" all-thread*
Two 5/16" nuts
Two 5/16" lock nuts
3/4" ID x 7/8" OD flat washer
5/16" ID x 3/4" OD flat washer
5/16" ID x 1" OD flat washer
rubber washer
7/8" diam. x 3/8" shoe heel material [†]
Check valve
Two 2" x 3/4" reducer bushings
3/4" close nipple
#8 x 1/4" machine
tractor tire rubber or leather [†]

[®]Other types of tanks or larger diameter pipes may work better, as fire extinguisher bodies are often made from soft aluminum with a potential for thread failure.

*A steel bolt with threads over its full length will also work and may be more durable.

[†]Available at shoe repair or leather-working shops.

having replacements on site, or using a more durable material.

Be as accurate as possible with the tolerance between the all-thread and the plug. Cut the shoe material accurately round, and center the holes carefully. The success of the pump depends on the waste valve running up and down precisely as well as how it seats on the union.

**Figure 1
Assembly
Detail**

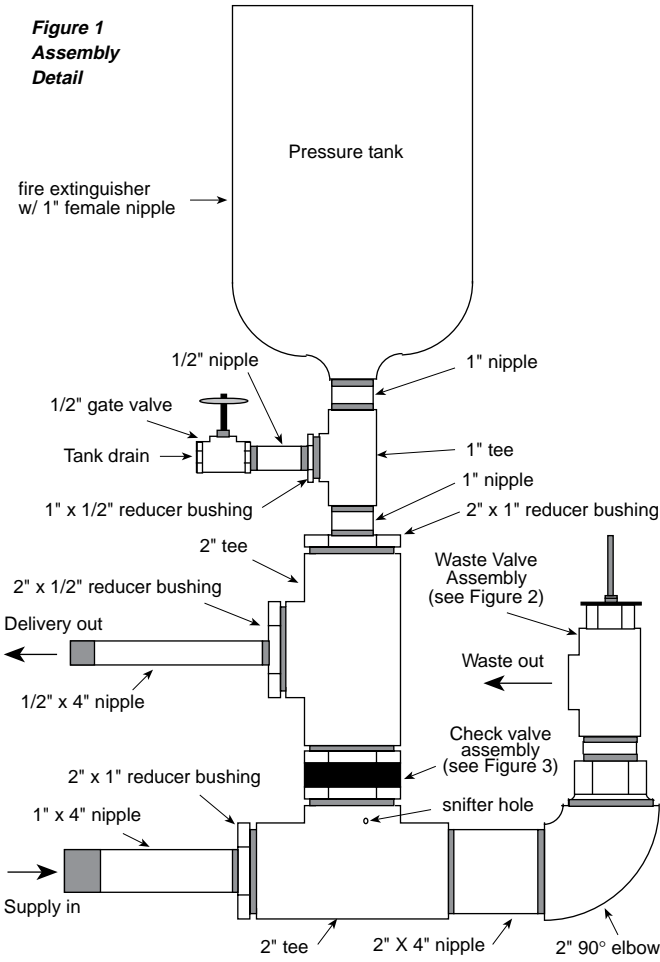

Check Valve Assembly

Figure 3 illustrates the check valve assembly. A reducer bushing is used as the valve seat. Drill a 1/16 inch hole in the bushing flange and thread the hole with a #8 tap. From tough rubber, such as a tire, cut a disk approximately 1/8 inch thick so that it fits loosely inside the bushing. Secure the disk with a screw. Cut additional disks to be used as spacers and support between the two bushings. Use Teflon tape on the nipple threads to prevent leakage.

Thick leather makes excellent check valve material, as well. Putting a heavy washer acting as a weight on top of the valve material may also increase the sealing

**Figure 3
Check valve detail**

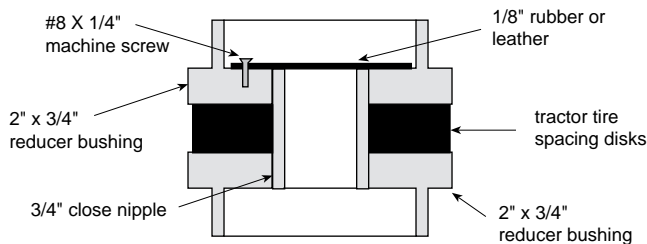

ability of the valve. This washer should be centered over and cover the width of the seat, and can be secured with a short bolt and locknut, with a small washer on the underside.

Pump Assembly

Valves, fittings, and pipes are assembled together as shown in Figure 1, using two pipe wrenches. In the same fashion as the check valve, all threaded pipe should be Teflon taped and tightly secured.

A very small snifter hole may be drilled in the tee below the check valve. This will allow air to be sucked into the pressure tank to replace the air that inadvertently mixes with water and exits through the delivery pipe. Many homemade pumps just leave this hole open, but efficiency can be lessened as water squirts out during the ram. Without a snifter, the pressure tank will eventually fill with water and need to be emptied regularly.

One marginal remedy is to put a nail through the hole with the head on the inside, bending the shank on the outside to prevent the nail from being sucked into the pump. Shoot for a loose back and forth fit so that air can be sucked in, yet the head of the nail can close off the inside of the hole during the ram.

Installation, Operation and Maintenance

Both the drive and delivery pipes should have a shut-off valve and union on the pump end of the pipe. The only mounting apparatus needed is a stable pad for the pump to rest (i.e., a board). The pump should be held upright and installed so that the waste valve unit is clear of water and obstruction.

**Figure 2
Waste Valve Detail**

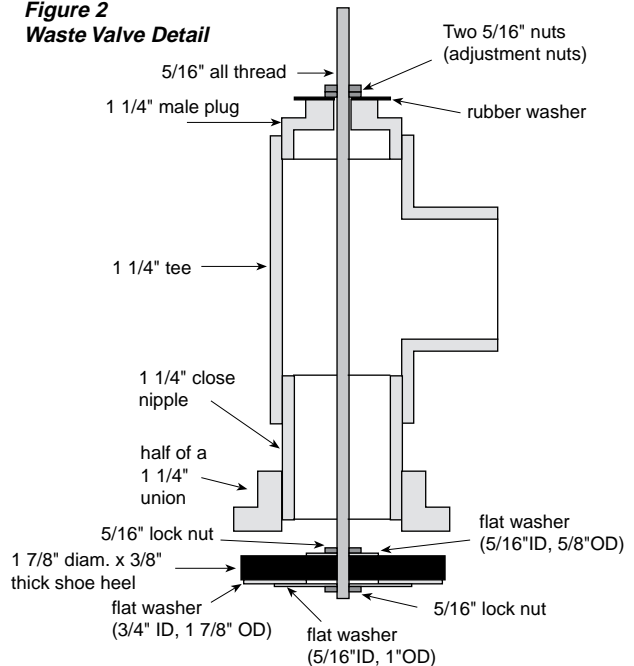

Homebrew

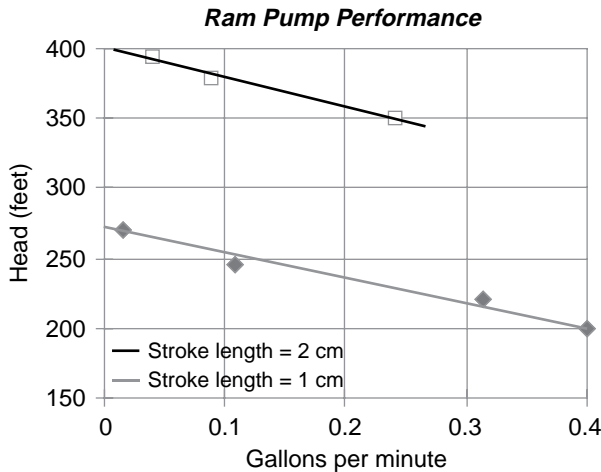

To start the pump, set the stroke length between one and two centimeters and open the inflow valve, keeping the outflow valve closed. Manually open and close the waste valve until it will operate on its own. Wait approximately one minute and then crack open the outflow valve a little at a time. If the pump fails to continue operating, repeat the process, lengthening the lag time prior to opening the outflow valve.

The stroke length can then be experimentally varied to optimize pump output. Shorter stroke lengths work better at lower flows and longer stroke lengths are better for higher flows. A longer stroke length provides a greater velocity in the drive pipe, thus increasing the potential energy in the falling water at the pump. However, more water is "wasted" which may result in possible source depletion.

If the pump is operated continuously without a snifter valve, it should be drained, via the tank drain, before the pressure tank becomes full of water. One should expect to drain the tank approximately once a month, unless you have a working snifter valve. The rubber used in the valves should withstand continuous use for several years. Periodic inspections will help determine when replacement is necessary.

This homemade ram pump is a "folk project", with improvements by each person who built it. If you find new solutions for keeping the waste valve in better alignment, or a good snifter design, please share them.

Access

Louise Finger & Kurt Janke developed this pump through Humboldt State University's International Development Program (see page 78). For information, call 707-826-3619.

Contact authors through Michael Welch, c/o Redwood Alliance, PO Box 293, Arcata, CA 95521 • 707-822-7884 (voice) • 707-822-8640 (Computer BBS)



ADVANCED ELECTRONICS

8525 Elk Grove Blvd Ste 106
Elk Grove, CA 95624

(916) 687-7666

Equipment shown
by appointment



UNFRAMED CARRIZO'S

Copper Quad Lams 87 Watts \$199
Bronze Quad Lams 95 Watts \$279
Super Gold Quad Lams \$469

FRAMED & J BOXED CARRIZO'S

Bronze Quads (polycarbonate) \$350
Bronze Quads (aluminum) \$379
Gold Quads 105 Watts (aluminum) \$449

AMORPHOUS LAMINATES \$39 each (MIN. ORDER 3 LAMS)

10 Watt 12"x36" FRAMELESS VOC-22.5, VPP-14.50

plus shipping and handling

Call for best pricing on inverters, charge controllers, and batteries.

THE RUTLAND WINDCHARGER

Ideal for stand-alone or combined wind/solar systems, the Rutland gives 1 Amp at 10 mph and 6 Amps at 22 mph.

The Rutland Windcharger's fine profile aerodynamically efficient blades and unique low friction generator ensure maximum performance from its 910mm (36") diameter turbine.

Manufactured in the U.K. and available in N. America from:

Trillium Windmills Inc.

Campbell Road, RR #3

Orillia, Ontario, Canada, L3V 6H3

Tel: 705 326 6513 Fax: 705 326 2778

Dealer Enquiries Welcome

Please contact Marlec for details of your country's distributor if outside North America.

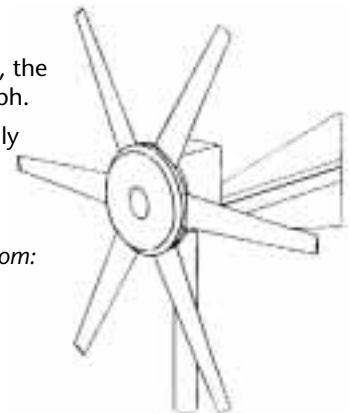

MARLEC Engineering Co. Ltd.

Rutland House, Trevithick Road, Corby,
Northants, NN17 1XY England

One of the world's
leading wind powered
battery chargers proven
by over 15,000
customers worldwide

Things that Work! Alternative Energy Engineering's High Lifter Pump

Test Conducted by Michael Welch



Things that Work!
tested by Home Power

Let me start by saying that I am completely sold on the High Lifter pump for my application. My High Lifter is pumping 240 gallons per day from a 6 gallons per minute spring that is 132 feet downhill from my water tank. The High Lifter is located 26 vertical feet below my spring.

Shipping Container and Documentation

The High Lifter comes well wrapped in a 6 in. x 6 in. x 28 in. cardboard box. Alternative Energy Engineering uses recycled materials for packaging their products. The shipping weight is 10 pounds. Included with the pump itself is an inlet filter, an inlet pressure gauge, a hose for between the filter and the pump, an output pressure gauge, and a ball valve with a check valve for the outlet.

The Owner's Manual that comes with the pump is one of the best written pieces of documentation that I've ever seen. It is 23 pages long and includes: an introduction, typical applications, how it works, how to install it for various situations, an in depth section on maintenance and troubleshooting, performance curves, a troubleshooting flow-chart, an exploded view showing all the pump parts, and a specifications table.

The Test Site

My water system is comprised of a spring which flows into a large 480 gallon settling tank. From there, the water flows at 6 gallons per minute through 3/4 inch Schedule 40 PVC pipe 26 vertical feet to my pump site. The pump then pushes the water up 158 vertical feet through 1" black rolled drinking water pipe (only 1/2 inch pipe is required). The 250 gallon tank at the top is suspended between two sturdy conifers about 20 feet above the taps in my home to obtain sufficient indoor water pressure.

Pumping water without electricity

This pump works great without electricity, without internal combustion, and without noise. This pump will take a steady but small flow of

water, and, with a short drop, pump a significant part of the water way up hill to the place it is needed.

Oh, if only all our water supplies were located above the point of use. Alas, it is an imperfect world. Well, then, if only we could afford some of the fine solar water pumping systems that are available. By the time you purchase the pump, wiring and the fair number of PV panels needed, your cookie jar will look like a bottomless pit.

I know two ways to use a downhill flow of water to pump a portion of the water further uphill. One is with the time-tested ram pump. The ram pump lets a flow of water in a pipe build up momentum until the flow causes an impetus valve in the pump to slam shut. The water, still wanting to exert its moving energy, is channeled into a chamber containing air, which is compressed by the force of water. The compressed air bubble in the chamber then expands to push a small amount of water out a second pipe going up the hill to the point where water is needed. The pressures inside the pump are then equalized, allowing the impetus valve to

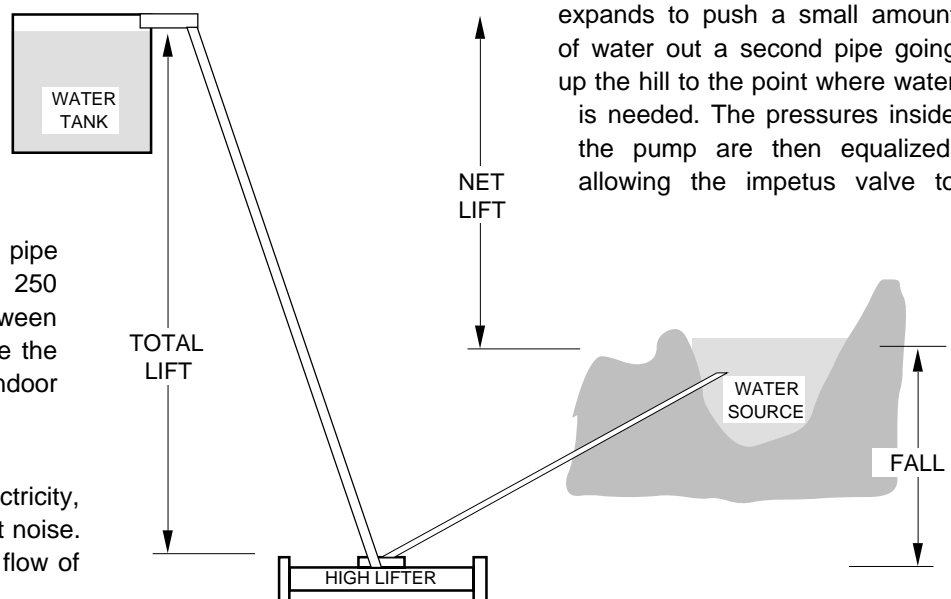

open again thus starting the downhill flow moving again, and the cycle repeats.

The second method is with the relatively new High Lifter. The High Lifter uses head pressure instead of momentum in a downhill pipe. It uses a larger volume of low-pressure water to pump a smaller volume of water at a higher pressure. A larger piston acts with a smaller one to gain mechanical advantage, a kind of "hydraulic lever." A collar inside the pump controls the inlet valve. As the pistons reach the end of their stroke, they contact this collar, pushing it until it directs a small amount of "pilot water" to the end of the spool in the pilot valve, thereby shifting it and changing the direction of the water flow in the pump. The flow moves the two-way pistons in the opposite direction until they again contact the collar, which shifts the pilot valve again, and the process repeats. Thus the pump's innards travel back and forth as it pushes water way up the hill.

High Lifter Specifications

The cylinders are made of stainless steel, the valve body and head materials are machined from acrylic, and the pistons are made of high quality nylon. The total width is about 4 inches, length 26 inches, and the pump itself weighs about 5.5 pounds. The High Lifter is obtainable in two volumetric pump ratio models, 4.5:1, and 9:1, and changeover kits are available to switch back and forth. The higher the volumetric ratio, the greater the pumping pressure and the lower the output flow.

FOR 9:1 VOLUMETRIC RATIO PUMPS

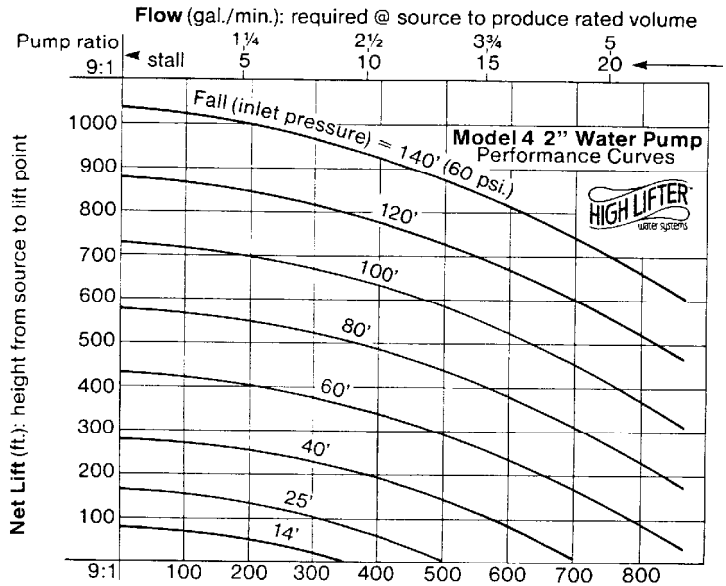

1 psi = 2.3' Delivery (gal./day): assuming adequate water @ source

Typical applications

According to the Owner's Manual, the High Lifter can deliver up to 750 or 1500 gallons per day, depending on the model. It can be used with flows as little as one quart per minute. It can achieve net lifts of up to 1,100 feet, depending upon the circumstances. In situations of low fall and high lift, two High Lifters can be used in series.

High Lifter Performance

When I took delivery of my High Lifter, I had nothing but problems. I thought I would be unable to recommend the pump in "Things that Work" because my test site seemed to put too much of a strain on the pump, causing it to stall out with regularity. After trying "everything in the book", and some things that weren't in the book, I took the pump back to Dave Katz's pump experts at Alternative Energy Engineering. (I like going there anyway because they have so much neat renewable energy stuff to look at.) There we discovered that some of the earlier pumps had been assembled with too much silicone glue between the barrel and the valve body. The excess silicone had slopped over to partially plug the pilot valve holes. They gave me a recently rebuilt pump since they didn't have a new one ready to give me.

I installed the newly rebuilt pump, and 30 hours later I checked my previously empty tank. I was totally amazed to discover that the 250 gallon tank was completely full! At that point I began keeping track of the flow: it was an remarkable 240 gallons per day. Two weeks later the

FOR 4.5:1 VOLUMETRIC RATIO PUMPS

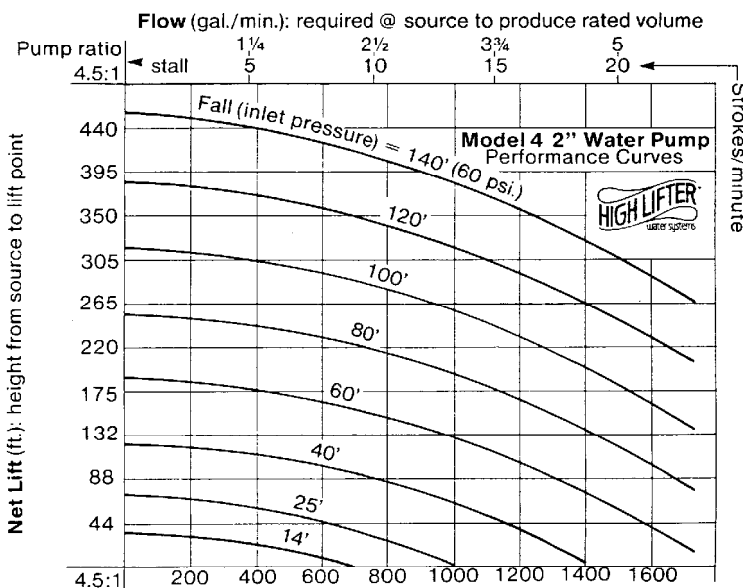

1 psi = 2.3' Delivery (gal./day): assuming adequate water @ source

Things that Work!

flow had decreased to 218 gallons per day so I cleaned the inlet filter. Now that the pump was broken in and the filter cleaned, my flow increased to 294 gallons per day! It seems to have settled in at between 220 and 300 gallons per day, depending on how clean the input filter is.

High Lifter Advantages

The advantages of the High Lifter over the ram pump are numerous. The pump is more efficient in that it uses less water to pump a given amount uphill. Additionally, it is a far piece quieter than the constant and very noisy KA-CHUNK of the ram, and it is quite a bit lighter and easier to move around than the ram. Last, but not least, the High Lifter will operate with relatively thin wall pipe in the input, whereas a ram, because of the intense and constant hydraulic hammering caused by the sudden closing of the impetus valve, requires solid mounting and steel pipe to keep from breaking apart joints.

The High Lifter is not without its disadvantages, though. It has a complex array of pilot valves and check valves, and relies heavily on close tolerance seals. Unlike the ram pump, water must be completely free of sand and grit lest

the barrels and seals become scored allowing leakage. The High Lifter comes with a filter which takes out much of the harmful sized particles which may flow from your water supply. The filter must be cleaned regularly to avoid loss of inlet pressure. If a lot of foreign matter flows with your water, then the High Lifter may not be for you.

The Owner's Manual states that there is a danger that a hard knock to the valve body could cause a misalignment, but personal experience proved that it takes 2 large, strong people to successfully dislodge the glued and strapped valve body from the barrel.

Conclusions

The High Lifter has far exceeded my expectations, and definitely lives up to its promises. It is worth the \$750. price tag, which includes access to the manufacturer who is willing to go the extra distance to help their customers.

Access

Author: Michael Welch, C/O Redwood Alliance, POB 293, Arcata, CA 95521 • 707-822-7884.

Manufacturer: Alternative Energy Engineering, POB 339, Redway, CA 95560 • 800-777-6609.



Carlson
Communications

Team Up With
The Future
At The

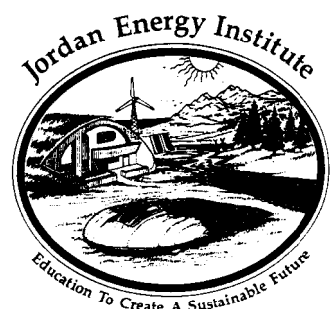

1, 2 & 4 Year Degrees:

- Renewable Energy**
(Solar, Wind, P.V., Biomass)
- Applied Environmental Technology**
- Energy Efficient Construction**
- Electric Vehicles**
- Energy Management**

155 Seven Mile Road
Comstock Park, MI 49321

(616) 784-7595

No reason not to run your battery system at 120VDC, Ben. Just keep in mind that all your switches, fuses, etc., must be rated at 150 VDC or better. 120 VDC is just a nominal battery voltage. The actual voltage of a fully charged 120 V battery system will be pushing 140 VDC or more. Finding a 120 DC to 120 ac inverter is a little trickier. Try Chad Lampkin at Michigan Energy Works- (616) 897-5161. By "mechanical" I assume you mean a motor/generator type? They do work and have the added advantage of producing a true sine wave, but are pretty inefficient compared to today's FET based units.

Running a water pump "backwards" in a closed system as you describe can produce power, but unless we're talking about lots and lots of water, not very much. The push-pull that you describe only works if the water is flowing freely out the bottom end of the line at near zero pressure. That's fine if you are just using the water to fill a pond or something, but if you expect to use the water under pressure, you would be better off directing the tailwater after it freely exits your runner into a catchment and starting over from that point. - Bob-O

Solar Help

Dear HPM Staff, Thank you for this great magazine! Please renew our subscription for two more years.

We have been off the grid since 1974 and we have been using solar electric since 1982, and we love both. My husband is disabled with multiple sclerosis. He has been working on some solar electric devices to help other disabled people be more independent in the backwoods. As I am pressed for time I will not elaborate now, but if anyone is interested I will gladly write more. Sincerely, Lu Marie & Michael Strickland, Dearborn Solar Electric Co., Rt. 1 So., Box 2364, Cascade, MT 59421

We salute you, Michael & Lu Marie. Independence enriches any life, renewable energy enriches the earth. Keep us up to date on your projects - Kathleen

Ram Pump

Dear HP, I read with interest the article in HP #23 on the high lifter pump. I agree that in many applications this pump is the best way to go. However, in the list of advantages there are some not always true statements. While in some situations the high lifter would be more efficient than a hydraulic ram, this would not be the case if the ram were installed correctly. I operated a business here in Missouri building, servicing and installing hydraulic rams for 10 years and am known as the local ram expert. We have used hydraulic rams to pump our water since 1979 and still do. The hydraulic ram water pump was invented in the late 1600s and is still used, mostly in

developing countries where power is not available. In 1979 I attended a workshop on hydraulic rams at New Life Farm in Drury, Missouri where we designed, built, and tested over 10 different hydraulic rams. The efficiency of most rams we built was over 80%, with one model having an efficiency of 95%! The efficiency was measured by measuring the amount of water used to operate the rams times the feet of fall used to operate the ram to give us the number of foot pounds of water used. We then measured the pounds of water delivered times the height the water was pumped to give us the foot pounds of water pumped. Dividing the foot pounds delivered by the foot pounds used actual efficiency was obtained.

For example, one test used 40 pounds of water per minute with a supply head of 6 feet for $40 \times 6 = 240$ foot pounds of water. The pump delivered 5 pounds of water to a height of 40 feet for $5 \times 40 = 200$ foot pounds of water. The efficiency was in this case $200/240 = 83\%$ efficient. Most pumps scored 90% or better. The only one less than 80% was the plastic pump published many years ago in Mother Earth News which didn't work at all, probably due to poor construction or materials. I used the design we decided on as the best for 12 months here at home using 15 feet of head pumping 75 feet before the impetus valve required replacement.

Using the figures in the article to calculate the efficiency of the high lifter as follows. Six gallons per minute and 26 feet of head gives $6 \times 26 = 156$ gallon feet of water used. Delivered is 0.166 gallons per minute and $132 + 26 = 158$ feet height gives $0.166 \times 158 = 26$ gallons feet of water delivered. The efficiency for this application is therefore $26/156 = 17\%$ efficient.

I definitely do not want to imply that the high lifter is not a good pump. I can see that in many cases it would be a better pump than a hydraulic ram. It does have many other advantages as listed in the article. An efficiency of 17% is actually very good for this type of pump. The efficiency of hydraulic rams can be this low or lower if improperly installed or if there is something wrong with the ram. If anyone has trouble with their ram feel free to call me at 417-683-3570. Written responses please include a stamped self-addressed envelope and \$10 per response. For plans to build a ram from metal pipe fittings send \$5. Dave Luckenbach, Rt 1 Box 393, Ava, MO 65608

Solar Anthem

Dear Home Power Persons: Here is the new Official National Anthem of the Solar Power Movement. The song is intended for solo and group singing at all gatherings of

will have to wait and see how they are coordinating the subscriptions with you folks.

Sometime this next year I will be adding solar to heat our water but currently I'm just looking to see what's out there. One thing I have noticed is all the units use electricity as a backup. Why no gas fired units? Probably I will put in a system with no backup, just a 120-gallon storage tank, and installing some of the inline on-demand tankless water heaters to make it hotter if necessary.

Also inclosed is a copy of the reader survey from HP#27, my 1st issue to warrant a mailing label. To add an additional option I would be willing to pay \$20-\$30 for B&W reprint of the original masters of issues 1-10 if it were offered. In the survey you don't make it clear what dollar amounts by each format choice mean. Are they your costs or approximate costs to the purchaser. Assuming your costs I'd say \$30-\$50 is what I'd pay. If just estimates I'd drop to \$20-\$35.

Just got my copy of the 1990 Alternative Energy Source Book from the folks at Real Goods and recognize many articles as reprints from Home Power. I was especially pleased to find an article from Richard with Lead-Acid charge/discharge curves. Good luck to all and keep up the good work.

P.S. On page 28 of HP#27 the picture was printed upside down so left and right are reversed. Oops. Don't let it bother you too much most people will spot it and occasional slips like that remind us we're human and to watch out for Murphy. Michael Kline, 2932 Hyder SE, Albuquerque, NM 87106 • 505-277-8148-Work, Internet mail - mikep@triton.unm.edu, bitnet mail - mike@unm

An easy way to tell if you're getting burned on the "C cell in a D cell" package scam is by weight. Heft the 2 D cell package in one hand and a 2 C cell package in the other. The D cells should be noticeably heavier. If not, the fix is in. Bob-O

Hi, Michael. We too noticed that DHW heat exchanger tanks are only fitted with electric power for backup, not propane. Consider using the less efficient tube-in-tube heat exchanger to interface with the propane hot water heater/tank. Be sure to insulate the exchanger/pipes well, and use a circulating pump on the exchanger/propane heater loop. The Thermomax setup in Bob-O's home uses this technique to interface solar heated water with a propane fired backup. Richard

Hello, Michael— Thanks for returning your survey (there's still time for those of you who have not!!) The prices are guestimates of cost to you, the reader. The next issue of

HP will have the findings from the survey. We noticed the reversed photo, too; the printer was a little rushed last issue. Ah well...Therese

High Lifter Pump Data

Dear HP: As the author of the "Things that Work" article on High Lifter pumps (HP#23), I'd like to respond to the letter from Dave Luckenbach as published in HP #26. Dave's letter put into question the efficiency of the High Lifter as opposed to ram pumps.

First of all, there was an error in the way I described my test site. I stated that 6 gpm flowed through my supply pipe to the High Lifter, and Dave's efficiency calculations were based on that amount being used by the pump. Actually, at that time, 6 gpm was flowing into my settling tank from my spring but only a small portion of that was needed to supply the High Lifter. Further development to improve the cleanliness of my spring water reduced the flow to under 2 gpm, still more than enough to feed the High Lifter.

I went back and did some more measurements to come up with an efficiency figure for the pump, which ended up being 78.6%. First I shut off the supply to the pump and carefully measured the total flow from my source tank, then I restarted the pump and measured the unused overflow from the tank. Subtracting, I deduced that the pump was using 1.19 gpm as its supply. Next, I measured the pump output at my storage tank above my house to be 0.154 gpm. I then calculated pump efficiency according to Dave's method: $1.19 \text{ gpm} \times 26 \text{ ft. head} = 30.94 \text{ gallon feet of water per minute used}$; $0.154 \text{ gpm} \times 158 \text{ ft. delivery height} = 24.33 \text{ gallon feet per minute of water pumped}$. Therefore, $24.33 / 30.94 = 78.6\%$ efficient.

Second, based on my experience to date, the High Lifter pump appears more suitable than ram pumps in low flow situations. The pump I used previous to the High Lifter was a Davey ram. This pump needed the entire 6 gpm my spring originally put out, and still would pump less than 175 gallons per day or 0.122 gpm. Admittedly this pump's impetus valve was very worn from years of debris flowing through it, and not a fair representation of a new ram pump. In recent months I have been testing a new, commercially available ram pump installed according to manufacturer's instructions, and have not been able to make it run on less than 2 gpm. I have not, however, given up on its potential for applications similar to mine. As I continue to experiment with non-electric pumps, I'll keep you posted on positive results.

My conclusion is that a ram pump is likely to be as or more efficient in higher flow situations, but the High Lifter

appears to be more appropriate for those of us with low flow situations and debris-free water supplies. Michael Welch, c/o Redwood Alliance, PO Box 293, Arcata, CA 95521 • 707 - 822 - 7884

Hydromaniac

Dear friends; I haven't even finished reading your magazine and I'm already subscribing. I am enthused to read about different aspects of hydro usage as I am a hydromaniac. In the 5 years that I have been using our hydro, I have come from "So what is an amp?" to redesigning our entire system with my partner. I've had many challenges such as chipping ice out of a frozen hydro at minus 30°F every day for a week and yearly, climbing into and cleaning out a 4' deep, 3' wide well casings full of silt and debris. Being a conservationist, I decided to use an existing system which was anything but optimum. Thanks to my partner and Steve Willey (Backwoods Solar), my spirit endured and our power grew. Your magazine is inspiring as well as informative to a lay person as myself. For me, being self-reliant and respectful of Earth means using her resources efficiently and purposefully. I would like to see articles about the spirit that drives us to be inventive, visionary and enduring in our goals of living harmoniously with Nature. Abundantly, Noreen Wenborne, 9465 Rapid Lightning Rd., Sandpoint, ID 83864

I have admiration for you, Noreen. You have obviously grown in the last 5 years. In response to your comment about the spirit of RE users I think you will be interested in the following letter. - Kathleen

IEAN

Dear Home Power Editor: Please allow me to introduce myself. My name is Carolyn Erler. I am director of Independent Environmental Artists Network, a new organization dedicated to people who work with environmental elements as art, and who primarily do this on their own time, i.e., most are not actively seeking publication of their works, but are in need of correspondents for feedback. As for our members, a willingness to communicate, an enthusiasm for pooling ideas and sharing experience, is the only requirement for involvement. We are people – artists, though representing a rich diversity of professional backgrounds – who are not only exploring the boundaries of what constitutes an art form, but are also striving to assume a broader role in regards to the whole of nature.

Being that the term "environmental art" seems to mean so much to so many these days, it would no doubt be helpful to you if I specified the kind of creative worker IEAN is seeking – although, please, what is mentioned below

should be taken merely as a set of focal points.

- Home-made passive energy installations: appliances, dwellings, related creative conceptualizations.
- Creative stonemasonry.
- Micro/macro organic and-or "found" architecture.
- Original thoughtwork regarding that which may, in an enlarged sense, be seen as aspects of an overarching, autopoietic Geo-art. Some examples: rock metamorphism, the carbon cycle, petroleum formation, chemosynthesis, space lattices, symbiotic alliances, microbial mats, dissipative structures, bioluminous cells – the universe is the limit! We seek active, enthusiastic correspondence among workers in these general fields. The working goal of Independent Environmental Artists Network is for it to evolve into an art itself. This means an on-line art composed of creative workers communicating, resonating, breaking out of old patterns of competition and silence.

While searching for various avenues through which possible contacts might be found for IEAN, I was made aware, through the Planetary Association for Clean Energy, Inc., of Home Power magazine. As a service both to myself and to those associated with IEAN, I was wondering if you might be able to send us any material (resource/address lists, sample issues, etc.) which could prove beneficial to this community of creative workers. Also, if you happen to know of someone among your friends and associates who is working in one of the above-mentioned areas, please urge them to write me at the address below.

Thank you for your time, and for whatever you might be able to send our way. Sincerely, Carolyn Erler, Director, Independent Environmental Artists Network, POB 396, Rochester, New York 14603

Consider the word spread, Carolyn. - Kathleen

Working System

Having installed and maintained a stand alone system here for 3 years, I am glad for any opportunity to share what I have learned with others interested in home power. You can give my name, address and number to anyone in this area wanting to see home power. An electric vehicle has to come next!

You serve as a guide and mentor for me as for so many others. Each issue an inspiration - when HP comes in the mail becomes for me a moment of rededication to earthkeeping. Thanks, Rich Meyer, 13416 CR 44, Millersburg, IN 46543 • 219-642-3963

Thank you, Rich. Here is the name, address, and number for interested parties near you. - Kathleen

N. Collier, Publisher

Links to sites hosted or produced by us.

[Flomaton Antique Auction \(.com\)](#)

We provided domain, hosting, photos, webcam and programming.

[Artifacts Colonial Florida Museum \(.org\)](#)

We provide domain, hosting, photos and technical assistance.

[Circa 19th Century Antiques \(.com\)](#)

We provide hosting, domain, photos and programming.
(Shop is closed due to Hurricane Ivan, but they can still locate your fine
antiques.)

[The Bogia Tractorworks \(.us\)](#)

Old tractors! Hosting, domain, photos and programming (in progress.)

[Information Specialists, Private Investigations \(.com\)](#)

We provide domain, hosting, and some of the programming.

[Flomaton, Alabama \(.com\)](#)

Hosting, domain, photos and programming (in progress.)

[Suncoast Systems, Inc. \(.com\)](#)

We provided photos and programming for non-public pages.

Any features or effects seen on these sites can be made available to your

site.

[Sites](#) [Contact](#) [Photography](#) [Webcams](#) [Links](#) [Advertising](#) [Home](#)

Page updated January 2005
Copyright 2005 by N. Collier, Publisher.

N. Collier, Publisher

Our Address:

**3251 South Pine Barren Road
McDavid, Florida 32568**

Our Phone:

850-256-4045

Our E-mail:

neal at ncollier.com

We avoid proper syntax on the email address to prevent spammers from harvesting and spoofing our address to send spam. We do not spam! We are taking measures to prevent spammers from marring our good name by sending you junk and porn with our name on it.

We are located about 1 hour north of Pensacola, 2 hours south of Montgomery and 2 hours east of Mobile.

[Sites](#) [Contact](#) [Photography](#) [Webcams](#) [Links](#) [Advertising](#) [Home](#)

Page updated January 2005

Copyright 2005 by N. Collier, Publisher.

N. Collier, Photographer



We have years of experience doing product photography for the internet and for print. We also sometimes do portraiture, weddings and architectural photography with the understanding that we do it OUR WAY. We mostly shoot digital but have cameras in more formats than there are available films, including [panoramic](#). In our work with museums, we have become quite accomplished at photo restoration.

We have an extensive stock photo collection of antiques available!

Our photos have been featured in: Maine Antiques Digest, Cotton and Quail,

Antique Week, The Tri-City Ledger, Orange County Home, Antiques and the Arts Weekly, Art and Antiques Magazine, A Pictorial History, A Sawmill Scrapbook (3 Volumes), Antique Trader, The Brewton Standard, numerous catalogs, brochures and websites.

This page is still under construction. Watch for a gallery of examples in the future.



We usually use a Canon 20D, D60, or D30, but have many film formats available.

[Sites](#) [Contact](#) [Photography](#) [Webcams](#) [Links](#) [Advertising](#) [Home](#)

Page updated January 2005
Copyright 2005 by N. Collier, Publisher.

N. Collier, Publisher

We Provide Webcams and Webcasting.

We can provide webcam services for your website or private broadcast. There are several types of webcam services available, each with particular advantages and disadvantages.

In the example below, still photos are pulled from the auction house video feed into a laptop where the image is processed. The image is then sent via a WiFi wireless link to the house network and relayed to the website through the DSL line. This is repeated at whatever interval is set in the programming. An applet on the viewer's computer pulls the images from the website at intervals.

Shuffling the image around can sometimes create a lag of several minutes, but there is little traffic on the DSL line, which must be available to provide online bidding updates. We combine this applet with the Ebay applets to provide realtime bidding info and nearly live house views. A thousand viewers can be online and not slow down our local DSL speed.

When available, this feed comes from [Flomaton Auction](#)

Another method we have used gives the viewer direct access to that laptop. This requires a fixed IP address, which can cost more from your ISP, but the photo updates can go much faster. This is great if you do not have many viewers or if you have warp-speed internet connection. If your website hosting price is based on metered service, those pictures being pulled directly from the computer at the camera are not counted against your website quota!

Yet another method employs streaming to provide true- or near-video rate images and sound. Because of processing, this is still not quite live, but pretty close. This can be done on ordinary dialup if you have only one viewer and have low resolution settings. To serve many viewers with high quality feeds you can use a relay server service. With ordinary connections, this type of cam is good for company broadcasts and teleconferencing.

Webcams do not necessarily have to be public or even be related to a website. For home or office security, a webcam can allow you to view the camera from anywhere in the world. Both live and archived pictures can be made available.

Ask us about your webcam needs.

[Sites](#) [Contact](#) [Photography](#) [Webcams](#) [Links](#) [Advertising](#) [Home](#)

Page updated January 2005
Copyright 2005 by N. Collier, Publisher.

N. Collier, Publisher

Links to sites not produced by us containing our photography or books.

[The Alger-Sullivan Historical Society](#)

We provided books, photos, and articles.

[A Colonial Florida Web Museum](#)

We provided photos and technical assistance.

[Prices for Antiques](#)

We provide photos of antiques sold at [auction](#).

[Live Auctioneers Online Auction](#)

We provide photos used in online auctions.

[HOME](#)



N. Collier, Publisher

Advertising



Flomaton
Antique
Auction
Since 1967

Friday, May 14th at 5 p.m.
Saturday, May 15th at 10 a.m.

Hundreds of Fine American Antiques

P.O. Box 1017, Flomaton, AL 36441
On AL/FL line North of Pensacola, FL

251-296-3059

Herbert & Nevin Heller #468/1094

www.FlomatonAntiqueAuction.com

Visit Our Website
for Photos
and Information

We can help design and publish all sorts of print advertising. We will prepare brochures, booklets, newspaper and magazine ads for you.

[HOME](#)

N. Collier, Publisher

WE SERVE NORTHWEST FLORIDA and SOUTHWEST ALABAMA and HERE'S WHAT WE CAN DO FOR YOU

Business Publishing

We can create a catalog of your products. We can produce instruction manuals to go with your products. We can provide databooks to explain your product line. We can handle it, from planning to production. We have established a relationship with several printers who do quality work at reasonable prices. We can also provide these books as e-books. This means your customer can get your books at any time from the Internet and you have no printing or postage costs! We can provide you with a sample.

Product Photography

Visit the web sites linked from our home page. Many of the photographs of products, artifacts and antiques were photographed by us. We can work in almost any digital and film format, including panoramic and [360](#). You may have seen our photos in newspapers and magazines across the country or websites around the world. Click the **Photography** button for examples.

Web Services

We are a brokerage for web site hosting and banner advertising. We also provide site construction services. We can assist in site planning and promotion. We have established a network of talented individuals who can satisfy virtually every web programming need. Are you uncertain as to whether a web site can benefit your company? We can help you evaluate the need. You **DO NOT** have to sell on the web to have a web site that pays its way!

While we don't have much in the way of frills, here, this site is a gateway for our operations and base for programming and marketing experimentation. If you find some odd things on our site and wonder why they are there, most are experimental traffic builders. A web site **MUST** be marketed and these little experiments help us find the ways that work. Besides, some are fun.

Web hosting starts at less than \$100/year, including domain. Qualified sites (those that give us a lot of programming business) are free! Click the **Web Sites** button for examples.

Book and E-Book Publishing

Our current commercial workload precludes us from taking on new book projects. We currently have several books in the works (and admittedly overdue): "Facing The Music," is a gripping action-adventure novel about a musician who takes on a drug cartel. "Pemmican Packstrap: A Funny Thing Happened On The Way To Maine," is a true adventure story of a mother-and-son team that set out to hike the Appalachian Trail. "Ox-Cheek Soup and Other Favorites," which is not your ordinary cookbook, combines old recipes, holidays and traditions with an offbeat view of history. "La Relacion" is a true adventure story of a ship-wrecked Spanish adventurer who was captured by the Indians 450 years ago.

Books in print include ["A Sawmill Scrapbook" \(Vols. 2&3\)](#) and ["A Pictorial History--- Settlements on the Escambia-Conecuh River."](#) available from [The Alger-Sullivan Historical Society](#)

Print Media Advertising

We have worked with numerous magazines and newspapers around the USA, providing advertising layout work. Click the **Advertising** button for an example.

Webcams

Be seen around the world! We can provide your site with webcam and webcast capability. Click the **Webcam** button to learn more.

[Sites](#) [Contact](#) [Photography](#) [Webcams](#) [Links](#) [Advertising](#) [Home](#)

Page updated January 2005
Copyright 2005 by N. Collier, Publisher.

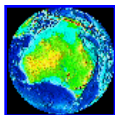

John Bamford & Associates

The Home Page



This internet site provides information about the business and other interests of John Bamford & Associates and family members.

Details of the Bamford "Hi-Ram Pump ®", a new and simple pump powered by water, are on the link below.

[\[Hi-Ram Pump\]](#) [\[pump.com.au\]](#) [\[Internet and Domain Names\]](#) [\[Latest News\]](#)

[\[Professional Experience\]](#) [\[Genealogy\]](#) [\[Bamfords.Info\]](#) [\[Vehicles\]](#) [\[Items for Sale\]](#)

[\[St Barnabas Parish\]](#) [\[Yass Chamber of Commerce\]](#)

If you have received spam showing a bamford.com.au email address, please read [Spooing or Forging of our Email Addresses](#)

Email bamfords@bamford.com.au

[Home Page](http://www.bamford.com.au) <http://www.bamford.com.au>

Bamfords, Post Office Box 11, HALL ACT 2618, AUSTRALIA

Phone +(61 2) 6227 5532 Fax +(61 2) 6227 5995

Bamford Industries NSW BN97702171, and John Bamford & Associates NSW L8632225

bamford.com.au™ is a Trade Mark

Copyright ©John Bamford & Associates 1998-2004

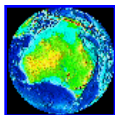

The Bamford "Hi-Ram Pump"®

Latest News

[\[Introduction\]](#) [\[Latest News\]](#) [\[About the Pump\]](#) [\[Questions & Answers\]](#) [\[Prices\]](#)
[\[Pump Installation\]](#) [\[File Downloads\]](#) [\[New Applications\]](#) [\[Links\]](#) [\[Contact Us\]](#)

Change of Main Pump Email Address

We have had to change the main email address for pump correspondence to reduce the effect of spam on the receipt of legitimate email. The new address is given at the bottom of the page.

The previous email address remains in place, but is subject to increasingly severe filtering which may result in some valid email messages being automatically deleted.

Email addresses within [YYezz.Net](#) are also in use with the changed email arrangements, particularly for autoresponder messages.

17 July, 2004

Availability and Price of Hi-Ram Pumps

Production pumps are available as a basic water pump, of the type shown on the "Introduction" page.

The 25 mm or 1 inch version of the basic pump (less the drive pipe assembly etc) is available at the recommended retail price of \$330 Australian, plus any dispatch costs involved. This price includes an Australian Government Goods and Services Tax (GST) of 10% . GST does not apply to pumps supplied outside Australia.

Distribution within Australia includes direct sales using parcel post. The pump weighs between 3 and 4 kilograms and goes in a box 310mm X 225mm X 102mm (an A4 size box). For direct sales, the dispatch costs to Australian addresses include handling, postage, packing, and insurance. These dispatch costs including GST are currently to NSW \$14, VIC \$17, QLD \$21, SA \$21, NT \$25, WA \$26, TAS \$22.

The pump and its drive pipe must operate together for the pump to work properly, and the drive pipe can be thought of as "half" of the pump. The use of a steel drive pipe is recommended

wherever possible.

There are so far no distribution arrangements in most countries overseas from Australia, although individual orders can be accepted. With the cost of economy air post included, the delivered cost of a pump is very competitive with alternative pumps available in many other countries. For overseas orders, if there were any other charges that are required by your country you would need to pay these yourself.

If you wish to order a Bamford Pump, please contact us (preferably by email) for more information about local retailers of the Bamford Pump, dispatch details, and alternatives for payment.

We are sorry that the prices above represent an increase from 1 December, 2004. Orders placed before that date will be supplied at the previous prices.

1 December, 2004

Email hi-ram@bamford.com.au

Bamfords, Post Office Box 11, HALL ACT 2618, AUSTRALIA

Phone +(61 2) 6227 5532 Fax +(61 2) 6227 5995

Bamford Industries NSW BN97702171, and John Bamford and Associates NSW L8632225

"Hi-Ram Pump" is a Registered Trade Mark

Copyright ©Bamford Industries 1999-2004

[Home Page](http://www.bamford.com.au) <http://www.bamford.com.au>

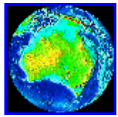

The Bamford "Hi-Ram Pump"®

About the Pump

[\[Introduction\]](#) [\[Latest News\]](#) [\[About the Pump\]](#) [\[Questions & Answers\]](#) [\[Prices\]](#)
[\[Pump Installation\]](#) [\[File Downloads\]](#) [\[New Applications\]](#) [\[Links\]](#) [\[Contact Us\]](#)

About the Bamford "Hi-Ram Pump"®

Development of the Bamford Hi-Ram Pump started in the Australian summer of 1997/98, following drought conditions and a shortage of water on a farming property. Although there was a stream of flowing water, it was unused because of the low rate of flow, the lack of electricity, and the difficult terrain. Normal methods of pumping water were simply not suitable.

Other ways of getting water from the stream were considered, particularly ways using the energy of flowing water to drive a pump. Attempts to construct and use a traditional hydraulic ram pump were marginally successful. The search for a simpler way led to the development of a new type of pump.

A diagrammatic installation for a Bamford Hi-Ram Pump to pump water is shown below. This is similar to the installation of a hydraulic ram pump, and a Bamford Hi-Ram Pump will typically work where other hydraulic ram pumps will work. Recommendations for pump installation are covered in more detail in the section "Pump Installation".

A Bamford Hi-Ram Pump can also work where other hydraulic ram pumps will not work. Its design also allows it the alternative roles of producing compressed air, or providing a mechanical output to operate other devices.

Bamford Hi-Ram Pump

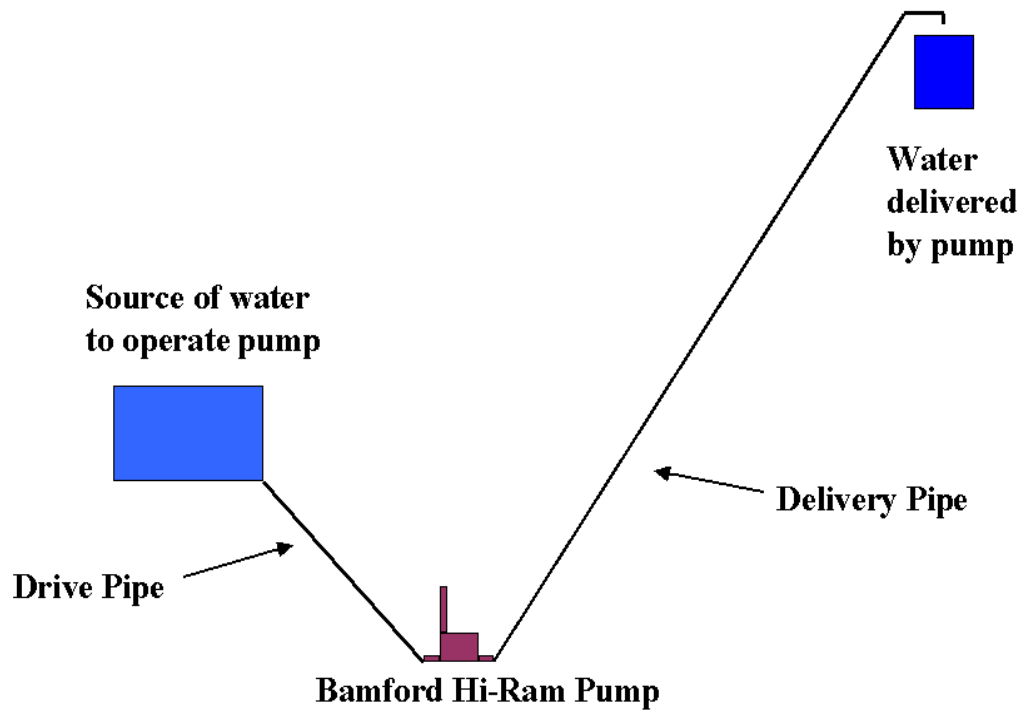

To work as a water pump, the Bamford Hi-Ram Pump needs a source of water above the pump. This can be from a stream or river or other source, so that water enters the pump through a Drive Pipe. A typical head of water to operate the pump is about two meters, although smaller and larger heads are also suitable. The characteristics of the Drive Pipe are most important in the operation of the pump.

Waste Valve Mechanism

“Hi-Ram Pump®” - Australian Patent No 741898

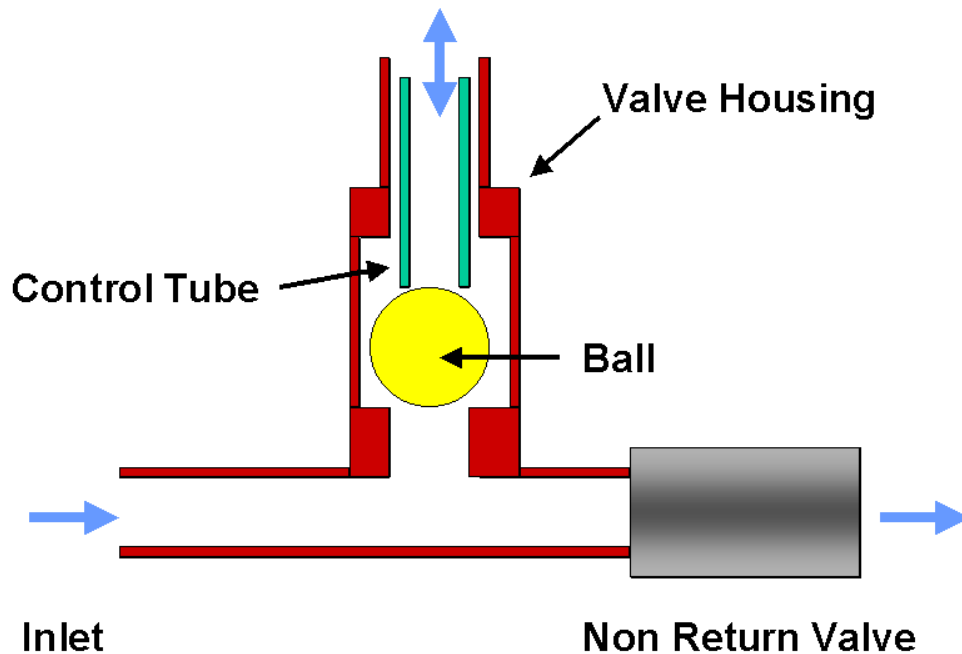

Copyright © Bamford Industries 2003

At the beginning of the operating cycle, water starts to flow through the Drive Pipe and goes to waste through a Waste Valve. The flow of water then increases, until the Waste Valve closes and suddenly stops the flow of water. The result is a "water hammer", which causes a high pressure inside the pump, so that water is forced past an Outlet Valve (Non Return Valve) into the Delivery Pipe. As the operating cycle continues, the pressure inside the pump drops and the Outlet Valve closes.

There is then a "rebound effect", and the pressure inside the pump further drops to below atmospheric pressure. During this part in the operating cycle, air can be brought into the pump by the use of an optional one way valve.

The pressure inside the pump will then increase because of the head of water from the entry to the Drive Pipe. Another operating cycle begins with water going through the Waste Valve, and so on.

A typical cycle time for a small pump is about one second. Most of the water entering the pump goes through the Waste Valve, the remainder being pumped up the Delivery Pipe. In a typical installation, the waste water can be diverted downhill to rejoin the river or stream from which it came. However, the design of the Bamford Hi-Ram Pump also allows waste water can be piped away for other uses, which could include operation of a second pump in series with the first.

In its simplest form, the Bamford Hi-Ram Pump will operate without an air reservoir or other

means to smooth the pressure pulses of water going into the Delivery Pipe. While this may require a stronger Delivery Pipe, in many situations the simpler pump is preferable.

Optional components can be fitted to improve the efficiency of the pump or to provide for its alternative roles, but at increased cost. One option is to fit a pressure cell pre-charged with air to smooth out pressure variations in the Delivery Pipe. Such pressure cells are widely used in other pumping applications, and typically have a flexible diaphragm to separate the air and water.

As described above, the pressure inside the pump drops below atmospheric pressure during part of the cycle of operation. If a one way valve is fitted, air can be drawn into the pump, so that air is then pumped through the Outlet Valve with the water. An optional pressure vessel can then be fitted near the pump outlet to automatically fill with air and smooth out pressure variations in the Delivery Pipe.

The pump can take in much more air than is needed to fill such a pressure vessel, in which case excess air simply goes up the Delivery Pipe. This is how the Bamford Hi-Ram Pump can provide compressed air, as air going through the Outlet Valve is at the same pressure as the water that it accompanies. If the main purpose of the Bamford Hi-Ram Pump is to supply compressed air, water need not be pumped anywhere provided the pump does not fill with air to stop the cycle of operation.

Although the optional components are not shown, the pressure changes in the pump from cycle to cycle can be used to operate other devices. This may provide an opportunity, for example, for a Bamford Hi-Ram Pump to drive a separate reciprocating pump and supply clean drinking water from another source.

The basis of the Bamford Hi-Ram Pump is a new waste valve mechanism with two moving parts, both of which can be easily removed. Alternative valve parts can therefore be used to provide rapid adjustment for different inlet and outlet heads, and for different water flow rates in and out.

The Bamford Hi-Ram Pump can produce high pressures from low flows of water at a modest head. The design of the pump allows construction in a range of sizes and of alternative materials to suit different operating conditions.

While its original development was for pumping water, the alternative roles of the Bamford Hi-Ram Pump considerably extend its usefulness. It can be useful in a variety of ways where the energy in a flow of water or other fluid is otherwise going to waste. Its simplicity and flexibility therefore offer the potential for new domestic, industrial and rural applications in both developed and developing countries.

Email hi-ram@bamford.com.au

Bamfords, Post Office Box 11, HALL ACT 2618, AUSTRALIA

Phone +(61 2) 6227 5532 Fax +(61 2) 6227 5995

Bamford Industries NSW BN97702171, and John Bamford and Associates NSW L8632225

"Hi-Ram Pump" is a Registered Trade Mark

Copyright ©Bamford Industries 1999-2004

[Home Page](http://www.bamford.com.au) <http://www.bamford.com.au>

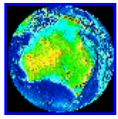

The Bamford "Hi-Ram Pump"®

Questions and Answers.

[\[Introduction\]](#) [\[Latest News\]](#) [\[About the Pump\]](#) [\[Questions & Answers\]](#) [\[Prices\]](#)
[\[Pump Installation\]](#) [\[File Downloads\]](#) [\[New Applications\]](#) [\[Links\]](#) [\[Contact Us\]](#)

Questions and Answers.

How many sizes of Bamford Hi-Ram Pump are there?

There is one size initially, normally using a 25 mm drive pipe. While the operating principle of the pump applies to larger pumps, this version is the one with the widest usage.

What head of water is required to operate the Bamford Hi-Ram Pump?

The pump will operate with a 1 metre drive head of water. However, 1.5 metres should be regarded as the normal minimum drive head, and where possible 2 metres or more should be used. For a given flow of water to drive the pump, the higher the drive head the more water will be pumped into the delivery pipe.

The pump is set up to work best with drive heads between 2 and 6 metres, although higher drive heads can be used in some circumstances.

How high can the pump raise water?

A drive head of 2 metres of water can achieve an output head of over 100 metres, and a drive head of 1.5 metres can give over 50 metres output head. The quantity of water delivered at these maximum heads is small. Except in special circumstances, a realistic working height would be about 60% of the maximum possible height.

For drive heads over 2 metres, greater output pressures can be achieved.

How much water will the Bamford Hi-Ram Pump pump?

About 1500 litres of water a day can be lifted 20 metres from a drive head of 2 metres and an inlet

flow of 20 litres a minute.

The amount pumped will be more for higher drive heads and lower output heads. The water flow rates in and out of a particular pump will also vary with the pump installation, and are further dependent on the drive pipe and the drive head.

How can the pump be adjusted for different operating conditions?

One of the two moving parts in the waste valve mechanism is a stainless steel tube that determines the flow of water through the pump. As this part is easily changed, a series of alternative tubes are used to adjust the amount of water that will go through the pump.

By this means, the pump is adjusted for best operation in each particular installation. The use of the alternative tubes also allows the pump to be "turned down", for example if the amount of water to drive the pump is reduced because of dry weather.

How important is the drive pipe in the operation of the pump.

The drive pipe is most important because its construction determines the magnitude of the "water hammer" during the operating cycle. This water hammer determines the maximum pressure that can be reached by the pump, and the amount of water that can be pumped. The pump should normally have an operating cycle time of about one second.

The Bamford Hi-Ram Pump can be used with a pre-fabricated drive pipe assembly, measuring about 1.75 metres by 0.75 metres by 0.1 metres when constructed of steel. Such a combination can be used to provide a "package pump" for "connection" to a suitable source of water.

Details for the construction of suitable drive pipes are provided with pumps offered for sale. The normal length of drive pipe shown in the instructions is around 10 metres.

When higher drive heads are used, for example 5 metres or more, the normal drive pipe may give a cycle time that is too short for the pump to run properly. If this happens it may be necessary to increase the length of the drive pipe which will increase the cycle time.

Must the drive pipe be made of steel?

Because of its rigidity, steel pipe gives the greatest water hammer effect, which provides the most efficient operation of the pump. The use of steel pipe is recommended wherever possible.

The use of high-pressure hard plastic pipe may be possible, but with significantly reduced performance. In some cases such plastic pipe may be preferable where the reduction in

performance is acceptable. For example, plastic pipe may be easier to install, and may avoid problems arising from corrosive water.

Normal agricultural plastic piping should not be used for the drive pipe. While it may operate with the performance reduced even more, the water hammer is likely to burst the pipe after a period of operation.

How should the drive pipe be installed?

The drive pipe does not need to be in a single straight line, or at any particular angle to the horizontal. For convenience of transport to the location where the pump will operate, the drive pipe can be assembled from shorter lengths of pipe connected together.

However, the drive pipe should be regarded as one aspect of the pump installation, which also involves the need to collect water and bring it to the pump. More details for pump installation are given in the section 'Pump Installation'

When a pipe is used to collect water to drive the pump, the entrance of the pipe is best located well below the surface of the water, in still water, away from the bottom, and with a filter. It is important to minimize the possibility of debris or air bubbles being drawn into the drive pipe.

For gently sloping ground, the distance from the source of water to give a drive head of about two metres can be much longer than the drive pipe length. In this situation, water can be brought along a feed pipe or channel to a relatively small header tank near the pump. A tank or drum of around 200 litres capacity is suitable. The drive pipe is then connected to this small tank in conjunction with a standpipe to give a suitable drive head for the pump.

As shown in the section 'Pump Installation', it is recommended that a standpipe always be used at the start of the drive pipe.

What happens if bubbles of air flow into the drive pipe?

Air bubbles reduce the amount of water hammer in the drive pipe. This will reduce the efficiency of the pump, or may cause it to stop.

Can a siphon over an embankment be used to work the pump?

While a siphon over an embankment may be satisfactory, try to avoid this arrangement because of the problems of establishing and maintaining a siphon.

Air nearly always collects in the siphon over a period of weeks or perhaps days. This reduces the

efficiency of the pump, and can cause it to stop unless the air is periodically flushed out.

What type of pipe should be used for the delivery pipe?

High-pressure piping, plastic or metal, is recommended for at least the first 20 metres at the pump end of the delivery pipe. Except for high lifts, agricultural grade plastic piping should be suitable for the remainder of the delivery pipe. If there is any doubt about the performance of agricultural grade plastic piping, high-pressure piping should be used for the full length.

Although the delivery flow rate is low, the minimum size recommended for the delivery pipe is pipe having an internal diameter similar to that of 25 mm (or 1 inch) metal pipe (i.e. around 22 mm or larger). This is because during pump operation there are pressure pulses that travel up and down the delivery pipe. High-pressure plastic pipe has thicker walls and a smaller inside diameter, and where used the next larger nominal size pipe should be selected (i.e. 32 mm high-pressure plastic pipe).

There is much to be said for the use of 40 mm delivery pipe which makes best use of the characteristics of the pump. In addition a 40 mm pipe is large enough for use with a powered fire fighting pump should you ever need a lot of water in a hurry.

It is normally necessary to restrain uphill sections of the delivery pipe, so that it cannot move downhill. If the delivery pipe is not restrained, the repeated pressure pulses coming from the pump will probably cause the pipe to "walk" downhill.

How do I start the Bamford Hi-Ram Pump?

Prior to starting the pump, water should be flushed through the drive pipe and the pump to ensure that no air is trapped between the source of water and the pump. Holding the waste valve mechanism open can do this. It can also help if the delivery pipe is not connected until after the drive pipe has been flushed out.

As part of the pump, there is a gate valve into which the drive pipe is connected. This gate valve can now be closed, so that the drive pipe remains full of water. The delivery pipe should be connected if this has not already been done.

The gate valve should now be opened to let water into the pump. The pump may start automatically, or the waste valve may simply close and prevent water flowing to waste. If necessary, the waste valve can be moved up and down by hand until automatic operation of the pump begins.

The pump requires a certain amount of back pressure in the delivery pipe for correct operation.

This is why manual operation of the waste valve may be necessary to initially build up some pressure in the delivery pipe. If the delivery pipe is long and sloping gently uphill, it may take a while to get sufficient back pressure.

Where the delivery head is small, in some circumstances the back pressure may not be enough for correct pump operation. If necessary this can be overcome by partially restricting the water flow coming out of the delivery pipe. However, there is an alternative drive pipe which is designed for installations where the delivery head is small.

Final adjustment for best performance should then be done when the delivery pipe is full of water and at operating pressure.

Once the pump is operating normally, and the drive pipe and delivery pipe are both full of water, the pump can be stopped and started as necessary by simply turning the gate valve off and on.

What does a normal operating cycle look like?

Each operating cycle normally takes about one second, with the water flow from the top of the waste valve housing starting and stopping as the waste valve opens and closes.

The stainless steel tube inside the waste valve housing goes up and down about 40 mm during each cycle. When a pump is initially being started, the tube might cycle up and down over a much shorter distance until the full outlet pressure in the delivery pipe is reached.

Email hi-ram@bamford.com.au

Bamfords, Post Office Box 11, HALL ACT 2618, AUSTRALIA

Phone +(61 2) 6227 5532 Fax +(61 2) 6227 5995

Bamford Industries NSW BN97702171, and John Bamford and Associates NSW L8632225

"Hi-Ram Pump" is a Registered Trade Mark

Copyright ©Bamford Industries 1999-2004

[Home Page](http://www.bamford.com.au) <http://www.bamford.com.au>

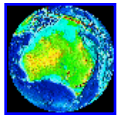

The Bamford "Hi-Ram Pump"®

Pump Installation

[\[Introduction\]](#) [\[Latest News\]](#) [\[About the Pump\]](#) [\[Questions & Answers\]](#) [\[Prices\]](#)
[\[Pump Installation\]](#) [\[File Downloads\]](#) [\[New Applications\]](#) [\[Links\]](#) [\[Contact Us\]](#)

Installation Details for the Bamford Pump

The installation and operating requirements for Bamford Pumps are covered generally in the Questions and Answers section of this Internet site. This section briefly covers a few further requirements.

The use of a suitable Drive Pipe correctly installed is essential for the pump to operate properly. Although the general principles always apply, each pump installation involves a unique set of circumstances that can only be addressed by those installing and operating the pump.

Before anyone installs a Bamford Pump for the first time, we strongly recommend that they temporarily set up a pump on flat ground and run it from an existing source of reticulated water. This can be done, for example, by connecting a garden hose to the Standpipe where inlet water normally enters to drive the pump. To start off, the pump outlet should also be blocked off (for example with a 1 inch plug) so that a back pressure is provided in the pump without any need to connect a Delivery Pipe. However, never block off the outlet if the drive head or length of Standpipe is more than 4 metres. This preliminary test allows the operation of the pump to be observed and understood under controlled operating conditions.

A file giving details of "Pump Installation and Drive Pipe Construction" can be found in the "File Downloads" link at the top of this page. If possible we suggest that you download this file for future reference.

A group of internet pages containing similar information is also available by clicking this link.
[Installation and Drive Pipe Construction](#)

Email hi-ram@bamford.com.au

Bamfords, Post Office Box 11, HALL ACT 2618, AUSTRALIA

Phone +(61 2) 6227 5532 Fax +(61 2) 6227 5995

Bamford Industries NSW BN97702171, and John Bamford and Associates NSW L8632225

"Hi-Ram Pump" is a Registered Trade Mark

Copyright ©Bamford Industries 1999-2004

[Home Page](http://www.bamford.com.au) <http://www.bamford.com.au>

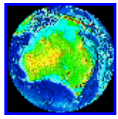

The Bamford "Hi-Ram Pump"®

File Downloads

[\[Introduction\]](#) [\[Latest News\]](#) [\[About the Pump\]](#) [\[Questions & Answers\]](#) [\[Prices\]](#)
[\[Pump Installation\]](#) [\[File Downloads\]](#) [\[New Applications\]](#) [\[Links\]](#) [\[Contact Us\]](#)

File Downloads

The following files may be downloaded for off-line viewing to assist those interested in the Bamford Pump. All files are copyright, and under no circumstances is a file to be altered in any way or used for other purposes.

The files may be updated from time to time, and you should check here to see if you have the latest version.

Depending on your computer and software:

If you click a link with the left mouse button, you may be able to open the file in a new window for viewing with your Web Browser.

If you click a link with the right mouse button, you should be able to save the file for later viewing.

Files are in Adobe Acrobat pdf format

[\(The free Adobe Acrobat Reader can be downloaded from here.\)](#)

To the best of our knowledge these files are virus free (and we actively try to keep it that way) - but downloader beware!

Brochure, landscape, double sided as a three-fold brochure.

[\[brochure.pdf - 6 October 2003 - 109 KB\]](#)

Pump Installation and Drive Pipe Construction.

[\[install.pdf - 10 June 2003 - 474 KB\]](#)

[\[addend1a.pdf - Addendum 1 - September 2004 - 43 KB\]](#)

(install.pdf combines and updates three previous files. We suggest you download it for reference rather than try to view it on-line)

If you have trouble downloading or viewing the file install.pdf, a group of internet pages containing similar information is also available by clicking this link.

[Installation and Drive Pipe Construction](#)

Email hi-ram@bamford.com.au

Bamfords, Post Office Box 11, HALL ACT 2618, AUSTRALIA

Phone +(61 2) 6227 5532 Fax +(61 2) 6227 5995

Bamford Industries NSW BN97702171, and John Bamford and Associates NSW L8632225

"Hi-Ram Pump" is a Registered Trade Mark

Copyright ©Bamford Industries 1999-2004

[Home Page](http://www.bamford.com.au) <http://www.bamford.com.au>

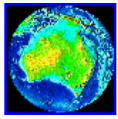

The Bamford "Hi-Ram Pump"®

New Applications

[\[Introduction\]](#) [\[Latest News\]](#) [\[About the Pump\]](#) [\[Questions & Answers\]](#) [\[Prices\]](#)
[\[Pump Installation\]](#) [\[File Downloads\]](#) [\[New Applications\]](#) [\[Links\]](#) [\[Contact Us\]](#)

New Uses and Applications

[Pumping Air or Compressing Air](#)

[Suction Pump](#)

[Primer for Water Siphon](#)

[Water Hammer Device](#)

[As an In-Line Pump](#)

[As a Power Source for Other Devices](#)

Pump Operation

A picture of a basic Hi-Ram Pump pumping water and a diagram showing operation of the Waste Valve Mechanism are shown just below - for reference in the following discussion. The operation of the pump is also discussed in more detail in the section "About the Pump".

The new uses involve a rearrangement of the normal components of the pump, in some cases with additional components. The principle of operation of the waste valve assembly is not changed. However, the geometry of the components can be very important for successful operation, and the limits for operation are not yet clearly defined for these uses. You might therefore like to regard this page as the experimenter's section of the pump internet pages.

In all of these applications it must be remembered that the amount of power produced to do useful work is small, so that the benefits occur gradually over a period of time. This corresponds to the normal water pump role, where a small flow of water fills a tank over a period of time.



Waste Valve Mechanism

“Hi-Ram Pump®” - Australian Patent No 741898

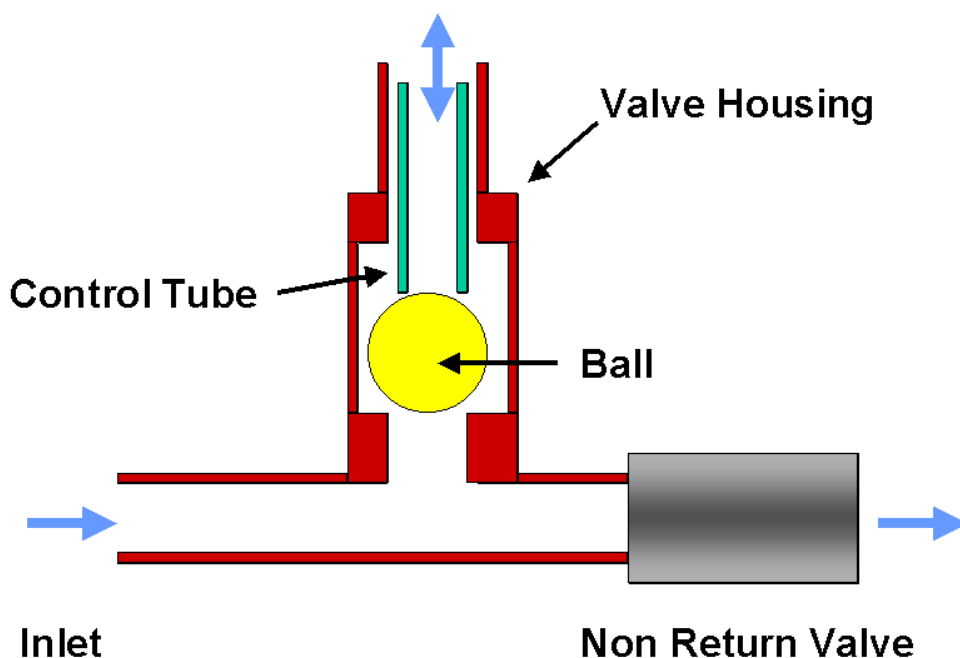

Copyright © Bamford Industries 2003

[\(Back to Top\)](#)

Pumping Air or Compressing Air

During each operating cycle of the Hi-Ram Pump the pressure in the pump body falls briefly below atmospheric pressure i.e. a vacuum is created. If the pump Non Return Valve is reversed and left exposed to the outside atmosphere, air will be sucked into the pump body to mix with the water inside the pump. This is the basis for the pump being able to pump air or generate compressed air.

Because the parts inside the waste valve stop water flow in both the upper and lower operating positions, the pump is much more efficient at generating a vacuum than other waste valve

mechanisms that only seal in the upper position.

The pictures below show a test set up with a 25 mm in-line pump. Air is sucked in the black non-return valve on the right, and goes with the "waste" water down the 25 mm inch poly pipe to come out about 500 mm below the water surface. The pump is also about 500 mm above the water surface. In addition to air being pumped into the water below, the flow of waste water provides a circulation effect. This test was to demonstrate possibilities for a self powered pump to both aerate and destratify a pond, being things of interest to those engaged in aquaculture such as fish farming.

The extra in-line fittings on the top of the pump are not needed where the pump is being used simply to evacuate air. The normal fitting at the top of the pump is used, and the air taken into the pump comes out with the waste water.

To generate compressed air, the pump uses two non return valves (not shown in illustrations here). One non return valve is used to draw air into the pump body. The second valve performs the same role as in a normal water pump, except that a mixture of water and air is pumped into the delivery pipe. The geometry and operation of the pump for this use are most important, as it is necessary to separate the delivered air and water and also ensure that the pump does not fill up with air (which will stop it). Subject to a reduction in pump efficiency because of the air injection, air can be compressed up to the maximum outlet pressure capability of the pump.



[\(Back to Top\)](#)

Suction Pump

With the same pump arrangement where the non return valve is reversed, the vacuum effect in the pump can also be used to draw in water through a suction line. Water that is sucked in exits the pump with the waste water that is operating the pump. The suction head that can be attained depends on the pump installation, although brief testing suggests that suction lifts of several metres

are possible.

Where there is a separate flow of water available to drive a pump, this opens the opportunity for the pump to act as a de-watering device or sump pump.

[\(Back to Top\)](#)

Primer for Water Siphon

There are applications where it would be useful to siphon water over an embankment, for example over the wall of a storage dam or pond. These applications are not always successful, because of the difficulty of initially priming the siphon and then maintaining the siphon effect. A siphon that is used intermittently or at a low flow rate tends to accumulate air in the upper part of the siphon, causing it to eventually stop.

While we are not aware of anyone doing this (so far), and depending on the arrangement of the siphon, a Hi-Ram Pump set up as an ancillary suction pump might provide the means of maintaining the prime in a larger siphon pipe.

[\(Back to Top\)](#)

Water Hammer Device

If the Non Return Valve shown in the diagram near the top of this page is removed or blocked off, the Waste Valve Mechanism will operate and generate the maximum internal pressures possible for the conditions of operation. (This should NOT be done for drive heads more than about 4 metres). In other words, all the input energy into the pump is dissipated through the resultant water hammer and the associated effects in the pump, the drive pipe and the overall installation.

The magnitude of the water hammer can be easily adjusted using the pump adjustment tubes and by varying the drive head. The Waste Valve Mechanism can therefore also be regarded as a way to generate water hammer for experimental purposes, or to test the resistance to water hammer of other appliances or items connected into the pipework.

[\(Back to Top\)](#)

As an In-Line Pump

In the description concerning the pumping of air (above), the Hi-Ram Pump has extra fittings so that it operates as an in-line pump. An in-line arrangement can also be used in a normal water

pumping role. This allows the waste water to be piped away in a closed system for other uses, instead of simply overflowing from the top of the pump.

The concept of an in-line pump also leads to the thought of whether the pipe for the waste water could be used to increase the effective drive head of the pump. Even if this is so, whether it is workable in a real installation is still another matter.

[\(Back to Top\)](#)

As a Power Source for Other Devices

As referred to above, the Waste Valve Mechanism will work on its own at the end of a drive pipe, generating high pressure pulses about once a second from the water hammer involved.

One way for the Hi-Ram Pump to act as a power source is to use these pressure pulses to operate other devices. For example, the pressure pulses could operate a diaphragm pump, which could be used to pump from another source of water. This would open the way to operate the Hi-Ram Pump on "dirty" water and pump "clean" water with the associated diaphragm pump.

As indicated before, although the amount of power available to do useful work is small, it can be useful when operation extends over a period of time.

[\(Back to Top\)](#)

Email hi-ram@bamford.com.au

Bamfords, Post Office Box 11, HALL ACT 2618, AUSTRALIA

Phone +(61 2) 6227 5532 Fax +(61 2) 6227 5995

Bamford Industries NSW BN97702171, and John Bamford and Associates NSW L8632225

"Hi-Ram Pump" is a Registered Trade Mark

Copyright ©Bamford Industries 1999-2004

[Home Page](http://www.bamford.com.au) <http://www.bamford.com.au>

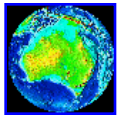

The Bamford "Hi-Ram Pump"®

Links

[\[Introduction\]](#) [\[Latest News\]](#) [\[About the Pump\]](#) [\[Questions & Answers\]](#) [\[Prices\]](#)
[\[Pump Installation\]](#) [\[File Downloads\]](#) [\[New Applications\]](#) [\[Links\]](#) [\[Contact Us\]](#)

Links

An understanding of the history of Hydraulic Ram Pumps and their subsequent development can help give a better understanding of the Bamford Hi-Ram Pump, its operation, and its usefulness.

There is much information about Hydraulic Ram Pumps on the Internet, and the links below lead to much of this information.

However, it is emphasized that the Bamford Hi-Ram Pump has different and new characteristics when compared with traditional Hydraulic Ram Pumps. Performance characteristics of other pumps, and descriptions of their operation, may not wholly apply to the Bamford Hi-Ram Pump.

[North Carolina Cooperative Extension Service](#) A comprehensive paper on "Hydraulic Ram Pumps", Publication Number: EBAE 161-92, prepared by Gregory D. Jennings.

[Lifewater Canada](#) The Internet Site of Lifewater Canada contains a comprehensive section on Hydraulic Ram Pumps with links to other sites. This section is found in the Lifewater Canada pages by going to "Manuals" and then to "Hydraulic Ram Pumps".

Email hi-ram@bamford.com.au

Bamfords, Post Office Box 11, HALL ACT 2618, AUSTRALIA

Phone +(61 2) 6227 5532 Fax +(61 2) 6227 5995

Bamford Industries NSW BN97702171, and John Bamford and Associates NSW L8632225

"Hi-Ram Pump" is a Registered Trade Mark

Copyright ©Bamford Industries 1999-2004

[Home Page](http://www.bamford.com.au) <http://www.bamford.com.au>

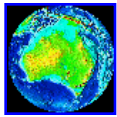

The Bamford "Hi-Ram Pump"®

To Contact Us

[\[Introduction\]](#) [\[Latest News\]](#) [\[About the Pump\]](#) [\[Questions & Answers\]](#) [\[Prices\]](#)
[\[Pump Installation\]](#) [\[File Downloads\]](#) [\[New Applications\]](#) [\[Links\]](#) [\[Contact Us\]](#)

Email and other contact details are below.

Email hi-ram@bamford.com.au

If you cannot see an email address just above, please read the one below and type it into your email program.

Email hi-ram@bamford.com.au

Just close this window to return to the previous page you were looking at.

We are sorry for the complication, but hope to reduce spam email which is interfering with legitimate messages.

Bamfords, Post Office Box 11, HALL ACT 2618, AUSTRALIA

Phone +(61 2) 6227 5532 Fax +(61 2) 6227 5995

Bamford Industries NSW BN97702171, and John Bamford and Associates NSW L8632225

"Hi-Ram Pump" is a Registered Trade Mark

Copyright ©Bamford Industries 1999-2004

[Home Page](http://www.bamford.com.au) <http://www.bamford.com.au>

ABOUT US: A BRIEF HISTORY

[Home page](#)

[About us](#)

[Products](#)

[Services](#)

[Orders](#)

[Contact us](#)

[Links](#)

In the year **1772** the first suggestions of raising water by means of a **Hydraulic RAM** were made by **John Whitehurst**, but it did not become a practical machine until **Joseph Montgolfier**, the French inventor of the fire balloon, succeeded in **1796** in making an automatic RAM.

The general principles involved have become the basis for all the hydraulic RAMS since that time, although subsequent improvements by Green and Carter have made them more highly efficient.



The firms outing in 1906?
Charles Doble's (current owner of G&C) **father is leaning on the front door with jacket over arm**
(Click on picture to enlarge)

Early in the nineteenth century **Mr James Easton** purchased Montgolfier's patent and introduced the machine into **England**, also purchasing the fledgling hydraulic RAM business of **John Whitehurst** and, as the founder of Messrs. Easton & Amos (known at various times as Easton, Amos & Anderson and as Easton, Courtney & Darbishire), was responsible for the installation of large numbers of these machines all over the British Isles, in fact more than 1000 prior to 1860.

(Obituary of Mr. James Easton - [Click Here](#))

We acquired this old-established business in 1929, having ourselves been actively engaged in the manufacturing and installation of the well known Vulcan and Vacher RAMS for well over 100 years.

PRODUCTS: OVERVIEW

Home page

About us

Products

Services

Orders

Contact us

Links

Does it work?

The Vulcan RAM is **field proven** by the units that have been installed in almost **every country in the world**, developed and developing, for over **two centuries**.

Every pump is **guaranteed forever**. Most RAMs, installed prior to 1800, are still working as well as the day they were installed, and **we still maintain a stock of all parts on the shelf**.



2inch Vulcan Simple Type RAM - Tanzania



1 1/2inch Simple Type Vulcan Ram



6inch Simple Type Vulcan Ram

Where is it used?

The Vulcan RAM is ideal for remote situations. Due to having no moving metal parts it requires only minimal maintenance and can usually cope with some degree of sediment and debris in the water. It does not require constant filter changing.

They can operate with very low falls or with extremely high falls, pumping to heads of more than 300 metres (1000 feet). Way beyond the capabilities of most imitators' units.

The Vulcan RAM is manufactured in over 60 varying types and sizes so there is a RAM built exactly for your requirements, whether you require high or low output.

Do they last?

Units are heavily constructed of cast iron and gunmetal. There is no substitute for this material. Imitators use plastics (which are subject to UV degradation), steel (which corrodes) and nylon seals and O-rings which become useless with the slightest wear.

Many large organisations and notable personages have used Vulcan RAMs with complete satisfaction for years (see our client list)

Are they Expensive?

Vulcan RAMs are extremely competitively priced and are generally available for immediate delivery.

Why Should you buy a Vulcan RAM?

We are the market leaders in RAM technology worldwide. Whether you have in mind an installation in the developing world, Western Europe or the United States, a Vulcan RAM should be your first choice.

Nobody manufactures such a wide range of RAM's, from drive pipes sizes of 3/4 of an inch (1.9cm) to 30 inches (76.2cm) (or more to order). We also manufacture the Compound RAM.

TESTIMONIALS

Mr Brown, Hardwick Farm, Cheshire, UK

Copyright©Green&Carter 2002

SERVICES: RECONDITIONING

Home page

About us

Products

Services

Orders

Contact us

Links

Reconditioned RAMs are usually available and prices subject to availability are list price less up to 20% depending on the amount of work necessary to provide full reconditioning service.

All our reconditioned RAMs are guaranteed exactly as our new RAMs.

We also operate a reconditioning service for any type of RAM.

For additional information please **contact us**



ORDERS

[Home page](#)

[About us](#)

[Products](#)

[Services](#)

[Orders](#)

[Contact us](#)

[Links](#)

UK & Worldwide

We have our own export packing department who can crate and pack our RAMs in individual component parts if required to withstand the most arduous transport in remote areas worldwide.

For all orders please **contact us** with your specific requirements.



CONTACT US

[Home page](#)

[About us](#)

[Products](#)

[Services](#)

[Orders](#)

[Contact us](#)

[Links](#)

Name

Company

Email Address

Country

Notes

To complete a Data Form with your requirements - [click here](#)

GREEN & CARTER

Vulcan Works
Ashbrittle
Near Wellington
Somerset
England
TA21 0LQ

Email: general@greenandcarter.com

Tel: 01823 672365 (24hrs)

Fax: 01823 672950

LINKS

[Home page](#)

[About us](#)

[Products](#)

[Services](#)

[Orders](#)

[Contact us](#)

[Links](#)

Eggstraspecial

www.eggstraspecial.co.uk

Energy Web

www.energyweb.co.uk

The National Trust, UK

www.nationaltrust.org.uk

Heligan

www.heligan.com

Worldwide Butterflies, Sherbourne, UK

www.wwb.co.uk

Howletts & Port Lympne Wildlife Park

www.howletts.net

Gurkha Welfare Trust

www.gwt.org.uk

The Wandle Industrial Museum

www.wandleindustrialmuseum.freemove.co.uk

Devon Guild of Craftsmen

www.crafts.org.uk

Royal Society for the Protection of Birds

www.rspb.org.uk



Making the **Web** work for you..

[Home Page](#)

[Web Solutions](#)

[Portfolio](#)

[FAQs](#)

[Contact Us](#)

MEET THE TEAM

We are a highly experienced professional team specialising in Web solutions. Our joint skills include layout and graphic design, application development and Website promotion.

Whatever your requirements we are confident we can meet them and offer what are probably the lowest prices in Europe.

Forza Media is a UK company, established in 1997.

FORZA MEDIA
3 Russet Way
Bath, UK, BA2 8SH
Tel: 07906 037647
info@forzamedia.co.uk

Client Login

Username

Password

Go



Want to talk about your new project? We'll call you



A highly experienced team with all the solutions

Some of the services we offer

Graphic design
Copywriting
Streaming video & music
Hosting & Domain names
Search engine registration
Flash & 3D design

Programming
Database integration
Secure server facilities
E-commerce
Content management
CD-Rom multimedia



[Site Map](#)

[Copyright](#)