

Serving HAM Radio since 1959, On the Web Since 1995

Order **Toll Free** Monday through Friday, 9 am to 4 pm, **1 800 726 2919** or **1 866 300 1969**, Saturday 9 AM to 2 PM ALL Times, Eastern
NO MINIMUM ORDERS, Same Day Shipping, except Sunday and Holidays Please **DO NOT** call Order Lines with technical questions. Our order lines are managed by sales personnel, and cannot transfer to tech support. BUXCOMM Tech Support is by expert ARO's, Technicians and Engineers.

*Tech Support; Email: support@buxcomm.com



A Packet Radio Primer

PACKET RADIO; The Easy Way !

(a PacketRadio primer) By *Buck Rogers* K4ABT © G. E. "Buck" Rogers Sr., 1985/2006

When I first wrote *PacketRadio: The Easy Way!* in 1985, I felt that somehow the new or prospective Packeteer would not feel comfortable with an attempt at setting up his or her Packet station without some means of tutorial. That was when I decided to write this tutorial. I had to give the ham who might be willing to give Packet Radio a try, a head start by taking them around the pitfalls that I had experienced when I set up my first Packet station. When I began my Packet Radio hobby, there were no neighbor Packeteers, no Packet books, no tutorials, and no PacketRadio page on the internet to provide guidance for a beginning Packeteer. Having said that;... Here then, is a brief and common-sense guide for the first time PacketRadio operator.

WHAT EQUIPMENT IS NEEDED TO BEGIN OPERATING PACKET?

The equipment needed to get on the air is a VHF transceiver

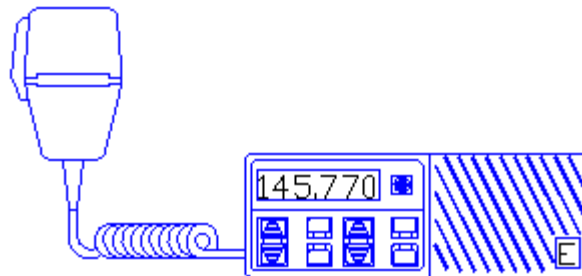

(without the microphone), AND

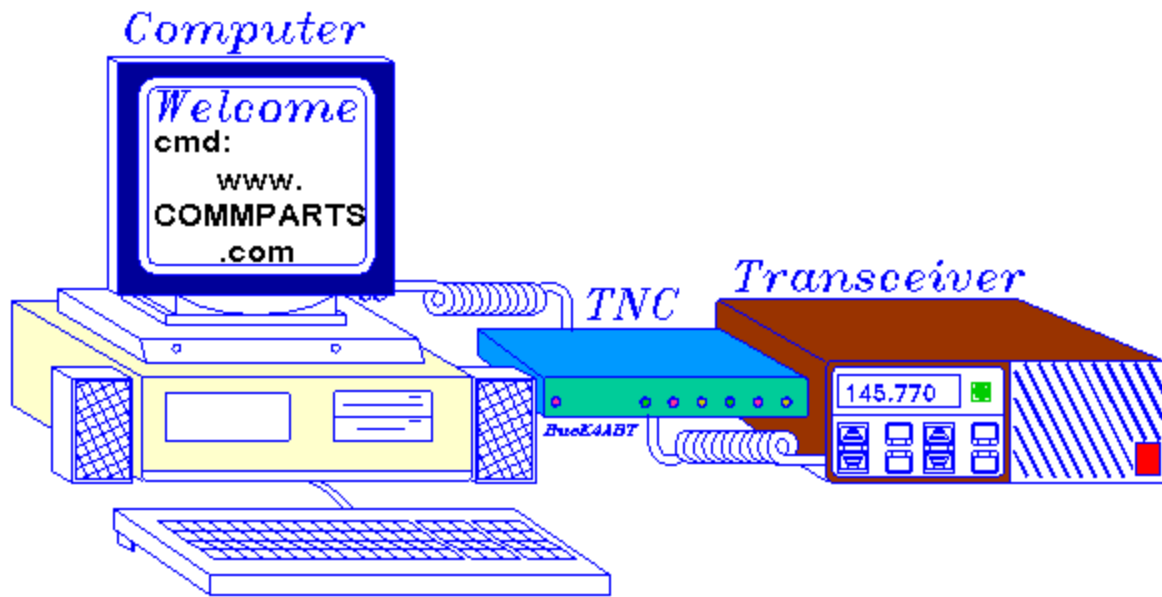

*The three (3) components of a PacketRadio station.
a computer or terminal, and a terminal node controller (TNC).*

There is packet activity on HF, but VHF is the best place to begin operating PacketRadio. The Terminal Node Controller or *TNC* contains a modem similar to the modem used to connect your computer to this internet page, except that it also contains special firmware especially designed for PacketRadio. This "firmware" converts computer data into "packets" of digital information that can be sent (error free, via PacketRadio nodes) across the PacketRadio network.

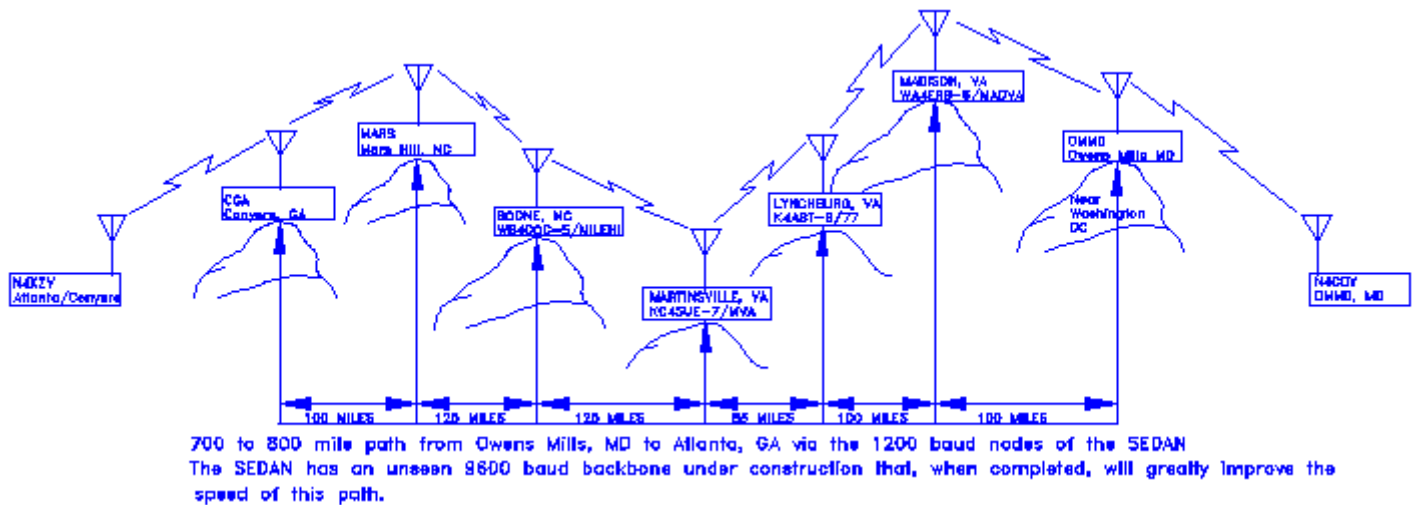

Keyboarding with friends over long distances is easy when using a PacketRadio Network. Very little power is needed, as the nodes along the network perform as "store and forward" devices for this purpose. The nodes do the "store and forward" function automatically. All the PacketRadio user has to do is establish the connection, the rest is handled by the nodes

WHAT IS A TNC?

A "Terminal Node Controller" (TNC) is similar to the modem you use when connecting to the internet. One difference is; The TNC is used to interface our terminal or computer into the "RF" or radio (wireless) medium. There is one other, *very* significant difference; Inside the TNC we have added some internal firmware called a "PAD." The pad or "Packet assembler/disassembler" captures incoming and out-going data and assembles it into "packets" of data that can be sent to and from a data radio or transceiver.

In addition to the data stream conversion to and from packets, the PAD also enables the Push-To-Talk (PTT) circuits of the radio transceiver. When you press the enter key of your computer keyboard, the typed in data is sent out over the air to the target station or a nearby "store-and-forward" device known as a "node."

Incoming (received) data from the transceiver is also converted within the PAD, from Packets of data into a stream of usable data and sent to the TNC/modem. Here the data stream is sent to the serial comports of the computer for display on the screen, or manipulated by a resident terminal program into on-screen text, pictures, or save-to-disk processing.

When you remove the TNC from the carton, you'll find cables and connectors provided with the TNC. These cable are usually for the TNC end of the interface cable. The other end of the cables that attach to the transceiver and computer are *not* supplied. The reason is that the TNC manufacturer has no idea what kind of [radio](#) or computer you might be connecting to.

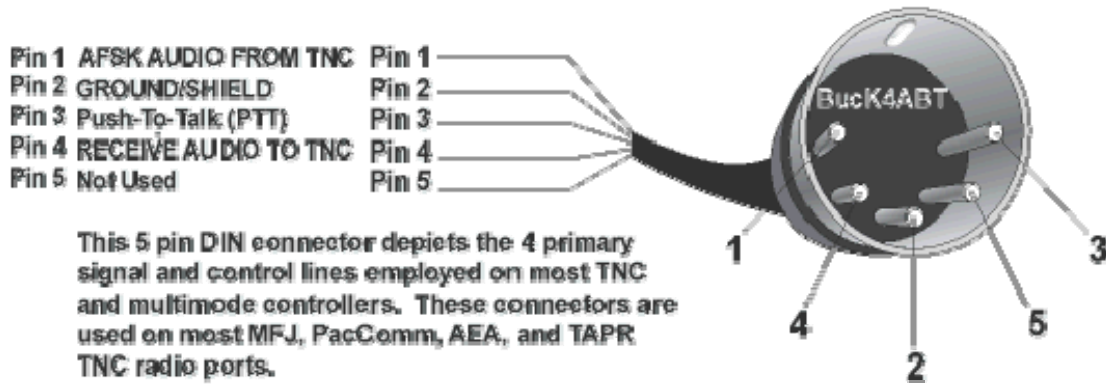

Before we go any further, look at the drawing above; This is one of the most popular TNC (Radio port, Input/Output (I/O)) connectors in use today. This 5 pin DIN connector is almost a "standard of the industry." Knowing the names of the signal and control wires for your TNC will save you a lot of time and grief when making your radio to TNC interface.

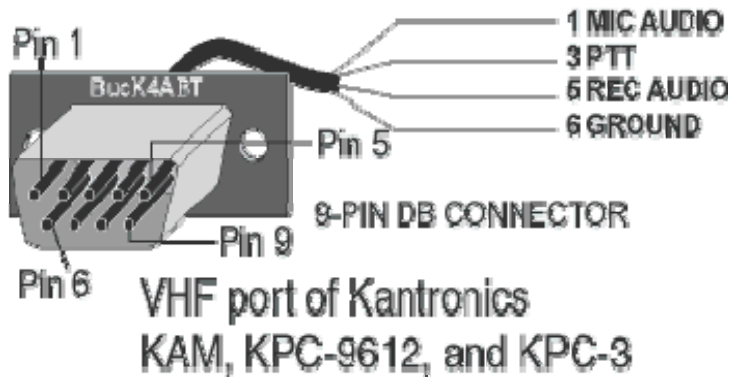

So that we cover other popular radio port interface connector types, the above drawing depicts the VHF radio port of the Kantronics KPC/KAM series. *"NOTE that no connections are made to pin 7!"*

The burden is on the user to purchase the correct [connector for the transceiver](#) and computer that will be used with the TNC. Determine the kind of microphone, speaker jack, and computer serial comport connectors that you're going to use.

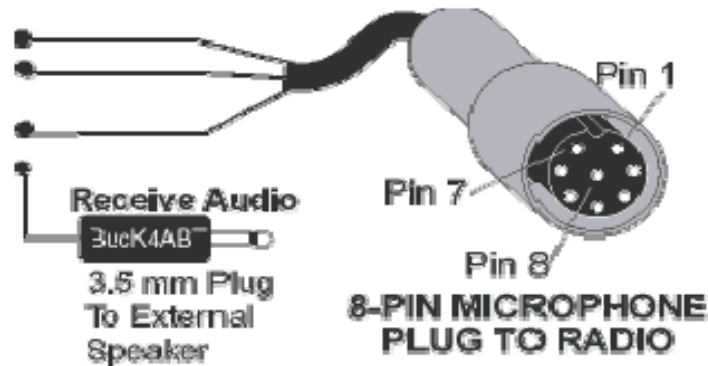

The four (4) signal and control lines associated with PacketRadio I/O are:

- o Transmit (AFSK) audio
- o Receive Audio
- o Push-To-Talk (PTT)
- o Ground/Shield

The drawing shown above, is an example of a typical microphone I/O employed on many pre-1997 VHF transceivers. This drawing is shown for reference only. The numbers identified on the MIC connector are to assist the user to identify the pin number sequence of a typical eight (8) pin microphone connector.

In some cases the TNC manufacturer furnishes only the connector for the TNC. This means that you must also furnish the cable that connects the TNC to your computer or terminal.

In most cases, a 25 pin RS-232 serial cable is used between the TNC and computer. The later models employ a 9 pin serial connector, thus you will need a 9 pin connector/cable. This may vary depending on the type and make of computer terminal being used. Check the serial comport of your computer to be sure of the type connector that you will need. **DO THIS BEFORE GOING TO THE PARTS SUPPLY HOUSE!**

In most cases the computer will have either a 9 pin male connector, or a 25 pin male connector as the RS-232 serial comport. If this is the case, you will have to supply the female connector for the computer end of the cable. Be sure to note the number of pins on the computer/terminal connector (and the gender).

The operating manuals supplied with most TNC provide adequate directions for use of various computers. Look for the computer to terminal node controller (TNC) interface section in the TNC manual. In most applications the cable for your TNC to computer may be purchased *ready-made* for many computer vendors.

When all else fails read the manual and set up procedures for your TNC very carefully. The manual that is supplied with your TNC may have information that is specific to the personality of your TNC.

When you have everything connected together, turn on the computer, load a terminal program. There are lots of terminal programs available for use with Packet radio.

An example of how the transceiver(s) are interfaced to the TNC is shown in the illustration below.

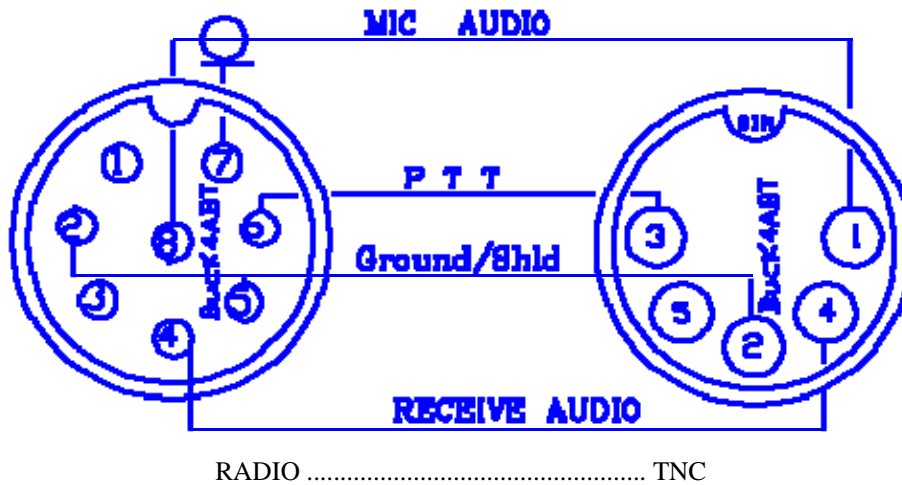

Many more interface drawings are included in the FREE Packet handbook described below. The drawing shown here is for illustration only. I am not responsible for damage resulting from errors, or omissions.

TERMINAL PROGRAMS FOR PACKET OPERATION:

If you have a PC or compatible computer but do not have a Packet terminal program, [CLICK HERE to DOWNLOAD the 2004-6 version 2.7 of BUXTERM.EXE](#) The ZIPped file also contains the text version of BUXTERM documentation.

If you prefer, you may download [BUXTERM.EXE](#) (*it is FREEWARE, give a copy to a friend*)

WITH THE TERMINAL PROGRAM "BOOTED" WE BEGIN:

Switch the VHF transceiver ON and turn the volume up a quarter turn or just above the "9:00 o'clock position." Make sure the squelch is not set too tight. The squelch should be set to a position where the transceiver is quite. The squelch is set in a similar manner that you would use for voice operation.

There are two communication speeds that are used in Packet Radio. It is necessary that each new Packeteer be aware of the meaning of each speed, and the relationship to his/her Packet station. The first speed is the terminal to TNC baudrate. The second speed is the "ON-AIR" or radio (VHF) baudrate.

Since we are about to begin operating in the VHF region we will begin with an on-air HBAUD speed of 1200 baud's. ABAUD refers to the terminal to TNC, and HBAUD refers to the RADIO or ON-AIR baudrate (data speed). Most computer and TNCs will operate at an ABAUD of 9600 baud's.

As shown in the illustration below, there are three main ingredients that make up a Packet station. They are:

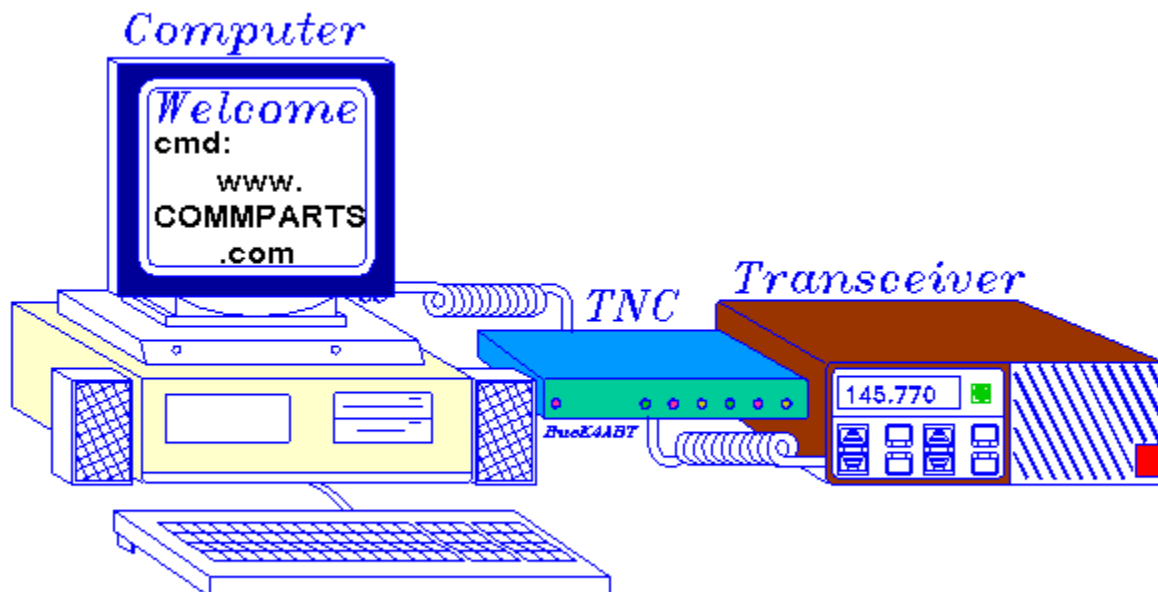

The three (3) components of a PacketRadio station.

LET'S BEGIN HAVING FUN:

Before we get too deep into the setup and operation of our Packet station, I have one small recommendation. **DO NOT**.. set a radio on top of a TNC, and **DO NOT** set a TNC on top of your radio. Many years ago we found that CPU noise will often inhibit the receive capability of our transceivers and thus prevent our being able to link to distant nodes or other Packet stations.

CPU noise is a product of poor shielding or radiation from the central processing unit within the TNCees and KPCees. This noise can be subliminal or low in level, but the CPU noise threshold can be destructive to certain receive components within our transceivers.. enough so, that it will prevent our TNC from decoding some data Packets.

Where possible, locate your Radio and Node side beside, but with at minimum of 4 inches between them... horizontally spaced. **DO NOT** PLACE THE TNC ATOP THE TRANSCEIVER, or vice-versa.

If you have followed the setup procedures outlined in the manual that comes with your TNC, then you are ready to take the plunge into the wonderful world of operating Packet. Verify that all control, signal and ground wires (PTT, RECEIVE, AFSK, and SIGNAL GROUND) are connected to the correct connector pins.

TURN ON THE TNC!

When you first turn on the TNC you may see garbled text on the screen. This is usually because the terminal to TNC baudrate is not set to the same parameters. Some TNCs will do a "search" mode to find the setting that you have your terminal program set to/for. If at first you see garbage on the screen then clear text begins to appear, you should follow the instructions that appear on the screen. If you are unable to establish communications with the TNC, then review the TNC manual for further instructions. The baudrate of the TNC has to match the baud rate used by your computer terminal program and serial comport configuration. The comport speed (ABAUD) is easy to adjust. When the terminal to TNC parameters are correct, a message will appear on the screen showing the TNC manufacturer's name, firmware (EPROM) version, and date of program manufacture.

Perform a "control C" (press Ctrl and the letter C at the same time); this places the TNC into command (cmd:) mode. This is where all commands are issued from you to the TNC. Any command that is typed while in the "cmd: mode is received by the TNC as a direct order.

Once in the command mode, you can press the [Enter] key and each time you press the [Enter] key a "cmd:" prompt should appear on the screen. This is an indication that you have control (command) of the TNC.

The next step will be to set our callsign into the TNC. To put our call sign into the TNC, at the cmd: prompt, we type and [Enter] the following:

MY (your call)

I send my call sign to my TNC in the following manner. Type and [Enter] to the keyboard/TNC: (the [Enter] simply means I pressed the Enter key).

MYcall K4ABT [Enter]

You may now test the TNC to see if your call sign is indeed set into the TNC. To do so, type:

MY [Enter]

The screen should display a response from the TNC with:

MYCALL [Yourcall]

If I enter:

MY [Enter] and the TNC should respond with:

MYCALL K4ABT

This tells us that the computer and TNC are communicating properly.

Now that you have entered your call sign as we have just described, followed by a carriage return, (CR or [Enter]), we are ready to set other commands into our TNC. If there is no response when you type MY, then try typing:

ECHO ON [Enter]

The :cmd:" should appear on the screen again, with a message similar to the following:

ECHO was OFF

NOTE; If you are seeing double letters (i.e.; MMY Y CCAALLLL) displayed when you type, this indicates that the ECHO command should be turned OFF. Type the following :

ECHO OFF

The TNC may respond with:

ECHO was ON

Here are some other commands that we should make active; Type them in as I have shown them below:

**MON ON
MCOM ON
MCON OFF
MRPT ON**

If you've wired the RS-232 interface cable using the RTS, CTS, Txd, Rxd, and Signal Ground leads, then set the XFLO command OFF. If you did NOT use the RTS, and CTS signals, then make sure the XFLO command is ON.

THE MOMENT OF TRUTH:

There are many frequencies that are set aside for PacketRadio use. The following is a list of VHF, and UHF Packet Radio simplex frequencies that are a part of the SEDAN Packet Radio bandplan (In Mhz):

144.91, 144.93, 144.95, 144.97, 144.99, 145.010 145.03, 145.05, 145.07, 145.09, 145.51, 145.53, 145.55, 145.57, 145.59, 145.61, 145.63, 145.65, 145.67, 145.69, 145.71, 145.73, 145.75, 145.77, 145.79.

Included in the ARRL future band plans are several simplex (64 kB), 100 kHz backbone frequencies within the 219 to 220 (FCC approved 16 March 1995 with restrictions, *see CQ Magazine PUN June 1995*) Mhz UHF band;

As I mentioned earlier, make sure the MONITOR command is ON, then watch the screen. If you have tuned to one of the Packet frequencies mentioned above and you are not yet seeing data appear on the screen, then try the SEDAN 1200 baud access Packet frequency of 145.770.

When all else fails call a Packet friend and ask them to connect to your call. If you are using an **SSID* of your call, be sure to include this in the information that you give the friend. While you are about it, ask if he/she uses an SSID.

***WHAT IS AN *SSID ?**

Now that I have you wondering; "What is an SSID?" Here is a brief explanation; The term: "*Secondary Station Identification*" or (SSID) is explained as follows:

In Packet Radio you can have up to 15 Secondary Station Identifiers (SSID's), an example is K4ABT-1 through K4ABT-15.

K4ABT without an SSID extension, is considered the 0 (zero) SSID, thus we could have sixteen different stations/calls on the air at the same time using our single call sign. That's where the numbers in the call sign come into play. The added dash numbers (-1 etc...) numbers are used to distinguish the various station(s) or node(s). Your personal mailbox (MYM or MYP) is almost always set into your TNC as -1 SSID. eg; my mailbox is K4ABT-1 To connect to a station or node which uses an SSID, it is important that we know what the SSID is before attempting a connect to that station. To try connecting to a station or node without having the appropriate SSID included in the connect sequence would be like trying to place a long-distance telephone call without using an area code. A crude analogy, but you get my drift.

You are about to embark upon one of the most fun filled facets of the Ham Radio Hobby. If you are looking for a TNC free environment, you may *try Sound Card to Transceiver, Packet, PSK31, RTTY, and SSTV, using the RASCAL Mark V Transceiver to PC interface.*

[NOW, do Packet Radio using your PC sound card and software. CLICK HERE](#)

NOW! *we are having fun already!* 73 de BucK4ABT