

AT MICROFICHE REFERENCE LIBRARY

A project of Volunteers in Asia

Grass Roots Radio: A Manual for Fieldworkers in
Family Planning and Other Areas of Social and
Economic Development

by: Rex Keating

Published by:

International Planned Parenthood Federation
18-20 Lower Regent Street
London SW1Y 4PW
United Kingdom

Paper copies are \$ 6.50.

Available from:

Distribution Department
International Planned Parenthood Federation
18-20 Lower Regent Street
London SW1Y 4PW
United Kingdom

Reproduced by permission of the International
Planned Parenthood Federation.

Reproduction of this microfiche document in any
form is subject to the same restrictions as those
of the original document.

A manual for fieldworkers in family planning and other areas of social and economic development



REX KEATING

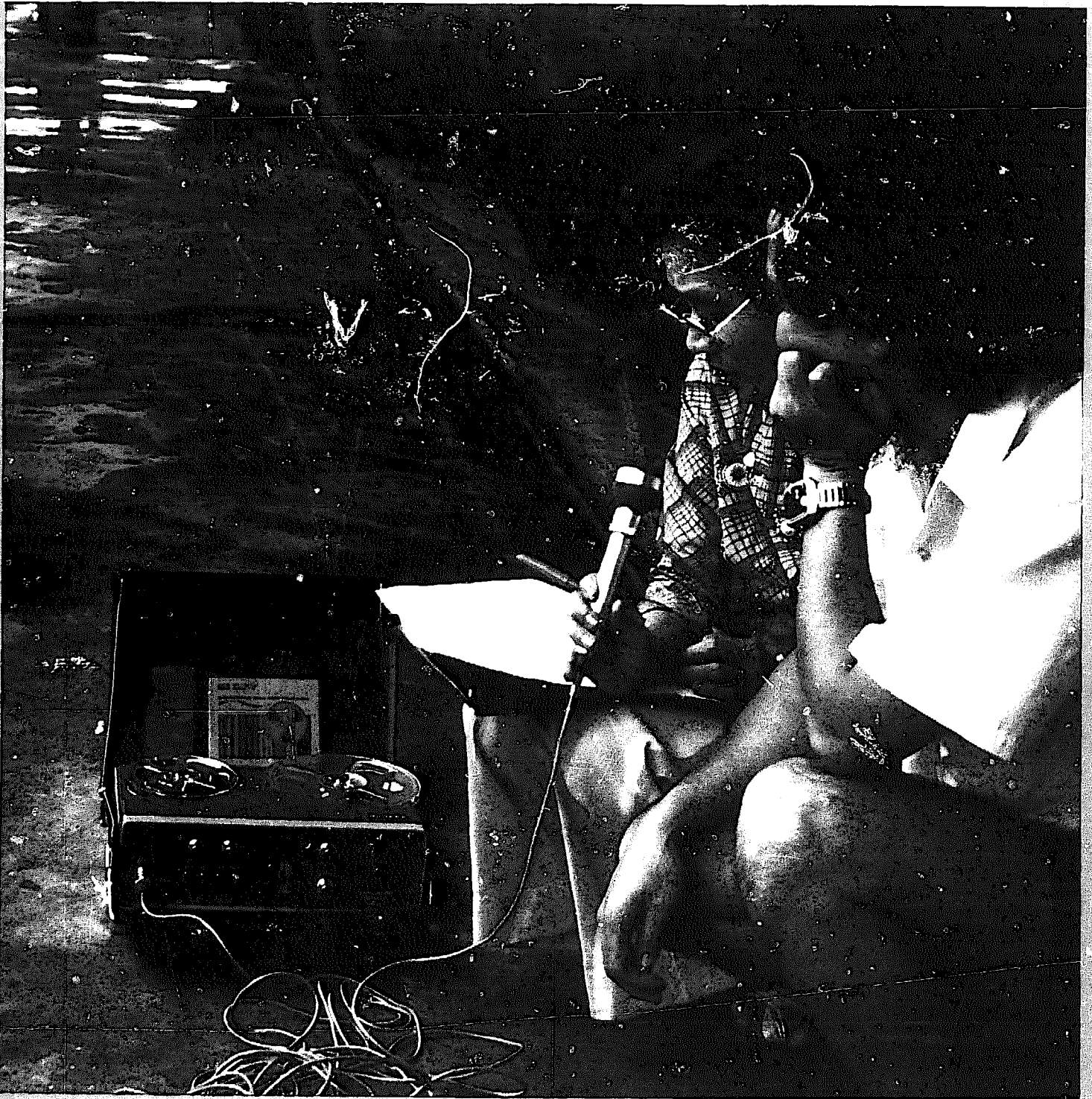

During 1976 the International Planned Parenthood Federation held a first regional training course in its East and South East Asia and Oceania Region, centred on Kuala Lumpur. Participants attended the course from nine countries in South East Asia providing both delegates and the IPPF with a new experience in training for radio. This Manual is a direct outcome of that experience.

Rex Keating has had long and practical experience in radio, having held numerous official positions in broadcasting services throughout Europe and the Middle East since 1935. He has had over 25 years experience in training in radio technique.

As a one time war correspondent and first Director General of the Cyprus Broadcasting Corporation . . . as an Independent Television newscaster in London and after 17 years with UNESCO producing countless radio programmes and many educational films, Mr Keating's credentials enabling him to write a book of this kind are impeccable.

His United Nations work stimulated an already keen interest in the developing world and the many problems of our global environment. Worldwide travel, research and writing led to the production of programmes and books closely related to this interest.

And always, as in this book, Mr Keating keeps his feet firmly on the ground of real field experience.

GRASS ROOTS RADIO

© 1977

**INTERNATIONAL PLANNED PARENTHOOD
FEDERATION**

No part of this book may be reproduced in any form by print,
photoprint, microfilm or any other means without written
permission from the publisher.

Published August 1977

ISBN 0 86089 008 2

Printed in Great Britain by
The Typographic Press Limited
Welwyn Garden City, Hertfordshire

GRASS ROOTS RADIO

A manual for fieldworkers in family planning and
other areas of social and economic development.

REX KEATING

with an introduction by
DUNCAN HAZELDEN
Audio Visual Services Manager IPPF

Design by CHRISTOPHER CHASEY *IPPF*
with humorous drawings by
DENNIS MUTTER



**INTERNATIONAL PLANNED
PARENTHOOD FEDERATION**
18-20 Lower Regent Street
London SW1Y 4PW

CONTENTS

| Page | |
|------|---|
| 6 | Foreword |
| 7 | Introduction |
| | CHAPTER ONE |
| 9 | How Broadcasting Works |
| | CHAPTER TWO |
| 11 | The Tape Recorder |
| | <i>How it works . . . The Reel-to-Reel Recorder</i> |
| | <i>The Cassette Recorder . . . Tape Recorder</i> |
| | <i>Maintenance . . . Controls . . . Editing</i> |
| | <i>The Microphone</i> |
| | CHAPTER THREE |
| 17 | Recording Drill |
| | CHAPTER FOUR |
| 19 | Interviewing |
| | <i>Introduction . . . Preparation . . . Setting the Scene . . .</i> |
| | <i>Conducting the interview: in the Village . . .</i> |
| | <i>Conducting the interview: in the Clinic . . . Possible</i> |
| | <i>Places for Interviews</i> |
| | CHAPTER FIVE |
| 25 | The Radio Talk—Script Writing |
| | <i>Structure . . . Treatment . . . Presentation</i> |
| | <i>The Radio Talk—Ten Illustrations</i> |
| | CHAPTER SIX |
| 40 | Discussions |
| | CHAPTER SEVEN |
| 44 | News |
| | CHAPTER EIGHT |
| 47 | Other Formats |
| | CHAPTER NINE |
| 52 | Listener Research |
| | <i>Introduction . . . Method . . . Application to FPAs</i> |
| 57 | Appendix: Case Studies |
| | <i>Radio Spots—Examples</i> |
| 66 | Suggested Short Reading List |

Foreword

The manual is not intended for the professional broadcaster. Its purpose is to instruct in, and analyse certain basic elements of radio production and writing which if skilfully applied will enable workers in the field of family planning to explain to listeners via the transmitters of their local radio stations the purpose and practice of family planning in relation to the communities they serve. Such persons as doctors and nurses in hospitals and clinics and in private practice: midwives; social workers; health and community workers and, of course, workers in the Family Planning Associations: in short the multitude of people involved in the actual application of family planning policies at the practising level. While addressed particularly to family planning personnel, the techniques described in the manual can be equally useful to workers in other fields of social and economic development, ranging from agriculture to public health.

Explanations are restricted to those few elements in the wide spectrum of broadcast programmes to which family planners and other fieldworkers can usefully contribute. Thus the book concentrates first and foremost on field interviewing. Here it is the person interviewed who is of interest to the radio listener; the interviewer must necessarily drop into the background and he does this by effacing his personality. He is in much the same position as the photographer who, while he controls the camera and pushes the button, seldom appears in the resulting photograph. The contrary is true of the three other radio activities covered by the manual: studio talks, participation in discussion programmes, and news contributions. In these broadcasts the contributor is presented to listeners as a person in his own right, speaking with authority on his own subject. Obviously, interviewing on the one hand and personal appearances before the microphone on the other, call for very different techniques and these differences the manual sets out to explain and illustrate.

Useful as a source book in training courses for non-professional broadcasters, the manual is designed primarily to be used by individual field-workers operating in a variety of cultures as an instructional tool in its own right.

Introduction

Throughout the developing world radio is now recognised as an ideal medium for the spreading of information about, and stimulating interest in, social and economic change and innovation. It has an obvious educational potential. It has an immediacy and a flexibility unique among the mass media and enjoys the outstanding advantage of being comparatively inexpensive in its programming. Moreover it is long established with either national or commercial broadcasting services, and sometimes both.

Levels of literacy are restricted in many developing countries and consequently strong aural traditions have developed over the centuries and this makes the talking medium – radio – an excellent channel for the communication of ideas originating beyond the confines of the village. In the past radio suffered from a handicap that still affects television broadcasting, the need for an electric power supply, and this effectively restricted use to the cities. But the development and marketing of the inexpensive battery-powered transistor radio has brought about a dramatic change. These pocket communicators have now reached many distant corners of the countryside where so much of the population lives and works. As a result hundreds of millions of once isolated villagers are in direct touch with authority of the centre and beyond that are catching glimpses of a new and intriguing world.

For those of us who work in family planning and other areas of social development the long reach of radio into the rural areas offers an exciting prospect.

For us, it is a means of taking both family planning, and information and education about it, to the people rather than expecting them to come to us. We have come to recognise the need in our work, to get out of the clinic and into communities where people live and work. Radio should help us, not only in reaching our audiences through public health service channels, but also in providing new outlets designed to reach our audiences through commercial and other channels. For example, the jingles, spots and other forms of advertising broadcast by both government and commercial radio stations clearly offer new opportunities to the IPPF in certain of its projects, such as the community-based distribution of contraceptives.

The tasks before us are so immense that they can only be tackled with the involvement and assistance of other channels, organisations and institutions.

From time to time we have all undoubtedly appreciated the many and diverse opportunities provided by the medium of radio, but we probably need to admit that our use so far has been characteristically sporadic, unplanned and not quite professional enough. We hope that this book, among other things, will encourage users of radio to design more properly planned and long-term approaches based upon a better understanding of what radio can do, and define clearer objectives.

There are undoubtedly special features enabling the use of radio as a tool for family planning communication apart from its range and ability to penetrate rural areas. For instance it provides a one-to-one channel of communication, where the individual listener can be addressed as 'you' and where there is no need for interpretation of an intermediary between the sender and receiver of messages. It is a highly personal form of communication and increasingly it is used as a two-way system, either through listener reaction coming back to the broadcasting station through responses in the mail, or in 'more developed situations' where an adequate telephone service exists there is the possibility of listeners 'phoning in' during a programme thereby steering the content of a broadcast even more in the direction of user requirement.

It may be thought that in explaining and proposing the wider use of radio as a tool in communicating developmental ideas we are suggesting its superiority when compared with other media. This is certainly not the case. Radio is one element which may profitably be used as part of an overall information or education programme. It may have received less than its proper share of attention because use thus far has been of an *ad hoc* nature. What is really required is a strategic approach to its use. In particular, it needs to be seen in its relationship to other media; how it fits in with the programmes of work, meetings and visits being undertaken by fieldworker personnel; how the broadcasts themselves may fit in with posters, leaflets or any other media of communication.

What we should like to see evolve is a situation where radio is seen as part of a total programme ap-

proach to a communications programme whatever the intention of those communications may be. It may be for example, that communications are intended to build and sustain a climate of acceptability for family planning or related content.

Alternatively, radio may be seen as a tool of an intensive education advertising approach. The spectrum of such possibilities is wide and the need to co-ordinate them clear.

Duncan Hazelden

CHAPTER ONE **How Broadcasting Works**

If you want to travel by rail you do not have to learn to be an engine driver, but you do have to know about timetables and connecting routes. Similarly if you want to fit into a programme's schedule it does help to have a rough idea of how broadcasting works. Any broadcasting station worthy of the name sets out to reflect the everyday life of the community or communities it claims to serve. It seeks to entertain its listeners and to tell them what is happening, not only in their own country, but in the world beyond. Unlike a newspaper, which is concerned only with news, a radio station brings to its listeners not just news but also music, literature, drama, entertainment and the whole range of programmes which are loosely termed 'public service broadcasts'. It is to this last group, the public service programmes, that you will most likely contribute.

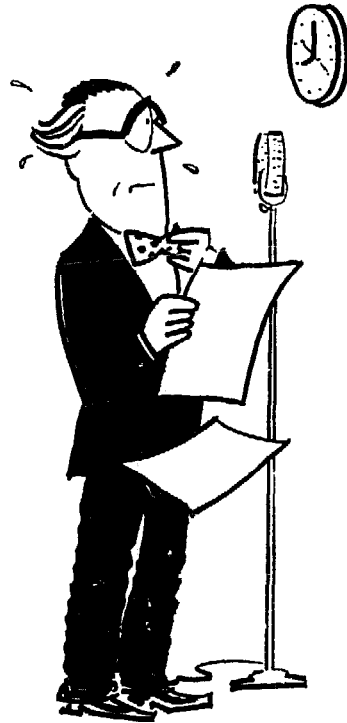

The broadcasting of a radio programme involves a whole range of persons with widely differing responsibilities, all ruled by the clock. As an example, let us suppose a discussion programme is about to be broadcast. First, the announcer has to know he is on duty at the scheduled time and that he must be in a certain studio to present the programme. Likewise the producer and participants must know the hour and place of the broadcast in order to be in position in good time; if the discussion has been pre-recorded, then someone is responsible for ensuring that the tape or disc (record) is in the right re-play cubicle and that a technician is present to load up the tape and push the 'play' button at the exact moment, according to a pre-arranged cue; in the central control room the operators on duty need to know which cubicle, or studio if the discussion is 'live', to control for correct sound level and switch into the line connecting studios with transmitter; if the live discussion is scheduled to be recorded simultaneously for broadcasting again at a future date, a recording channel has to be made available beforehand and switched into circuit on cue by yet another technician. And all this goes on throughout all day, every day.

Obviously, broadcasting needs meticulous co-ordination and this getting together of all persons and facilities concerned in their proper places and at the right time is the responsibility of a unit, usually known as Programmes Operations or 'Ops' for short. It is Ops



which arranges studio bookings, rehearsals, recording channels, duty rosters for announcers and technicians, etc. according to the details listed in the Programme Chart or Schedule. The Chart is drawn up by the Programmes Director and it is he who meets regularly with the producers, usually weekly, to plan the schedule of several weeks ahead. In due time Ops breaks down the weekly schedule to a daily one for distribution to all personnel concerned with the current day's broadcasting. And if your head is beginning to reel, let me hasten to point out that the foregoing programmes structure is only a part of the overall structure of the Station. Other divisions deal with finance, contracts, copyright, sound recording and reference libraries, news gathering and editing, technical maintenance, secretarial work for script copying and stenography, publicity, transport and so on.

The foregoing then is a condensed version of how an average size broadcasting station functions. The little commercial stations which work on a 'shoestring' operate, of course, at a much simpler level, yet even they have to plan and run a programme schedule. Always bear in mind that broadcasting personnel work under pressure in a permanent state of crisis. They are very busy people, beset by deadlines and ruled by the clock. Therefore your material must be presented in a form which these overworked professionals will find the least trouble. Present a producer with an interview which is both lively and concise and complete in itself – in short a neat package – and he will probably accept it. On the other hand if your interview is full of stops and starts, hesitations and repeated phrases it will have to be dubbed (copied onto tape) and edited, to be made broadcastable; editing takes up valuable time and moreover requires the services of a technician plus recording channel. Such an interview is likely to

be rejected. Remember, you are in competition with many other programme sources, all trying to get time on the air. In some respects, unless you are a professional broadcaster or famous, getting entry into a broadcasting schedule is rather like trying to storm a fortress without weapons. The weapons in your case must be quality, liveliness and brevity.

Another important point: do not send your cassette or tape addressed to the Programmes Director, unless you happen to know him personally. Seek out a producer who usually handles your kind of material and try to interest him in what you have to offer.

Remember, too, that the planners prefer to schedule their programmes in series to be broadcast at regular fixed hours. They do this to accustom their listeners to tuning in to their favourite programme at the same time of each day, or week, or month. The news bulletin is a good example of fixed-hour broadcasting. It is in such regular broadcasts that your contributions will be most effective.

Here is a brief list of types of broadcasts which your material will most likely fit.

Magazines (interviews and brief items of talk)

Public Service Broadcasts (current social and economic developments and problems, new ideas and innovations that concern communities and individuals)

Discussions

News (bulletins and news comment)

Adult education broadcasts

Schools broadcasts

Straight talks (10-15 minutes as distinct from 2-5 minutes Magazine talks)

There are, of course, other types of programmes that can carry the family planning message. They include playlets and so-called 'soap operas', quiz and panel games, comedy shows, record request broadcasts, and commercial-type jingles and slogans. These can be very effective but they call for special skills and professional writing and production. For this reason they are largely outside the ground covered by the scope of this manual.

CHAPTER TWO

The Tape Recorder

How it Works

Because I firmly believe that to have a rough idea of how the machinery works makes one a better car-driver, I propose to begin this chapter with a much over-simplified explanation of how a strip of brown plastic can be made to accept and retain a wide variety of complex sounds and then reproduce them as required. Actually, one face of the plastic strip is coated with a very thin layer of iron oxide. Now iron can be magnetized and if we pass this band of iron-coated material at a constant speed through the field of an electromagnet in which is flowing a series of electrical impulses generated by a microphone, the iron coating particles will be arranged into a corresponding series of microscopic magnets. The electromagnet is called a 'head'. On playback the now magnetised tape passes through the field of another 'head' and induces in it a flow of electric current. This current, when amplified, faithfully reproduces the original sounds of voice or music as they arrived at the microphone. Thus it follows that all tape recorders have a recording head and a playback head; usually there is an 'erase' head as well which is used to remove previously recorded material by de-magnetising the tape. Often, by means of internal switching one head is made to do the work of two. The tape must pass across the heads at constant speed if 'wow' or 'flutter' is to be avoided, and the 'transport mechanism', as they call it, is a vital element in a tape recorder's construction.

The speeds at which the tape passes across the heads can be $3\frac{3}{4}$ ips (inches per second) or 9.5 cms, $7\frac{1}{2}$ ips (19 cms) or 15 ips (38 cms). The greater the speed the higher the quality (frequency response). Studio recorders generally use 15 ips while portable machines run at $7\frac{1}{2}$ ips and sometimes at $3\frac{3}{4}$ ips. (The cassette recorder operates at the extremely low speed of $1\frac{7}{8}$ ips (4.76 cms), which accounts for its compactness and for the remarkable length of recording time which can be squeezed onto a single cassette tape: up to 120 minutes). Most portable and non-professional machines use only one half of the full width of the tape at a time (half-track recording), so that in practice two entirely different sets of signals can be recorded on a single tape. This means considerable economy in tapes. Studio recordings are always full-track which gives slightly improved quality and makes for ease of tape editing (cutting and splicing).

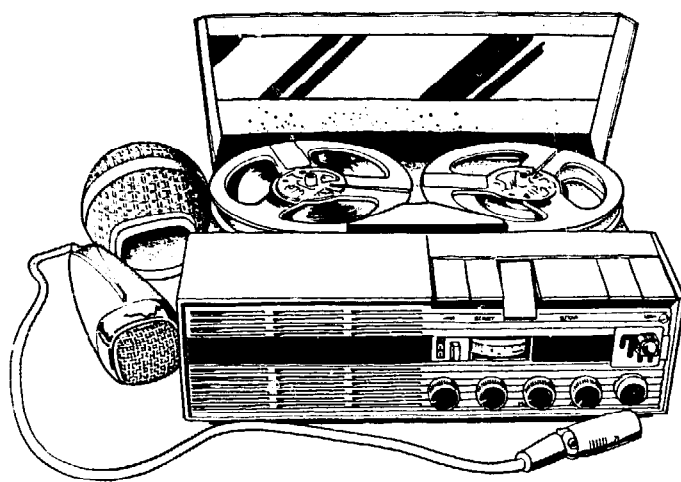

The Reel-to-Reel Recorder

Tape recorders are of two kinds: reel-to-reel and cassette. The former, as the name suggests, uses a reel of magnetic tape, five inches in diameter in portable machines, which is drawn across the heads onto a 'take up' reel or spool. A five inch spool of standard tape running at a speed of $7\frac{1}{2}$ ips, will give you approximately 15 minutes of continuous recording. This time will be increased to 30 minutes if your machine records at $3\frac{3}{4}$ ips. However, one should bear in mind that the lower the recording speed, the poorer will be the quality (frequency range) of the signal recorded. Portable reel-to-reel recorders are usually professional or semi-professional machines and, therefore, expensive to buy.

When threading the tape through the recording gate and onto the 'take-up' spool take care not to twist the tape, and be equally careful to check that the coated side faces the heads - the magnetic coating is dull (non shiny) in appearance. In the illustration the cover of the recording gate has been removed to show the heads.

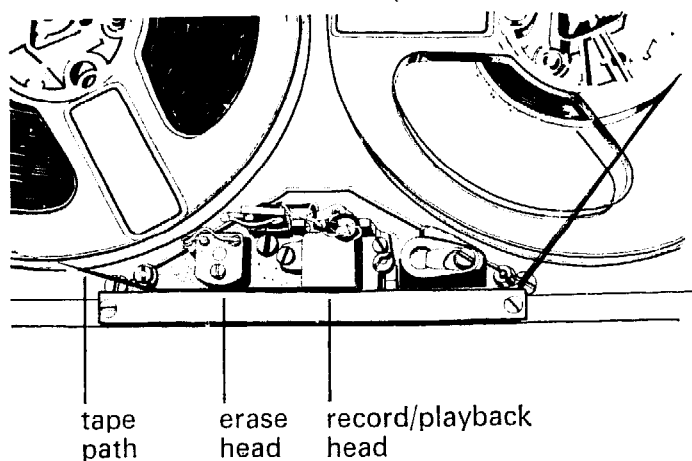

The Cassette Recorder

By contrast, the cassette machine is cheap to buy and usually easier to operate. A few years ago the average cassette recorder was of doubtful reliability and gave a performance much inferior to that of the reel-to-reel type; today, improved manufacturing techniques have made available reliable and reasonably-priced machines capable of excellent performance. Cassette tape is only half the width of standard tape and is therefore cheaper. A further economy stems from the very low recording speed, already referred to: $1\frac{7}{8}$ ips which means that the length of tape needed for a given period of recording time is only half that of a spool of standard tape recording at $3\frac{3}{4}$ ips. Finally, the cassette machine is always half-track thus accommodating two full-length recordings on one band of tape. There is, of course, a price to pay for this economy: a narrowed frequency range and therefore a lower quality of signal. However the narrower band of frequencies is adequate for the recording of speech and it is speech, in the form of field interviews and commentaries, which concerns us. Two tiny spools, one filled (charged) with tape, the other the 'take-up' spool are fixed by the manufacturers within a plastic container known as a cassette cartridge and when the cartridge is dropped into place and switched on, the tape inside is drawn across the heads which are located in the machine itself.

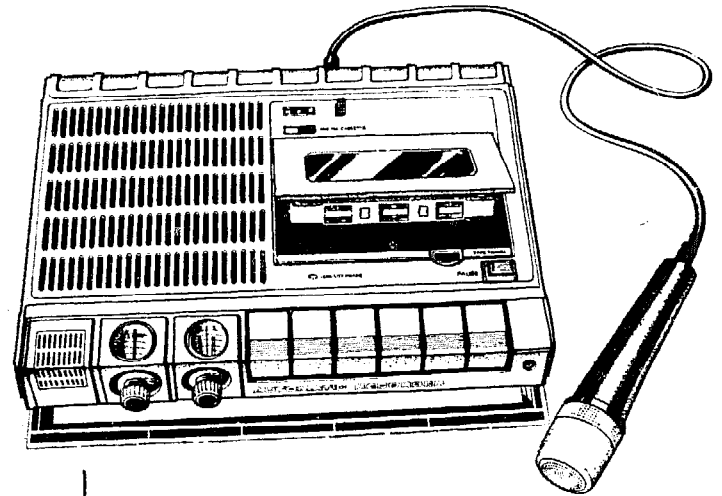

electret
microphone

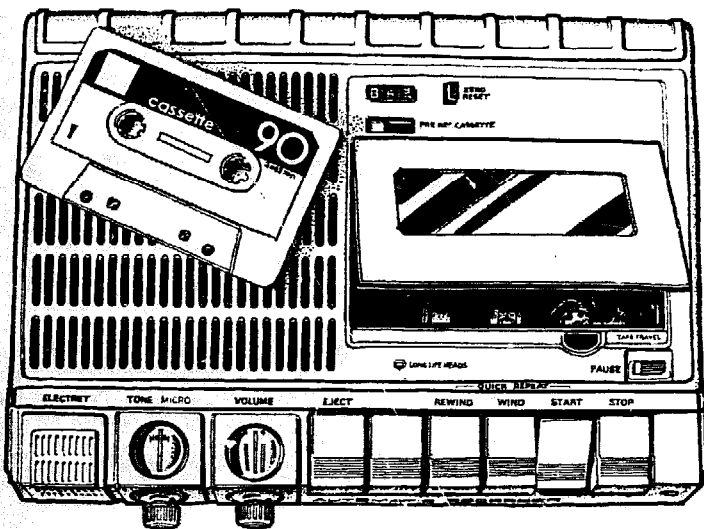

Tape Recorder Maintenance

The tape actually touches the heads as it is drawn across them and, inevitably, particles of the iron oxide coating rub off and get deposited on the heads as a fine dust. If not removed this dust will cause the recorded signals to deteriorate in quality and, eventually, cease altogether. Therefore you have to clean the heads regularly together with those parts of the transport mechanism with which the tape comes in contact. Usually this is done after 3-4 hours of recording, using a matchstick or similar splinter of wood with a small twist of cotton wool soaked in a special cleaning fluid (*see illustration*). Never use any liquid other than this fluid which can be obtained from most cassette service stations or dealers.

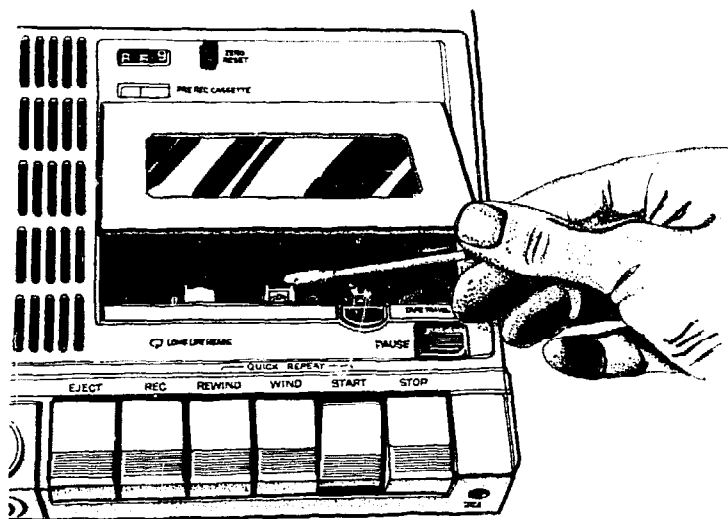

Despite its robust appearance the tape recorder is a delicate apparatus and should be handled and operated with care. It is particularly susceptible to dust and humidity and because of this I strongly recommend that on field outings you wrap both recorder and microphone – an equally delicate piece of equipment – in plastic bags.

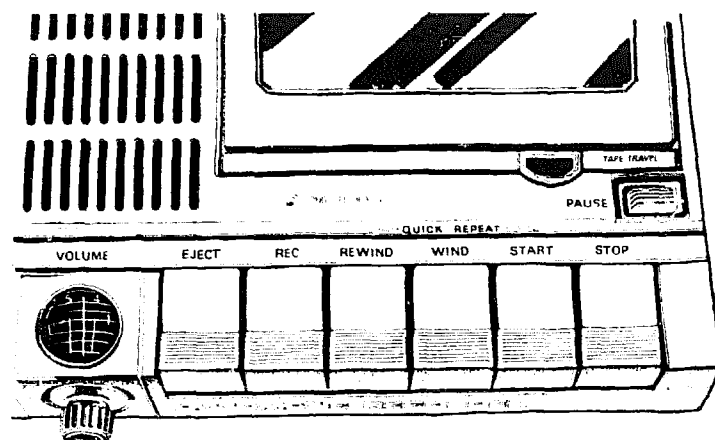

Controls

The *Push Buttons* marked 'Start', 'Stop', 'Record', 'Forward', 'Eject', 'Reverse' are self explanatory. The 'Pause' button, if there is one, needs explanation. When depressed it disconnects the tape transport motor but leaves the amplifier switched on (*see illustration*). This enables you to (a) test and adjust the microphone recording level without running the tape and (b) cut the motor momentarily during an interview should you wish to make a comment that you don't want recorded.

The *Modulation/Microphone* knob or button adjusts the level of the microphone input. Some of the new cassette recorders, called 'automatic', have circuits which adjust the microphone to the correct level electronically; such machines do not have a level indicator or an external knob for microphone level. They possess certain drawbacks which make them less suitable for field interviewing than the non-automatic type. The *Volume* knob usually controls the level of the signal output when played back for listening. Some recorders have a *Tone* or *Tonality* control knob which regulates the frequency range of the playback. As a general rule you should leave it at the top end, i.e. fully clockwise, where the upper (treble) speech frequencies predominate. This makes for clarity. If turned anti-clockwise, to the lower (base) end of the sound spectrum, speech will sound muffled or boomy.

The *Level Indicator* must always be your guide when recording. If the needle is allowed to 'peak' too high into that segment of the indicator usually marked in red, there will be distortion and loss of clarity in speech. On the other hand, if you are over-cautious and keep the recording level too low the result will be a weak signal accompanied by an obtrusive background hiss.

The *Microphone Plug* is a potential trouble-maker. Microphone plugs always tend to work loose, so before a recording begins, be sure that the plug is pushed firmly into its socket on the recorder.

Editing

Sometimes it is necessary to remove from a recording unwanted words or sounds, errors in speech, hesitations, coughs, etc. This is done by physically cutting out the relevant section of tape and then joining the two ends. The exact points for cutting are found by moving the tape spools back and forth by hand across the reproducing (playback) head so that you can hear what you are doing through the loud speaker. Having located the exact spot on the tape you mark it with a wax (chinagraph) pencil at the point where it leaves the playback head (*see illustration*).

The tape is laid in the groove of a splicing block and cut at the marked point, using a razor blade or special scissors made of non-magnetic metal. The cut must be diagonal, at an angle of about 45 degrees; if the tape is cut square, at 90 degrees, the join will be audible on playback as a kind of click (*see illustration*). After removal of the edited section the two pieces of tape are laid end to end in the channel of the splicing block and a short length of special splicing tape is pressed firmly over the join (*see illustration*).

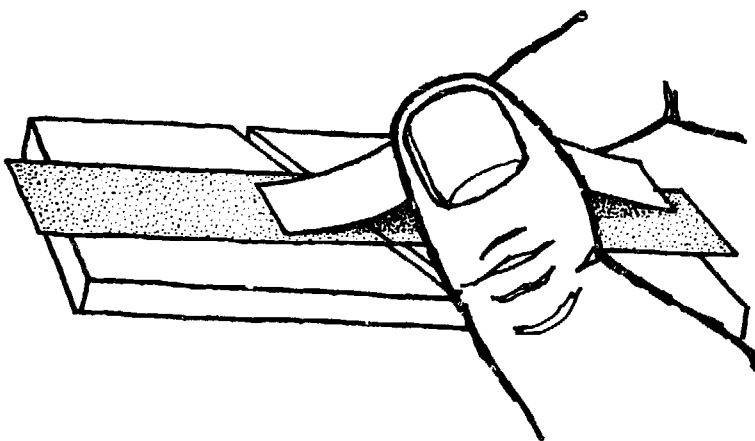
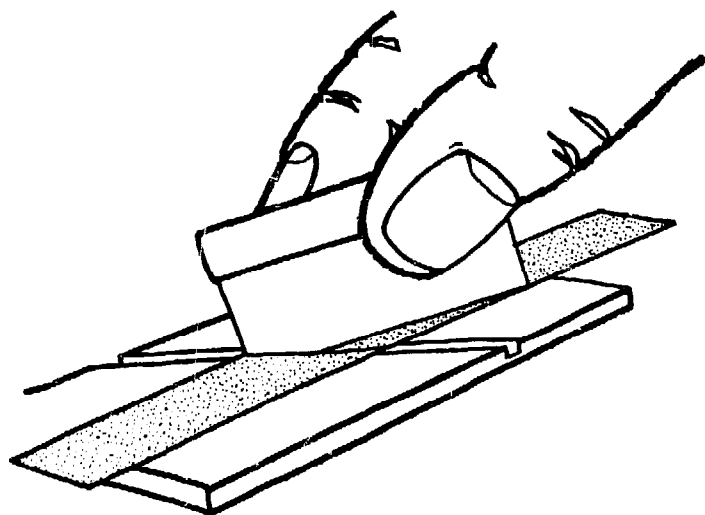
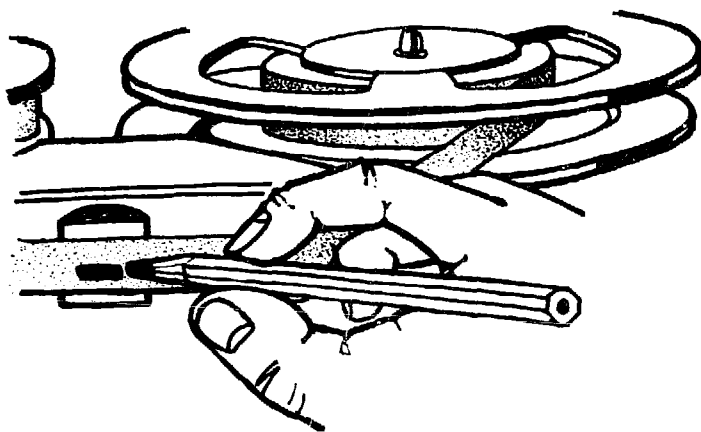
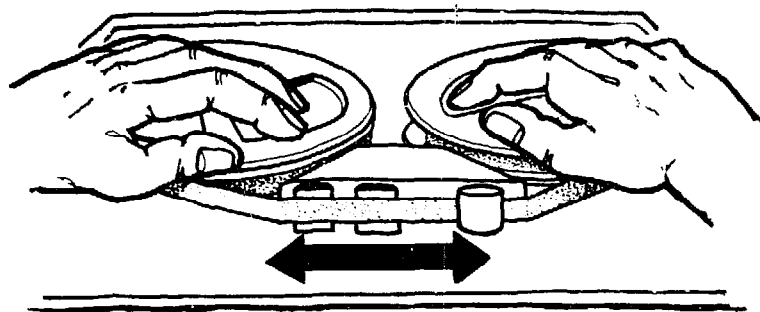

It is not possible to cut a cassette tape without destroying the cassette cartridge. Cassette editing is done by dubbing (transferring) the required material from the cassette to a reel-to-reel recorder, after which the open reel copy can be edited as described above. Some technicians use the dubbing technique in editing – stopping and starting the two machines as required. But this is a highly skilled operation, far more difficult than the cut-and-splice technique. Indeed, tape editing like film editing is something of an art in itself demanding far more than manual skill in cutting and splicing: whether an indrawn breath should be cut or retained, how long a pause or hesitation should be, the exact note on which to cut a musical passage, and so on. Any editing of your recordings will normally be done by trained personnel of the radio station, not by you. However, if you must do it yourself, persuade a local radio professional to demonstrate the technique.

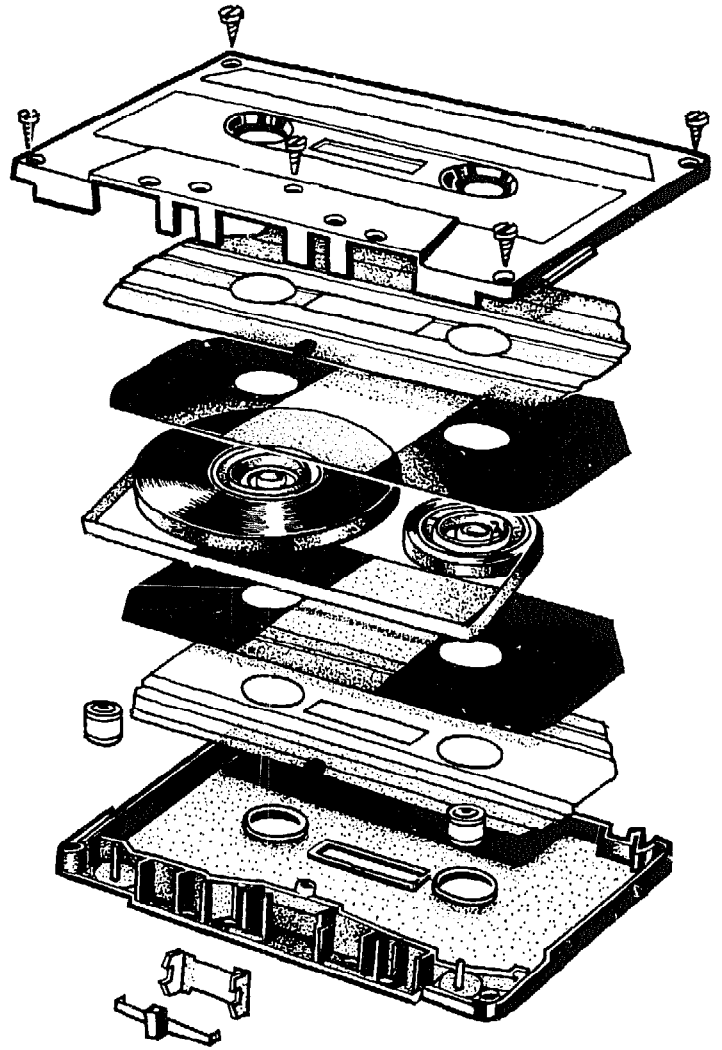

assembly of a cassette tape

*omni-directional
microphone*

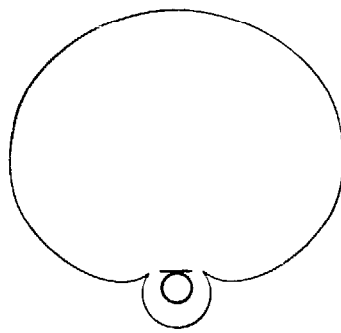
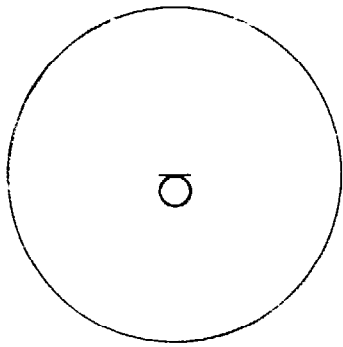

cardioid microphone

The Microphone

Microphones are manufactured in dozens of types, shapes and sizes, but we need concern ourselves with only two: the *omni-directional* and the *cardioid*. The omni-directional microphone, as suggested by the name, is sensitive to sounds coming from all directions, through 360 degrees (*see diagram*). Therein lies its disadvantage in field interviewing: its capability of picking up extraneous sounds which can interpose a distracting background to your interview. The cardioid microphone, on the other hand, is sensitive to sounds coming from the direction in which it is pointing, but insensitive to sound coming from the rear (*see diagram*). Obviously, the cardioid is the type most suitable for field interviews.

To get the best results from a cardioid microphone one should hold it at shoulder level, not higher, and move it from one person to the other (*see illustration*). In holding the microphone the interviewer should take a loop of the connecting cable between his fingers, to prevent vibrations being transmitted to the microphone by the dangling length of cable (*see illustration*).

Most cassette recorders of medium price and reputable make can be relied on to produce voice recordings good enough in quality for professional use – with one proviso: the *microphone* must be of professional standard. The instrument provided with most cassettes is not. The type of microphone we need – the cardioid – could cost as much as half the price of the recorder itself, or even more. It is the one item on which you cannot afford to economise.

The newest cassette recorders often have a microphone (electret) built into the body of the recorder. Obviously it is an arrangement useless for field interviews, or any other kind of interviewing, for that matter. Fortunately most of these machines have a socket into which you can plug an external microphone, which you should always use (*see illustration page 12*).

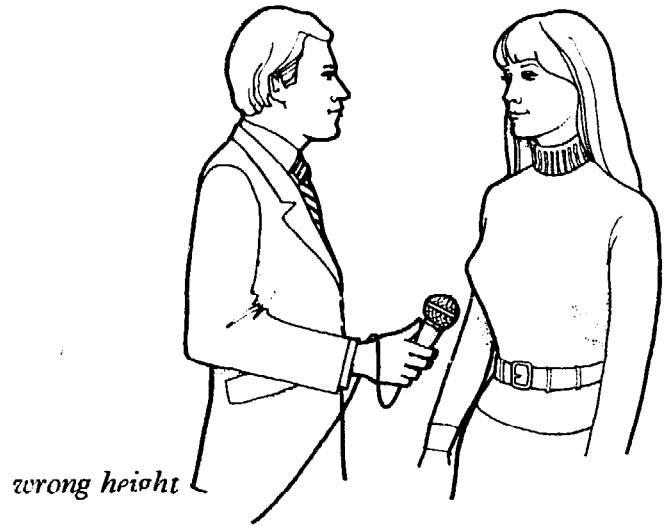

wrong height



correct height

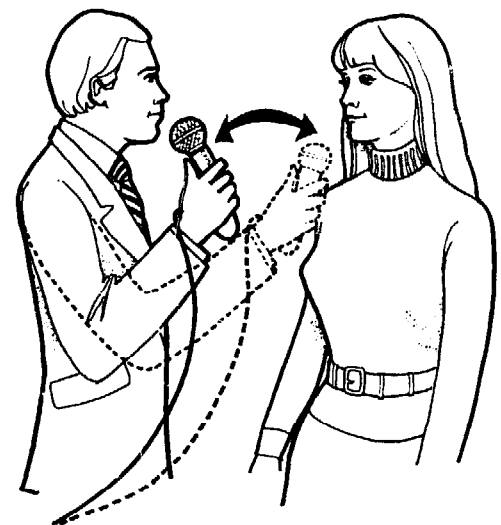

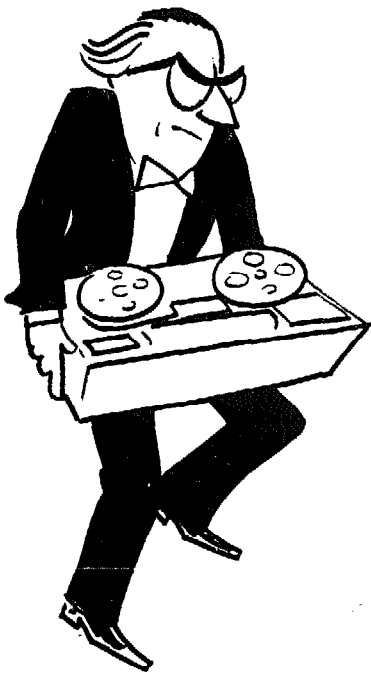

CHAPTER THREE

Recording Drill

(a) Before leaving your office or home :

1. Check the batteries in the recorder. Make sure they are fresh and not run down. Most recorders have an indicator which shows the condition of the batteries. It's advisable to carry a spare set of batteries with you.
2. Place a cassette (or tape) in the recorder and connect the microphone.
3. Make sure the recorder is working properly. Do this by recording a few sentences in your own voice, then run back the cassette to the beginning and turn the switch to 'Playback'. What you have recorded should come through clearly. If you hear crackling sounds its probably a poor microphone connection; check it! If the sound is distorted you probably had the microphone level control turned too high. Repeat the recording, checking that the recording level indicator, with which most recorders are fitted, is not jumping into the 'red'. On the other hand if the playback sounds weak you probably had the microphone control turned too low. Check with indicator and repeat test recording as above.
4. Before leaving be sure to erase the test recordings by running back the cassette to the beginning.
5. It's a good idea to disconnect the microphone before you set out; it may get loosened on the journey if you don't do so.

6. Make certain the recorder is switched off, otherwise you may find the batteries exhausted on arrival at your destination.
7. Don't forget to bring the microphone windshield.
8. Always carry with you at least one spare cassette or tape.

(b) At the recording site :

1. Before you actually start recording, repeat the test routine to ensure that the machine is working properly after what has been, more often than not, a rough journey; check batteries and microphone connection and make a short recording of your own voice, taking care to see the recording volume control is at the right level. If the test is satisfactory, take care to rewind the cassette to the beginning. Do these preliminaries in a quiet corner if you can and not in front of the interviewee (let us call him 'X'); you don't want to make him nervous.
2. Make a short (15-30 second) test recording of X's voice. But first explain why you are doing this; it's embarrassing if he launches straight into speech in the belief that the interview has actually begun, and you have to stop him and start again. Ask him to use his ordinary speaking voice and adjust the recording control to the correct level on the indicator, with the microphone 6-9 inches from his mouth. If the level is too low ask X to raise his voice – people who are nervous tend to speak in a whisper – and if too high either reduce the recording level or move the microphone a few inches further from his mouth. Remember, you must match the level of your voice to X's; you do this either by speaking louder, or more softly, or by moving the microphone closer to, or further from, your mouth. This latter is easier and more convenient.
3. Having made the test recording and adjusted the microphone levels to your satisfaction, be sure to rewind the cassette or tape to the beginning.

4. If you are working in the open air, always place the windshield on the microphone. Never try to record in a wind; not even the windshield will be able to protect the microphone's diaphragm from being overloaded, and the result will be a series of disturbing clicks. In windy conditions try to find shelter behind a wall or tree trunk. If none are nearby, stand with your back to the wind and tuck the microphone inside your shirt or jacket; it will be very uncomfortable for both you and X and should only be done as a last resort.
5. If the recording is made in a room with bare walls, such as a school classroom, hospital ward or office, there is likely to be reverberation (echo) and listeners will be unable to hear clearly the words of the recording. In such surroundings you must make the microphone less sensitive to the background noise level of the room. You and X should speak closer to the microphone, less than 6 inches; you must lower the recording level accordingly, and the level of your voices as well. Failure to adjust these levels will result in a badly distorted recording.
6. Having finished the interview, don't just pack up and move off. First you must be certain the recording is satisfactory. So reverse the cassette for about 15 seconds – not more – and play back the result to the end. Incidentally, to do this is good public relations, most interviewees love to hear their own voices. When you reach the end, *don't rewind*; if you do you risk erasing the recording when you make your next interview. Sometimes you will be asked to replay the whole interview; this should be resisted on the grounds of running down the batteries, which indeed could happen.
7. Before you leave to return home, be sure to switch off the recorder and disconnect the microphone.
8. Also before leaving, see that the various recorded sequences are identified and numbered on the cassette or tape boxes. Never trust to memory!



Introduction

Some family planners have tended to see their movement in crusading terms: population growth is running out of control and straining their country's resources, therefore persuade people to have less children and the result will be a better life for the individual. Unfortunately this simplistic approach often fails to get results and in some societies can even be disruptive. Consider the term 'better life'. In wealthy, industrialized societies it probably means a new car or washing machine, a colour television and holidays abroad. In short 'better' has come to be equated with the acquisition of material things – greed, some would call it. None too soon, there is increasing awareness that the quality of life has deteriorated. The casualties are peace of mind for the individual and the disruption of family relationships.



What does 'better life' mean for a villager in a developing country? Something very different. It means relief from the ceaseless anxiety of whether the rice crop will provide enough food to keep his family at something above subsistence level and keep him out of the moneylender's clutches; at least some schooling for his children; a lightening of his grinding work in the fields from dawn to dusk; a local health service that will provide protection against the more dangerous of the diseases for himself and his family; a little leisure time for talk, play or just doing nothing, and the know-

ledge that he will end his days in some degree of comfort and security. Not much to ask, but for scores of millions no more than a dream.

To translate that dream to reality, to improve the quality of life for the under-privileged – in other words the majority – is the purpose behind the development plans which all the poorer countries have embarked on. And experience over recent years has shown that 'development' means the simultaneous development of the economy, of health and social services, of agriculture and industry, education and information. Inevitably development brings innovation and change which if thoughtlessly imposed can cut across deeply-entrenched cultural tradition and social practices, and these are the very cement of the community structure with its collective concern for the individual members of that community. Rural populations are especially vulnerable. Without the goodwill and the cooperation of the people at large the efforts of the planners will come to nothing. This is where education and the information services should play a vital role, in bringing about a painless acceptance of the changes that must come.

That is all very interesting, you may say, but how does it affect me as a worker in the family planning movement? Where do I fit into this scheme of things? The answer is that family planning must be seen not as an end in itself but as one thread in the overall development pattern. It is an attitude that, wherever possible, should be reflected in your radio material, something to hold in the back of your mind when conducting interviews with villagers whose experience and interests, problems and aspirations are limited to their own locality.

Example: you have set the scene and are about to introduce a leading village personality – possibly the head man or the teacher.

Question: I see you have a new school here. How did that come about?

Answer: The old school needed many repairs which would have cost too much. But most of all we needed a bigger school because we have more children in the village.

Q: Oh! more children! Why is that?
A: One reason is better health. Less of our children die as babies or when they are young.

Q: Better health, you say?
A: Yes. We have this mobile clinic coming round from time to time. And we have a building for them to work in. We built it ourselves.

Q: You mean the villagers?
A: Yes. We supplied the labour and some of the local materials – the Government gave the rest and the equipment.

Q: So people here are richer than a few years back?
A: No, worse off! The cost of so many things has risen. School books, for example. And this last two years the weather has been bad for the crops.

Q: Well then, with those problems, wouldn't it be a good thing to practice family planning?
A: Oh, we do! That's part of the mobile clinic's work.

Q: How many of the women accept family planning then?
A: About a third, but the number is increasing.
etc, etc

In that interview, the interviewer first exposed several significant social points: increase in child population and the reason (improved health service); attempt of education authority to keep pace (new school), villagers' self-help despite increased poverty (building of clinic). Only then did he introduce the family planning element, putting it in correct social perspective. He could have gone further into the building of the clinic, as being newsworthy as well as praiseworthy.

The kind of approach to avoid:

Q: What is your occupation?
A: I work on a rubber plantation.

Q: Are you married?
A: Yes, about 12 years.

Q: How many children do you have?
A: Seven.

Q: Do you want more or less?
A: We don't want any more. We can't afford it.

Q: Are you practising family planning?
A: Yes, there is a family planning clinic on the plantation.

Q: What method do you use?
A: The pill.

Q: And does it have any ill effects on your wife?
A: Not now. Only at the beginning.

Q: Thank you.

That interview is typical. It is dull and stereotyped. It offers nothing new and lacks human interest. And it made family planning the central theme, indeed the only theme, thus failing to place it in the larger social context.

Preparation

For the professional interviewer who has to be ready to interview anyone on any topic, research into (a) the topic and (b) the interviewee 'X' is essential. In short, although he himself is not an authority on any given subject he must make himself sufficiently well-informed on that subject to be able to ask the questions that will earn him the respect of X. For you, (a) does not apply so far as the subject of family planning is concerned, although you will have to take into account the overall social background of the village, as described in the Introduction to this chapter. Therefore your main interest will be in (b), the personality of X.

First seek out someone who knows the village intimately – the headman, teacher, local fieldworker or other prominent personality, and get him to fill in for you the village background; its problems, its personalities, its innovations, its scandals even. And ask who would be good to interview. Having got one or two names, make a few notes about the person's

characteristics and habits. He'll be surprised and flattered when you come to interview him and reveal that he's not unknown to you. Drawing on what you have learned, make a short list of tentative questions. Now you are ready to seek out your first victim, test the recorder as laid down in the chapter on recording drill and start your interview.

Setting the Scene

If you are to engage the radio listener's attention, your opening words are vitally important. In them you must make him 'see' where you are and what is going on. And you must do this in a few carefully worded phrases – so carefully worded that it's a good idea to think about it beforehand and write them down to read as the opening to the interview. It follows that it's essential to use your eyes in setting the scene. It's not enough to say 'I'm standing in a field. It's 6 o'clock in the morning, and with me is a farmer'. Rather: 'The sun is just rising above a line of low-lying hills over to

my right and the countryside is coming awake, as you can hear from the birdsong. It's the moment when farmers are starting the day's work and Mr X, who's standing beside me is no exception, etc. . . .' A vivid picture has been conjured up and you've established by implication that the time is around dawn and that you're in a field to talk to a farmer; moreover you've taken advantage of the background noise (birdsong) to add actuality to the scene.

Background noise can often provide a good lead-in to your interview and at the same time help convey to the listener where you are making your recording, but be sure to identify the sounds for the listeners and thereafter keep them well in the background.

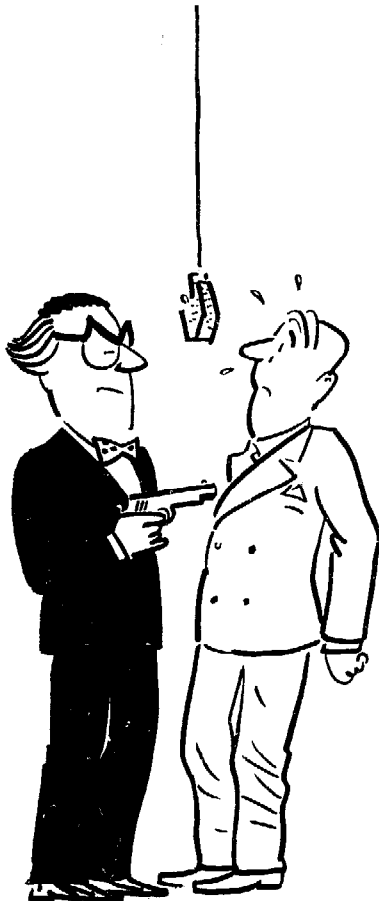

Example 1

(Noise of machine, say for 15 seconds)

Interviewer: 'Those sounds are made by a machine used for extracting oil from the fruits of the oil palm. This mill which is some thirty miles from Kuala Lumpur is surrounded by acres of oil palms, part of a large plantation, large enough to have its own family planning clinic. But first I'm going to ask the Manager here with me to describe the process and talk about the importance of the mill to the local economy. Mr X'.

Example 2

(General noise background – say 15 seconds)

Interviewer: 'This is a government housing estate at. . . Each flat consists of 2 rooms – a kitchen and a living room, where I am now. Several children are crowding the doorway, staring at me full of curiosity and in a corner there's a baby in a cot – as you can hear. On the wall opposite is a coloured picture of the Virgin Mary and below it is a sewing machine surrounded by pieces of cut out cloth. With me is the flat's occupier, Mr X'.

Q: Mr X, that sewing machine looks well-worn.

A: Yes, it's mine. I'm a tailor, etc. . . .

The interviewer here used his eyes to good effect and set the scene well. The Virgin Mary and the sewing machine not only conveyed a vivid picture of the room but established the religion of the occupier (Catholic) without saying so, and his occupation (tailor), without having to ask 'What is your job?' By mentioning the children in the doorway and the baby in the cradle the interviewer prepared the listener for any noises they might make during the interview (as indeed they did). Also during the interview a little boy rattled into the room on roller skates; at once the interviewer broke off to identify the sound of the skates while the mother called to the child to stay quiet. All this provided a nice piece of domestic 'colouration' to the interview and enabled the interviewer to switch naturally from the father to the mother in his questioning.

Example 3

The scene is a sugar plantation in the Philippines. A family planning 'motivator' is addressing a group of some 30 women in the shade of the plantation clinic. Using his eyes as well as his ears, the interviewer had noticed a cluster of men standing nearby and listening intently. Quick to take advantage of the situation, he rapidly described the scene (place, motivator, women) taking care that the motivator's questions and the answers came through as background to his description, then quickly he moved across to the men to collect their views on family planning, thereby airing a number of prejudices.

This recording was very effective. The scene was clearly set and an element of conflict introduced – which always makes for good broadcasting – in this case female versus male.

To sum up. Use your eyes as well as your ears; take advantage of background sounds, but keep them unobtrusive; describe by implication rather than flat statement.



Conducting the interview: in the Village

1. Keep your approach relaxed and friendly. Above all, avoid the teacher-pupil attitude.

2. Seek to put X at his ease by first asking him a question about himself or his family and friends, or about his village generally, based on what you have already learned and noted from the headman or teacher. If possible make a joke or light-hearted comment. Remember that to him you are a stranger from 'outside', but he will be quick to notice and pleased if you reveal inside knowledge of his community. The intention is to put him at his ease before the interview itself begins.
3. Try to interview X in his natural work or living surroundings. Not, for example, a farmer in a schoolroom or the teacher in an animal compound. Select the coffee shop or village grocery, or out in the fields, or inside a woman's own house (if it is not taboo, of course).
4. In setting the scene, take care to identify the village by name. Later it will give the villagers a thrill to hear it named on the radio.
5. Don't use 'time' words in introducing the interview: words such as 'This evening', 'This afternoon', 'Good morning'. Remember the interview may well be broadcast at other times of day.
6. Always identify X by saying who he is and what he does, at the beginning of the interview and at its end. During the interview again address him by name.
7. Have on a scrap of paper the questions you intend to ask. However, if X says something interesting or startling which you had not anticipated, don't hesitate to follow it up, even if it means dropping one of your prepared questions. In short, keep the interview flexible.
8. Don't ask too many questions. Better to have a shorter interview with only two or three good questions.
9. Ask one question at a time. If you ask double or triple questions, for example 'Where were you born; how many children do you have; are your parents alive?' you will certainly confuse X.
10. Be careful to phrase questions in such a way as to extract information from X. Don't take over the interview by giving all the information yourself so that X can only answer 'yes' or 'no'. A bad question would be: 'I understand this is a new school-room and that the villagers built it themselves because there are more children in the village. Is that so?' The right kind of question will start X talking. Always bear in mind that X is the 'star' and that the interviewer should keep himself firmly in the background.
11. Try not to make comments on what X says: 'I see', 'Yes', 'That's very interesting', 'good', etc. Such comments tend to interrupt the flow of the interview, and anyway sound patronising – the teacher to pupil attitude coming through.
12. Try to end on a high note – even if it makes the interview shorter than you intended – a strong point of argument or an amusing remark by X or yourself. Don't let it just tail off to end in a weak 'Thank you'.
13. Sometimes X will be deliberately non-cooperative, refusing to answer question in anything but monosyllables. Or he may be mischievous, throwing your questions back at you: 'Yes, but what's *your* opinion?' And if you give your opinion you will have fallen into the trap and lost control of the interview. Your only recourse is to say firmly: 'That's of no importance. It's your opinion we want'.
14. If it becomes obvious that X is shy or not prepared to speak freely, then abandon the interview by thanking him courteously and moving away.
15. Field interviews should be restricted in length to 4 or maximum 5 minutes.

Conducting the interview: in the Clinic

1. The questions you ask depend on who X is or what he does. If a doctor or nurse, the questions will be at a different level from those put to a village acceptor'.

2. Warn the doctor or nurses not to use medical jargon in their responses. If they cannot avoid it, then they must explain what they mean in simple terms.
3. Ask the doctor or nurse whether there are any acceptors or enquirers present who can speak easily, have a story to tell or are likely to be amusing. Then seek them out and interview them. Here we have the homework/background preparation at work.
4. In a clinic you will surely have babies crying or making goo-goo sounds. So much the better! They provide a lively atmosphere. But do take care to keep the crying very much in the background.

Possible Places for Interviews

Literally anywhere where people gather: village festivals; markets; mothers', women's and youth clubs; community centres; factories; beauty parlours; trade union headquarters; railway workshops; cafes; clinics barracks; seaports; mobile audio visual units (MAVUs); etc. The list is endless.

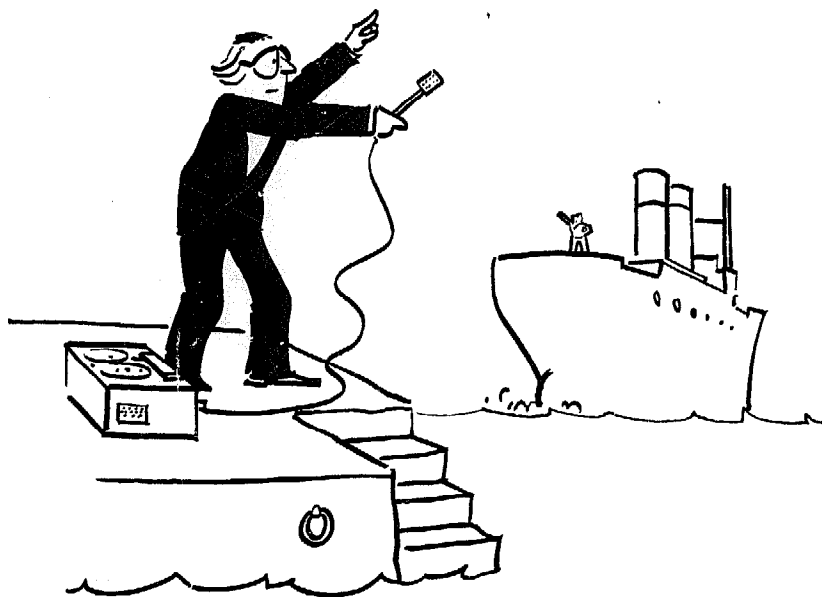

CHAPTER FIVE

The Radio Talk – Script Writing

In the chapter on interviewing it was emphasized that an interviewer should keep himself or herself firmly in the background and concentrate on persuading the person interviewed to do the talking. However, when you broadcast a talk you do so under your own name, speaking as an authority on your own subject – family planning. Such talks are, in effect, compositions and have to be written down, unlike the field interview which is recorded extempore and conducted in everyday conversational language. This is the secret of the liveliness of field interviews. Liveliness is what holds the listener's attention, just as surely in a studio talk as in a field interview. How then do we go about putting together a radio talk which is both informative and lively?

At once we come up against what seems to be a contradiction in terms: 'writing' is one thing, 'talking' another. Apparently we have here two different means of communication, one making use of the eyes, the other of the ears. But is this really so? In conversation we watch closely the changing expressions on the other person's face, the movement of his eyes, his hands or his body, movements which reinforce the meaning of the words he is uttering. 'Visual signals' we call them. So that, unless we happen to be blind, we do use two of our senses in talking. 'What a pleasant person she is' seen on the printed page could have only one meaning, but if spoken by someone with an expression of loathing on his face the phrase would convey just the opposite interpretation. However, a radio listener gets no visual signals from the black hole of his loud-speaker. All the meaning has to be in the choice of words and in the way the words are arranged.

One might argue: why not sit down at the microphone and just talk on the chosen subject? Sadly, that is a rare gift! Most of us when we talk throw words around almost with abandon – we repeat ourselves again and again, we leave sentences hanging in mid-air, verbs are left without objects, grammar becomes a casualty, we wander from the subject. That sort of talk would be intolerable to the radio listener. Even the experienced lecturer will always have his notes at hand to keep him on the rails. Furthermore a speaker on the radio is given a fixed period of time in which to broadcast what he intends to say. Hence he has to regulate his thoughts and there is only one way to do this:



write them down. Yet as soon as we put them on paper our natural tendency is to write for the eye and the result is a literary exercise. This is simply not acceptable for radio, which demands a conversational style but without the sloppiness of normal conversation. It has been said again and again that of all the forms of writing, the radio script is the most difficult to do successfully, and I for one would heartily agree.

The radio talk is also the hardest of all the radio formats to write and present convincingly. A brief comparison of radio with television will show why. Television is two-dimensional, that is to say it is seen and heard with eyes and ears simultaneously. Radio, on the other hand, is one-dimensional in that it uses only the ears. However, radio does need a second dimension and this provided by the listener's imagination. That is why in drama and documentary programmes we reinforce the words by making use of sound effects, background noise and music, these help stimulate the imagination of the listener. An important point to remember is that the mind-pictures which radio conjures up will be unique to every individual listener. If I, on radio, describe a tall, dark man with a moustache, the figure you will see in your mind's eye, as we say, will be different for each of you. Whereas on television, were I to show a tall, dark man with a moustache, everybody would see the same man. The imagination is not called upon to work at all in tele-



switch off. Therefore you must construct and deliver your talk in such a way that the listener will not be prompted to shout 'stop' or 'go back' but will be carried along effortlessly on the stream of words. In planning a talk you must make certain that each sequence, whether it be idea, proposition or argument, emerges naturally from the sequence that preceded it. It is like building a house: you start by laying one row of bricks, then another and another until you reach the roof and the structure is complete. Sentence should follow sentence in smooth, logical succession. There is no place in radio for such 'jump-around' words as 'the former', 'the latter', 'the preceding'.

vision. Unfortunately, the sound effects and music so necessary to radio drama and documentary cannot be used to reinforce the imagination in a radio talk, which has to rely for its impact on words alone. If we neglect to choose and marshal those words in particular ways, the clicks of listeners switching off will be deafening throughout the land. In writing a talk there are three elements to consider: Structure, Treatment and Presentation.

Structure

1. *General.* When reading from the printed or written page one pauses from time to time to consider a statement or point of argument, and sometimes one goes back a line or two to re-read a paragraph or sentence not wholly understood. So the eyes are continually flitting back and forth over the lines of words. When listening to the radio one's ears can't have this flexibility. The listener cannot say to the broadcaster: 'Stop, I want to think about what you've just said' or 'Please go back and repeat that last sentence.' Let me illustrate with an analogy. Imagine you are in a darkened room. On a table before you is an open book which you cannot see. Suddenly a narrow beam of torchlight starts to move across the page, illuminating only one or two words at a time. You, the reader, have no control over the torch which travels on at unvarying pace, line by line; you cannot stop it or cause it to go back. So it is with radio: the flow of speech goes steadily on and all the listener can do is go on listening or



2. *Development.* A radio talk must have a clearly defined beginning, a middle and an end. It should be a neat package made up of three distinct, though unified, sections: (a) brief introductory remarks, (b) the body of the talk, which enlarges on the subject being presented and (c) a conclusion which is a summing up of the points made in the body of the talk.

3. *Introduction.* The introductory remarks are vital. In that first 15 seconds or so you will either capture your listeners' attention or lose it. Therefore start with an ear-catching or arresting remark. *Example:* 'Today I'm going to talk about the relationship between the world's over-population problem on the one hand and its food production on the other. First, some figures, etc.' *Comment:* A clear straightforward introduction, but dull; hardly likely to arouse interest. Now this: 'I'm going to start by clicking my fingers' (does so, several times). 'With each click another child was born into the world, in 10 seconds – 20 more children. With every hour that passes there are 7,000 more mouths to be fed. That's nearly 200,000 a day. At that rate the world will have doubled its population by the end of the century yet, even now, two-thirds of our fellow-humans are underfed.' *Comment:* An arresting statement, calculated to startle the listener and make him curious to hear more. Moreover, it presented the statistics (figures are always difficult for the radio listener to digest) in a dramatic form likely to stir the listener's imagination.

3. *The Sentence.* Use short, simple sentence. Long or compound sentences containing several ideas or propositions are certain to lose listeners. The mind simply cannot cope with intricate arguments or statements through sound alone. So not more than one idea or proposition to one sentence.

4. *Clauses.* Keep dependent clauses to a minimum.

Example: 'The fortune left to Smith by his grandfather, who had been a thrifty man – he invariably made a point of not tipping waiters and porters – made it unnecessary for him to work for a living.'

Comment: In that sentence with its clauses the meaning is clear enough – to the eye. But for radio it wouldn't work; it would have to be split into two sentences and re-arranged:

'Smith did not have to work for a living. He'd inherited a fortune from his grandfather, a thrifty man who invariably made a point of not tipping waiters and porters'.

5. *The Verb.* Keep the subject/object close to its verb. Not: 'My secretary, despite distractions that never let

up for a moment and which left her little time to do other than routine work and deal with matters needing urgent attention, found with considerable difficulty and not a little exasperation the missing file of instructions'.

Comment: Even for the eye, that is a poorly constructed sentence, although not untypical of normal conversation. Lost in a confusion of clauses, the main verb 'found' is a fugitive from both its subject and object. For radio the sentence would have to be split into three, re-arranged and the wording changed somewhat. 'My secretary found the missing file of instructions with considerable difficulty and not a little exasperation. I may say she managed it despite distractions that never let up for a moment and left her little time to do other than routine work. Moreover she had to deal with matters needing urgent attention'.

6. *Grammar.* Don't worry too much about following all the rules of grammar. Stick too closely to the rules and your speech can sound stilted: 'The man about whom you made enquiries' becomes 'The man you enquired about', which is what we would say in conversation. And don't hesitate to open a sentence with 'And' or 'But'.

7. *Punctuation.* When writing your script, bear in mind that the voice can express only four punctuation marks: the question, the comma, the full stop and parenthesis, i.e. brackets or dashes.

8. *Active and passive.* It sounds livelier on the air if you use the active voice rather than the passive: 'Her father opened the door' rather than: 'The door was opened by her father'. Or 'The neighbours are preparing a feast' instead of 'A feast is being prepared by the neighbours'.

9. *Duration.* Radio producers usually treat a short talk of 3 to 6 minutes as one item among others, for inclusion in magazine-type programmes. The talk of 10 to 15 minutes duration goes into a subject in greater depth and usually is presented as a programme item in its own right. Fifteen minutes is about the maximum length a listener can take in.

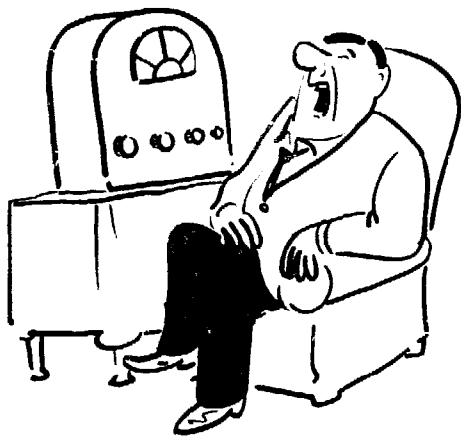

Treatment

eye caught the glint of light on her *greying* hair reflected from the chandelier. He moved towards her, his *heavy rubber boots* making no sound on the *thick pile* of the carpet. She spoke, 'Can I offer you something to drink - *champagne*?' The key words are italicised. Without actually saying so, we have established (a) she is a forceful character (*strode*), (b) she did not expect to find him in the room (*surprise*), (c) she is middle-aged (*greying*), (d) the room expresses luxury (*chandelier* and *thick pile*), (e) the man is not her social equal (*heavy rubber boots*) and (f) she is wealthy (*champagne*).

The Voice. In a radio talk it's not only the words that convey meaning but also how they are said. The voice can lay stress on a word to emphasise the meaning, can pause to produce a dramatic effect, can suggest mood by inflection. Take account of these possibilities when writing the script.

Emphasis. To drive home an important point, do not hesitate to repeat it. And leave your most important point to the end; it is always the last few words spoken that stick in the listener's mind. Radio advertisers know this well and often end their 15 seconds or so of 'persuasion' with an ear-catching slogan.

The Question. A useful device is to put the information in the form of a question, which you then answer: 'Is there an injectable contraceptive? Indeed there is, and it's called, etc.'

Comparisons. It helps listeners to grasp your meaning if you compare with something they know that can be visualized: 'It's very small - (about the size of a fingernail)', or 'It's a large animal - (about the size of an elephant)'.

Approach

People listen to the radio primarily to be entertained; if they are lectured at or bored then 'click' will go the OFF switch. Therefore keep the writing lively and colourful. Wherever possible reinforce an argument or proposition by illustrating it with an anecdote: 'Something like that actually happened to a farmer I know. He was going . . . etc.' Throw in a touch of humour occasionally, but be careful how you do it; humour can sometimes give offence, especially in so sensitive and personal an area as family planning.

The golden rule for a talk is: have something worth saying, say it as precisely as you can and as briefly as you can. Ration the number of points you want to include; too much information gives a listener aural indigestion - *if* he stays listening! Cut ruthlessly all superfluous words - make every word work for its inclusion.

Audience

Write for your audience. If talking to villagers, you use words and phrases that differ from those addressed to, say, fieldworkers or officials. Mass audiences are not intellectuals but neither are they children.

Person-to-person

Don't cut yourself off from the listener by using 'you' and 'I' when describing some action or other: '*You* must be careful not to waste food' sounds patronising; it is the teacher instructing the pupil, and nothing irritates listeners more. '*We* must be careful not to waste food' is the correct psychological approach. And never say 'listeners are aware of', but 'as you know'. *You* are talking to *me*.

Writing

Strive to avoid dull, flat writing. It is often more effective to suggest than to state outright; you can usually convey the information not only more colourfully, but with an economy of words. *Example:* 'She *strode* into the room and paused in *surprise*. Looking at her, his

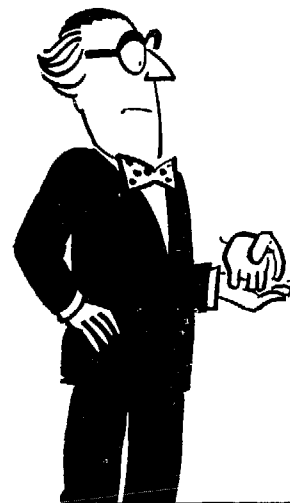

Statistics. If you must include statistics, use them sparingly. Numbers, like a row of facts, make for aural indigestion. Large figures should be rounded off: 'half a million' is easier to grasp than '495,760'. Keep clear of percentages. Say one-third rather than 33%; nearly all, rather than 90%.

Etcetera. Never use written 'shorthand': etc., viz., e.g. Say: 'and so on', 'namely', 'for example'.

'Tongue Twisters' For your own peace of mind, avoid writing tongue twisters: 'A welcome to the thirty-first thousandth member of our radio club'. 'In an uncomfortable bed', 'his sixth sense suggested'. I once had to read in a news bulletin the words 'According to a leading Swedish newspaper'; what I actually said was 'According to a Swedning leadish newspaper'.

Jargon. Jargon is acceptable between persons in the same profession or line of business, but it means nothing to an outsider – and in that sense all listeners are 'outsiders'. So avoid jargon. However, family planners cannot escape the technical terms of the medical profession which are, of course, jargon. So whenever you use a medical expression, be careful to explain its meaning.

Abbreviations/Acronyms. These are a form of jargon – 'in' expressions which have been described as 'verbal virus of communication'. *Example:* APH is ADG of OPI in the ECAFE Office at UN HQ'. What could a radio listener make of that? If you must use an acronym, be sure to say what it stands for: 'WHO – the World Health Organization'.

Sentences. Keep your sentences short; this will help you to think in precise terms and your listeners to follow your meaning with ease. A good guide to length: a sentence should not be longer than you can carry on a breath. Avoid devious sentence construction like the plague. Here are typical examples extracted from official reports ('officialese'). The radio equivalent is bracketed alongside each one:

1. Food consumption has been dominated by the world supply situation. (People have had to eat what they can get).

2. The cessation of house building operated over a period of five years. (No houses were built for five years).
3. From a cleaning point of view the shelving is too high. (The shelves are too high for cleaning).
4. Consideration should be given to the possibility of carrying into effect. (Think about taking action).
5. The problem is likely to continue in existence for an indefinite period ahead. (The problem is likely to continue indefinitely).
6. The children were evacuated to alternative accommodation. (The children were taken to another house).
7. The crunch will come if the new scenario drives us into a bottleneck situation at the end of the day. (Typical, nonsensical jargon).

The Choice of Words. You are writing for the ear, not the eye, therefore select informal, everyday words such as we use in conversation. Prefer words which are in your spoken vocabulary, the common rather than the less common, which may be outside some listeners' vocabulary. Unusual words may make a speaker feel important but they can block communication and irritate the listener.

Length of Words. Avoid polysyllables. The shorter a word the stronger its impact on the ear. The synonyms given below illustrate this:

| | |
|--------------------|--------------------------|
| try | not endeavour or attempt |
| results or effects | not repercussions |
| go | not proceed |
| most | not majority |
| tell | not acquaint |
| send | not transmit |
| some | not proportion of |
| happen or occur | not materialize |
| begin or start | not commence |
| plan | not blueprint |
| end | not terminate |
| before | not prior to |
| help | not assistance |
| cost | not expenditure |

Pomposity

Stock to the simple. Avoid such conceits as:

- 'a certain area of readership' for 'one group of readers'
- 'consumer oriented' for 'in favour of consumers'
- 'ablution facilities' for 'washroom'
- 'teaching situation' for 'classroom'
- 'in relation to' for 'with'
- 'with regard to' for 'in'

Absolute Words. Don't qualify words of absolute meaning. To prop them up with adjectives is to weaken them:

- (high degree of) perfection
- (somewhat) unique
- (definitely) harmful
- (near) refusal
- (comparatively) small or large
- (great or serious) danger
- (overall) average
- (quite) wrong
- (very) remarkable

Metaphors. Metaphors are useful imagination stimulators but are only too easy to mix and thus provoke laughter: 'There's no sense in breaking our backs to keep our heads above water'. Treat metaphors with care.



Cliches. Writers are always advised to avoid cliches but often cliches are invaluable because they convey exactly what we want to say. Nevertheless some are worked to death: 'long hard look', 'rushed to hospital', 'a breakthrough', 'spell out', 'first and foremost', 'there's many a slip', 'face up to reality', etc.

Word Pictures. Sometimes, if one is lucky, one can dream up words and phrases that cause a talk to light up: 'the house wore a surprised look', 'a man of grinding rectitude', 'she didn't unbend - she verbally unbuttoned', 'he devotes most of his time to the neglect of his duties', 'the highest products of civilization are those who have the capacity to endure it', 'the man's a

hurricane on two legs', 'X country is a functioning anarchy', 'the milk of human kindness is bad for the liver', 'his inertia is so great it becomes a moving force', 'what a flood of indifference that invokes', 'people are caught up in the web of their time', 'History with its flickering lamp stumbles along the trail of the past, trying to reconstruct its scenes, to revive its echoes, and kindle with pale gleams the passion of former days' (Churchill). Descriptive words in general provide that vital series of images which the listener's imagination needs.

Adjectives. Economise in adjectives, especially vague adjectives: substantial, appreciable, considerable. Unless, of course, you are being deliberately imprecise.

Onomatopoeic words. These words which resemble the sound they represent are very useful in radio writing. Like sound effects, they stimulate the imagination. Examples are: snake, slither, soft, gentle, snap, vicious, bang, slow, weary, quick, snug, crack, limpid. Say them aloud and you'll hear what I mean. Advertisers on radio and television are given to using onomatopoeic words. An example: 'Feel how X's soap glides smoothly and gently on the skin, soothing and relaxing tired tissues.' Several famous examples of onomatopoeic composition can be found in Gray's poem 'Elegy Written in a Country Churchyard'. Here is one: 'The curfew tolls the knell of parting day, the lowing herd winds slowly o'er the lea, the plowman homeward plods his weary way, and leaves the world to darkness and to me'.

The teller of stories has always been held in esteem throughout history, particularly in non-literate societies where he was often the sole repository of folk or tribal memories. As a spinner of words he knew how to hold his audience spellbound, by firing their imagination. Which is just what a successful radio talker does to his unseen listeners. In describing how words can be used and, as often as not, misused I have tried to show how they can be spun into a design, to emerge as a story rather than a dull procession of facts and ideas. The do's and don'ts of verbal communication in the English language are the subject of this chapter but parallels will assuredly be found in all the major tongues of this polyglot world of ours.

Presentation



Attitude. When we broadcast it is wrong to think of ourselves as addressing an immense crowd, an audience of thousands. If we do that we become orators. In reality we are talking directly to two or three people in the privacy of their home or maybe a small group of villagers around a transistor. So adopt a conversational style of delivery. Visualize a friend in the studio listening to you on the other side of the microphone, and pitch your voice accordingly. Avoid the teacher to pupil style and never patronise by adopting the attitude of the expert talking down to the uninformed.

Person to Person. This visualizing of a friend on the other side of the microphone helps when arguing a controversial proposition in your talk. Think of him as being well disposed but slightly critical and set yourself to convince *him*. Radio is very much a person to person affair.

Speed. Don't read fast. In conversation we tend to speak quickly. This will not do for radio because the listener will be unable to keep up with you. A slow speaker reads at about 120 words a minute, a fast speaker as high as 160. A good average for radio is around 140 words a minute.

Variety in Delivery. Vary the pace of your delivery and vary the length of pauses between sentences and phrases, otherwise the most carefully constructed script will sound monotonous and boring. For example, when you have said something you consider to be especially noteworthy, pause for effect; that is to say, leave a slightly longer pause than usual before reading the sentence that follows.

Using the Voice. The words in your script have to be given meaning through your voice and this you do by emphasizing key words, slowing down or pausing for meaningful utterances, changing the tone of your voice according to the seriousness or lightness of what you are saying. In short, you have to be something of an actor. This side of 'presentation' is usually taken care of by a station talks producer who listens to your talk before the broadcast and gives hints about how you should deliver it. However, you cannot always count on professional help, especially if it's a small

broadcasting station you are concerned with. So, it's not a bad idea to read your talk aloud to a friend beforehand and take note of his or her comments. In effect, a rehearsal.

Punctuation of Script. You will not be able to keep in mind all the pauses and key words to emphasize, so punctuate the script at rehearsal: underline for emphasis, for rising voice inflexion— for falling voice inflexion— dashes to indicate a pause, brackets for parenthesis. But do be careful in marking up your script, or the result can be embarrassing. There's a well-known example heard over the BBC some years back when a disc-jockey announced a newly introduced hit 'What now my love?' (meaning 'what happens from now on?') as follows: 'What — now my love?'

Timing. Always time your script beforehand, by reading it aloud to a watch or clock. You don't want to have to start removing whole passages of a carefully constructed script immediately before you go on the air.

Gestures. It is natural for some people to gesture while talking: to handcuff such persons is as effective as gagging them. If you are one of these don't be put off by the microphone and gesture away as you would in conversation. Beware, though, of your flailing arms or you may strike the microphone or even worse, as happened many years ago in a studio of the Palestine Broadcasting Service. One of the news readers — a large, muscular woman addicted to gesturing — was delivering a bulletin when a sub-editor, who happened to be a small rather timid woman, crept in with a last-minute news item. As she was trying noiselessly to push the piece of paper in front of the microphone, the news reader flung wide an arm, striking her colleague on the jaw and stretching her senseless on the studio floor.

Script Handling. Be careful how you handle your script. Don't scruffle the pages around and when you finish a page, slide it carefully to one side rather than lift it. A rustling script sounds like thunder to a listener. It's easier to handle each page noiselessly if you turn up the corners.

Inflexion. Try not to drop your voice at the end of sentences. The microphone will miss the last word or two and so will the listeners.

Be my Guest. A radio speaker is in effect a guest in the listener's home; therefore he should behave as such, with courtesy, and an avoidance of coarseness or vulgarity in his address. A friendly chat is the thing to aim at. The late President Roosevelt's popularity was largely due to his regular 'Fireside Chats' over the radio.



The Radio Talk: Ten Illustrations

A news bulletin has only one format, as we shall discuss in a later Chapter. Not so the radio talk which can be cast in any number of formats, limited only by the writer's imagination. The excerpts that follow have been selected to illustrate a few of the wide variety of approaches open to a script-writer.

Example 1 Jam-packed Seoul Bus

It's a bright Monday morning. Another busy week has just started in this crowded city.

As usual, Mr Kim, a furniture salesman, left his home for his office. When he reached the bus station, a long line of people were already thronged there. A bus arrived but it was fully loaded and only a few people could get into it. Mr Kim had missed five buses already. He grew fearful that he might be late in his office. A scowling boss's face flickered in his head.

So, when the next bus arrived he dashed into the crowded bus with clenched fists. A yell of protest broke among the people in the queue for his cutting in.

There was no place to put his hands and his briefcase now that he had succeeded to get into the crowded bus. With one hand raised, he stood sandwiched between people. His other hand with the briefcase was stuck into a lady's waist. His face was forced onto a gentleman's shoulder, so that he could hardly breathe. 'Oh, I'm choking'. Someone stepped on his toes. It was painful, but he couldn't even manage to scream.

What drudgery, what hell, standing among steaming breaths, packed among a jungle of people.

But another misery was awaiting him. When he got off the bus, he found his pocket-book was gone. What a pity! What a miserable morning for him! But this is not Mr Kim's misfortune alone. It could happen to everybody in Seoul.

People, people, people.

Every citizen in Seoul is fed up with the crowd. Is

there no way to get rid of the people? To reduce the population in this town is the most urgent problem we have to solve.

(Test exercise contributed by a participant at the Kuala Lumpur Training Course)

Comment. The writer used one small incident in the routine of a single commuter to point up the miseries of life for all the inhabitants of an over-populated city. The action, packed into a quick-firing series of simple sentences, is closely observed, for example the graphic description of the sufferings of the unfortunate Kim inside the bus. The note of despair which ends the story is, in effect, a call for action. The vigorous, colloquial style of writing is exactly right for this story.

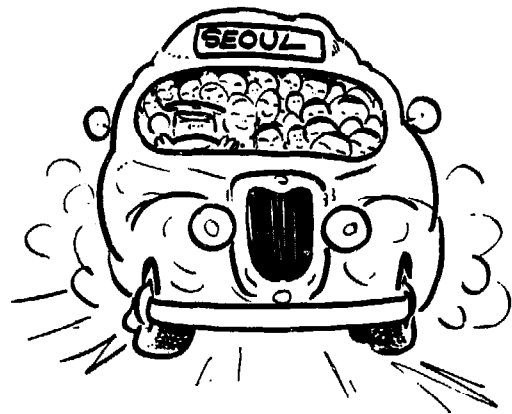

Example 2 The Right Time

(Effects: A cry of a baby....)

Are you one of the many newly-married couples still deciding when to have your first child? If you are then we at the Family Planning Centre can help you. Firstly we ask ourselves these question. Is the present family income sufficient to feed three mouths when the new-born arrives? Can you give the child the basic needs of life? How good is your relationship as husband and wife? Have you developed trust and understanding between you? For the development of the child depends to some extent on the parents' relationship. Every child born should be a wanted

child. It deserves to be loved and cared for. It is not the number of children you produce that makes you an admired parent but how well you have planned and spaced your children, have been able to provide them with proper food and clothing, a proper education and have been able to look after their health. A well spaced child is usually a healthy child.

If you feel that you are not ready to have a baby, we at the Family Planning Centre can help you. We have various contraceptive methods to help you plan your family for the first one or two years until you are ready to have a baby. The doctor at our Centre will examine you and will decide which method is most suitable for you.

Visit your nearest Family Planning Centre for further information and free Consultation.

MAKE EVERY CHILD A WANTED CHILD.

(Test piece contributed by one of the participants at the Kuala Lumpur Training Course).

Comment. This short piece is more of an announcement than a true radio talk. Still, it does follow the rules. First a series of questions are posed, each question arising naturally from the preceding one and all leading up to an inevitable conclusion: all children should be wanted children. And to round it off an offer of practical help from the Family Planning Association, reinforced by a slogan. The sound effect used to introduce the talk thrust the listener straight into the topic. A good idea!

Example 3 Family Planning for Development

We are now in the Development age. It is essential that all of us should participate in its efforts. We want development that will give all of the people enough education, so that all will live more prosperously.

However, one factor that influences development is the population problem. Population increases faster

than food production, faster than housing can be provided, faster than jobs can be created. What does it mean to you? What does it mean to your society and family?

Let's take a look at two families. Family A consists of a husband, wife and two children. The husband can afford to buy enough clothing and enough food, and he can educate his children properly. Family B consists of husband and wife and 10 children. His salary is not enough to buy sufficient food or clothing, not enough to rent a house and educate the children. An unhappy outlook for the future.

My friends, I'm sure most of you are aware of this problem. Many of you are already practising family planning, but for those of you who aren't, our field-workers usually call at your village once a week. They will help you with your difficulties.

You will help the government and yourself by practising family planning. Remember, it's the quality that counts, not the quantity.

A happy family makes a happy country.

(Test piece contributed by a participant at Kuala Lumpur Training Course).

Comment. Like the preceding illustration this is an announcement rather than a talk. It is logically constructed, first relating population to national development, then reinforcing the argument by contrasting two families and ending with an offer of practical assistance to the villager and an appeal to patriotism. The words are simple and the sentences short and to the point – just right for the target audience of rural listeners. It contains the useful device of asking a question and then using the answer to convey the point of the argument, viz. the consequences of having more children than you can afford. Recognising that it is the closing words that stick in the listener's mind, the writer has neatly summed up his appeal with 'quality not quantity that counts' and rounds it off with a positive slogan. Good!

Example 4 A Railway Story

The scene: A Thai State Railways' workshop on the outskirts of Bangkok. The participants: 3,000 railway workers in khaki shirts and trousers, all neatly pressed. The occasion: a Saturday afternoon 'information and education' session organised by the Planned Parenthood Association of Thailand, known as PPAT. A young man is earnestly explaining through a loudspeaker what the growing numbers of people mean to the world in general and to Thailand in particular. He stops, to a flutter of applause. 'Are there any questions?' he asks, only to be confronted by rows of expressionless faces. A pretty young woman from PPAT's office staff steps forward smiling. Within two minutes she has them laughing and is offering a prize to the first man to ask a question. 'You', she says to a reluctant volunteer. His question is asked with obvious embarrassment: would a vasectomy mean he'd lose his virility? Since he is rising 60 this provokes a roar of appreciation from his fellows. The public health doctor present gives the answer and the girl steps forward and smilingly hands over the prize – a packet of condoms. The ice is broken and questions now come from all sides. Question time is followed by a film show. First a cartoon showing the trials inflicted on two parents by an excess of children. Being made in Norway the sound track would be meaningless but for the astonishing skill of another member of PPAT's staff. This young man, using a microphone and speaking in Thai, imitates all the voices himself in perfect synchronization and throws in sound effects and a collection of family planning slogans for good measure. The audience loves it. The second film, also foreign, shows how contraceptives are used, with diagrams to illustrate the various methods, and here it is the doctor who supplies the narration. While he is speaking a queue begins to form for packets of condoms, the vendors being other girls from PPAT's staff. By the time the meeting breaks up some 400 men have handed over their money – for each a very small sum – and 22 others have been given appointments for vasectomies at a Government clinic. The railway workshop gathering was but one of many similar sessions regularly organised by PPAT's Bangkok headquarters and it seemed to me as an

onlooker that their success was largely due to two factors: one, the personality of the 'presenters', the other, their ability to strike a sympathetic cultural chord in the audience.

(Contributed by an instructor of the Kuala Lumpur Training Course)

Comment. The talk launches straight into a brief description of the scene and then builds up the development of the action in concise, simple sentences. By telling the story in the present tense the reader gives it a feeling of immediacy, so that the listener can well imagine he is actually present. The writer uses a series of sketches, each with a marked human interest – the girl 'motivator', the embarrassed railwayman, the young man who imitates sound film tracks – linking them by relevant action, and rounding off the story with a significant observation.

Example 5

'The graph of population in the past was a curve like an aircraft taking off. Now it's like a rocket rising straight up from the launching pad. On present trends we could reach 50,000 million in a space of time no further ahead than the Napoleonic Wars are behind us. No one can say whether the ingenuity of man could feed that many. Certainly the soil could not produce enough, but there are other ways we could produce the chemistry of sustenance we need. We could stack people up in hutches and feed them like battery fed chickens, although you get to the point predicted by Professor J. H. Fremlin of Birmingham, when people huddled together will die of heat – their own body-heat. But we can ignore ultimate figures. What matters is the *rate* of growth. For instance if you have, as some developing countries have, a 3 per cent per annum growth in population and a 2½ per cent per annum growth of food production – which is pretty good, incidentally – you have chronic hunger.'

'Food and population is an equation. On one side of the equation you can increase (as we must) the production of food, on the other side you can restrict population. The answer is to do both simultaneously, and try to balance production and reproduction.'



Comment. This is an example of how it is possible to popularise a difficult subject, in this case by using technological terms as analogies to stimulate the imagination: 'rocket' and 'launching pad', 'stacking like battery-fed chickens', 'chemistry of sustenance'. First came a statement depicting the scope of the problem, then the relating of population to food production in terms of an equation, leading to the social, economic and political implications of population control. Straightforward statements sequentially developed, in a lively style to hold attention. We have here again the analogy of the house builder – first the foundations, then brick course laid on 'rick course until comes the culmination the roof. This is good writing for the ear!

Example 6

'I watched the crane swinging in towards the facade of Stockholm's Old Parliament as two young men perched in the cradle at its top began to dismantle the giant placard fixed above the portal. The placard depicted a symbolic figure, arms outstretched to encompass the globe. It was the emblem of the United Nations Conference on the Human Environment. Parked among the lilacs below were several of the buses that had ferried delegates and news correspondents back and forth between the three buildings which had been the scene of solemn deliberations over the preceding two weeks in Stockholm. The uniformed drivers, plus a handful of the many security guards who had maintained a strict watch on our comings and goings, stared as the blue and white figure was pulled apart vertically down the middle, and one half was whirled away by the crane to be deposited in a waiting truck. The split, I reflected, could be seen as more than the partition of a piece of painted hardboard; it could be taken to symbolize the cleavage between the industrialized countries on the one hand, preoccupied with the effects of their own pollution and, on the other, the developing world, much more concerned with the effects that any anti-pollution measures might have on their own fragile economies.'

That's what the arguments on The Pill are about'.

'But first you have to persuade people. And it is not just a question of religious opposition. People want to have children, and so they should. That is to say, they should have the children they want but not necessarily the children they don't want. Children, in a peasant community are hands for work and they are an insurance that the parents will be taken care of in their old age. So people have lots of children – lots, because in the past, so many of them died.'

'So we've come to the point where you see that this population problem isn't something which can be adjusted by demographers, or treated as an epidemic of children which medical science alone can solve. It's political, it's economic, it's social and, above all, it's personal. It is a question of persuading people, as well as giving them the means to control births. But it is *urgent*.'

(Extract from one of a series of UNESCO Radio programmes 'Science, Peace and Survival').

(Extract from one of a series of UNESCO Radio programmes 'Down to Earth').

Comment. Here an event is used to symbolize a state of affairs: the division between the industrialized countries and the developing world. Strictly speaking the dismantling of the UN Environment placard was a non-event yet the writer saw it as a means of placing the Stockholm Conference in its world context, in a few lines of low-key description. It illustrates how a story can be hung on the most unlikely of pegs.

Example 7

'That classic of English literature, Lewis Carroll's *Alice in Wonderland*, has in it a hilarious scene known as the Mad Hatter's Tea Party. Generations of children have read it with delight, adults too, but how many have wondered why the Hatter was labelled Mad? Why not the mad tailor or mad shoemaker? The answer lies in one of the evils of Britain's Industrial Revolution, over a century ago. At that time it was fashionable for men to wear tall hats faced with beaver skin or something similar and in the process of manufacture, mercury was used. Now mercury is highly poisonous and it can cause delirium, hysteria and, ultimately, death. Hence the term "Mad Hatter". The latest outbreak of Mad Hatter disease was in Japan where a number of fishermen in Minamata Bay died after eating shellfish dredged up from the sea bed. The shell-fish were contaminated by organic mercury mixed with waste spewed out by local factories into the waters of the Bay. Sufferers from Minamata disease, as they call it nowadays, are supposed to number around 10,000. Elsewhere, in Toyama, about 130 farmers lost their lives through Itai-itai disease which is caused by eating food and fish contaminated by cadmium from nearby smelters. Perhaps there's some excuse for the industrialists of a century ago who were ignorant of the hazards of exposing their work people to chemical processes. There is no excuse for industrialists of today who wilfully discharge waste materials into the environment knowing they are dangerous to health. There was the notorious incident of the Rhine fish when the horrified Dutch found millions of dead fish floating down from Germany, victims of toxic chemicals in the river, 'falling off' a barge. In England recently there was the scandal of children

found playing with drums of cyanide dumped on waste ground by unscrupulous manufacturers. Some countries have legislated to stop such practices but anti-pollution measures are usually expensive, so it's cheaper to pay the fines and carry on as before. And it's not only the private sector of industry that wages war on the planet in this way. Nationalized industries and government factories can be just as cynical in their indifference to the environment, fouling the atmosphere with noxious fumes from their chimneys, dumping poison gas and the waste products of nuclear fission into the oceans, and so on. We are overwhelmed by the array of dangerous pollutants being released into the human environment. How many people should be permitted to sicken, to go mad or die before we take action? These are inescapable questions associated with industry today. Of course, technologically speaking, it is possible to clean up and avoid pollution. For instance, as a result of the Clean Air Act of 1956 the air of London is far cleaner today than it was 100 years ago. In the United States pollution control expenditures by pulp and paper firms have reached around \$200 million a year. People can now swim in the Ruhr River in Germany which runs through the most heavily industrialized area in the world. In Osaka, Japan, a municipal incinerator, while meeting strict anti-pollution standards, not only burns the city's rubbish to produce electricity but also contrives to burn sewage sludge. In Kansas in the USA glass from millions of throw-away bottles is being used to construct an interstate highway - 'Glassphalt' they call it. In France, at Vandreuil, they are designing the world's first pollution-free industrial city, with tunnels to remove all pollutants and wastes, and with traffic flowing underground. One could give many such examples of enlightened action. But - and here's the rub - how much is the citizen prepared to bear of the cost of clean air, clean water, uncontaminated food? All of which we regarded only a generation ago as 'free goods'. Because it's the citizen who foots the bill as either victim or taxpayer.'

(Extract from one of a series of UNESCO Radio programmes 'Down to Earth').

Comment. The writer launches straight into a tantalizing statement intended to arouse the listener's curiosity, using the device of posing his own question and answering it. The 'vignette' opening leads straight into the theme of the talk which essentially is in two parts. The first lists a series of deprivations, interspersed with comment, all calculated to arouse anger in the listener. The second alleviates his fears somewhat by giving examples of how pollution can be prevented or cured. Then the summing up: who bears the cost? All this in a series of terse statements conveying the sense of urgency.

Example 8

'There was once a man on a beach who got tar on his foot. Scrubbing it off, he paused to ask himself why there was tar on the beaches. Thus he became Ecologically Aware. Because the tar had come from a tanker bringing oil to make petrol, he sold his car. Since there were no trams or buses to where he lived, he had to go everywhere on foot. But the fumes from the cars' exhausts were so strong that finally he stayed at home. Since the oil went to make plastics, too, he stopped buying his milk in plastic bottles, or putting his refuse in plastic sacks. But the refuse collectors refused to take it, so it piled up in his garden. Looking at it, he realised that he had not really needed most of it. He had been pressed into buying it by the advertising. So he sold his television and smashed his radio set. Retreating from the city, he went to live in the hills, growing vegetables without fertiliser, keeping a cow for milk and chickens to give him eggs. But the local farmer sprayed the grass with pesticide which got into the milk, and the chickens ate insects that had been sprayed and soon they died. Planes came over low on their way to land at the city's airfield, and the neighbours told him that soon a motorway would pass across his land. . . . So the man fled to an island in the Pacific. There he met a fisherman who had been burned by the fall-out from a nuclear test explosion. Turning away in despair, he ran towards the beach . . . and there he got tar on his foot. Scrubbing it off, he asked himself why there was tar on the beaches. The reason, he concluded, was that

the oil companies could make bigger profits if they did not pay for pollution-free tankers. And so he became Politically Aware.

'The man went back to live in the city. He bought a car because there were no buses and he had to get to meetings. He watched television and listened to the radio to know what was going on. He bought his milk in plastic bottles because it was cheaper and he needed money for books. And he went into politics to try to change society.'



(Extract from one of a series of UNESCO Radio programmes 'Down to Earth', with acknowledgements to 'Agenor' magazine).

Comment. Here is an unusual and amusing way of expounding the environment crisis, which often, with its emphasis on gloom and doom, is self-defeating. By treating a serious subject in a light-hearted manner and the ingenious use of the parable form, the writer has strengthened the impact of his message.

Example 9 - Adaptation

'A second conundrum has political overtones and thus is not the source of much open reflection or discussion in the developing nations. The conundrum is: how much credibility can there be in messages originating from mistrusted sources? It is a fact that many governments in the developing world are highly centralized and, while passively accepted by the

people, may not necessarily be trusted or seen as acting in the best interests of the people . . .’

‘Phrased in melodramatic terms, can the sincere or dedicated instructional technologist overcome the possible mistrust or even open hostility of the people toward the agency which pays him or her?’
(Extract from a published report).

Comment: Here we have a typical example of writing for the eye. To grasp the full meaning one has to read the text carefully and moreover be schooled in words not usually used in everyday speech: conundrum, overtones, reflection, credibility, passively, melodramatic. For radio it simply would not work in that form. It would have to be taken apart, re-structured, given fuller explanation and simplified.

Radio Version

There’s a second problem which is hard to deal with since politics come into it and because of that developing nations rather avoid discussing it openly. The problem is this: how far can one expect people to believe information that comes to them from sources they are suspicious of? Many governments in the developing world are highly centralized. The decisions that matter seem to be made at the centre of authority, usually the capital city, while the districts or regions don’t seem to have much say in the running of things. It’s a state of affairs which most people accept without protest, but that doesn’t mean they trust the central authority or believe that it’s acting in their best interests. It’s an attitude that makes things very difficult for an instructor in, say, techniques. The people he’s trying to help know he’s being paid by the Government or an agency connected with it. Therefore no matter how sincere or dedicated he may be, he will very likely come up against mistrust or even hostility. What can he do to overcome it? That is the problem.

(Contributed by an instructor at the Kuala Lumpur Radio Training Course).

Example 10

‘Elsewhere in this manual emphasis has been laid on the necessity to promote family planning, not in isolation – an end unto itself – but as part of the overall pattern of social and economic development. The radio talk or documentary – essentially a spoken composition – is an excellent vehicle for placing family planning in the wider national perspective.

The following is an example.

‘. . . At this rate of increase, by the end of the century – in only 25 years – the country will be weighed down under the intolerable burden of double the number of people to support. Think for a moment what doubling the population means to a country. It means doubling the number of schools and teachers, doubling the volume of public transport, power stations, drinking water, public utilities. It means doubling the quantity of food needed, doubling the capacity of industry, doubling the number of hospitals, doctors, nurses. And we’ve just heard from Dr Kom that he’s the only fully qualified doctor to care for the health of 66,000 persons. . . .’

(Extract from WHO radio programme).



The discussion programme is an excellent rostrum for the exchange of views and ideas. It can produce stimulating talk of the kind that sets us thinking; on the other hand it can be unexciting and tedious. It largely depends on the skill of the chairman (moderator) in steering a tactful course between opposing opinions. For it is a fact that the airing of conflicting ideas and points of view is the very lifeblood of radio discussion; to have all the participants agreeing among themselves would make very dull listening.

Because of its flexibility, the discussion programme is a good format for placing family planning within the wider context of national development. If, for example, the theme of the programme were family planning and population, it would be natural to open out the discussion and bring in related problems of nutrition, education, unemployment etc. Conversely if nutrition or child health happened to be the chosen subject, what more logical than to draw family planning into the debate?

Formats

1. *The Round Table*, sometimes called a panel discussion or radio forum, is probably the most acceptable form of radio discussion. A panel of three or four persons, led by a chairman, discuss a single subject or theme for between 10 and 20 minutes. Since the listener finds it hard to identify several voices talking together, the participants should be limited to four—three is the ideal number. They are chosen for their specialized knowledge or because of their importance in the community, and for an ability to express themselves with fluency. The pivot of the discussion is, of course, the chairman. To generate liveliness, this type of programme is unscripted. At its best the round table can be both informative and entertaining.

2. *The Extended Interview*, as the name suggests, is a lengthy (up to 20 minutes) exchange between two persons. It becomes a discussion because the interviewer does not confine himself to questions, nor does he efface himself; on the contrary he plays a positive role in debate and may deliberately provoke his guest by putting forward opposing views of his

own and playing devil's advocate generally. Often the interviewer is himself a well-known personality and, provided he has done his homework thoroughly, he can dig far deeper into a subject than is possible with the normal interview of four or five minutes duration.

3. *The Debate* is a form of discussion not often used in radio since it demands considerable behind-the-scenes organization. Nevertheless it does have its place and can produce lively entertainment. Unlike the round table, the debate is not strictly a discussion. In some ways it resembles a court of law in that a proposition is put forward, and supported through reasoned argument by one group of participants, while the members of the opposing group in turn devote their vocal energies to demolishing it. Which is probably why the radio debate is most effective when broadcast in the presence of a 'live' audience.

4. *The Symposium*, so beloved of experts, usually takes the form of prepared statements, read by each of the participants, which are then summed up by a moderator or chairman. Generally, air-time is too limited for subsequent discussion and without the cut and thrust of spontaneous discussion there is little to hold the attention of the casual majority, as distinct from the sprinkling of listeners with an interest in the subject of the broadcast. The symposium is a format not well suited to radio.

Since the round table is the most favoured form of radio discussion, it is the one likely to be of most interest to you, as participant or possible chairman. This, then, is the format analysed below, in terms of responsibilities and procedures.

The Producer will almost certainly be a staff member of the radio station. He it is who will select (a) the subject for discussion, as being of interest to the intended audience, (b) the panel of participants, taking into consideration their specialized knowledge and their microphone personalities, and (c) the chairman, for his or her tact and ability to guide the discussion and keep it on the move. It is the producer who, in com-

pany with the chairman will find out before the broadcast starts what each participant is likely to contribute to the subject. Given this information, he will decide the 'shape' of the programme and accordingly brief both chairman and participants, encouraging them to jot down notes. To my mind, this is as far as the producer should go; to attempt a full-length rehearsal, is to risk losing freshness and spontaneity in the actual broadcast.

During the broadcast the producer will keep an eye on the studio clock, signalling to the chairman as each pre-arranged stage of the discussion approaches its allotted time and, finally to wind up the broadcast when time runs out. The producer will also instruct chairman and participants in microphone drill: not dropping the voice at the end of sentences, not moving the head back and forth in relation to the microphone, not tapping the fingers on the table top to emphasise a point of debate, not breaking in on a speaker or talking at the same time as another is saying his piece.

Should there be no producer, which could be the case in a small radio station, the onus of planning the discussion, as above, and briefing the panel members, will probably fall on the chairman.

The Chairman has two things to bear in mind, (a) the producer's instructions which he must interpret (he should have made notes of these) and (b) the tactful, yet firm, control of the participants when they get into their stride. Here is what he should do:

1. Write down his introductory remarks, together with the names of the participants, clockwise round the table. He may have met them for the first time just before the broadcast and it is only too easy to forget or confuse a name in the heat of debate. Slips of that kind make a chairman sound incompetent.
2. Introduce in turn each participant by name, not forgetting to say what he or she is or does in the community.
3. Then state briefly what the discussion is about and start it off by asking a broadly-based question and inviting one of the participants to have his say.

4. In the early part of the discussion he should name the speakers frequently, until he judges that the listener is able to identify each one by voice.
5. Usually the programme will deal with only one subject or theme; nevertheless, several related topics will certainly emerge during discussion, and he must allow them to be aired. However, should a speaker stray too far from the main subject, it is for the chairman to intervene at a convenient point, bringing the discussion back into line by himself asking a relevant question and inviting another speaker to comment on it. He will do the same thing should he judge a topic to be exhausted, or conversely, not being fully aired. He should not permit any one participant to monopolize a topic.
6. The chairman's leading questions must never be so phrased as to limit the participant's response to a simple 'yes' or 'no' (this was analysed in the 'Interviewing' Chapter).
7. Like the radio talk, a discussion should follow a logical development of the subject, and the chairman should guide it accordingly. A discussion that jumps around may be a lot of fun for the participants but will only confuse the listener.
8. He will endeavour to preserve a balance between differing points of view.
9. He will welcome disagreement. Indeed, if the discussion becomes too harmonious (all participants agreeing with one another) he may himself introduce a controversial note to provoke opposing points of view. However, although conflict of opinion is essential in radio discussion, it should never be allowed to get out of hand. The chairman must firmly dampen over-exuberance, not by calling the offender to order, but by intervening with a joke or light-hearted remark – something to provoke laughter. Throughout, he should strive to sustain a good-humoured atmosphere.
10. The chairman should round off the session with a summary, taking care to limit his remarks to the covering of points actually discussed. He must resist any temptation to raise questions not dealt with in the discussion or make personal comments on what has been said by the panel members.

The Participant

1. Forewarned on the subject of the round table, you should come to the studio with a list of points you would like to make during the discussion. It's unlikely there will be time for them all so underline the two or three which you regard as the most important.
2. Don't give statements. You are participating in an exchange of views, therefore listen closely to what each speaker says and don't hesitate to ask him to explain further if you haven't properly understood.
3. Don't be afraid to disagree with another participant but do it pleasantly with an introductory remark calculated to turn away wrath: 'Do you really think so?', 'I'm afraid that's not been my experience', 'Surely there is another way of looking at it you know', etc.
4. Be careful not to monopolize or dominate the debate. Keep your remarks brief and to the point and wherever possible relate an anecdote or personal experience to illustrate or reinforce your assertions.



5. At all times follow the chairman's lead. To ignore his guidance will make you sound unruly and discourteous to listeners. For the same reason avoid the temptation to interrupt a speaker however strongly you may disagree with what he is saying; try to catch the chairman's eye if you want to intervene.
6. Always keep your temper, no matter how assertive or dogmatic another speaker may be in his utterances. In such a case you will be helping the chairman by staying good-humoured.

The presentation of radio news is a specialised task and one from which outsiders are excluded. Whether a story comes from a news agency, an official spokesman or a local correspondent – no matter what its origin – the news editor or one of his staff will abbreviate and re-write it. Therefore there is little point in explaining the somewhat stereotyped requirements of news writing. On the other hand since family planning as a subject often makes news, you should be able to recognize in your activities events and items of information which are newsworthy and therefore worth feeding to the local radio news editor or reporter.

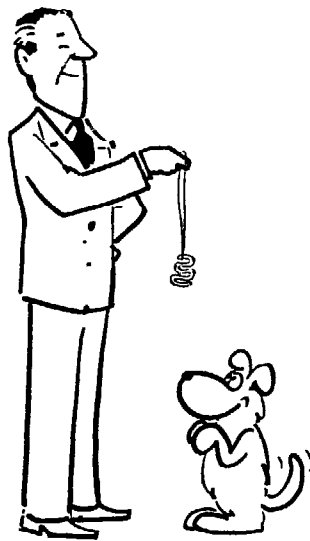

News Attitudes. Newsmen are not specialists (except in the reporting of news) and they tend to view everything from a story angle, rather than for any intrinsic value. Moreover, they incline to think in headlines and any story which can be condensed into a snappy headline will surely attract their attention: 'The Pill Goes to the Dogs (*Malay Mail*, June 24, 1975) – headline to a Washington report of canine birth control. The eye or ear-catching effect is what they look for and this often means reducing specialized news to a 'digestible' form which often leads to what the specialist contributor – like yourself – feels is oversimplification; by telling only the surface of the story, the information becomes distorted and loses its value, in the public service sense. Thus, conflict arise over the way in which the specialist would like to see his material presented and the way in which the newsman actually does it. Generally a compromise can be reached, somewhere between the editor's 'popular' approach and the expert's specialized one. The criterion for both specialist and newsman to apply is that of public interest.

What is News? It has been said that news editors are not interested in 'good' news, except possibly the ending of a war! And there is the cynical observation that a newspaper is a device for amusing one half of the world with the other half's troubles. What, then, can be regarded as news? Anything unusual, off-beat, amusing, controversial and, above all, sensational. But it must be NEW and it must be of interest to the public at large. The presentation of a news story can be summed up in six words: What? Where? Who?

When? Why? How?, in that order. (What happened, where did it happen, who did it happen to, when did it happen, why did it happen and how did it happen).

News in Family Planning: Examples

1. Social and economic consequences of a family planning campaign.
2. Cultural changes caused by family planning practices.
3. Criticism (or praise) of contraception from prominent people.
4. The discovery of a new birth-control method; the failure of a long-established one.
5. A new and promising line of research into fertility control.
6. Dramatic changes in numbers of acceptors – either increase or decrease.
7. A sudden increase in the number of vasectomies or sterilizations.
8. A woman giving birth to triplets in spite of ten years on the Pill.
9. A man giving birth would be sensational news.
10. Adoption by a government of an active birth control policy.
11. A government which abandoned such a policy would be even bigger news.
12. Family planning in the school curriculum.
13. The opening of a family planning exhibition or festival.
14. A family planning competition or anniversary celebration.
15. The opening of a new clinic, or the closing of one.

16. A decrease in world population would be news. If it were directly attributable to the efforts of Family Planning Associations, that would be news.

17. Bigger news would be the publication of figures showing that all efforts to control population were losing ground.

And so on. In short: the new, the unexpected, the unusual, the controversial, the sensational, failures as well as successes.

Sources. Radio gathers its news from many sources. The larger broadcasting stations will employ staff journalists concerned with the collection and reporting of national news, and 'stringers' – part-time correspondents who report local events. Other sources are the 'handouts' from government departments and from public relations officers. News from abroad comes from one or other of the big international agencies who sell their news to interested buyers. Small radio stations often pick up national news from local newspapers, and international news by monitoring short-wave services of the BBC, Germany, France, the USA and so on.

News Formats

(a) *The Bulletin or Summary.* News bulletins generally present a series of factual events, known as 'hard' news, in order of importance. However, of recent years, news comment has crept into bulletins, so that a statement of known fact will be expanded and speculated on in a brief comment by an expert or celebrity (in the body of the bulletin as distinct from news comment at the end of the bulletin). Bulletins usually run between 10 and 15 minutes, summaries between 2 and 5 minutes.

(b) *The News Magazine.* This type of presentation can be up to 30 minutes duration and, in addition to a short, formal bulletin of hard news, could include several items of 'soft' news: one or two eye-witness accounts, a magazine interview or report, extracts from speeches and a short specialized talk or two. It is a vehicle particularly suited to family planning stories and interviews, most of which would be regarded as

soft news. A variant of the news magazine is the shorter radio newsreel.

Foreign Family Planning News. Bear in mind that your local station won't have access to news of family planning and population developments abroad, which you probably will have; so make a point of feeding the editor with foreign material which you consider newsworthy. Of course, that goes equally for any similar material concerning your own country or community.

The preceding chapters have dealt with those types of radio programmes which family planners can produce themselves or personally participate in. Now we examine briefly other programme formats that are strictly in the realm of the professional broadcaster, who has at his command not only his specialized training but all the facilities of the radio station, not to mention its finances. However, it should be said that some national Family Planning Associations do have on their staff individuals who, because of a communications background and personal enthusiasm, have become so adept in radio writing and production generally that they can be considered as semi-professional or even professional; indeed some Family Planning Associations use such persons as radio officers with considerable success. Yet radio specialists of this kind are rare in the family planning movement, as they are in the fields of agriculture, medicine and the social services generally. Nevertheless, given goodwill on the part of the radio station, family planners should be able to influence the use of these programme formats in spreading the concept of family planning.

Radio Drama. A child one said that she liked radio better than television 'because the scenery is better'. Quite so! The scenery is built in the mind of the listener; lacking visual aids, his imagination is put to work. Everything has to be made clear to him through words, musical sounds and effects, pauses and silence. On the other hand radio drama has no limitations in physical space; the dramatist may place a character in any setting he chooses: at one moment in his bedroom, the next on the surface of the moon. Suspense,

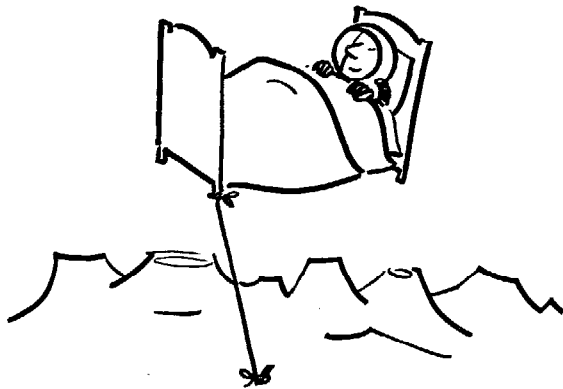

conflict, comedy, all can be conjured up. Radio drama has been called, rightly, the theatre of the imagination and as such it is a powerful conveyor of public information. By taking us into the thoughts and lives of people, it is particularly effective in expounding human problems through the interplay of emotions between imaginary characters in contrived situations. With these the radio listener can equate himself or herself, following their tribulations and enjoyments as though he or she were actually experiencing them. If radio can be said to have produced an art form it is surely to be found in the drama production. Not surprisingly it demands creativity and special skills from writer, producer and actors alike. However, don't be discouraged if you fail to write an acceptable play. There is no reason why you shouldn't write the outline of a script based, possibly, on a real life drama you have come across in the source of your work, and try to persuade the local station to get one of their writers to turn it into a play for radio.

A Family Planning Association in the Philippines has done just that. Every two weeks, they selected a real life problem from among those encountered in their area and paid a professional writer and group of actors to handle it; the play was produced gratis by the local commercial station as a public service. Admittedly it was a television production, but it could have been done just as effectively on radio and with less expense, and moreover, would have reached a far wider audience. They went further: at the conclusion of each play, which, being drawn from real life, offered no solution, the problem it had presented was discussed by a panel of two or three community leaders. A radio play can be anything from 10 to 60 minutes in length.

The Soap Opera can be regarded as an endless series of mini-dramas, each one an episode centred round the same community or family. The drama must relate to the day-to-day life of the intended audience so that listeners can identify with it. Each episode starts with a complication and ends with a crisis always a minor one, since the soap opera never reaches a final climax. It was started many years ago in the United States of America as a publicity stunt, by manufacturers of soap and detergents who foresaw, correctly, that a daily



serialized radio drama aimed specifically at the housewife would sell their products. But it soon spread beyond the confines of commercial radio into the national networks. 'The Archers' serial of the BBC is still being broadcast nightly after nearly 30 years. It is set in an imaginary farming community somewhere in the English Midlands and over the decades it has become a valuable channel for introducing and explaining to rural listeners new methods and changes in farming practices. In short, an easily-digested form of propaganda. If such a serial happens to be broadcast in your country or district it shouldn't be too difficult to persuade the producer to devote an occasional episode to a family planning problem.

Dramatic serials have also been written and broadcast on a one-a-week basis. I came across one such, again in the Philippines, which had as its theme the anguish suffered by a rural family as the result of an abortion. It ran for five episodes and, to my mind, was extremely effective, largely because of the high standard of writing and production.

The Documentary, sometimes called 'Feature', is an odd hybrid which in a single programme could include elements of drama, narration, interview, sound archives material, eye-witness accounts, verse, folk and mood music and effects, or any combination of these. However, unlike radio drama with its imaginary characters inter-acting in contrived situations, the documentary examines people, problems and situations from the real world. Moreover, it can transcend

the material world of 'doing' to reach into those hidden areas of the mind which encompass abstract thought. The various elements have, of course, to be woven into a cohesive pattern and this is usually done by a linking narration. The narrator himself is central to the production; given an imaginatively written and dramatically presented linking narration, he can assume his proper role; that of a teller of stories whose story is illustrated from life itself.

The subject of the programme may be literally anything: historical events and current social problems, biographies of celebrities past and living, national happenings, the entire fields of culture and science – the list is endless. At its best, the radio documentary is a potent interpreter of the world around us. It can make us aware of how people and things work – how a farmer lives and how a new medicine can cure. It follows, therefore, that the documentary is a very effective way of transmitting the family planning message. Indeed, many radio documentaries have been written around population growth and associated problems of diminishing resources and environmental pollution, and doubtless there will be many more. As to length, the documentary can be anything from 15 to 60 minutes, according to the breadth of the subject.

The objectives of a documentary are nearly always educational or informative, but that is no reason for it to be dull or boring to listeners. On the contrary; a well-researched (as all documentaries should be) and imaginatively produced programme can be of absorbing interest, and good entertainment at the same time. Essentially a scripted programme constructed around a single theme, the documentary uses the techniques of talks and drama, and it commands talent and expertise in both writing and production. It is necessarily a task for professionals. However that is no reason why you should not make contributions to appropriate programmes by supplying information on family planning or even participating yourself in your official capacity. You could also try persuading a producer in the local station to prepare a documentary on family planning activities and developments. Probably the simplest form of documentary, and a very effective form it is, would be a series of short field interviews linked by a lively narration, depicting the local family planning scene.

Request Programmes consist of musical items on gramophone records (discs) played at the request of listeners, whose names and addresses are announced, sometimes with birthday or marriage greetings added. The universal popularity of such programmes is not so much due to the music played as to the pleasure people get in hearing their names mentioned on the air; it gives them a fleeting claim to fame. Request programmes are a minimum of trouble to produce and, moreover, inexpensive, so that they are looked on with favour by programme planners. Where there is a regular request programme on your local station you could try to persuade the producer to devote an occasional session to listeners with family planning problems. These would be read by the announcer (disc jockey) between requests and you would be at the microphone to provide a brief answer to each question.

Educational Programmes are minority broadcasting, in that they are prepared for and directed to specific audiences: children in school and adults in search of further education. However, they are significant audiences for family planners, although sex education in schools is taboo in some countries. Usually schools radio and adult education broadcasts are controlled by the Ministry of Education so that liaison with your education authority would be necessary for the inclusion of family planning material in the programmes. Any contribution you might make would probably be a straightforward talk.

The Magazine Programme is the rag-bag of radio. As the name suggests, it consists of a collection of items from 2 to 5 minutes in length, usually topical. They need not be of one subject, indeed variety in topics is usually sought by the editor. There are magazines for farmers and industrial workers, for youth and sports enthusiasts, gardeners and stamp-collectors; housewives and women generally are specially catered for; there are even magazines of general appeal. The programme can be anything between 10 and 45 minutes long and, typically, may include interviews, mini-talks, on-the-spot reports and eye-witness accounts, stories, news items, music and announcements. A radio magazine devoted exclusively to family planning matters is hard to imagine but the general format is

above all, an excellent vehicle for your field interviews and short talks, and for family planning spot announcements and slogans.

The Panel Game or Quiz is a public guessing competition, usually played with words – spelling bee, general knowledge, ‘right or wrong’ – and occasionally musical – ‘guess the tune’. A chairman puts the questions and four (the usual number) competitors try to give the correct answers. The game element is crucial and the whole thing is conducted in a light-hearted way, as straight entertainment. Cheap, needing no script and easy to produce, panel games are understandably approved of by radio station directors, and the public loves them. A live audience provides an audible reaction to the success or failure of each panellist in responding to questions. The panellists, of course, are risking making fools of themselves by parading their ignorance in public, whereas the listener at home can pit his wits against chairman and panellists in smug privacy. This is one secret of the great popularity of panel games.

How can we family planners ‘get in on the act’, as they say in the world of entertainment? About the only practical way is for you to prepare a selection of questions and answers related to family planning and persuade the producer to include them in an occasional broadcast.

Commercials is the name given to a range of ingenious methods developed by advertisers to sell commercial



products and ideas. Or as the cynical definition has it: to persuade people to buy things they don't need with money they haven't got. Be that as it may, advertising plays an important role in our lives and in many countries radio stations are supported very profitably by the revenue they get from manufacturers who use the radio medium to advertise their products. And just as you can persuade people to buy goods you can sell them ideas, the concept of family planning for instance. Let us take a glance at some of the means regularly used in radio advertising which could be applied to the promotion of family planning.

Spot Announcements can be used to inform listeners about forthcoming events: the opening of a new clinic or exhibition; where the mobile clinics or MAVU's (mobile av units) will be on specified dates; to let listeners know where and how they can get information on family planning; to remind the audience of dates and times of future radio broadcasts on family planning. Spot announcements should be short and to the point and should present only one subject per spot. They can be used to stimulate interest in family planning through brief messages: 'It took two million years to reach the world's present population of 3,700 million persons. It will take only 30 years to double that figure if the present rate of growth is allowed to continue. We must all do our part to reduce the number of children born. Write for information or call on the Family Planning Association at etc.'. 'Wise parents protect the family's future by having no more children than they can afford to feed adequately and educate. Seek advice from the Family Planning Association, etc.'. 'Just married? Why not practice family planning now, before it's too late. Apply to . . . for information, etc.'. 'What is this Family Planning that people talk about? Does it affect me? Good questions, why not find out? Get in touch with . . . etc.'. Such messages can sometimes be presented in a few lines of dialogue:

- A: 'Hullo, I haven't seen you for some time. Tell me, how is it you always look so young? What's the secret?
- B: 'It's no secret. It's because I space my children. I practice family planning. Why don't you do the same? Get in touch with etc.'.

Slogans usually play on word meanings and rhymes and are often adaptations of well-known proverbs, but never are they more than a few seconds long. The shorter the better! For a slogan to stick in the listener's mind it must be repeated regularly, several times daily if possible. It can be inserted in, say, a magazine programme between items, or between individual programmes in what are called 'natural breaks'. It's a good idea to introduce a series of slogans with an identifying sound and even to end each slogan with the same sound. Thus it becomes a kind of signature tune. An obvious example would be a baby cry, or the Ton-Ton (rhythmic message drum) of rural Indonesia. Below are some examples selected from the many suggested by participants at the Kuala Lumpur Radio Course.

- Save space - space children
- A happy child is a wanted child
- A pill in time saves nine
- More children, more poverty
- It may be nice but please think twice
- Fewer children make light work
- Good breeding starts with family planning
- It you want two or three then have an IUD
- Spare the Pill and spoil the family

Jingles are in effect slogans put to music. However, the melody must itself be catchy, the kind of tune that people hum after hearing once or twice. The Family Planning Song of Thailand is an example; it's sung everywhere, in schools, at meetings. I've even heard it in a Buddhist monastery. Like the spoken slogan, the jingle to be effective must be continually repeated.

Many Family Planning Associations make good use of the advertising 'gimmicks' outlined above. However, commercial radio stations insist on novelty and a constant renewal of ideas, exactly what advertising agencies exist to provide. You could turn to such agencies for help. They might demand payment yet equally they could see family planning promotion as a means of bolstering their public image, and so give their services gratis; this latter attitude is quite often adopted by commercial radio stations. For those Family Planning Associations that can afford to, the ideal arrangement is to pay an outside agency, or the publicity department of a commercial radio station, to

plan and produce family planning campaigns, as is done in South Korea. If financially feasible, advantage should certainly be taken of the specialized expertise of this highly effective field of public persuasion.

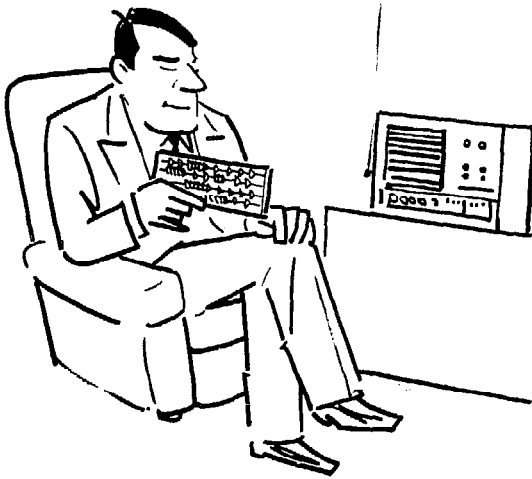

Introduction

Who listens and why? Who doesn't listen and why not? Those are questions that worry every radio producer and he would dearly love to know the answers. Very likely he is thinking of his programme in terms of its entertainment value. Yet entertainment is a fleeting thing and the outside might argue: does it matter? One is bound to reply that it matters very much, (a) if your entertainment is tied to the sale of a commercial product and paid for by a hard-headed business man, and (b) if its purpose is to persuade people to social action – family planning, for example. To gauge the impact of their broadcasts on the public is a preoccupation of all radio stations, the big networks in particular spending large sums of money on 'listener research', as it is termed. To the uninitiated, listener research is the straightforward gathering and analysis of opinions. This is not so. The basis of listener research must be factual – who listens, when and to what? When the facts are established it may be possible to find out why the facts are as they are – why listeners listen to one programme and not to another; but such research can only be superimposed on the basic information.

Some organisations, like the BBC, rely on trained staff to seek out and evaluate the information they need in planning their programme schedules. Others, notably American networks, use the services of commercial companies which specialise in 'audience measurement' (public-opinion polls). Either way, it's an expensive operation and the result – a regularly compiled 'listener index' – has over the years come to be regarded as the measure of a programme's excellence. It's all based on the debatable assumption that the public actually knows what it wants to listen to, or look at, in the case of television. The old-style planners who provided the listening public with a good measure of 'uplifting' programmes intended to broaden the mind and improve taste, have given place to those who labour to give the public what they believe the public thinks it wants. Today, programme planners and producers in the larger broadcasting concerns are guided in their decisions by the listener index; to them personal judgement is unreliable and intelligent guesswork suspect. Inevitably, the result has been a lowering of standards to the level of the lowest common

denominator of the mass of listeners. All very regrettable, one might observe; on the other hand it is a policy that could very well work in favour of family planners whose objective, of course, is to implant their message at the 'grass roots', if one may mix a metaphor.

Method

How do the experts go about gathering information on listeners' likes or dislikes and listening habits? The commonest sources are four: listeners' letters, personal interviews, postal questionnaires, and listening panels.

Listeners' letters, while providing a useful index of a programme's impact, must be treated with reserve. Only persons of strong views, given to self-expression, take the trouble to sit down and write letters; they are a very small minority in any community and certainly not typical. It is the views of the so-called 'silent majority' which matter, especially if among that majority literacy is low. Nevertheless, because they lack the means to pay for listener research, small radio stations do rely on listeners' letters to keep them informed on the reception of their programmes, plus intelligent guesswork on the part of the broadcasting personnel.

Personal Interviews are the most effective way of collecting information on listening habits and views. The questions asked by the interviewer are drawn from a carefully prepared questionnaire on which he records the answers. Face-to-face questioning is normal practice among FPAs and fieldworkers should find no difficulty in becoming 'listener researchers'.

Postal Questionnaires are, as the name suggests, sent by post to selected individuals in the hope that they will be completed and returned to the research office. It is a method which presupposes a literate audience, and the ownership of radio receivers by most of the population. Its effectiveness in developing countries is likely to be limited.

Listening Panels are especially useful when the re-

sponse of listeners to individual programmes is sought. The method calls for at least one person of standing in each community (teacher, extension worker, headman or other opinion leader) to be appointed – on a voluntary basis – to act as a listening post for the broadcasting station. He reports back to the station his own views on a programme plus others which he has collected from a cross-section of listeners in his community. It is a method that could be organized without much difficulty by FPAs seeking public reaction to their radio broadcasts.

Application to FPAs

The foregoing methods, then, of collecting information about their daily broadcasts are those commonly used professionally by wealthier broadcasting organizations. Obviously, listener research at this level requires considerable expertise, organization and administrative detail, plus the knowledge of how to analyze statistically and interpret the information coming in from the several sources. It is a task beyond the resources of most FPAs. They can, of course, ask the station broadcasting their material to use its listener research machinery to report on the family planning broadcasts. But the likelihood is that most radio services, especially individual stations – as distinct from networks – won't have access to comprehensive listener research. Of the four methods outlined above, the ones most appropriate to FPAs are the face-to-face interview and the Listening Panel both, of course, involving the use of questionnaires. There are, however, two other possibilities. First there is the MAVU (mobile audio visual unit); with a large captive audience already 'in the mood' it should be easy to find among them individuals willing to respond to questioning. The second possibility is to persuade personnel in family planning clinics and hospitals, and also midwives, to do the questioning and complete the questionnaires. You could also leave questionnaires with womens' clubs and youth associations; even sports clubs should not be overlooked. Analysis of the data should present few problems to FPAs which are accustomed to using evaluation techniques in the course of their normal activities.

The Questionnaire. The questions must be formulated to extract precise information – always specific, never vague. For example: not ‘Do you listen to the radio?’ but ‘At what time of day are you able to listen to the radio?’ Put in that form, you are likely to learn whether the villager owns a radio or listens to someone else’s, as well as the most convenient time for him to listen. The latter is vital information since there’s little point in a family planning broadcast at a time when most women are busy in fields or engaged in preparing the evening meal. This is the reason why the daily broadcast by the Rural Broadcasting Council in the Philippines is on the air from 5 to 6 am, immediately before the farming communities start work.

The first group of questions should aim for basic factual information: how many receivers are there in the village, how many people listen to them – in groups or individually, where do they listen, when do they listen, which station do they listen to most? Incidentally, this is data which the Director of your local radio station would be grateful to receive! Following the basic questions should come those designed to extract information you desire to know about your family planning broadcasts. Here again, make the questions specific, as far as possible breaking them down in such a way as to elicit a simple yes or no. You are in search of facts, not nebulous opinions.

Apart from those questions designed to help in assessing the degree of popularity of your radio programmes, the one question you will want answered above all is whether your broadcasts have increased the number of family planning enquiries at the clinic or the midwife’s house. For this information you must have a basis for comparison, in other words you need to know what the situation is before your broadcasts start – what is usually known as ‘baseline information’ Only by obtaining such advance data will you be able to assess the impact of your radio programmes on the community.

Keep the questionnaire as short as you can; don’t be tempted to throw in a few extra questions ‘that might be useful’.

Sampling. How does one decide on how many interviews should be made and questionnaires completed? Information on the actions and habits of a large number of people can be accurately assessed by studying a small ‘sample’ of them, provided the sample is representative of the whole group. Take as an example an area containing 50 villages. If five of these were selected at random for questioning, the information they yielded would hold good for the other 45. However it would be essential that all 50 villages have the same cultural background, follow the same kind of livelihood and be at the same level of social development. To mix villages, some of which relied heavily on a local industry, with others engaged exclusively in agriculture, would produce a sample both inaccurate and misleading. At the individual village level, a sample of 25 out of a population of say, 500, would yield an accurate assessment of the whole, provided the sample represented a true cross-section of the community.

The Farm Radio Forum. Probably the most effective invention of radio in the service of economic and social development is the Farm Forum. The idea originated in Canada many years ago and has since been introduced with considerable success into many countries where agriculture is the major occupation.



Rural broadcasting, as practised in most developing countries, is a one-way line of communication, the specialist or government official instructing farmers and other members of the rural community in ways and means of making their lives more bearable. But any form of adult education yields its best results when the communication is two-way and this is the secret of the Farm Forum success. It lies in the creation of a continuous public dialogue between rural communities and the central authority, using techniques peculiar to radio.

Farm Forum broadcasting has been the subject of many publications. It is a highly selective form of radio which requires the setting-up of a production unit of specially trained personnel, and close cooperation between the national broadcasting service and the relevant Departments of Government, including that concerned with statistical analysis. Nevertheless, it may be of interest to readers of this Manual to know some details of the method. At one level it involves organized group listening in selected villages, each session being followed immediately by discussion of the broadcast's content between members of the audience and the specialist or official present. The comments, questions and answers are recorded on the spot for subsequent broadcast and further discussion on the air. Here then is instant and down-to-earth feed-back. At another level, farmers and other rural dwellers are invited to the radio studio where they can question, and themselves be questioned by, experts and officials. The written comments of listeners to the programmes, which are broadcast regularly at fixed times, are encouraged and are also included in the broadcasts. A consequence of all this public interplay, and an important one, is that it gives the central government a human face.

The Senegal experience in Farm Forum radio – one of many – is worth recounting briefly. Started in 1968, by 1974 10,000 out of Senegal's 13,000 villages were listening to the *Dissoo* (Wolof word meaning both 'dialogue' and 'concerted study') broadcasts. In many of them listeners' groups, each numbering about thirty persons, have been organized with a leader co-opted by the others and trained in leadership techniques to facilitate discussion. Members of the *Dissoo* team are always on the move, systematically covering the

countryside, and in each village they hand over their microphone to anyone willing to use it. The programmes' producers insist that three-quarters of the time on the air, in the three weekly programmes, is devoted to what the villagers have to say, including the reading of letters selected from the hundreds delivered to the studio each week. The broadcasts embrace all aspects of the rural scene, from animal husbandry and crop production to public health and prevailing market conditions. It's of significance that *Dissoo* has brought about a better mutual understanding between farmers and the officials who run the technical services of the countryside. More than this, the programme and the wealth of data it produces is now accepted by the central government as a sensitive indicator of rural opinion and has become a major factor in the planning of rural development policies.

One finds variations in the Farm Radio Forum approach from country to country, but common to all is the essential ingredient of public dialogue; it is at the very heart of the Farm Forum concept, the means by which social grievances, aspirations and reforms can be aired and debated. From the foregoing description it is obvious that the Farm Radio Forum is an expensive and complicated operation, beyond the organizational resources of a FPA. However, if by a happy chance your country's central radio system includes radio forum-type broadcasts in its schedule, you would be well-advised to do everything possible to involve the FPA as a contributor.

Narrowcasting. This odd word first came my way during the Kuala Lumpur Regional Radio Training Course. The participants heard it used by a lecturer while they were visiting the University in Penang. He described how he and his colleagues used cassette recordings to motivate villagers 'under the trees'. It's a brilliant idea, but why limit it to motivation? Equally, the ubiquitous tape recorder could be used to pre-test radio material and to provide direct feed-back – in short, become a cheap and flexible tool for listener research. As an example, let us assume that a new format in family planning programmes is being considered. A prototype programme is produced and recorded on cassette, which is then played back in several villages to groups of, say, 10 to 15 persons at a

time. At the end of each playback, comments are invited and taken note of – even better, several of the more articulate among the audience have their comments recorded on the same machine for subsequent analysis back at headquarters.

Another application, using the same procedure, would be for the gathering of first-hand criticism of programmes already broadcast, and which your village audience may not have heard anyway. In this case the cassette played back to the villagers would be a recording of the original broadcast. Some of the comments thereafter recorded on the machine might well be interesting enough for inclusion in future broadcasts. I see the narrowcasting technique serving a triple purpose: collecting first-hand data useful in listener research, pre-testing projected radio programmes and producing field material for broadcasting by the local station. And, of course, you could follow the Penang example and use cassette recordings for motivation in the field. No doubt you will have detected by now that narrowcasting echoes certain techniques used in Farm Radio Forums.



Appendix: Case Studies

Affiliated to the International Planned Parenthood Federation (IPPF) are the Family Planning Associations of 100 countries; it would be surprising if some of them did not make use of the radio medium in furthering their activities. That many of them do, in varying degrees, is revealed by an enquiry which was instigated in connection with the preparation of this Manual. The information thus collected is sometimes detailed, more often sparse, but enough to show the general appreciation of the powerful potential that radio offers in family planning and how its applications vary widely from country to country. Some FPAs limit themselves to the broadcasting of straightforward announcements, some use the adult education services of national radio networks, others participate in 'radio schools', yet others employ commercial agencies to handle their radio campaigns.

Below then is a small selection of brief case studies drawn from the information sent in by the Family Planning Associations which responded to our enquiry. The principal criteria followed in the selection were those of novelty and variety. That some are more comprehensive than others was dictated by the degree of detail we received in each submission. All the examples given are limited to the experiences of voluntary associations but this, of course, is no reflection on the excellent and well-organised campaigns carried by many national radio networks under government aegis.

Location:
Colombia

Organization:
Accion Cultural Popular (ACPO) – Radio Sutatenza

Period of Operation: 1947 onwards

Method:
ACPO is adult education by radio: a six-month basic course primarily for teaching literacy with daily 30 minute broadcasts; a two-year progressive course intended for farming families who have not completed primary school and which embraces health, literacy, mathematics, economy and spirituality; a three-year complementary course for preparing students to take the school-leaving examination (primary school curriculum). ACPO participants are organised into 'radio schools' (study groups). Each group consists of 6-10 adults all from the same neighbourhood, and are organised by a voluntary helper (auxiliary). He has little or no special training and may himself have been through the radio school. He serves as group leader until or when other leadership emerges. Each radio school receives gratis one set of the text-books which repeat the texts of the radio lessons.

Coverage:
ACPO is Colombia's largest radio network, serving over 20,000 'radio schools' and hundreds of thousands of students all over Colombia. From its headquarters at Bogota, ACPO broadcasts 19 hours a day. Three stations elsewhere in Colombia use about two-thirds of the Bogota broadcasts, the other third being produced locally. ACPO's programme is intended specifically for rural committees which are out of reach of government and other national services.

Support Activities:
ACPO publishes the most widely read weekly journal in Columbia, *El Campesina*, written in a style suitable for new literates. The circulation in the early 1970's was 70,000 copies, but each copy is read by 9 persons on average. It also publishes about 600,000 text-books annually for the basic and progressive radio courses, and some 300,000 copies of books for general reading.

Then there is the correspondence service. It is ACPO's principal source of feed-back and is an important factor in the revision and development of the teaching courses. The 200 or so letters received daily are answered by a permanent staff of 20. The Campesino Library distributes a collection of books written in language suitable for new literates. A nominal charge is made for the books, some one and a quarter million of which have found their way into rural homes since 1963 when the Library was introduced. Several audio-visual units, known as ACPO mobiles, tour the countryside with films, slides and sound recordings to promote particular education campaigns. There are also extension courses and campaigns largely concerned with agriculture and health practices. In addition to the radio-school broadcasts, Radio Sutatenza radiates the usual range of popular programmes: entertainment, music, news, current affairs, general knowledge, etc.

Family Planning:

Topics relating to family planning have been included in the basic programme of education since 1973. The 40 hour course includes family planning concepts with emphasis on responsible parenthood. The broadcasts make use of a wide range of formats: spot announcements, news items, radio drama, etc.

Evaluation:

In 1975 an independent evaluation was made of the responsible parenthood (family planning) component. It reported favourably on both the organization and the material used, and made a number of suggestions for improvements. It is said that since the family planning element was introduced into the broadcasts clinic attendances have increased.

Remarks:

From that day in 1947 when Father Jose Joachim Salcedo introduced radio broadcasts combined with study groups for adult education at Sutatenza, ACPO has grown into a vast and influential enterprise. In the early 1970's it had a full-time staff of 200 in Bogota, employed 130 in its editorial and publishing division, maintained 200 fieldworkers, and relied on the services of hundreds of parish representatives and listening

groups supervisors, and 20,000 unpaid auxiliary workers in the radio schools. A nationwide system of training and organization provides the necessary backing.

Finance:

Only about seven per cent of the income comes from government sources, plus smaller donations from abroad. ACPO is now close to being self-supporting: the radio network and newspapers carry commercial advertisements and commercial printing is a profitable sideline. However, it must be said that the programme still places heavy reliance on voluntary, unpaid helpers. Only the family planning element has been largely funded from outside sources.

Remarks:

ACPO's attitude towards responsible parenthood education has been summed up by Father Salcedo: 'ACPO does not discuss nor repudiate chemical or physical birth control methods. This is not our purpose. We want to build a base so that each individual can make a proper decision with complete responsibility'.

The ACPO enterprise has here been described in some detail because of its comprehensive character and because it represents what is almost certainly the most effective application of the radio medium to adult education anywhere in the developing world.

Location:
Colombia

Organizer:
Profamilia (Asociacion Pro-Bienestar de la Familia Colombiana)

Period of Operation:
1969 onwards.

Method:
Series of short (2-3 months) campaigns. Radio spots only were used, repeated several times daily - 15 seconds to 30 seconds.

Coverage:
1973 - 28 radio stations serving 27 towns
1975 - 77 radio stations serving 39 towns
1976 - 30 radio stations serving 30 towns

Evaluation:
Three studies so far. The 1973 survey covered eight towns and showed that 94 per cent of the 3,600 persons interviewed had heard about family planning. Of these, 45 per cent had learned about it via the radio. Of the listeners to the radio campaign, one third had 'taken action' on family planning.

Remarks:
Profamilia considers radio as the best of the mass media for carrying information campaigns in Colombia. Their purpose is to reinforce awareness of family planning and help eliminate taboos, and the campaigns are regarded as having been successful in spite of the lack of variety in the radio formats (spots only). Three of Colombia's privately owned radio networks supported Profamilia with a campaign gratis in 1975 and two of them continued to do so in 1976.

Example 1

Announcer:

This child has brought joy into the home . . . will the next one also be a cause for happiness? The responsibility you undertake when you have a child goes beyond the tenderness and love you will give it. Plan your family.

Profamilia is there to guide and serve you.

Example 2

Operator:

Signature Tune - fade behind

Announcer:

Profamilia presents its programme: External Consultation. Questions and answers about family planning.

Operator:

Fade up music briefly and fade out

Man:

Doctor, my wife refuses to have frequent sexual relations with me, for fear of getting pregnant . . . and we've got problems in our marriage.

Woman:

Yes, doctor - it's because I don't want to have children just yet . . .

Man:

What can we do, doctor?

Operator:

Fade up music briefly then out

Announcer:

The contraceptive methods recommended by the doctor, will allow you to have sexual relations without the consequence of pregnancy.

The pill, contraceptive foam, creams and jellies, are all scientifically tested aids. Use them!

Profamilia is there to guide and serve you. Ask advice about your case.

Location:
Dominican Republic

Organizer:
Asociacion Dominicana Pro-Bienestar de la Familia
Inc - Radio School for Family Education (EREF)

Period of Operation:
1972 onwards

Method:
EREF broadcasts five consecutive days a week a programme entitled 'Towards a New Family'. Each broadcast is produced at a central studio on tape, copies being delivered to each of nine stations for transmission the following week. The magazine format of the programme includes talks, discussions, interviews, spot announcements, music, competitions and commentaries on listeners' letters - in short, the wide variety of items necessary to sustain interest in a programme which is 50 minutes long.

Coverage:
EREF broadcasts are carried by nine commercial stations which reach about 75 per cent of the population at the prime evening time of 8 to 9 o'clock.

Family Planning:
The topics covered by 'Towards a New Family' vary considerably and include nutrition, hygiene, child care and other matters of interest to present and future parents. Into this pattern the family planning message is inserted gradually, so that it is seen within a wider context.

Support Activities:
Printed materials, posters, leaflets and calendars. Written texts of talks given by the Radio School are available. Monitors established in every locality covered by the broadcasts report back to EREF headquarters weekly. By 1975 nearly 7,000 persons were participating in 165 listening groups. EREF also employs six motivators who act as links between the Radio School and family planning clinics. These *promotoras polalares* are now also involved in community-based distribution of contraceptives.

Each *promotora* is responsible for recruiting and keeping in touch with six 'distributors' drawn from the community. By the end of the first year of operation, 1975, the *promotoras* were estimated to have made a total of 28,800 house-to-house visits.

Financing:
The broadcasts are paid for by EREF which buys air-time from the nine commercial stations. Financial support comes from the central government. It was a grant from the IPPF that made possible the setting-up of the Radio School for Family Education in 1972.

Evaluation:
A survey sponsored by IPPF in 1973 indicated from those questioned an increase in the awareness and practice of family planning as a direct result of the Radio School broadcasts. EREF concludes that its 'Towards a New Family' is listened to in some 225,000 homes, and although the programmes are not aimed specifically at a rural audience, it is estimated that 70 per cent of listeners are in the countryside.

Remarks:
Plans are in hand to produce a series of dramatisations on family planning themes featuring rural characters - a kind of soap opera! There will be recorded field interviews with a view to introducing more direct listener participation in the broadcasts. EREF intends to organize listeners' discussion groups which will meet weekly to exchange views on the ideas contained in a programme broadcast specially for the purpose. Another innovation will be a regular series of booklets which will reflect a variety of topics covered by the Radio School. It is also planned to introduce a more systematic letter-answering service to deal with the problems and queries of individual listeners. Finally a serious effort will be made to provide continuous evaluation of the impact of the innovations on Radio School listeners.

Location:

Indonesia : Semarang in Central Java Province and Ujung Pandang in South Sulawesi Province

Organization:

Indonesian Planned Parenthood Association (IPPA)

Period of Operation:

Six months in 1975. Both were specially funded pilot projects.

Method:

Each month four programmes of 30 minutes each were produced and copied on to 80 cassettes. These were distributed to local IPPA branches which in turn loaned them to local stations. The format mostly used was a selection of popular and local songs interspersed with family planning messages or spot announcements. Occasionally short talks were included plus comedy and radio drama. Production and most of the script-writing was done by the one radio officer in each of the two FP Chapters involved.

Coverage

After the 1966 change of government, scores of privately owned radio stations sprang up in Indonesia, most of them in the intensely populated island of Java. All are operated on a commercial basis by companies, religious and other groups and by local government administrations. Alongside this multitude of mini-broadcasters is the network of official stations run by the Ministry of Information. Most of the stations are in big cities, the smaller towns being served by the local government-owned stations. In all, Indonesia contains well over 300 broadcasting stations. In the case of the Semarang Pilot Project, 35 stations in Central Java made use of the cassette service, without charge for air time.

Evaluation:

On completion of the project an evaluation was made by headquarters of the IPPA. The finding is that the project was successful as a back-up to fieldwork. The project also demonstrated that an effective and regular radio production service can be set-up and maintained on a 'shoestring'.

Remarks:

Since the project ended the recording equipment has not remained idle. In Semarang, for example, the radio officer continues to produce, from his regular budget, eight short programmes a month for IPPA distribution in Central Java. The cost is partly offset by a cassette copying service which is provided for the Government family planning body, the BKKBN, and for which a small charge is made. He also records from time to time the puppet shows so popular in Central Java, inserting family planning messages where appropriate; the cassettes are then sold to local radio networks.

Location:

The Philippines

Organization:

Family Planning Organization of the Philippines (FPOP).

Method:

FPOP's radio activities are tied in with *Magdamayan* national total community participation for family life). In this connection FPOP recently produced a song on *Magdamayan* which it is popularising through radio broadcasts. FPOP's Central Office produces: a radio drama series in four dialect versions; spot announcements; jingles; news items and general information on family planning developments; course material for the 'Family Planning School on the Air', which is widely broadcast and which offers a certificate to those listeners who complete the full course.

FPOP maintains close relations with the Rural Broadcasting Council. This organization of 200 volunteers, mostly journalists, produces and presents on six days a week a programme directed specifically to rural audiences. The 5-6 am broadcasts embrace a broad range: agriculture and social matters, hygiene and child care, news of the countryside and a family planning message. The broadcasts are heard throughout the Philippines.

Coverage:

Scattered among the many islands of the Philippines are dozens of privately owned radio stations, and the provincial chapters the FPOP cooperate with many of them. The formats they use vary considerably but could include discussions and interviews, talks and news, jingles, spot announcements and soap operas. An example of local cooperation is the FPOP support for the educational programme of ALU (Association of Labour Unions). The ALU has its headquarters in Cebu city, the country's second largest seaport, and it owns a radio station which is run for the benefit of the Philippines labour force. It broadcasts for 20 hours daily and its educational programmes incorporate material related to family planning.

Remarks:

Of the many radio stations operating in the Philippines, some are official, the majority private or commercial. Most give free air-time for family planning broadcasts.

Example 1

A series of soap operas (radio skits), from Quezon. Quoted below is the format and content of the series as envisaged by the producer:

'The episodes will deal with a doctor's experiences with rural people, discussing their problems of day to day living, giving helpful household hints every now and then. Medical instruction is a must for every episode, ranging from the treatment and early diagnosis of a wide range of diseases from common colds to tuberculosis. In the course of her experiences the Doctor will realise the importance of family planning, seeing the effect it has wrought on various lives that she touched. Eventually, planning its objectives, relevance and need for implementation will be discussed subtly or subliminally, but will never be its main content. Helpful advice for a couple with 13 children, advice for those about to get married, for the *barkadas* of the husband heckling him to have children so that he can prove he is a man, a reprimand from a grandmother wanting to have many grandchildren, etc. The opportunities are limitless for the exploration of the family planning theme while at the same time exploiting the mass media appeal to housewives and husbands wanting to learn some helpful medical instruction from *sera natiwidad*. The barrio people will have the opportunity of 'identifying themselves' with the characters the Doctor meets.

Selling points are:

1. Medical Instructions and other hints that will help in the early diagnosis and treatment of various diseases.
2. Other household tips like proper nutritional food for a balanced diet, etc.
3. They will cater to the curiosity of political concepts of listeners.
4. The medium for 'Identification' will be the variety of characters, the down-to-earth ordinary man in the street whom the Doctor meets in her daily rounds.

The message will eventually be the relevance and importance of Family Planning or Planned Parenthood. This will always be the logical solution to most of the problems the Doctor will try to solve.

Example 2 Spot announcement from Quezon

Announcer:

'It's hard to believe that the average husband and wife can spend close to 2,000 hours a year together and never get round to talking about family planning. Then when they realise it's about time, they have five or six children they've been so busy bringing up. Don't let the 'cat get your tongue' when it comes to discussing family planning with your spouse - or you may be seeing a lot more of babies than you expect'.

Example 3 Spot announcement from Quezon

Woman's voice (soft, sympathetic):

'I have a message for women. Are you tired? Are you tired of bringing up children? Are you afraid of another pregnancy? Do you have the time you need to make yourself pretty and enjoy life? You have no time except to give birth and bring up children? But there is the pill to help you out. It's easy to take, it's safe and it won't hurt you. You need not be afraid of the pill. Lately I have also heard about sterilization for men (vasectomy) and tubaligation and miniclip for women which is a permanent method. For information contact: . . .'

Location:

Colombo, Sri Lanka

Organization:

The International Planned Parenthood Federation, Indian Ocean Regional Office.

Period of Operation:

12 months beginning 1st January 1976

Method:

A 15 second spot announcement twice daily; a 30 second jingle three times daily; a 15 minute weekly programme 'Sukhi Ghar'. 'Sukhi Ghar' (Happy Home) was a 10-11 minute drama of the soap-opera type plus a question and answer session based on listeners' correspondence. The drama concerned itself with the multitude of problems that beset a rural family. The writing and production was done by the broadcasting staff using material supplied by the IOR Office. All broadcasts were in the Hindi language.

Coverage:

The FP broadcasts were radiated by the Sri Lanka Broadcasting Corporation's (SLBC) All-Asia Hindi Commercial Service. This popular Hindi Service uses powerful short-wave transmitters beamed to the North, North-West and North-East of the Sub-Continent, and covering Bangladesh, India, Nepal and Pakistan.

Evaluation:

An attempt at evaluation has been made. It encountered the difficulties all overseas broadcasting services face when attempting to assess the impact of their programmes on listeners abroad. The main source of information has been the analysis of incoming listeners' mail. The SLBC Hindi Commercial Service has given rise to more than 120 listeners fan clubs, mostly situated in India. Many of them publish newsletters and periodicals based on the programmes. In an attempt to use them as monitoring points for its FP broadcasts, in particular the 'Sukhi Ghar' programme, the IOR Office solicited their cooperation, and the response was encouraging. Questionnaires were also sent to the

clubs and to listeners who corresponded regularly with the IOR Office.

Remarks:

Production costs and air-time were met by the IOR Office. The project is of considerable interest in its use of short-wave transmission to project the family planning message far beyond national frontiers.

Location:

St Vincent, West Indies

Organization:

The St Vincent Planned Parenthood Association

Period of Operation:

January 1976 onward

Method:

A weekly programme of 15 minutes, 'Family Planning Night', is broadcast at the prime evening time of 7.45. The signature tune is one or two stanzas of the Family Planning Calypso, which has become the PPA's theme song. The programme content varies from talks, discussions and short stories to interviews and role-playing. In addition to the weekly programme a spot announcement is repeated six times daily on average; the spot is changed at weekly intervals.

Coverage:

The one broadcasting station on St Vincent is owned and operated by the government. It reaches the entire island population which is very radio conscious. Nearly every rural family owns a transistor radio. The radio facilities are granted free of charge.

Evaluation:

No organized research has been carried out but feedback from field visits indicates that the broadcasts are very much appreciated.

Remarks:

The topics dealt with in 'Family Planning Night' have covered a very wide range. To name but a few: 'Health Education and Schools', 'Family Planning

and Nutrition', 'Men's Irresponsibility', 'The Increasing Population and Unemployment in Relation to Crime', 'Family Planning and Promiscuity', 'Family Life Education', 'Family Planning - an Approach to National Development', etc.

Examples of Broadcast Material

Example 1

Spot announcements:

Don't get pregnant just for pleasure
With fewer mouths to feed, your pay cheque goes further.

Believe it or not, it can happen to you,
Having an unwanted child just won't do
So don't let pride stand in your way
Visit the Family Planning Clinic today.

Carnival is a time for gay abandon
So do remember to use a condom.

Having a baby too soon can ruin your career
Visit the Family Planning Clinic -
the folks there CARE

Have no misconception
Use some form of contraception

To have unwanted children, there's no excuse
When there are so many contraceptives from which
to choose

Avoid famine with Family Planning.

Before you plan your Easter picnic
Plan a visit to the Family Planning Clinic.

Sexually active?
Then why not use a contraceptive?

Every child should be wanted
So avoid unwanted ones being implanted.

After the Flood these words were said,
'... multiply and replenish the earth'
Today there are many mouths to be fed,
There's no room for an unwanted birth.

Hope is not a method —
This has been proved already.
Don't let your future be hindered
By an unwanted pregnancy.

Overcrowding and juvenile delinquency often go hand
in hand

Spacing your family would help us all enjoy a better
land

Don't let unwanted pregnancies hover,
By having a vasectomy, your problems are over.

Don't take chances,
Take Family Planning.

Don't tempt fate —
Start using contraceptives before its too late.

Hope cannot prevent pregnancy —
Contraceptives can!

Start a family tradition
Use some form of contraception.

We practise pest control —
Why not birth control?

Everyone has the right to plan his family —
Plan your family to avoid more worry.

Help your community and the nation,
Smaller families mean less overpopulation.

Overpopulation begins at home!

Plan today,
Reap the benefits tomorrow.

There's no planning like FAMILY PLANNING.

You and Planned Parenthood
Can save the State from overpopulation.

Get to know how the two of you don't have to become
the three of you

Example 2
The St Vincent Family Planning Calypso
Composed and sung by the Mighty Sheller,
Calypso King 1965-67-70-71-72

They say ninety thousand, is our population,
One hundred and fifty square miles of land
For we to live on.
One fifth of the population is strong and healthy
women
Don't doubt everyone of them could produce children.

Chorus: There is need I see, in this country
So start plan your family,
Otherwise is more delinquency
More crime and more poverty.
So do some family planning, and help the
situation
Join St Vincent Planned Parenthood
Association.

We have pills for every woman, to give them good
protection,
The Ovral, and Norlestrin, Serial 28 and Eugynon.
You can get a diaphragm, a loop, or a tying off;
So when you see your friend belly big, make style on
she and laugh.

Young men of this country I want you to realise
If you join in this exercise, you can get yourself
sterilise
Come, take the operation, it's simple and quite easy,
That wouldn't prevent you from enjoying sexual
activity.

Our local Association will give you some good advice
When you need it, come and visit, the staff is helpful
and nice:
So my fellow Vincentians, I am telling you in advance
I feel Family Planning is of National importance.

Suggested Short Reading List

- Aspinall, Richard, *Radio Programme Production*, UNESCO, 1973.
- Bordenave, Juan E. Diaz, *Communication and Rural Development*, UNESCO, 1977
- Gough, Howard, *The Radio Programme*, Asian Institute for Broadcasting Development, Kuala Lumpur, 1977.
- Hancock, Alan (Editor), *Producing for Educational Mass Media*, UNESCO and Longman, 1976.
- Herbert, John, *The Techniques of Radio Journalism*, Adam and Charles Black, 1976.
- Leven, Harry L., and Gillespie, Robert W., *The Use of Radio in Family Planning*, World Neighbors, Oklahoma City, USA.
- Lee, Miles, *Radio Production*, East African Literature Bureau, Nairobi, 1977.
- Nisbett, Alec, *The Use of Microphones*, Focal Press, 1974.
- Nisbett, Alec, *The Technique of Sound Studio*, Focal Press, 1962.
- Rawson-Jones, Daphne, and Salkeld, Geoffrey, (Editors), *Communicating Family Planning*, IPPF, 1971.
- El-Bushra, Judy and Perl, Susan (Editors), *Family Planning Education in Action*, IPPF, 1976.
- UNESCO Reports and Papers in Mass Communication*
No. 51 (1965) 'An African Experiment in Radio Forums for Rural Development'.
No. 1 (1975) 'Communication Media, Family Planning and Development'.
No. 2 (1975) 'Communication Research in Family Planning'.
No. 3 (1975) 'Research in Population Communication'.

Cassettes to accompany this book

Prerecorded tape cassettes containing many examples of the ways in which radio is used by various family planning associations around the world including some of those examples referred to in this book are available from the International Planned Parenthood Federation, 18-20 Lower Regent Street, London SW1Y 4PW, at a cost of US\$5.00 including packing and postage.