

ROPE WORKS ARCHIVE

[GO TO ARTICLE OF THE MONTH ARCHIVE](#)

[GO TO ANIMATED KNOTS](#)

[GO TO DOWNLOAD PAGES](#)

[!\[\]\(d66ff64371a51729ac8c1cdaa685ba6f_img.jpg\)](#) [Home](#) [!\[\]\(0f31ebba7abcd47777e178db26f29705_img.jpg\)](#)
[GUESTBOOK](#)
[E-Mail](#)

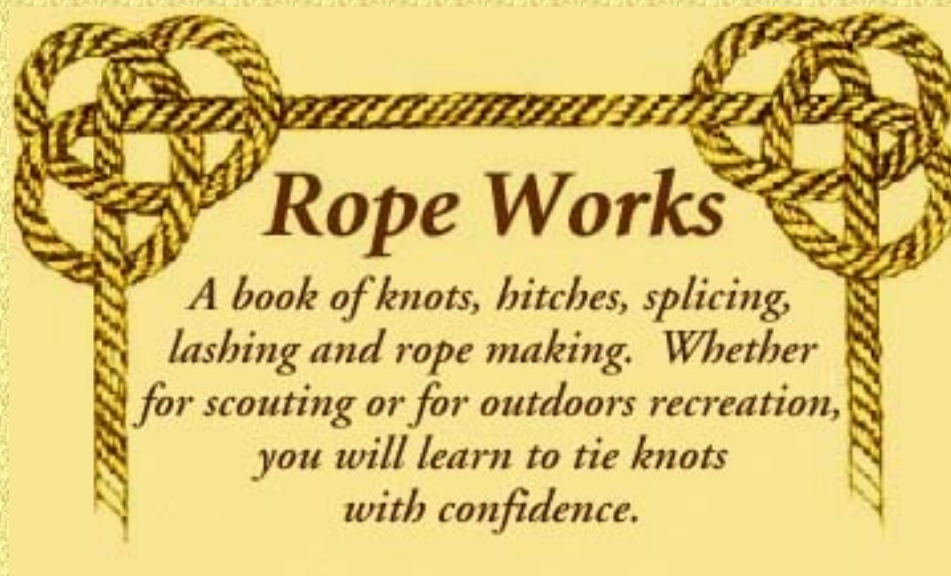

**Rope Works can now be ordered by
credit card Through PayPal**





Order a copy of RopeWorks now !

ARTICLE OF THE MONTH ARCHIVE

"TURK'S HEAD "

"RINGBOLT HITCHING"

"BOATSWAIN'S WHISTLE KNOT"

"DIAGONAL LASHING"

"CONSTRUCTOR KNOT"

"MONKEY'S PAW (Turh's Head Style)"

"MOORING HITCH"

"JUG KNOT"

"BELAYING TO A CLEAT"

"WHIPPING"

"FIGURE-EIGHT"

"TRIPOD LASHING"

"SHEET BEND"

"MASTHEAD KNOT"

"FLOOR LASHING"

"MAULS"

"FUSING"

"TAUT-LINE"

"SPANISH WINDLESS"

"ROPE HALTER"

"LADDER LASHING"

"SEIZING"

"FIDS"

"JAPANESE SQUARE LASHINGS"

"MARLIN SPIKE HITCH"

"FOOTROPE KNOT"

"CAMP STOOL:"

"MONKEY'S PAW (Coil Stile)"

"MAKING A CLEAT"

"ROPE WRENCH"

"NETTING"

"PROLONG KNOT"

"LIFE BASKET"

"KNOB COVERING"

"CROWN KNOT"

"WALL KNOT"

"ALAMAR KNOT"



GO TO TOP OF PAGE



ANIMATED KNOTS



"(Animated) TURK'S HEAD"

"(Animated) BOATSWAIN'S WHISTLE KNOT"

"(Animated) CONSTRICTOR KNOT"

"(Animated) MOORING HITCH"

"(Animated) BELAYING TO A CLEAT"

"(Animated) FIGURE-EIGHT"

"(animated) WHIPPING"

"(animated) BOWLINE"

"(animated) BOWLINE ON A BIGHT"

"(animated) CROWN KNOT"

GO TO TOP OF PAGE

DOWNLOAD OF THE MONTH

The following PFD files are based on articles being assembled for a new publication. However, some of the knotboards are contained in ROPE WORKS.

These PDF files are formatted so that the printed copy can be placed in a three-ring-binder.

PDF files can be opened and printed using Acrobat Reader.



DOWN LOAD INSTRUCTIONS

When using **Netscape** as your browser, these files can be DOWNLOADED by clicking on the title.

When using **Internet Explorer** as your browser, select the DOWNLOAD FILE function and enter the URL that appears after the title.

"BOWLINE ON A BIGHT" -----

<http://humber.northnet.org/ropeworks/reader/bowbight.pdf>

"CLOVE HITCH" ----- <http://humber.northnet.org/ropeworks/reader/clove.pdf>

"SQUARE LASHING" -----

<http://humber.northnet.org/ropeworks/reader/squarlas.pdf>

"EYE SPLICE" ----- <http://humber.northnet.org/ropeworks/reader/eyespli.pdf>

"TURK'S HEAD " ----- <http://humber.northnet.org/ropeworks/reader/turkshea.pdf>

"RINGBOLT HITCHING" -----
<http://humber.northnet.org/ropeworks/reader/ringbolt.pdf>

"BOATSWAIN'S WHISTLE KNOT " -----
<http://humber.northnet.org/ropeworks/reader/boatswai.pdf>

"DIAGONAL LASHING " -----
<http://humber.northnet.org/ropeworks/reader/diaglash.pdf>

"CONSTRUCTOR KNOT " -----
<http://humber.northnet.org/ropeworks/reader/bowbight.pdf>

"MONKEY'S PAW (Turk's Head Style):" -----
<http://humber.northnet.org/ropeworks/reader/constric.pdf>

"MOORING HITCH" ----- <http://humber.northnet.org/ropeworks/reader/mooring.pdf>

"JUG KNOT" ----- <http://humber.northnet.org/ropeworks/reader/jugknot.pdf>

"BELAYING TO A CLEAT" -----
<http://humber.northnet.org/ropeworks/reader/cleat.pdf>

"WHIPPING" ----- <http://humber.northnet.org/ropeworks/reader/whipping.pdf>

"FIGURE-EIGHT KNOT" -----
<http://humber.northnet.org/ropeworks/reader/fig8-t.pdf>

"TRIPOD LASHING" ----- <http://humber.northnet.org/ropeworks/reader/tripod.pdf>

"SHEET BEND" ----- <http://humber.northnet.org/ropeworks/reader/sheben.pdf>

"MASTHEAD KNOT" -----
<http://humber.northnet.org/ropeworks/reader/masthead.pdf>

"FLOOR LASHING" ----- <http://humber.northnet.org/ropeworks/reader/flash.pdf>

"MAULS" ----- <http://humber.northnet.org/ropeworks/reader/mauls.pdf>

"FUSING" ----- <http://humber.northnet.org/ropeworks/reader/fusing.pdf>

"TAUT-LINE HITCH" ----- <http://humber.northnet.org/ropeworks/reader/tautline.pdf>

"SPANISH WINDLESS" -----
<http://humber.northnet.org/ropeworks/reader/swindless.pdf>

"ROPE HALTER" ----- <http://humber.northnet.org/ropeworks/reader/Rhalter.pdf>

"LADDER LASHING" ----- <http://humber.northnet.org/ropeworks/reader/ladder.pdf>

"SEIZING" ----- <http://humber.northnet.org/ropeworks/reader/seizing.pdf>

"FIDS" ----- <http://humber.northnet.org/ropeworks/reader/fusing.pdf>

"JAPANESE SQUARE LASHINGS:" -----
<http://humber.northnet.org/ropeworks/reader/JsqrLSH.pdf>

"MARLIN SPIKE HITCH:" -----
<http://humber.northnet.org/ropeworks/reader/marlin.pdf>

"FOOTROPE KNOT:" -----
<http://humber.northnet.org/ropeworks/reader/footrope.pdf>

"CAMP STOOL:" ----- <http://humber.northnet.org/ropeworks/reader/campstool.pdf>

"MONKEY'S PAW (Coil Stile):" -----
<http://humber.northnet.org/ropeworks/reader/monkpawcoil.pdf>

"MAKING A CLEAT:" ----- http://humber.northnet.org/ropeworks/reader/cleat_.pdf

"ROPE WRENCH:" ----- <http://humber.northnet.org/ropeworks/reader/wrench.pdf>

"NETTING:" ----- <http://humber.northnet.org/ropeworks/reader/net-1.pdf>

"PROLONG KNOT:" ----- <http://humber.northnet.org/ropeworks/reader/prolong.pdf>

"LIFE BASKET:" ----- <http://humber.northnet.org/ropeworks/reader/lifbas.pdf>

"KNOB COVERING:" -----

<http://humber.northnet.org/ropeworks/read02/knobcover.pdf>

"CROWN KNOT:" ----- **<http://humber.northnet.org/ropeworks/read02/crown.pdf>**

"WALL KNOT:" ----- **<http://humber.northnet.org/ropeworks/read02/wallknot.pdf>**

"ALAMAR KNOT:" ----- **<http://humber.northnet.org/ropeworks/read02/alar.pdf>**



[GO TO TOP OF PAGE](#)



GO TO ARCHIVE

ARTICLE OF THE MONTH

Each month there will be a new knot related article displayed on this page.

THIS MONTH'S IS THE :

<

ALAMAR KNOT

The alamar knot is a decorative knot related to the pretzel knot. The pretzel knot is tied in a single strand; the alamar knot is tied by doubling the strands as shown in [Step 1]

[Step 1] Double the strand as shown.



[Step 2]

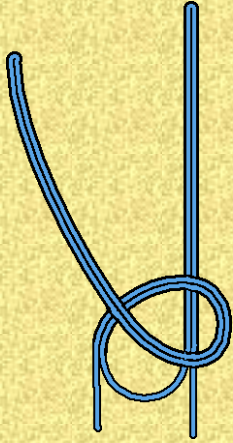

[Step 3]

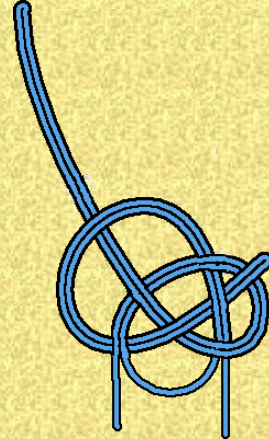
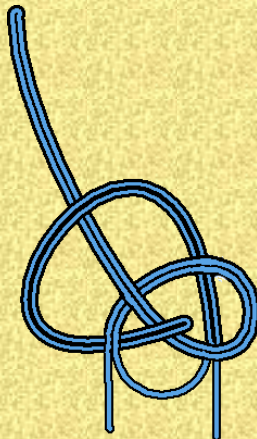
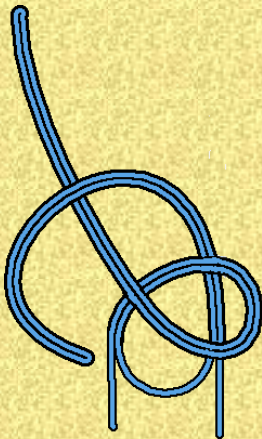

[Step 4]

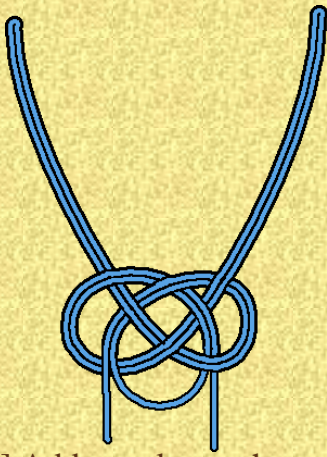

[Step 5] Add tassels or other end decorations.



KNOTBOARD OF THE MONTH

ARCHIVE



Home
E-Mail



Introduction
Knots & Hitches
Splicing
Lashing
Making Rope
Links
Knotboard of the Month
Archive
Ordering

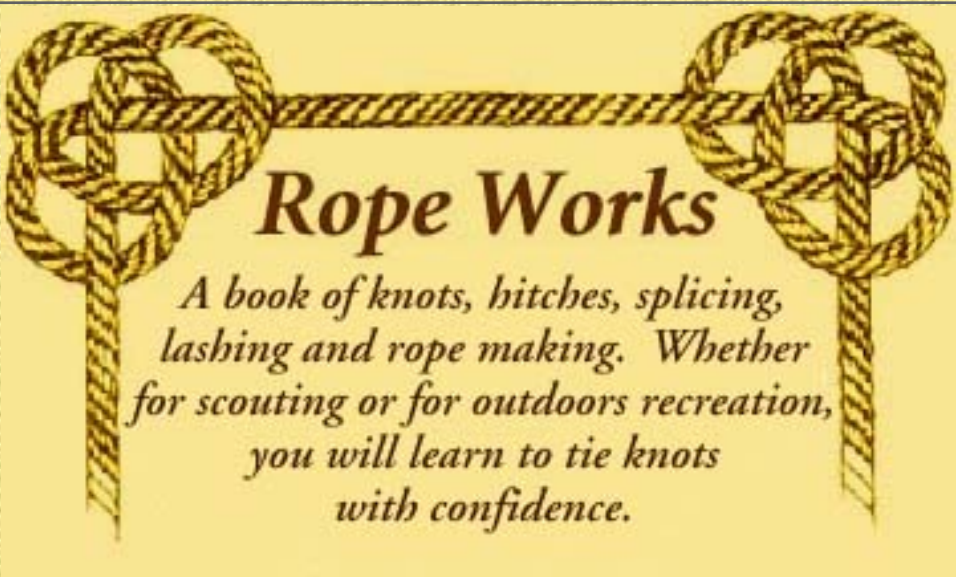

Rope Works
A book of knots, hitches, splicing, lashing and rope making. Whether for scouting or for outdoors recreation, you will learn to tie knots with confidence.

This site was updated JUNE 23, 2002 :

Rope Works can now be ordered by credit card Through PayPal



FastCounter by LinkExchange

FastCounter by LinkExchange

<http://www.fastcounter.com>

 **GUESTBOOK** 
[E-Mail](#)



GUESTBOOK.....

Please enter your name:

and your email address:

Enter your comments and suggestions below:

Thanks for your input

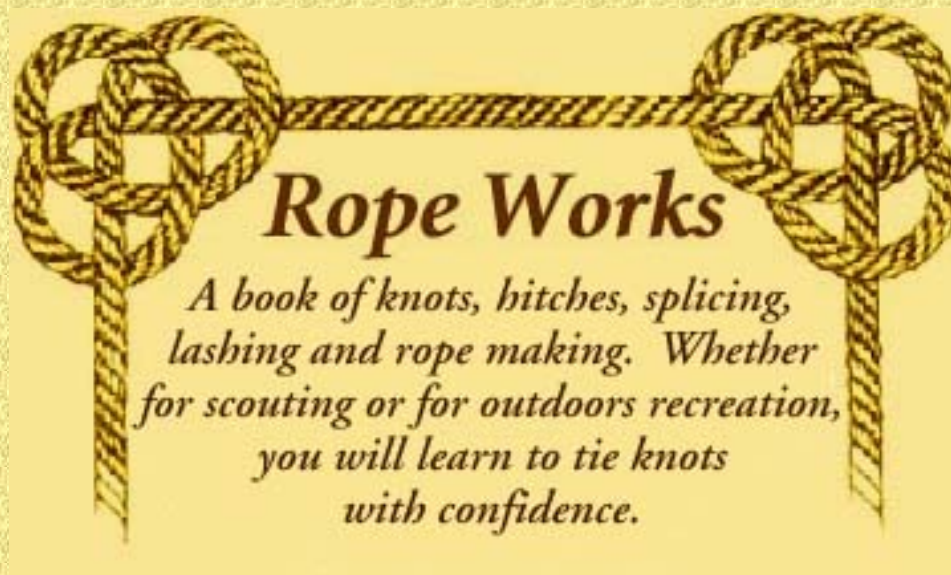

Order a copy of RopeWorks now !



Home



To place an order use the following to caculate the the Total Payment.

Rope Works Order: (must be in US funds)

QUANTITY	* \$8.35	COST OF BOOKS
	SHIPPING	See below
	TOTAL	COST OF BOOKS + SHIPPING
	NY Sales Tax (7%)	If your live in New York State, caculate and add the NY Sales Tax
	TOTAL PAYMENT	TOTAL + NY Sales Tax

Shipping and Handling Fees

To each shipping address in the USA or Canada:

- one or two books \$3.00.
- Three or four books 3.50

To each shipping address outside the USA or Canada:

- one or two books \$5.00.
 - three or more books check with me by E-mail (gfindley@northnet.org)
-

To order by regular mail



ORDER BY MAIL

To order by credit card through PayPal

Use the work sheet above to caculate the **TOTAL PAYMENT**

Enter the **TOTAL PAYMENT** as the **Amount:** on the PayPal page.



[Home](#)
[E-Mail](#)

KNOTBOARD OF THE MONTH

TURK'S HEAD:

Description ----

Three strand braid worked in a continuous circle.

Use ----

- (1) As a decorative knot around a staff or railing.
- (2) Worked tight around a checked or cracked tool handle or canoe paddle to reinforce them.
- (3) As a neckerchief slide or wogal.

Comments ----

The form of Turks head shown here is a five crown Turk's head, this is only one of a group of knots that go by the name Turk's heads. The crown number is determined by counting the number of bights at the edge of the knot. To make a larger loop the, increase the size of the wraps made in steps 1 - 4 and then, at step 7 use three strand braiding to increase the number of crowns. The number of crowns can be increased by increments of three; so that the number of crowns in a larger loop can be 8, 11, 14, etc..The size of the finished Turk's head depends on the size of the rope used and the number of times the strand is chased.

Other Names ----

Three lead by five bight Turk's head, ordinary Turk's head.

Narration ----- (For Turk's head knotboard.)

- (1) Start at the center of the line, by taking a

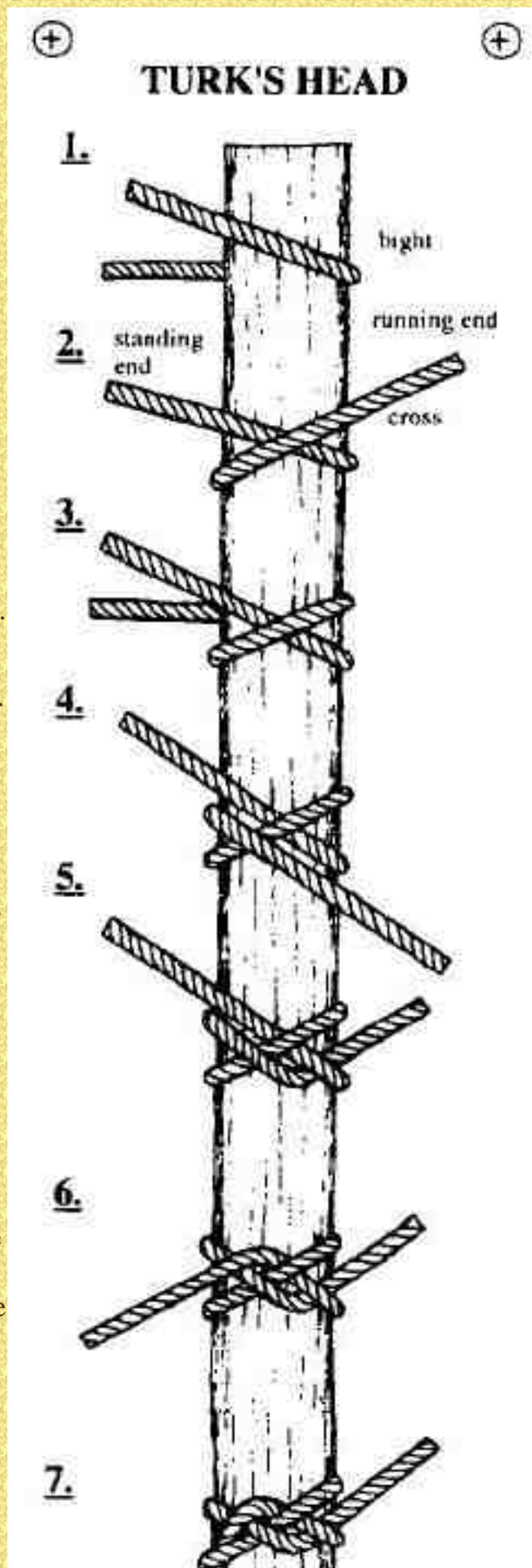

bight around an object (the fingers of the left hand work well) (2) Complete the round turn and cross the running end over the standing end. (3) Take a second bight around the object so that the running end is between the standing end and the first wrap. (4) Lay the running end across the first wrap then (5) tuck the running end under the standing end. (6) lay the standing end across the second wrap and (7) tuck it under the first wrap. (8) rotate the knot around the object so that you are looking at the opposite side. (9) Cross the second wrap over the first wrap. (10) Reeve the standing end through the eye formed between the two wraps. (11) Reeve the running end through the eye between the two wraps so that the ends are in opposite directions. (12) Chase, follow, the strand of the knot two or three times. Cut off and secure the ends.

[NOTE] To determine the length of line to use, wrap the line around the object four times for a single strand knot. Add three and one half wraps for each time you intend to chase the original strand.

ANIMATED KNOT



TURK'S HEAD KNOT

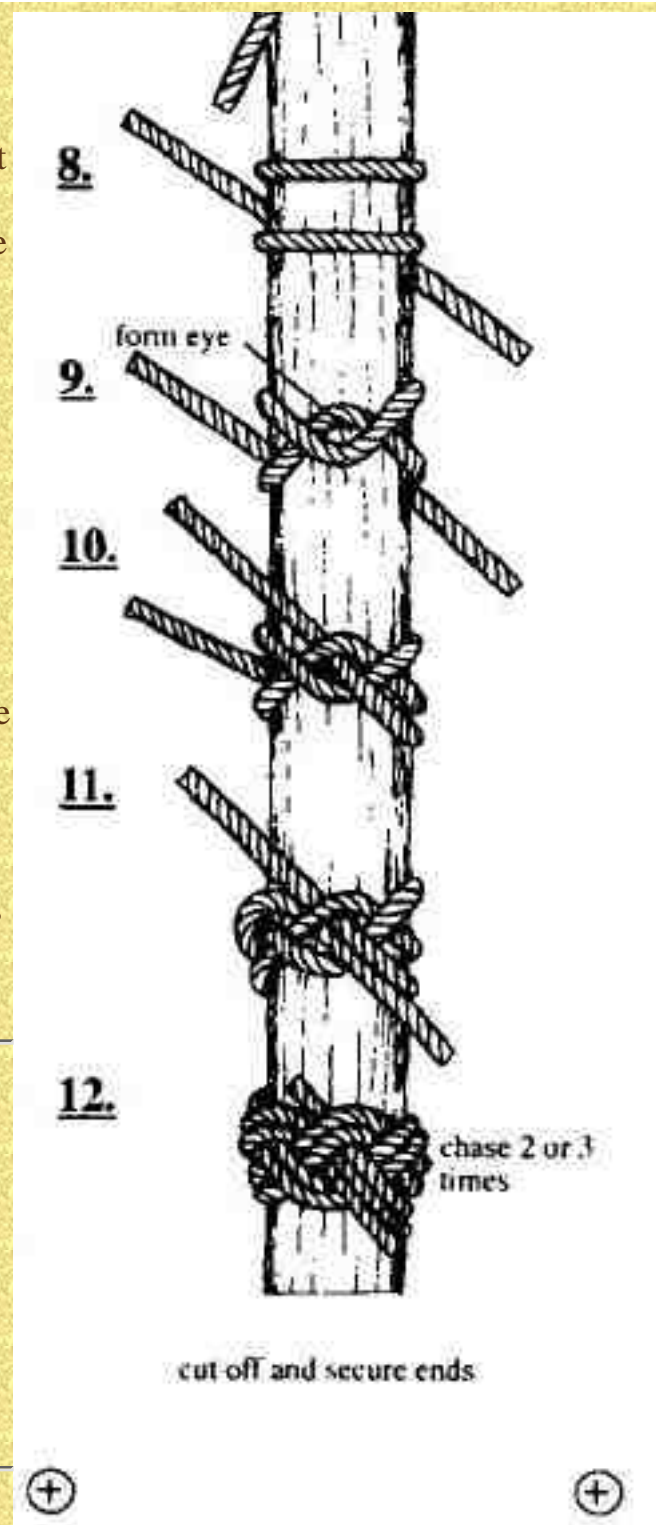



Home
E-Mail



[Home](#)
[E-Mail](#)

KNOTBOARD OF THE MONTH

RINGBOLT HITCHING:



Description ----

A series of interlocking lark's head knot that form a ridge around the outside of a ring or loop.

Use ----

To prevent chafing; as a decoration.

Comments ----

There are many forms of ringbolt hitching, the form shown here is one of the simplest and does not require the use of a needle as many other forms do. Ringbolt hitching was used to prevent chafing of ropes that were reeved through hand forged iron rings and to keep them from clanging against objects around them. In the present,

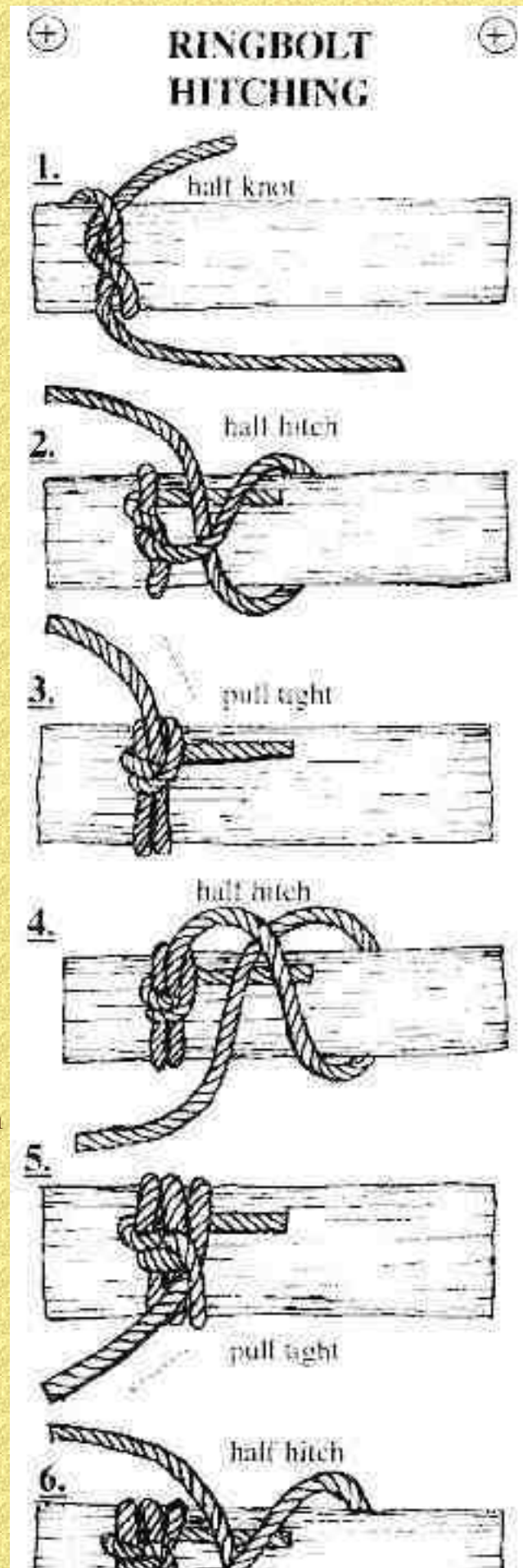

ringbolt hitching can be used to protect synthetic ropes that are easily chafed by applying a layer of material that is not easily chafed.

Other Names ----

Platted Ring; Hog Backing; Cockscombing.

Narration ----- (For Ringbolt Hitching knotboard.)

(1) Start the ringbolt hitching by tying a half knot around the object. (2) Tie a half hitch around the object so that the standing end is trapped under the half hitch. (3) pull the half hitch tight. (4) Tie the next half hitch in the opposite direction around the object. (5) Pull the half hitch tight. (6) Tie another half hitch in the opposite direction around the object; the same direction as the first half hitch. (7) Pull half hitch tight. (8) When the length of the ringbolt hitching is within 5 or 6 half hitches of being long enough; form a bight in the a short piece of twine so that the eye of the bight is toward the end of the work. (9) Continue to add half hitches until the ringbolt hitching is completed; reeve the running end through the eye of the bight. (10) Use the short piece of twine to pull the running end under the half hitches. (11) Cut off the end of the twine.

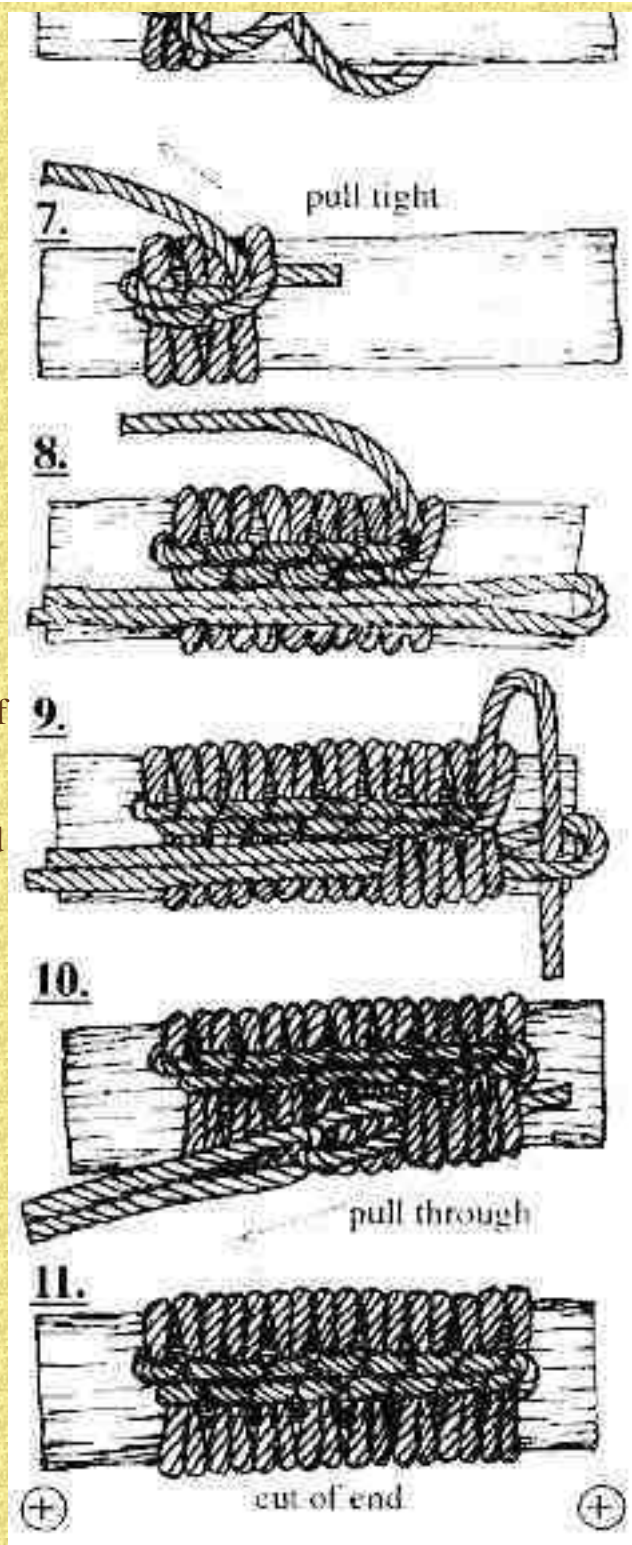



Home
E-Mail



[Home](#)
[E-Mail](#)

KNOTBOARD OF THE MONTH

BOATSWAIN'S WHISTLE KNOT:

Description ----

A two lead knot that is built up from two interlocking underhand loops to looks like a turk's head knot when it is worked tight.

Use ----

As a decorative knot to attach a whistle or a knife to a lanyard ---- to form a toggle or button.

Other names ----

Sailor's knife lanyard knot, marlingspike lanyard knot, single-strand diamond knot, two strand diamond knot ---- pipe lanyard knot.

Narration -- (For

Boatswain's Whistle Knot knotboard.)

((1) Use the left hand to hold the middle of a strand of rope so that the loop of the bight is to the back of the hand and the two leads are between the fingers and hanging down across the palm. (2) Use the bottom lead, to lay an underhand loop over the standing end of top lead. (3) Form a bight in the bottom lead so that its running end is under the running end of the top lead. (4) Weave the running end of the bottom lead over the right edge of the top underhand loop, then under the standing end of the bottom lead, and over the left edge of the top underhand

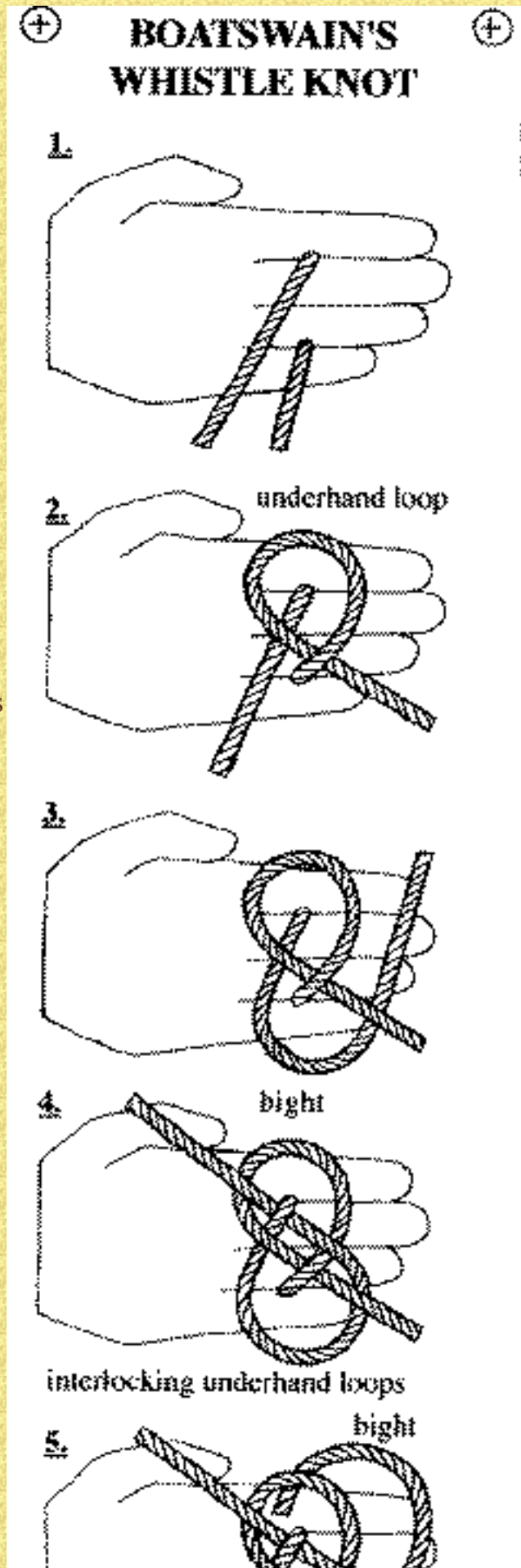

hand loop. This forms two interlocking underhand loops. (5) Form the next bight by placing the running end of the top lead under the top edge of the top underhand loop. (6) Reeve the running end of the top lead to the outside of the standing end of the bottom lead and up through the middle of the interlocking underhand knots. (7) Form the next bight by placing the running end of the bottom lead under the bottom edge of the bottom underhand loop. (8) Reeve the running end of bottom lead to the outside of the standing end of the bottom lead and up through the middle of the interlocking underhand knots. (9) Work the knot tight.

ANIMATED KNOT



BOATSWAIN'S WHISTLE KNOT

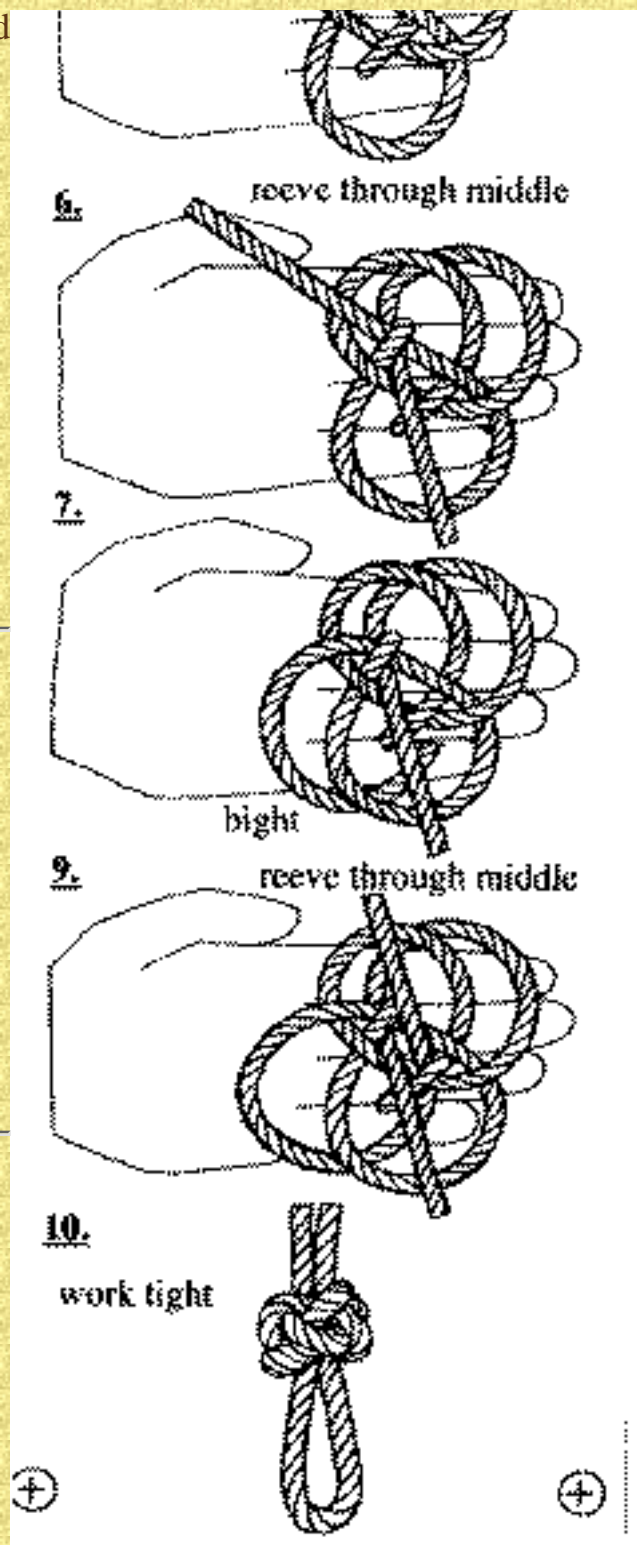



Home
E-Mail



[Home](#)
[E-Mail](#)

ROPE WORKS ©1996 Gerald L. Findley, all rights reserved

KNOTBOARD OF THE MONTH

DIAGONAL LASHING:

Use ----

Diagonal lashing is used to bind poles together that cross each other but do not touch when their ends are lashed in place in a structure.

Comments ----

The diagonal lashing gets its name from the fact that the wrapping turns cross the poles diagonally.

The diagonal lashing can be used to bind poles that cross each other from 90o to 45o. If the angle between the poles is less than 45o a shear lashing should be used.

The diagonal lashing makes use of the timber hitch to pull poles together that are not touching each other. The timber hitch allows the poles to be drawn together without changing the relative positions of the poles.

[NOTE] If a square lashing were used to bind poles that do not touch, the beginning clove hitch would pull the cross pole toward the clove hitch causing unnecessary bowing of the cross pole and could also produce a force that would act along the length of the pole to which the clove hitch is tied. These additional force, if strong enough, can place unnecessary strain on other lashing within the structure causing the structure to twist and fail.

Narration ----- (For Diagonal Lash knotboard.)

(1) Tie a timber hitch diagonally around both poles. (2) Start the wrapping turns on the opposite diagonal to the timber hitch, by pulling the rope tight so that the poles contact each other. (3) Take 3 to 4 wrapping turns; keep

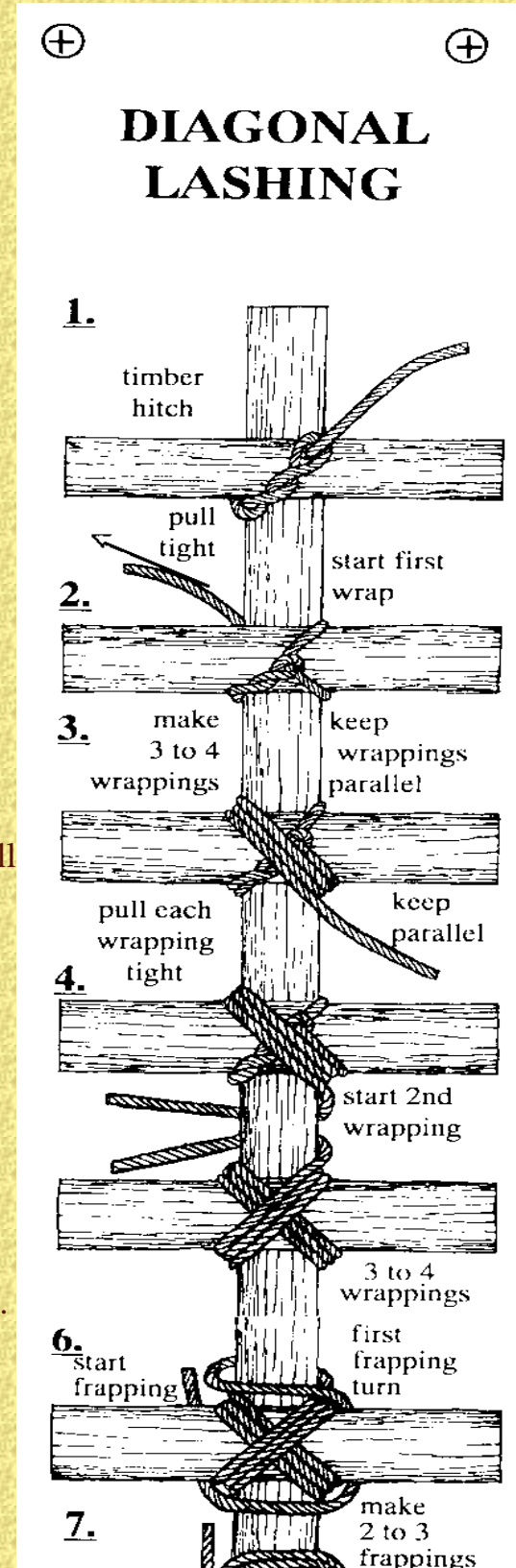

the wrapping turns parallel; pull each wrapping turn tight. [NOTE] If the wrapping turns are allowed to cross, the increased friction between the strands of the rope will make it difficult to tighten the wrapping turns. (4) Start the second set of wrapping turns by going past and around the vertical pole. [NOTE] Going around the pole the rope allows the direction of the rope to be changed without crossing the first set of wrapping diagonally. (5) Take 3 to 4 wrapping turns; be sure to keep the wrapping turns parallel; pull each wrapping turn tight. (6) Start the frapping turns by going past and around one of the poles. [NOTE] Going around the pole with the rope allows the direction of the rope to be changed without crossing the wrapping turns diagonally. (7) Take 2 to 3 frapping turns; keep the frapping turns parallel. Be sure to pull each turn tight. (8) End the lashing with a clove hitch. Take the first half hitch of the clove hitch by going past and then around one of the poles. Lock the half hitch tight against the lashing by working it tight. (9) Take a second half hitch around the pole. (10) Work the second half hitch tight against the first half hitch so that the clove hitch is locked against the lashing.

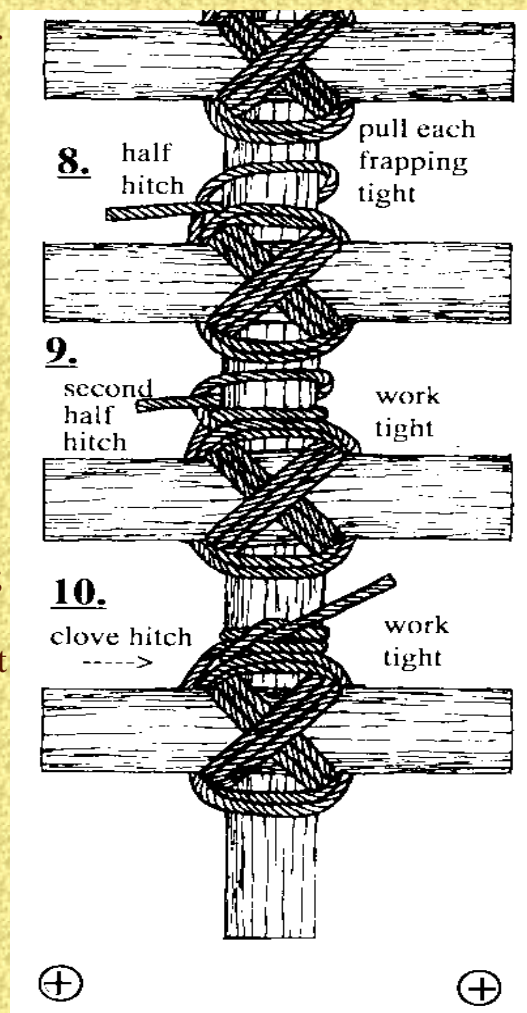

[NOTE]

If very smooth rope is used, the lashing can be made more secure by adding a third or fourth half hitch to the clove hitch.



[Home](#)
[E-Mail](#)



Home

ARCHIVE

ROPE WORKS ©1996 Gerald L. Findley, all rights reserved

KNOTBOARD OF THE MONTH

Each month there will be new knotboard and descriptive text displayed on this page.

THIS MONTH'S IS THE :

CONSTRUCTOR KNOT:

Description ----

A clove hitch with a half knot under the cross-point.

Use ----

To tie a smaller rope to a larger one, or to tie a rope to a stake or pole; a substitute for whipping; as a lashing for light construction ; as a hose clamp.

Comments ----

A secure nonslip knot ; difficult to untie without cutting.

[NOTE]

Use this method of tying the constrictor knot on either side of where you intend to cut a rope. This is a fast and easy way to prevent a rope from unlaying when it is cut.

Narration ----- (For Constrictor Knot knotboard.)

((1) take a bight around an pole. (2) Continue wrapping the running part around the pole so that the running part crosses over the standing part. (3)

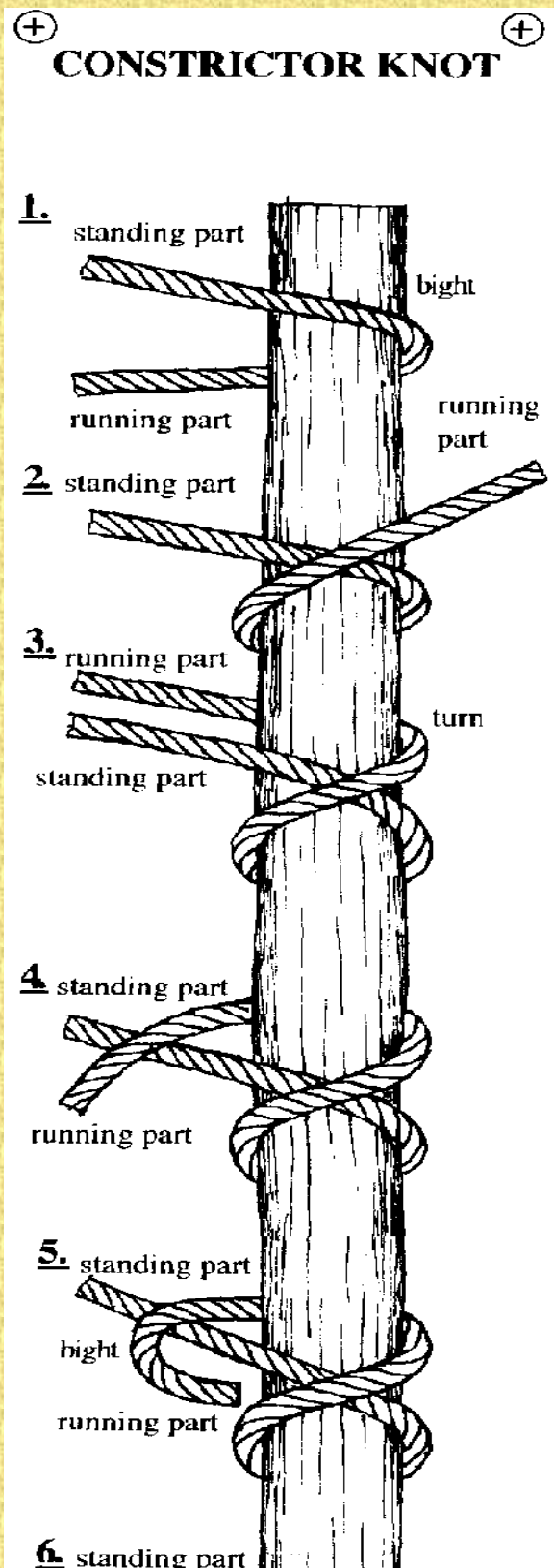

Complete the turn around the pole. (4) Cross the running part over the standing part so that (5) a bight is formed around the standing part. (6) Reeve the running part under the cross part of the loop in the standing part to form a half knot under the cross-point. (7) Pull the standing tight. (8) Lock the knot tight by pulling hard on both the standing part and the running part.

ANIMATED KNOT



BOATSWAIN'S WHISTLE KNOT

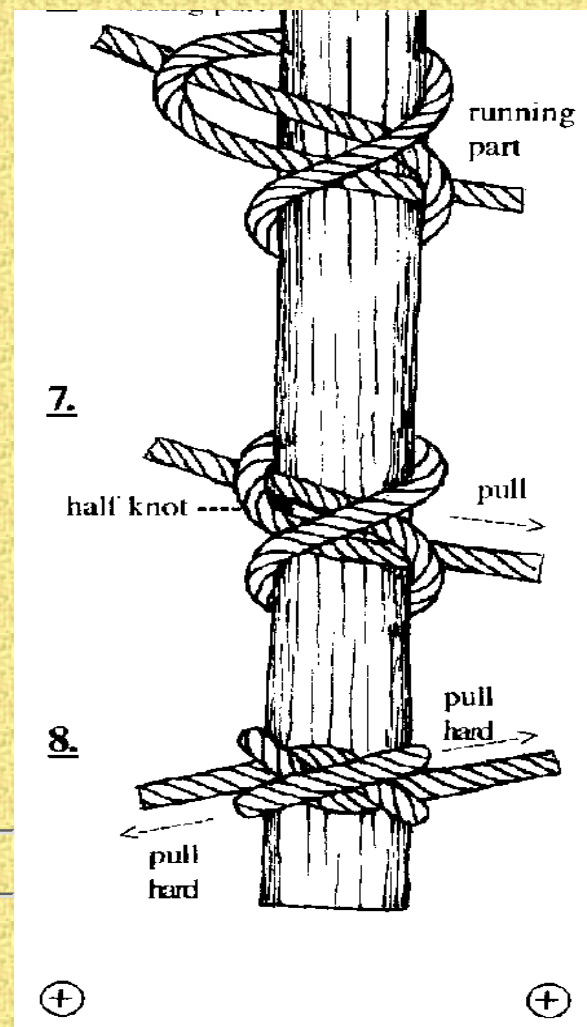

KNOTBOARD OF THE MONTH

ARCHIVE



Home
E-Mail



[Home](#)
[E-Mail](#)

KNOTBOARD OF THE MONTH

MONKIE'S PAW:

Description ----

Two forms of the monkey's paw are shown here the first is formed from four interlocking loops: a four crown turk's head; the second is constructed from three interlocking coils.

Use ----

The core determines what the monkey's paw can be used for. When tied over a stone or heavy ball, the monkey's paw can be used to add weight to a heaving line. If tied over a cork ball with small cord the monkey's paw makes a good float for boat keys or other small items used around a water front. Tied over a ball of twine or other soft material, the monkey's paw can be used as weight on the end of a rope for the game jump the shot. A Monkey's Paw can also be used as a toggle..

Comments ----

Neither form of the Monkey's Paw has an advantage over the other. Which one you choose to use is a matter of personal preference.

Core Size ----

The diameter of the core should be between three and four diameters of the rope being used..

Narration ----- (For Monkey's Paw Turk's Head knotboard.)

(1) Form an overhand loop (2) Form a second

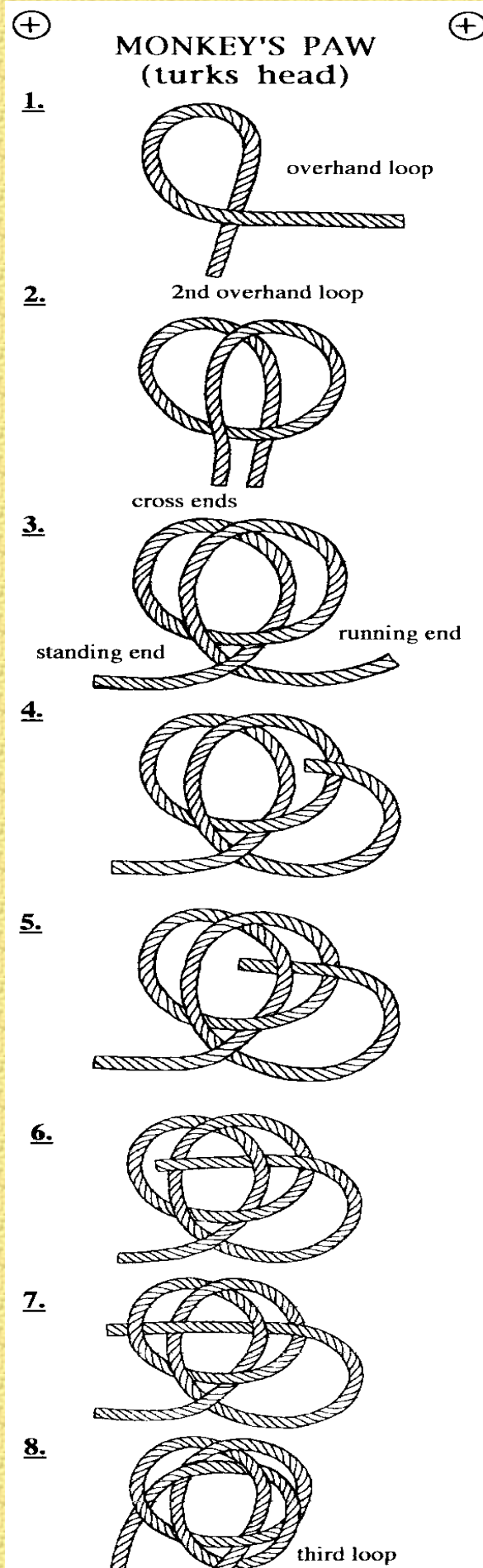

overhand loop over the left edge of the first overhand loop . (3) Cross the standing end over the running end. (4) Weave the running end across the loops by placing the running end over the right side of the top loop (5) then under the right side of the bottom loop (6) next, over the left side of the top loop (7) and finally under the left side of the of the bottom loop. (8) Pull the running end through until a third loop equal in size to the first two loops. (9) Add the fourth loop by placing the running end parallel to the standing end. (10) Chase the original pattern 2 to 3 times. (11) Work tight over the core.

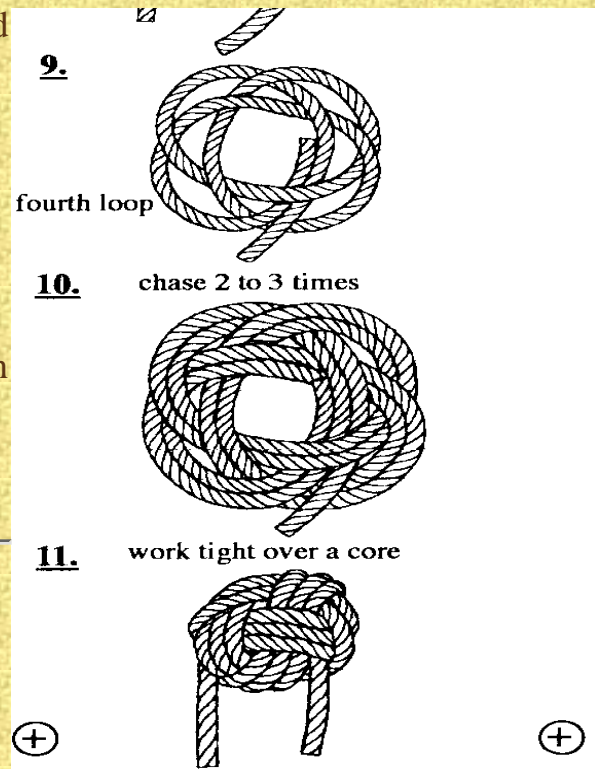

[Home](#)
[E-Mail](#)



Home ARCHIVE

KNOTBOARD OF THE MONTH

Each month there will be new knotboard and descriptive text displayed on this page.

THIS MONTH'S IS THE :

MOORING HITCH:

Description ----

An underhand loop toggled to the standing part with a bight made in the running end.

Use ----

To securely tie off a rope so that it can be quickly untied, especially a small boat to a dock or piling.

Comments ----

A secure knot that is easily tied or untied in wet or dry rope; when properly tied a non closing loop is formed, this allows the hitch to move up or down a piling as the water level changes.

Narration ----- (For Mooring Hitch Knotboard.)

(1) Take a bight around an object. (2) Form an underhand loop in the running part. (3) Place the eye of the underhand loop over the standing part. (4) Pull a bight of the standing part through the eye of the underhand loop. (5) Pull the underhand loop tight around the bight. (6) Place the running part under the eye of the bight that was pulled through the underhand loop. (7) Pull a bight of the running part through the eye of the standing part bight. (8) Pull on

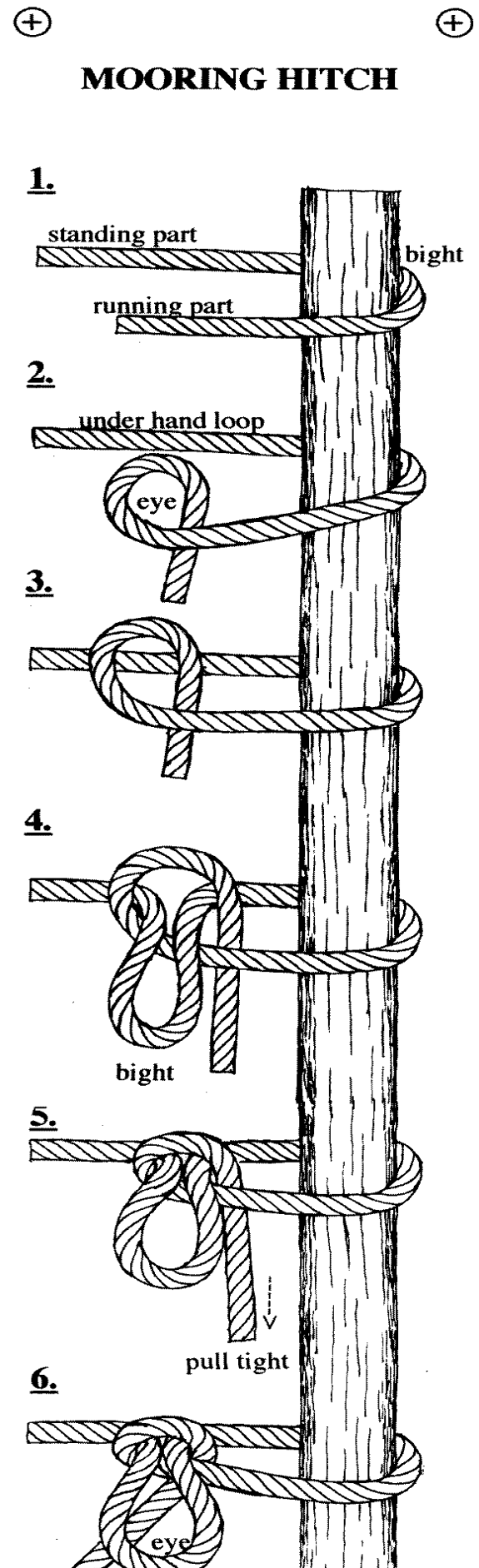

the standing part to tighten the standing part bight around the running part bight.

ANIMATED KNOT



MOORING HITCH

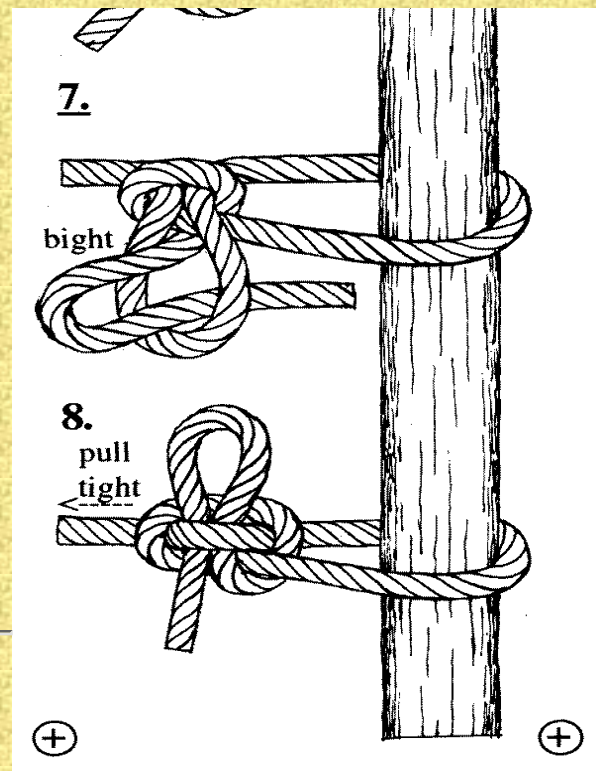

KNOTBOARD OF THE MONTH

ARCHIVE



Home
E-Mail



Home ARCHIVE

KNOTBOARD OF THE MONTH

Each month there will be new knotboard and descriptive text displayed on this page.

THIS MONTH'S IS THE :

JUG KNOT:

Use ----

- to provide a convenient carrying handle for jug or bottle ---- to attach a tool, such as a hammer to a security line to prevent accidental dropping --- to add a wrist loop to a walking staff --- to attach a safety line to a canoe paddle use your imagination, but be sure that you keep safety in mind.

Other Names ----

Jar knot, moonshiner's knot, hackamore, bridle knot..

Comments ----

The most common use is to provide a loop handle attached to the neck of a bottle. The loop handle makes it easy to carry several bottles with one hand. If a toggle or a two strand button knot such as boatswain whistle knot is added to the free end of the rope, The loop of the jug knot can be use to toggle the bottle to a belt so that the bottle can be use as a canteen.

Plastic bottles with screw-on lids such as soda, sport drink, and mineral water bottles make strong,

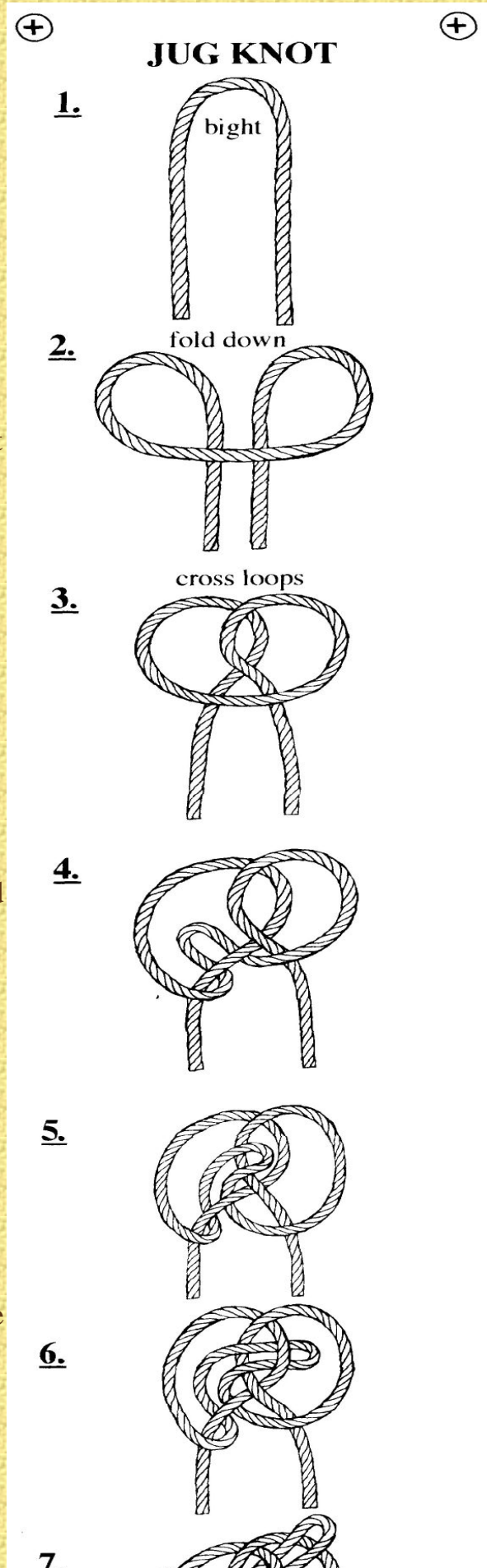

lightweight containers for carrying water on hikes and camp outs. 2 and 3 liter soda bottles are large enough to use as water containers around the camp kitchen. Smaller bottles (8 to 16 oz.) can be used as personal water bottles or canteens. These bottles can be made even more convenient by using a jug knot to attach a loop handle.

To help keep your water cool and refreshing in hot weather, place a sock over the bottle, wet the sock when you fill the bottle, evaporation will do the rest.

In cold weather, carry your water bottle under your coat. A dry sock placed over the bottle will help keep the water from freezing. In cold weather, carry your water bottle under your coat. A dry sock placed over the bottle will help keep the water from freezing.

In cold weather, carry your water bottle under your coat. A dry sock placed over the bottle will help keep the water from freezing.

Narration ----- (For Jug Knot Knotboard.)

Narrative ---- (For jug knot knotboard) (1) Form a bight in the middle of a 24 to 30 inch long by 3/16 inch diameter rope. (2) Fold the bight down over the standing ends to form two loops. (3) Place the right loop over the side of the left loop. (4) Weave the middle of the bight under the standing end; then over the left edge of the right loop; (6) next go under the right edge of the left loop; (7) finally pass the bight over the right side of the left loop. (8) Turn the tops of the original loops down over the knot. (9) Place the knot over the neck of a bottle and work the knot tight so that the bight forms a 4 to 5 inch loop handle and the loose ends are even.

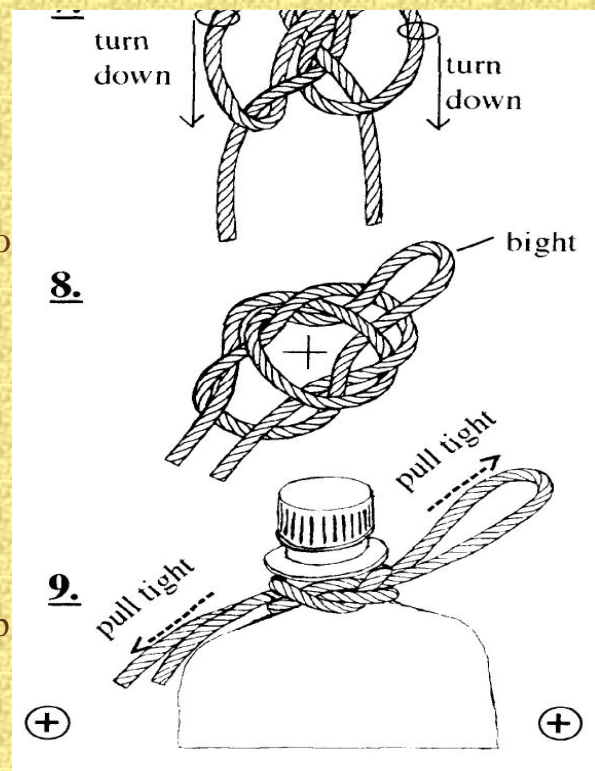

KNOTBOARD OF THE MONTH

ARCHIVE



Home
E-Mail



Home ARCHIVE

KNOTBOARD OF THE MONTH

Each month there will be new knotboard and descriptive text displayed on this page.

THIS MONTH'S IS THE :

BELAYING TO A CLEAT:

Use ----

To secure a flag lanyard, to moor a boat to a dock.

Comments ----

Belaying to a cleat is a fast non-jamming method of securing a rope anywhere along its length without reeving any part of the rope through or around anything.

Narration ----- (For Belaying to a CleatKnotboard.)

(1) Take a turn around the cleat and pull the line tight. (2) Complete a round turn around the cleat . (3) Place the line across the cleat. (4) Take a bight around one horn of the cleat. (5) Place the line across the cleat a second time. (6) Take a bight around the other horn of the cleat to form a figure eight around the horns of the cleat. (7) Repeat steps 3 through 6. (8) Form an underhand loop. (9) Place the eye of the underhand loop over the horn of the cleat. (10) Pull the underhand loop tight to form a half hitch around the horn of the cleat, this locks the rope in place.

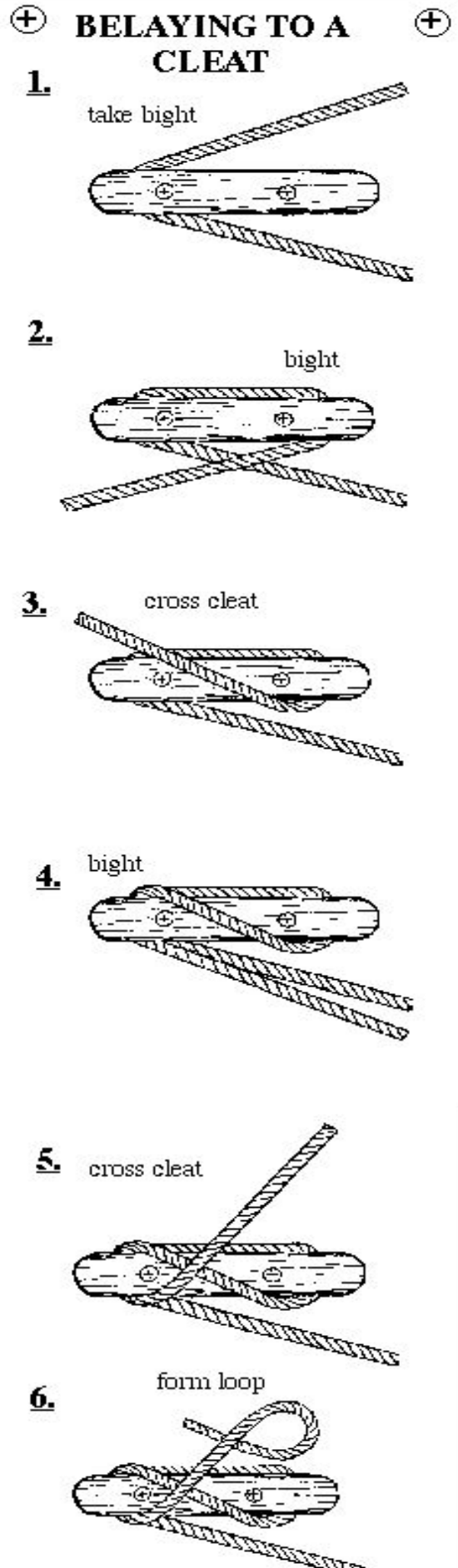

ANIMATED KNOT



BELAYING TO A CLEAT

KNOTBOARD OF THE MONTH

ARCHIVE

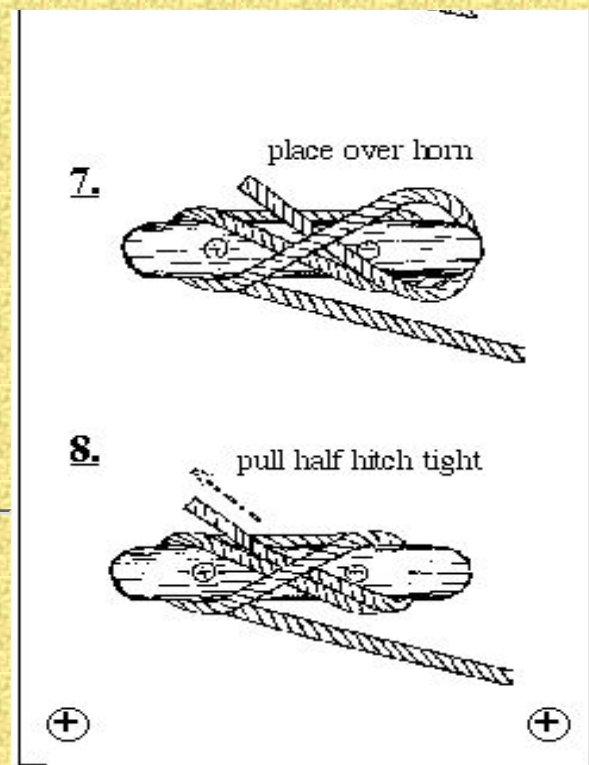

Home
E-Mail



Home ARCHIVE

KNOTBOARD OF THE MONTH

Each month there will be new knotboard and descriptive text displayed on this page.

THIS MONTH'S IS THE :

WHIPPING:

Description ----

Twine wrapped and secured to the end of a rope.

Use ----

To prevent the fraying of the end of a rope.

Comments ----

Even though "whipping" is done in several different ways, the finished "whippings" have similar appearance: the ends are secured under the turns, the length of the whipping is equal to the diameter of the rope, and all turns are parallel. Synthetic rope, rope made of plastic, should be whipped and fused to prevent the rope from fraying. Fusing helps to hold the whipping in place and the whipping helps to prevent the fused rope strands from braking apart.

Narration ----- (For Whipping Knotboard.)

(1) Take a turn around the cleat and pull the line tight. (2) Complete a round turn around the cleat. (3) Place the line across the cleat. (4) Take a bight around one horn of the cleat. (5) Place the line across the cleat a second time. (6) Take a bight around the other horn of the cleat to form a figure eight around

+

WHIPPING

+

1. (12 inch twine)

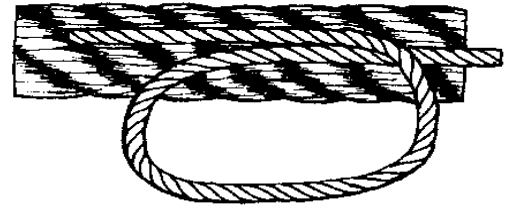

2.

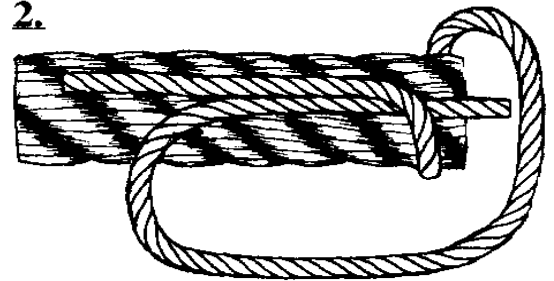

3.

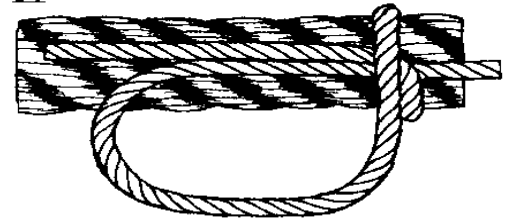

4.

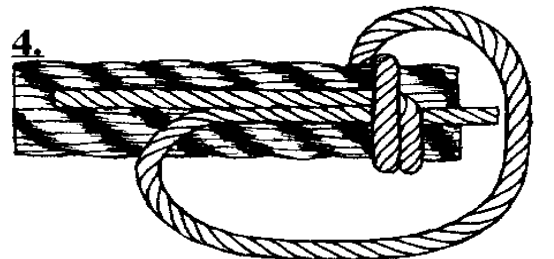

5.

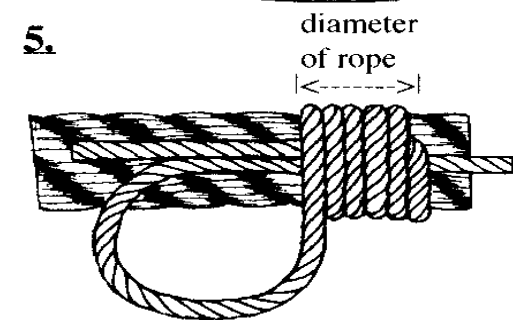

6.



the horns of the cleat. (7) Repeat steps 3 through 6. (8) Form an underhand loop. (9) Place the eye of the underhand loop over the horn of the cleat. (10) Pull the underhand loop tight to form a half hitch around the horn of the cleat, this locks the rope in place.

KNOTBOARD OF THE MONTH

ARCHIVE

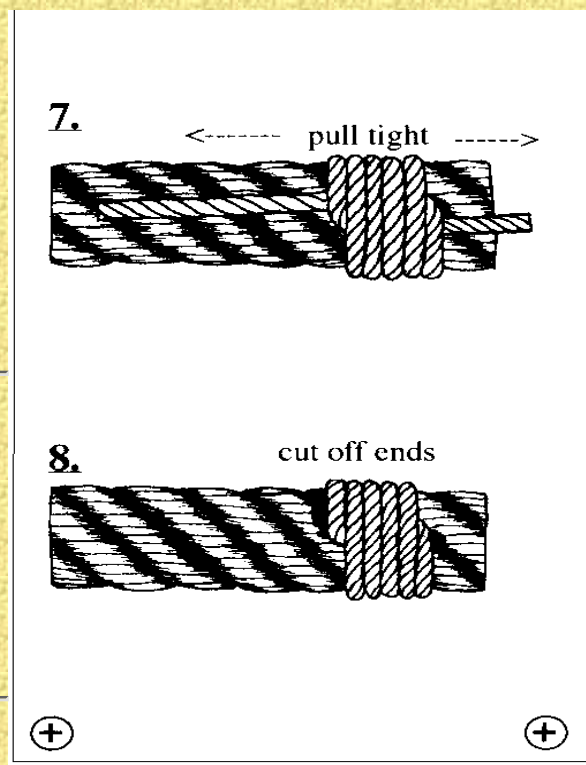

Home
E-Mail



Home ARCHIVE

KNOTBOARD OF THE MONTH

Each month there will be new knotboard and descriptive text displayed on this page.

THIS MONTH'S IS THE :

FIGURE-EIGHT KNOT:

Description ----

Interlocking overhand loops, the running part goes through the eye of one loop and the standing part goes through the eye of the other loop.

Use ----

- (1) As a stopper knot; to keep a rope from unreeving from a pulley block; to prevent a rope from unlaying.
- (2) When tied on a bight, makes a reliable loop for rescue work and mountaineering.

Comments ----

Easier to tie and untie than an overhand knot; does not damage the rope fiber or jam like an overhand knot.

Narration ----- (For Figure-eight Knotboard.)

- (1) Form an overhand loop. (2) Take a bight around the standing part. (3) Form the second overhand loop by bring the running part over the top edge of the first overhand loop. (4) Complete the knot by reeving the running part through the eye of the first overhand loop (5) and pull tight.

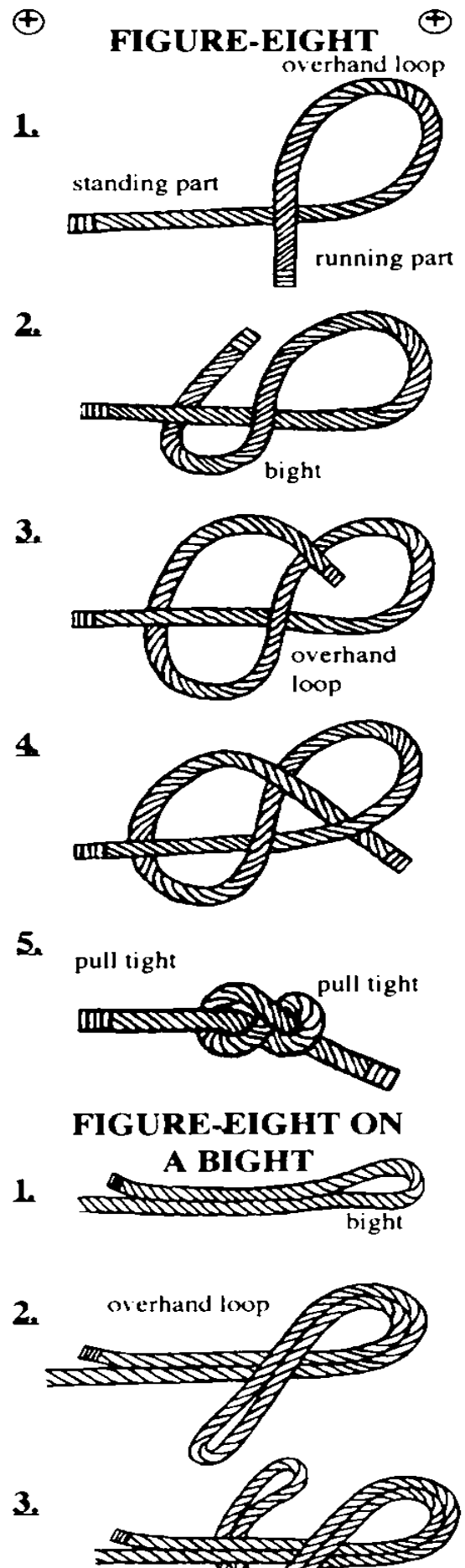

FIGURE-EIGHT ON A BIGHT:

Description ----

Interlocking overhand loops tied on a bight in the running part (the bight is used as the running part); the running part goes through the eye of one loop and the standing part goes through the eye of the other loop.

Use ----

(1) Makes a reliable loop for rescue work and mountaineering. (2) As a stopper knot; to keep a rope from unreeving from a pulley block; to prevent a rope from unlaying.

Comments ----

Easier to tie and untie than an overhand knot; does not damage the rope fiber or jam like an overhand knot on a bight.

Narration ----- (For Figure-eight on a Bight Knotboard.)

(1) Form a bight in the rope. [NOTE] Treat the two strands of the bight as a single strand as the rest of the knot is tied. (2) Form an overhand loop. (3) Take a bight around the standing part. (4) Form the second overhand loop by bring the running part over the top edge of the first overhand loop. (5) Complete the knot by reeving the running part through the eye of the first overhand loop (6) and pull tight.

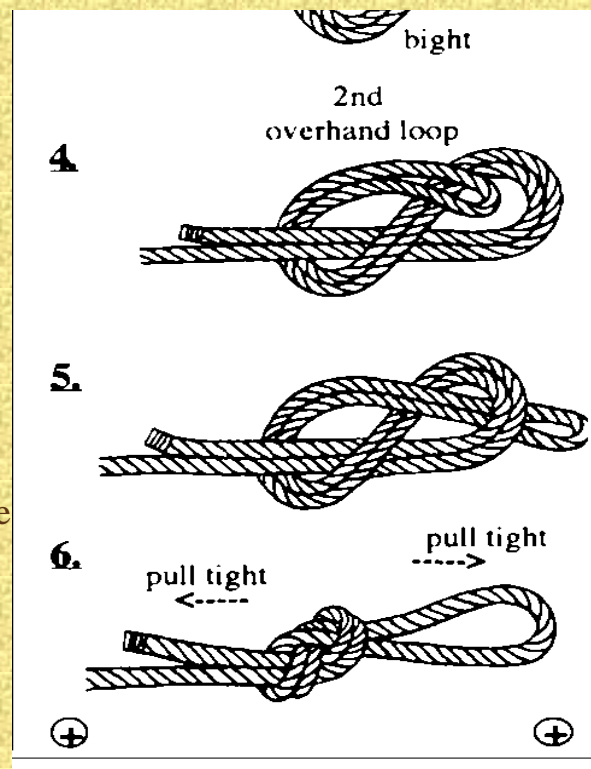

ANIMATED KNOT



BELAYING TO A CLEAT

KNOTBOARD OF THE MONTH

ARCHIVE



Home
E-Mail



Home ARCHIVE

KNOTBOARD OF THE MONTH

Each month there will be new knotboard and descriptive text displayed on this page.

THIS MONTH'S IS THE :

TRIPOD LASHING:

Description ----

A shear lashing around 3 poles.

Use ----

To bind three poles together, for the construction of a tripod. ---- To bind three poles together that contact at the same point in a structure

Comments ----

The tripod lashing is a shear lashing that binds three poles together at the same point. ---- The tripod lashing gets its name from the fact that its most common use is the construction of a tripod. ---- The tripod lashing can be used just about anywhere in a structure that three poles cross each other at the same point and the same time in the sequence of construction. ---- Tripod lashing takes two main forms; with racked wrapping turns (the rope is woven between the poles) and with plain wrapping turns (the rope is wrapped around the poles without weaving the rope between the poles). When the lashing is made with racked turns the rope contacts each pole around its entire circumference ; this

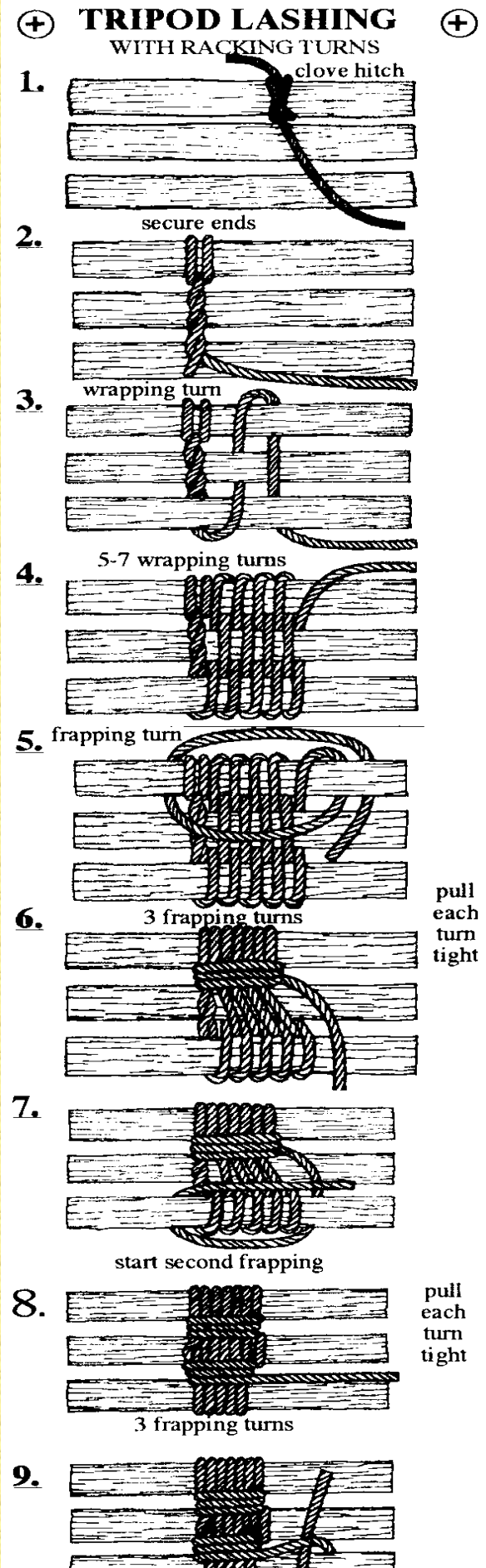

contact makes the tripod lashing with racking turns the most secure form of tripod lashing: therefore tripod lashing with racking turns should be used when safety is important. However, for light structures where there would be no danger if the lashing slipped, the faster to tie tripod lashing with plain wrapping turns may be used.

Laying Out The Poles ----

For most tripod lashings, lay the pole side by side with the butt ends aligned. The alignment of the butts of the pole insures that the tripod legs are the desired length.

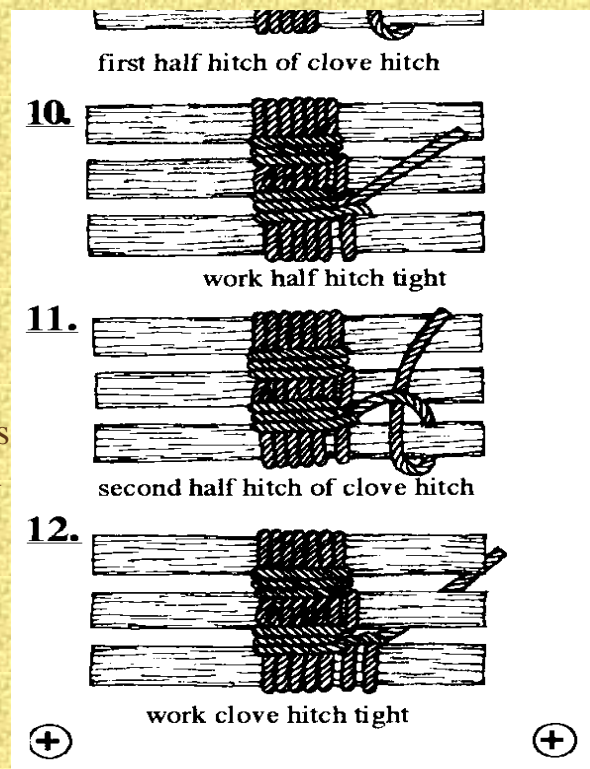
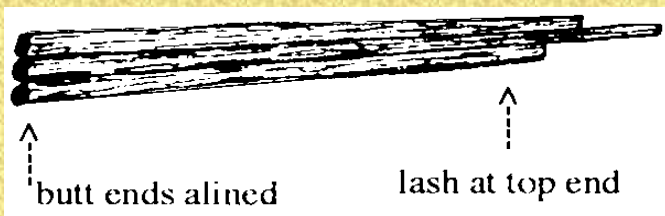

[NOTE]

The practice of laying the center pole in the opposite direction to the outside poles creates several problems. When the poles are laid in opposite directions the wrappings must be put on loosely so that when the center pole is rotated to its proper position the lashing is tightened around the poles. If the wrappings are put on too tight, the rope is stretched causing damage to the rope fibers, therefore weakening the lashing. On the other hand, if the rope is wrapped too loosely, the lashing will not tighten enough when the center pole is rotated and the lashing will be able to slip along the length of the pole. Either way, the rope too loose or the rope too tight, a dangerous situation is created.

Setting Up A Tripod -----

Set up the tripod by crossing the outside poles so that the cross point of the poles is under the center pole. Crossing the outside poles under the center pole causes part of the load that is placed on the tripod to be taken up by the wood to wood contact of the poles.

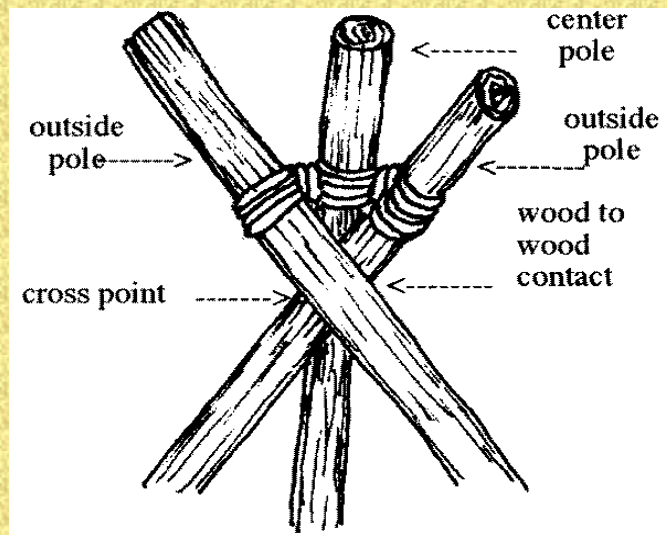

Narration ----- (For Tripod Lashing Knotboard.)

(1) Tie a clove hitch around one of the outside poles. (2) Secure the standing part by wrapping it around the running part. [NOTE] Wrapping the standing part around the running part prevents the clove hitch from slipping around the pole. If the clove hitch slips the lashing will loosen up from the inside. (3) Start the racked wrapping turns by weaving the rope between the poles. (4) Take a total of 5 to 7 wrapping turns. Pull each wrapping turn tight as it is made. [NOTE] The stiffness of the tripod lashing depends on the number and tightness of the wrapping turns. As the tightness of the wrapping turns or the number of wrapping turns increases, the stiffness of the tripod will increase. (5) Take the first frapping turn by taking the rope around the pole that the clove hitch was tied to, then between the outside pole and the center pole. (6) Take 3 frapping turns. Pull each frapping turn tight as it is made. (7) Start the second set of frapping turns by taking the rope across the center pole and reeving it between the second outside pole and the center pole. Take the second set of frapping turns in the opposite direction to the first set of frapping turns. [NOTE] Taking the second set of frapping turns in the opposite direction to the first set of frapping turns prevents the rope from crossing the wrappings at a diagonal. Unnecessary crossing of the rope increases friction between the strands of the rope making it difficult to tighten the lashing properly. (8) Take a total of 3 frapping turns. Pull each turn tight. (9) Take the first half hitch of the ending clove hitch around the second outside pole by taking the rope past the pole and then around the pole. (10) Work the half hitch tight so that it is locked against the lashing. [NOTE] See the narration for square lashing for instructions on working the half hitch tight. (11) Take the second half hitch of the ending clove hitch. (12) Work the half hitch tight to complete the ending clove hitch. [NOTE] If the clove hitch is not worked tight so that it is locked against the lashing the clove hitch will slip around the pole allowing the lashing to loosen. [NOTE] If very smooth rope is being used, a 3rd half hitch should be added to the clove hitch to insure that the lashing will stay in place.

KNOTBOARD OF THE MONTH

ARCHIVE



Home
E-Mail



Home ARCHIVE

KNOTBOARD OF THE MONTH

Each month there will be new knotboard and descriptive text displayed on this page.

THIS MONTH'S IS THE :

SHEET BEND:

Description ----

An interlocked bight and half hitch.

Use ----

To temporarily join two ropes, especially if the ropes are of different sizes.

Comments ----

The sheet bend is a secure but easily untied knot. ----
When tying the sheet bend the running parts should be left long because there is some initial slip in the knot when the knot is first brought under tension. ----
The proper and more secure way to tie the sheet bend is so that the two end the rope are on the same side of the knot.

Other Names ----

Weavers knot

Related Knots ----

Bowline; becket hitch; these knots share the same form but are tied in a different way or have a different use.

Narrative ---- (For sheet bend knotboard.)

(1) Form a bight in the running part of the

+

SHEET BEND

+

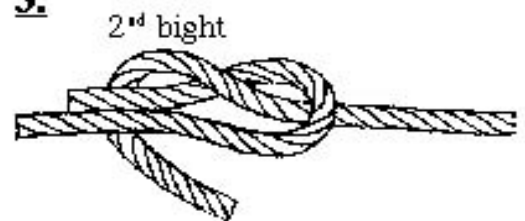
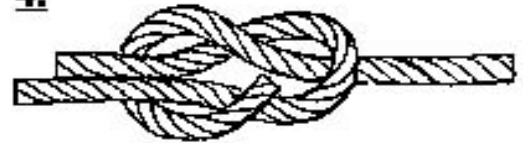
1.**2.****3.****4.****5.****6.**

left-hand rope. (2) Reeve the running part of the right-hand rope through the eye of the bight in the left-hand rope. (3) With the right-hand running part take a bight around the running part and the standing part of the left-hand rope. (4) Pass the right-hand running part over the left-hand standing part, (5) under the right-hand rope, and (6) over the standing part of the left-hand rope. (7) Pull tight.

ANNIMATED KNOT



SHEET BEND

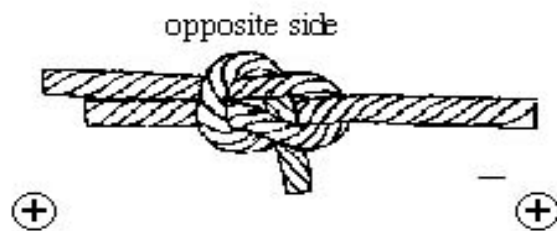

KNOTBOARD OF THE MONTH

ARCHIVE



Home
E-Mail



Home ARCHIVE

KNOTBOARD OF THE MONTH

Each month there will be new knotboard and descriptive text displayed on this page.

THIS MONTH'S IS THE :

MASTHEAD KNOT:

Description ----

A multiple loop knot formed by reeving the loosely made loops of two over hand knots through each other and then securing the knot to a mast (pole).

Use ----

On board ship, a masthead knot was used to rig a temporary mast if the mast was lost in battle or during a storm. On land a masthead knot can be used to rig a gin pole or a flag pole.

Comments ----

There are several forms of the Masthead Knot. This form of the Masthead Knot was chosen for its symmetry and the ease of transition to the running half hitches used to secure it to the pole.

Other Names ----

Jury mast knot, pitcher knot.

Narrative ---- (For masthead knot knotboard.)

(1) Loosely tie two over hand knots. (2) Place the loop of one overhand knot on top of the loop of the loop of the other over hand knot. (3&4) Reeve the

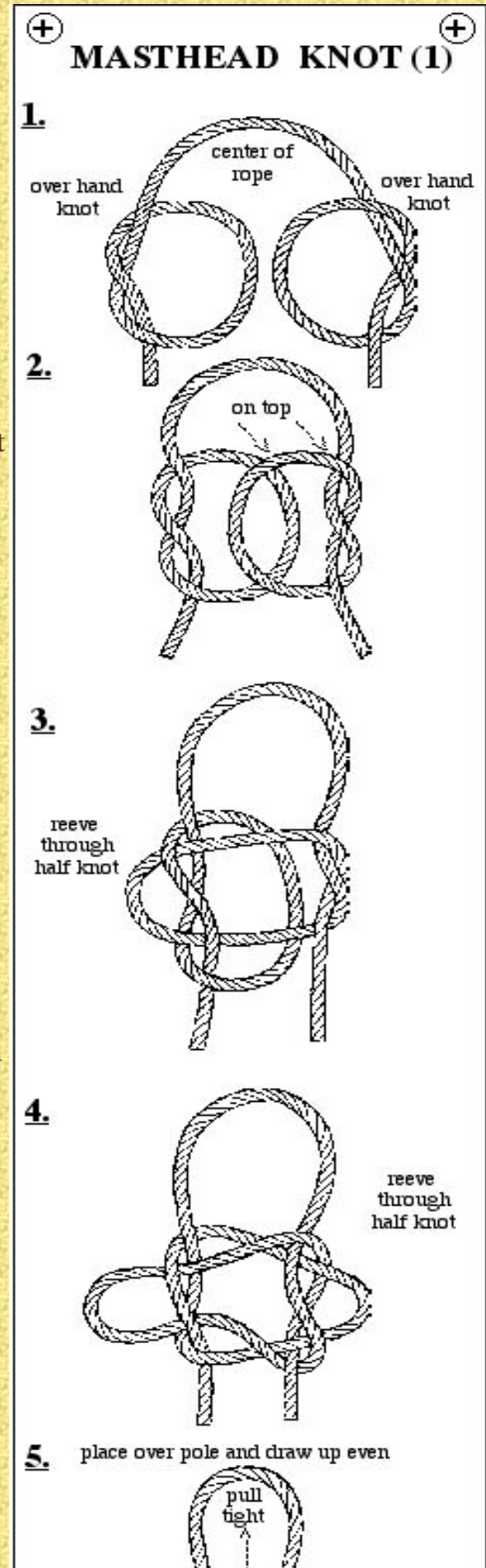

loops of the overhand knot through the half knot part of the opposite overhand knot. (5) Place over a pole and draw the three loops up even. (6) Secure to the pole with a series of running half hitches above and below the mast head knot.

[NOTE]

A fourth loop may be formed by tying or splicing the ends together. If a fourth loop is made, nail a cleat to the pole to prevent the mast head knot from slipping.

[NOTE]

Attach the guy lines to the loops with becket hitches.

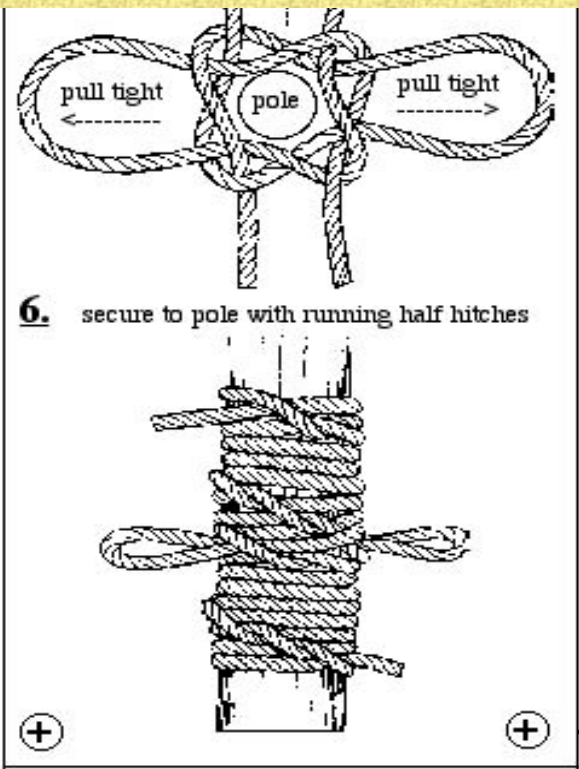
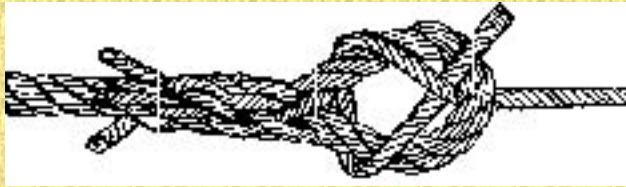

KNOTBOARD OF THE MONTH
ARCHIVE



Home
E-Mail

KNOTBOARD OF THE MONTH

Each month there will be new knotboard and descriptive text displayed on this page.

THIS MONTH'S IS THE :

FLOOR LASHING:

Use ----

to lash a series of poles to a set of stringers to form a flat surface such as a deck, a table top, or a road way.

Comments ----

When using a floor lashing, both ends of the decking poles must be lashed at the same time to insure a firm even surface.

When placing the decking poles on the stringers, lay the decking poles so that their butt end are in alternating direction. Alternating the butt ends of the decking poles will compensate for the natural taper of the poles so that the length of the decking along each stringer will be equal.

Narrative ---- (For floor lashing knotboard)

(1) Tie a clove hitch around each stringer. (2) Secure the short end of the rope by wrapping it around the running end (wrap with the lay of the rope). (3) Place the decking poles on the stringers and take a bight around the first pole. (4) Next, on the inside of the stringer, pull a bight up between the first decking pole and the next decking pole. (5) Place the eye of

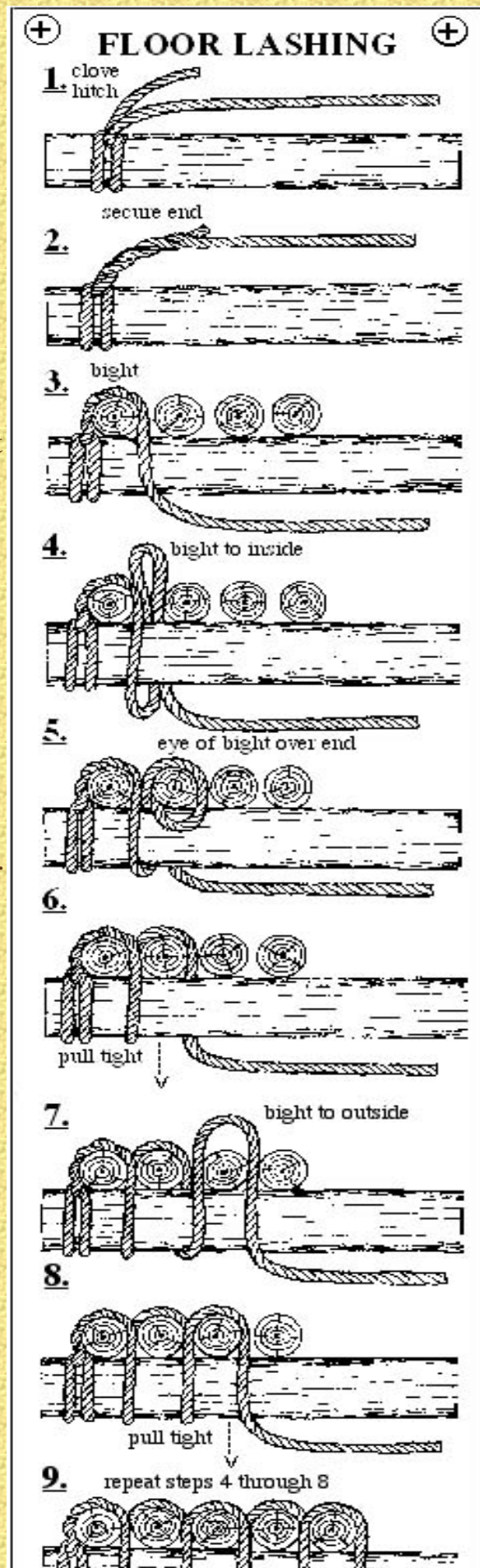

the bight over the end of the decking pole. (6) Pull tight. (7) On the outside of the stringer, place a bight over the next decking pole. (8) Pull tight. (9) Repeat steps 4 through 8 until all decking poles are lashed in place. (10) Tie the first half hitch of the ending clove hitch. Work half hitch tight. (11) Tie the second half hitch of the ending clove hitch. Work half hitch tight (12) to form clove hitch.

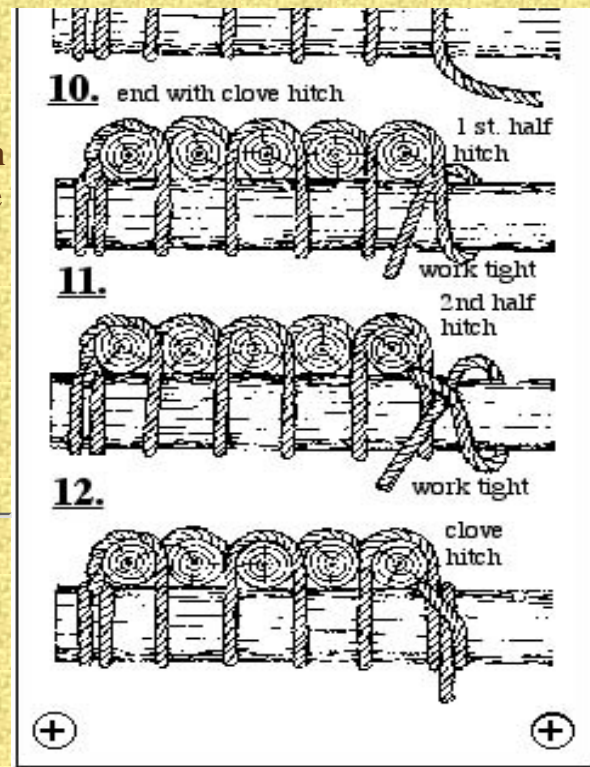

KNOTBOARD OF THE MONTH

ARCHIVE



Home
E-Mail

ARTICLE OF THE MONTH

Each month there will be article on this page.

THIS MONTH'S IS THE :

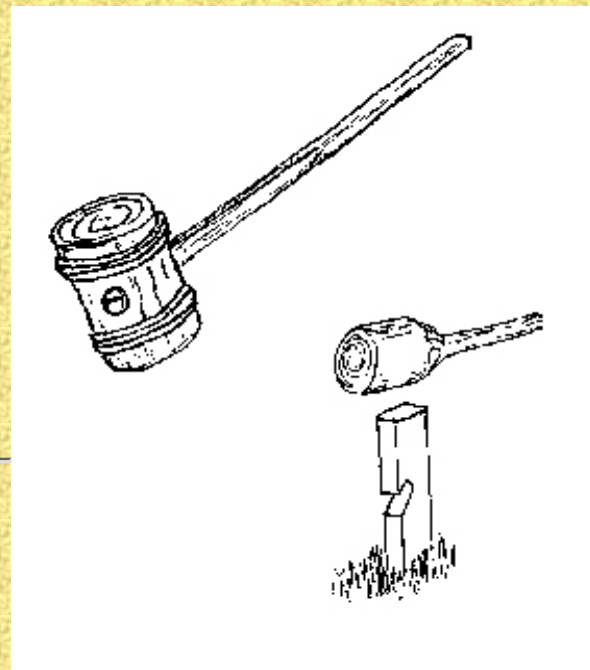

MAULS:

A maul is a wooden club or hammer that is used for driving stakes or wedges and for safety reasons should be used instead of an ax.

Using an ax instead of a maul exposes the user to the danger of being cut by its sharp edge. Even if the edge is covered by a sheath, a glancing blow can cause the sheath to be ripped off or to be cut through.

The pole of an ax serves as a counterweight to the blade. This counterweight adds to the balance of the ax head and helps to control and increase the force of momentum delivered to the bit. The ax head is shaped in such a way that the momentum of the ax head is delivered through the thin walls of the eye. However, when an ax is being used as a hammer, this same shape causes the eye of the ax head to spread and the handle to loosen.

The flat surface and angular edges of an ax pole makes it difficult to strike a stake squarely. This difficulty in striking a square blow results in most blows delivering some there force sideways, causing the end of the wooden stake to flare and split very quickly. In addition, when the pole of an ax contacts a stake, the metal surface of the pole lacks the ability absorb any of the force of the impact this contributes to the destruction of the stake. A wooden maul, on the other hand, absorbs some of the impact of the initial contact and a maul has no angular edges. Therefore, more of the force of the maul is used to do useful work and less of the force is used up in deforming or splitting the stake.

FOR MORE INFORMATION GO TO "MAULS"



"MAULS"

ARTICLE OF THE MONTH
ARCHIVE



Home
E-Mail



ARTICLE OF THE MONTH

Each month there will be an article on this page.

THIS MONTH'S IS THE :

FUSING:

Use ----

To prevent a rope from fraying.

Comments ----

The ends of a synthetic rope can be fused to prevent the rope from fraying. This is done by heating the end of the rope so that the ends of the rope fibers melt together.

The fusing can be done by holding the end of the rope to the side of a candle or other small flame. If the end of the rope is placed in the flame or held too close to the flame, the plastic will ignite causing the end of the rope to turn black. Burning plastic can also give off toxic fumes . If the end of the rope is held above the flame, unburned carbon particle will be deposited on the melted plastic causing it to turn black. A candle flame will generate enough heat to fuse the end of a rope up to about one inch in diameter. If the rope is larger than one inch, a propane torch will work better .

FOR MORE INFORMATION GO TO "FUSING"

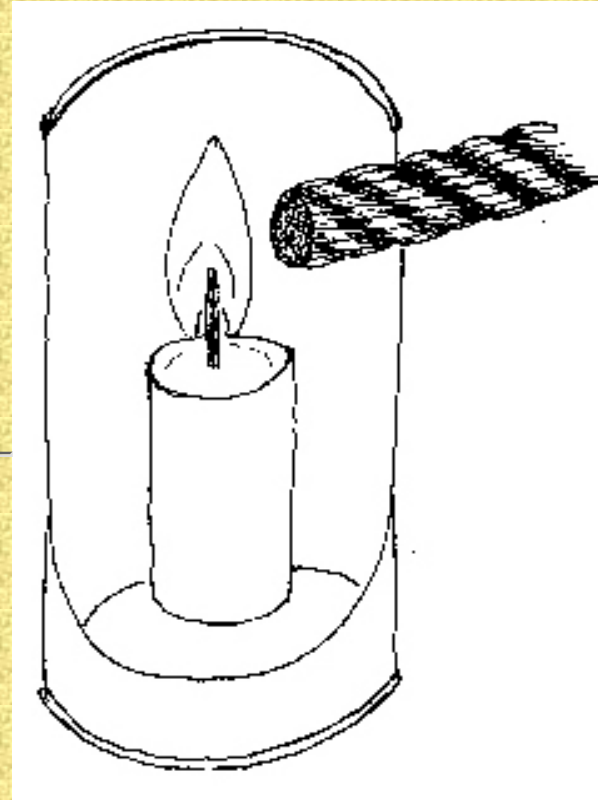

ARTICLE OF THE MONTH

ARCHIVE



Home
E-Mail

ARTICLE OF THE MONTH

Each month there will be article on this page.

THIS MONTH'S IS THE :

TAUT-LINE HITCH:

Description ----

Two half hitches with an extra turn.

Use ----

To adjust the tension on guy lines.

FOR MORE INFORMATION GO TO "TAUT-LINE"

ARTICLE OF THE MONTH ARCHIVE

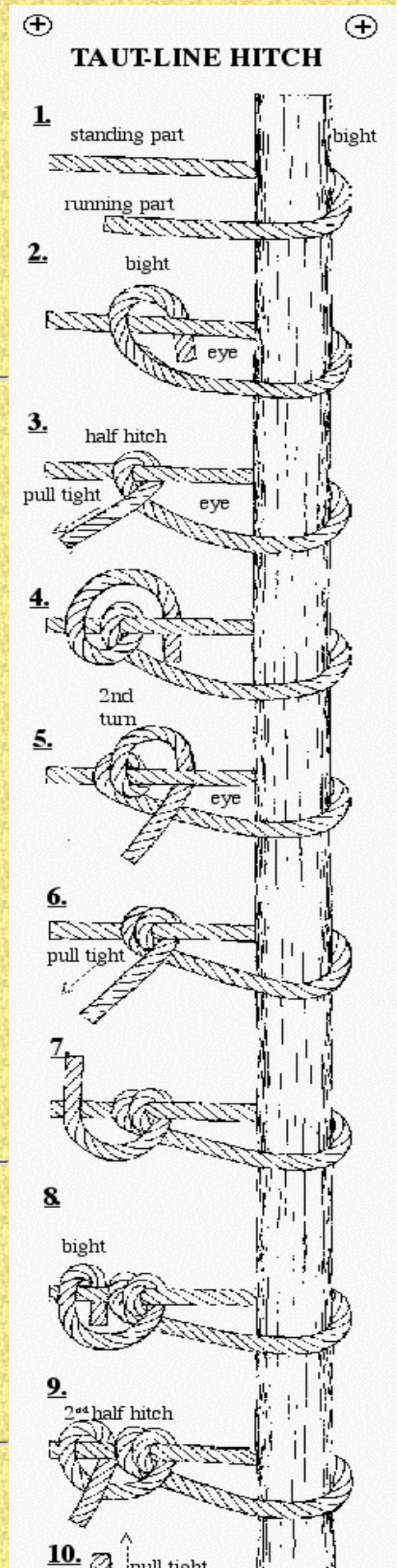



[Home](#)
[E-Mail](#)

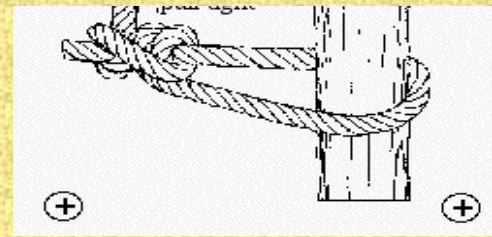



Home ARCHIVE

ARTICLE OF THE MONTH

Each month there will be new knotboard and descriptive text displayed on this page.

THIS MONTH'S IS THE :

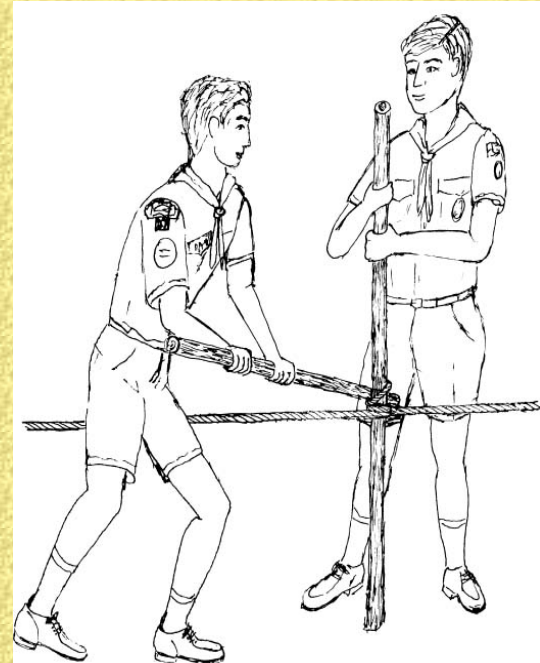

SPANISH WINDLESS:

Description ----

A Spanish windless is a device for moving heavy loads such as rocks and logs.

[WARNING]

When setting up a Spanish Windless do not use nylon or other synthetic fiber ropes that stretch under a load. If you slip or let go of the poles the energy you used to stretch the rope will be released as the rope returns to its original length. This release of energy could cause the poles of the windless to spin around causing injuries to any one near by. Natural fiber ropes, such as sisal, have little stretch; therefore are much safer to use.

MATERIALS:

- 1 - 8 foot * 3 inch pole
- 1 - 5 foot * 3 inch pole
- 1 - 3/4 inch * 50 foot (natural fiber)

SETUP:

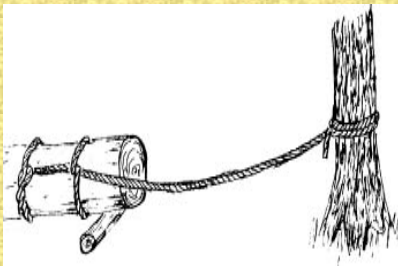

STEP 1:

Tie one end of the rope to the load and the other end to a secure anchor point. Leave some slack in the rope so that the windless can be rigged.

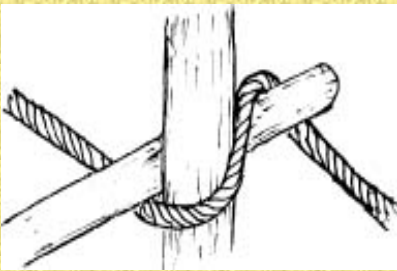

STEP 2:

Follow the diagrams to set up the poles at the mid point of the rope.

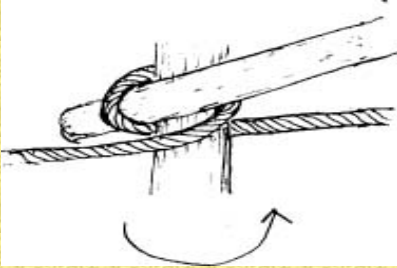

STEP 3:

While one person holds the up right pole, a second person rotates the longer pole around the upright so that the rope begins to wrap around the upright pole. Adjust the height of the rope so that it can be easily stepped over.

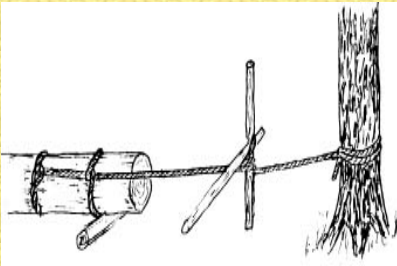

STEP 4:

Continue to rotate the longer pole around the upright.

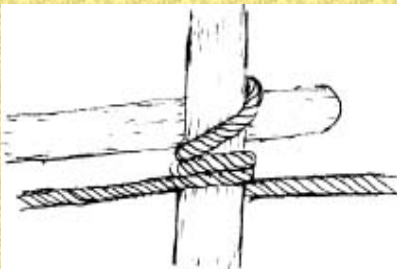

[NOTE]:

As the rope wraps around the upright it will be necessary to move the base of the upright to keep it vertical.

[NOTE]:

Be careful that the two ends of the rope are kept at the same level on the upright.

ARTICLE OF THE MONTH

ARCHIVE



Home
E-Mail



[Home](#)
[GUESTBOOK](#)
[E-Mail](#)

[GO TO ARCHIVE](#)

ARTICLE OF THE MONTH

Each month there will be new knotboard and descriptive text displayed on this page.

THIS MONTH'S IS THE :

ROPE HALTER

Start with an eye splice.

(The Eye splice will form one end of the nose piece of the halter)

Decide how long the nose piece must be then tie a quick eye into the rope.

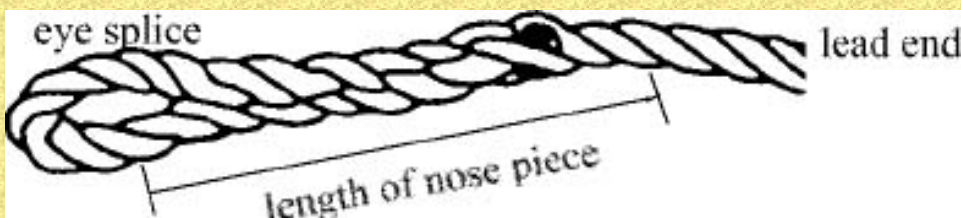

Quick Eye STEP1

Decide where the quick eye must be. Then reeve the lead end through the lay of the rope as shown. (Slightly larger than the diameter of the rope)

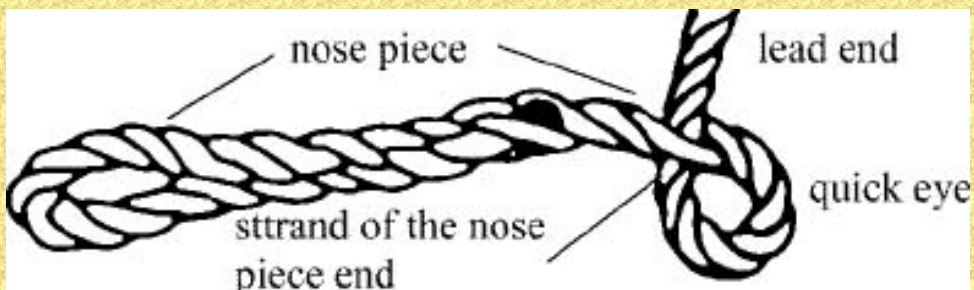

Quick Eye STEP 2

Observe which strand of the lead end is directly under the strand of the nose piece end. Reeve the eye splice under that strand.

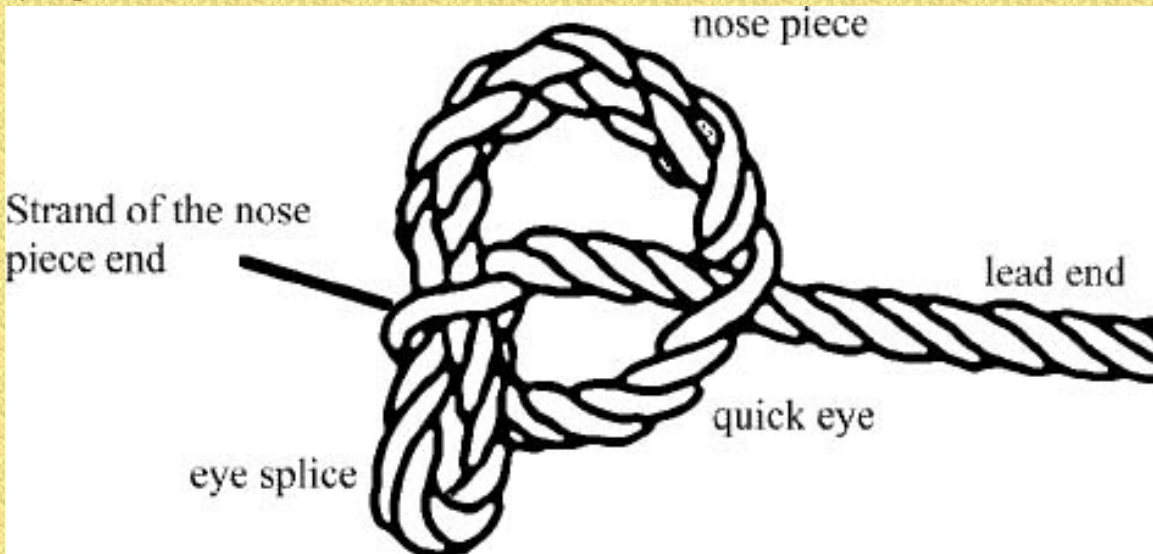

Quick Eye STEP 3

Work the eye into shape. (Do not just pull on the ends this will distort the eye.) When the eye is in shape, the strands of the rope should lay even showing little or no distortion.



Finnish the halter by reeving the lead end through the two eyes as shown.

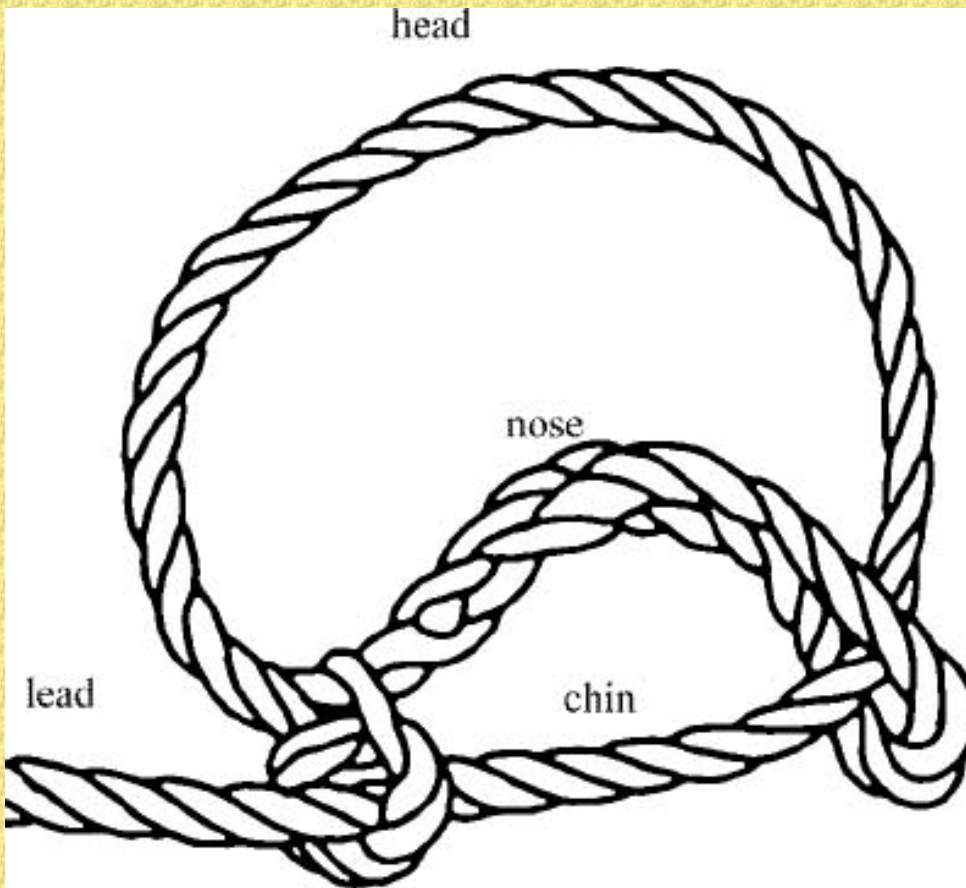

ARTICLE OF THE MONTH
ARCHIVE



Home

E-Mail

© 2000, Gerald L. Findley

LADDER LASHING:

Comments:

Ladder lashing allows for a quick and secure method for constructing a ladder or for constructing a decking with evenly spaced decking pieces.

This form of lashing has several advantages over the traditional floor lashing. Less material is required because unlike floor lashing a space can be left between each piece of the decking. Also, each rung is securely lashed in place by several loops of rope in much the same way as a square lashing; with the traditional floor lashing only a single loop of the rope holds each end of the decking in place, therefore if one piece loosens, the entire deck loosens.

The ladder lashing has two forms; left and right, each is a mirror image of the other.

START: The ladder lashing is started by using a clove hitch stopped with two half hitches to secure a rope to the top end of each rail.

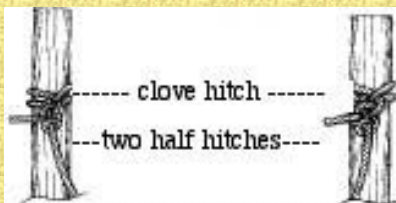

STEP 1: Lay an overhand loop over each side rail so that the running end of each loop is to the outside.

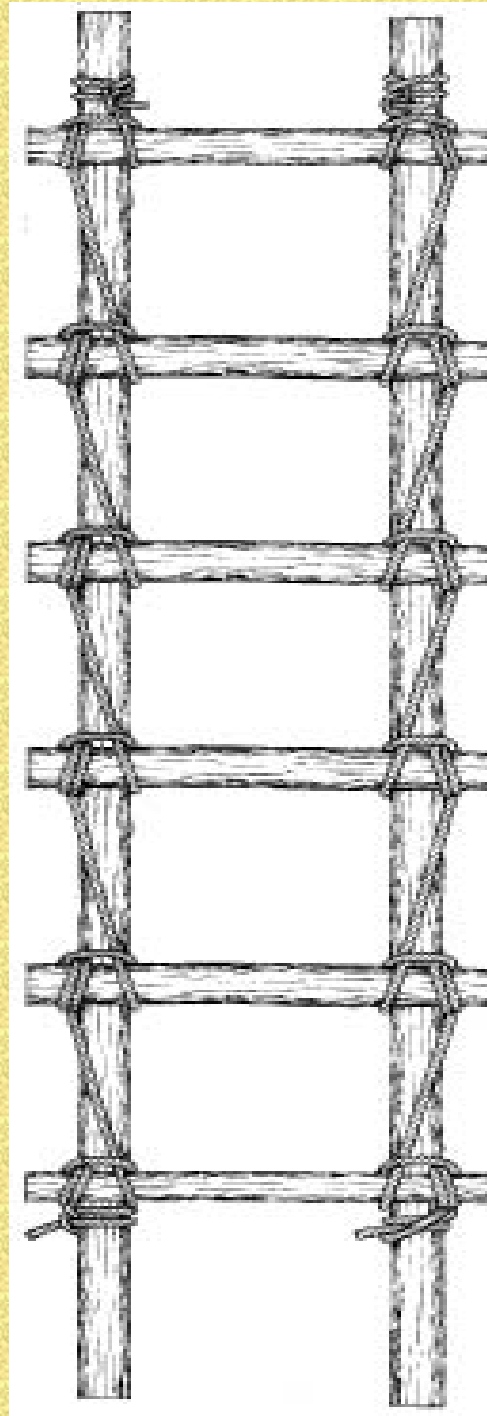

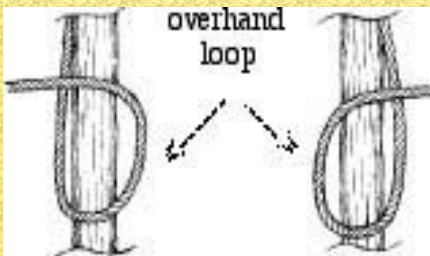

STEP 2: Place a rung across the rails so that the standing part of each overhand loop is over the end of the rung and the running part of each overhand loop is under the rung.

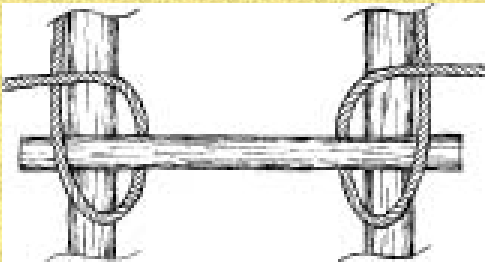

STEP 3: Pull the running part side of each overhand loop behind and to the outside of each rail.

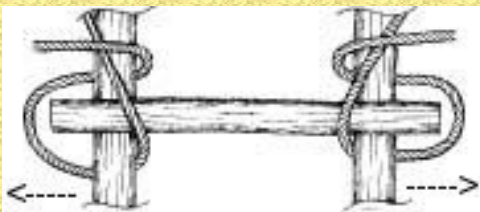

STEP 4: Then pull the loop over the end of the rung.

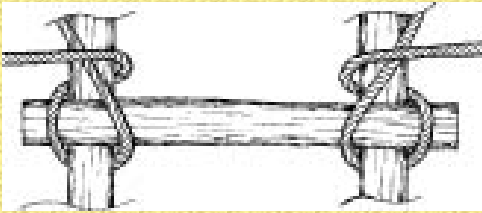

STEP 5: Work each rope until it is tightened around the rung and the rung is in its desired position.

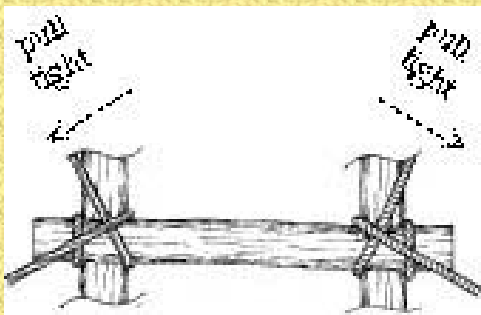

STEP 6: Form an overhand loop in each running part.

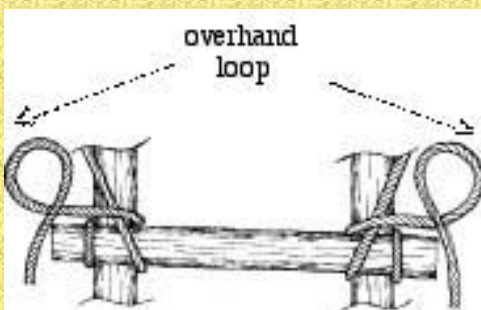

STEP 7: Place an overhand loop over each end of the rung to form a half hitch around each end of the rung.

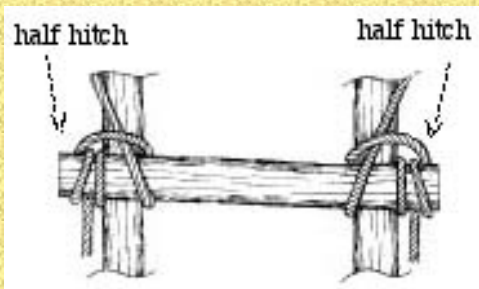

STEP 8: Work the half hitch tight.

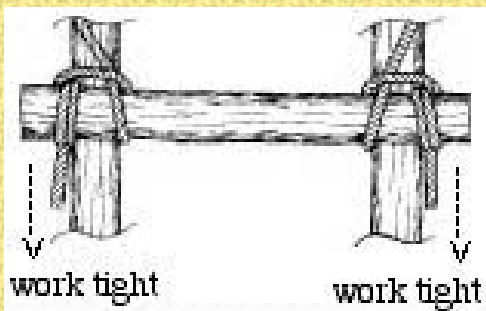

STEP 9: Repeat steps 1 through 8 for each additional rung.

END: Finish the lashing by tying a clove hitch around each rail so that the clove hitch is directly under the bottom rung.

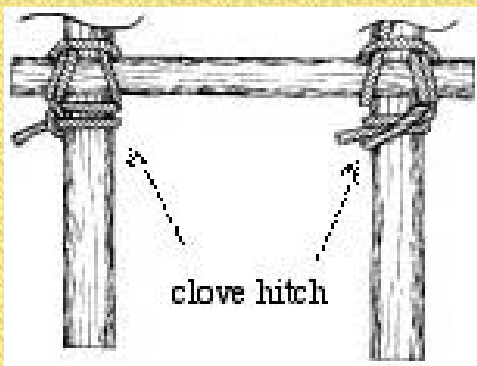

Quick Eye STEP 3

Work the eye into shape. (Do not just pull on the ends this will distort the eye.) When the eye is in shape, the strands of the rope should lay even showing little or no distortion.



Finnish the halter by reeving the lead end through the two eyes as shown.

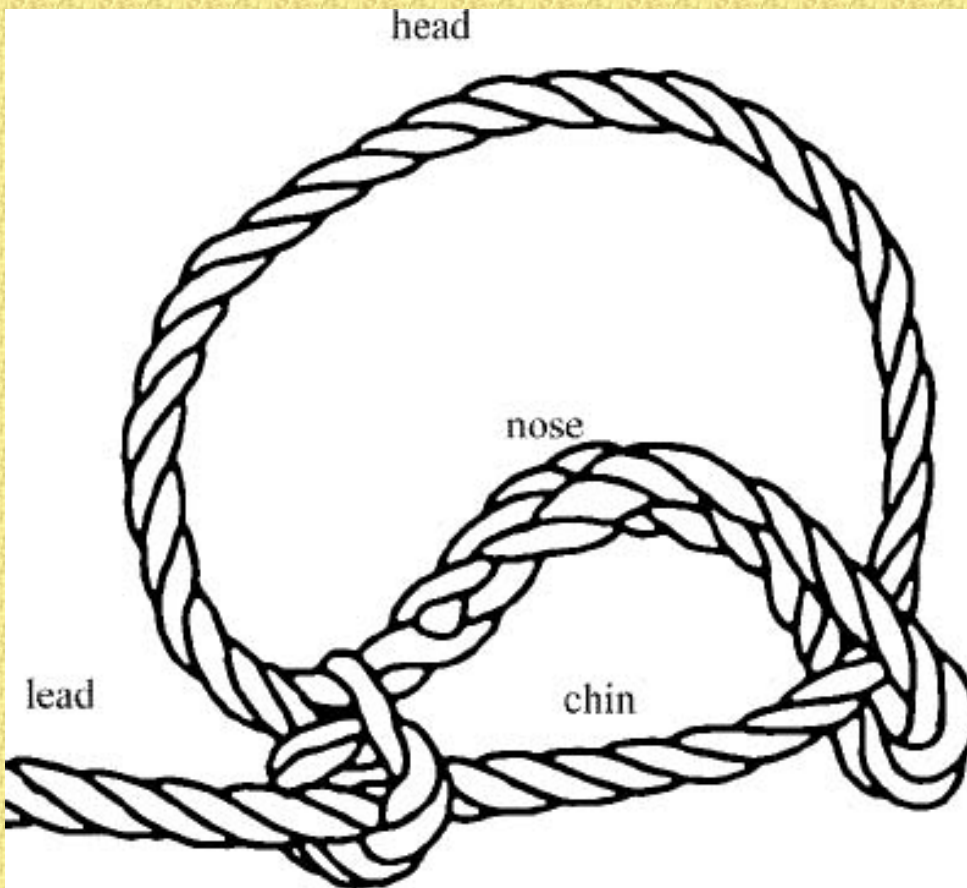

ARTICLE OF THE MONTH
ARCHIVE



Home

E-Mail

SEIZING:

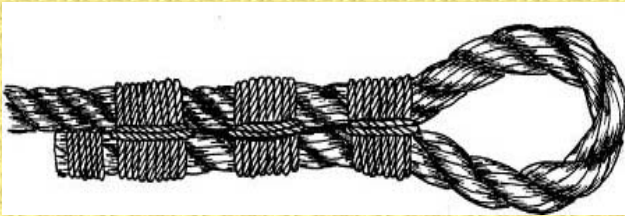

Use ---- To bind ropes together or to bind a rope to an object. Sometimes used to bind the running end of a rope to the standing end of the rope to prevent a knot from spilling.

Comments ---- Seizings do not use as much material and are not as bulky as a knot or a splice; nor does the seizing damage the fiber of the rope. The fibers of a rope do not need to be bent or separated to be seized as they do when a knot is being tied or a splice worked. If the seizing is no longer needed, the seizing can be cut away and the rope is undamaged.

The seizings shown here can be worked with out the use of a needle. However there are many forms of seizing that require the use of a needle to apply them to a rope.

To form an eye, 3 to 4 seizing should be used. This ensures that the eye will safely remain in place even if one of the seizings is damaged.

If there is additional strain on the ropes,

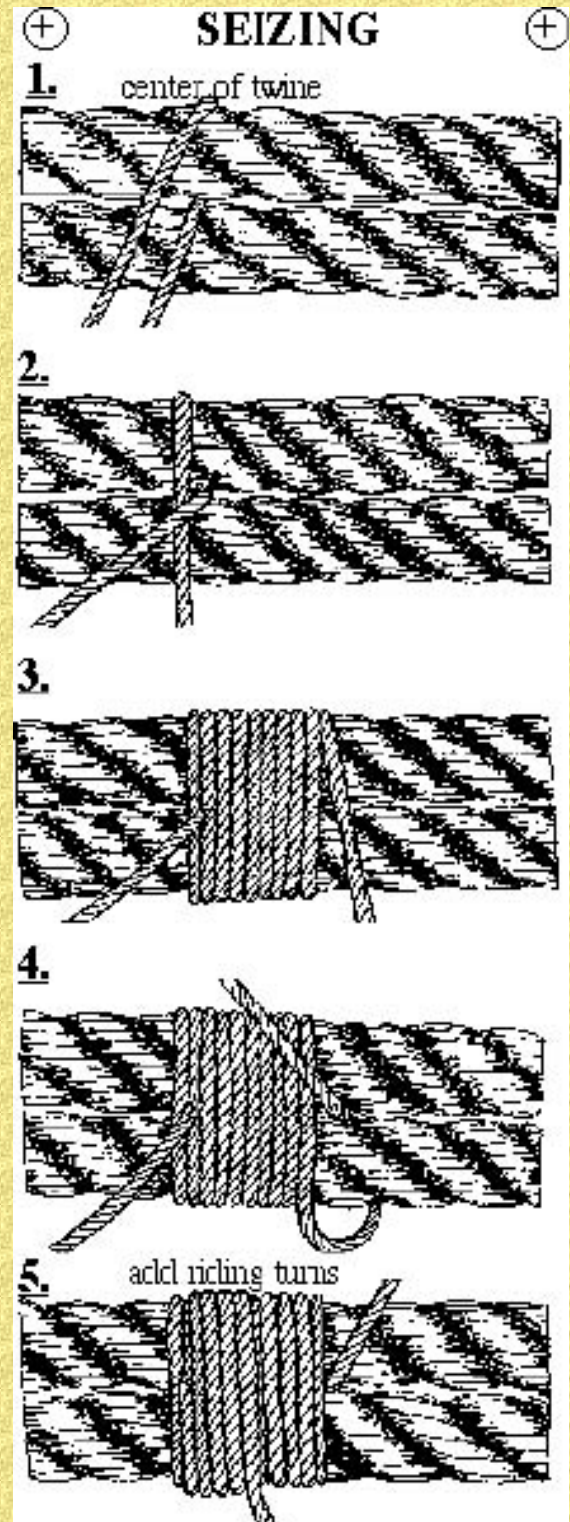

such as at the first seizing of an eye, racked turns should be used.

Materials ---- The diameter of the "twine" that is being used to do the seizing should be 1/8 to 1/12 the diameter of the rope being seized. The length of the "twine" should be about 3 feet for each 1 inch of diameter of the rope.

Narration ---- (For **seizing** knotboard.)

(1) Fold a piece of twine in half over one strand of the rope. (2) Start the first layer of wrapping turns by laying the end of the twine that is between

the ropes over the other end. (3) Wrap the outside strand around the ropes so that so that the wrapping turns are parallel to each other; pull each wrapping turn tight. (4) When the width of the wrapping is equal to the diameter of the rope, end the first layer of wrapping turns by reeving the twine between the ropes; pull tight. (5) Add a layer of riding turns; the riding turns are laid in the groove between the wrapping turns and pulled tight but not so tight as to separate the wrapping turns of the first layer. (6) When the riding turns have been completed, end the riding turns by reeving the end of the twine between the ropes so that it is in the opposite direction to the other end of the twine. (7) Add frapping turns; reeve the end of the twine between the ropes at the other end of the wrappings; pull tight. (8) Use a square knot to end the frapping turns: reeve the ends of the twine between the

ropes again; tie a half knot; pull the half knot and the frapping turns tight. (9) Reeve the ends of the twine between the ropes again; tie the second half knot of the square knot. (10) Pull the second half knot tight so that the square knot is between the strands of the rope. Cut off the ends of the twine.

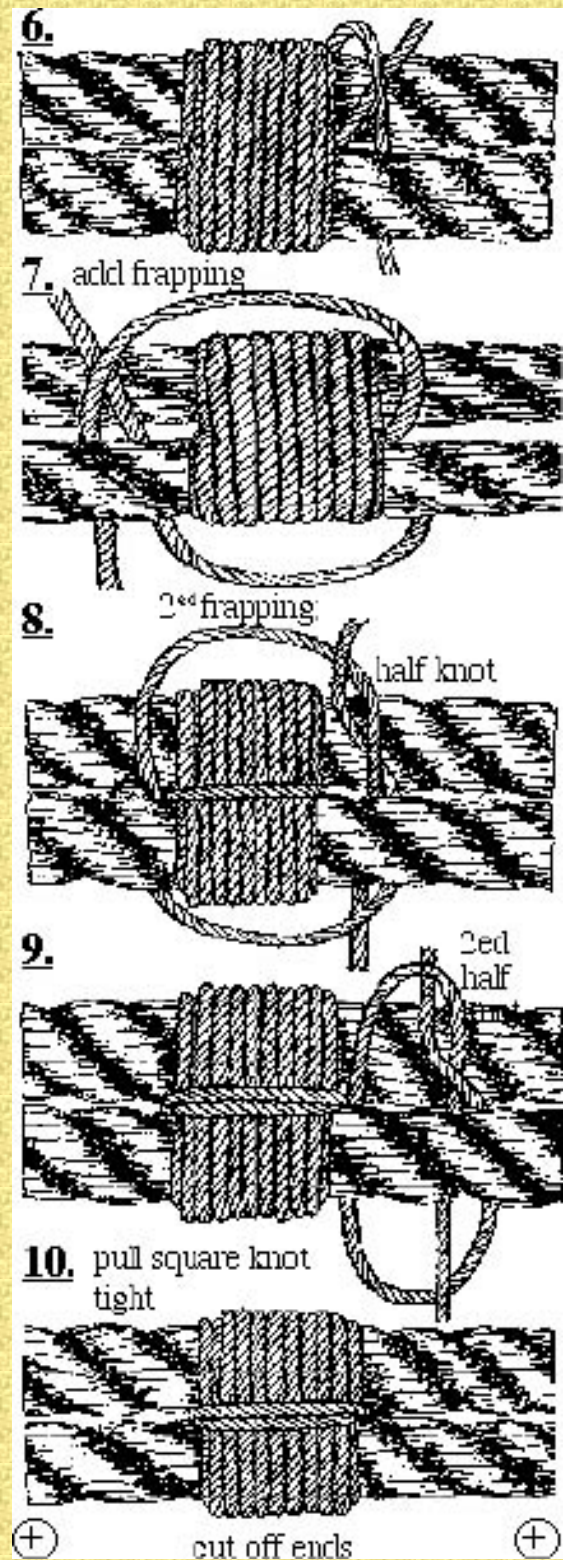

**For a printout of the above and additinal
information go to....**

<http://www.northnet.org/ropeworks/reader/seizing.pdf>

For printouts of previous articles go to ...

ARCHIVES.

ARTICLE OF THE MONTH

ARCHIVE



Home
E-Mail



FIDS:

A fid is a tool that is used to open the lay of a rope when working a splice or to loosen knots.

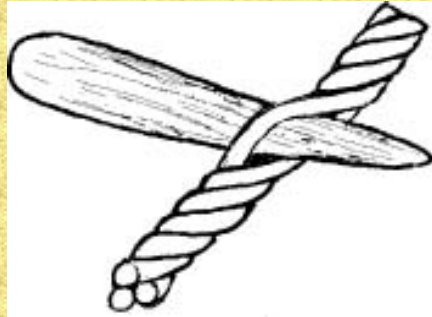

MAKING A WOODEN FID:

Split out an 8 inch by 3/4 inch piece of close grained, smooth, hardwood. Carve and smooth the piece to the shape shown in the diagram.



MAKING METAL FIDS:

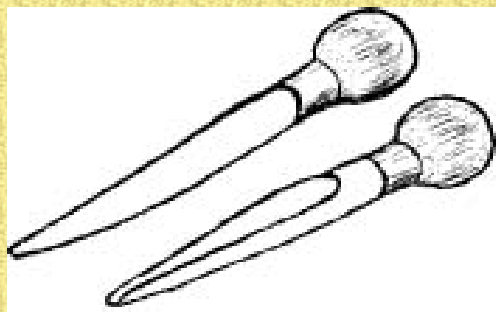

Materials:

1 --- 8 inch * 1/2 inch copper tubing or steel electrical conduit.

2 --- 1 inch diameter * 3 inch long piece of smooth grained hardwood.

2 --- 4D finishing nails.

Construction:

Cut the tubing diagonally into two pieces as shown in the diagram (Use a hacksaw).

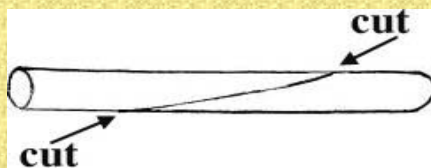

Making a Closed Fid:

STEP 1: Use a triangular file to enlarge the diagonal opening in one of the halves of the tubing. File the opening to the shape indicated by the dotted lines in the diagram.



STEP 2: Close the diagonal opening. Using light taps with a hammer gently roll the two edges toward each other to form the tubing into a cone. (When the two edges of the opening meet the seam in the tubing should be straight).



STEP 3: Solder the edges of the opening together.

3A] Clean the edges of the opening with steel wool.

3B] Spread soldering paste along the cleaned edges.

3C] Solder the seam. Use a propane torch to apply heat to the side of the fid that is opposite the seam. (Heating the tube from the opposite side, will ensure that metal is heated all the way through so that the solder will flow into the seam and not just spread out on the surface.) As you heat the tubing test the seam for the proper temperature by touching the solder to the seam. When the solder starts to melt and flow into the seam, move the solder along the seam until the entire seam is filled with solder.

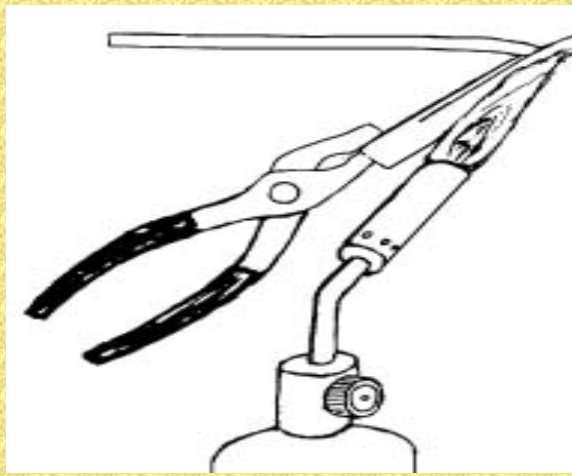

STEP 4: Cleanup the seam with steel-wool and a file. Make sure that there are no sharp edges to catch or cut the rope fibers when the fid is being used.

Making an Open Fid:

STEP 1: Enlarge the diagonal opening of the other piece of tubing by setting the tubing on end and forcing a rod into the opening. When the rod is forced into the opening, the cross section of the tubing should become "U" shaped.

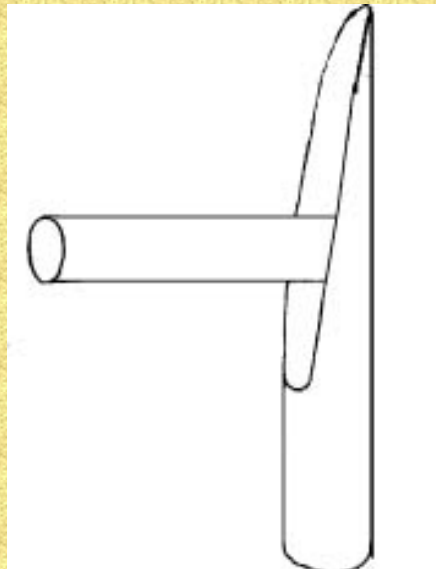

STEP 2: With a round file, enlarge the diagonal opening to the shape shown by the dotted line.

STEP 3: Smooth all rough and sharp edges with a file and steel-wool.

STEP 4: Gently tap the edges of the opening toward each other so that a cross section anywhere along its entire length will be "U" shaped.

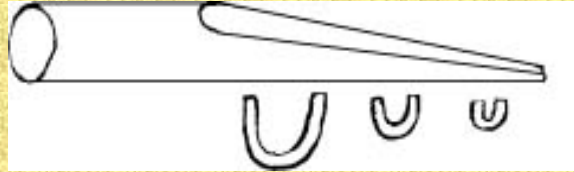

Making Handles For Fids:

STEP 1: Carve one end of a 1 inch diameter * 3 inch long piece of wood so that it will fit snugly into the end of the fid.

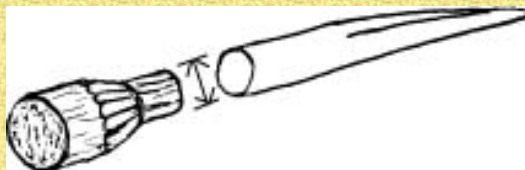

STEP 2: Attach handle to fid.

2A] Drill a small hole into the side of the fid about 1/2 inch from the end.

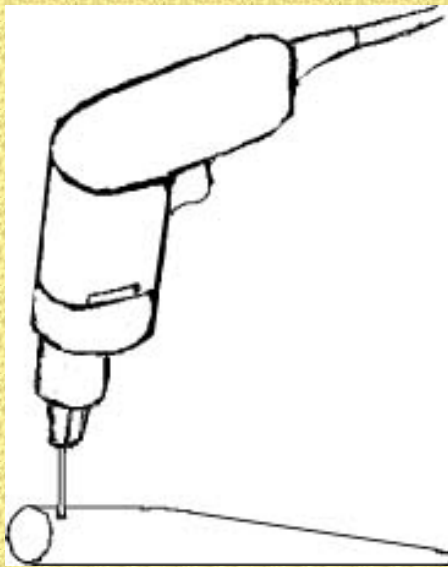

2B] Insert the handle into the end of the fid. Then drive a finishing nail through the hole into the wood of the handle.

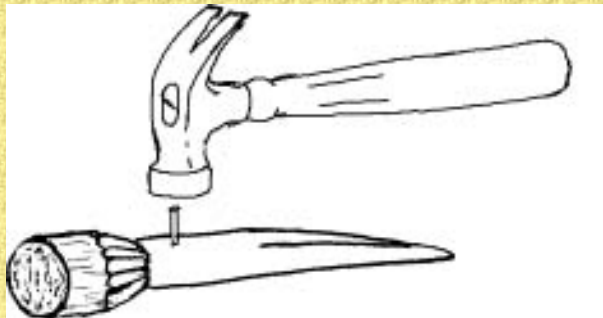

2C] Cut the nail off close to the side of the fid. Then file the nail down so that it is smooth and even with the surface.

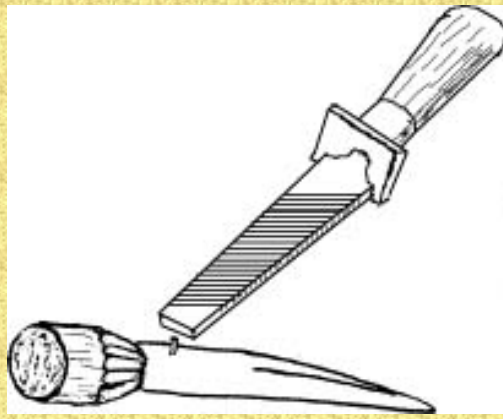

STEP 3: Finish the handle. Here is a chance to be creative. You can carve a simple rounded handle or let your imagination take over.

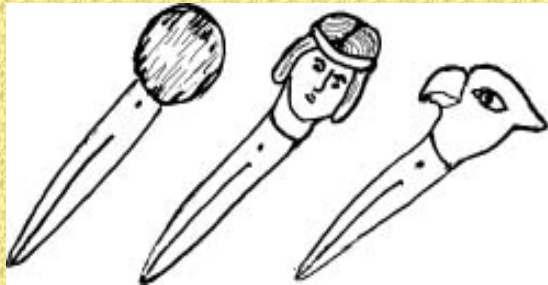

For a printout of the above go to....

<http://www.northnet.org/ropeworks/reader/fid.pdf>

For printouts of previous articles go to ...

ARCHIVES.

ARTICLE OF THE MONTH

ARCHIVE



Home
E-Mail

© 1999, Gerald L. Findley



MARLIN SPIKE HITCH:

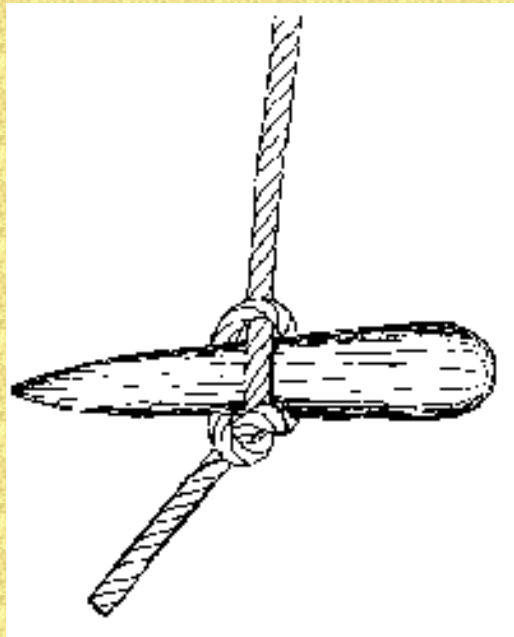

Description A loop formed by a half hitch around a bight in the standing part of the rope.

Use To temporarily hold a toggle (a Marlin Spike) so that a rope can be pulled tight; as a mooring hitch that can be dropped over the end of a stake or pole; to hold the rungs of a rope ladder.

Comments A secure temporary hitch that can be easily spilled by removing the toggle. The Marlin Spike Hitch gets its name from the practice of using it around a Marlin Spike or similar tool to tighten knots and servicing,

Other Names Slip Noose; especially when the half hitch is pulled closed around the bight.

Narrative ---- (For **marlin spike** knotboard) (1) Form an overhand loop. (2)

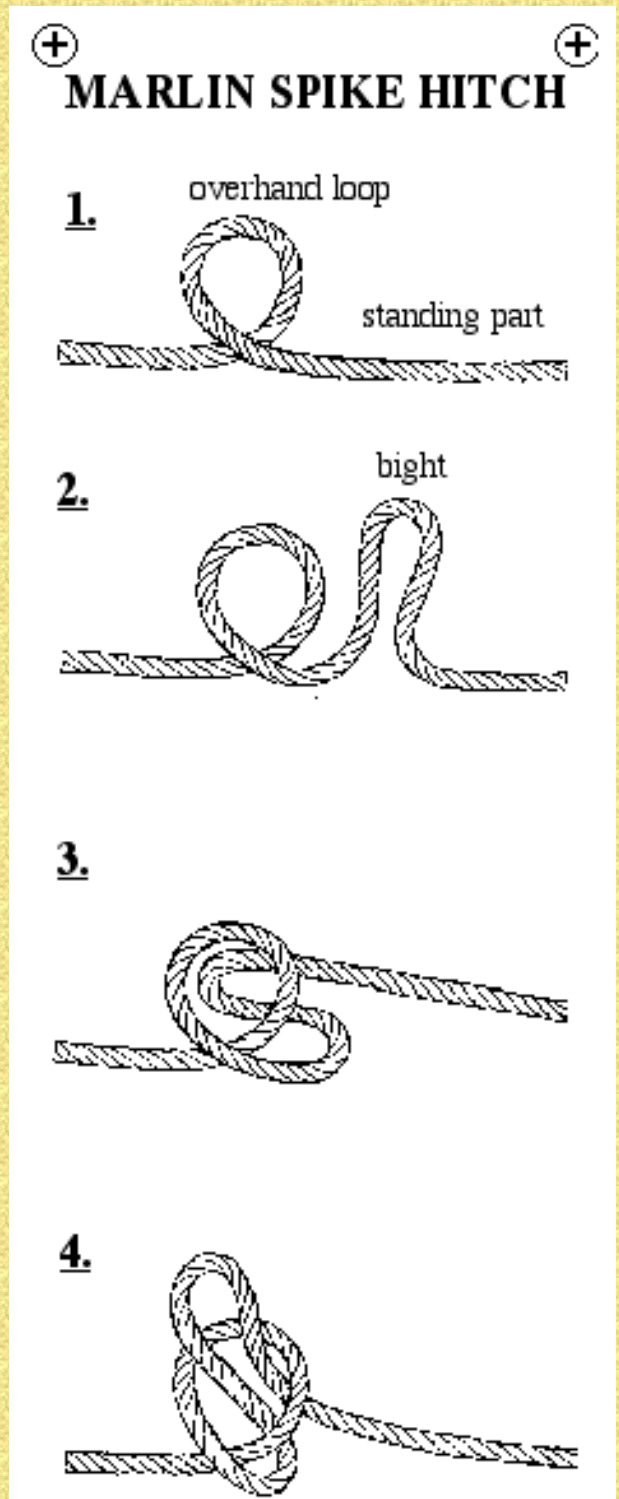

Then form a bight in the standing part. (3)
Place the bight under the overhand loop.
(4) Then reeve the bight through the
underhand loop. (5) Pass a toggle

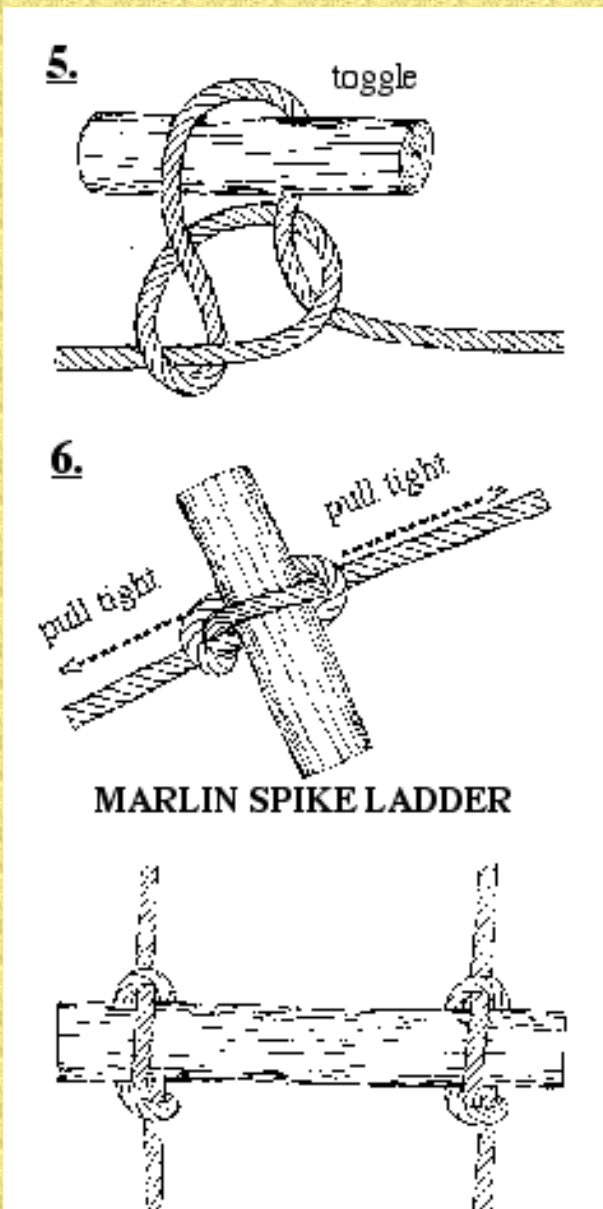

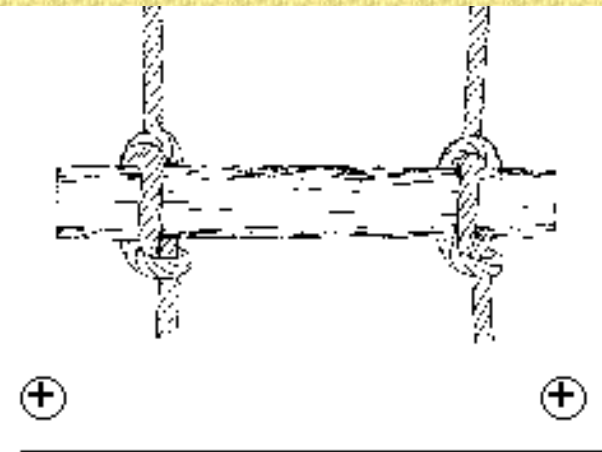

ARTICLE OF THE MONTH
ARCHIVE



[Home](#)
[E-Mail](#)

FOOTROPE KNOT

Description: a three strand knot that looks somewhat like a turk's head knot.

Comments: This knot was tied in the "footrope" (the rope that was tied under the yard arm for the sailors to stand on when they were setting the sails) to prevent the sailors' feet from slipping along the footrope.

Use: as a stopper knot in the end of a rope.

STEP 1: Unlay 4 to 5 turns of the lay.

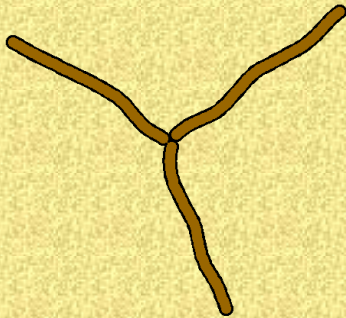

STEP 2: Tie a loose crown knot.



STEP 3:

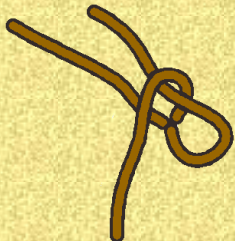

STEP 4:



STEP 5:



STEP 6:



STEP 7: Tie a wall knot under the crown knot but tuck the strands up through the center of the crown knot.



STEP 8:



STEP 9:



STEP 10:



STEP 11:



STEP 12:



STEP 13: Work tight and finish by combing out the fibers to form a tassel of relay the strand and whip the end of the rope.



[Home](#)
[←](#) [GUESTBOOK](#) [→](#)
[E-Mail](#)

[GO TO ARCHIVE](#)

ARTICLE OF THE MONTH

Each month there will be new knotboard and descriptive text displayed on this page.

THIS MONTH'S IS THE :

© 2001, Gerald L. Findley

CAMP STOOL:

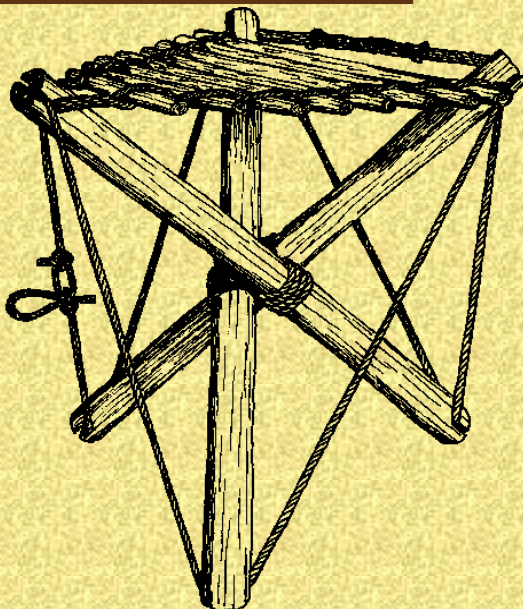

MATERIALS:

3 --- 2 Foot * 2 inch poles

20 --- 1/2 inch diameter sticks (various lengths)

1 --- 3/8 inch * 5 foot rope

1 --- 1/4 inch * 12foot rope

CONSTRUCTION:

STEP 1: Cut a groove 1 inch deep and 3/8 inch wide in each end of the 2 foot poles. Be sure that the grooves are in the same direction.

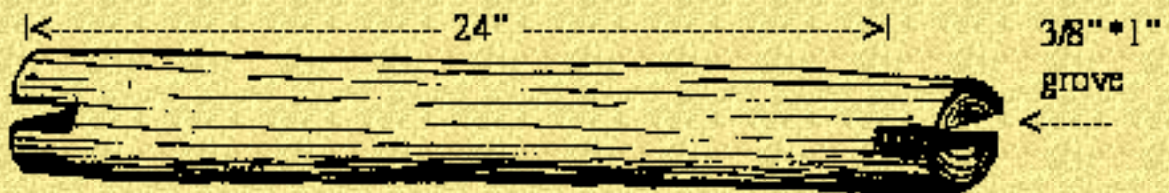

STEP 2: Lash the 2 foot pole together at their centers with the 1/4 inch * 12 foot rope. Use the **equal shear tripod lash** shown here.

2A] Tie a clove hitch around one of the poles; secure the end by wrapping it around the standing end.

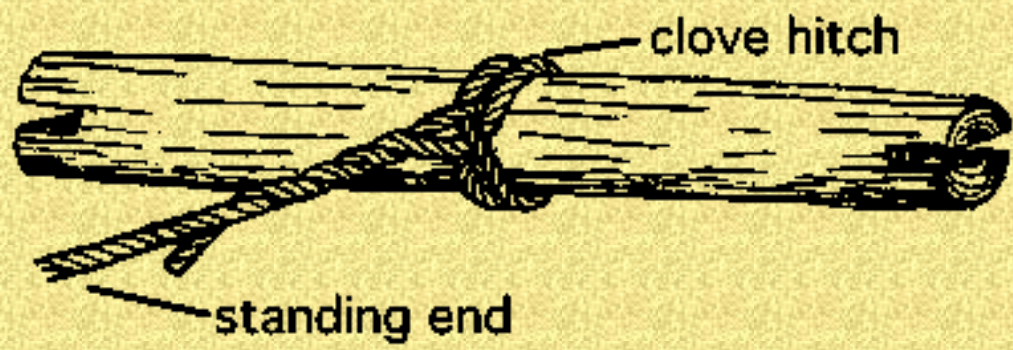

2B] Take 4 wraps around the 3 poles; follow the pattern shown for each wrap.

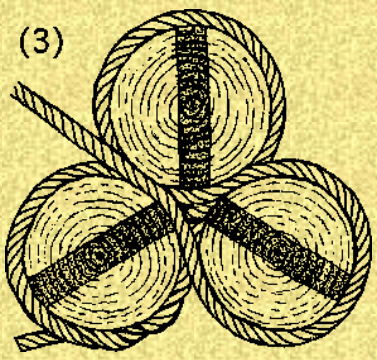
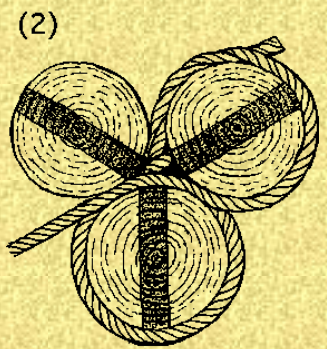
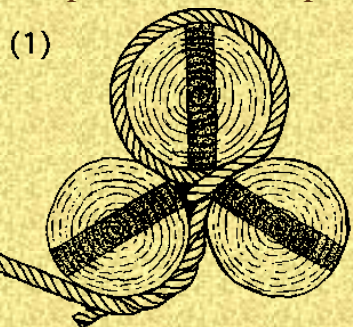

2C] Take 2 frapping turns behind each pole.

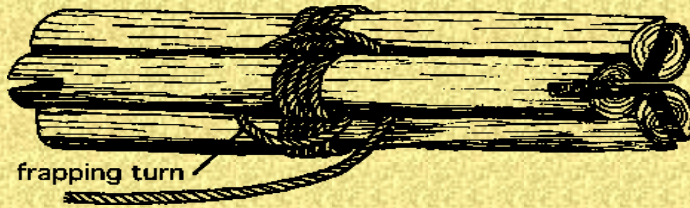

2D] End the lashing with a clove hitch around one of the poles.

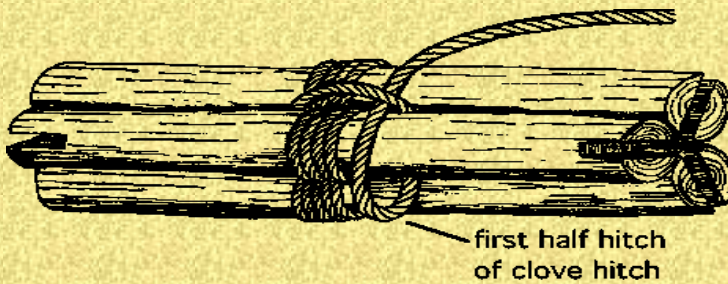

2E] Set the tripod up by rotating each leg

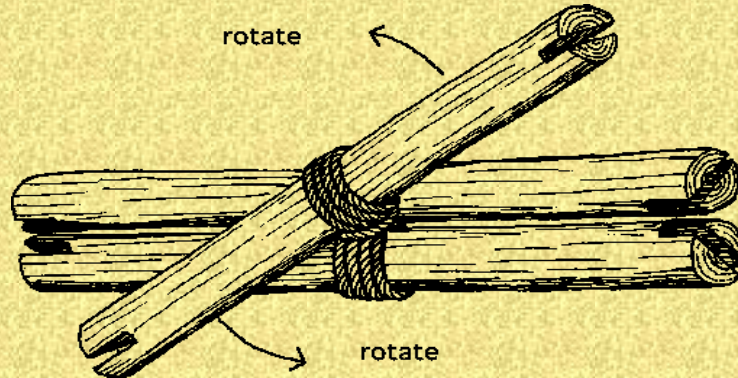

STEP 3: Prepare the seat support rope by marking the middle of the 3/8 inch * 5 foot rope by tying a piece of twine around it. Then form a loop that has a 42 inch circumference by temporarily tying the ends of the rope together.

STEP 4: Place the seat support rope in the groves at the top of the poles so that the middle of the rope is in one of the groves. Adjust the ends poles so that they are evenly spaced around the loop.

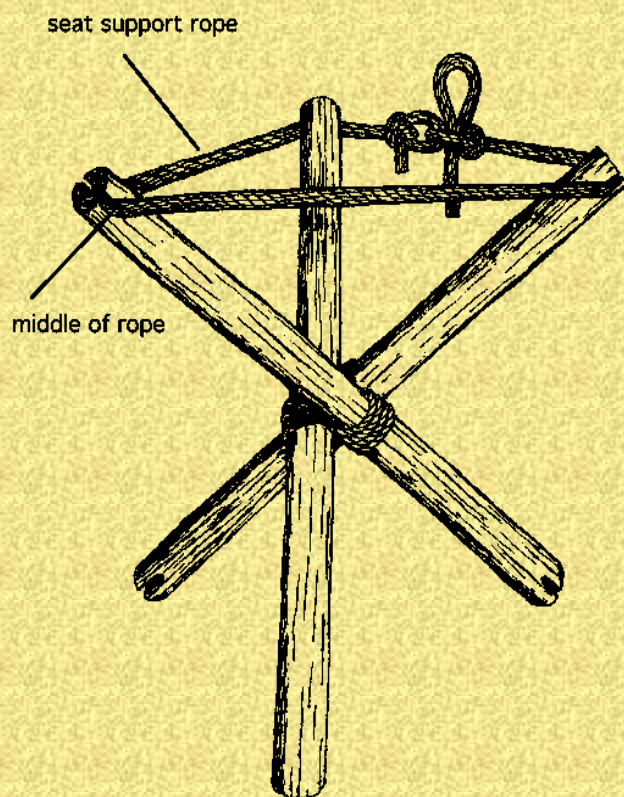

STEP 5: Add the bracing rope. Tie a bowline into one end of the 1/4 inch * 10 foot rope. Then weave the rope back and forth between the ends of the tripod poles; follow the pattern shown in the diagram. End by tying a slippery half hitch through the eye of the bowline.

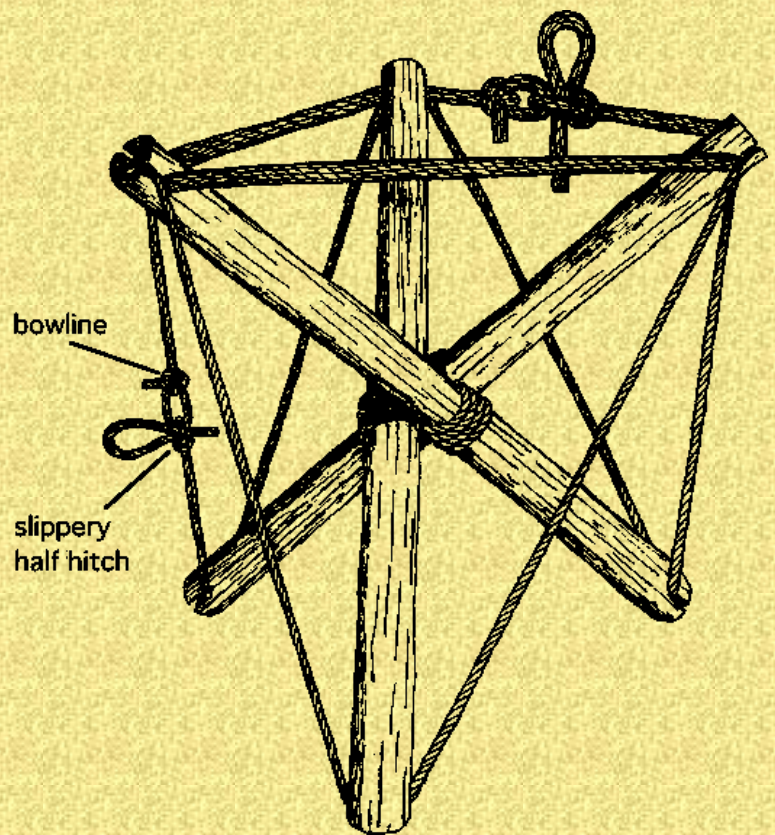

STEP 6: Assemble the seat.

6A] Lift one strand of the lay of the seat support rope on either side of the pole that is at the midpoint of the rope loop.

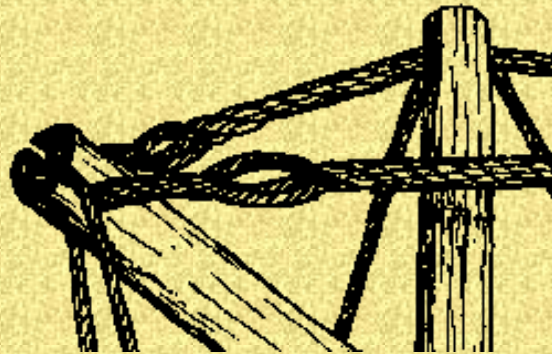

6B] Slide the ends of a 1/2 inch stick under the lifted strands of the seat support rope

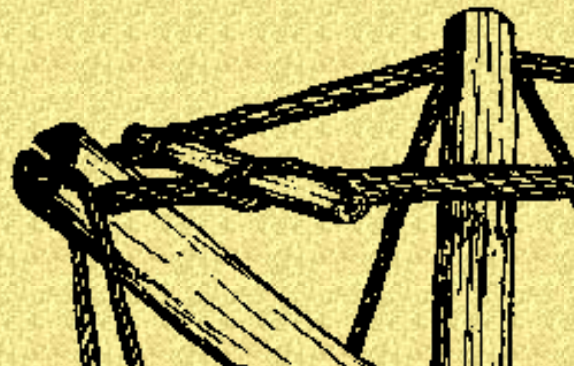

6C] Lift the next strand of the lay of the rope on either side of the pole that is at the midpoint of the seat support rope

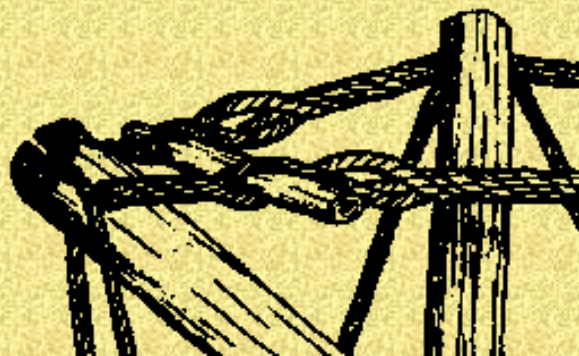

6C] Insert the next 1/2 inch stick.

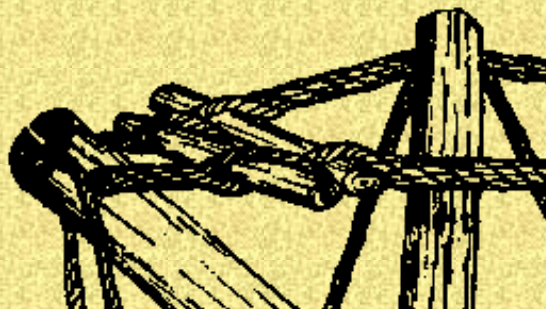

[NOTE] To keep the ends of the tripod poles at a equal distance from each other as the seat is being constructed, the temporary knot that joins the two ends of the seat support rope will need to be retied several times.

6E] Continue in this manner until the seat is the desired size.

6F] Permanently join the 2 ends of the rope loop with a short splice.

6G] Trim the ends of the 1/2 inch sticks so that they extend about 2 1/2 inches beyond the rope.

[NOTE] By removing the 1/4 inch brace rope, this stool can be folded for transport and storage.

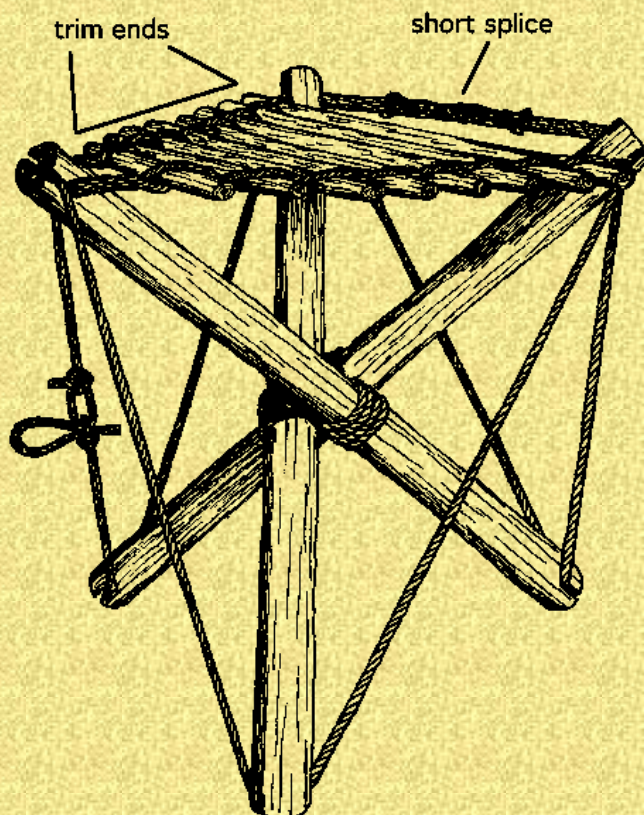





!-- Generation of PM publication page 1 -->



MONKEY'S PAW

(coil style)

(1) Form the first coil by stacking three loop on top of each other.

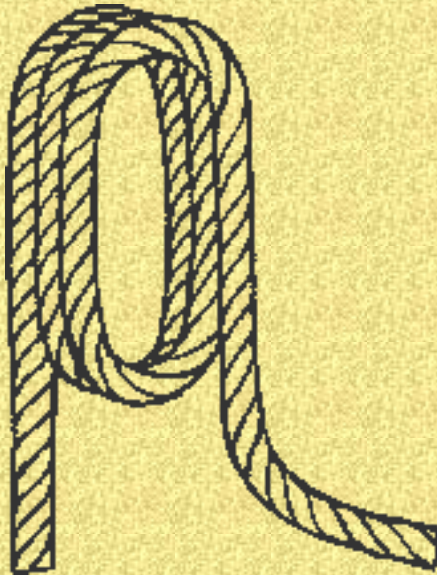

(2) Insert core into center of coil.

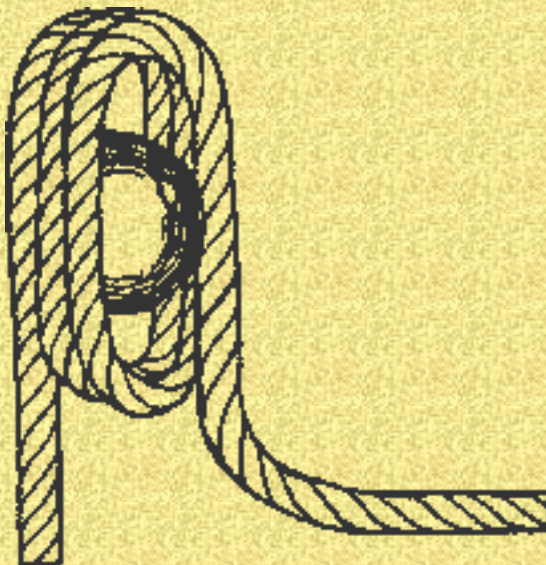

3) Start second coil by forming a small loop at the bottom of the first coil.

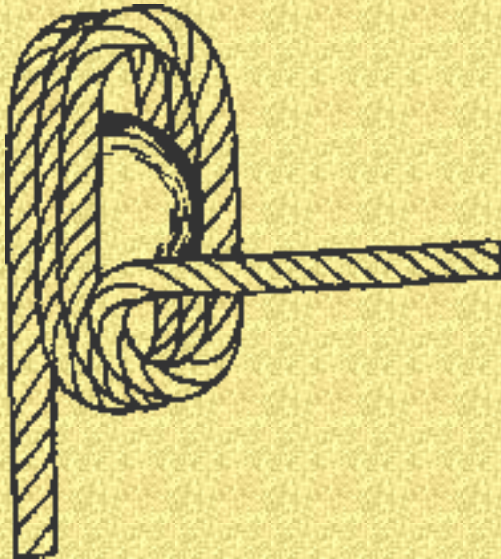

(4) Pass the running end behind and

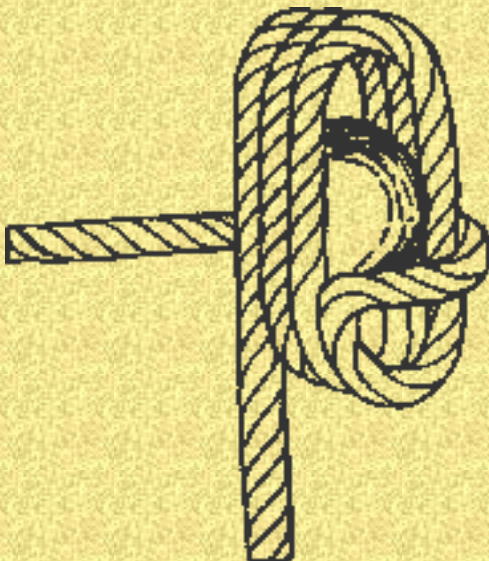

(5) across the front to for the first loop of the second coil

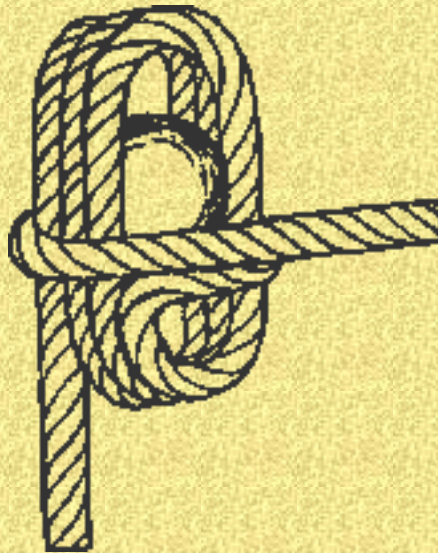

(6) Add the second and third loops of the second coil.

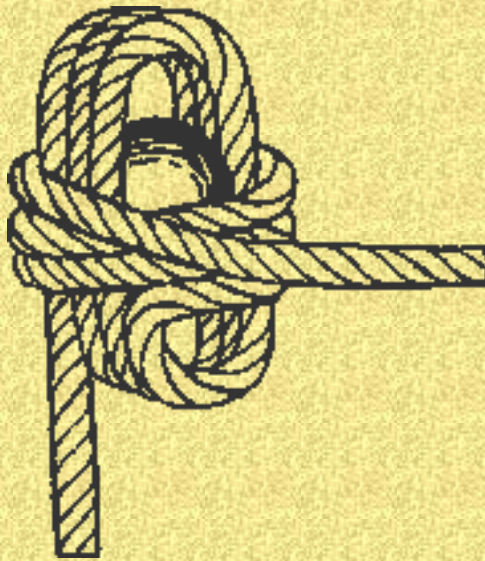

(7) Start the third coil by reeving the running end through the top of the first coil and

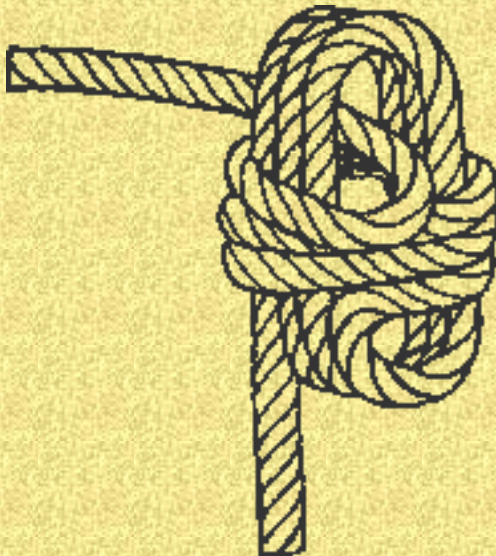

(8) then reeve the running end through the bottom of the first coil.



(9) Add the second and third loops of the third coil.

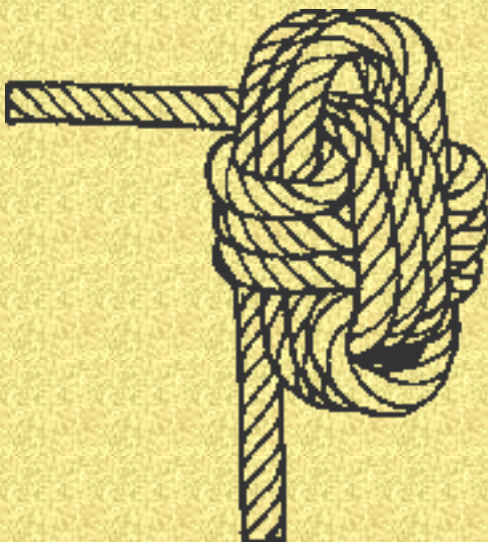

(10) Work all coils tight over the core.





Flag Pole Cleat:

A cleat is a device used to temporarily secure a line. When valuable equipment such as boat is being tied off, a commercially made cleat should be used. However, when a rustic appearance is desired a temporary cleat can be made with rope and wood.

Green
Stick
Cleat:

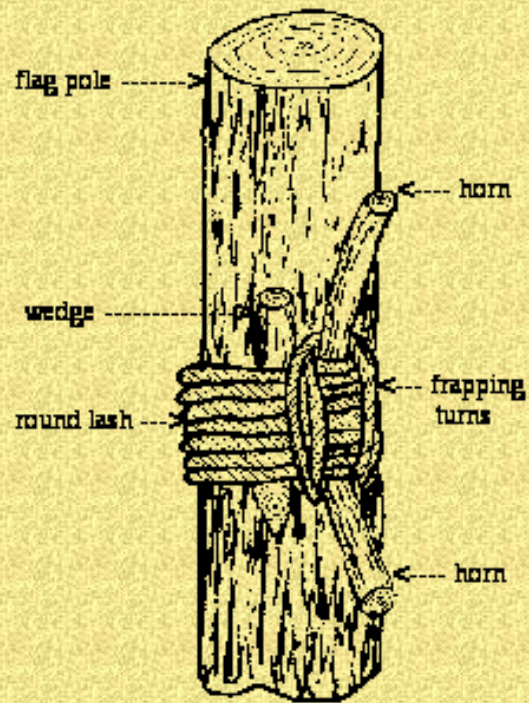

[Step 1] Round lash a piece of flexible green wood or a naturally curved piece of wood to the flag pole to make the horns of the cleat.

[Step 2] Tighten the round lashing by driving a small wedge on either side of the cleat.

[Step 3] Use frapping turns to raise the horns of the cleat.

Dry Wood Cleat:

Suggestion 1 ----

If only dry wood is available a cleat can be made as shown in the following diagrams:

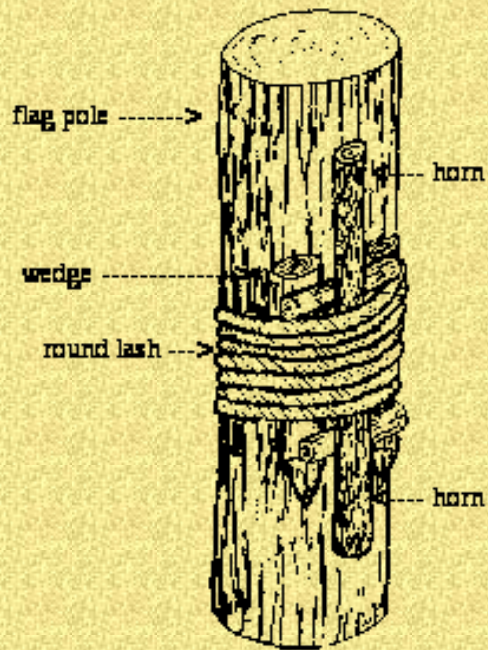

[Step 1] Round lash a stick of suitable size to the flag pole to make the horns of the cleat.

[Step 2] Raise the horns by forcing short risers under each horn.

[Step 3] If needed tighten the round lashing by driving a small wedge on either side of the cleat.

Suggestion 2 ----

Preshape the cleat from a piece of limb wood .

[Step 1] Split a 3 inch diameter by 8 inch piece of limb wood in half.

[Step 2] Use an ax and knife to shape the horns on either end of split piece of wood.

[Step 3] Round lash the cleat to the flag pole.

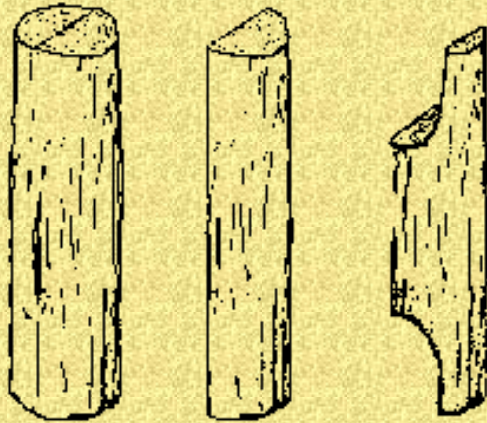

[Step 4] Tighten the round lashing by driving a small wedge on either side of the cleat.



Precut Cleats:

A cleat can be made from hard wood lumber by sawing it to the desired shape and then round lashed to the flag pole. Small wedges are used on either side of the cleat to tighten the round lashing and to stabilize the cleat.

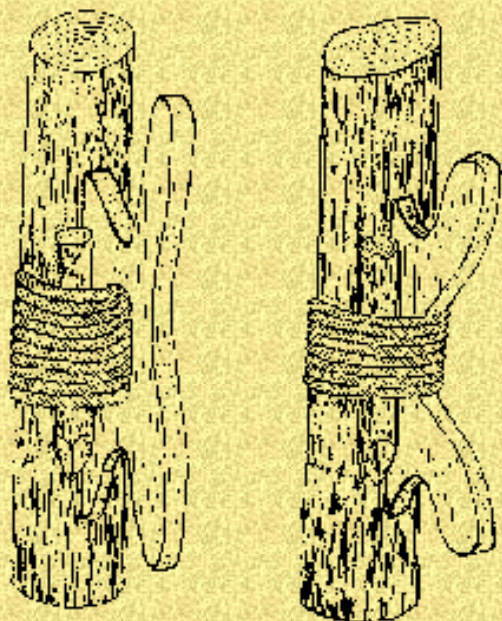

Making Wedges:

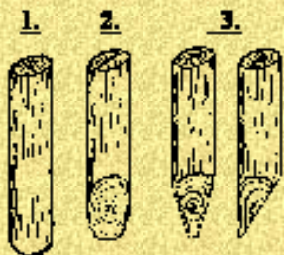

[Step 1] Cut to size. Length --- slightly longer than the width of the round lashing. Diameter --- slightly larger than the gap formed between the rope, the flag pole, and the cleat.

[Step 2] Cut one end off at an angle.

[Step 3] Taper the sides of the point so that the point of the wedge is on one side.

LE
BORDER=0 CELLPACING=0 CELLPADDING=0 LANG=en DIR=LTR WIDTH="612" COLS="8">

ROPE WRENCH:

A rope wrench is a simple tool that can be used to tighten the ropes of a lashing. Use a crochet stick that is about 18 inches long and 1 1/2 inches in diameter; the crotch should be about 6 inches from the end.

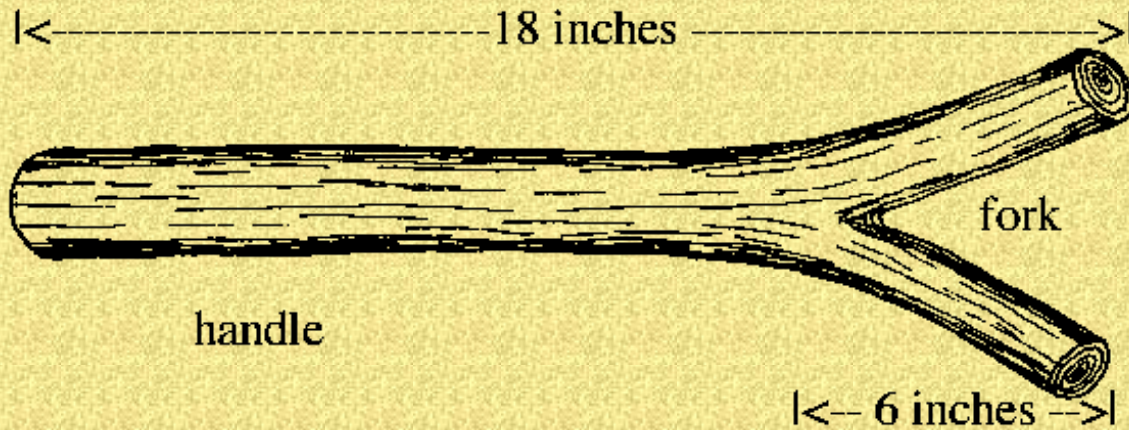

Using A Rope Wrench:

[STEP 1] Use the rope wrench by placing it over the pole next to the rope that is to be tightened.

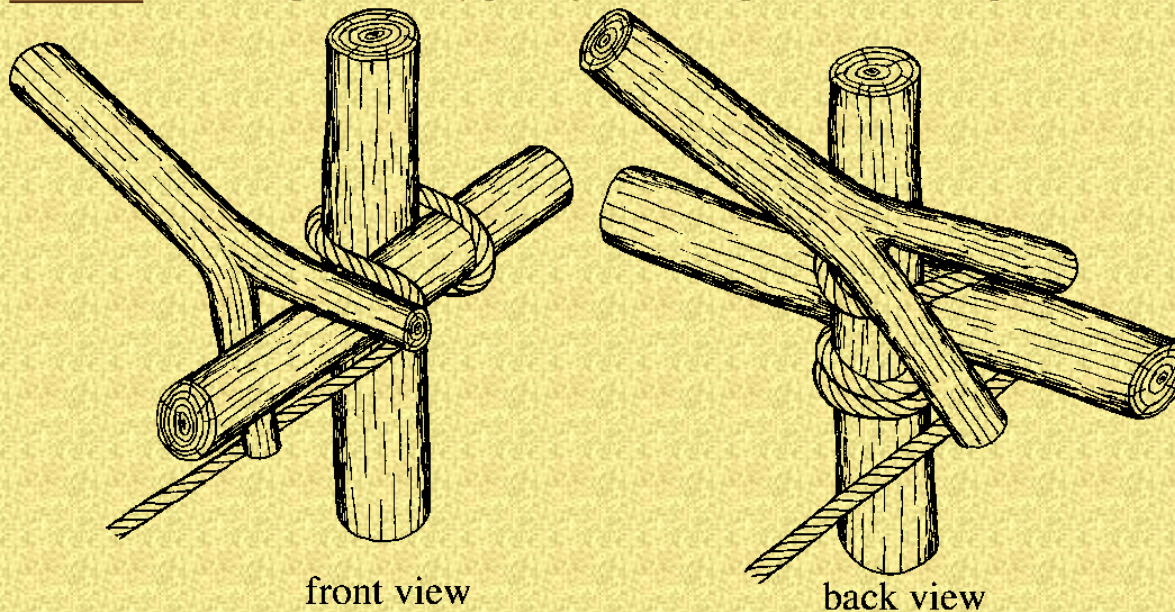

[STEP 2] Wrap the rope around the fork of the wrench.

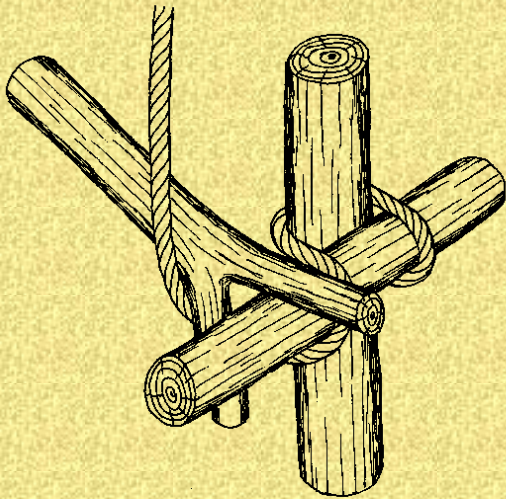

front view

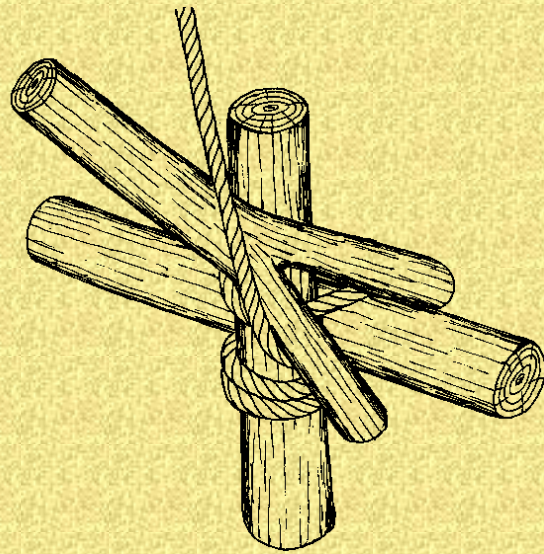

back view

STEP 3] Make one or two wraps around the handle of the wrench.

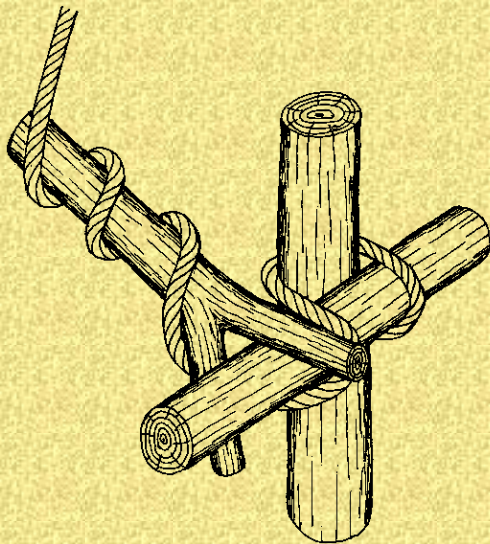

front view

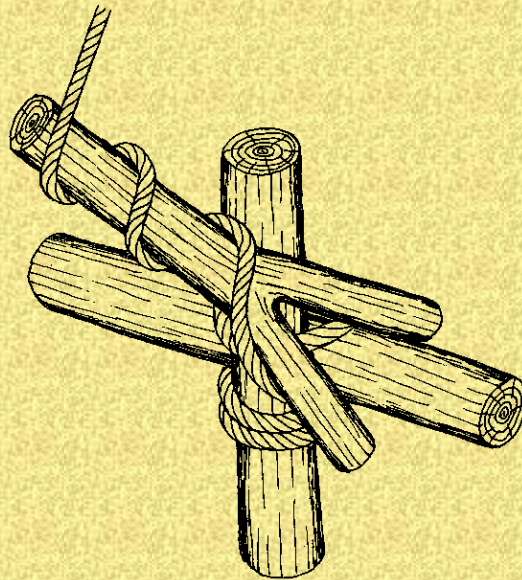

back view

[STEP 4] Grasp the handle so that you are holding the rope firmly to the handle; then rotate the wrench around the pole.

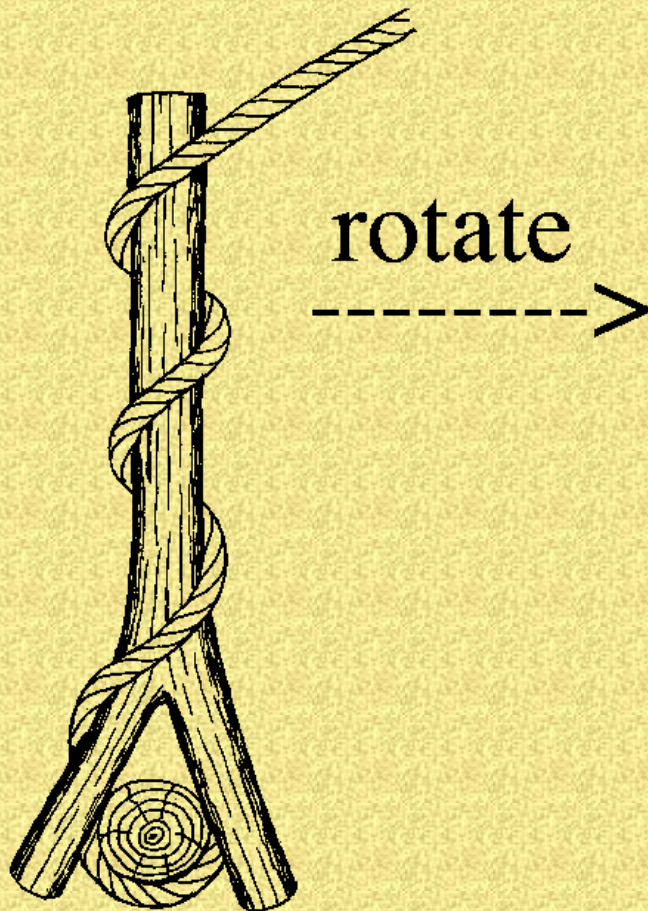

[NOTE] Tighten each turn of a lashing as it is made. The friction between the rope and the pole is too great to tighten more than one turn at a time.

Maintain the tightness of the rope by keeping a small amount of tension on it or by pressing the rope firmly against one of the poles while taking the next turn around the poles.

Be careful that the rope is not tightened so tight that the fibers of the rope begin to break.

Generation of PM publication page 1 -->

NETTING:

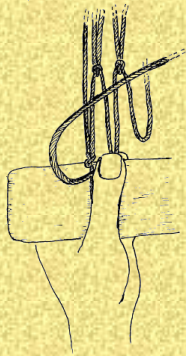

The making of netting is an ancient craft. Many prehistoric cultures used netting for a verity of uses, storage bags, fencing, hammock, just to name some and of course the obvious use as a fish net. No matter what the netting was used for, the knitting of the mesh was done by tying a series of loops in some type of twine.

In one method, the basic knot used was the sheet bend. To form and tie the loops a knitting shuttle and a spacer (gauge) were used.

NETTING TOOLS:

The size of the shuttle and gauge that is needed will depend on the project that you are working on. The size of the shuttle and gauge given in the following directions is a convenient size for many projects and is also a good size to use for practicing the craft of netting. Shuttles and gauges of different sizes can be made by changing the size of the materials used.

Knitting Shuttle:

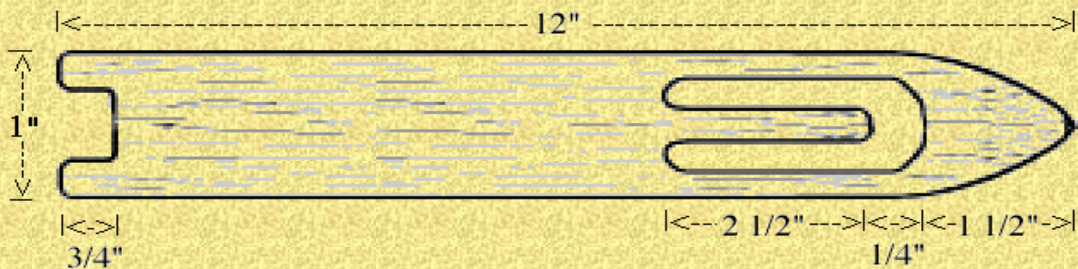

cross
sections

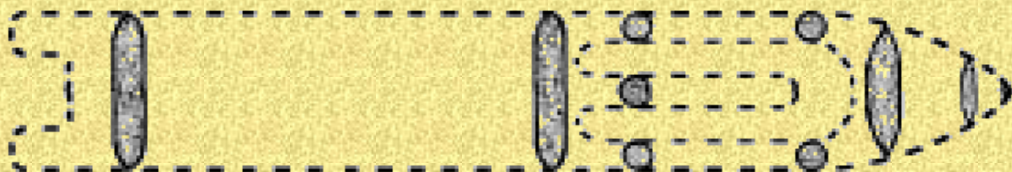

Make the knitting shuttle from a 1/4 inch * 1 inch * 12 inch piece of smooth grained hard wood. Carve and sand the shuttle to the shape shown in the diagram. Leave the shuttle unfinished; varnish or paint has a tendency to become sticky.

Knitting Gauge:

Make the knitting gauge from a 1/4 inch * 1 1/4 inch * 12 inch piece of smooth grained hard wood. Carve and sand the gauge to the shape shown in the diagram. Leave the gauge unfinished; varnish or paint has a tendency to become sticky.

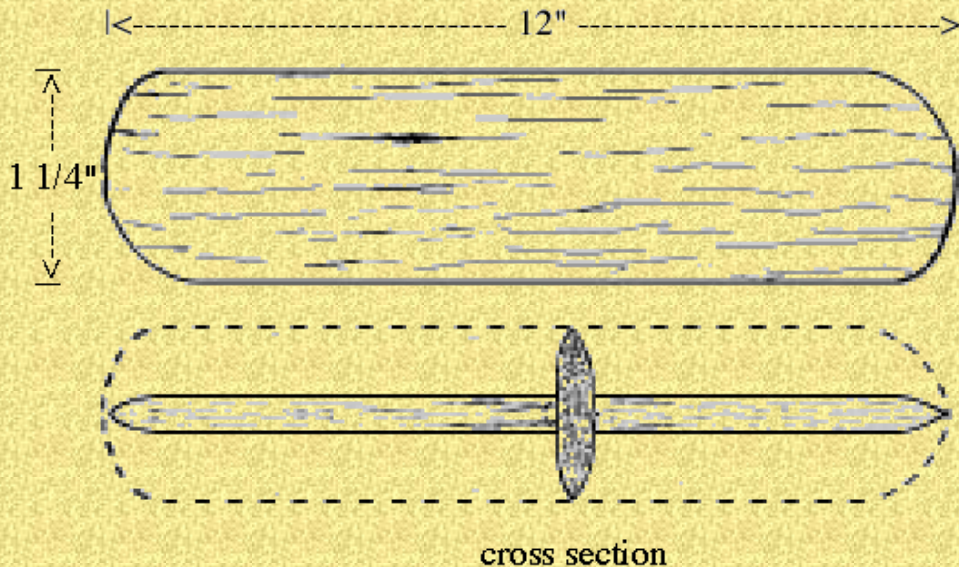

Filling The Knitting Shuttle:

STEP 1: Fill the shuttle with twine. Start by tying a single hitch around the tongue of the shuttle and then pass the twine through the notch.

STEP 2: Turn the shuttle over, loop the twine around the tongue and then through the notch.

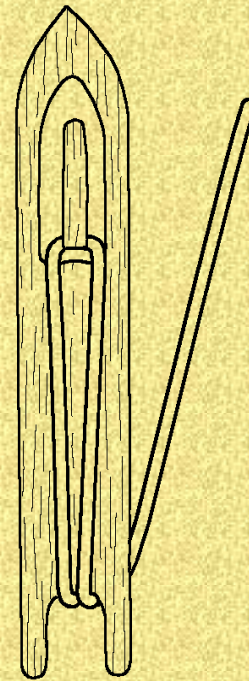
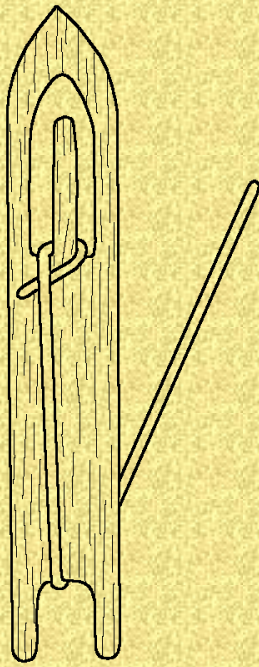

STEP 3: Continue turning the shuttle from side and looping the twine around the tongue until the shuttle is filled.

[NOTE] To prevent synthetic twine from fraying, use a candle flame to cut and fuse the ends.

[WARNING] Using a butane cigarette lighter to cut or fuse synthetic rope or twine may cause the lighter to over heat and explode.

DIAMOND MESH NETTING:

Diamond mesh netting is the easiest of the two forms of mesh to make. Square mesh netting will be dealt with latter.

Casting On: To start diamond mesh netting the first row of mesh loops is cast on to a loop of some kind. The kind of loop used depends on the project; a ring, grommet, frame, or loop of twine may be used. The following directions are for casting on to a ring but the same steps may be used for any starting loop.

STEP 1: Tie the end of the twine to the ring with a clove hitch stopped with two half hitches.

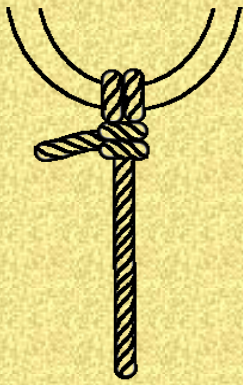

STEP 2: Place the twine behind the gauge then bring the twine in front of the gauge and to the right.

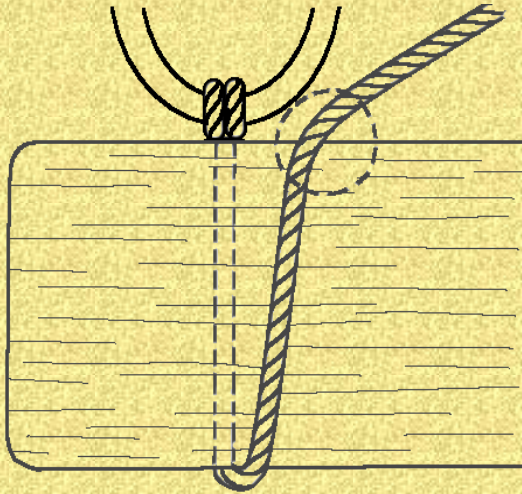

[NOTE]: The dotted circles in each of the diagrams is used to show the position of the thumb and finger of the left hand.

STEP 3: Reeve the twine through the ring from the front to the back so that an overhand loop is formed.

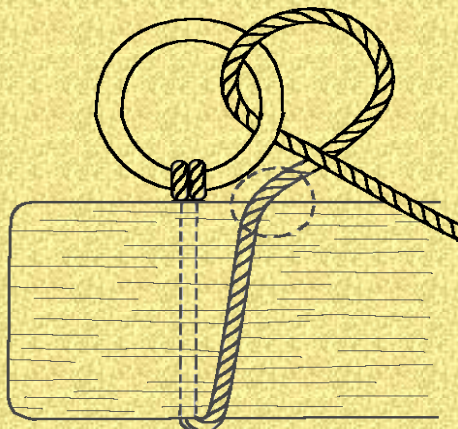

STEP 4: Pull the twine to the left to tighten the twine around the ring and the gauge.

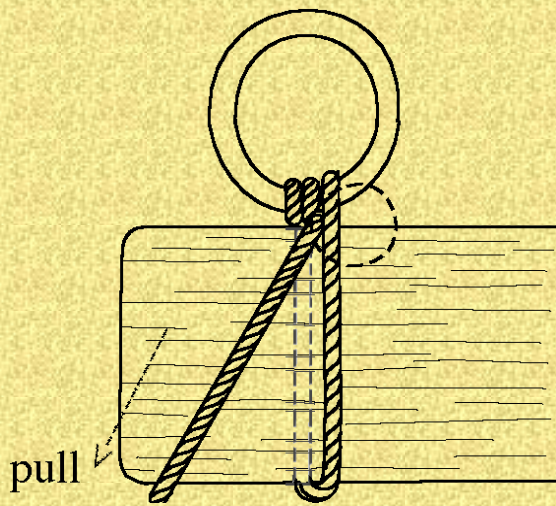

STEP 5: Lay the twine across the ring from left to right.

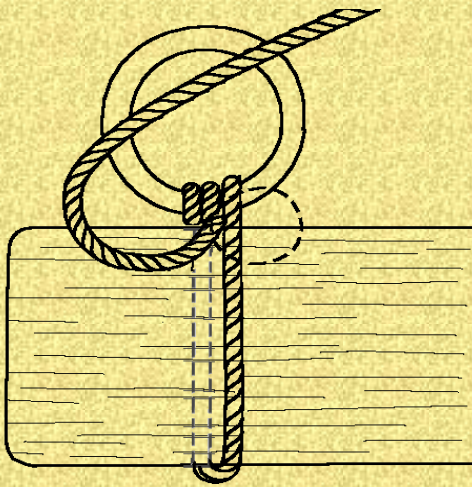

STEP 6: Reeve the twine through the ring from the back to the front.

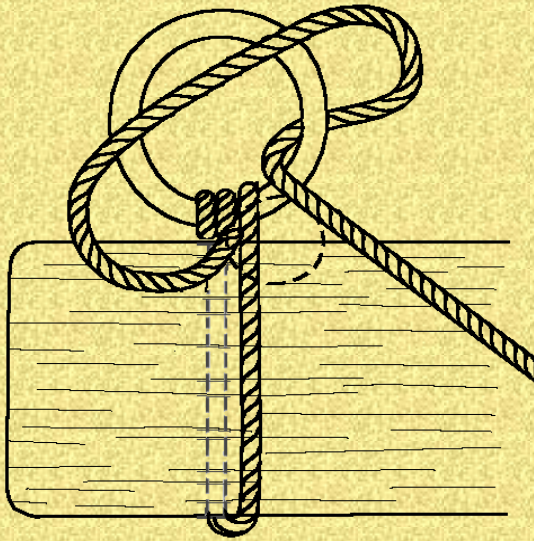

STEP 7: Place the twine behind the gauge; then pull the twine downward to tighten the twine around the ring. This forms a lark's head knot around the ring.

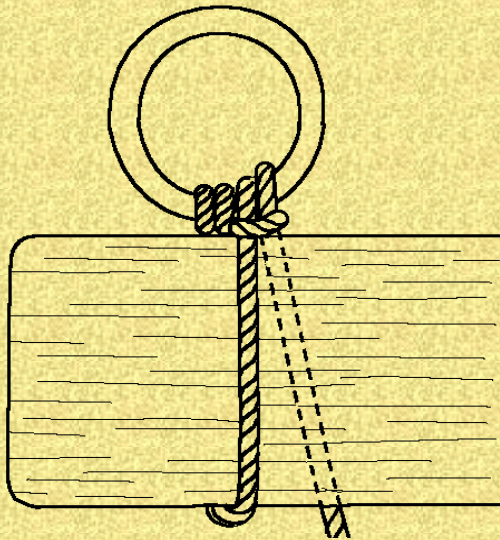

KNITTING A ROW OF MESH:

Netting is made by knitting rows of mesh using a shuttle and a gauge. The gauge is used to determine the size of the mesh, and the shuttle is used to hold the twine and form and tie the mesh loops. The basic knot used in netting is the sheet bend. The following diagrams illustrate the tying of the sheet bend as it is used for knitting a net.

STEP 1: Bring the twine down and up the back of the gauge. Then pick up the next loop by passing the shuttle through the loop from front to back.

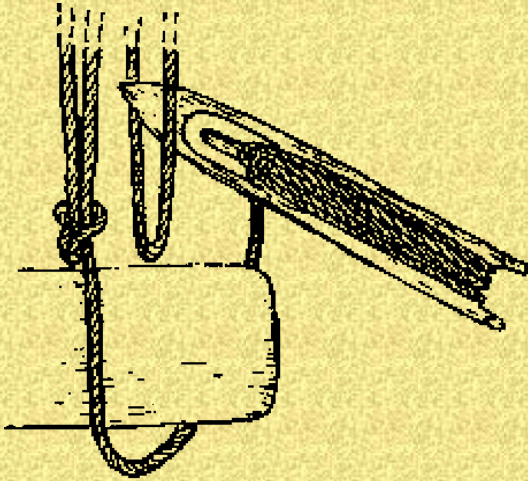

STEP 2: Pull the twine to the left to tighten the twine around the gauge. Use the thumb and finger of the left hand to hold the twine in place.

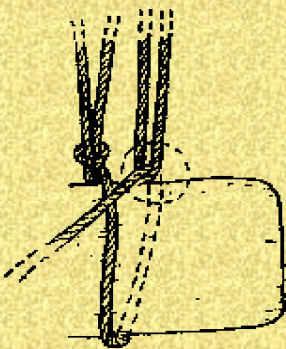

STEP 3: Lay a loop of twine over the loop just picked up.

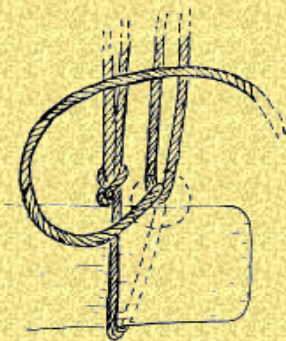

STEP 4: Pass the shuttle in back of the picked up loop and the through the loop that was laid on top.

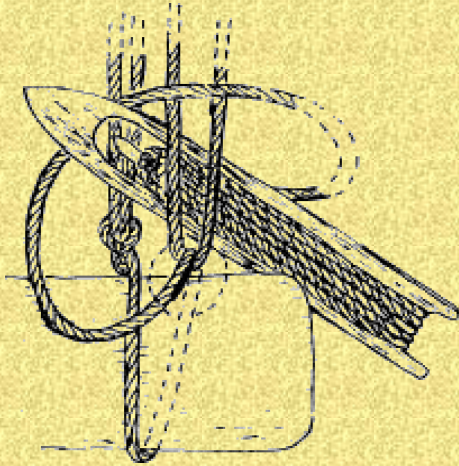

STEP 5: Pull the twine downward and slightly to the right to tighten the knot.

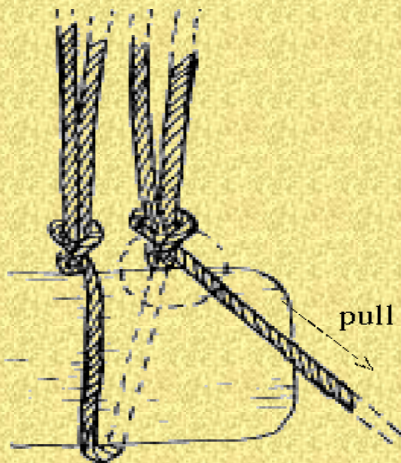

STEP 6: Repeat steps 1 through 5 for each loop in the row.

STARTING A NEW ROW:

STEP 1: When the end of a row of mesh is reached, slide the accumulated loops off the gauge, turn the work piece over so that the running end of the twine is on the left side of the work piece.



STEP 2: Wrap the twine around the gauge from front to back; pick up the first loop by passing the shuttle through the loop from back to front.

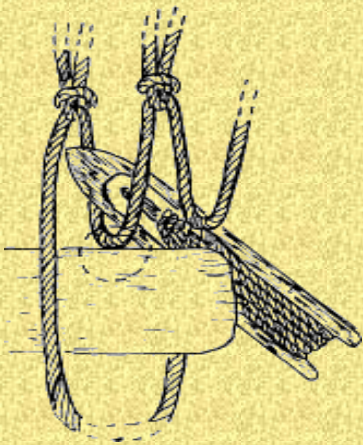

STEP 3: Knit the loop in place by following the directions for knitting a row of mesh.

ADDING A LOOP:

For some projects it is necessary to increase the width of the netting part way through the project. The width of the netting is increased by adding loops of mesh.

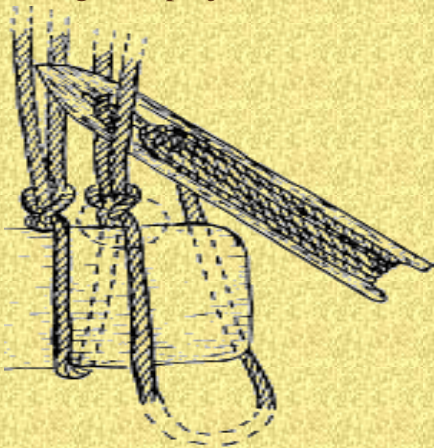

A loop is added by picking up the same loop a second time so that two loops are formed in the new row of mesh are tied to the same loop in the previous row of mesh.

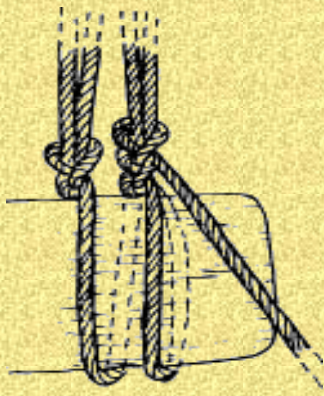



PROLONG KNOT

DESCRIPTION:

A flat knot that is made by interweaving two strands of rope.

USE:

As stair tread, mat, or chafing gear; also as a decorative knot in a two strand lanyard.

COMMENTS:

The prolong knot gets its name from the fact that it can be extended to any length.

TYING:

STEP 1:

Place the center of the rope over a peg or hook and tie a loose half knot.

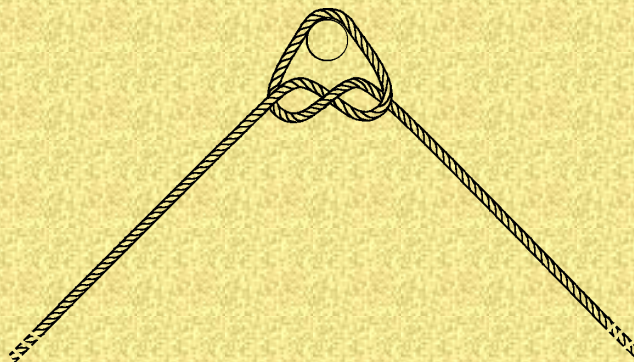

STEP 2:

Extend the half knot as shown.

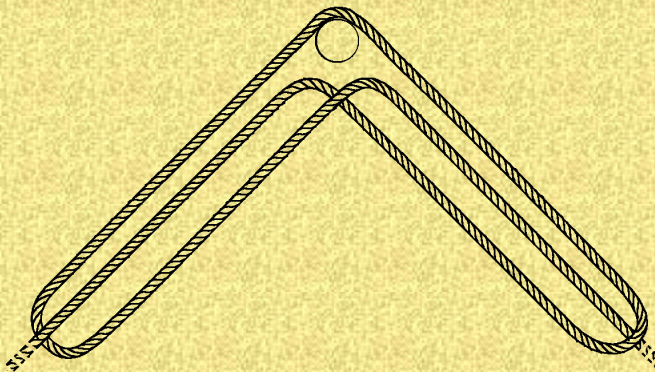

STEP 3:

Twist the left loop and extend it to the right side.

[NOTE] This will start the over under pattern

of the weaving.

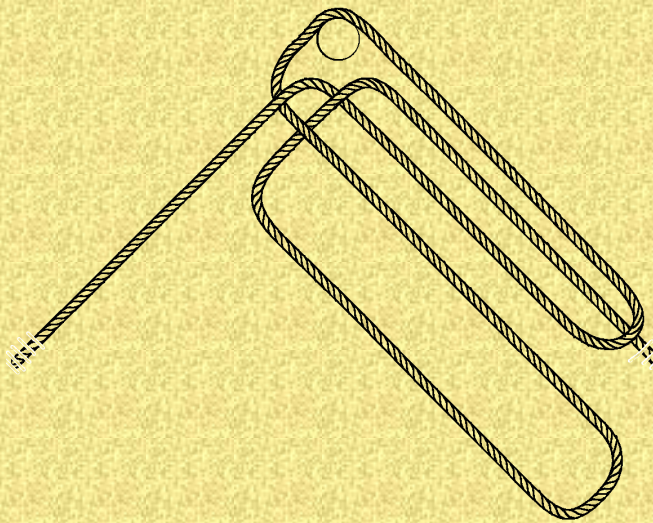

STEP 4:

Twist the right loop and extend it to the left side so that it is over the first extended loop.

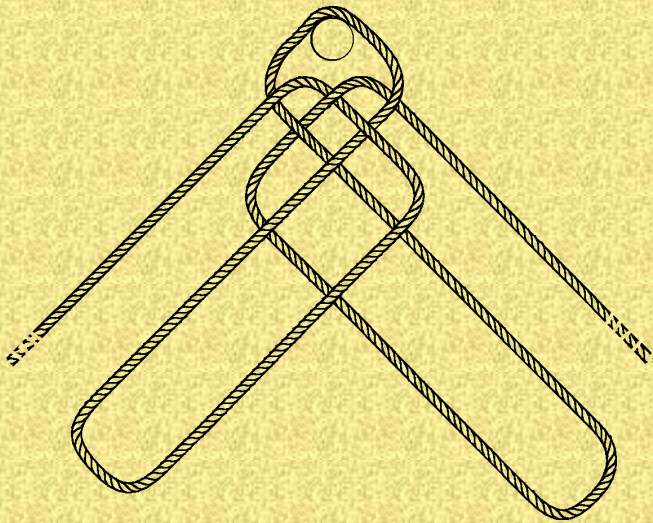

STEP 5:

Weave the left strand to the right in the pattern shown.

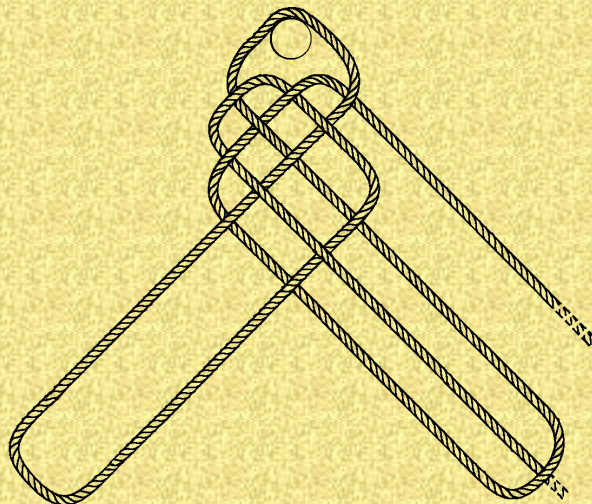

STEP 6:

Weave the right strand to the left in the pattern shown.

[NOTE] This completes the four bight prolong knot. At this stage it may be ended and worked firm (over tightening distorts the knot) or the strands may be doubled as shown in later diagrams.

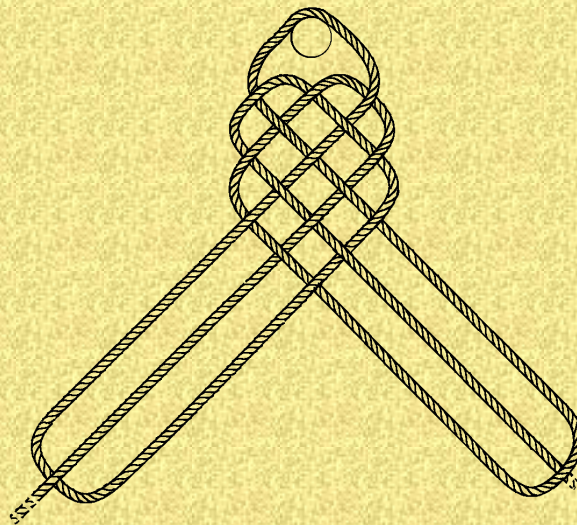

STEP 7:

Twist the left loop and extend it to the right side.

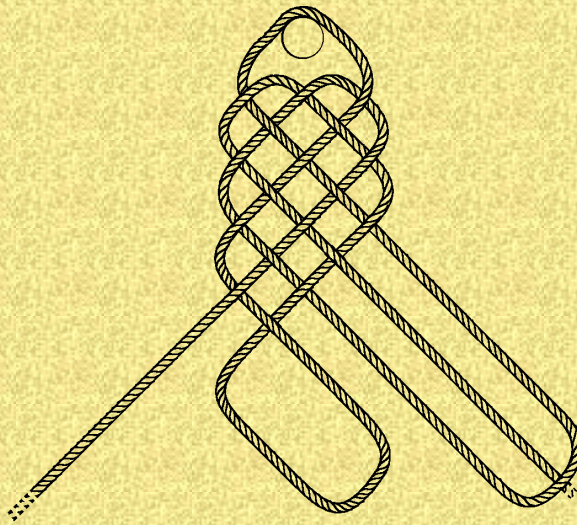

STEP 8:

Twist the right loop and extend it to the left side so that it is over the first extended loop.

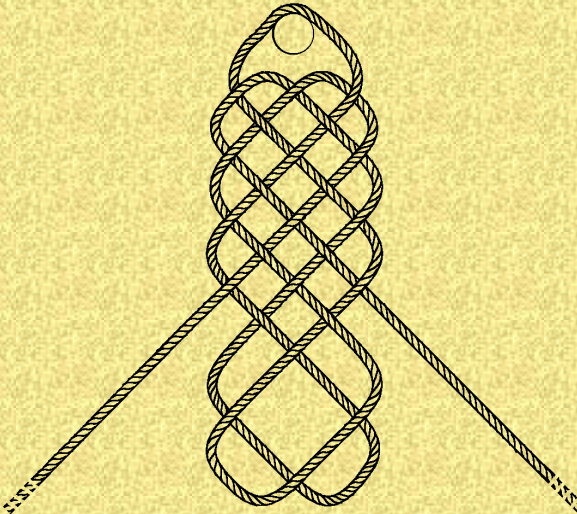

STEP 9:

Weave the right strand to the left in the pattern shown.

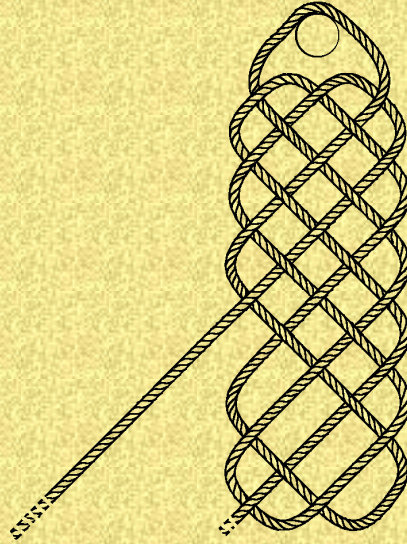

STEP 10:

Weave the left strand to the right in the pattern shown. This completes the 7 bight form of the prolong knot.

[NOTE] The prolong knot can be extended three bights at a time by repeating steps 7 through 10 for each extension.

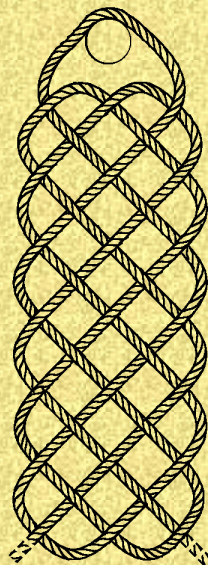

STEP 11:

Start doubling the strands by chasing (following) the opposite strand.

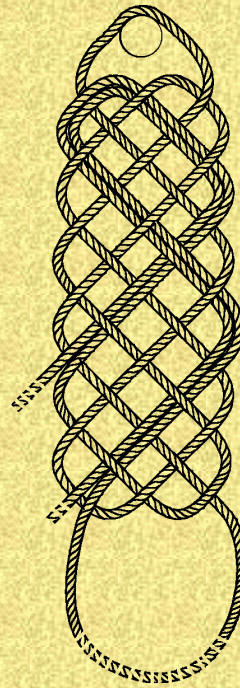

STEP 12:

Complete doubling the strands. Then work the knot into a firm mat . Do not over tighten the strands as this will distort the mat.

[NOTE] The ends of the strands can be hidden by sewing them to the adjacent strand on the underside of the mat.

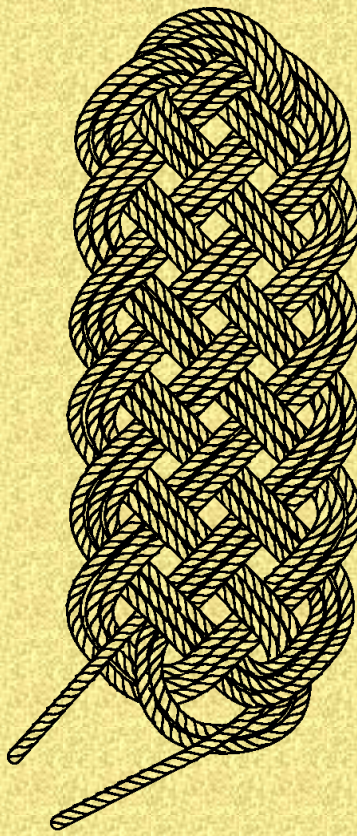

1996, Gerald L. Findley

LIFE BASKET:

Description ---- A body harness made by combining a bowline on a bight and a french bowline.

Use ---- To lower a severally injured person when a life threatening situation exists.

Comments ---- The life basket is a secure harness that can be used to move an injured person that is weakened or unconscious. However, unless there is a life threatening situation, such as a burning building or immediate danger of avalanche, you should wait for a trained rescue team.

If you attempt to use the life basket, do not allow the rope to slide through your hands as you lower the injured person . The friction caused by the sliding rope can cause severe painful rope burns and loss of control of the rope. The rope must be let out in a hand over hand manner to insure a safe, controlled descent.

1.



Narration ---- (1) Tie a bowline on a bight. Place one loop of the bowline on a bight around each leg. [NOTE] (The bowline on a bight should be large enough so that when it is in place the knot should be close to the victims belt buckle. Be sure to leave the running part of the rope extending about 3 feet beyond the knot.)

2.

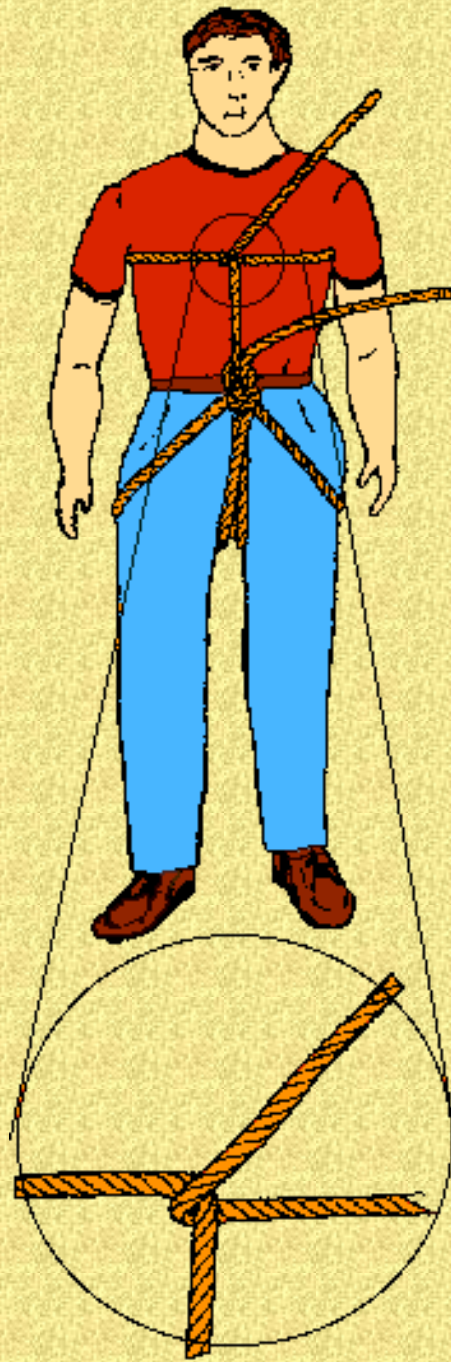

(2) Take a half hitch around the victims chest.

(3) Form a bight in the standing part by pulling it under the right hand part of the half hitch so that an underhand loop is formed around the cross point of the half hitch.

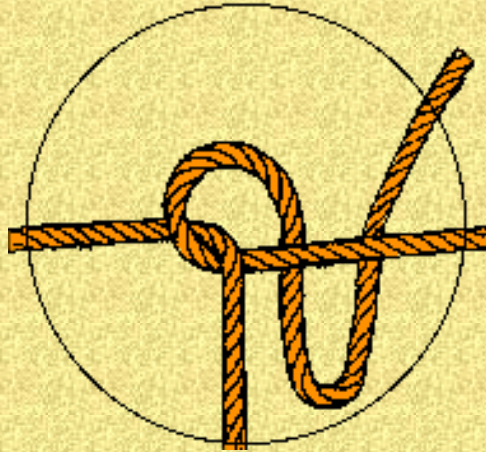

(4) Fold the bight around and reeve it through the eye of the underhand loop.

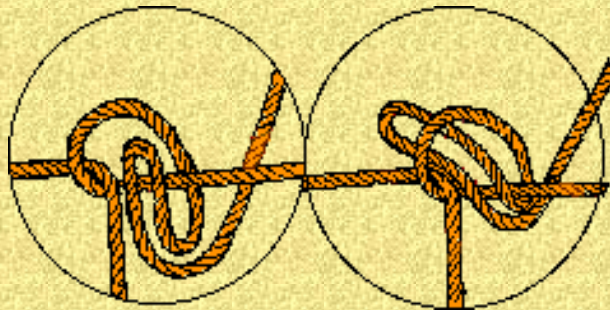

(5) Reeve the running part of the rope through the bight.

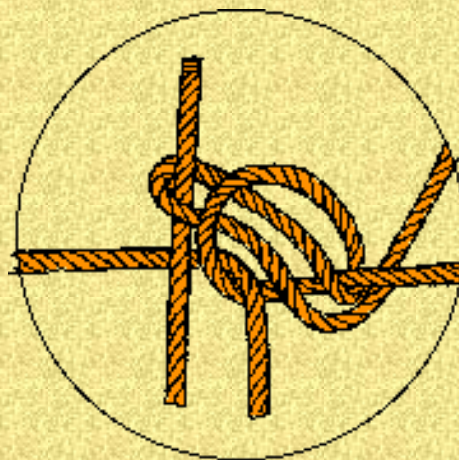

(6) Take the slack out of the running part of the rope and fold the it over to form interlocking bights.

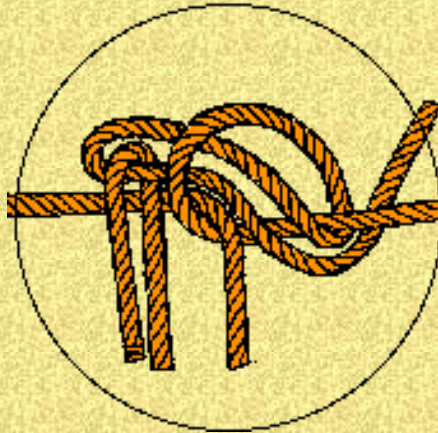

(7) Pull on the standing part so that the bight in the running part of the rope is pulled through the eye of the underhand loop and the underhand loop flips over and tightens around the bight to form a French Bowline.

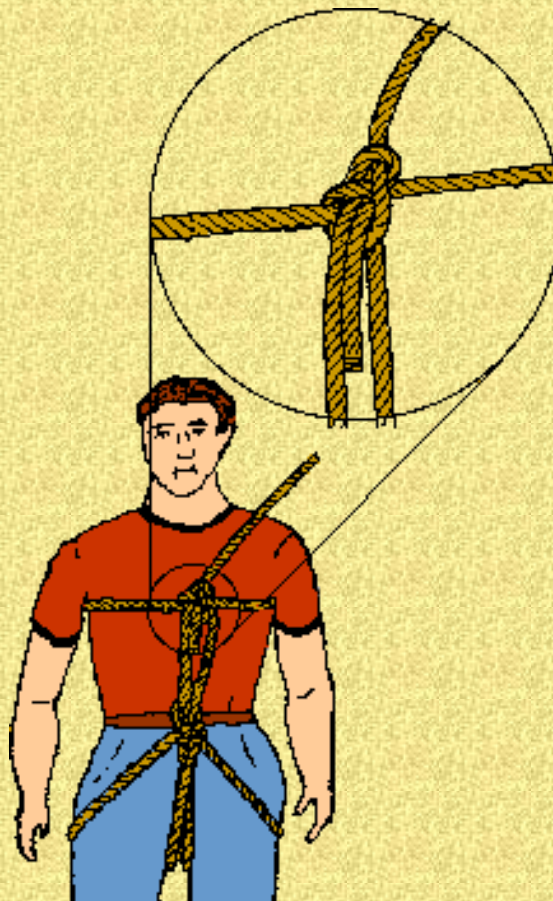

SPHERICAL KNOB COVERING

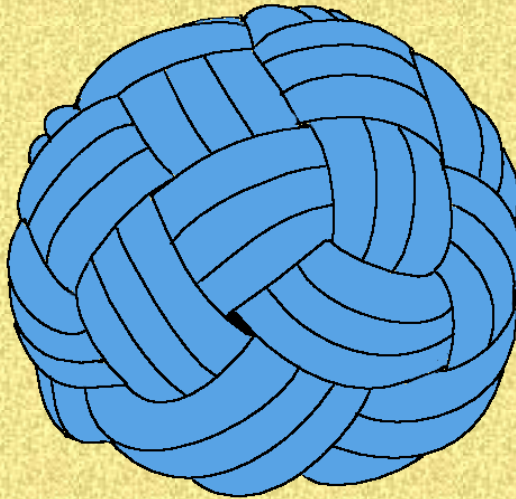

This knot is used to cover knobs. One example would be to cover a knob at the end of a walking stick.

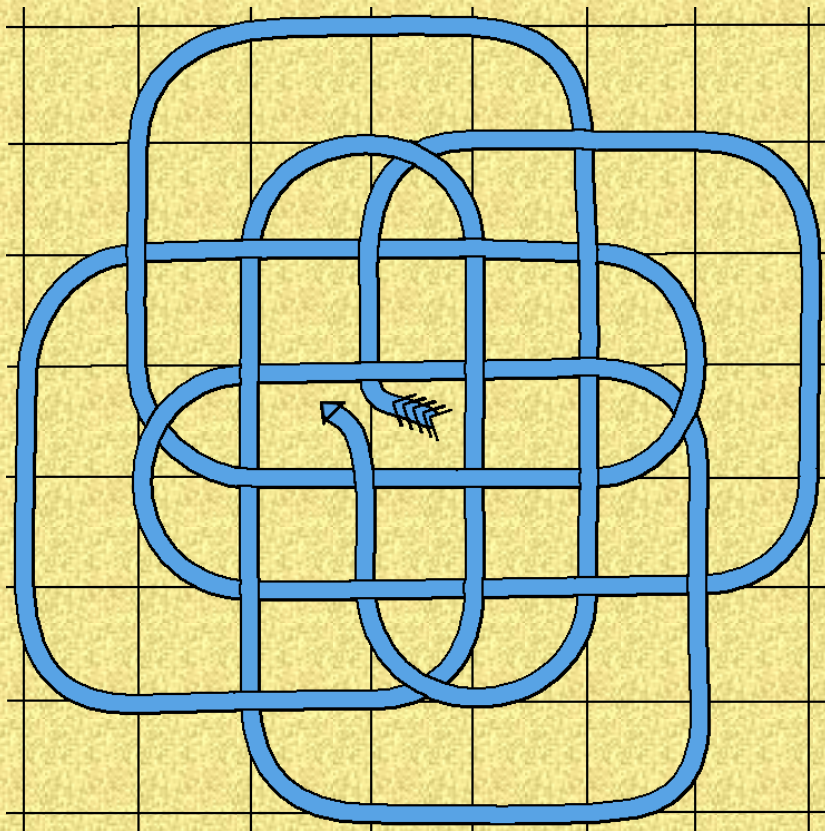

The length of cord needed to tie the knob covering knot depends on the size of the cord and the number of times the pattern is to be chased. A good length to start with is 8 times the circumference of the knob for each time the pattern is to be chased. [Example: a one inch knob has a circumference of a little over 3 inches. To cover a one inch knob it would require about 25 inches of cord for each time the pattern is chased. The pattern should be chased at least 2 times.

This means that about 50 inches of cord would be used to cover a 1 inch knob.

The knob covering knot is difficult to tie "in hand" the easiest method of tying it is to make a copy of the diagram and fasten the diagram to a work board. Start by pinning the middle of the cord to the feathered end of the arrow in the diagram. Then following the path indicated, pin the cord to the diagram. Be sure to follow the over/under pattern indicated in the diagram. Studying the following partial diagrams may help.

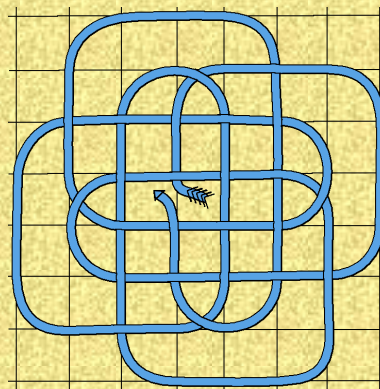
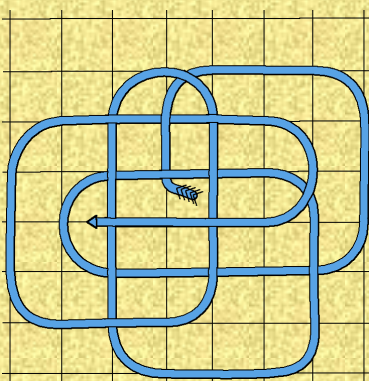
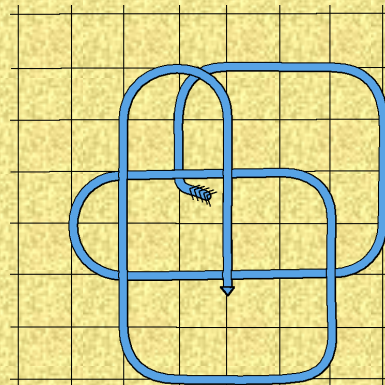
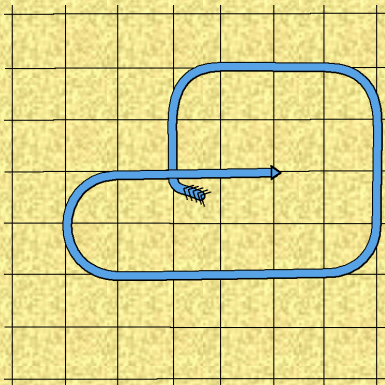

After the knot is tied on the work board unpin it and work it loosely into shape over the knob. Then chase the pattern the required number of times. Next work the knot tight around the knob. Do not rush this stage. When the knot is tight cut off the ends of the cord and push the ends into the knot.

To preserve the knot, it may be varnished or painted.

Walking Stick:

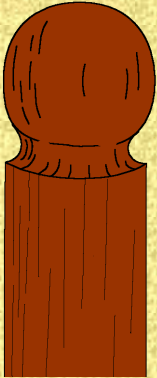

Carve a knob on the end of the walking stick.

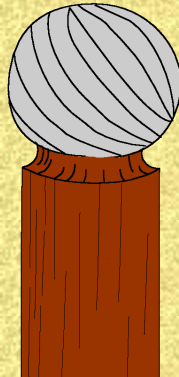

If desired, the size of the knob can be increased by wrapping it with tape.

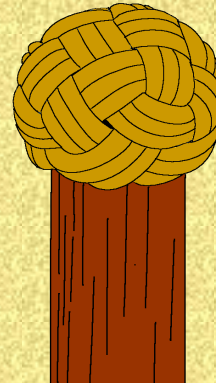

Tie the covering knot and work it tight over the knob.



CROWN KNOT:



Use ---- To tie of the end of a rope so that it does not unlay. ----- To begin a back splice. ---- As part of several multiple strand knots.

(1) Tie off the rope 6 complete lays from the end.



(2) Unlay the rope to the tied off point.

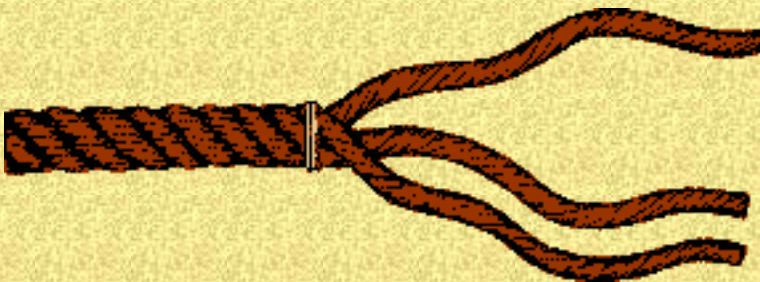

(3) Place the end of one of the unlayed strand between the other two unlayed strands;

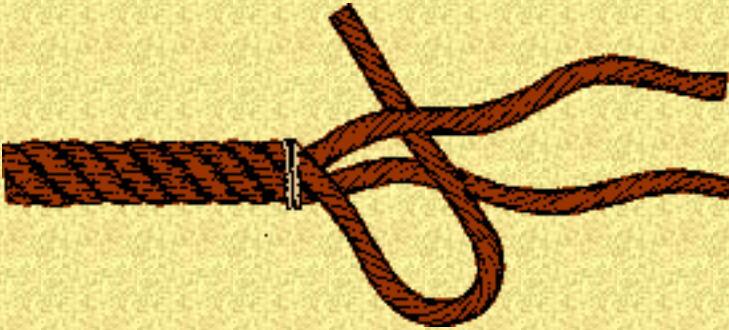

(4) press the strand firmly between the strands so that a loop is formed. [NOTE] As you are looking at the end of the rope work counterclockwise around the rope .



(5) Fold the second strand over the first strand. [NOTE] This will hold the loop in the first strand in place.



(6) Reeve the end of the third strand through the eye of the loop.



(7) Fold the third strand over the second strand. [NOTE] This will hold the second strand in place.

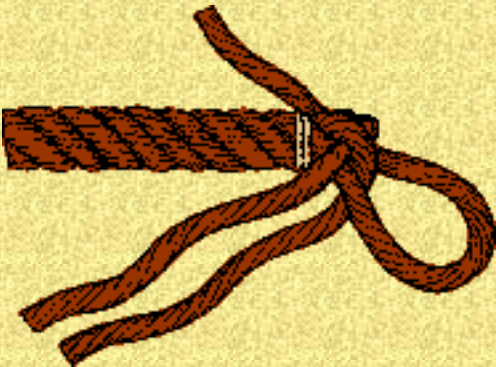

(8) Pull the loop closed. [NOTE] Work and pull all three strands until the knot is even and symmetrical.

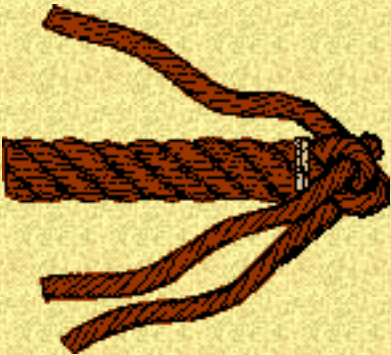

TABLE BORDER=0 CELLSPACING=0 CELLPADDING=0 LANG=en DIR=LTR
WIDTH="500" COLS="5">



WALL KNOT

Use ---- To tie of the end of a rope so that it does not unlay. ---- As part of several multiple strand knots.

(1) Tie off the rope 6 complete lays from the end



(2) Unlay the rope to the tied off point.

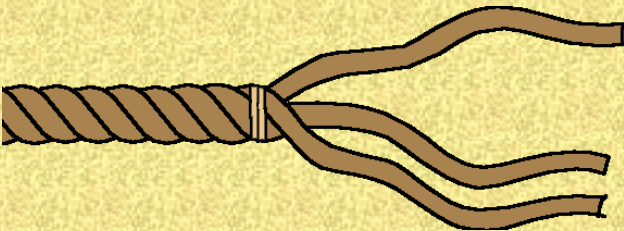

NOTE: work the knot in a counterclockwise direction as you look at the end of the rope.

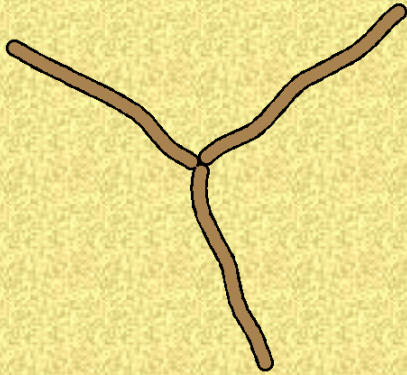

(3) Place the end of one of the unlayed strands under the strand to its left. (Hold the loop open as you work the knot).

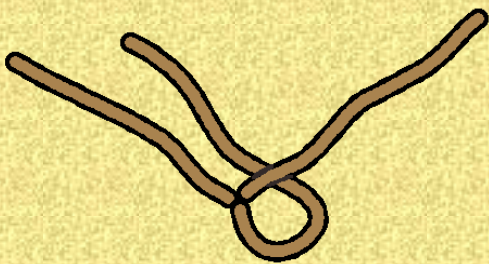

(4) Place the second strand under the first and third strand.

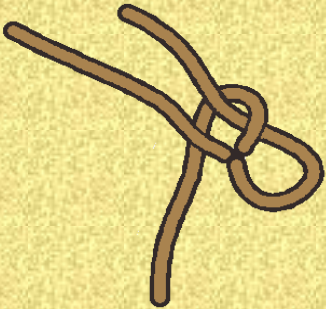

(5) Place the third strand under the second strand.



(6) Reeve the end of the third strand up through the loop formed in the first strand.

[A]



[B]

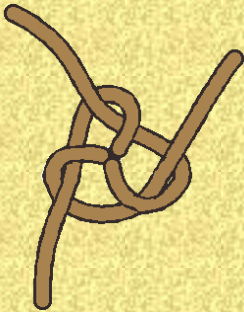

(7) work tight.

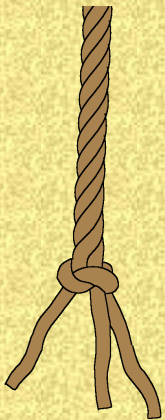



ALAMAR KNOT

The alamar knot is a decorative knot related to the pretzel knot. The pretzel knot is tied in a single strand; the alamar knot is tied by doubling the strands as shown in [Step 1]

[Step 1] Double the strand as shown.



[Step 2]

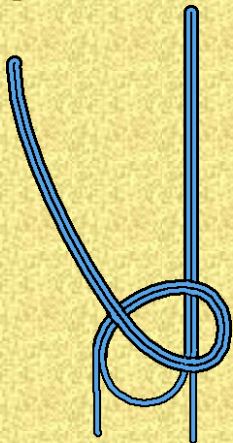

[Step 3]

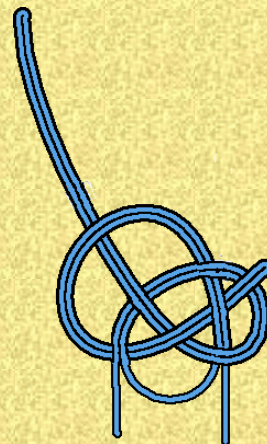
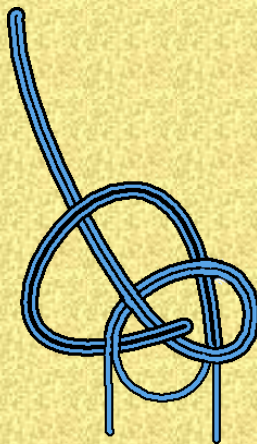
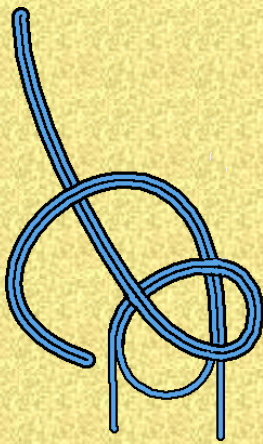

[Step 4]

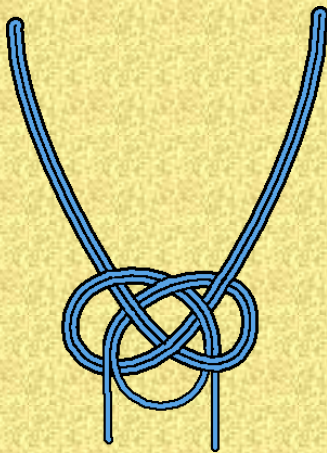

[Step 5] Add tassels or other end decorations.



TURK'S HEAD KNOT

RERUN ANIMATION

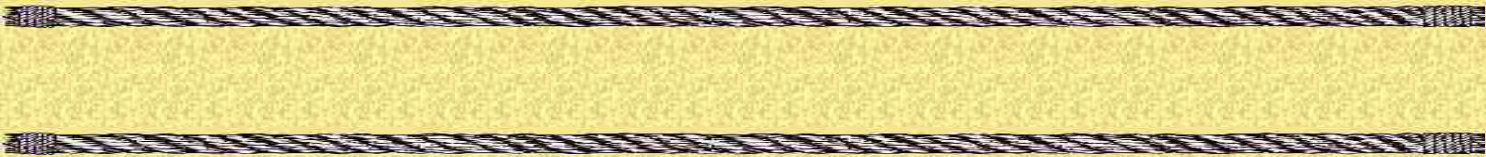
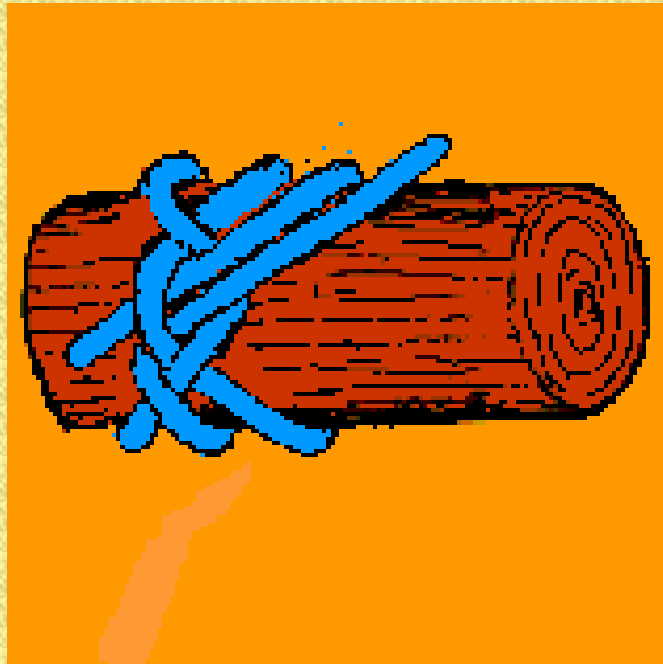

Home
E-Mail

BOATSWAIN'S WHISTLE KNOT

RERUN ANIMATION

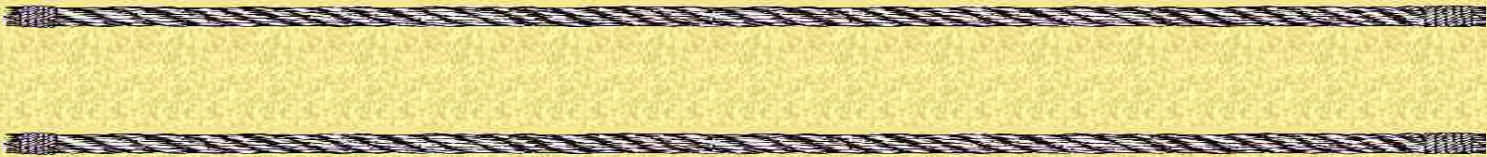
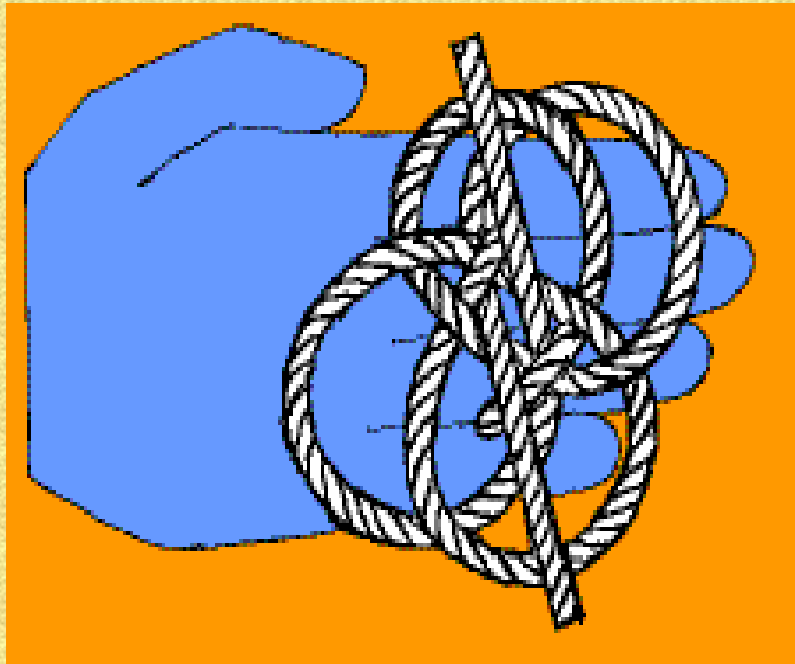

Home
E-Mail

CONSTRICTOR KNOT

RERUN ANIMATION

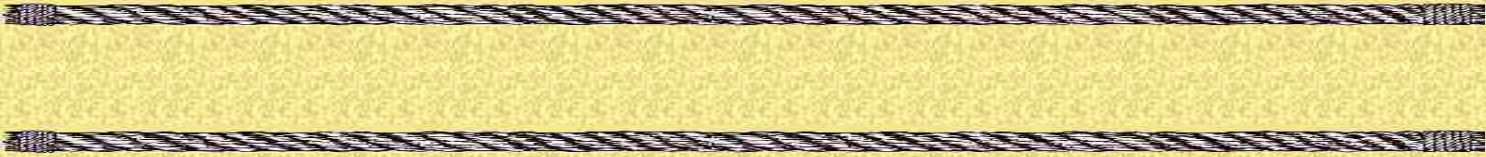
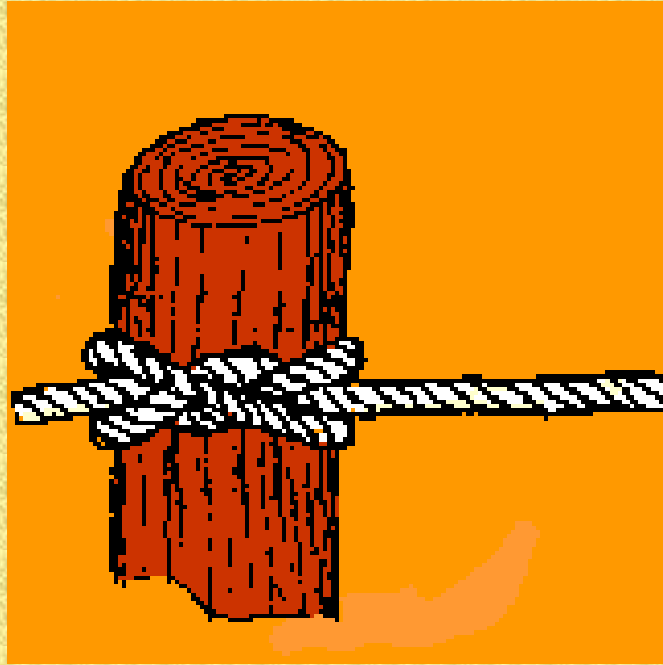

Home
E-Mail

MOORING HITCH

RERUN ANIMATION

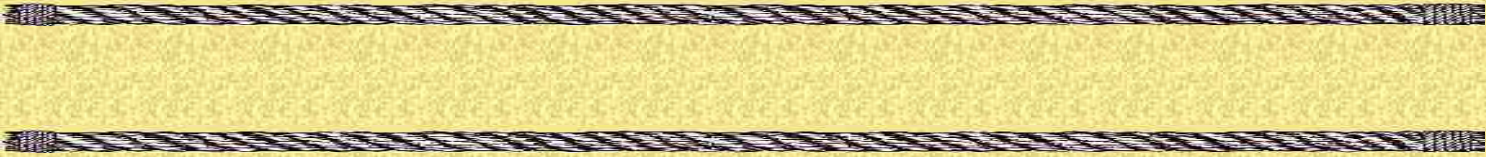
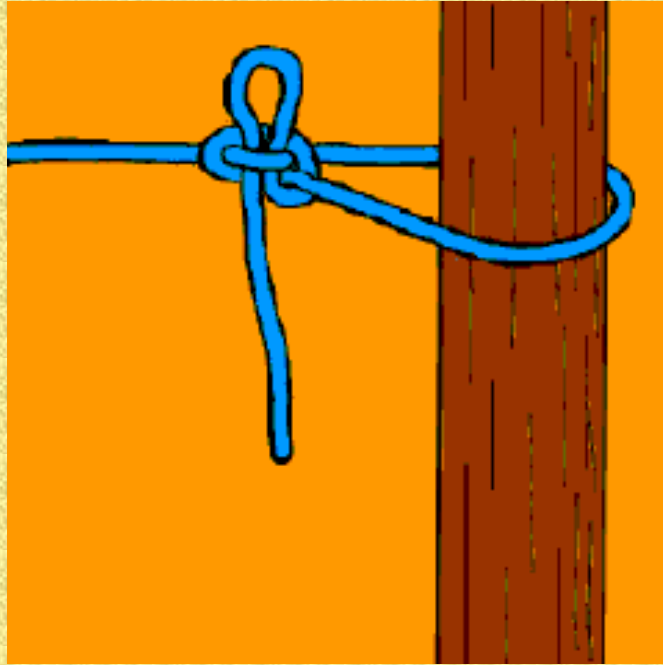

Home
E-Mail

BELAYING TO A CLEAT

RERUN ANIMATION

RUN ANIMATION WITHOUT TEXT

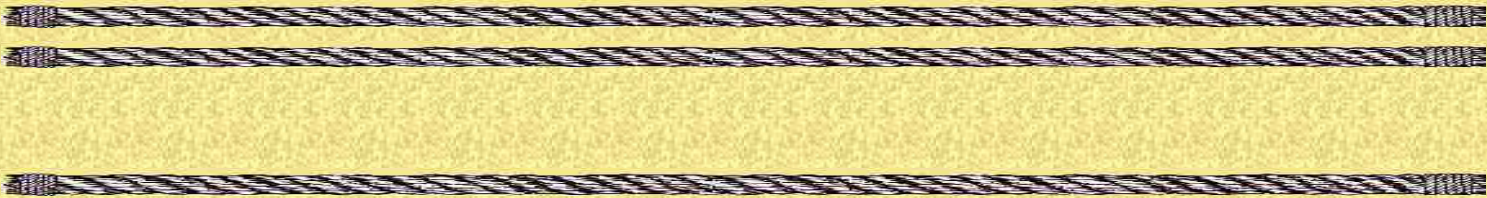
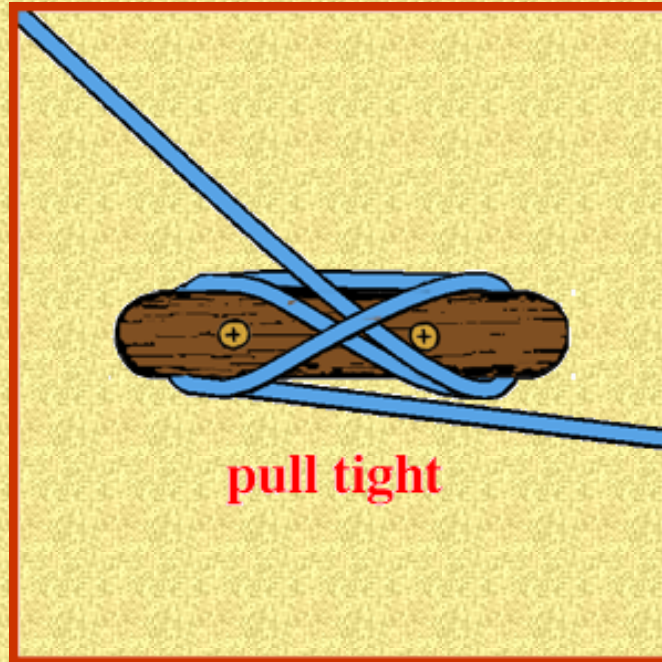

Home
E-Mail

FIGURE-EIGHT KNOT

RERUN ANIMATION

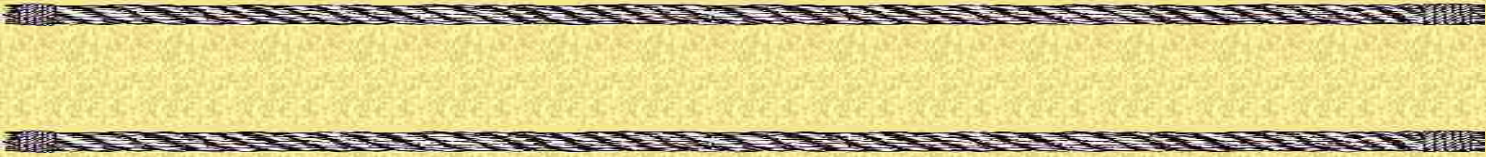
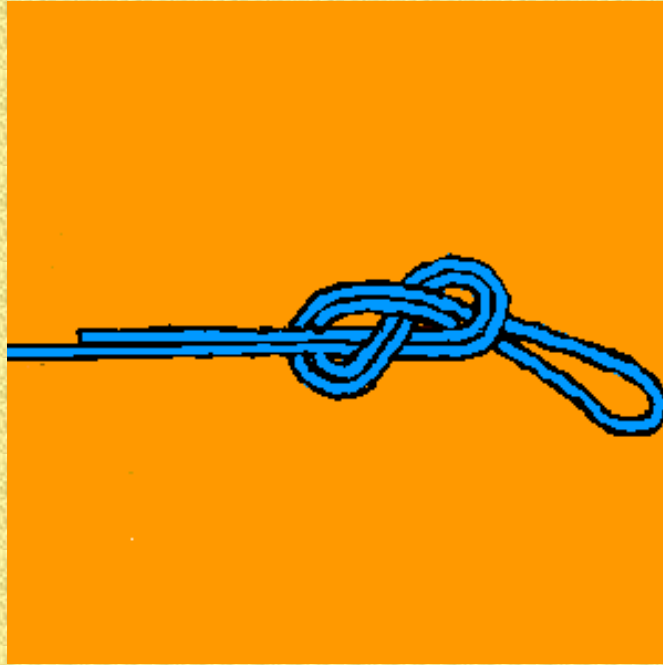

Home
E-Mail

WHIPPING

RERUN ANIMATION

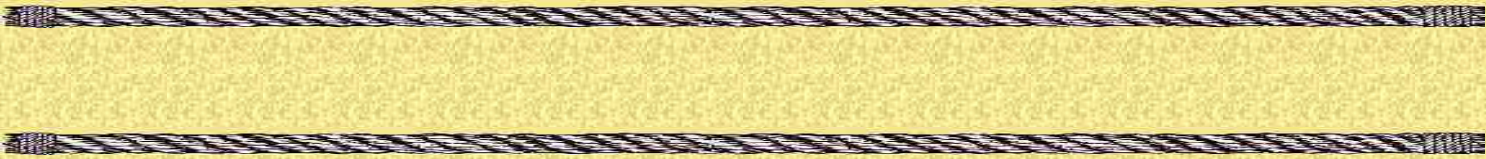
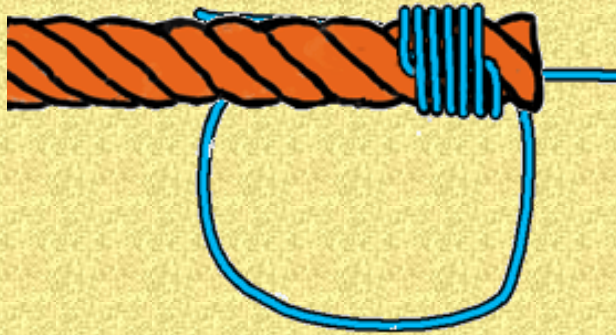

Home
E-Mail

BOWLINE

RERUN ANIMATION

form an overhand loop
pull tight

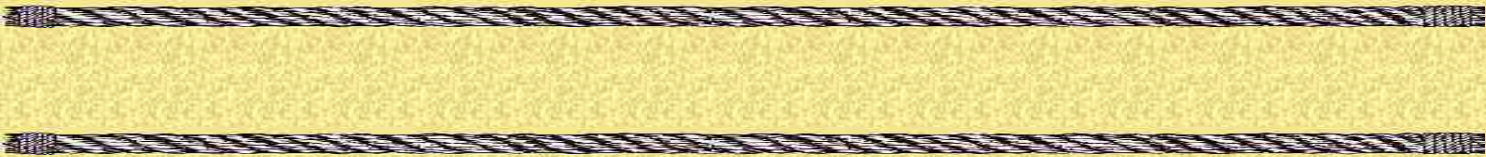

Home
E-Mail

BOWLINE ON A BIGHT

RUN ANIMATION WITH TEXT

RUN ANIMATION WITHOUT TEXT

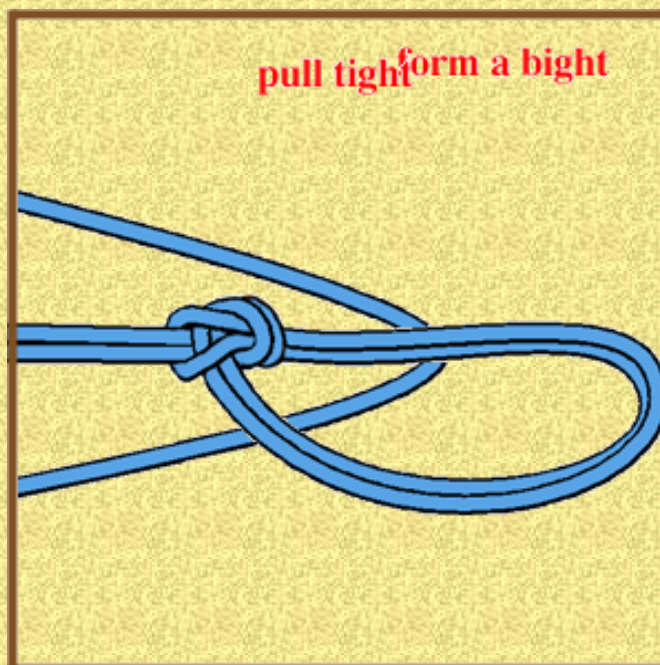

Home
E-Mail

CROWN KNOT

RUN ANIMATION WITH TEXT

RUN ANIMATION WITHOUT TEXT

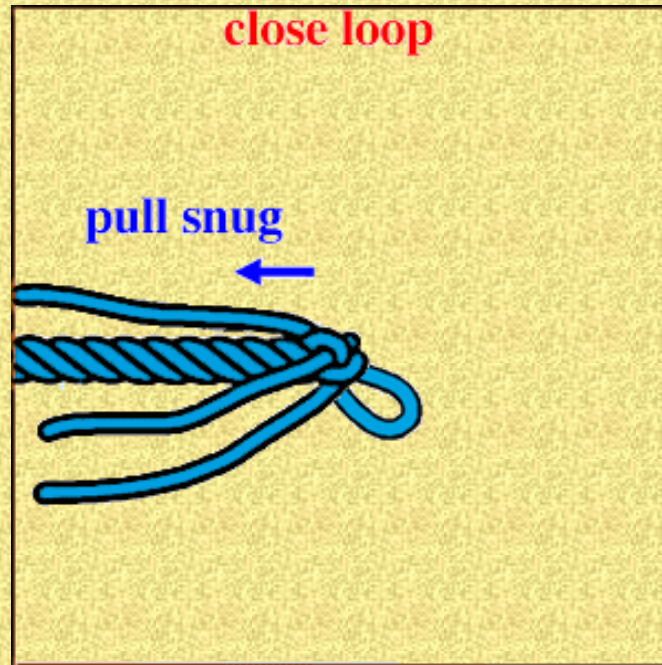

Home
E-Mail

[Skip navigation](#)



Products	Solutions	Support	Purchase	Company
--------------------------	---------------------------	-------------------------	--------------------------	-------------------------

- 
- [Search](#)
- [Contact Us](#)
-

Products

- [All](#)
- [Acrobat family](#)
- [Document Services](#)
- [Digital imaging](#)
- [Video and audio](#)
- [Web publishing](#)
- [Print publishing](#)

Solutions

- [Enterprise](#)
- [Government](#)
- [Adobe Studio](#)
- [Digital imaging](#)
- [Education](#)
- [Partners](#)

Support

- [Support main](#)
- [Downloads](#)
- [Training](#)
- [Forums](#)
- [Announcements](#)

Purchase

- [Adobe Store](#)
- [Your account](#)
- [Volume licensing](#)
- [Other ways to buy](#)
- [Customer service](#)

Company

- [About Adobe](#)
- [Press](#)
- [Jobs](#)
- [Investors](#)
- [Adobe Ventures](#)
- [Community](#)
- [Contact Adobe](#)

Adobe Reader

Download Adobe Reader

Thank you for your interest in [Adobe® Reader®](#) — free software for viewing and printing [Adobe Portable Document Format](#) (PDF) files. Created from applications like [Adobe Acrobat® 6.0](#), Adobe Photoshop® Album [photo software](#), and more, Adobe PDF files can be viewed on most major operating systems. Adobe Reader 6.0 is the newest version of the familiar Adobe Acrobat Reader software. It also replaces [Adobe Acrobat eBook Reader](#), software for viewing high-fidelity eBooks on your notebook or desktop computer.

IMPORTANT: Review the [system requirements](#) before downloading and installing Adobe Reader 6.0.

To distribute Adobe Reader software or place an "Includes Adobe Reader" logo on your printed material, [see details](#).

Step 1 of 2

Choose your language and platform. Your selection will determine the version of software that you will download.

Language

Platform

Step 2 of 2

The platform and language combination specified will determine the version of Adobe Reader that you will receive.

Full version: You will receive the full-featured version of Adobe Reader software. Recommended for broadband users.

Basic version: You will receive a compact version of Adobe Reader software without all available options. This version will transfer more quickly over dial-up connections.

By downloading software from the Adobe Web site, you agree to the terms of our license agreements. Please read the following license agreements before downloading:

[Adobe Reader license agreement.](#)

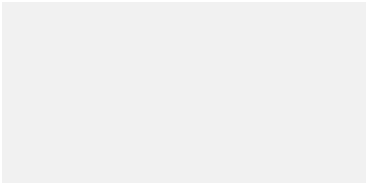

An accessible, [text-only Adobe Reader download page](#) is available if you are using a screen reader. [An Adobe Reader archive page](#) enables you to find and download an earlier version of Adobe Reader.

Copyright © 2004 Adobe Systems Incorporated. All rights reserved.

- [Terms of Use](#)
- [Privacy Policy](#)
- [Accessibility](#)
- [Avoid software piracy](#)
- [Permissions and trademarks](#)
- [Product License Agreements](#)





BOWLINE ON A BIGHT:

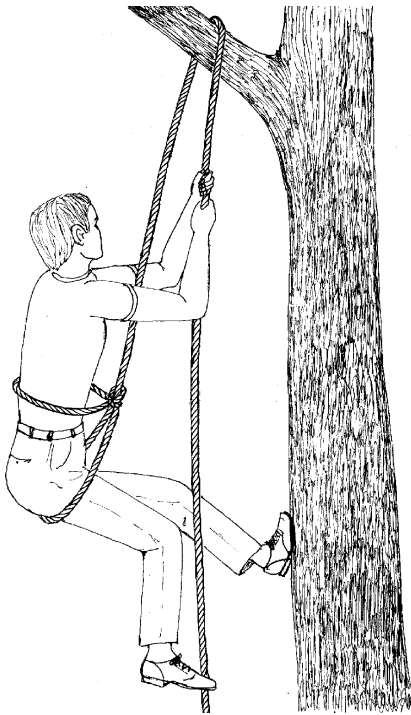

Description ---- A double loop bowline Tied by interlocking a doubled half hitch and a bight.

Use ---- As a nonslip double loop; as a loop anywhere along the length of a rope; as secure loop for rescue work; as the start of a life basket harness; as an emergency boatswain chair.

Comments ---- The bowline on a bight is a secure double loop that can be tied anywhere along the length of a rope. Several can be used as "dead eyes" for tightening a rope when securing a load or guy line.

Narration ---- (For **bowline on a bight** knot-board.) (1) Take a bight in the rope. (2) Using the bight as the running part, make a double strand overhand loop. (3) Take the running part under the overhand loop. This forms a double strand bight that will become the eye of the knot. (4) Reeve the running part through the eye of the overhand loop. (5) Spread the eye of the running part (bight). (6) Pull the running part (bight) through the overhand loop

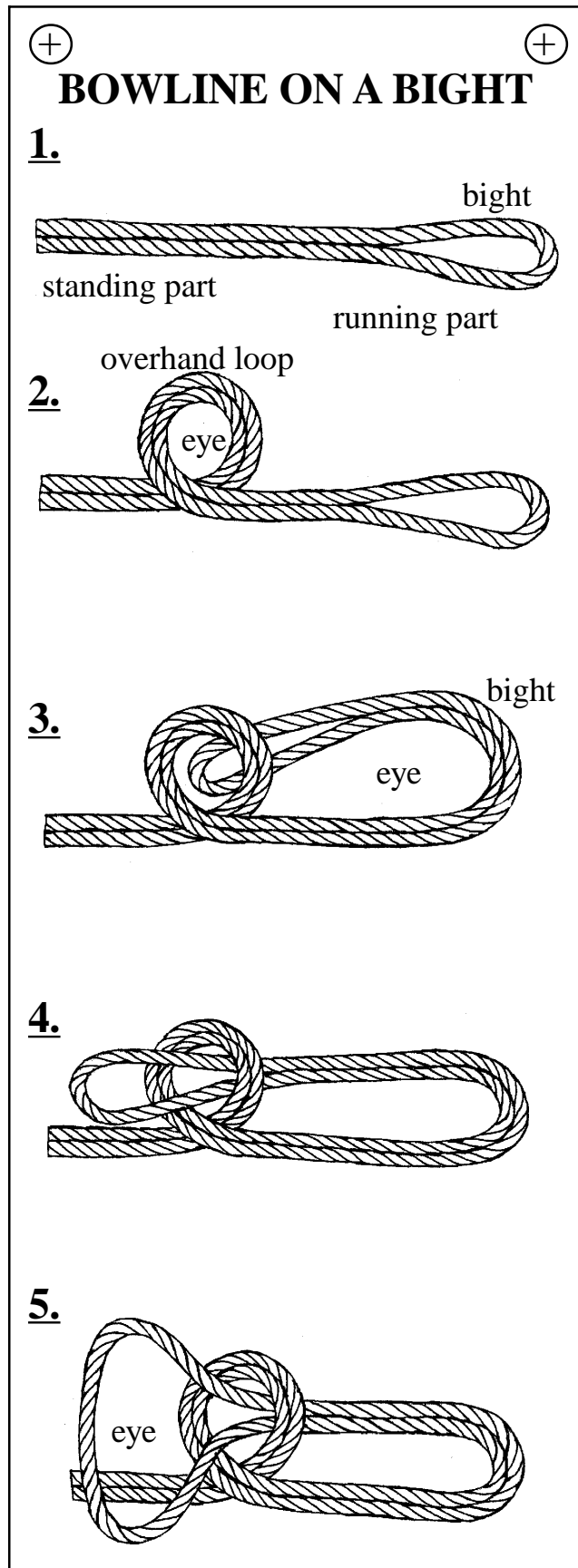



6.

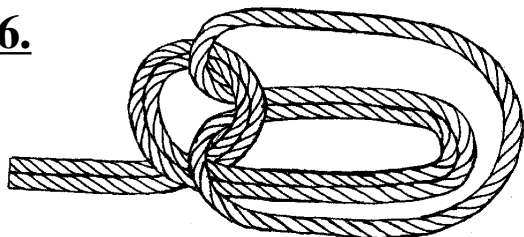

7.

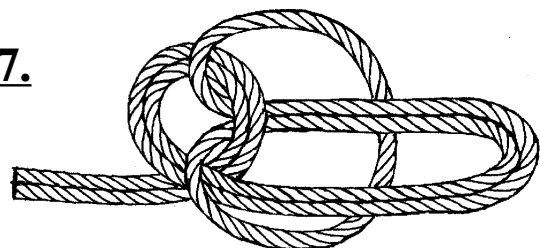

8.

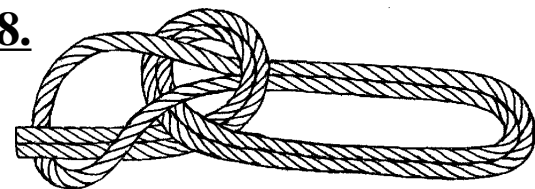

9.

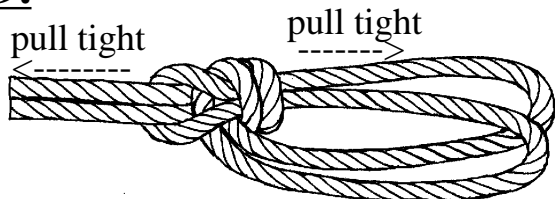

(back)

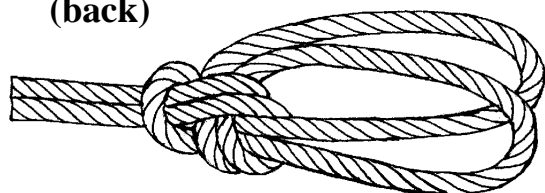

until you can enlarge it enough (7) to pass it over the double strand bight. (8) When the eye of the running part (bight) is around the standing part, (9) Grasp the double loop bight and the standing part and pull the knot tight.

[NOTES]



CLOVE HITCH:

Description — Two single hitches (half hitches) tied in the same direction around an object.

Uses — To secure a line to a post or pole; to start and end most lashings.

Comments — Can be untied (spilled) by pulling on the standing part so that it rotates the cross point in the knot until it goes over the end of the rope.

The length of the standing part can be adjusted by rotating the loops of the knot around the pole. To shorten the standing part, pull on the running end so that it rotates the cross point toward the standing end. To lengthen the standing part, pull on the standing part so that the cross point is rotated toward the running part.

Because the clove hitch can be spilled by rotating the standing part against the cross point, the clove hitch will spill itself if it is tied so that standing part moves back and forth in such a way that it cause the loops of the knot to slide around the pole. To prevent the clove hitch from spilling, 'stop' it by tying two half hitches around the standing part.

STOPPED CLOVE HITCH

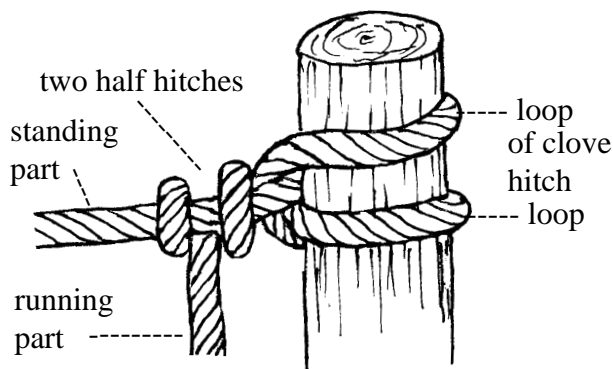

When under constant tension the clove hitch has little tendency to slide along the length of the pole even if the tension is nearly parallel to the pole.

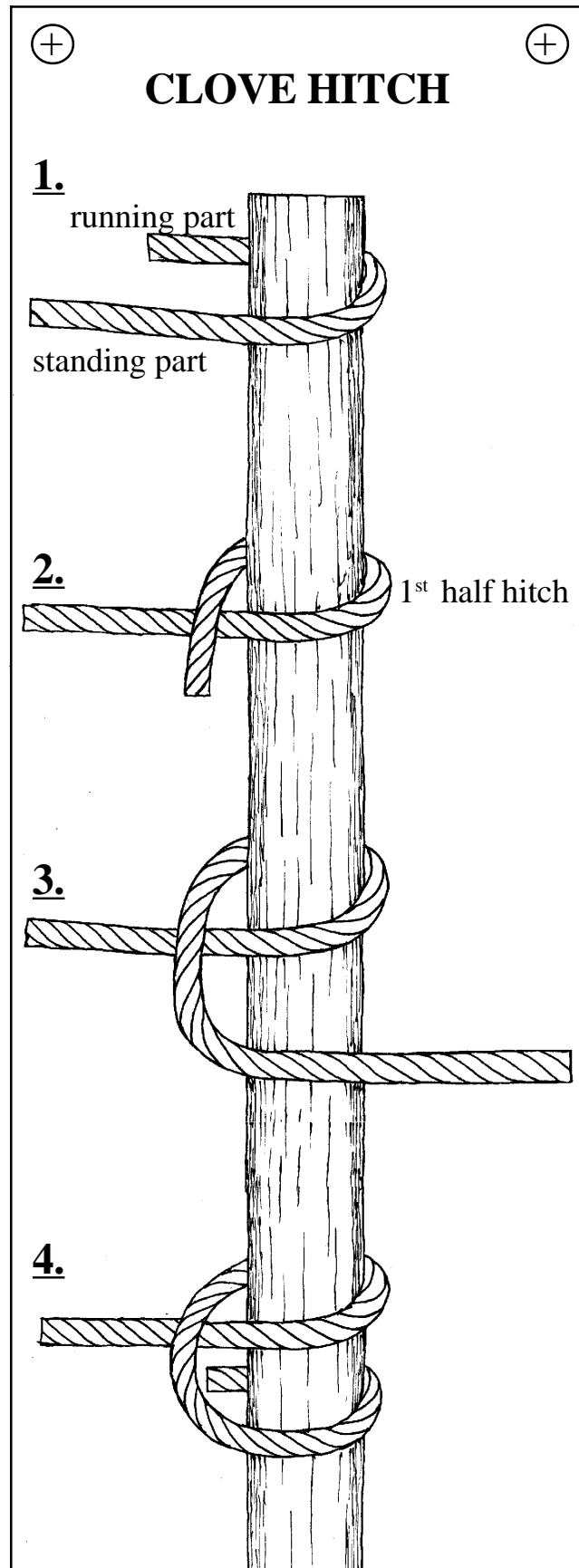

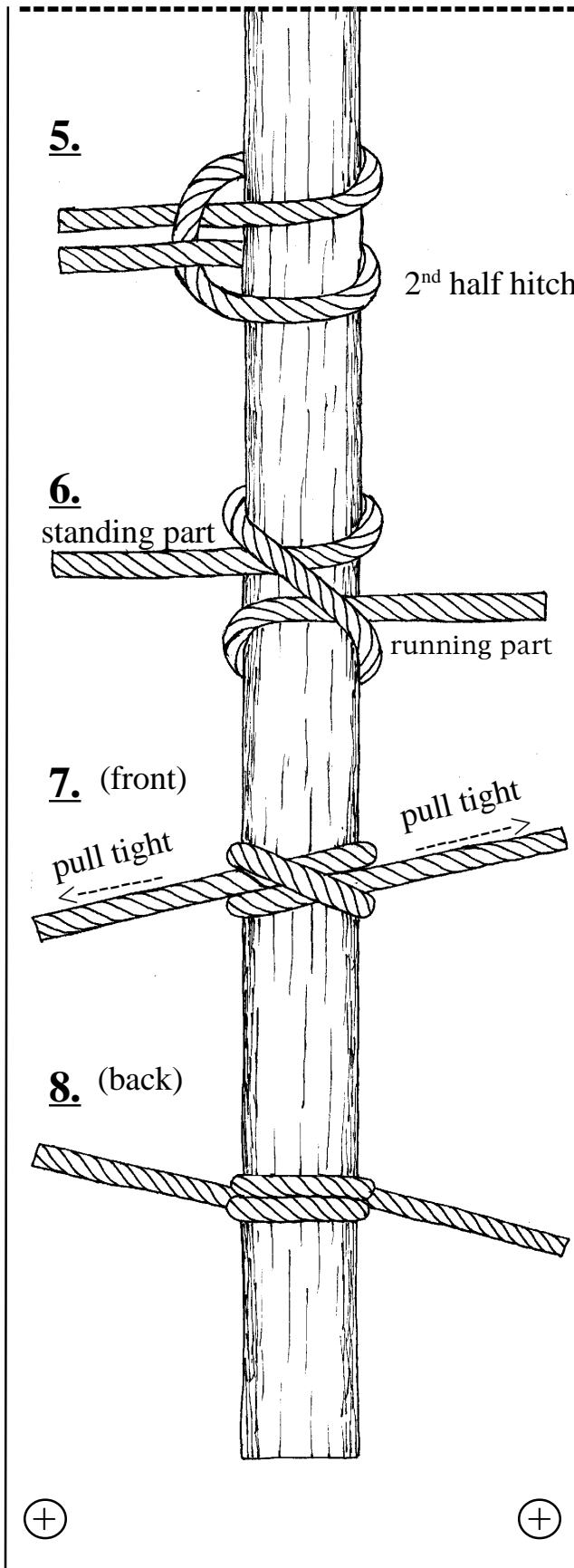

Narrative ---- (For **clove hitch** knotboard.) (1) Start the clove hitch by taking a bight around an object with the running part. (2) Cross the running part over the standing part to form a half hitch. (3) Start the second half hitch by continuing to wrap the standing part around the object in the same direction as the first half hitch. (4) Form a second bight around the object. (5) Finish the second half hitch. (6)&(7) Grasp the standing part and the running part: pull tight the clove hitch tight.

CLOVE HITCH; OVER AN END:

A clove hitch can be tied over the end of a pole or stake by using this method.

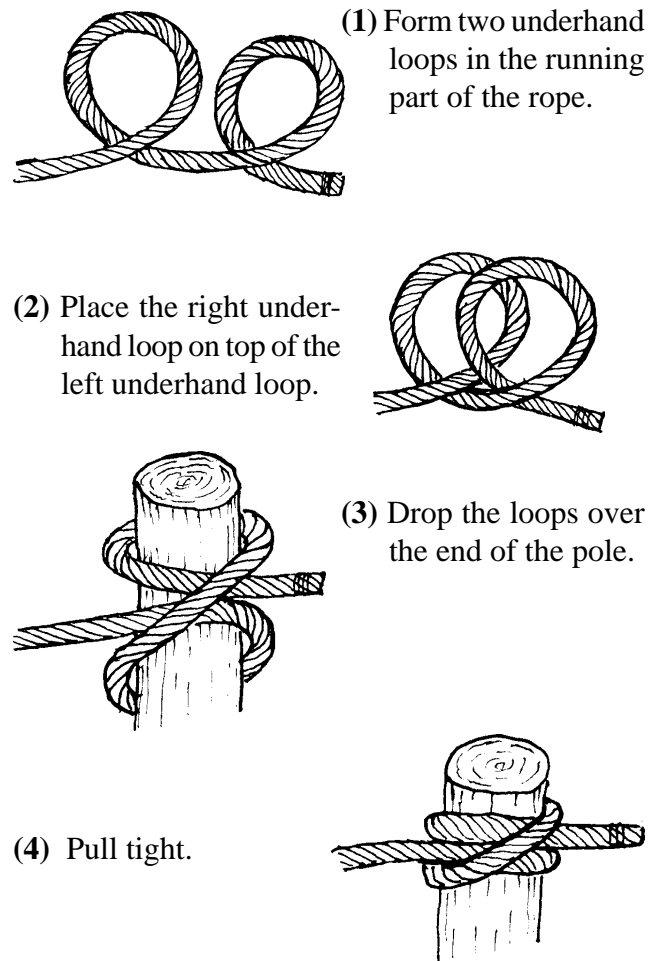



SQUARE LASHING:

Use ---- To bind poles that are in contact and cross each other at any angle from 45° to 90°.

Comments ---- The square lashing gets its name from the fact that the wrapping turns are at 90° or "square" to the poles.

Traditional square lashing is the most frequently used and the most secure form of lashing. If tied properly, the square lashing will remain tight and secure, but, as with all lashings, if any steps are omitted or done carelessly, the lashing will loosen and create a dangerous situation.

The square lashing can be used to bind poles together that cross and contact each other at any angle from 45° to 90°. If the angle of contact is greater than 45°, a shear lashing should be used.

When tying a square lashing, the poles and the rope must be positioned properly to achieve the maximum strength. The cross pole should

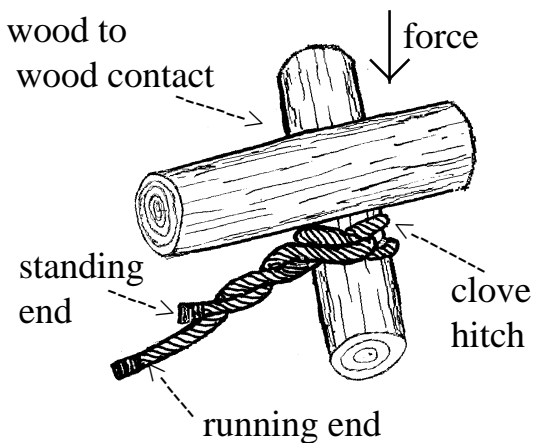

be positioned so that the force applied to the cross pole is directed toward the pole it is lashed to; this allows the wood-to-wood contact to bear part of the load; if the force tends to separate the poles, only the rope will be supporting the load. The beginning clove hitch should be tied to the pole that is closest to parallel to the direction of the force and to the side of the cross pole that is opposite to the direction of the force.

In most cases the force applied to a structure is due to gravity, therefore downward, this means that the beginning clove hitch is usually tied to the vertical pole, and under the cross pole. The standing end of the rope is secured by wrapping it around the running end.

Narration ----- (For square lash knotboard.)

(1) Tie a clove hitch to the vertical pole. (2) Wrap the standing end of the rope around the running end [NOTE] The wrapping of the standing part around the running part is to secure the clove hitch so that it will not slip around the pole and loosen the lashing from the inside. (3) Bring the running end up and over the cross pole; then around the vertical pole; and back down over the cross pole. (4) Pass the rope behind the vertical pole and back up in front of the cross pole; this completes the first wrapping. [NOTE] Notice that the rope goes around the pole perpendicular, at 90° to the length of the pole. This 90° angle gives the square lashing its name. (5) Take two more wrapping turns for a total of three wrappings: pull each turn tight. [NOTE] When the wrappings are taken around the vertical pole the rope should be to the inside of the previous wrapping turn; and the wrappings around the cross pole should be to the outside of the previous wrapping turn. When this pattern of taking the wrapping turns is followed the rope strands remain parallel; this insures the maximum contact between the wood and the rope. Also if the strands are not kept parallel, the additional friction between the crossed strands will make it difficult to properly tighten the wrapping turns. (6) Start the wrapping turns by taking one

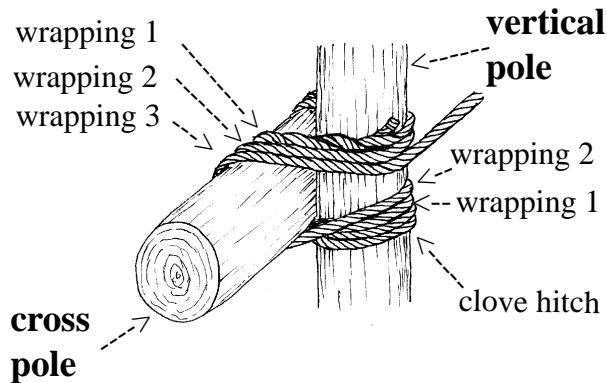



complete turn around the cross pole; [NOTE] The turn around the cross pole prevents the rope from crossing the wrapping turns on a diagonal. If the change of direction between the wrapping turns and the frapping turns is made by passing the rope diagonally across the wrapping turns, the increased friction between the rope strands will make it difficult to pull the wrapping turns tight. A diagonal across the wrapping turns will also allow unnecessary movement within the completed lashing, which could cause chaffing of the rope. (7) Take at least two frapping turns; keep the turns parallel to each other; pull each turn tight as it is made. [NOTE] Keeping the frapping turns parallel prevents unnecessary friction between the turns making it easier to tighten the frapping turns. (8) When the last frapping turn is in place, take a half hitch around the cross pole, work the half hitch tight. [NOTE] To prevent the rope from crossing the wrapping turns diagonally when tying the half hitch, take the rope past the cross pole on the same plain as the frapping turns, then around the cross pole. [NOTE] To work the half hitch tight, first pull the running end toward the standing end. This will tighten the frapping turns. Next, while

keeping tension on the running end pull it in the opposite direction so that the loop of the half hitch will slip around the pole. This takes up any slack left in the rope. Work the running end back and forth in this way until the half hitch is locked tight against the lashing. If this half hitch is not locked against the lashing the ending clove hitch can slip around the pole allowing the lashing to loosen. (9) Add a second half hitch to form a clove hitch around the cross pole; work half hitch tight.

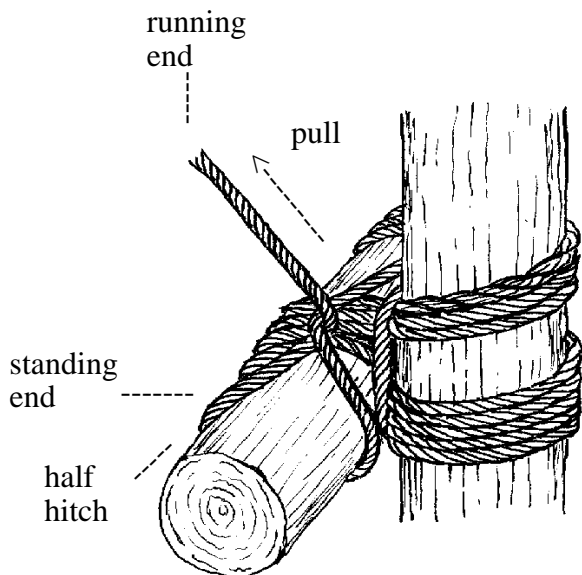
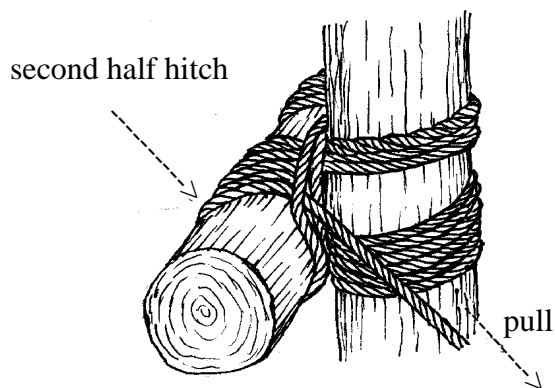

[NOTE] If smooth rope is being used a third half hitch added to the clove hitch will help insure that the lashing will stay securely in place.



+

+

SQUARE LASHING

1.

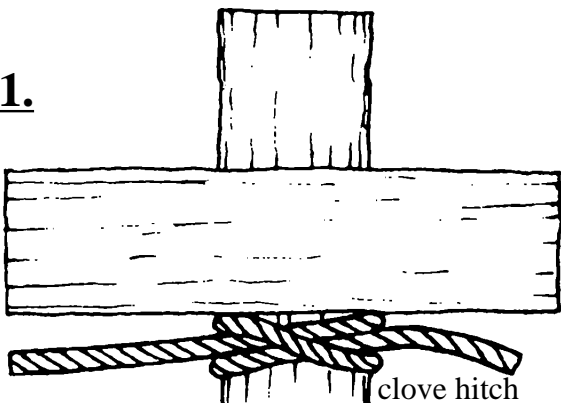

2.

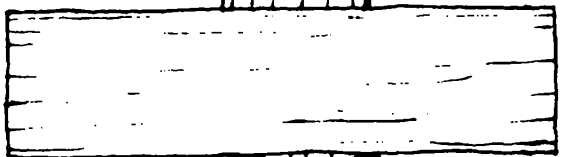

3.

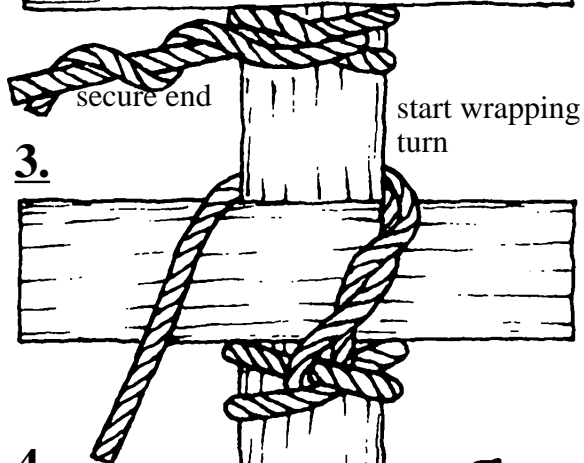

4.

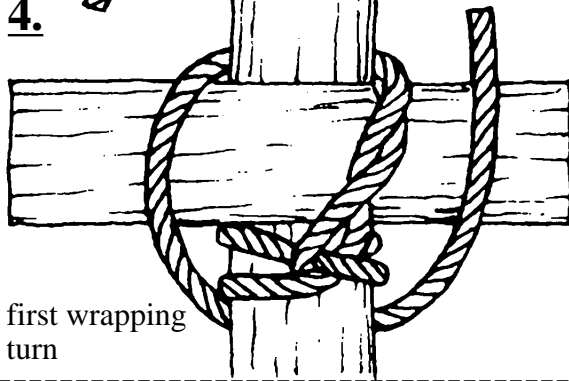

5. make 3 wrapping turns

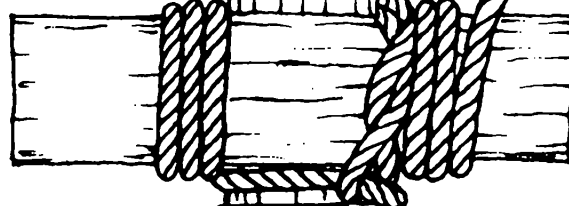

6. first frapping turn

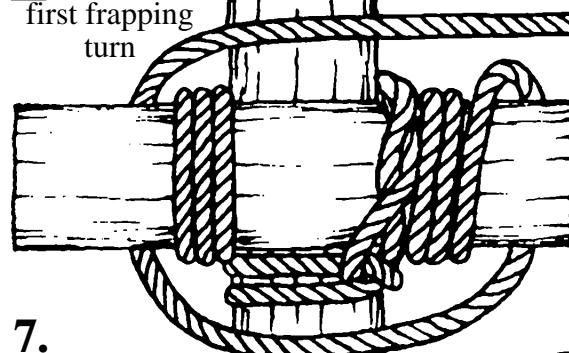

7. make 2 frapping turns

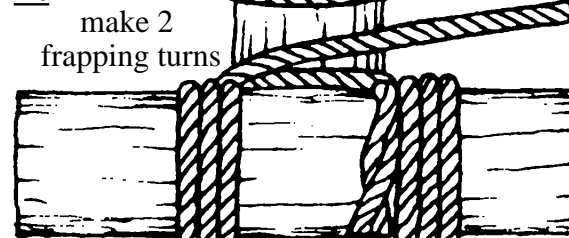

8.

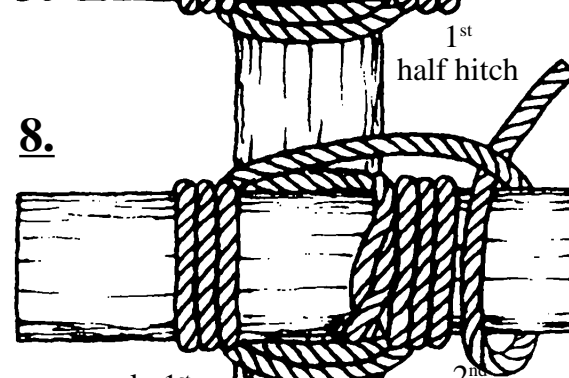

work 1st half hitch tight

9.

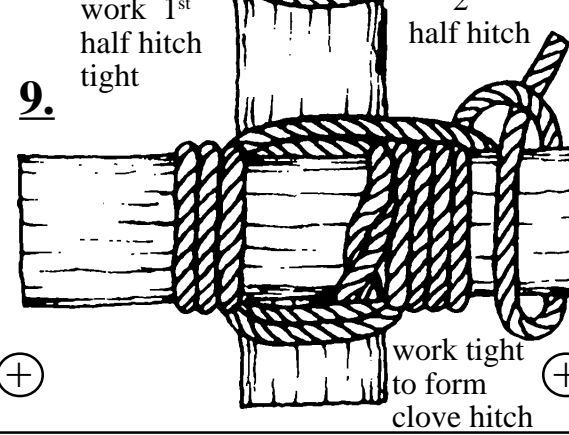

+

+



EYE SPLICE:

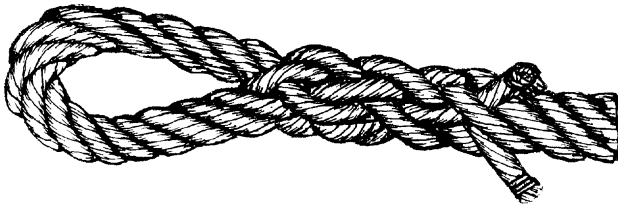

Use ---- To form a permanent loop or eye in the end of a rope.

Comments ---- The loop formed by a well made eye splice maintains 85% or more of the original strength of the rope; this makes the eye splice the preferred way to form an permanent loop in the end of a rope. However if the eye is to be subjected to repeated chafing, such as a rope being pulled through it, the eye should be serviced with a wear resistant twine.

Narration ---- (For eye splice knotboard) (1)&(2) Count back and unlay 5 rounds of the lay of the rope. (3) Fan the unlaid end of the rope and place it over the standing part of the rope. The strand to the inside of the eye must look like it is coming out from under the other two strands and the other two strands must be fanned in such a way that they do not cross each other. (4) While holding the inside strand in place, stick the middle strand under one of the strands of the standing end of the rope. (5) While holding the inside strand in place, stick the inside strand under the other two strands of the standing end of the rope.

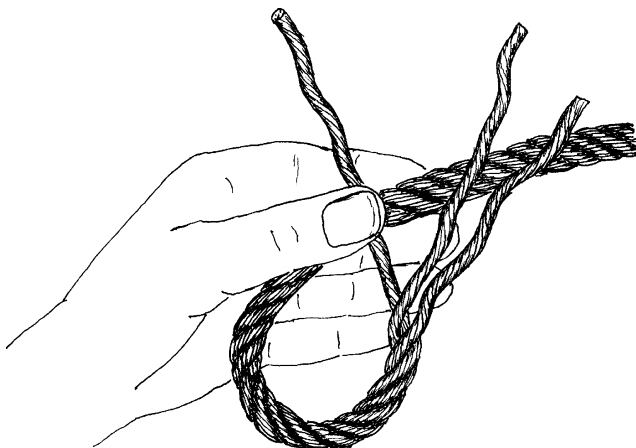

EYE SPLICE

1.
1 2 3 4 5

2. unlay

3. fan end

4. stick middle strand

5. stick inside strand



6.

rotate

1/2

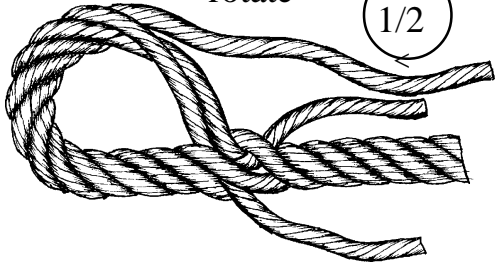

7.

stick third strand

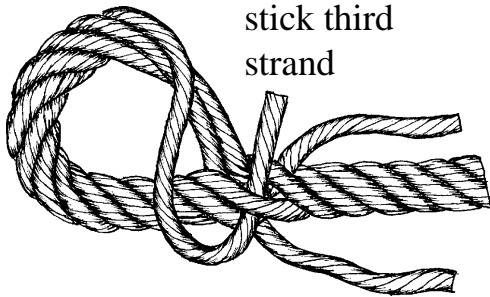

8B.

back

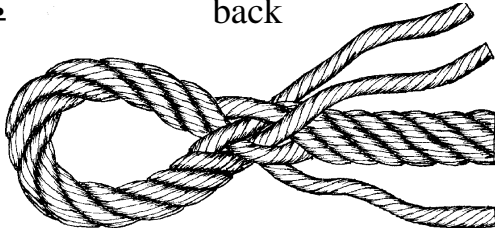

8F.

front

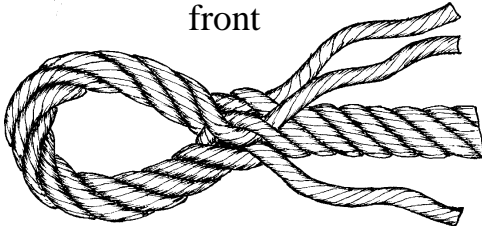

(5) Pass the inside strand over the standing end strand and stick it under the next standing end strand. [NOTE] The second strand goes in where the first strand came out. (6) Turn the splice over. (7) Stick the third strand under the remaining strand of the standing end. [NOTE] The third strand is stuck in where the second strand came out and comes out where the first strand went in. [NOTE] When the third strand is stuck it appears to go backward but when it is examined closely you will see that it is stuck in the same direction as the other two strands. (8B) & (8F) Complete the splice by working the strands snug and adding 3 to 5 50unds of tucks.

[NOTE] When the strands are folded back over the eye, you will notice that there is one strand going in and one strand coming out between each of the strands of the standing end.

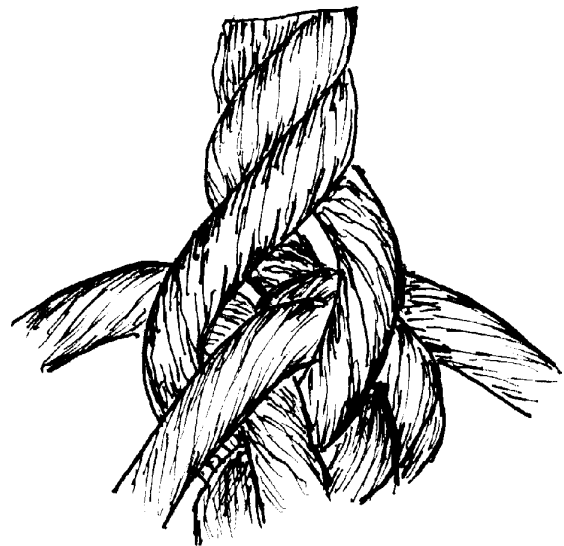



TURK'S HEAD:

Description ---- Three strand braid worked in a continuous circle.

Use ---- (1) As a decorative knot around a staff or railing. (2) Worked tight around a checked or cracked tool handle or canoe paddle to reinforce them. (3) As a neckerchief slide or wogal.

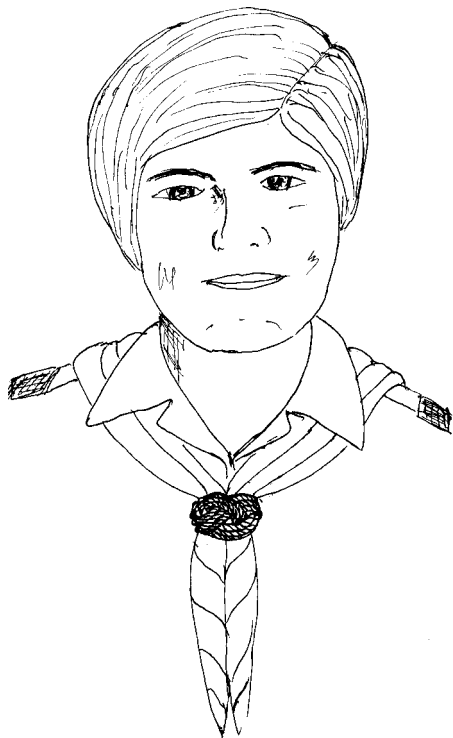
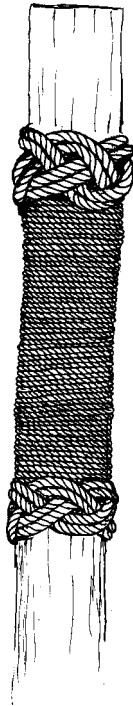

Comments ---- The form of Turks head shown here is a five crown Turk's head, this is only one of a group of knots that go by the name Turk's heads.

The crown number is determined by counting the number of bights at the edge of the knot. To make a larger loop, increase the size of the wraps made in steps 1 - 4 and then, at step 7 use three strand braiding to increase the number of crowns. The number of crowns can be increased by increments of three; so that the number of crowns in a larger loop can be 8, 11, 14, etc..

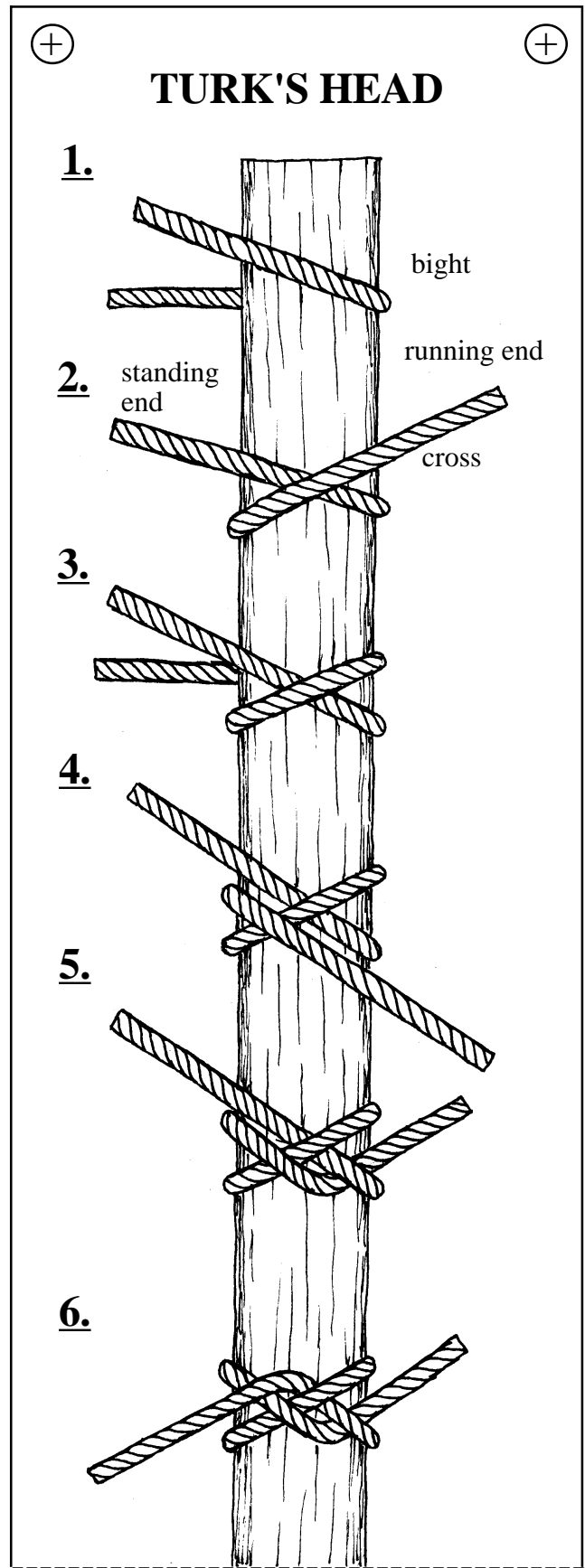

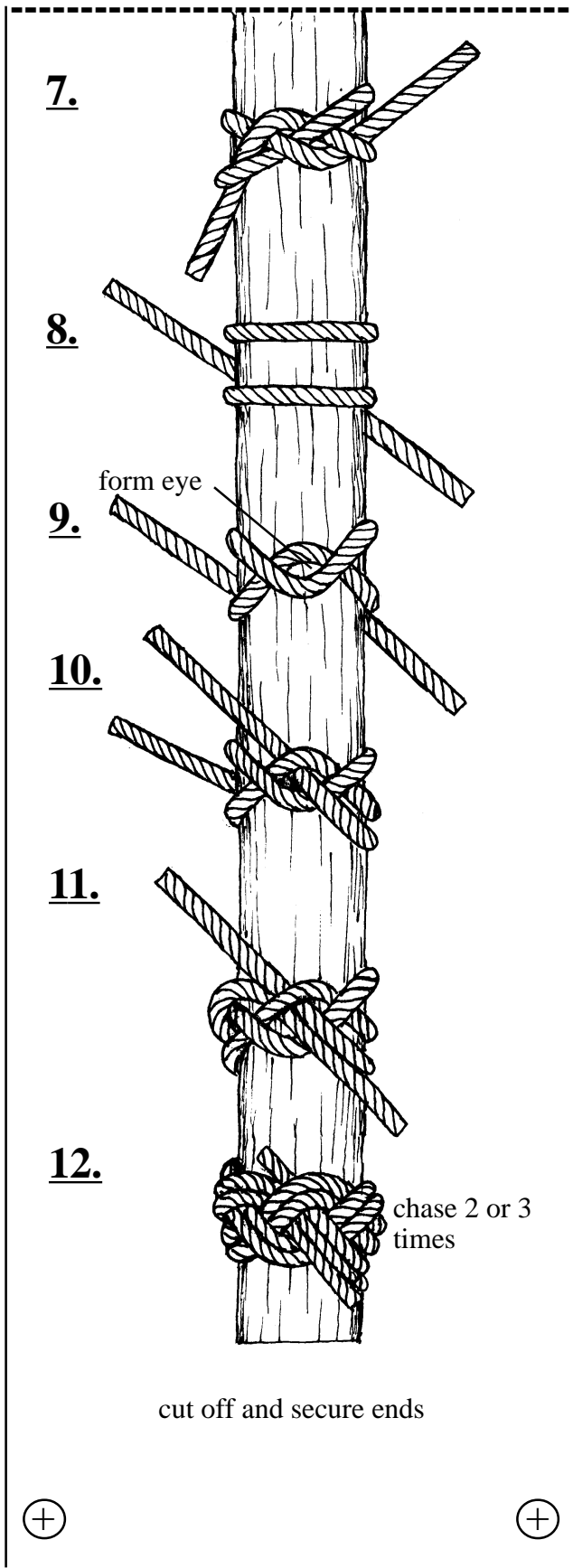

The size of the finished Turk's Head depends on the size of the rope used and the number of times the strand is chased.

Other Names ---- Three lead by five bight Turk's head, ordinary Turk's head.

Narration ----- (For Turk's head knotboard.)

(1) Start at the center of the line, by taking a bight around an object (the fingers of the left hand work well) (2) Complete the round turn and cross the running end over the standing end. (3) Take a second bight around the object so that the running end is between the standing end and the first wrap. (4) Lay the running end across the first wrap then (5) tuck the running end under the standing end. (6) lay the standing end across the second wrap and (7) tuck it under the first wrap. (8) rotate the knot around the object so that you are looking at the opposite side. (9) Cross the second wrap over the first wrap. (10) Reeve the standing end through the eye formed between the two wraps. (11) Reeve the running end through the eye between the two wraps so that the ends are in opposite directions. (12) Chase, follow, the strand of the knot two or three times. Cut off and secure the ends.

[NOTE] To determine the length of line to use, wrap the line around the object four times for a single strand knot. Add three and one half wraps for each time you intend to chase the original strand.



RINGBOLT HITCHING:

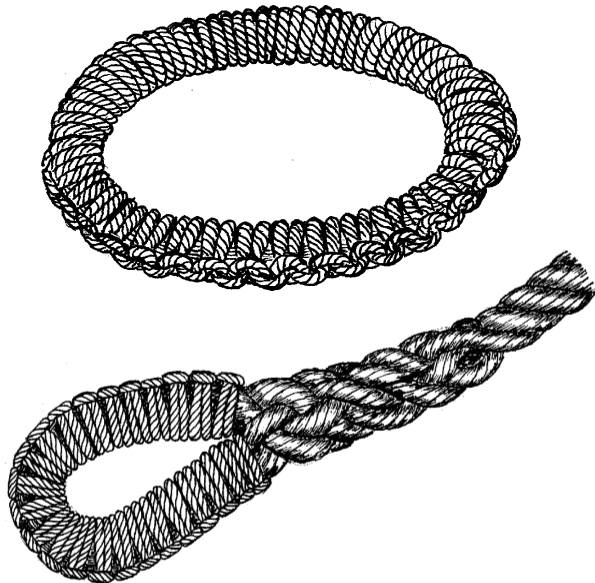

Description ---- A series interlocking lark's head knot that form a ridge around the outside of a ring or loop.

Use ---- To prevent chafing; as a decoration.

Comments ---- There are many forms of ringbolt hitching, the form shown here is one of the simplest and does not require the use of a needle as many other forms do. Ringbolt hitching was used to prevent chafing of ropes that were reeved through hand forged iron rings and to keep them from clanging against objects around them. In the present, ringbolt hitching can be used to protect synthetic ropes that are easily chafed by a applying a layer of material that is not easily chafed.

Other Names ---- Platted Ring; Hog Backing; Cockscombing.

Narration ----- (For ringbolt hitching knotboard.)
 (1) Start the ringbolt hitching by tying a half knot around the object. (2) Tie a half hitch around the object so that the standing end is trapped under the half hitch. (3) pull the half hitch tight. (4) Tie the next half hitch in the opposite direction around the object. (5) Pull the half hitch tight. (6) Tie another half hitch in the opposite direction around the object; the same direction as the first half hitch. (7) Pull

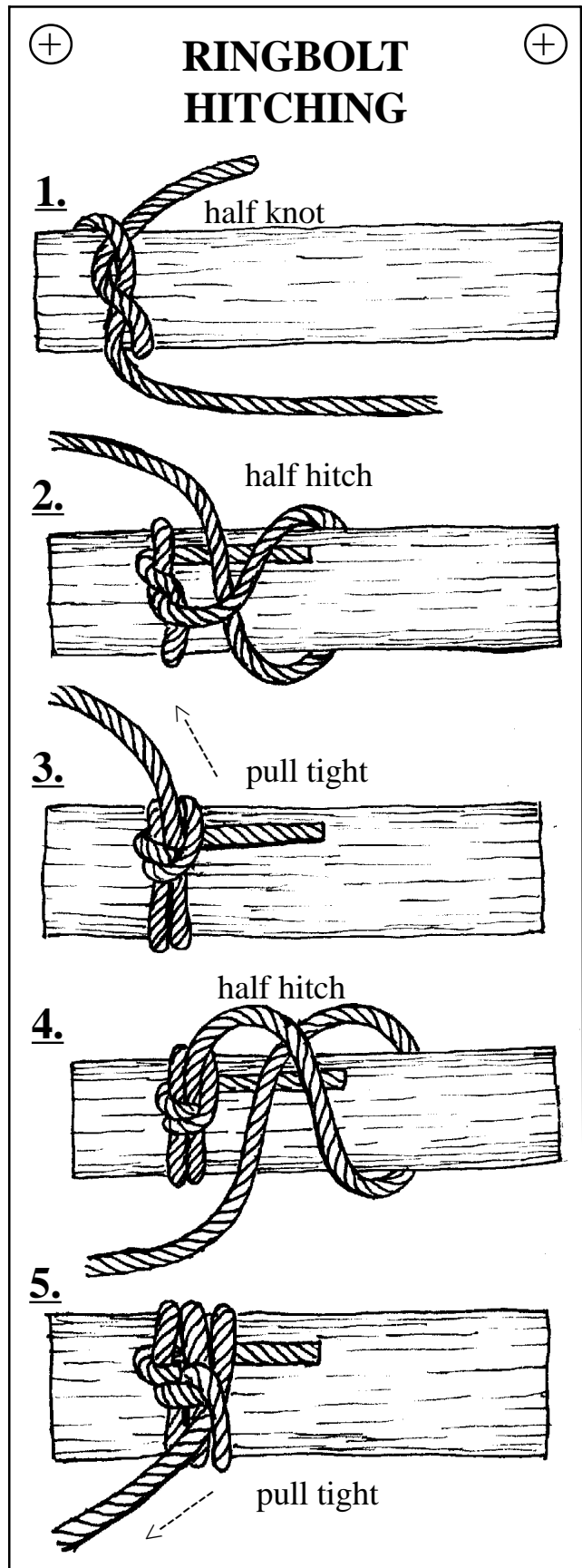

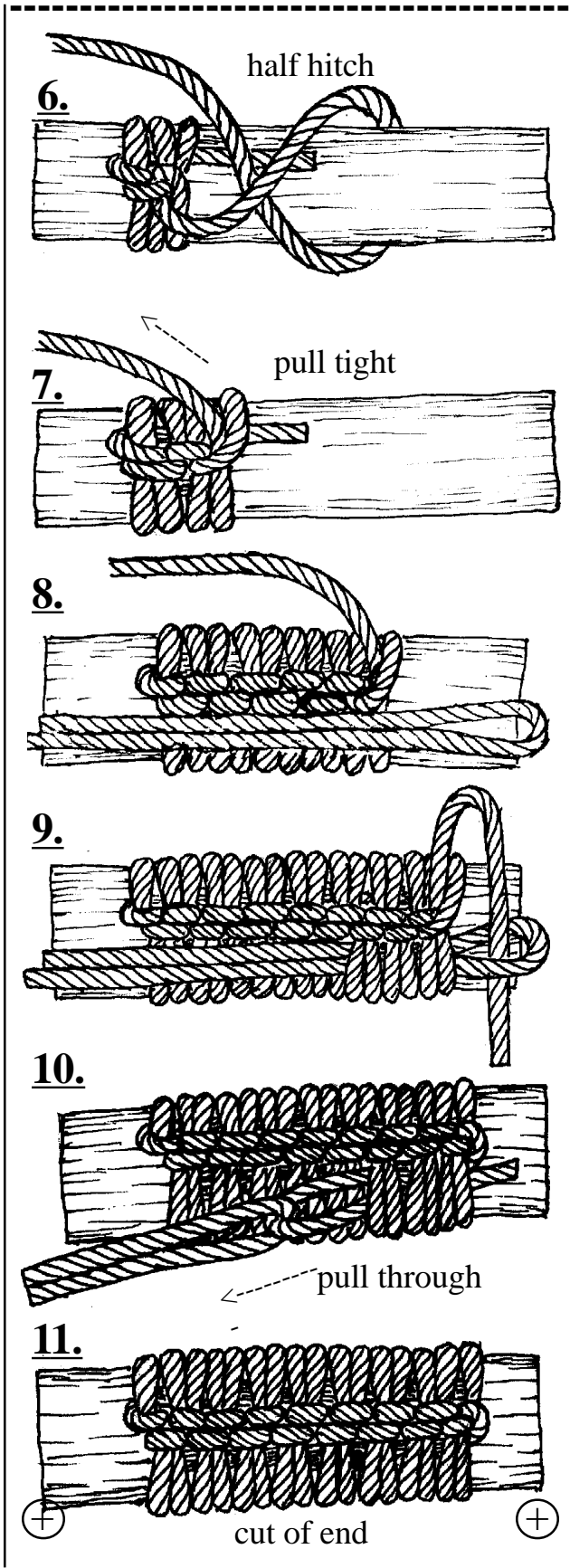

half hitch tight. (8) When the length of the ring-bolt hitching is within 5 or 6 half hitches of being long enough; form a bight in the a short piece of twine so that the eye of the bight is toward the end of the work. (9) Continue to add half hitches until the ringbolt hitching is completed; reeve the running end through the eye of the bight. (10) Use the short piece of twine to pull the running end under the half hitches. (11) Cut off the end of the twine.

[NOTES]



BOATSWAIN'S WHISTLE KNOT

Description ---- A two lead knot that is built up from two interlocking underhand loops to looks like a turk's head knot when it is worked tight.

Use ---- As a decorative knot to attach a whistle or a knife to a lanyard ---- to form a toggle or button.

Other names ---- Sailor's knife lanyard knot, marlingspike lanyard knot, single-strand diamond knot, two strand diamond knot ---- pipe lanyard knot.

Narration ----(For **boatswain's whistle knot** knot-board.) (1) Use the left hand to hold the middle of a strand of rope so that the loop of the bight is to the back of the hand and the two leads are between the fingers and hanging down across the palm. (2) Use the bottom lead, to lay an underhand loop over the standing end of top lead. (3) Form a bight in the bottom lead so that its running end is under the running end of the top lead. (4) Weave the running end of the bottom lead over the right edge of the top underhand loop, then under the standing end of the bottom lead, and over the left edge of the top underhand hand loop. This forms two interlocking underhand loops. (5) Form the next bight by placing the running end of the top lead under the top edge of the top underhand loop. (6) Reeve the running end of the top lead to the outside of the standing end of the bottom lead and up through the middle of the interlocking underhand knots. (7) Form the next bight by placing the running end of the bottom lead under the bottom edge of the bottom underhand loop. (8) Reeve the running end of the bottom lead to the outside of the standing end of the bottom lead and up through the middle of the interlocking underhand knots. (9) Work the knot tight.

Doubling:

Doubling the Boatswain's Whistle Knot increases its size. The increase in size makes it more effective as a toggle or button. Doubling also gives a variation in appearance when doing decorative work.

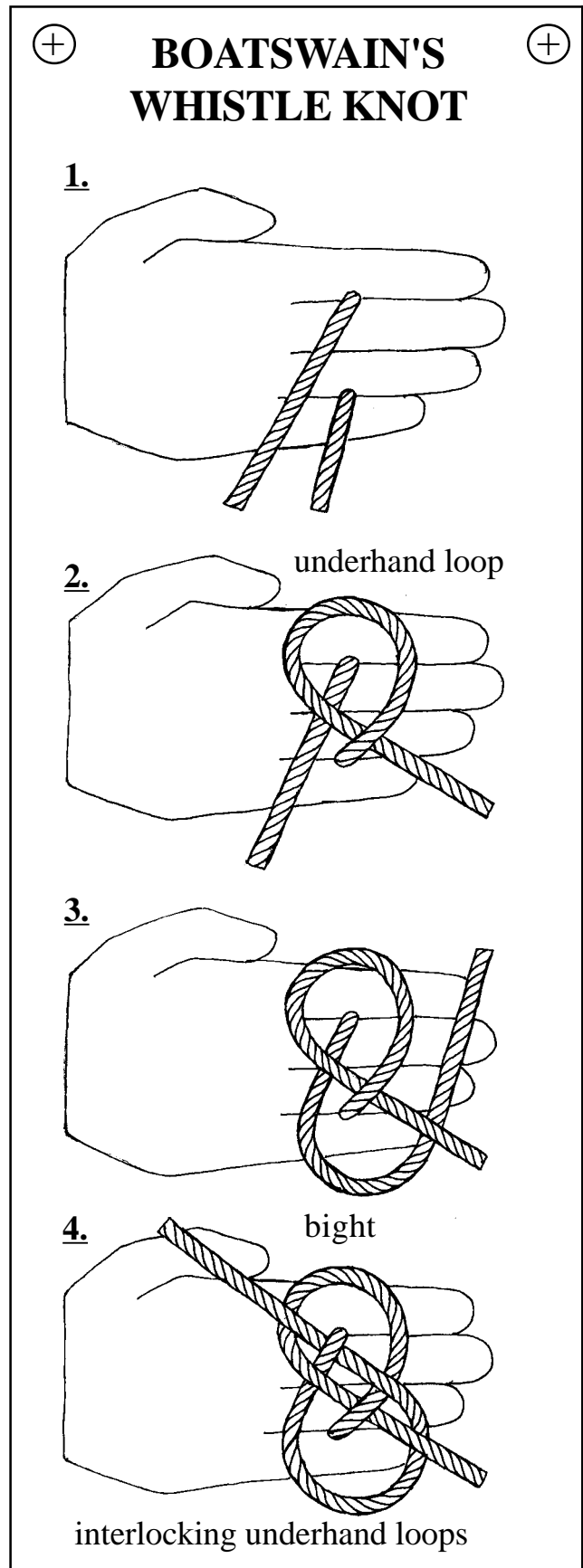

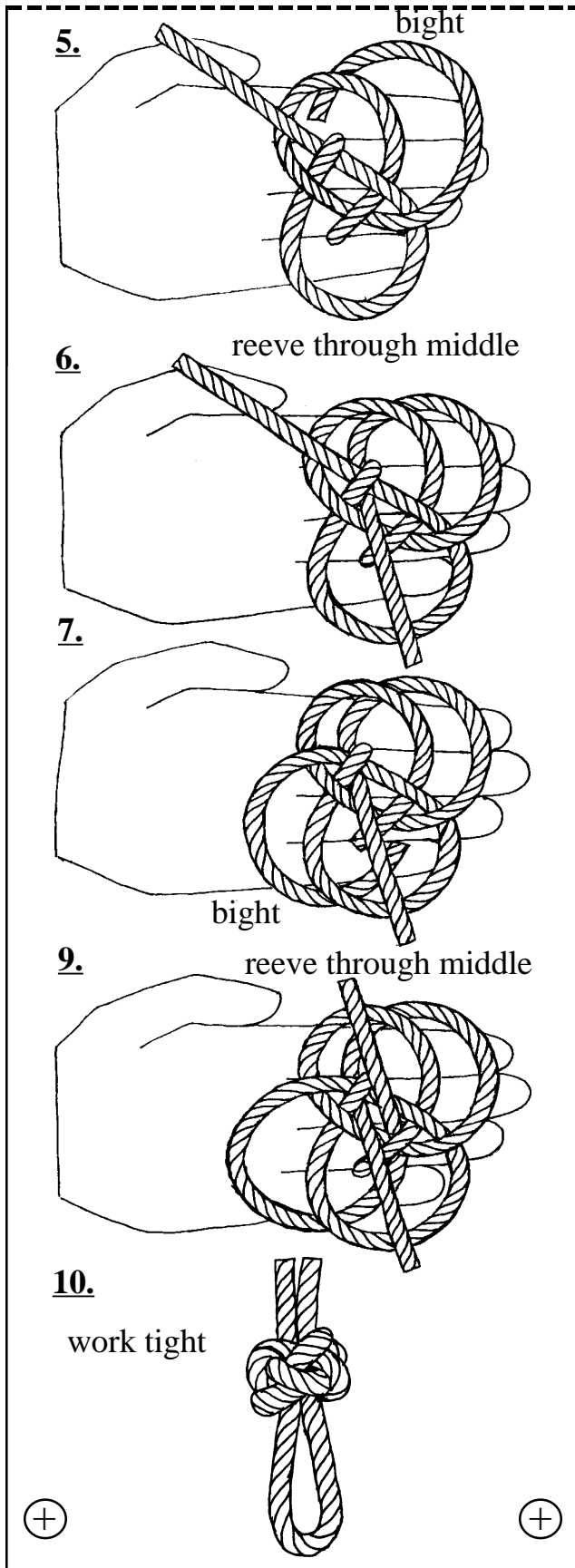

Doubling Continued:

Narrative ---- (For **Doubling** knotboard.) (1) Follow steps 1 --- 4 from the knot board for the **BOATSWAIN'S WHISTLE KNOT**. (2) Form the next bight by placing the running end of the top lead under the top edge of the top underhand loop. (3) weave the running end of the top lead to the inside of the standing end of the bottom lead and across the middle of the interlocking underhand knots. (4) Form the next bight by placing the running end of the bottom lead under the bottom edge of the bottom underhand loop. (5) Weave the running end of bottom lead to the inside of the standing end of the bottom lead and across middle of the interlocking underhand knots. (6) Chase the top lead with the bottom lead; end by bringing the top lead up through the middle. (7) Chase the bottom lead with the top lead; end by bringing the bottom lead up through the middle. (8) Work the knot tight.



+

BOATSWAIN'S WHISTLE KNOT (DOUBLED)

+

1.

Follow steps 1 -- 4 from the knot board for the BOATSWAIN'S WHISTLE KNOT

2.

top underhand loop
bottom lead

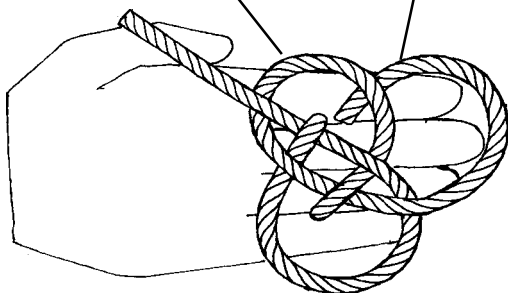

3.

weave inside lead

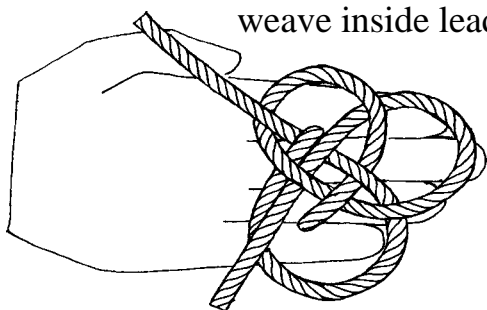

4.

top lead
bottom underhand loop

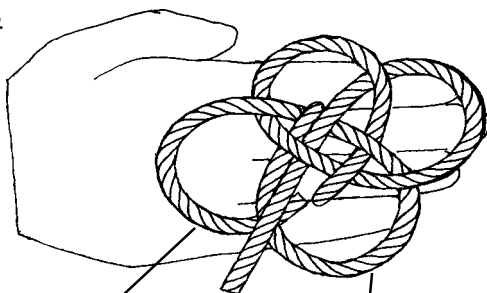

5.

weave inside lead

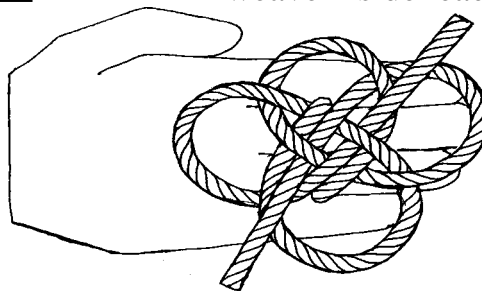

6.

chase top lead

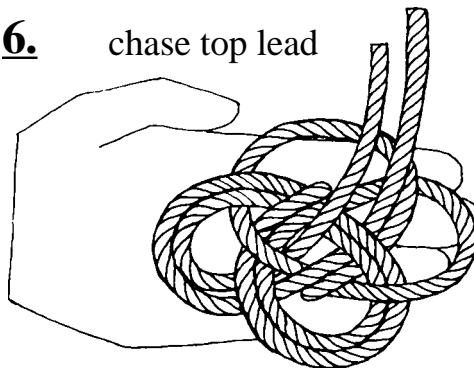

7.

chase bottom lead

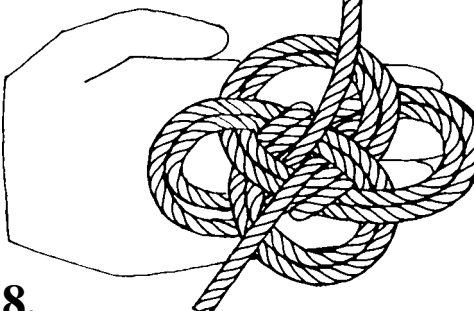

8.

work tight



+

+

DIAGONAL LASHING:

Use ---- Diagonal lashing is used to bind poles together that cross each other but do not touch when their ends are lashed in place in a structure.

Comments ---- The diagonal lashing gets its name from the fact that the wrapping turns cross the poles diagonally.

The diagonal lashing can be used to bind poles that cross each other from 90° to 45°. If the angle between the poles is less than 45° a shear lashing should be used.

The diagonal lashing makes use of the timber hitch to pull poles together that are not touching each other. The timber hitch allows the poles to be drawn together without changing the relative positions of the poles. [NOTE] If a square lashing were used to bind poles that do not touch, the beginning clove hitch would pull the cross pole toward the clove hitch causing unnecessary bowing of the cross pole and could also produce a force that would act along the length of the pole to which the clove hitch is tied. These additional force, if strong enough, can place unnecessary strain on other lashing within the structure causing the structure to twist and fail.

Narration ---- (For **diagonal lash** knotboard.) (1) Tie a timber hitch diagonally around both poles. (2) Start the wrapping turns on the opposite diagonal to the timber hitch, by pulling the rope tight so that the poles contact each other. (3) Take 3 to 4 wrapping turns; keep the wrapping turns parallel; pull each wrapping turn tight. [NOTE] If the wrapping turns are allowed to cross, the increased friction between the strands of the rope will make it difficult to tighten the wrapping turns. (4) Start the second set of wrapping turns by going past and around the vertical pole. [NOTE] Going

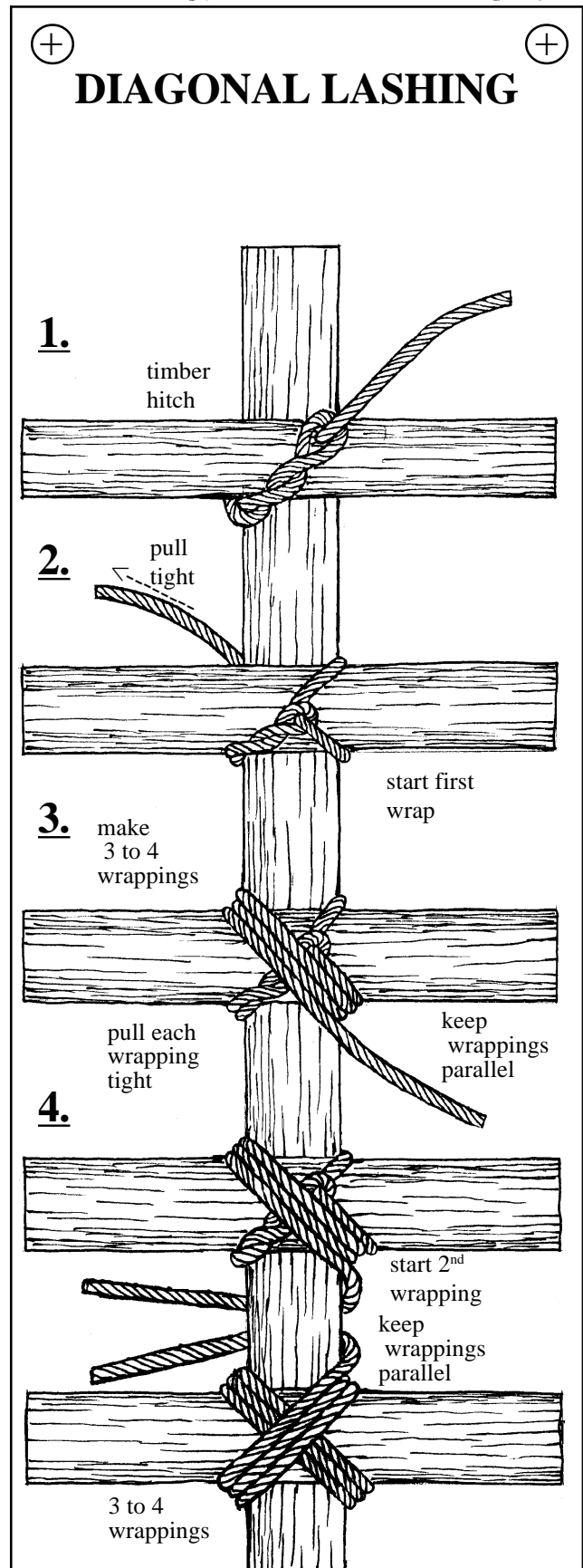

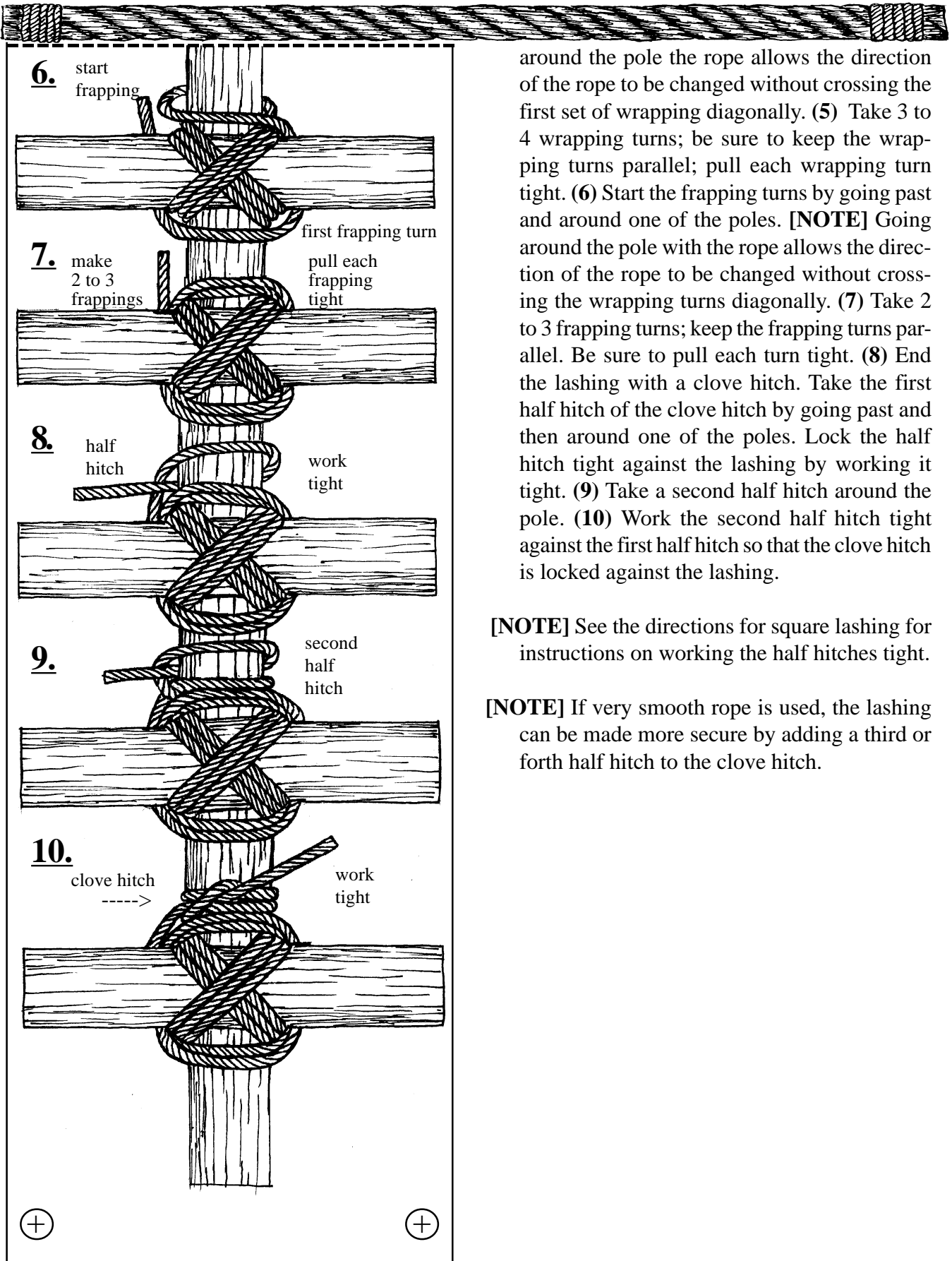

around the pole the rope allows the direction of the rope to be changed without crossing the first set of wrapping diagonally. (5) Take 3 to 4 wrapping turns; be sure to keep the wrapping turns parallel; pull each wrapping turn tight. (6) Start the frapping turns by going past and around one of the poles. [NOTE] Going around the pole with the rope allows the direction of the rope to be changed without crossing the wrapping turns diagonally. (7) Take 2 to 3 frapping turns; keep the frapping turns parallel. Be sure to pull each turn tight. (8) End the lashing with a clove hitch. Take the first half hitch of the clove hitch by going past and then around one of the poles. Lock the half hitch tight against the lashing by working it tight. (9) Take a second half hitch around the pole. (10) Work the second half hitch tight against the first half hitch so that the clove hitch is locked against the lashing.

[NOTE] See the directions for square lashing for instructions on working the half hitches tight.

[NOTE] If very smooth rope is used, the lashing can be made more secure by adding a third or fourth half hitch to the clove hitch.



CONSTRUCTOR KNOT:

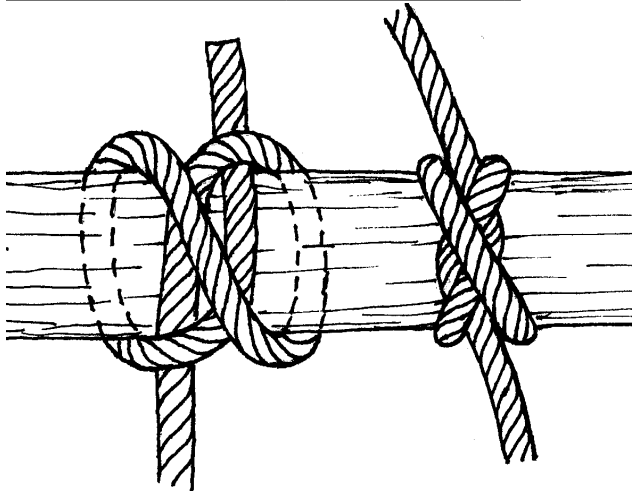

Description ---- A clove hitch with a half knot under the cross-point.

Use ---- To tie a smaller rope to a larger one, or to tie a rope to a stake or pole; a substitute for whipping; as a lashing for light construction ; as a hose clamp.

Comments ---- A secure nonslip knot ; difficult to untie without cutting.

METHODS OF TYING:

Method # 1:

[NOTE] Use this method of tying the constrictor knot on either side of where you intend to cut a rope. This is a fast and easy way to prevent a rope from unlaying when it is cut.

Narration ---- (For constrictor knot (method #1) knotboard.) (1) take a bight around an pole. (2) Continue wrapping the running part around the pole so that the running part crosses over the standing part. (3) Complete the turn around the pole. (4) Cross the running part over the standing part so that (5) a bight is formed around the standing part. (6) Reeve the running part under the cross part of the loop in the standing part to form a half knot under the cross-point. (7) Pull the standing tight. (8) Lock the knot tight by pulling hard on both the standing part and the running part.

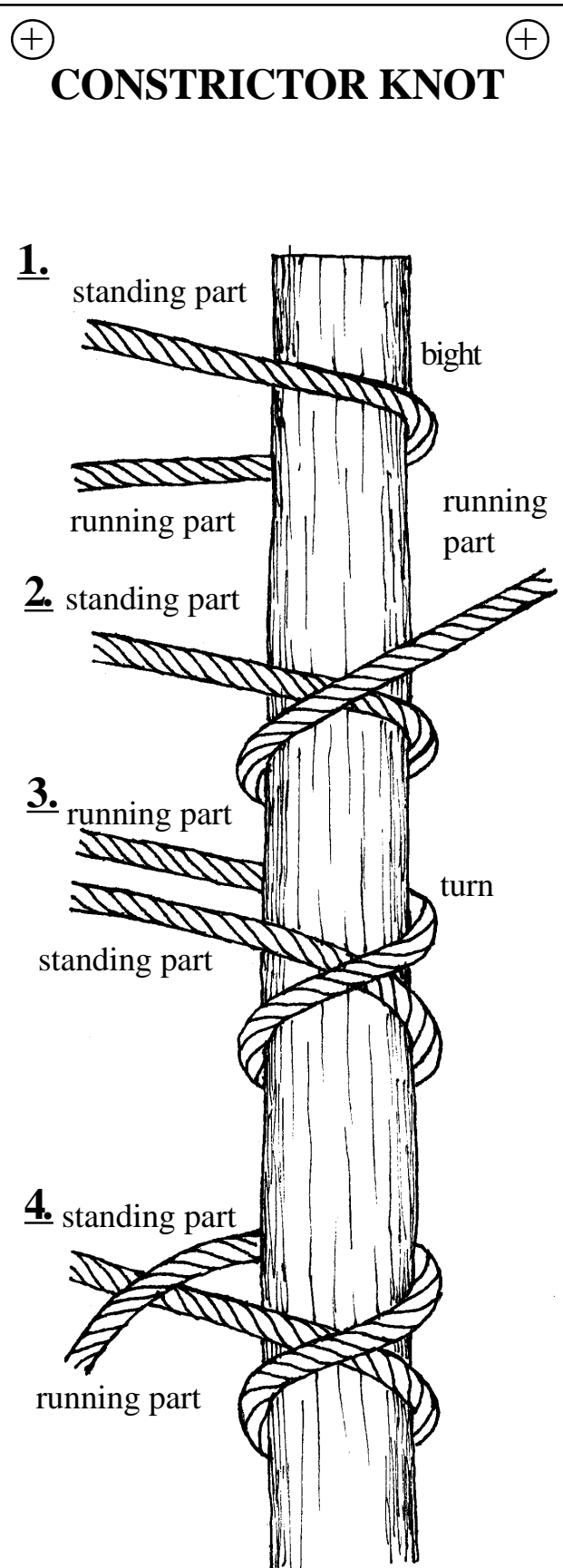

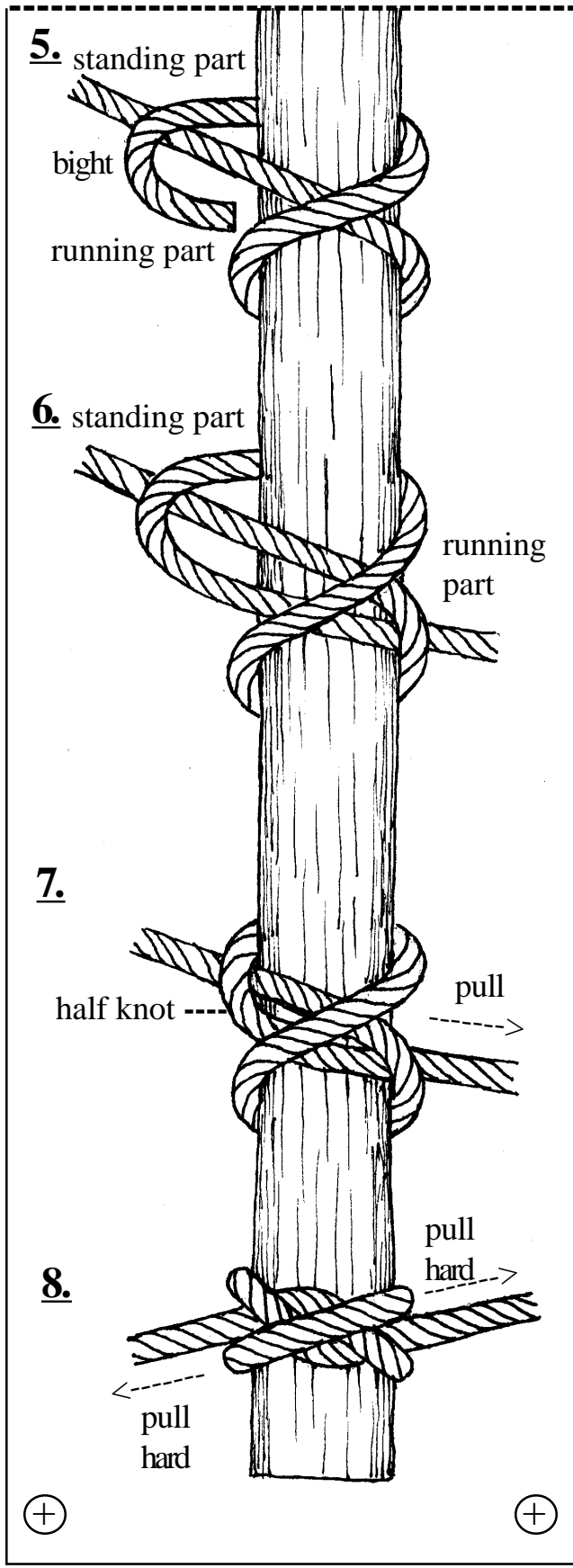

METHODS OF TYING:

Method # 2: Over the end of a pole or rope.

[1] Start with an underhand loop laid on the pole.

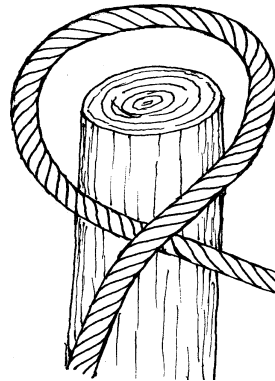

underhand loop

[2] Place the loop over the end of the pole.

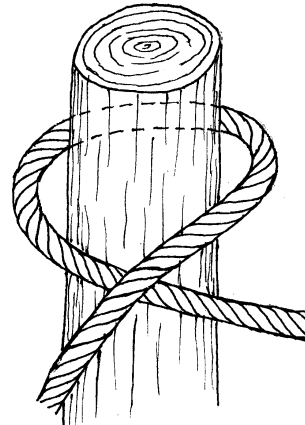

[3] Pull the opposite side of the loop down and under the cross point of the underhand loop

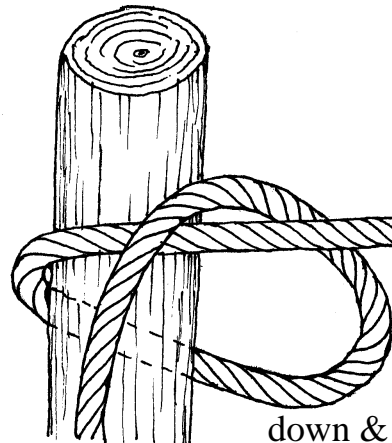

down & under



[4] then pull it up and over the end of the pole

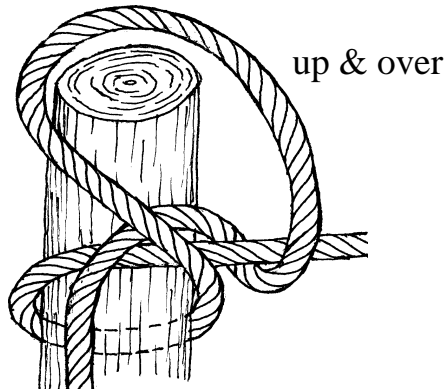

[5] to form a second loop around the pole and a half knot under the cross point of the knot.

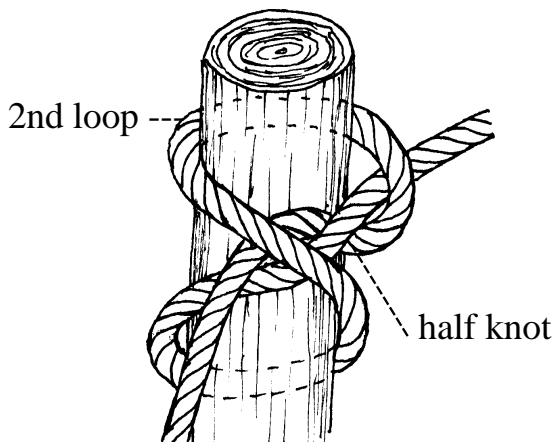

[6] Pull the two ends tight. The harder you pull the tighter the knot.

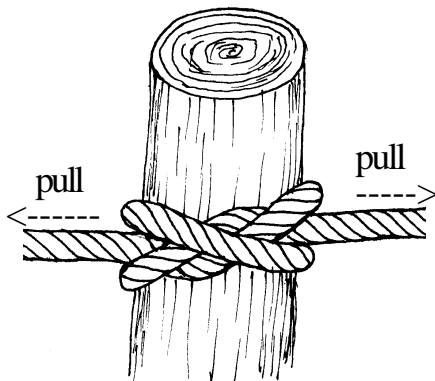

Method # 3: Slippery constrictor knot.

[NOTE] This method of tying the constrictor knot allows it to be untied quickly and easily.

1. running part



2.

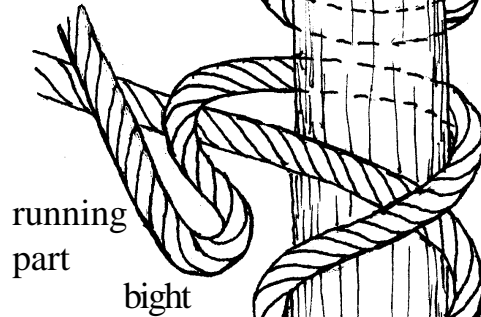

3.



4.

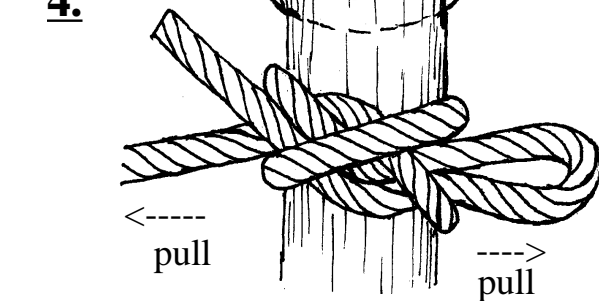



Narration -----(For **slippery constrictor knot** knotboard.) (1) Tie the slippery constrictor knot the same way as a regular constrictor knot but (2) form a bight in the running end before it is (3) reeved under the cross part of the loop in the standing part. Pull the standing tight. (4) Lock the half knot tight by pulling hard on both the standing part and the running part.

Method # 4: As a lashing.

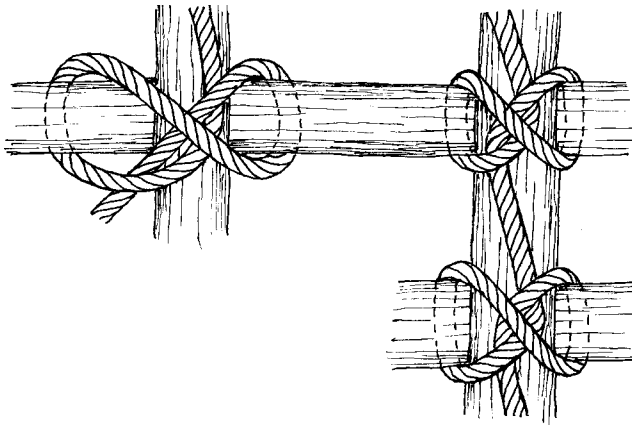

tying to a stake or pole

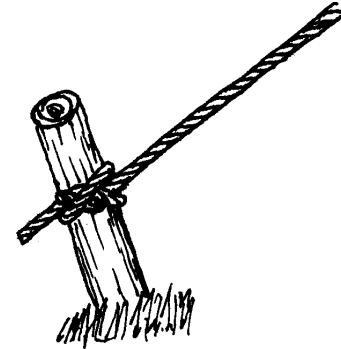

round lashing

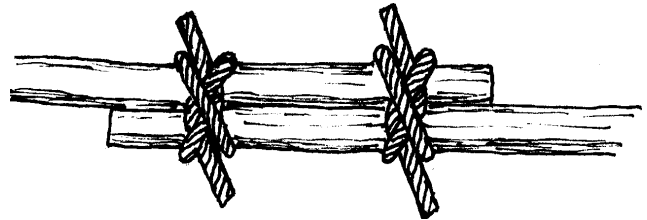

SUGGESTED USES: For the constrictor knot.

whipping

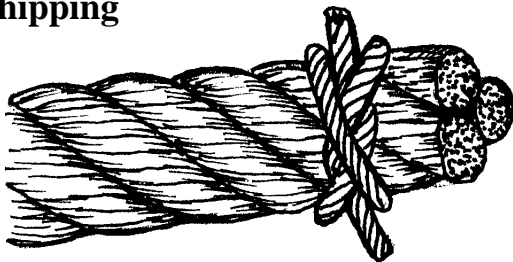

spaced rungs

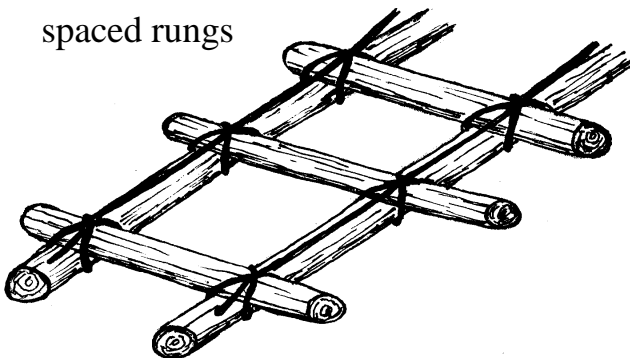

[NOTES]



MONKEY'S PAW:

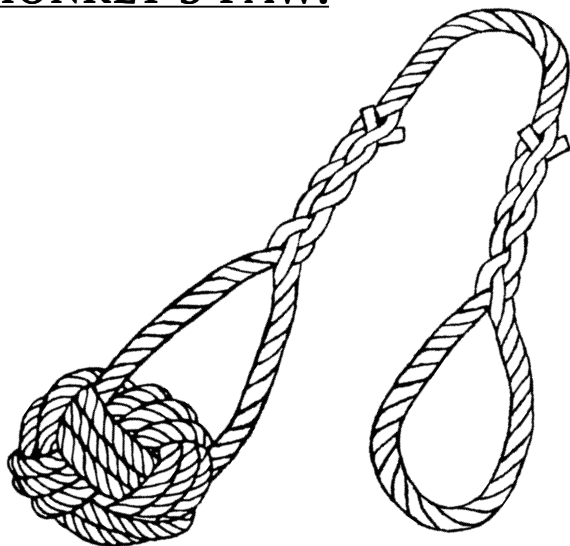

Description ---- The form of the monkey's paw shown here is formed from four interlocking loops: a four crown turk's head.

Use ---- The core determines what the monkey's paw can be used for. When tied over a stone or heavy ball, the monkey's paw can be used to add weight to a heaving line. If tied over a cork ball with small cord the monkey's paw makes a good float for boat keys or other small items used around a water front. Tied over a ball of twine or other soft material, the monkey's paw can be used as weight on the end of a rope for the game jump the shot. A Monkey's Paw can also be used as a toggle.

Core Size ----- The diameter of the core should be between three and four diameters of the rope being used.

MONKEY'S PAW TURK'S HEAD

Narration ---- (For monkey's paw turk's head knotboard) (1) Form an overhand loop (2) Form a second overhand loop over the left edge of the first overhand loop (3) Cross the standing end over the running end (4) Weave the running end across the loops by placing the running end over the right side of the top loop (5) then under the right side of the bottom loop (6) next, over the left side of the top loop (7) and

⊕

MONKEY'S PAW (turk's head)

⊕

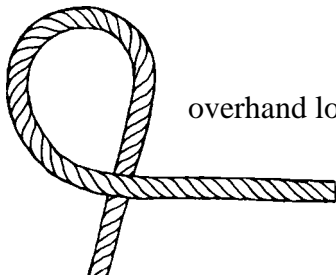
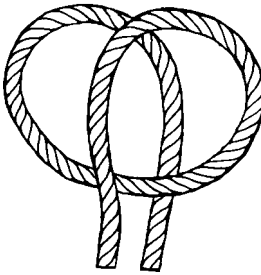
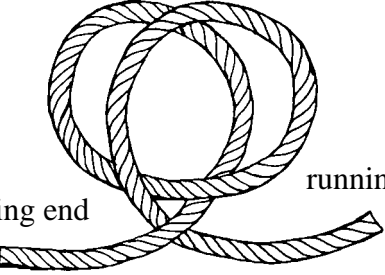
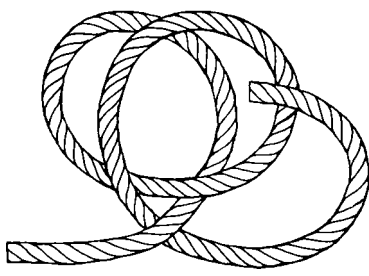
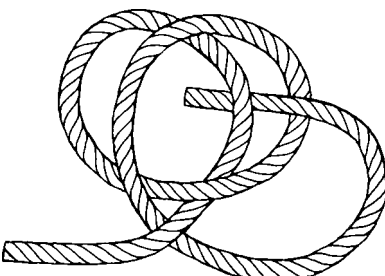
1.  overhand loop
2.  2nd overhand loop
cross ends
3.  standing end running end
4. 
5. 



6.

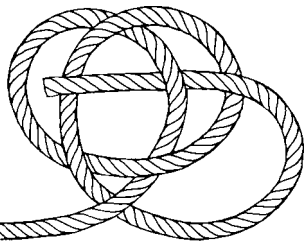

7.

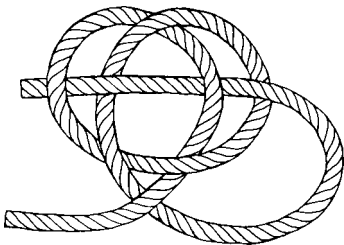

8.

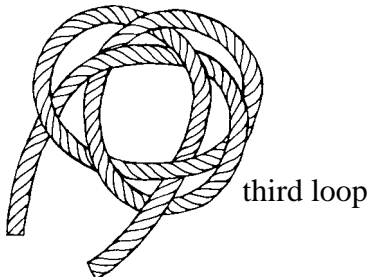

9.

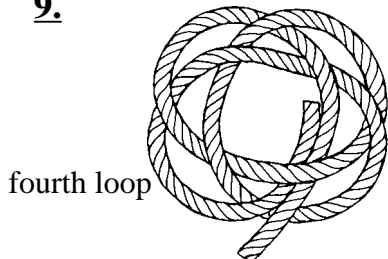

10.

chase 2 to 3 times

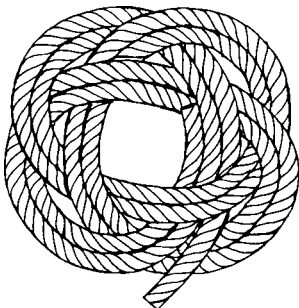

11.

work tight over a core

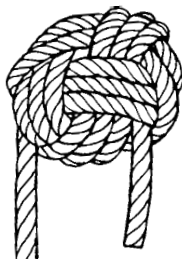

finally under the left side of the of the bottom loop. **(8)** Pull the running end through until a third loop equal in size to the first two loops. **(9)** Add the fourth loop by placing the running end parallel to the standing end. **(10)** Chase the original pattern 2 to 3 times. **(11)** Work tight over the core.

[NOTE] Join the two ends of the monkey's paw with an eye splice, a short splice, or a seizing.

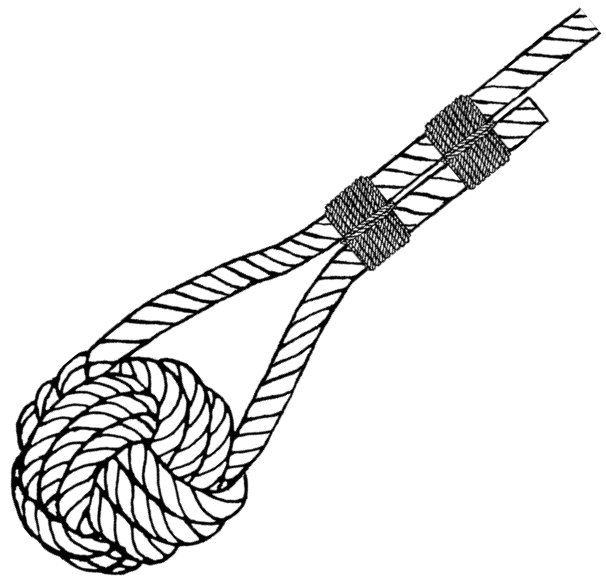

MOORING HITCH :

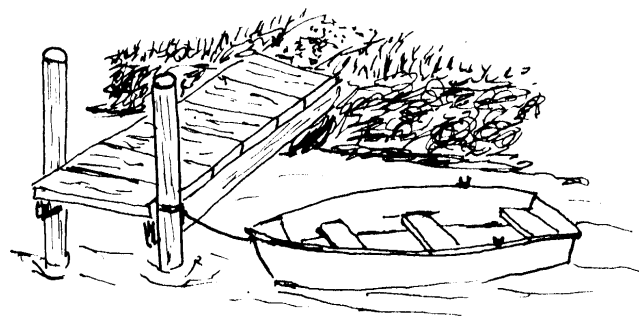

Description — An underhand loop toggled to the standing part with a bight made in the running end.

Use — To securely tie off a rope so that it can be quickly untied, especially a small boat to a dock or piling.

Comments — A secure knot that is easily tied or untied in wet or dry rope; when properly tied a non closing loop is formed, this allows the hitch to move up or down a piling as the water level changes.

Narrative —(For **mooring hitch** knotboard.)

- (1) Take a bight around an object.
- (2) Form an underhand loop in the running part.
- (3) Place the eye of the underhand loop over the standing part.
- (4) Pull a bight of the standing part through the eye of the underhand loop.
- (5) Pull the underhand loop tight around the bight.
- (6) Place the running part under the eye of the bight that was pulled through the underhand loop.
- (7) Pull a bight of the running part through the eye of the standing part bight.
- (8) Pull on the standing part to tighten the standing part bight around the running part bight.

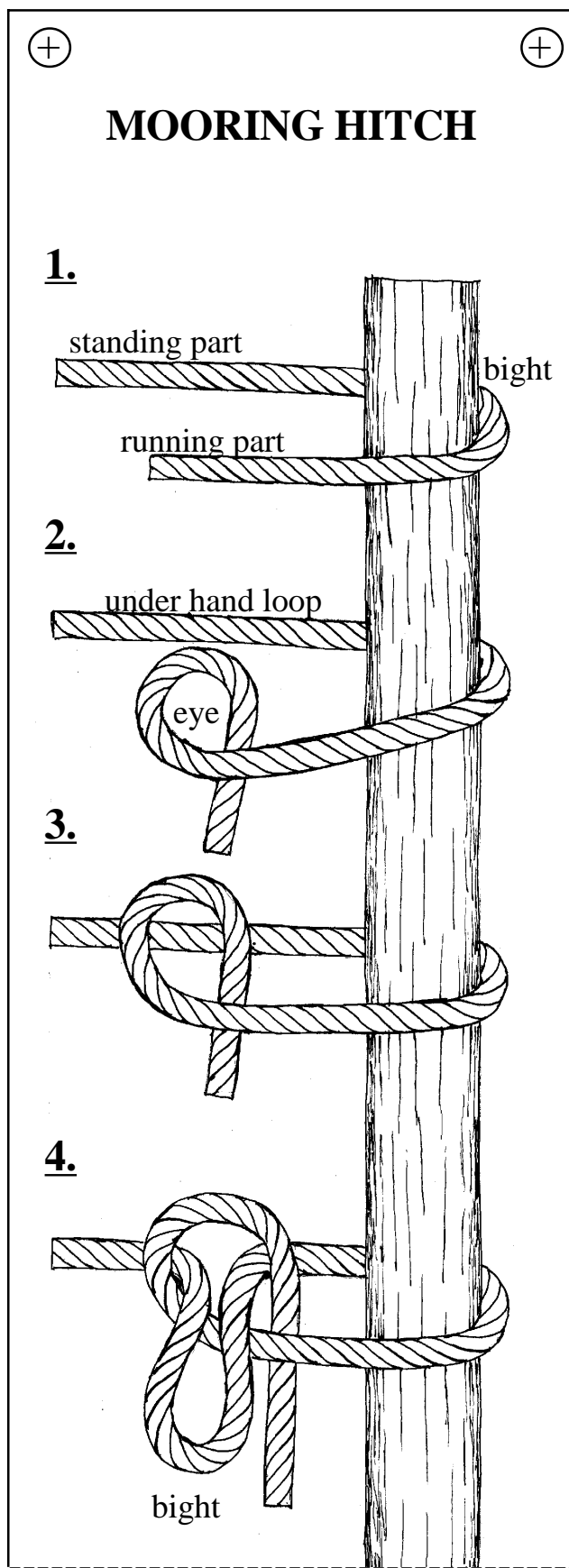

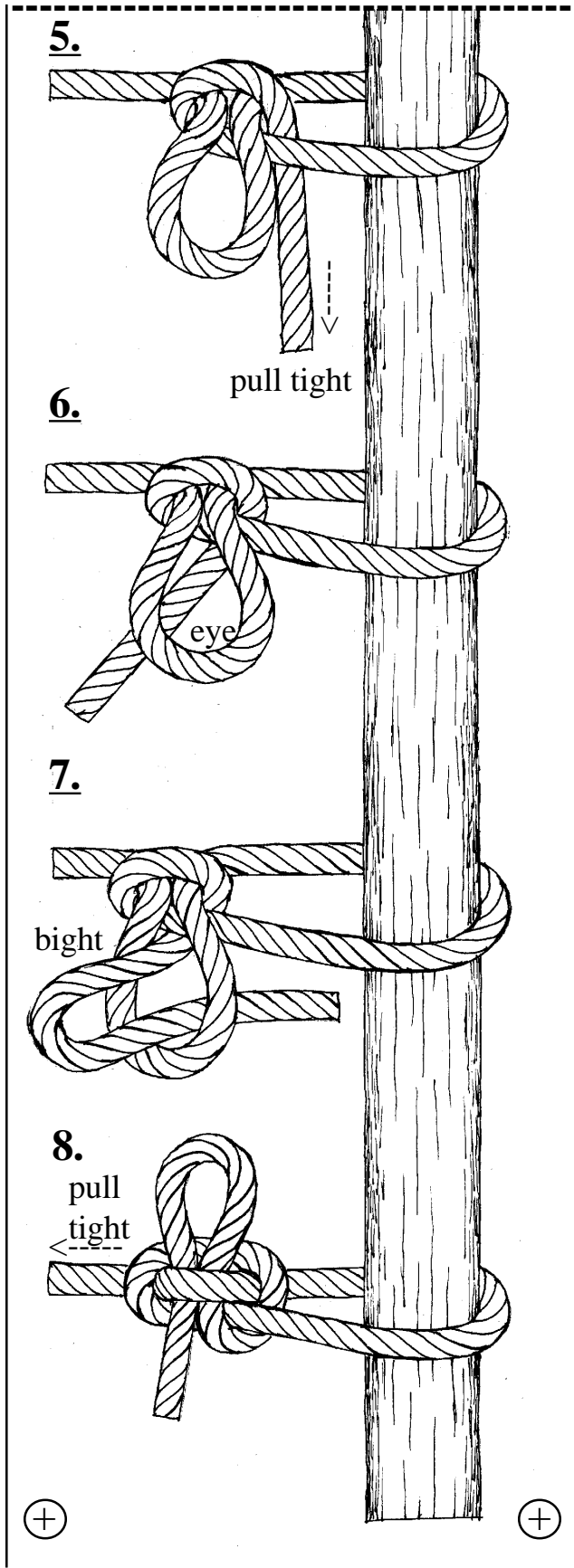

[NOTES]



JUG KNOT:

Use ---- to provide a convenient carrying handle for jug or bottle ---- to attach a tool, such as a hammer to a security line to prevent accidental dropping --- to add a wrist loop to a walking staff --- to attach a safety line to a canoe paddle use your imagination, but be sure that you keep safety in mind.

Other names ---- Jar knot, moonshiner's knot, hackamore, bridle knot.

Comments ---- The most common use is to provide a loop handle attached to the neck of a bottle. The loop handle makes it easy to carry several bottles with one hand. If a toggle or a two strand button knot such as boatswain whistle knot is added to the free end of the rope,

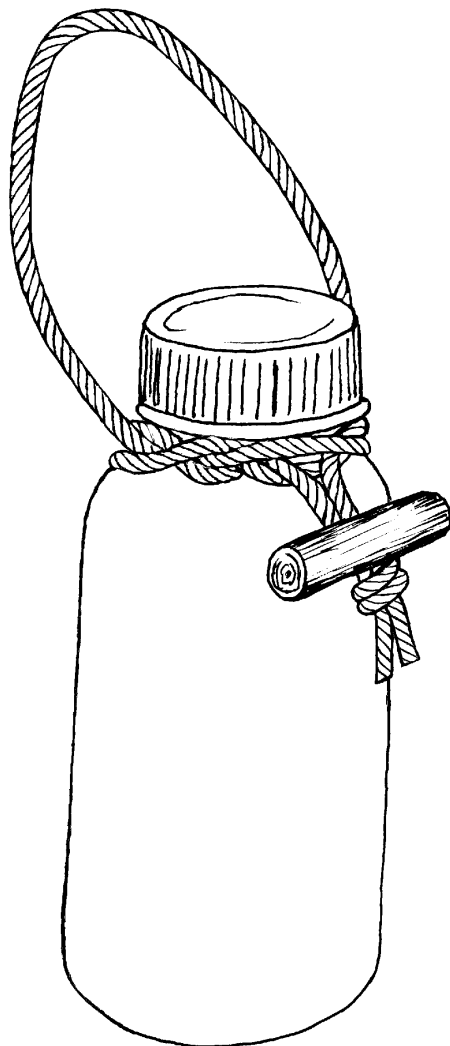

+

JUG KNOT

+

1.

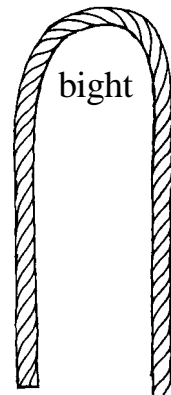

2.

fold down

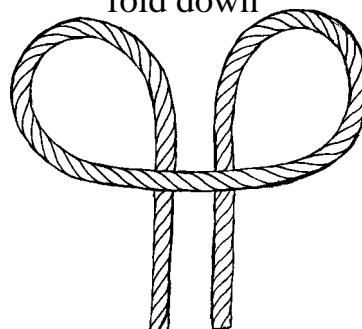

3.

cross loops

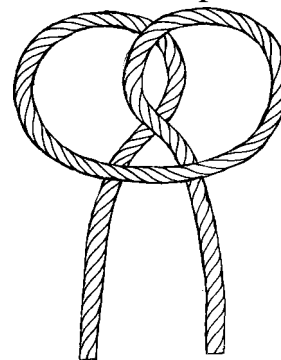

4.

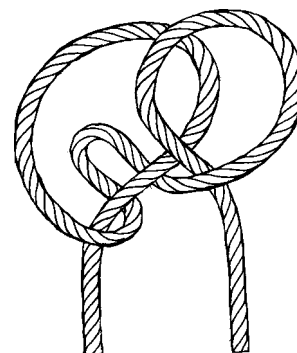



5.

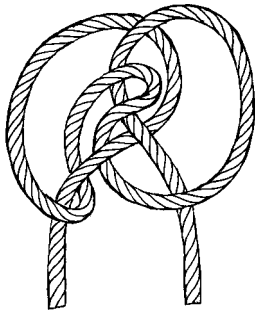

6.

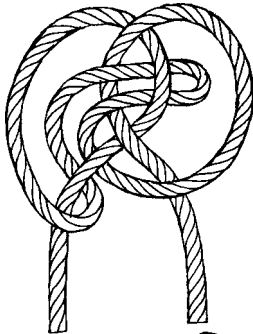

7.

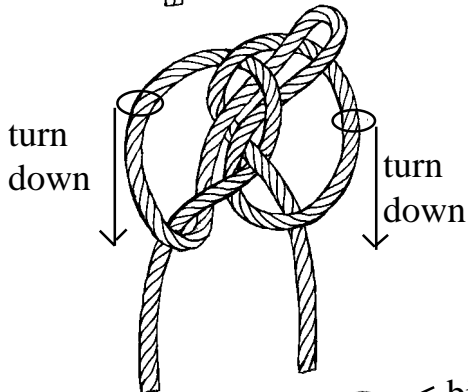

8.

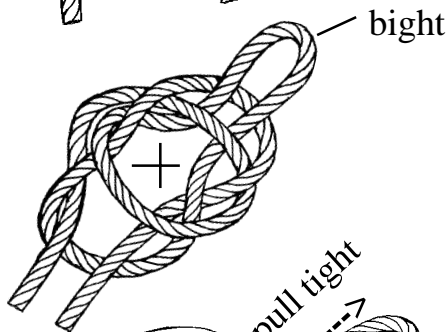

9.



The loop of the jug knot can be used to toggle the bottle to a belt so that the bottle can be used as a canteen.

Plastic bottles with screw-on lids such as soda, sport drink, and mineral water bottles make strong, lightweight containers for carrying water on hikes and camp outs. 2 and 3 liter soda bottles are large enough to use as water containers around the camp kitchen. Smaller bottles (8 to 16 oz.) can be used as personal water bottles or canteens. These bottles can be made even more convenient by using a jug knot to attach a loop handle.

To help keep your water cool and refreshing in hot weather, place a sock over the bottle, wet the sock when you fill the bottle, evaporation will do the rest.

In cold weather, carry your water bottle under your coat. A dry sock placed over the bottle will help keep the water from freezing.

To protect your health, wash and disinfect your water bottle with a chlorine bleach solution and don't share your water bottle with others; show them how to make a water bottle of their own.

Narrative ---- (For **jug knot** knotboard) (1) Form a bight in the middle of a 24 to 30 inch long by 3/16 inch diameter rope. (2) Fold the bight down over the standing ends to form two loops. (3) Place the right loop over the side of the left loop. (4) Weave the middle of the bight under the standing end; then over the left edge of the right loop; (5) next go under the right edge of the left loop; (6) finally pass the bight over the right side of the left loop. (7) Turn the tops of the original loops down over the knot. (8) Place the knot over the neck of a bottle and work the knot tight so that the bight forms a 4 to 5 inch loop handle and the loose ends are even.





BELAYING TO A CLEAT:

Description ----- A turn secured to a cleat with a figure eights and locked in place with a half hitch.

Use ---- To secure a flag lanyard, to moor a boat to a dock.

Comments ---- Belaying to a cleat is a fast non-jamming method of securing a rope anywhere along its length without reeving any part of the rope through or around anything.

Narration ----(For **belaying to a cleat** knotboard.)

(1) Take a bight around the the first horn of the cleat and pull the line tight. (2) Take a bight around the second horn. (3) Place the line across the cleat. (4) Take a second bight around the first horn. (5) Place the line across the cleat a second time. (6) Form a loop so that its running end is under its standing end. (7) Place the eye of the loop over the second horn of the cleat. (8) Pull the loop tight to form a half hitch around the horn of the cleat, this locks the rope in place.

⊕ BELAYING TO A CLEAT ⊕

1.

take bight

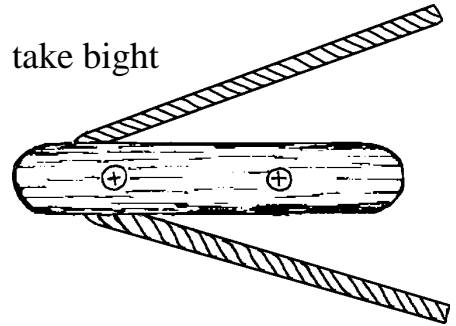

2.

bight

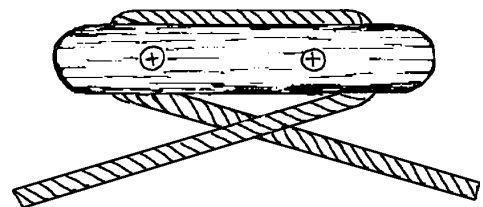

3.

cross cleat

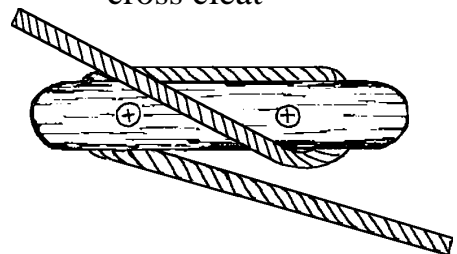

4.

bight

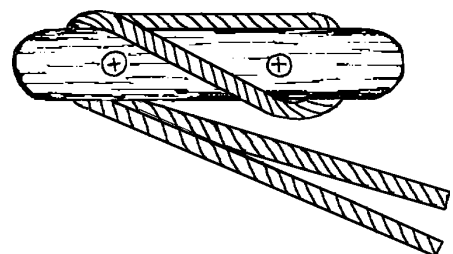



5. cross cleat

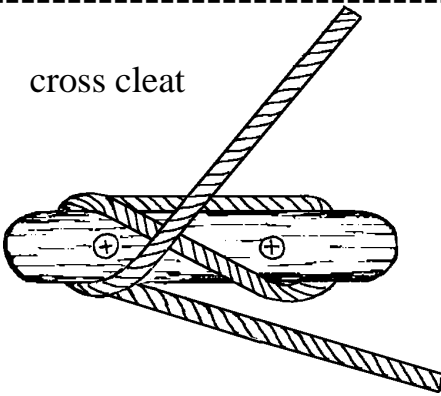

6. form loop

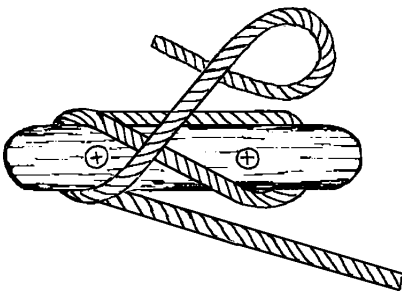

7. place over horn

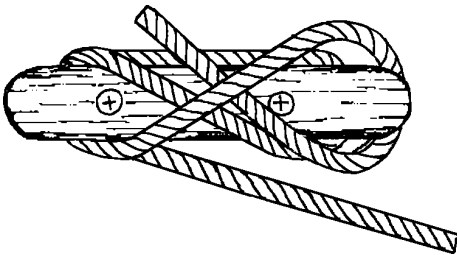

8. pull half hitch tight

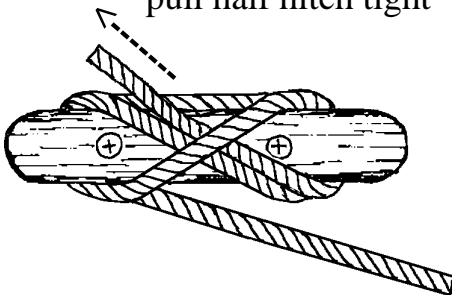

KNOTBOARD CLEAT **PATTERN:**

Use this pattern to make 8 hardwood cleats. Attach the cleats to the knotboard with 1 1/2 inch number 8 round head wood screws.

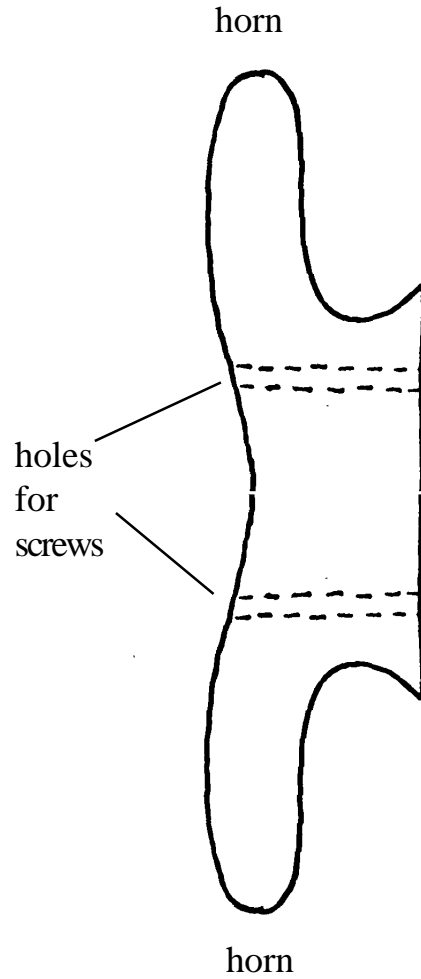

WHIPPING:

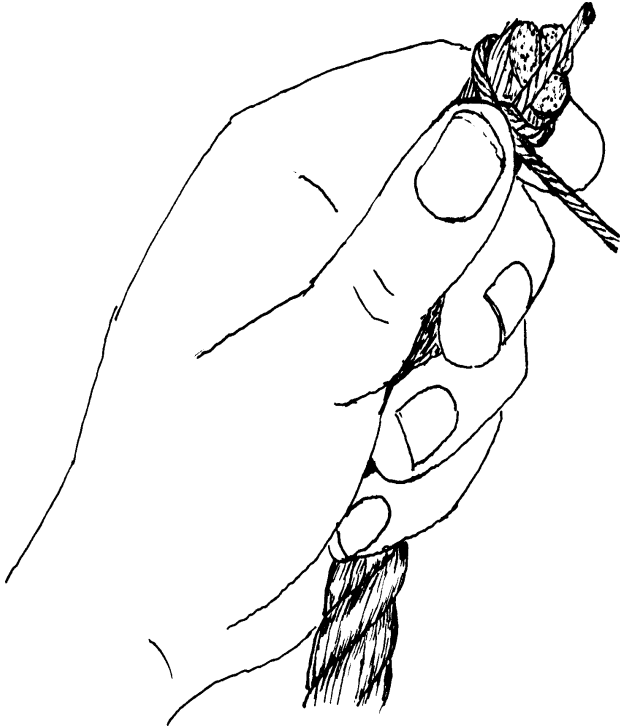

Description ---- Twine wrapped and secured to the end of a rope.

Use ---- To prevent the fraying of the end of a rope.

Comments ---- Even though "whipping" is done in several different ways, the finished "whippings" have similar appearance: the ends are secured under the turns, the length of the whipping is equal to the diameter of the rope, and all turns are parallel.

Synthetic rope, rope made of plastic, should be whipped and fused to prevent the rope from fraying. Fusing helps to hold the whipping in place and the whipping helps to prevent the fused rope strands from braking apart.

Other Names ---- **Serving:** When a rope is wrapped with twine to prevent chafing or wearing; the wrapping is done using the similar

methods to whipping. ---- **Seizing:** When twine is wrapped around two or more strands of rope to hold the rope in place; the wrapping is done using methods similar to shear lashing.

Materials ---- The twine that is used for whipping should be tightly spun or braided twine that is less than 1/8 the size of the rope to be whipped. Twine made of synthetic material should be used to whip synthetic rope, if natural fiber twine is used, the capillary action along the fibers of the rope draw water under the whipping causing the whipping to remain damp, so that rot quickly sets in. Likewise, natural fiber twine should be used to whip natural fiber rope, the poor wicking action of synthetic fibers allowing the whipping to trap moisture in the natural fiber rope, causing the rope to rot.

WHIPPING: METHOD 1:

Narration ---- (For **whipping [method 1]** knot-board.) (1) Form a loop in a 12 inch piece of twine so that the ends of the twine are parallel and in opposite directions. Lay the loop on the end of the rope so that the ends of the twine and the rope are all parallel and one end of the twine is extending beyond the end of the rope. (2) While holding the twine in place between the thumb and forefinger, pass the loop of twine around the end of the rope so that the wrap is with the lay of the rope. (3) To finish the wrapping, pull the twine under the thumb so that the twine is wrapped toward the standing part of the rope, pull the twine tight. (4) While holding the last wrapping in place between the thumb and forefinger, add additional wraps by passing the loop of twine around the end of the rope and pulling the wrap tight under the thumb for each wrap. (5) Continue to add wraps until the length of the whipping is equal to the diameter of the rope. (6) While still holding the last wrap tight between the thumb and forefinger, pull the loop closed by pulling on the end of the twine that is sticking out past the end of the rope. (7) Tighten the whipping by pulling on both ends of the twine. (8) Finish the whipping by cutting off the ends of the twine.



+

WHIPPING

+

1. (12 inch twine)

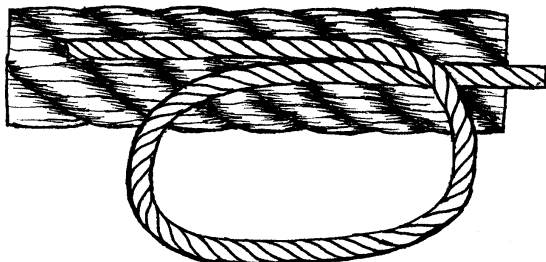

2.

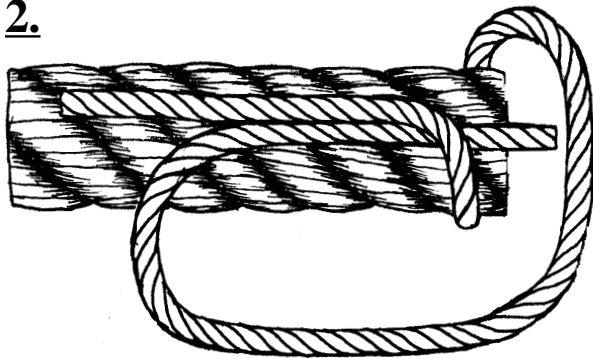

3.

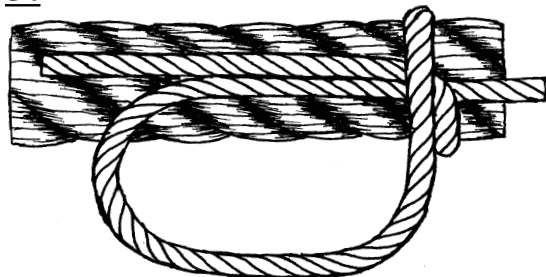

4.

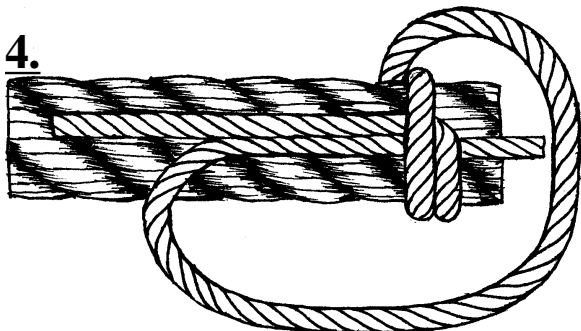

5.

diameter of rope
|----->

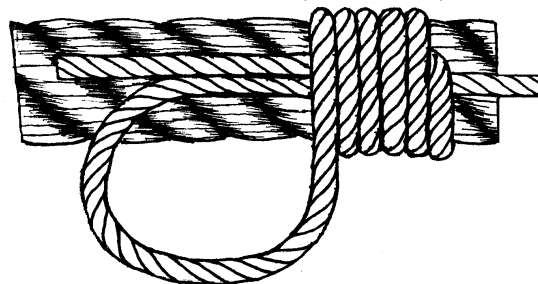

6.

pull
----->

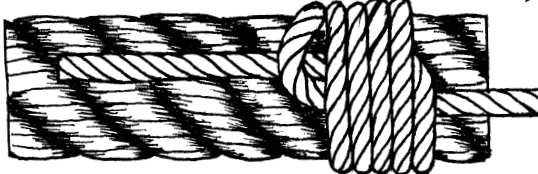

7.

pull tight
----->

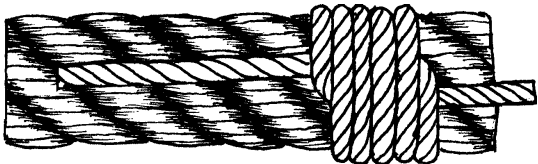

8.

cut off ends

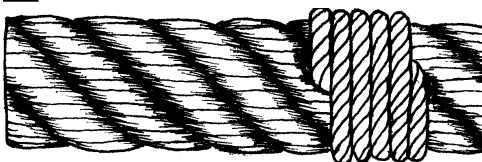

+

+

WHIPPING: METHOD 2:

Narration ----- (For whipping [method 2] knot-board.) (1) Form a bight in the end of a 24 inch piece of twine and lay it parallel to the end of the rope so that part of the short side of the bight is extending beyond the end of the rope. (2) Take a wrap around the end of the rope; hold the bight and the wrap in place with the thumb and forefinger; pull wrap tight. (3) When the length of the whipping is equal to the diameter of the rope, reeve the end of the twine through the eye of the bight. (4) Pull wrappings tight. (5) Pull on the end of the twine that is extending beyond the end of the rope until a bight of the free end of the twine is pulled under and to the mid point of the wrappings. (6) Finish the whipping by cutting off the ends of the twine.

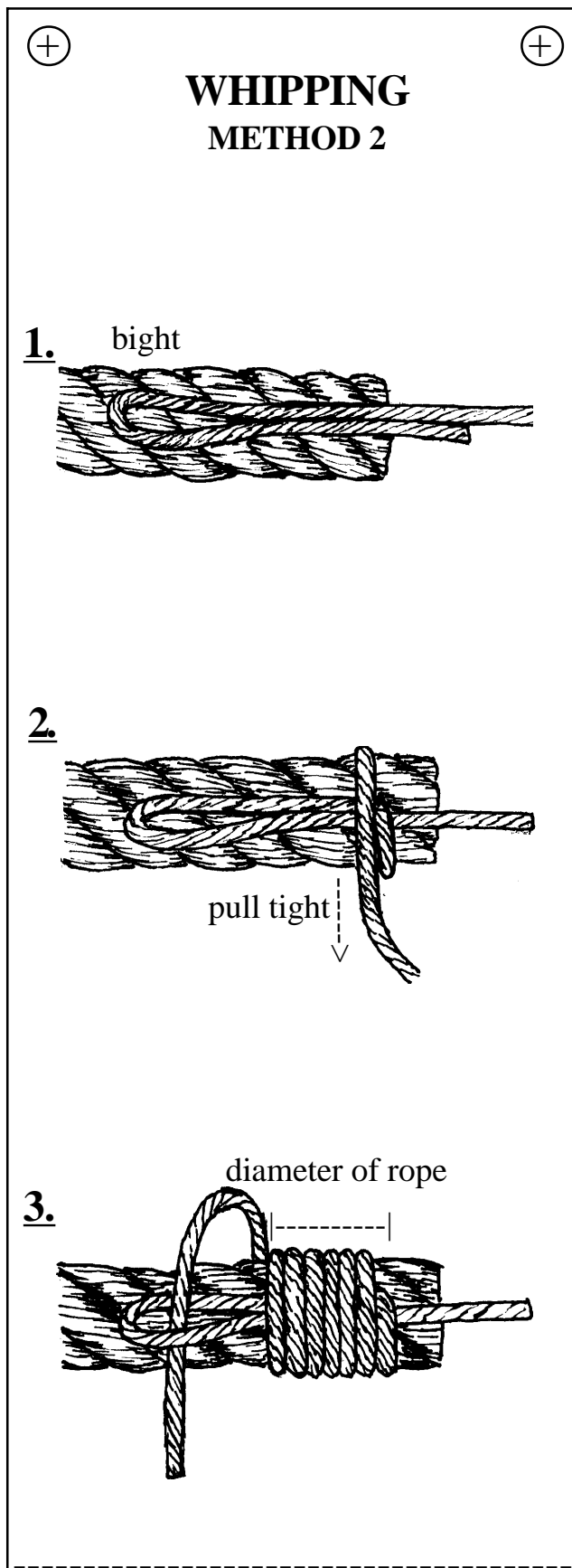



4.

pull tight

5.

pull to center

6.

cut off ends

(+) (+)

(+) (+)

WHIPPING METHOD 3

1.

short bight

2.

12 inch twine

3.

pull tight

(+) (+)



4.

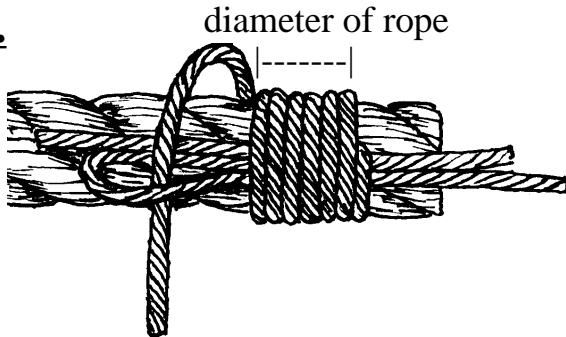

5.

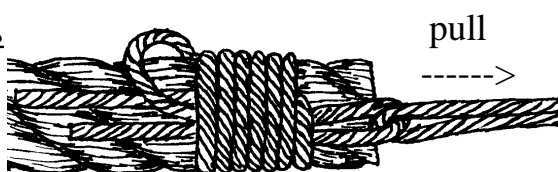

6.

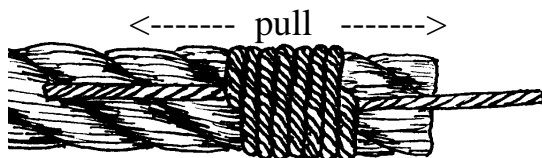

7.

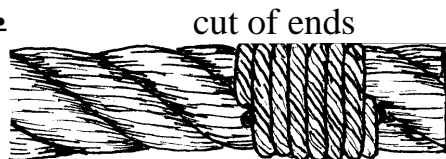

WHIPPING: METHOD 3

Narration ----(For **whipping [method 3]** knot-board.) (1) Form a bight in a 6 inch piece of twine; lay the bight parallel to the end of the rope with the ends of the twine extending past the end of the rope. (2) Lay the end of a 24 inch piece of twine next to the loop with the long end extending past the end of the rope. (3) Take a wrap around the end of the rope; hold the bight and the wrap in place with the thumb and forefinger; pull wrap tight. (4) When the length of the whipping is equal to the diameter of the rope, reeve the end of the twine through the eye of the bight. (5) Use the bight to pull the free end of the twine under the wrappings. (6) Tighten the whipping by pulling on the ends of the twine. (7) Finish the whipping by cutting off the end of the twine.

BOUND WHIPPING:

Description ---- A whipping with strands across the wraps.

Use ---- As a secure permanent whipping.

Comments ---- Bound whipping secures the wrapping turns by adding frapping turns to a standard whipping.

Other Names ---- Sailmaker's Whipping, (usually done with a needle).

Tying a Bound Whipping:

STEP 1: Lay a loop formed from a 24 inch piece of twine in one of the grooves between the strands of the rope. The end of the twine toward the standing part of the rope should be about 3 inches long.

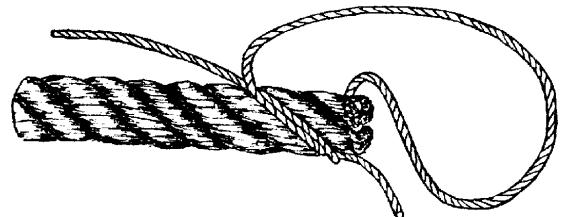



STEP 2: Wrap the twine around the end of the rope, work toward the standing part of the rope.

STEP 3: When the length of the whipping is equal to the diameter of the rope, close the loop by pulling on the end of the twine that extends beyond the end of the rope.

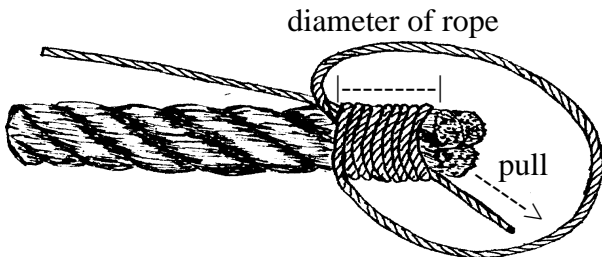

STEP 4: Pull on both ends of the twine to tighten the whipping around the rope.

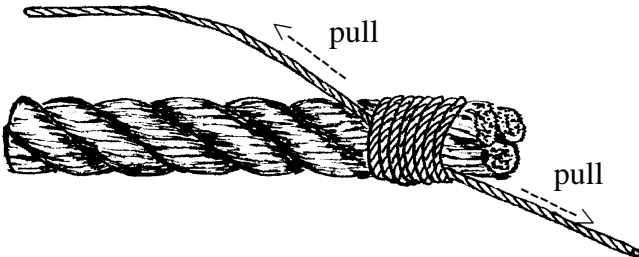

STEP 5: Separate the ends of the rope strands, pull the twine between the strand to the right of the groove that the twine was originally laid in and the other two strands.

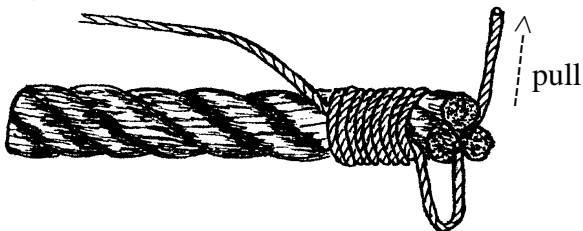

STEP 6: Use a fid to lift the strand of the rope as shown in the diagram (this is the same strand that the twine went around at the end of the rope), reeve the twine under the strand; pull twine tight.

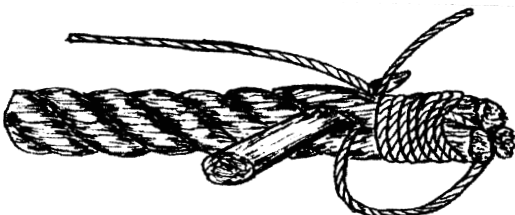

STEP 7: Lay the twine over the original groove and then pull the twine between the ends of the rope strands so that the twine is around the rope strand to the left of the original groove; pull twine tight.

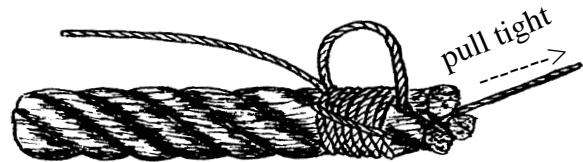

STEP 8: Use a fid to lift the rope strand as shown in the diagram (this is the same strand that the twine went around at the end of the rope); reeve the ends of the twine through the opening and tie a half knot as shown in the diagram; pull twine tight.

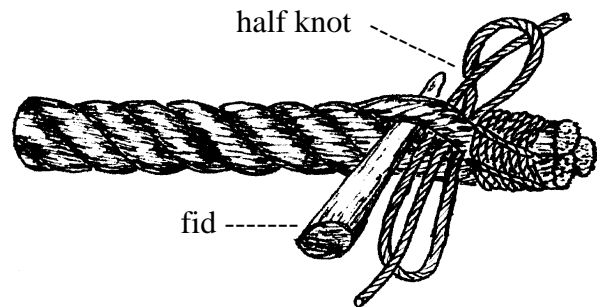

STEP 9: Reeve the ends of the twine through the opening again; tie a second half knot in the opposite direction as shown in the diagram; pull twine tight to form a square knot.

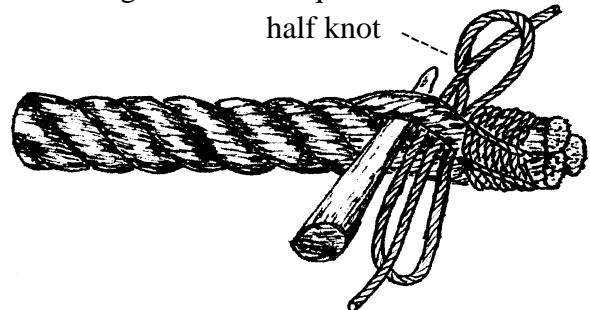

STEP 10: Remove the fid and trim the ends of the twine close to the surface of the rope.



[NOTE] If synthetic rope and twine were used the ends of the rope and the twine may be fused.

FIGURE-EIGHT KNOT:

Description ---- Interlocking overhand loops, the running part goes through the eye of one loop and the standing part goes through the eye of the other loop.

Use ---- (1) As a stopper knot; to keep a rope from unreeving from a pulley block; to prevent a rope from unlaying. (2) When tied on a bight, makes a reliable loop for rescue work and mountaineering.

Comments ---- Easier to tie and untie than an overhand knot; does not damage the rope fiber or jam like an overhand knot.

Narration ---- (For **figure eight** knotboard.) (1) Form an overhand loop. (2) Take a bight around the standing part. (3) Form the second overhand loop by bring the running part over the top edge of the first overhand loop. (4) Complete the knot by reeving the running part through the eye of the first overhand loop (5) and pull tight.

FIGURE EIGHT ON A BIGHT:

Description ---- Interlocking overhand loops tied on a bight in the running part (the bight is used as the running part); the running part goes through the eye of one loop and the standing part goes through the eye of the other loop.

Use ---- (1) Makes a reliable loop for rescue work and mountaineering. (2) As a stopper knot; to keep a rope from unreeving from a pulley block; to prevent a rope from unlaying.

Comments ---- Easier to tie and untie than an overhand knot; does not damage the rope fiber or jam like an overhand knot on a bight.

Narration ---- (For **figure eight on a bight** knotboard.) (1) Form a bight in the rope. [NOTE] Treat the two strands of the bight as a single strand as the rest of the knot is tied. (2) Form an overhand loop. (3) Take a bight around the standing part. (4) Form the second overhand loop by bring the running part over the top edge of the first overhand loop. (5) Complete the knot by reeving the running part through the eye of the first overhand loop (6) and pull tight.

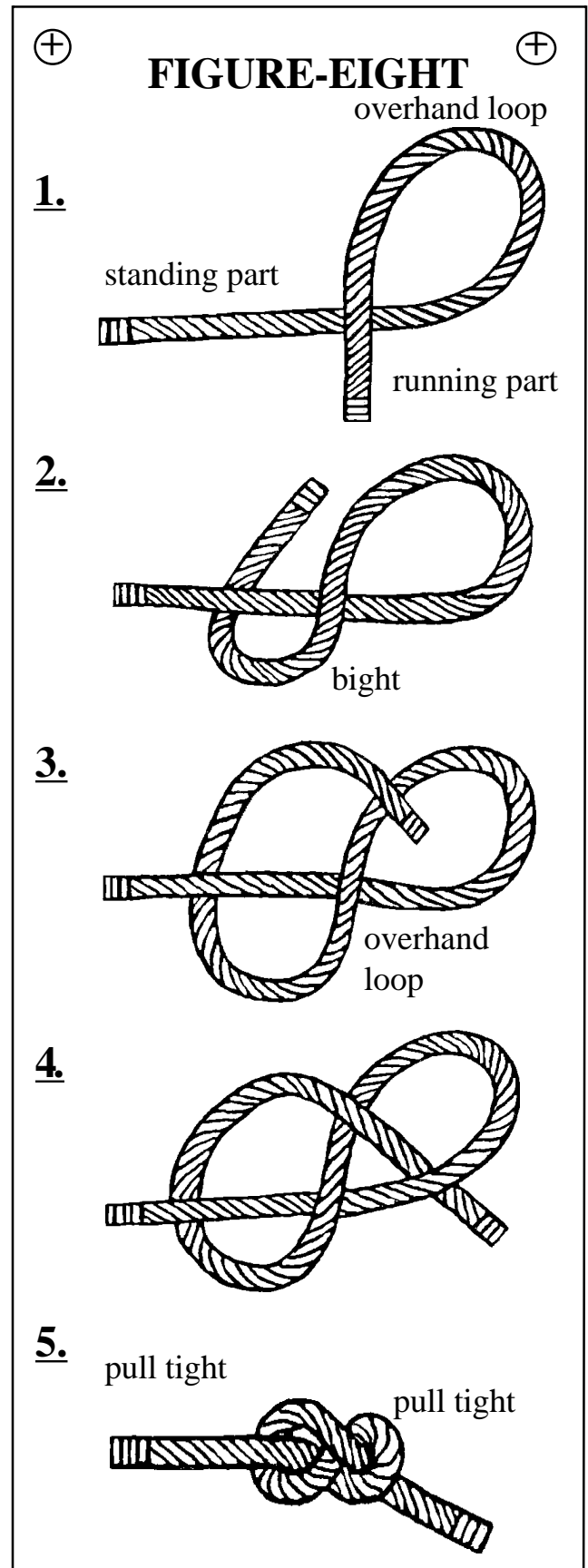
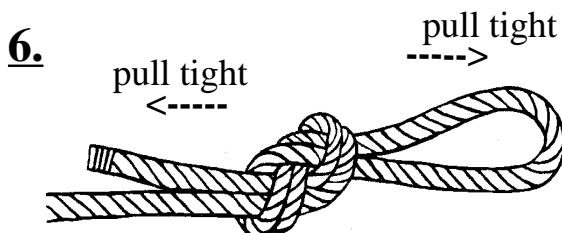
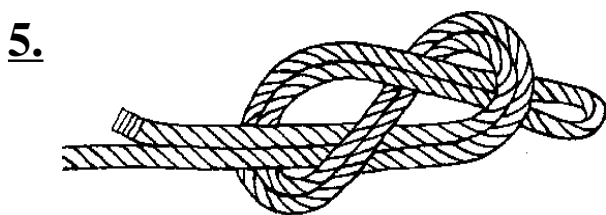
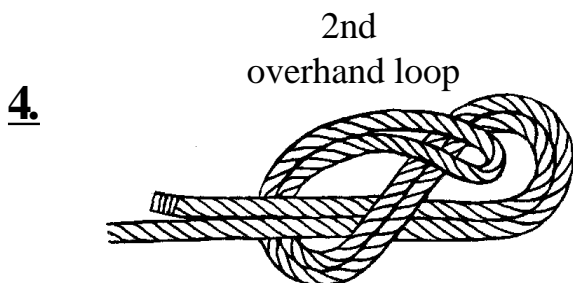
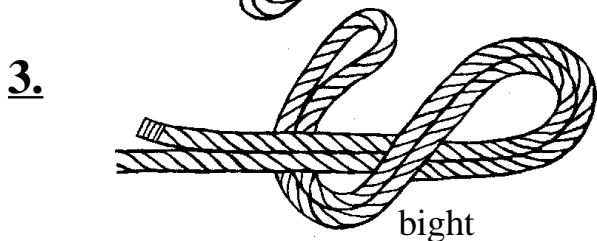
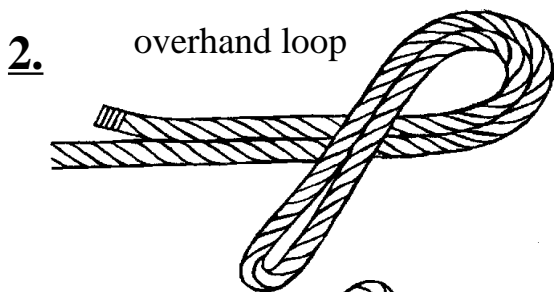
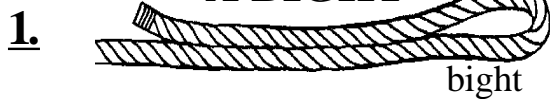



FIGURE-EIGHT ON A BIGHT



[NOTE]

TRIPOD LASHING:

Description ---- A shear lashing around 3 poles.

Use ---- To bind three poles together, for the construction of a tripod. ---- To bind three poles together that contact at the same point in a structure.

Comments ----The tripod lashing is a shear lashing that binds three poles together at the same point. ---- The tripod lashing gets its name from the fact that its most common use is the construction of a tripod. ----The tripod lashing can be used just about any where in a structure that three poles cross each other at the same point and the same time in the sequence of construction. ---- Tripod lashing takes two main forms; with racked wrapping turns (the rope is woven between the poles) and with plain wrapping turns (the rope is wrapped around the poles without weaving the rope between the poles). When the lashing is made with racking turns the rope contacts each pole around its entire circumference ; this contact makes the tripod lashing with racking turns the most secure form of tripod lashing; therefore tripod lashing with racking turns should be used when safety is important. However, for light structures where there would be no danger if the lashing slipped, the faster to tie tripod lashing with plain wrapping turns may be used.

Laying Out The Poles ---- For most tripod lashings, lay the pole side by side with the butt ends aligned. The alignment of the butts of the pole insures that the tripod legs are the desired length.

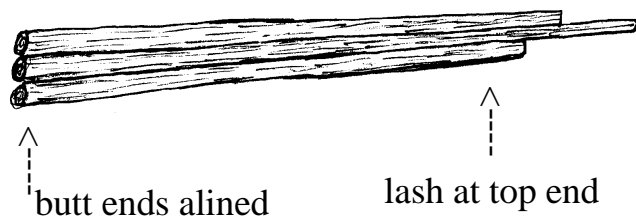

[NOTE] The practice of laying the center pole in the opposite direction to the outside poles creates several problems. When the poles are laid

in opposite directions the wrappings must be put on loosely so that when the center pole is rotated to its proper position the lashing is tightened around the poles. If the wrappings are put on to tight, the rope is stretched causing damage to the rope fibers, therefore weakening the lashing. On the other hand, if the rope is wrapped too loosely, the lashing will not tighten enough when the center pole is rotated and the lashing will be able to slip along the length of the pole. Either way, the rope too loose or the rope too tight, a dangerous situation is created.

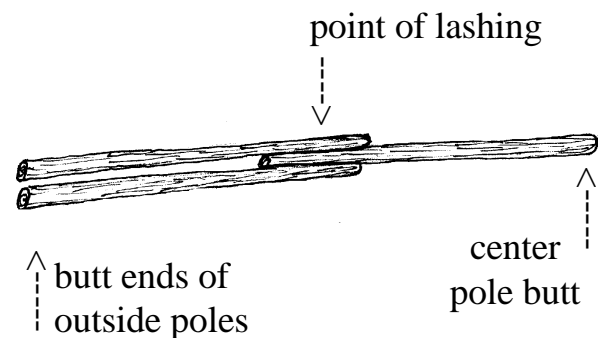

However, if the tripod is to be part of a structure and the center pole will be at an angle greater than 90° to the outside poles, lay the center pole in the opposite direction to the outside poles so that the rotation of the poles at the lashing is less than 90° . See gate way below for an example.

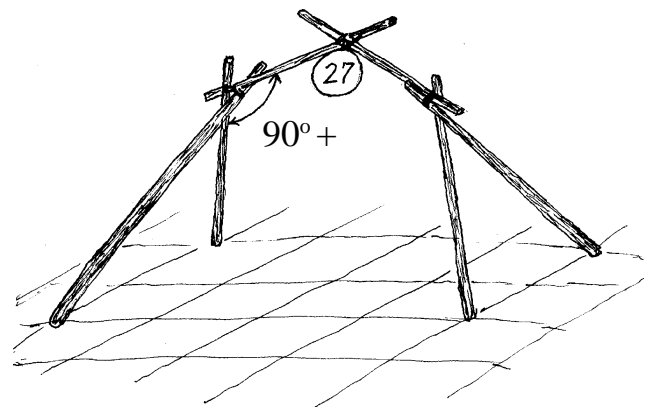

Setting Up A Tripod ----- Set up the tripod by crossing the outside poles so that the cross point of the poles is under the center pole. Crossing the outside poles under the center pole causes part of the load that is placed on the tripod to be taken up by the wood to wood contact of the poles.

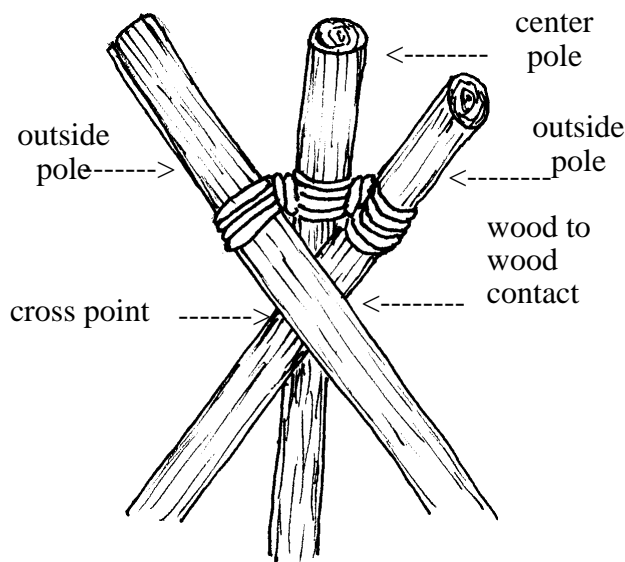

If the outside poles are crossed above the center pole, the rope of the lashing will be required to support all or most of the load; therefore the tripod will not be as strong as when the outside legs are crossed under the lashing.

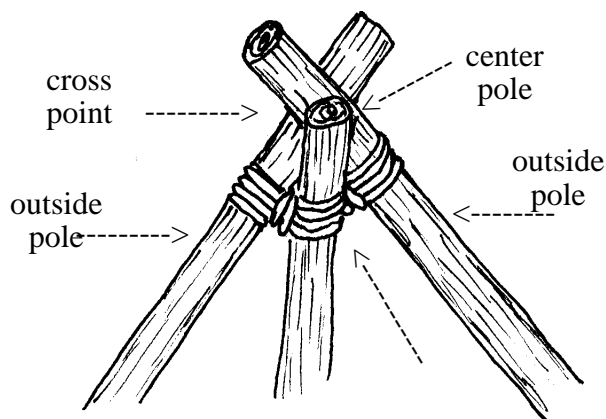

no wood to wood contact, rope supports load

If a symmetrical arrangement of the poles is needed within a structure, the tripod can be set up by rotating the poles around the lashing. This rotation causes the loss of the wood to wood contact so that the load is supported only by the ropes, and the joint between the poles becomes very flexible; therefore the tripod may be unstable.

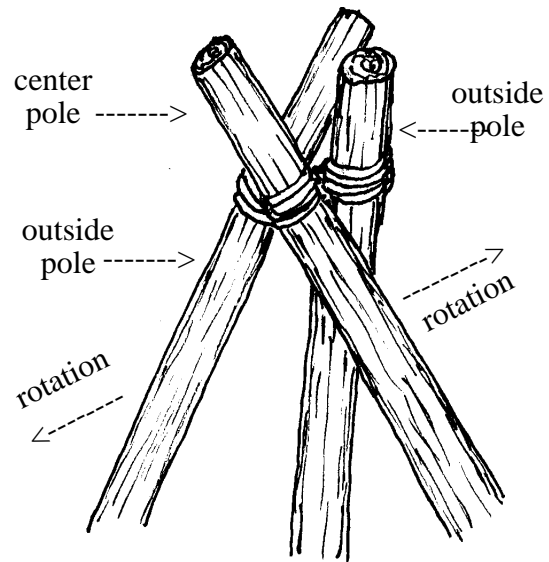

TRIPOD LASHING: (With Racking Turns)

Narration ---- (For tripod lashing with racking turns knotboard.) (1) Tie a clove hitch around one of the outside poles. (2) Secure the standing part by wrapping it around the running part. [NOTE] Wrapping the standing part around the running part prevents the clove hitch from slipping around the pole. If the clove hitch slips the lashing will loosen up from the inside. (3) Start the racked wrapping turns by weaving the rope between the poles. (4) Take a total of 5 to 7 wrapping turns. Pull each wrapping turn tight as it is made. [NOTE] The stiffness of the tripod lashing depends on the number and tightness of the wrapping turns. As the tightness of the wrapping turns or the number of wrapping turns increases, the stiffness of the tripod will increase. (5) Take the first frapping turn by taking the rope around the pole that the clove hitch



+ **TRIPOD LASHING** **+**
WITH RACKING TURNS

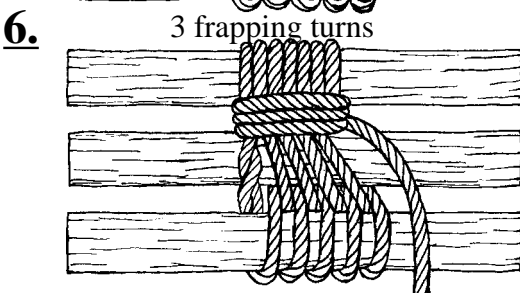
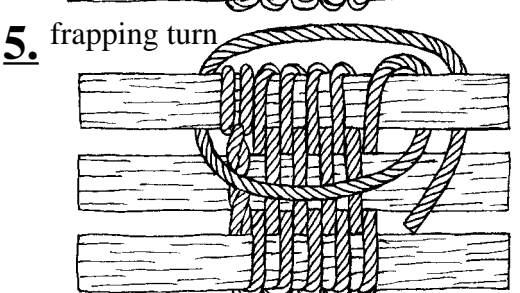
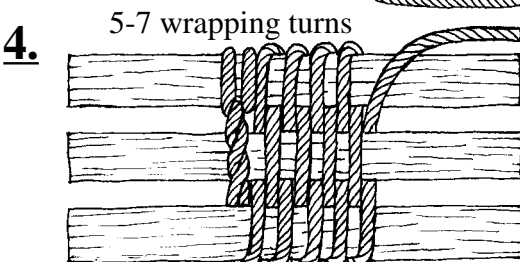
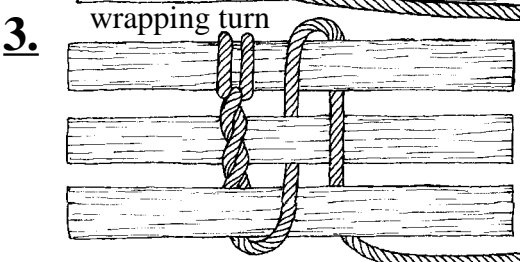
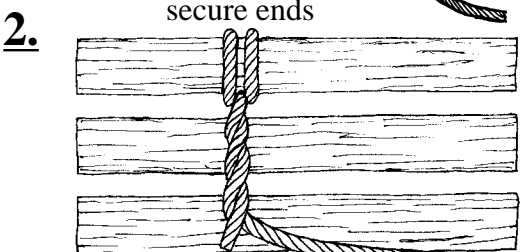
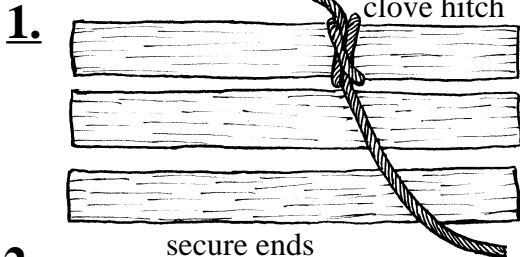

pull each turn tight

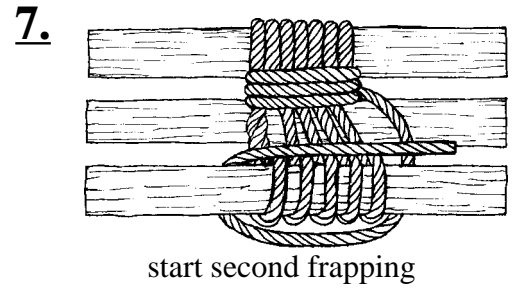

start second frapping

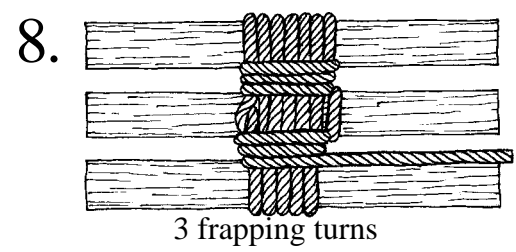

3 frapping turns

pull each turn tight

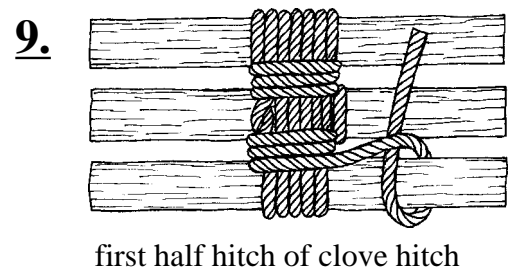

first half hitch of clove hitch

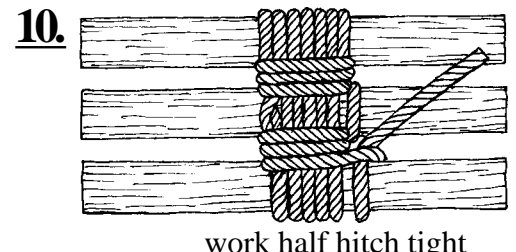

work half hitch tight

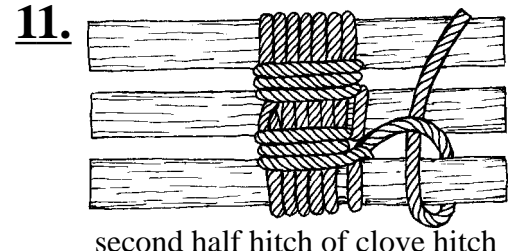

second half hitch of clove hitch

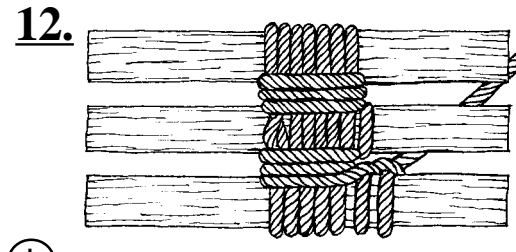

work clove hitch tight

+

+

was tied to, then between the outside pole and the center pole. (6) Take 3 frapping turns. Pull each frapping turn tight as it is made. (7) Start the second set of frapping turns by taking the rope across the center pole and reeving it between the second outside pole and the center pole. Take the second set of frapping turns in the opposite direction to the first set of frapping turns. [NOTE] Taking the second set of frapping turns in the opposite direction to the first set of frapping turns prevents the rope from crossing the wrappings at a diagonal. Unnecessary crossing of the rope increases friction between the strands of the rope making it difficult to tighten the lashing properly. (8) Take a total of 3 frapping turns. Pull each turn tight. (9) Take the first half hitch of the ending clove hitch around the second outside pole by taking the rope past the pole and then around the pole. (10) Work the half hitch tight so that it is locked against the lashing. [NOTE] See the narration for square lashing for instructions on working the half hitch tight. (11) Take the second half hitch of the ending clove hitch. (12) Work the half hitch tight to complete the ending clove hitch. [NOTE] If the clove hitch is not worked tight so that it is locked against the lashing the clove hitch will slip around the pole allowing the lashing to loosen. [NOTE] If very smooth rope is being used, a 3rd half hitch should be added to the clove hitch to insure that the lashing will stay in place.

TRIPOD LASHING: **(WITH PLAIN TURNS)**

Narration ---- (For tripod lashing with plain turns knotboard.) (1) Tie a clove hitch around one of the outside poles. (2) Secure the standing part by wrapping it around the running part. [NOTE] Wrapping the standing part prevents the clove hitch from slipping around the pole. If the clove hitch slips the lashing will loosen up from the inside. (3) Start the wrapping turns by wrapping the rope around the poles. Take a total of 4 to 6 wrapping turns. Pull each wrapping turn tight as it is made. [NOTE] The stiffness of the tripod lashing depends on the number and tightness of the wrapping turns. As the tightness of the

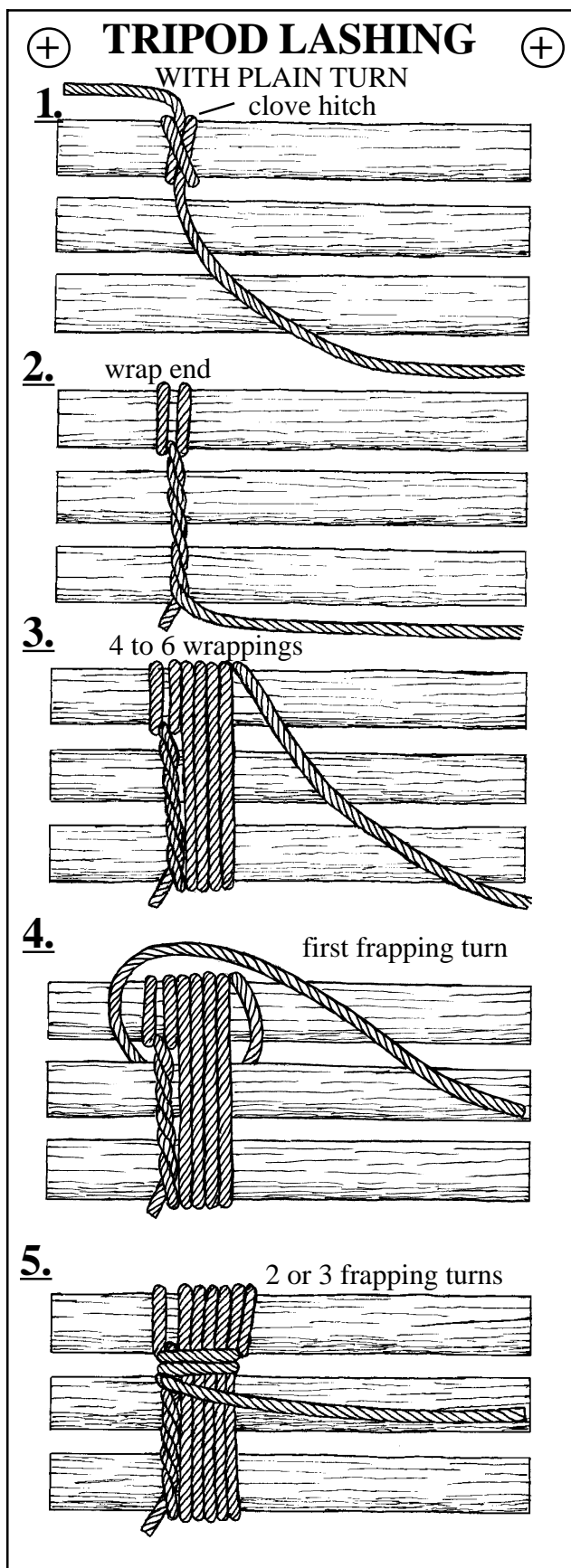

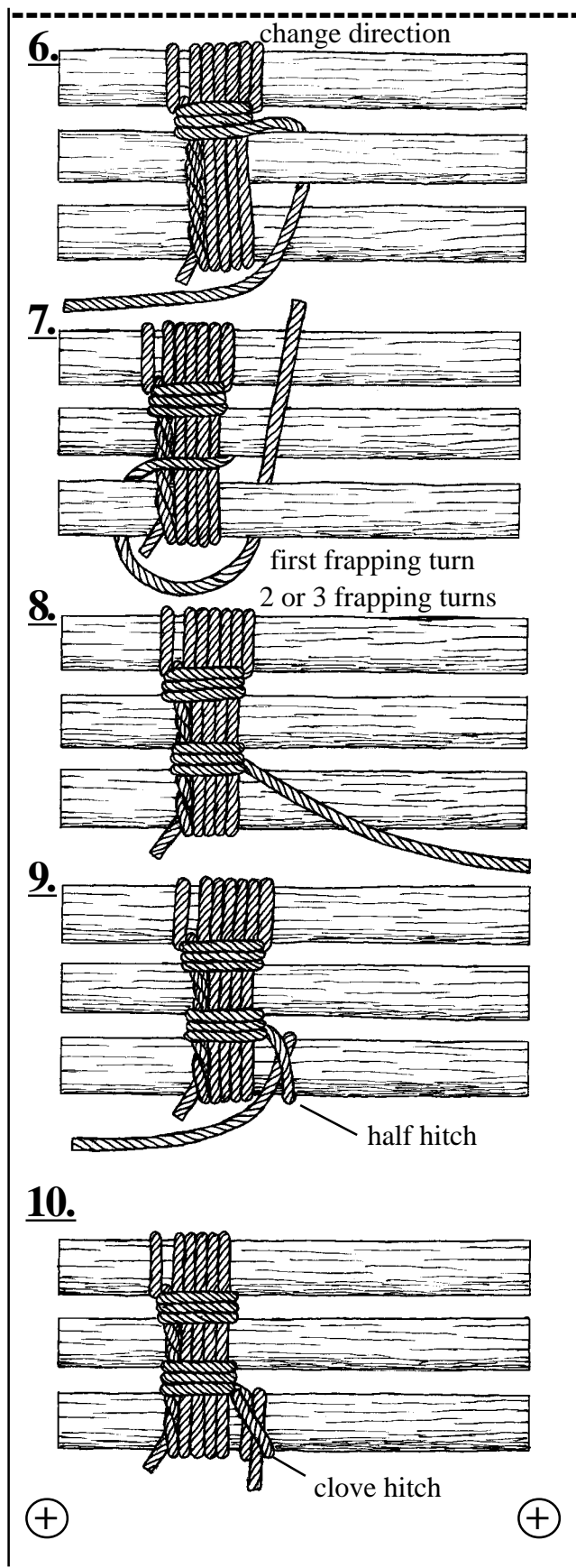

wrapping turns or the number of wrapping turns increases, the stiffness of the tripod will increase. (4) Take the first frapping turn by passing the rope around the pole that the clove hitch was tied to, then between the outside pole and the center pole. (5) Take 2 or 3 frapping turns. Pull each frapping turn tight as it is made. (6) Start the second set of frapping turns by taking the rope around the center pole and reeving it between the second outside pole and the center pole. (7) Take the second set of frapping turns in the opposite direction to the first set of frapping turns. [NOTE] Taking the second set of frapping turns in the opposite direction to the first set of frapping turns prevents the rope from crossing the wrappings at a diagonal. Unnecessary crossing of the rope increases friction between the strands of the rope making it difficult to tighten the lashing properly. (8) Take a total of 2 or 3 frapping turns. Pull each turn tight. (9) Take the first half hitch of the ending clove hitch around the second outside pole by taking the rope past the pole and then around the pole. Work the half hitch tight so that it is locked against the lashing. [NOTE] See the narration for square lashing for instructions on working the half hitch tight. (10) Take the second half hitch of the ending clove hitch. Work the half hitch tight to complete the ending clove hitch. [NOTE] If the clove hitch is not worked tight so that it is locked against the lashing the clove hitch will slip around the pole allowing the lashing to loosen. [NOTE] If very smooth rope is being used, a 3rd half hitch should be added to the clove hitch to insure that the lashing will stay in place.

QUICK TRIPOD LASHING:

Comments ---- The tripod quick lash is one of the fastest ways to construct a tripod. However the tripod quick lash is not as secure as the more conventional methods, therefore the tripod quick lash tripod should not be use for heavy loads.

Directions -----

STEP 1] Lay the poles side by side with the with the butt ends alined. Wrap 5 to 8 wrappings around all three poles.

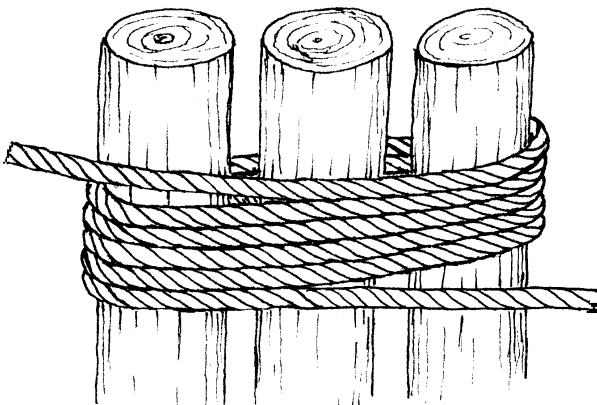

STEP 2] Start the frapping turn by taking each end around an outside pole and then between the outside pole and the center pole.

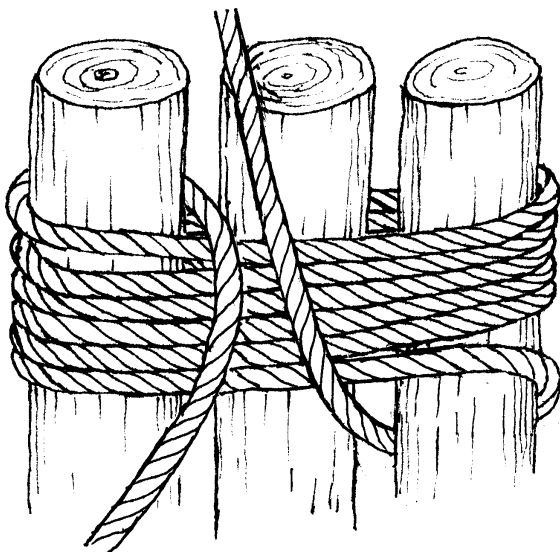

STEP 3] Take 1 or 2 frapping turns with each end. Pull the frapping turns tight; this will also tighten the wrappings.

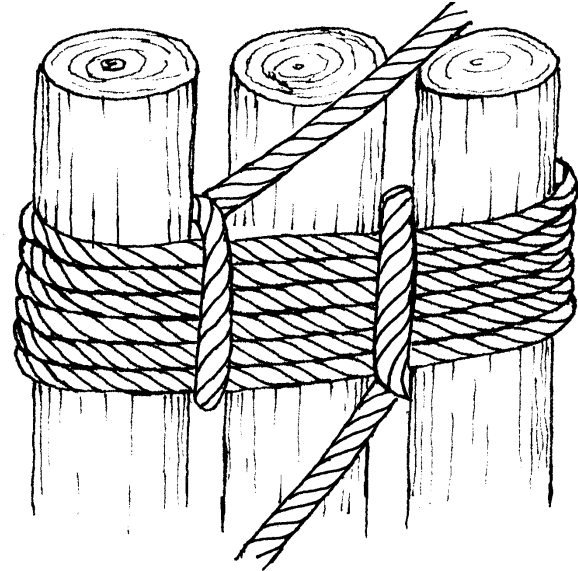

[NOTE] The frapping turns are taken in opposite directions.

STEP 4] End the lashing by tying the ends of the rope together with a square knot.

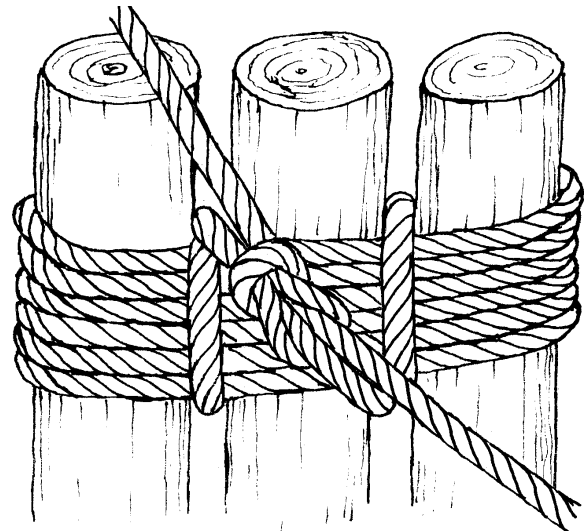

[WARNING]

If one end of the square knot is pulled it can be up set into a lark's head knot. When this happens the knot will slip causing the entire lashing to loosen and fail.

SHEET BEND:

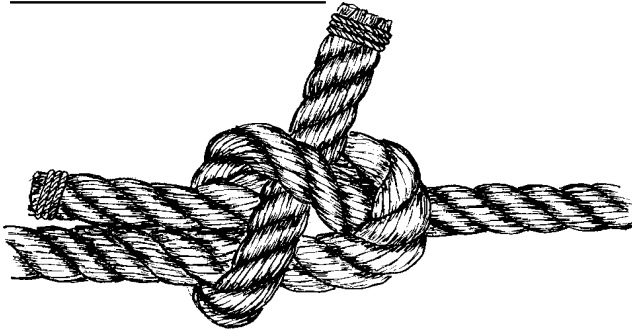

Description ---- An interlocked bight and half hitch.

Use ---- To temporarily join two ropes, especially if the ropes are of different sizes.

Comments ---- The sheet bend is a secure but easily untied knot. ---- When tying the sheet bend the running parts should be left long because there is some initial slip in the knot when the knot is first brought under tension. ---- The proper and more secure way to tie the sheet bend is so that the two ends of the rope are on the same side of the knot.

Other Names ---- Weavers knot

Related Knots ---- Bowline; becket hitch; these knots share the same form but are tied in a different way or have a different use.

Narrative ---- (For **sheet bend** knotboard.) (1) Form a bight in the running part of the left-hand rope. (2) Reeve the running part of the right-hand rope through the eye of the bight in the left-hand rope. (3) With the right-hand running part take a bight around the running part and the standing part of the left-hand rope. (4) Pass the right-hand running part over the left-hand standing part, (5) under the right-hand rope, and (6) over the standing part of the left-hand rope. (7) Pull tight.

SHEET BEND

1.

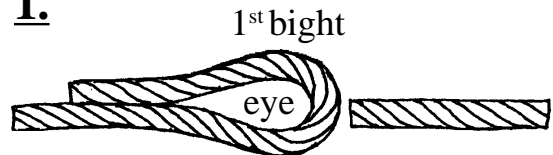

2.

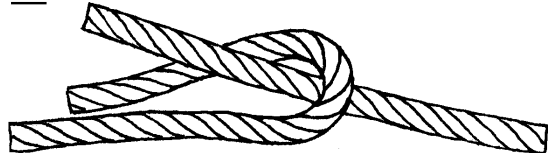

3.

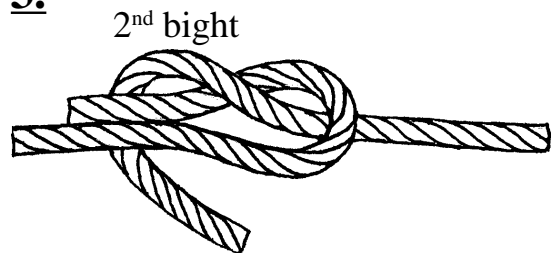

4.

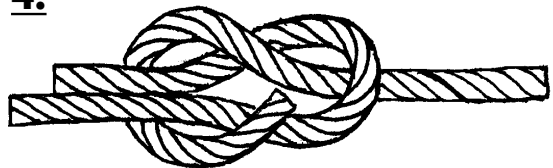

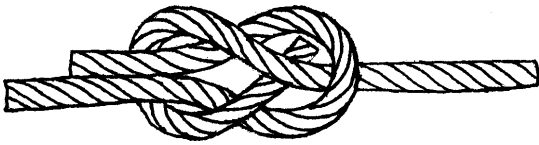
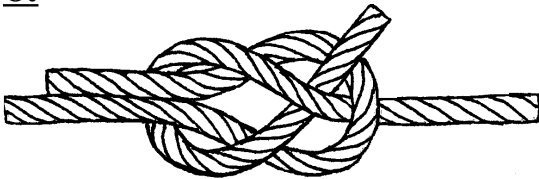
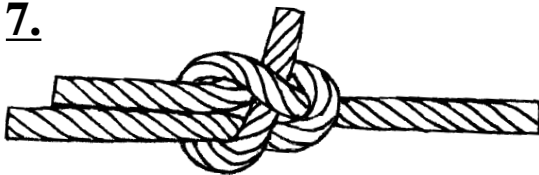
56.7.

<----- pull tight ----->

opposite side

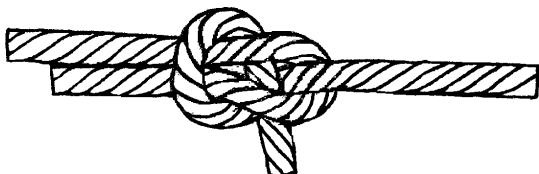

WEAVER'S KNOT:

Description ---- A different method of tying a sheet bend.

Use ---- For joining light twine and yarn together, especially by weavers.

Comments ---- This method of tying the sheet bend is faster than the usual method

Narration ----- (For **weaver's knot** knotboard.)

(1) Cross the left-hand running part over the right-hand running part. Hold this cross point together between the thumb and first finger of the left hand. (2) With the right hand, grasp the right-hand standing part and make a loop over the thumb and (3) between the standing parts so as to form a half hitch around the left-hand rope. (4) Fold the running part of the left-hand rope back along itself to form a bight around the standing part of the right-hand rope. (5) Reeve the running part of the left-hand rope through the eye of the half hitch and pull the knot tight to complete the knot.



+

+

WEAVER'S KNOT:

1.

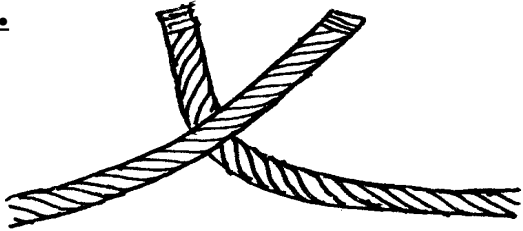

2.

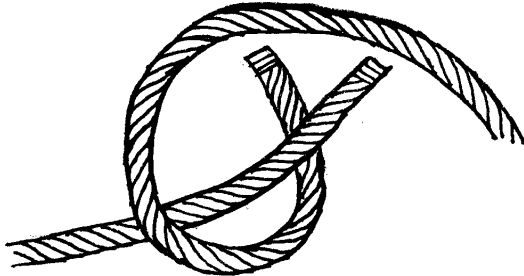

3.

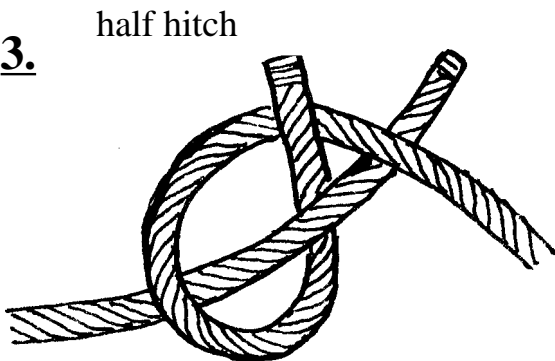

4.

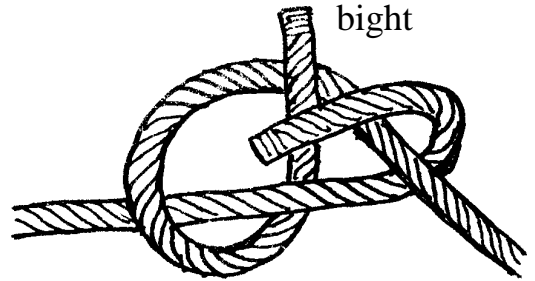

5.

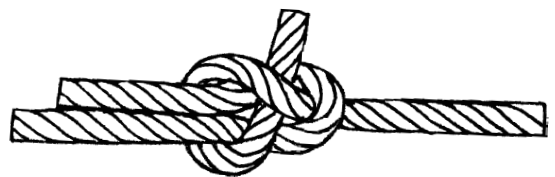
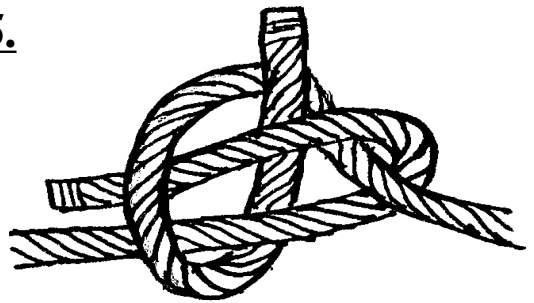

<----- pull tight ----->

+

+



BECKET HITCH:

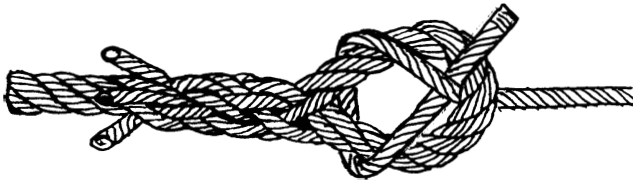

Description ---- A half hitch tied around a permanent eye, such as the eye of an eye splice or a hook.

Use ---- To tie a rope to an eye splice, a hook or a ring.

Comments The becket hitch has the same form as the sheet bend but is used to tie a rope to an eye or hook, whereas the sheet bend is used to join two ropes.

DOUBLE SHEET BEND:

Comments ---- This method of tying the sheet bend is the most secure form of the sheet bend and should be used if there is a significant difference in the sizes of the two ropes that are being used.

Narrative ---- (For **double sheet bend** knotboard.)

- (1) Form a bight in the larger of the two ropes.
- (2) Reeve the smaller rope through the eye of the bight.
- (3) Then take a bight around the part of the larger rope; be sure to take the bight from the standing part side to the running part side.
- (4) Bring the running part of the smaller rope over the larger rope and (5) under the smaller rope to form a half hitch around the two parts of the bight in the larger rope. This forms the first turn.
- (6) Take a second bight around the larger rope.
- (7) Again bring the smaller rope over the larger rope and under the smaller rope to complete the second turn.
- (8) Pull tight.

[NOTE] If the difference in the sizes of the ropes is significant or the ropes are very smooth, additional turns of the smaller rope will help to prevent the ropes from slipping.

+

+

DOUBLE SHEET BEND

1.

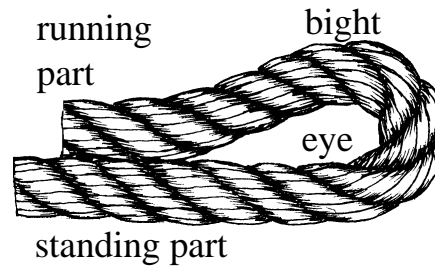

2.

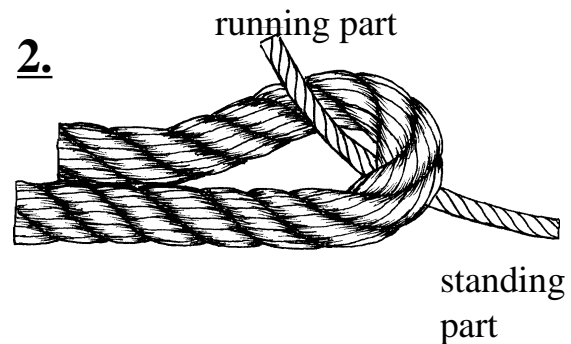

3.

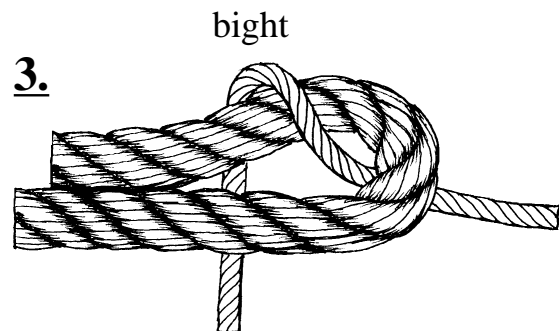

4.

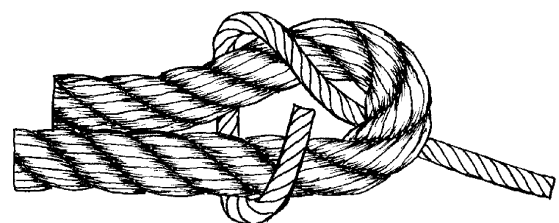



SHEET BEND ON A SHORT END:

Use ---- For joining light rope, twine, thread, and yarn.

Comments ---- This method of tying the sheet bend is useful for tying a piece of rope onto another rope when the end of the rope is very short.

Narrative ---- (For **sheet bend on a short end** knotboard.) (1) Form an overhand loop. (2) Fold the loop over onto its standing part. (3) Pull a bight of the standing part through the loop to form an overhand knot in the running part. (4) Pull on the standing part and the running part of the overhand knot to close the eye around the standing part to form a slip noose. (5) Place the eye of the slip noose over the running part of the second rope. (6) Pull on the running part of the first rope and push on the overhand knot to upset the slip noose so that a bight of the second rope is pulled through the overhand loop to form the sheet bend. (7) Pull on the standing parts of each rope to tighten the sheet bend.

[NOTES]

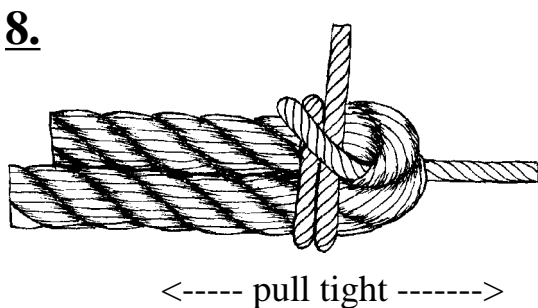
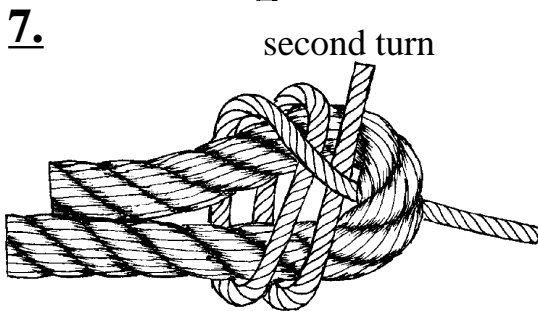
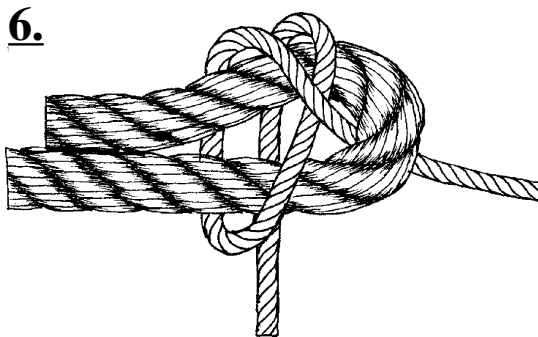
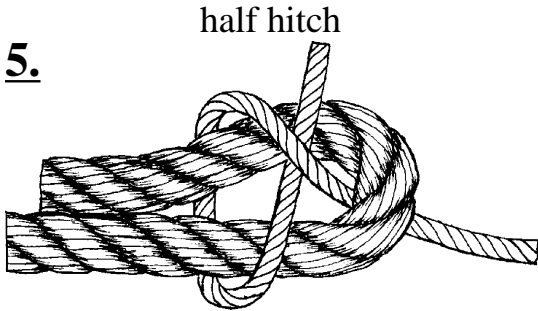



+

SHEET BEND (SHORT END)

+

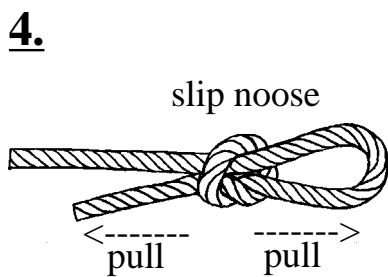
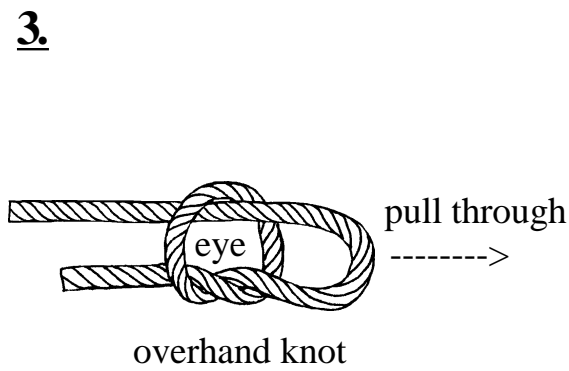
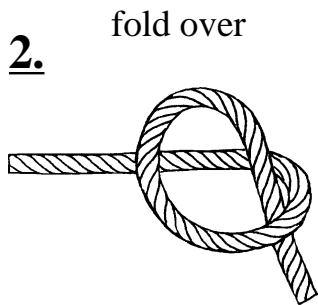
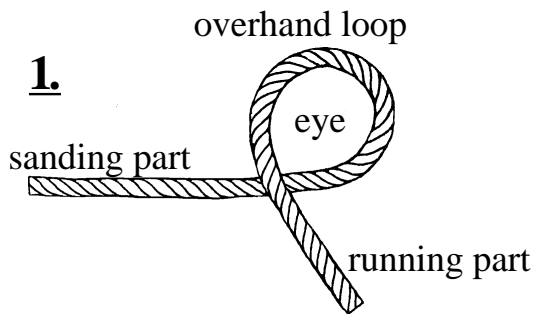

5.

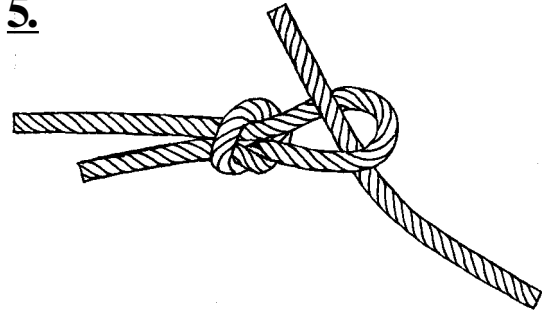

6.

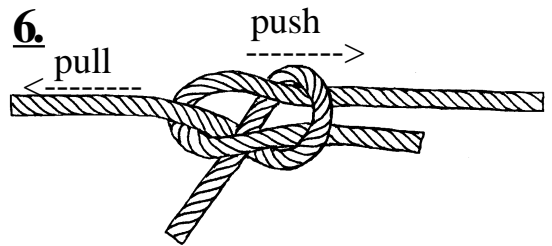

7.

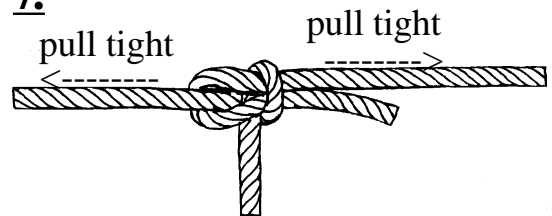

back view

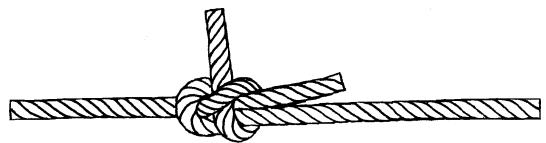

+

+

MASTHEAD KNOT:

Comments ---- There are several forms of the Masthead Knot, two of which are shown here. The first form of the Masthead Knot was chosen for its symmetry and the ease of transition to the running half hitches used to secure it to the pole. The second form was chosen for the ease with which it can be tied.

Use ---- On board ship, a masthead knot was used to rig a temporary mast if the mast was lost in battle or during a storm. On land a masthead knot can be used to rig a gin pole or a flag pole.

Other names ---- Jury mast knot, pitcher knot.

MASTHEAD KNOT (1):

Description ---- A multiple loop knot formed by reeving the loosely made loops of two over hand knots through each other and then securing the knot to a mast (pole).

Narration ----- (For **masthead knot (1)** knot-board.) (1) Loosely tie two over hand knots. (2) Place the loop of one overhand knot on top of the loop of the loop of the other over hand knot. (3&4) Reeve the loops of the overhand knot through the half knot part of the opposite overhand knot. (5) Place over a pole and draw the three loops up even. (6) Secure to the pole with a series of running half hitches above and below the mast head knot.

[NOTE] A fourth loop may be formed by tying or splicing the ends together. If a fourth loop is made, nail a cleats to the pole to prevent the mast head knot from slipping.

[NOTE] Attach the guy lines to the loops with becket hitches.



+

+

MASTHEAD KNOT (1)

1.

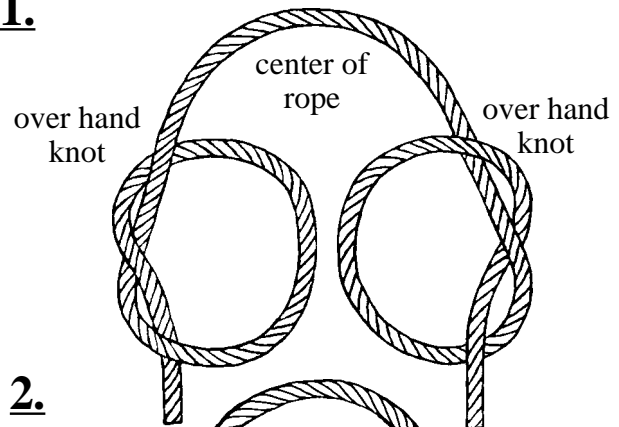

2.

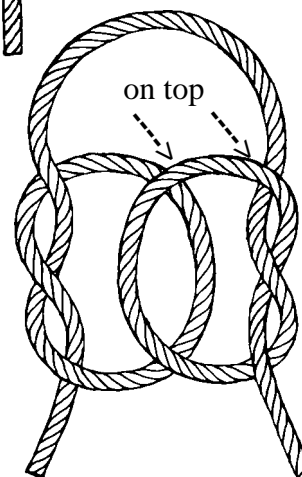

3.

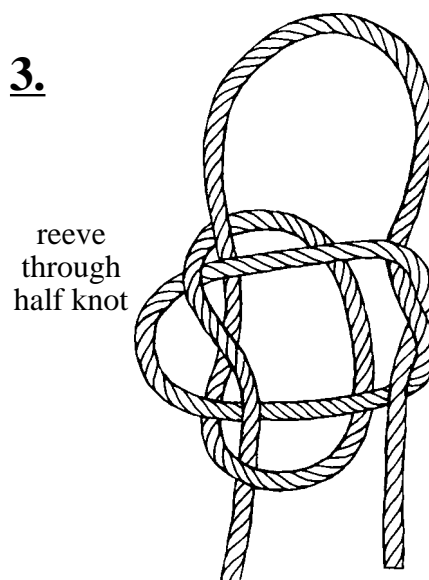



4.

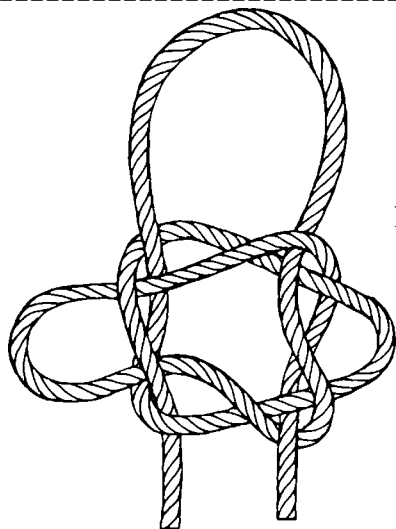

reeve through half knot

5. place over pole and draw up even

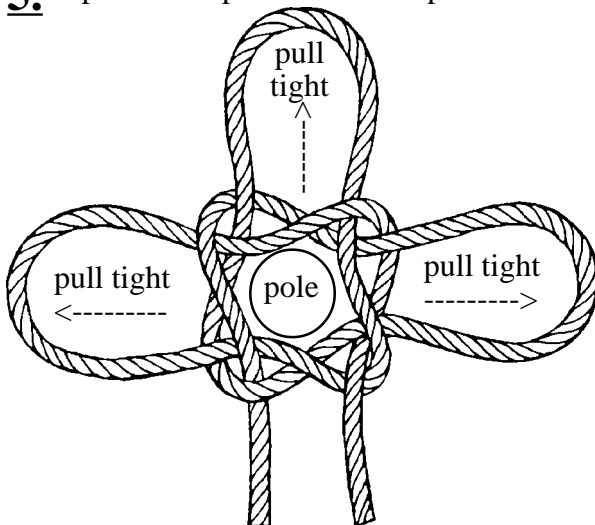

6. secure to pole with running half hitches

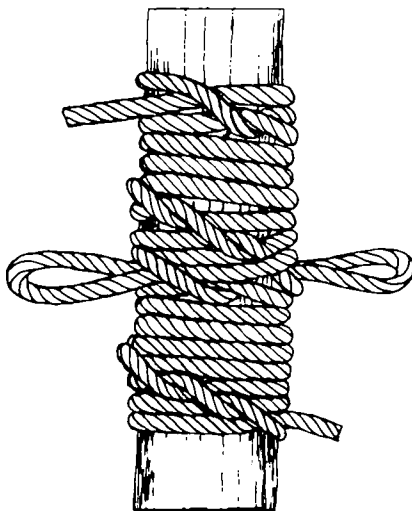

MASTHEAD KNOT (2):

Description ---- A multiple loop knot formed by weaving three overlapping over hand loops together and then securing the knot to a mast.

Narration ----- (For **masthead knot (2)** knot-board.) (1) Form an over hand loop near the center of the rope. [NOTE] The size of the loop is determined by the size of the pole that the finished knot is to be placed over. (2) Form a second larger overhand loop at the center of the rope. (3) Place the left edge of the second overhand loop under the right edge of the first overhand loop. (4) Form a third overhand loop. (5) place the left edge of the third overhand loop under the right edge of the second overhand loop. (6) Start weaving the over hand loops together by placing the left edge of the right overhand loop on top of the right edge of the left over hand loop. (7) Continue the weaving by placing the right edge of the left overhand loop over the right edge of the center overhand loop and by placing the left edge of the right overhand loop under the left edge of the center overhand loop. (8) Finish the weaving by placing the right edge of the left overhand loop under the right edge of the right overhand loop and by placing the left edge of the right overhand loop over the left edge of the left overhand loop. (9) Place over pole and work tight. The knot is prevented from slipping down the pole by nailing cleats to the pole or by cutting a groove for the knot to rest in. (10) Secure the ends of the rope by seizing them to the adjacent loop; two half hitches may also be used.

[NOTE] A forth loop may be formed by tying or splicing the ends together.

[NOTE] Attach the guy lines to the loops with becket hitches.





(+) (+)

MASTHEAD KNOT (2)

1. over hand loop

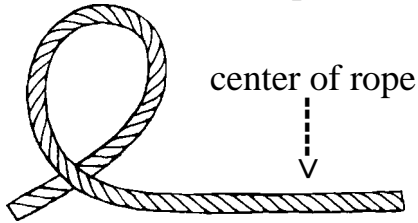

2. 2nd overhand loop

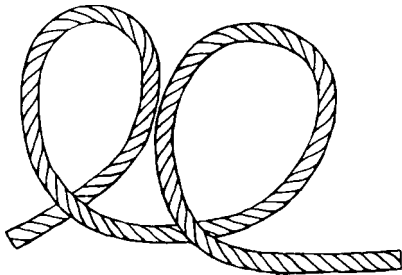

3. place edge under

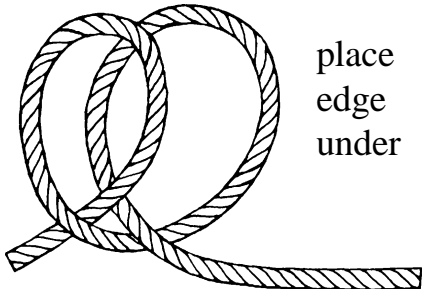

4. 3rd overhand loop

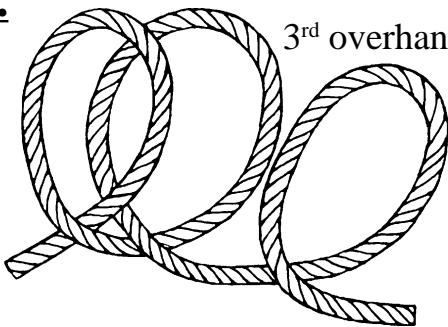

5. place edge under

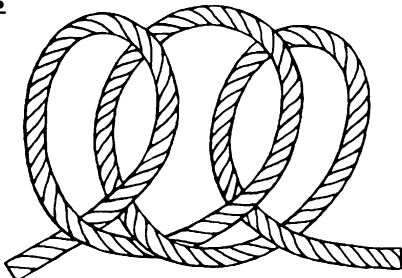

6. start weaving across

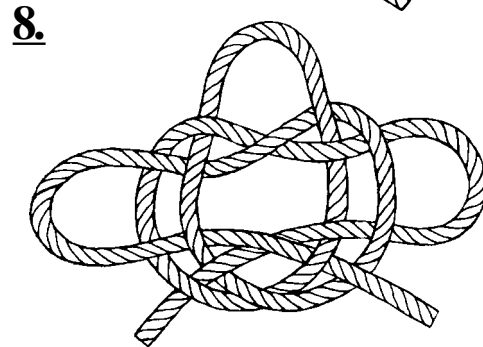
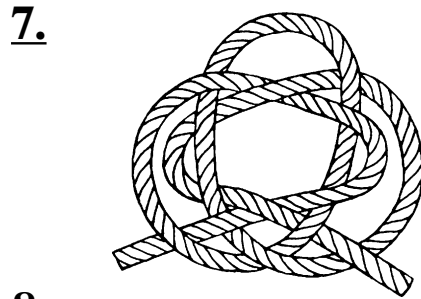
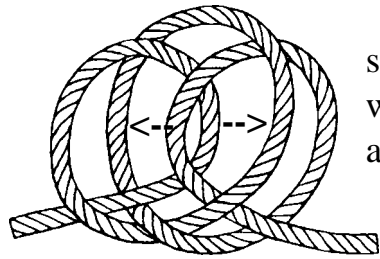

9. place over pole

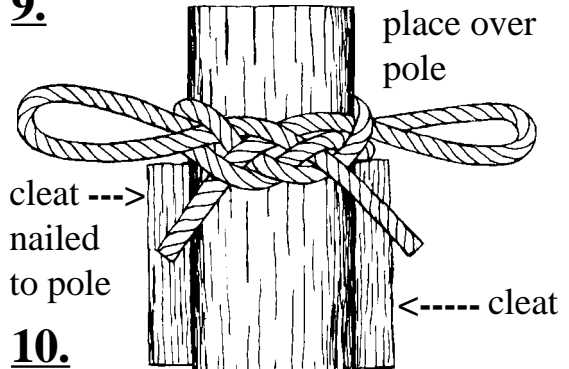

10. seizing

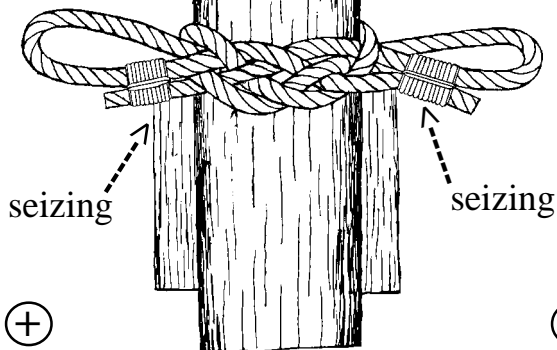

(+) (+)

FLOOR LASHING:

Use ---- to lash a series of poles to a set of stringers to form a flat surface such as a deck, a table top, or a road way.

Comments ---- When using a floor lashing, both ends of the decking poles must be lashed at the same time to insure a firm even surface.

When placing the decking poles on the stringers, lay the decking poles so that their butt end are in alternating direction. Alternating the butt ends of the decking poles will compensate for the natural taper of the poles so that the length of the decking along each stringer will be equal.

Narration ---- (For floor lashing knotboard) (1) Tie a clove hitch around each stringer. (2) Secure the short end of the rope by wrapping it around the running end (wrap with the lay of the rope). (3) Place the decking poles on the stringers and take a bight around the first pole. (4) Next, on the inside of the stringer, pull a bight up between the first decking pole and the next decking pole. (5) Place the eye of the bight over the end of the decking pole. (6) Pull tight. (7) On the outside of the stringer, place a bight over the next decking pole. (8) Pull tight. (9) Repeat steps 4 through 8 until all decking poles are lashed in place. (10) Tie the first half hitch of the ending clove hitch. Work half hitch tight. (11) Tie the second half hitch of the ending clove hitch. Work half hitch tight (12) to form clove hitch.

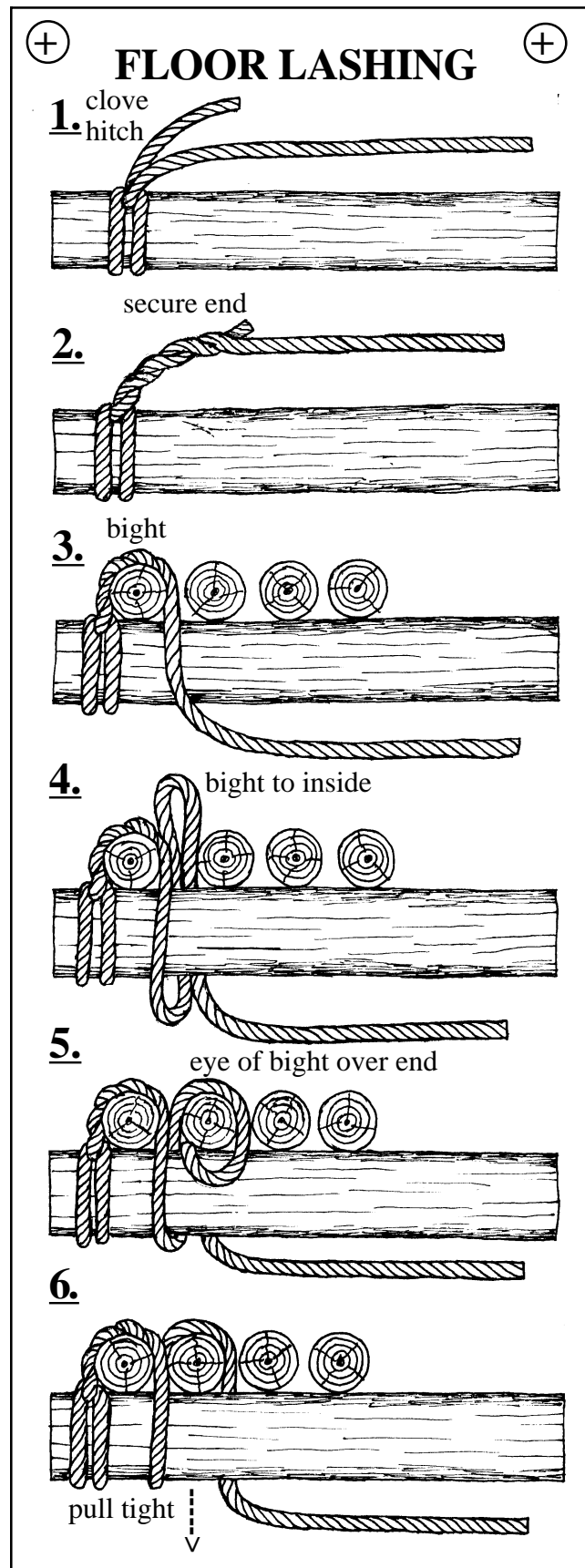



7. bight to outside

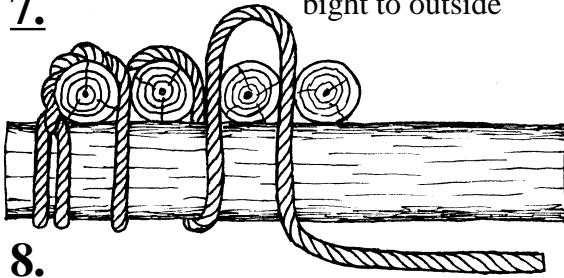

8.

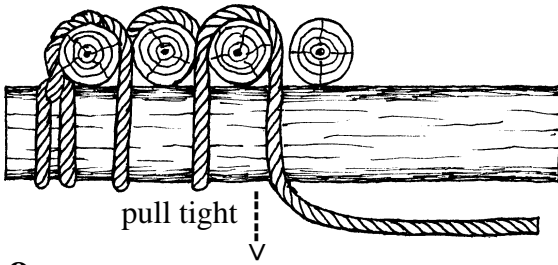

9. repeat steps 4 through 8

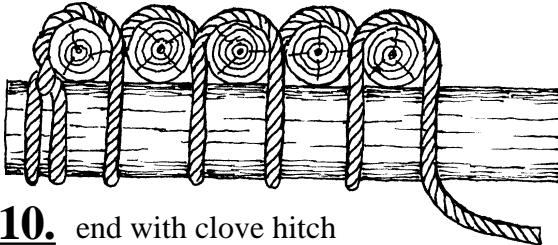

10. end with clove hitch

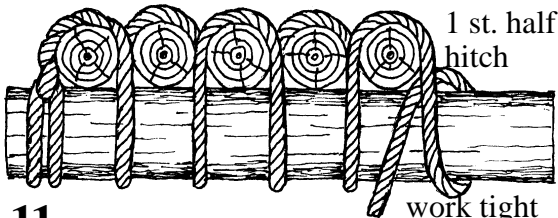

11.

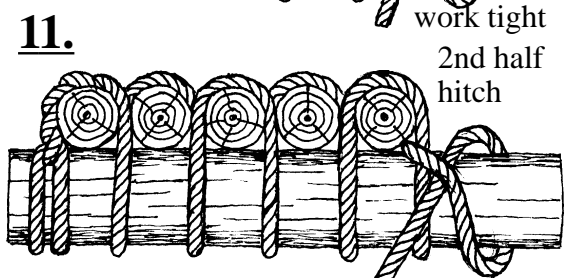

12.

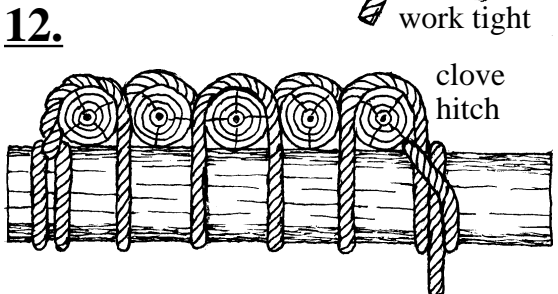

[NOTES]



Mauls:

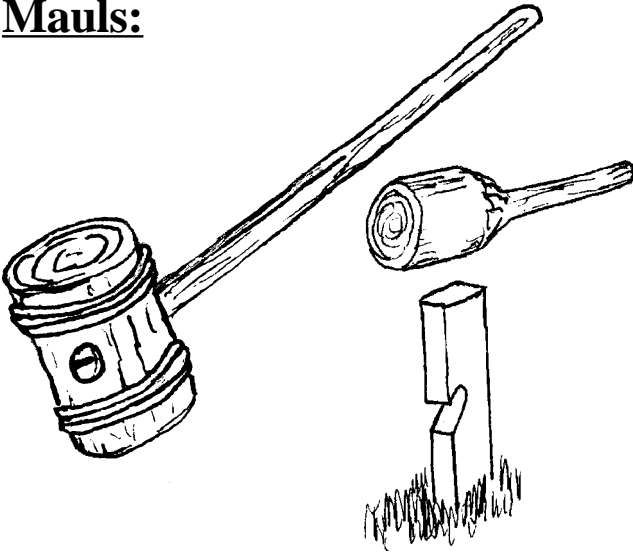

A maul is a wooden club or hammer that is used for driving stakes or wedges and for safety reasons should be used instead of an ax.

Using an ax instead of a maul exposes the user to the danger of being cut by its sharp edge. Even if the edge is covered by a sheath, a glancing blow can cause the sheath to be ripped off or to be cut through.

The pole of an ax serves as a counterweight to the blade. This counterweight adds to the balance of the ax head and helps to control and increase the force of momentum delivered to the bit. The ax head is shaped in such a way that the momentum of the ax head is delivered through the thin walls of the eye. However, when an ax is being used as a hammer, this same shape causes the eye of the ax head to spread and the handle to loosen.

The flat surface and angular edges of an ax pole makes it difficult to strike a stake squarely. This difficulty in striking a square blow results in most blows delivering some their force sideways, causing the end of the wooden stake to flare and split very quickly. In addition, when the pole of an ax contacts a stake, the metal surface of the pole lacks the ability absorb any of the force of the impact this contributes to the destruction of the stake. A wooden maul, on the other hand, absorbs some of the impact of the initial contact and a maul has no angular edges. Therefore, more of the force of the maul is used to do useful work and less of the force is used up in deforming or splitting the stake.

Making a Club Maul:

A club maul, for driving tent pegs and other light work, can be made from a piece of hardwood that is about 3 inches in diameter and 18 to 24 inches long.

-----18" to 24"-----|



---- 4" to 5" ----|

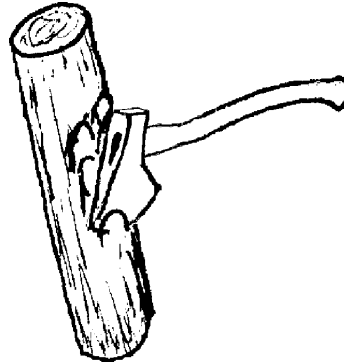

STEP 1: Use an ax to rough out the maul. Form a handle by cutting away one end of the piece of wood so that it is about 1 1/4 inches in diameter. Leave 4 to 5 inches of the other end at its original diameter to form the head of the maul.

STEP 2: Smooth the handle with a knife.

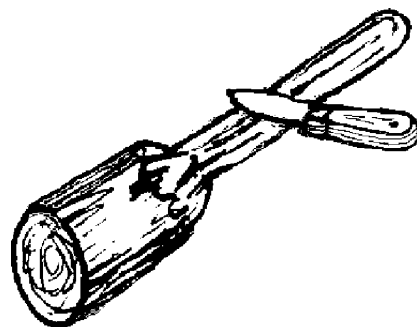

MAKING A HAMMER

MAUL:

Materials:

To make the head of a hammer maul you will need a 4 inch diameter, 10 inch long piece of hard, dense, unchecked, well seasoned, hardwood such as elm, black gum or hophornbeam.

For the handle you will need a piece of well seasoned ash, hickory, or similar straight grained wood; 1 1/2 inch diameter and 3 to 4 foot long.

Making a Maul:

STEP 1: Square the ends of the head with a saw.

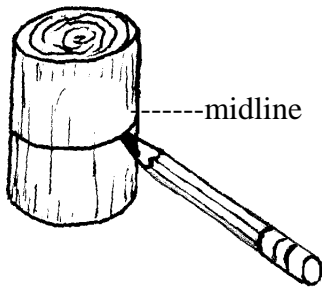

STEP 2: Find and mark the midline between the two ends.

STEP 3: Locate the center of the handle hole on each side of the maul head.

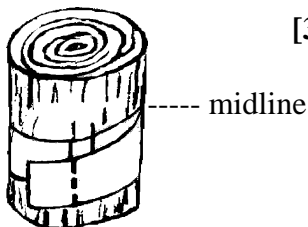

[3A] Wrap a strip of paper around the maul head. Cut the strip of paper off so that the two ends just meet.

[3B] Locate handle hole by folding the strip of paper in half to mark its mid point, then unfold it and wrap it around the maul head again. Mark the midline at the fold and at the ends of the strip of paper.

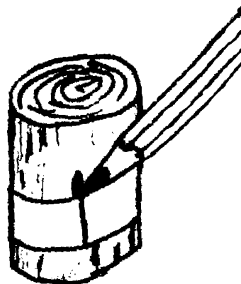

STEP 4: Drill handle hole in head. Use a 1 1/4 inch drill bit to drill a hole halfway through the head from one side, then finish drilling the hole from the other side of the maul head.

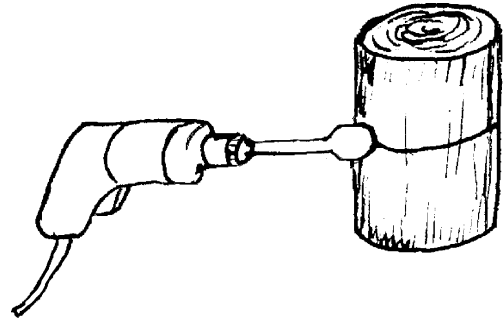

[NOTE] If the holes do not lineup in the middle use a chisel or wood rasp to cut away some of the excess wood.

STEP 5: Make maul handle.



5A] Cut a saw kerft in the one end of the handle. The depth of the kerft should be equal to 1/2 the diameter of the maul head.

5B] Use a knife to shave the end of the handle down until it can be easily driven through the head with light blows with a light wooden block.

STEP 6: Attach the maul head to the handle.

6A] Make a hardwood wedge that is 1 1/4 inch wide, 3 inches long, and 1/4 inch thick at its large end.



6B] Drive the handle into the maul head, make sure that the saw kerft is lined up across the maul head.

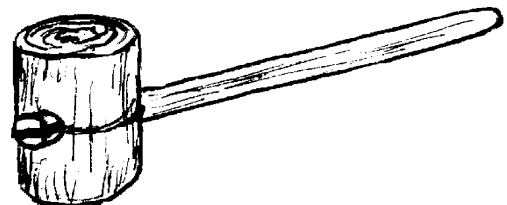

6C] Then drive the wedge in place.

STEP 7: Reinforce the maul head to keep it from splitting by wrapping several turns of rope or wire around each end of the maul head. These can be held in place with staples.

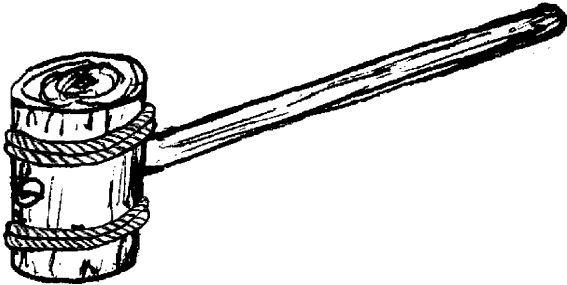

Another method of reinforcing the head would be to drive a braided ring or a grommet over each end of the head.

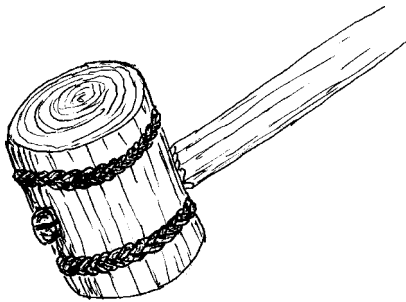

[NOTES]

MAUL --- DOVE TAIL HANDLE:

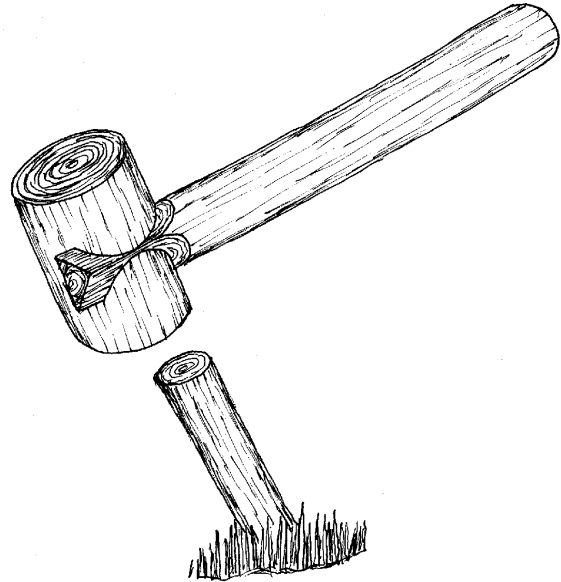

MATERIALS:

- 1 ---- Piece of seasoned hardwood that is 2 2/2 to 3 inches in diameter and 5 to 7 inches long for the head.
- 1 ---- piece of seasoned hardwood that is 1 1/2 inches to 2 inches in diameter for the handle.

CONSTRUCTION:

STEP 1: With a saw, cut 3 kerfts as shown at the center of the side of the head.

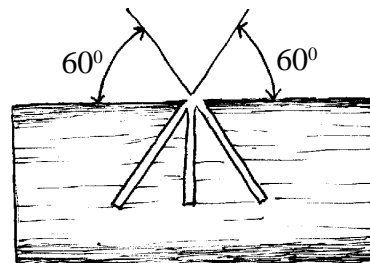

Less than the
diameter of
the handle

[NOTE] The width of the bottom of the dovetail notch must be less than the diameter of the handle.



STEP 2: Use a knife or chisel to remove the wood to form the dovetail notch.

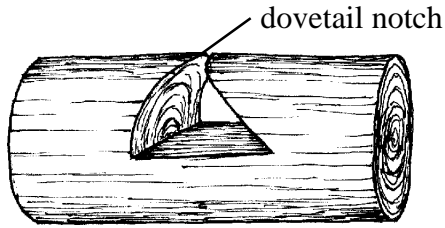

STEP 3: Shape and fit handle to head.

3A] Flatten one side of the end of the handle.

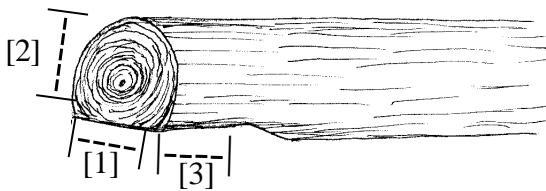

[1] Equal to or greater than the width of the bottom of the dovetail notch.

[2] Equal to or less than the depth of the dovetail notch.

[3] Equal to the diameter of the head.

3B] Fit the handle to the bottom of the dovetail notch. Gradually remove the surplus wood until the flattened part of the handle is the same width as the width of the dove tail notch.

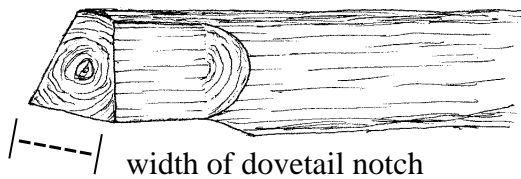

3B] Flatten the remaining two sides of the handle. Gradually remove the surplus wood until the handle fits snugly into the dove-tail notch in the head.



3A] Tap handle firmly into dovetail notch.

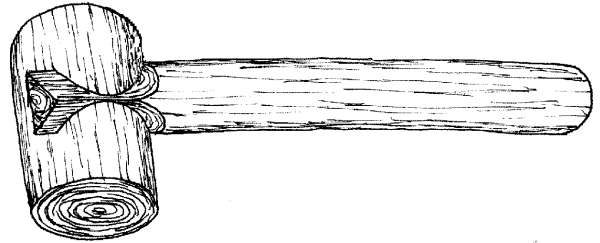

ROPE WRENCH:

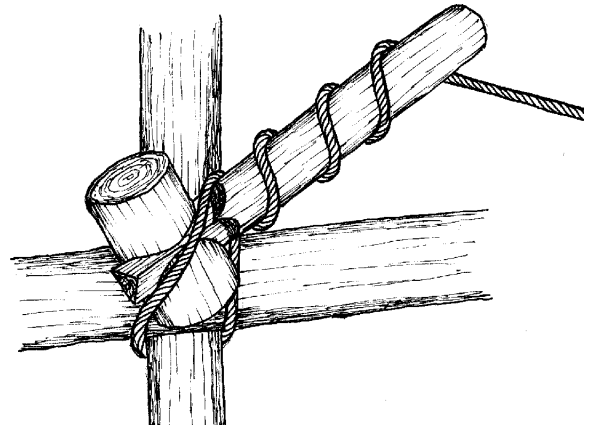

The dovetail maul makes a good rope wrench. Pass the rope over the head of the maul and then take several wraps around the handle. The rope is then tightened by rotating the maul so that the rope wraps part way around the head of the maul.



FUSING:

The ends of a synthetic rope can be fused to prevent the rope from fraying. This is done by heating the end of the rope so that the ends of the rope fibers melt together.

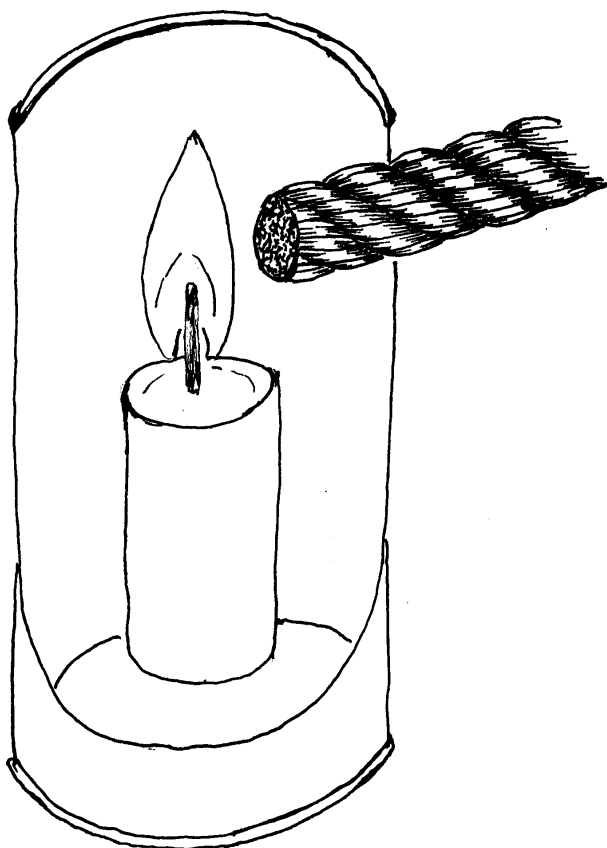

The fusing can be done by holding the end of the rope to the side of a candle or other small flame. If the end of the rope is placed in the flame or held too close to the flame, the plastic will ignite causing the end of the rope to turn black. Burning plastic can also give off toxic fumes. If the end of the rope is held above the flame, unburned carbon particle will be deposited on the melted plastic causing it to turn black. A candle flame will generate enough heat to fuse the end of a rope up to about one inch in diameter. If the rope is larger than one inch, a propane torch will work better.

[WARNING] Do not use a butane cigarette lighter to fuse rope. A butane lighter can explode if it is permitted to burn too long.



[NOTE] If the rope is cut to length with a soldering iron or other hot cutting tool, the ends of the rope will be fused as the rope is being cut to length.

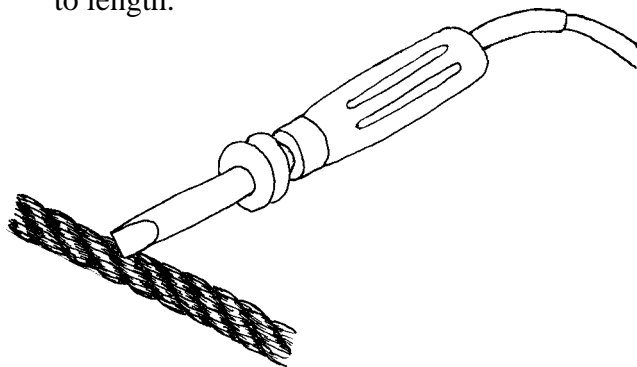

A small lamp such as an alcohol lamp or a small oil lamp works very well for fusing rope.

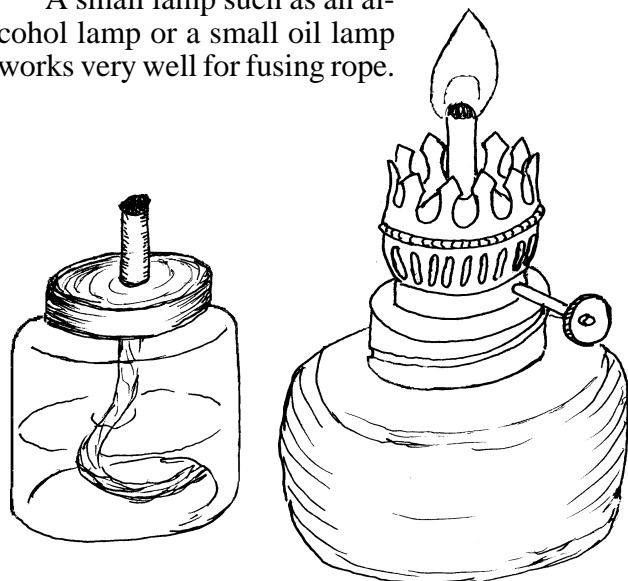



TAUT-LINE HITCH:

Description — Two half hitches with an extra turn.

Use — To adjust the tension on guy lines.

Comments — The tension is adjusted by sliding the knot along the standing part of the rope.

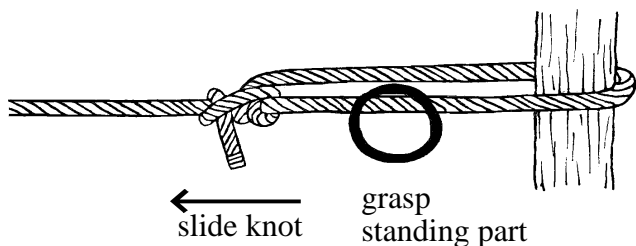

To decrease the tension on a guy line, grasp the standing part just outside the loop, then slid the knot away from your hand.

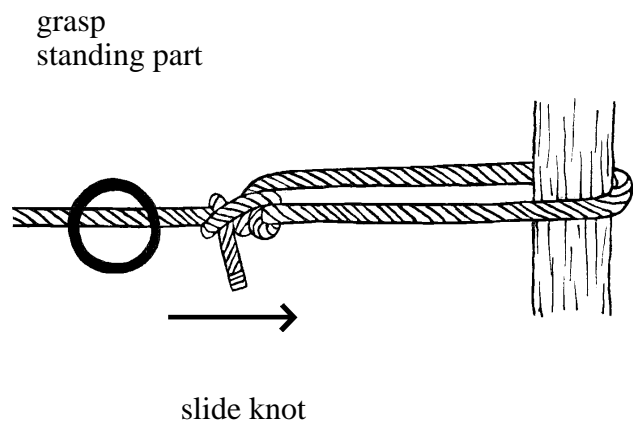

Other Names — There are several other names that are used interchangeable for the taut-line hitch and several related knots. The midshipman's hitch, rolling hitch, and magnus hitch. The following seems to be the most common usage of these name:

When tied around its own standing part ---**taut line hitch.**

rolling hitch

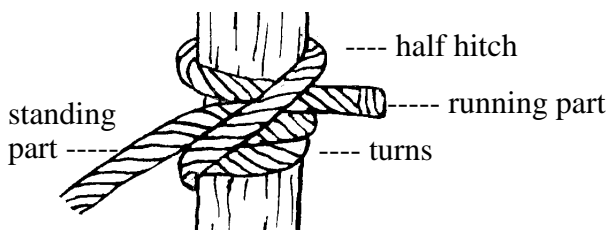

When tied around an object other then its own standing part --- rolling hitch, **magnus hitch.**

midshipman's hitch

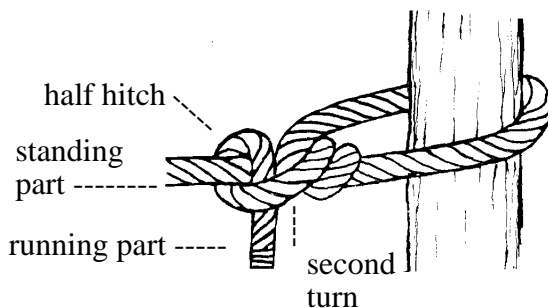

When tied so that the second turn is between the first turn and the standing part --- **midshipman's hitch** (see direction for midshipman's hitch).

adjustable jam hitch

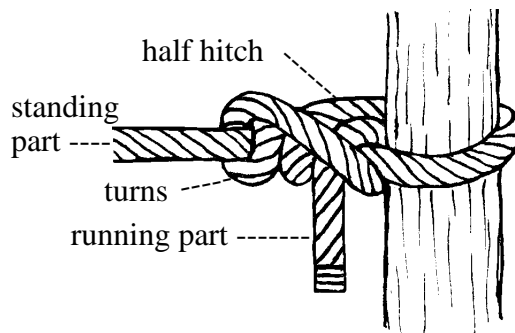

When tied with the two turns outside the loop and the half hitch inside the loop --- **adjustable jam hitch.**

Use --- To tie-up a bundle so that the knot can be tightened by sliding the knot toward the bundle and loosened by sliding the knot away from the bundle.

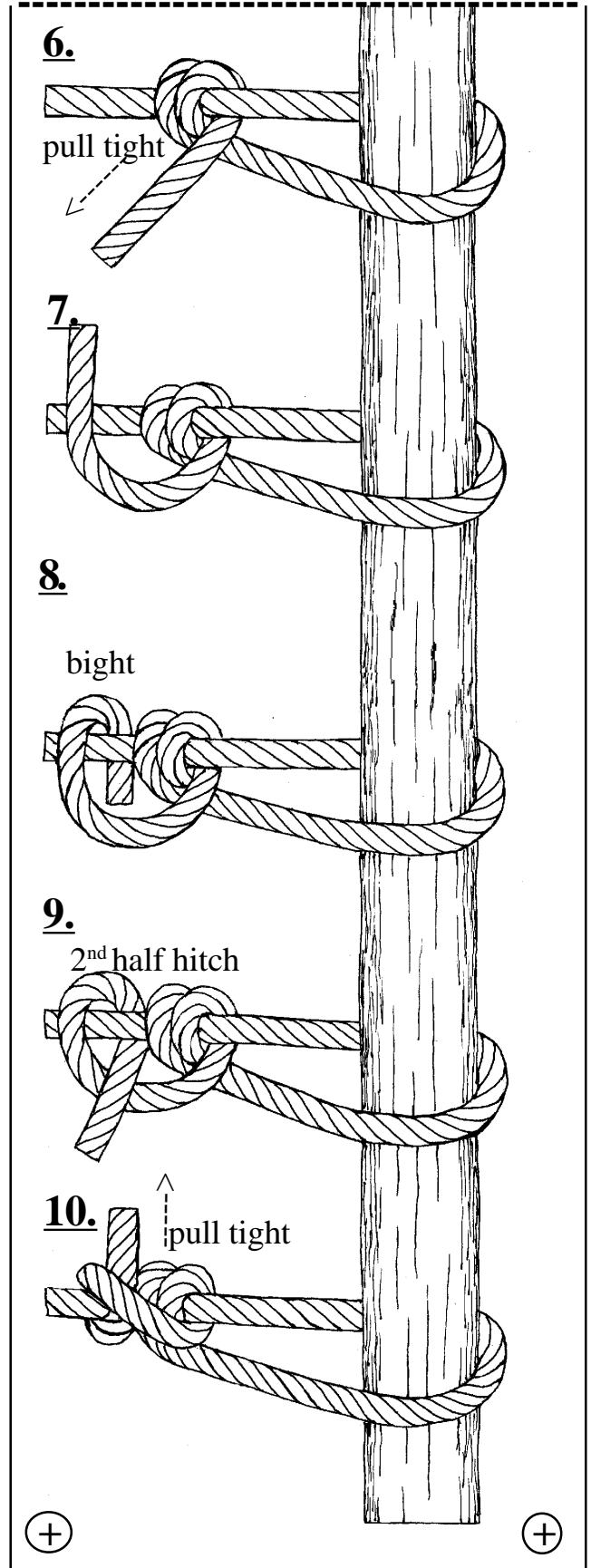
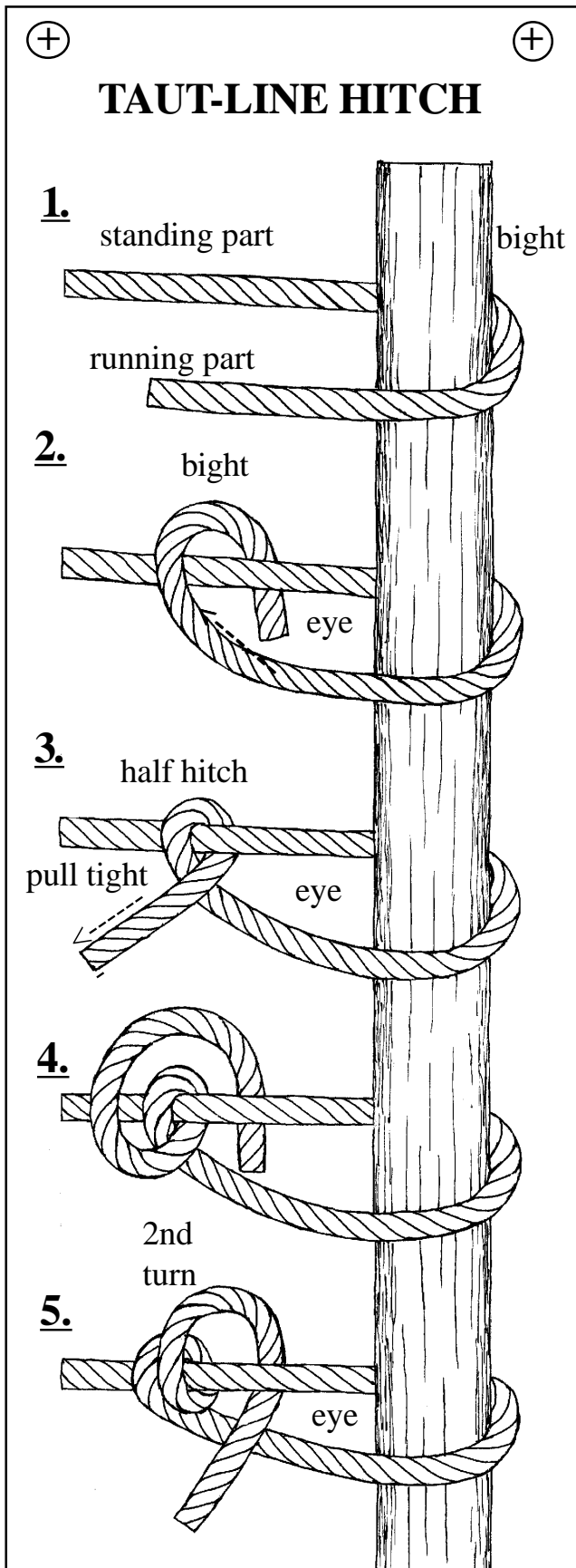

Narrative ---- (For **taut-line hitch** knotboard.) (1) Take a bight around the pole. (2) Take a bight around the standing part. (3) (The eye of the bight becomes the eye of the taut-line hitch) Pass the running part through the eye of the aut-line hitch (between standing part and the pole) this forms a half hitch around the standing part; pull tight (4) Take a second bight around the standing part in the same direction; (5) this results in two complete turns around the standing part. (6) Pull tight. (7) Go to the outside of the loop. (8) Take another bight around the standing part; pass the running part between itself and the first half hitch, (9) this forms the second half hitch, (10) Pull tight.

[NOTES]

MIDSHIPMAN'S HITCH:

Description ---- Two half hitches with an overlapping extra turn.

Use ---- To adjust the tension on a guy line when very smooth rope is being used.

Comments ---- The midshipman's hitch is harder to adjust than the taut-line hitch, therefore it is the ideal knot for adjusting the tension on synthetic rope guy lines.

Narrative ----

(1) After taking a bight around an object, take a turn around the standing part so that the turn is inside the loop.

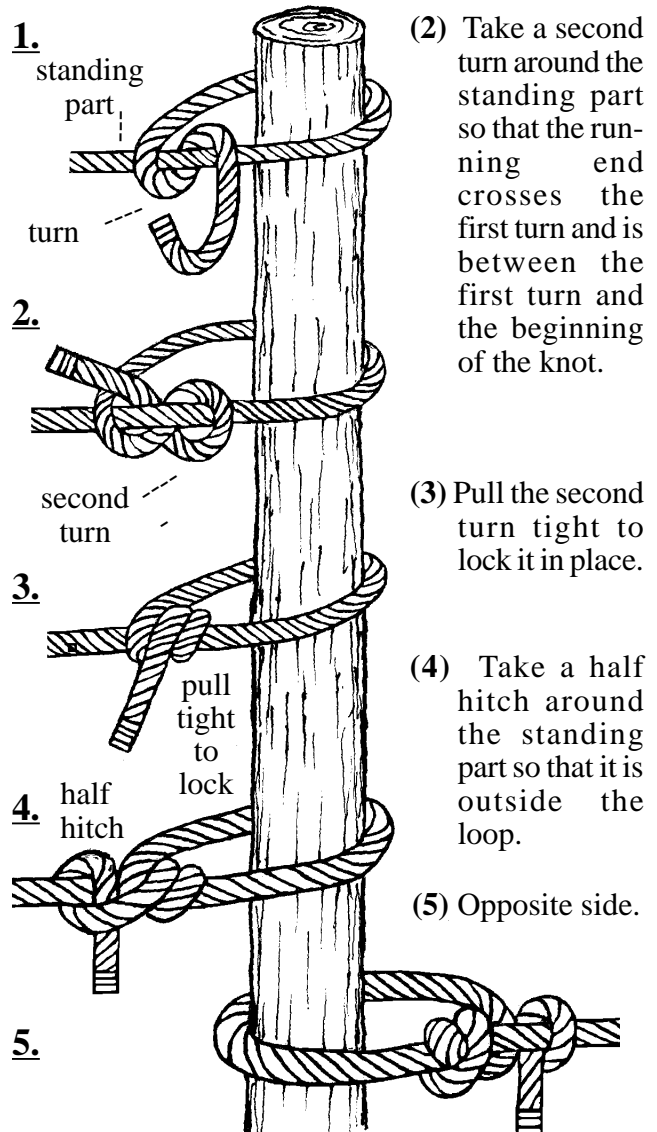



SPANISH WINDLESS:

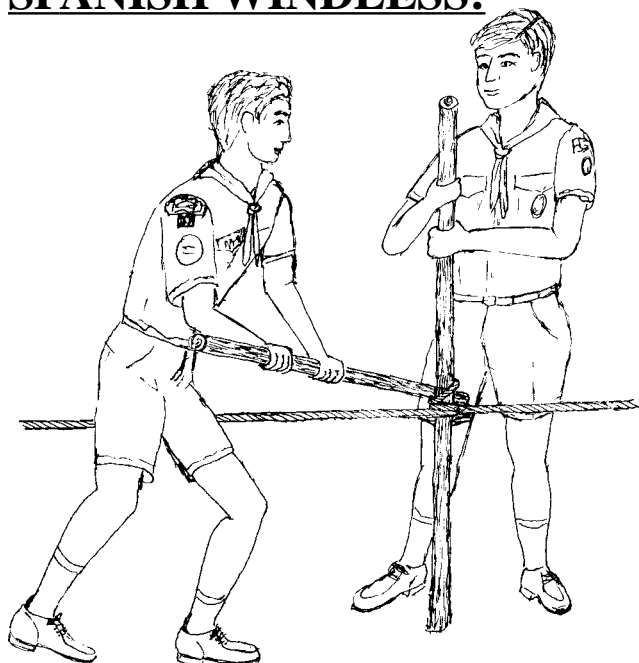

A Spanish windless is a device for moving heavy loads such as rocks and logs.

[WARNING] When setting up a Spanish Windless do not use nylon or other synthetic fiber rope that stretch under a load. If you slip or let go of the poles the energy you used to stretch the rope will be released as the rope returns to its original length. This release of energy could cause the poles of the windless to spin around causing injuries to any one near by. Natural fiber ropes, such as sisal, have little stretch; therefore are much safer to use.

MATERIALS:

- 1 — 8 foot * 3 inch pole
- 1 — 5 foot * 3 inch pole
- 1 — 3/4 inch * 50 foot (natural fiber)

SETUP:

STEP 1: Tie one end of the rope to the load and the other end to a secure anchor point. Leave some slack in the rope so that the windless can be rigged.

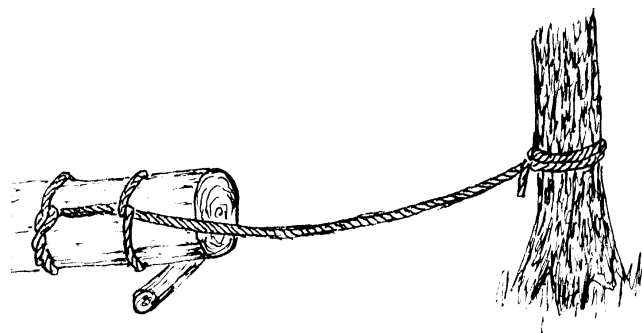

STEP 2: Follow the diagrams to set up the poles at the mid point of the rope.

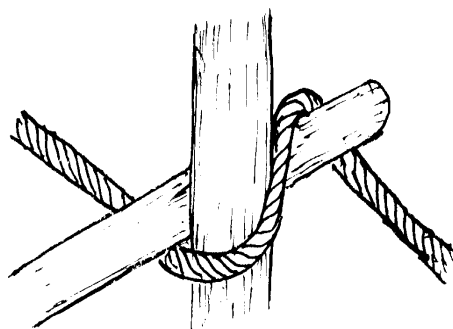

STEP 3: While one person holds the up right pole, a second person rotates the longer pole around the upright so that the rope begins to wrap around the upright pole. Adjust the height of the rope so that it can be easily stepped over.

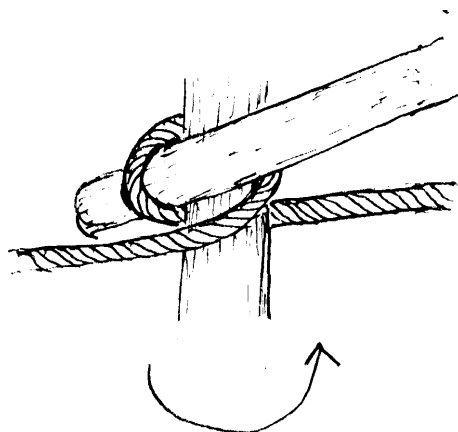



STEP 4: Continue to rotate the longer pole around the upright.

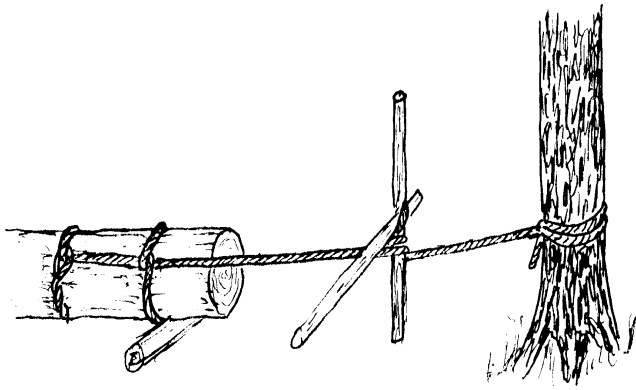

NOTE] As the rope wraps around the upright it will be necessary to move the base of the upright to keep it vertical.

NOTE] Be careful that the two end of the rope are kept at the same level on the upright.

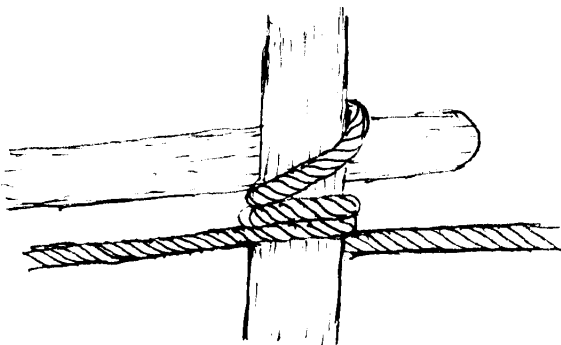

keep rope at
same level

[NOTES]

ROPE HALTER

Start with an eye splice.

(The Eye splice will form one end of the nose piece of the halter)

Decide how long the nose piece must be then tie a quick eye into the rope.

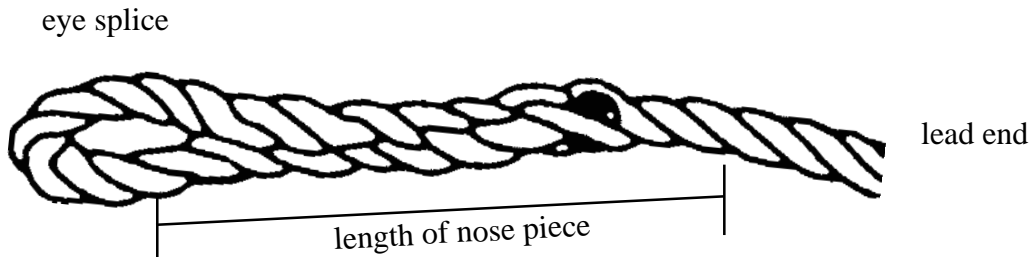

Quick Eye STEP1

Decide where the quick eye must be. Then reeve the lead end through the lay of the rope as shown. (Slightly larger than the diameter of the rope)

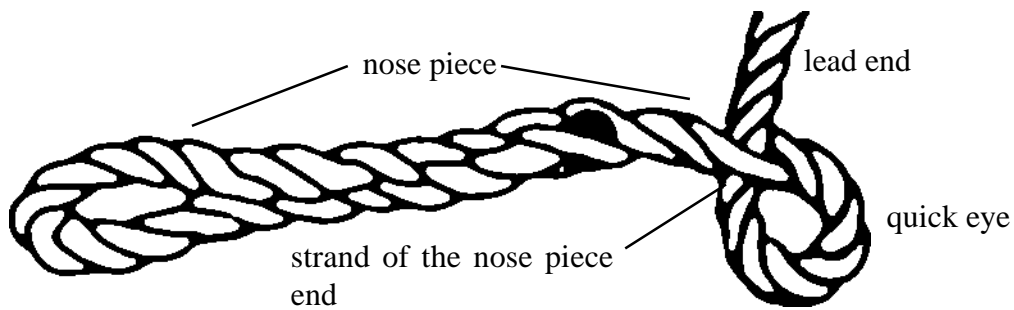

Quick Eye STEP 2

Observe which strand of the lead end is directly under the strand of the nose piece end. Reeve the eye splice under that strand.

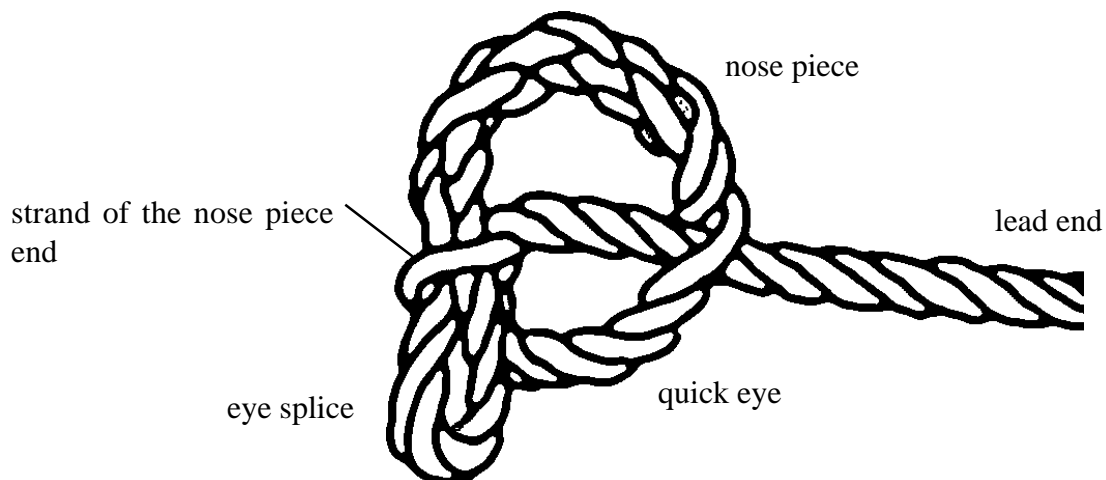

Quick Eye STEP 3

Work the eye into shape. (Do not just pull on the ends this will distort the eye.) When the eye is in shape, the strands of the rope should lay even showing little or no distortion.



Finish the halter by reeving the lead end through the two eyes as shown.

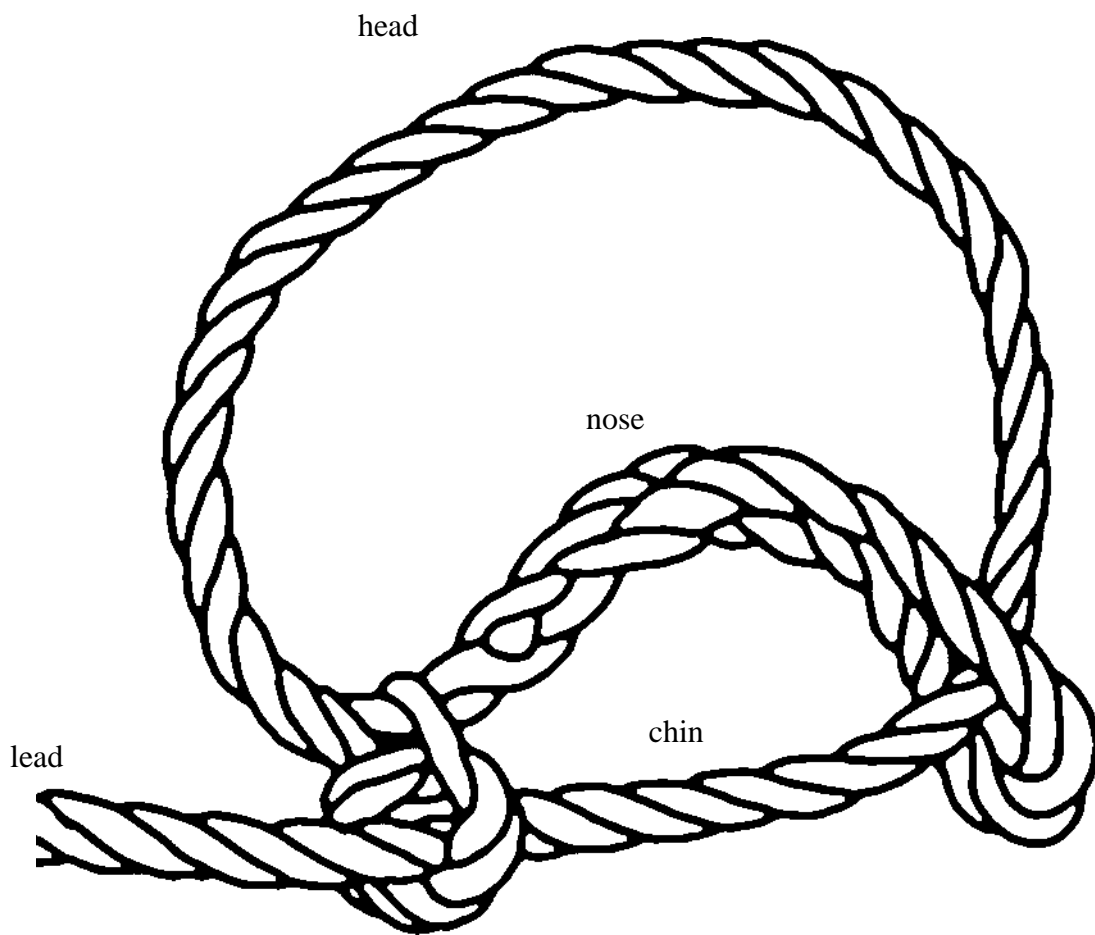



LADDER LASHING:

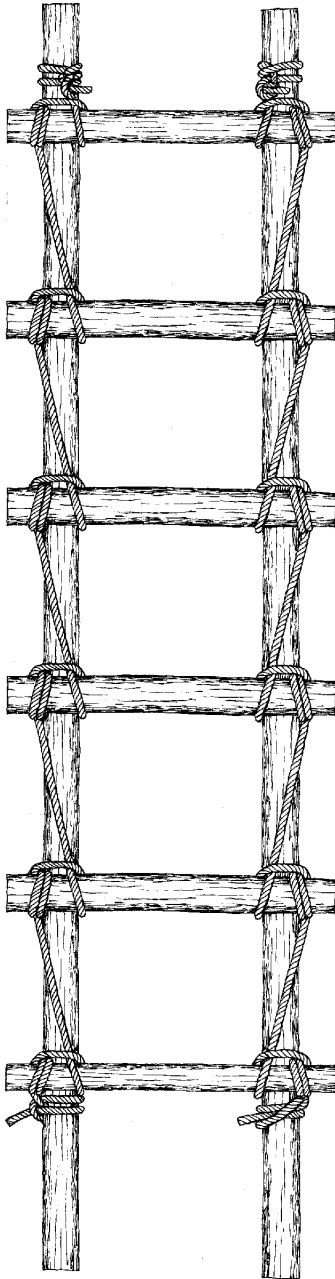

Comments:

Ladder lashing allows for a quick and secure method for constructing a ladder or for constructing a decking with evenly spaced decking pieces.

This form of lashing has several advantages over the traditional floor lashing. Less material is required because unlike floor lashing a space can be left between each piece of the decking. Also, each rung is securely lashed in place by several loops of rope in much the same way as a square lashing; with the traditional floor lashing only a single loop of the rope holds each end of the decking in place, therefore if one piece loosens, the entire deck loosens.

The ladder lashing has two forms; left and right, each is a mirror image of the other.

START: The ladder lashing is started by using a clove hitch stopped with two half hitches to secure a rope to the top end of each rail.

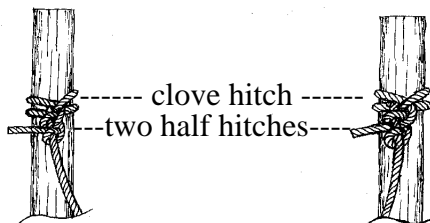

STEP 1: Lay an overhand loop over each side rail so that the running end of each loop is to the outside.

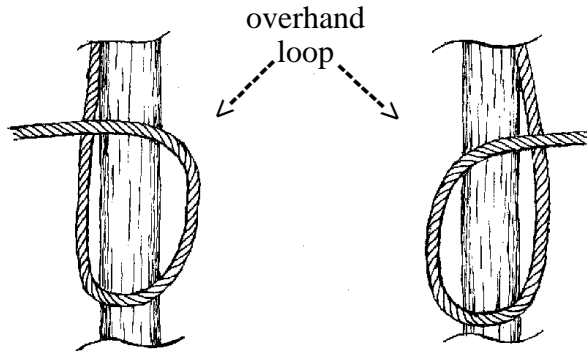

STEP 2: Place a rung across the rails so that the standing part of each overhand loop is over the end of the rung and the running part of each overhand loop is under the rung.

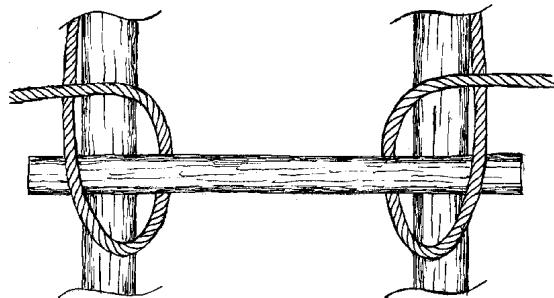

STEP 3: Pull the running part side of each overhand loop behind and to the outside of each rail.

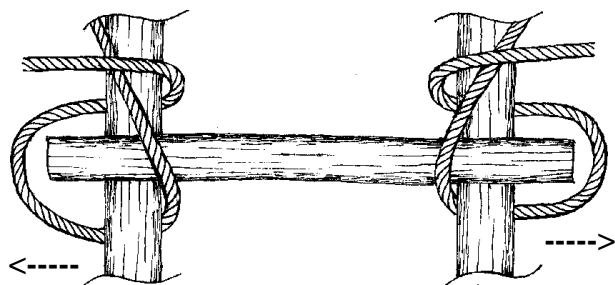



STEP 4: Then pull the loop over the end of the rung.

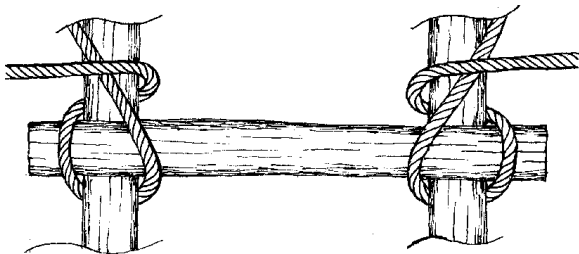

STEP 5: Work each rope until it is tightened around the rung and the rung is in its desired position.

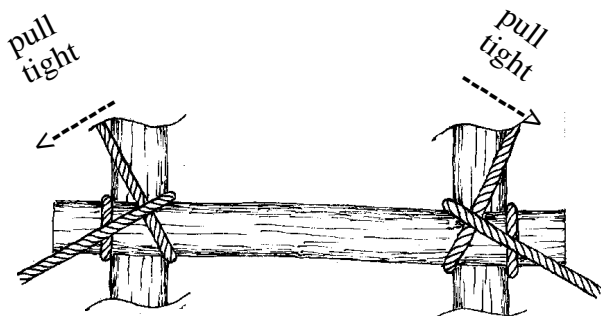

STEP 6: Form an overhand loop in each running part.

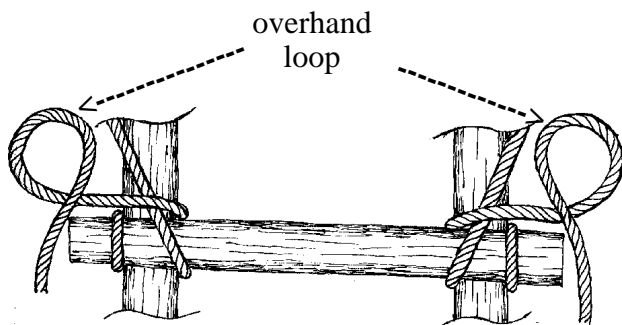

STEP 7: Place an overhand loop over each end of the rung to form a half hitch around each end of the rung.

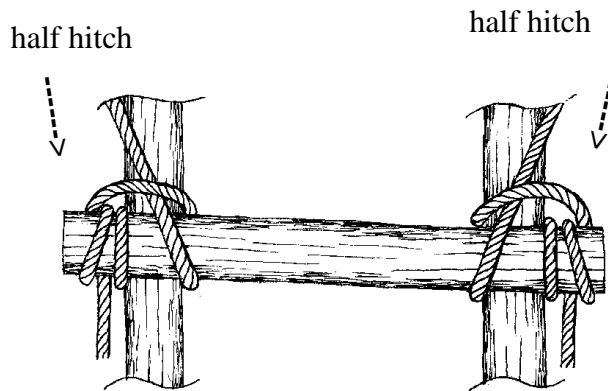

STEP 8: Work the half hitch tight.

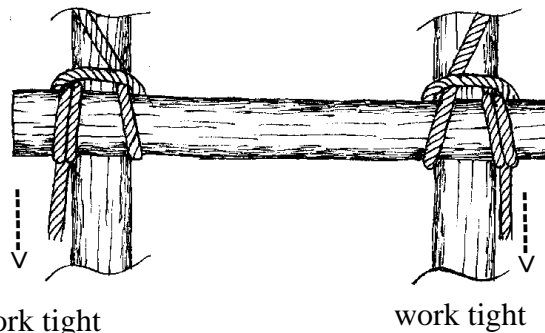

STEP 9: Repeat steps 1 through 8 for each additional rung.

END: Finish the lashing by tying a clove hitch around each rail so that the clove hitch is directly under the bottom rung.

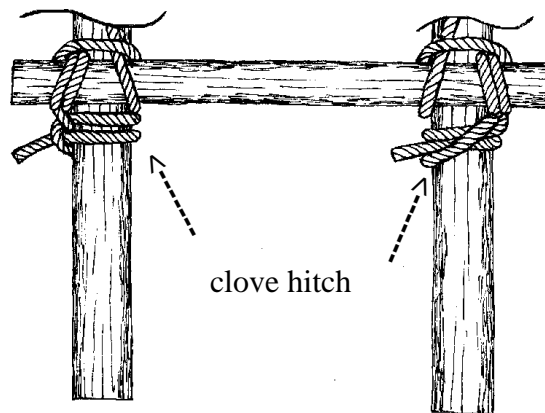



SEIZING:

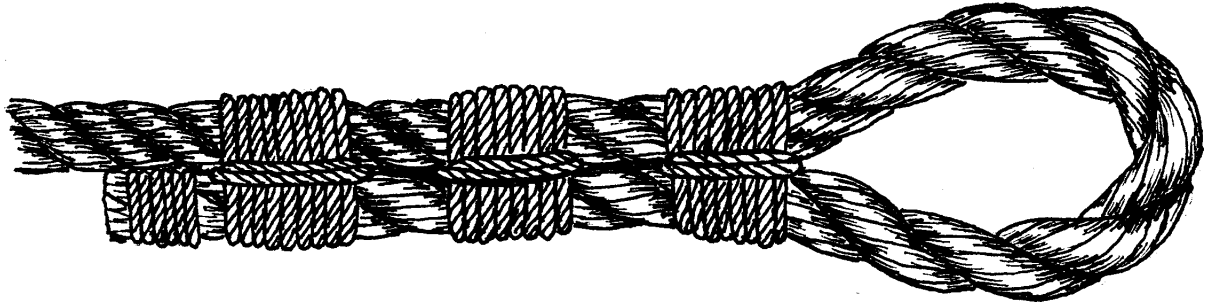

Use ---- To bind ropes together or to bind a rope to an object. Sometimes used to bind the running end of a rope to the standing end of the rope to prevent a knot from spilling.

Comments ---- Seizings do not use as much material and are not as bulky as a knot or a splice; nor does the seizing damage the fiber of the rope. The fibers of a rope do not need to be bent or separated to be seized as they do when a knot is being tied or a splice worked. If the seizing is no longer needed, the seizing can be cut away and the rope is undamaged.

The seizings shown here can be worked without the use of a needle. However there are many forms of seizing that require the use of a needle to apply them to a rope.

To form an eye, 3 to 4 seizing should be used. This ensures that the eye will safely remain in place even if one of the seizings is damaged.

If there is additional strain on the ropes, such as at the first seizing of an eye, racked turns should be used.

Materials ---- The diameter of the "twine" that is being used to do the seizing should be 1/8 to 1/12 the diameter of the rope being seized. The length of the "twine" should be about 3 feet for each 1 inch of diameter of the rope.

Narration ---- (For **seizing** knotboard.) (1) Fold a piece of twine in half over one strand of the rope. (2) Start the first layer of wrapping turns by laying the end of the twine that is between

the ropes over the other end. (3) Wrap the outside strand around the ropes so that so that the wrapping turns are parallel to each other; pull each wrapping turn tight. (4) When the width of the wrapping is equal to the diameter of the rope, end the first layer of wrapping turns by reeving the twine between the ropes; pull tight. (5) Add a layer of riding turns; the riding turns are laid in the groove between the wrapping turns and pulled tight but not so tight as to separate the wrapping turns of the first layer. (6) When the riding turns have been completed, end the riding turns by reeving the end of the twine between the ropes so that it is in the opposite direction to the other end of the twine. (7) Add frapping turns; reeve the end of the twine between the ropes at the other end of the wrappings; pull tight. (8) Use a square knot to end the frapping turns: reeve the ends of the twine between the ropes again; tie a half knot; pull the half knot and the frapping turns tight. (9) Reeve the ends of the twine between the ropes again; tie the second half knot of the square knot. (10) Pull the second half knot tight so that the square knot is between the strands of the rope. Cut of the ends of the twine.



SEIZING



1. center of twine

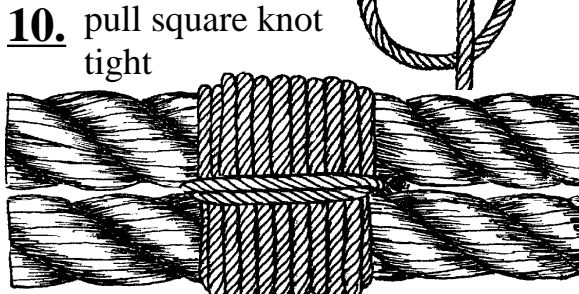
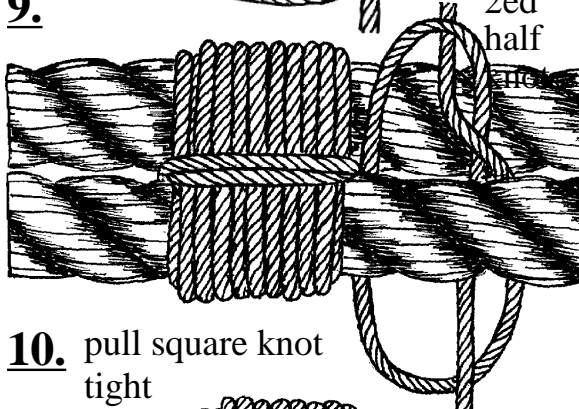
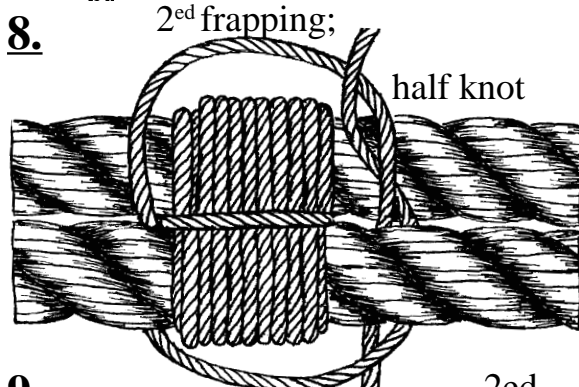
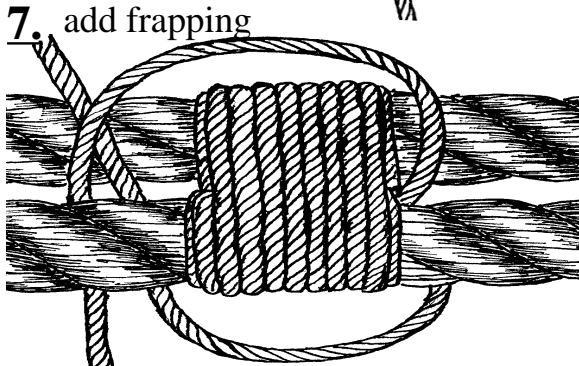
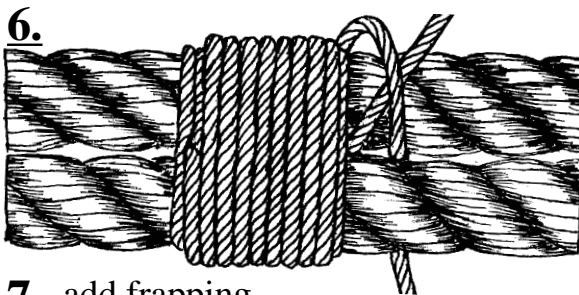
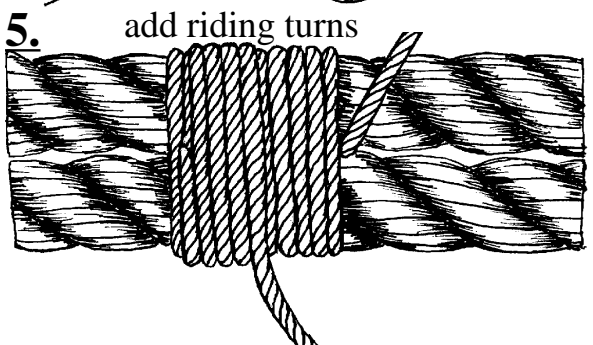
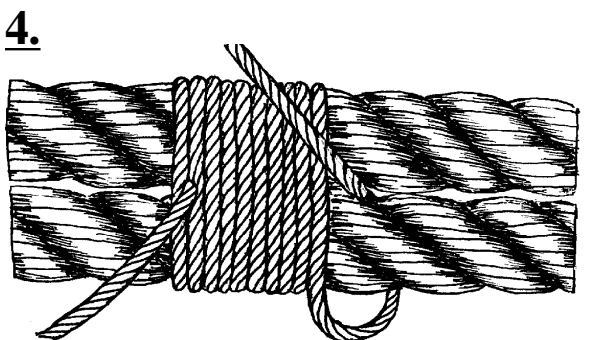
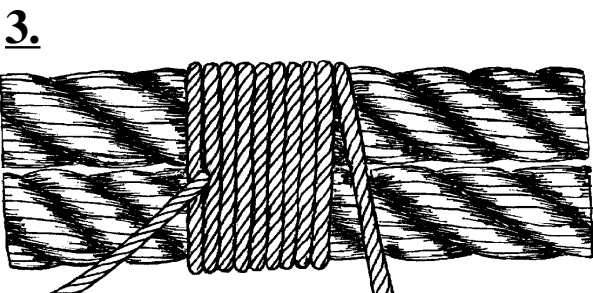
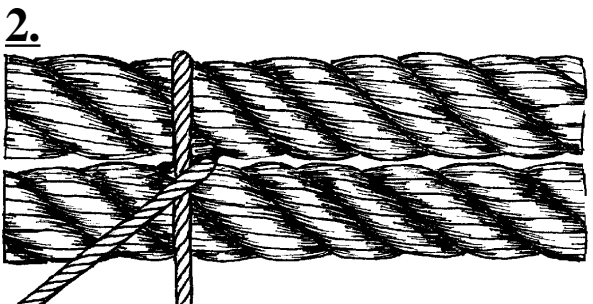
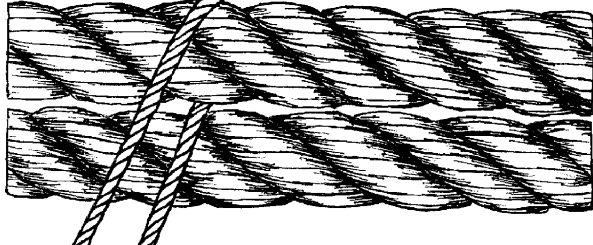

cut off ends



SEIZING: WITH RACKING TURNS

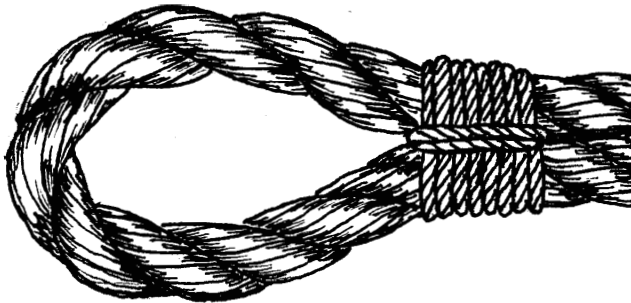

Narration ---- (For seizing with racking turns knotboard.) (1) At the center of a piece of twine, tie a half knot so that the twine is around the first rope and the half knot is between the ropes. (2) Take racking turns with the twine by taking a bight around the second rope and reeveing the twine between the ropes; (3) then take a bight around the first rope and reeve the twine between the ropes again. (each racking turn forms a figure "8" around the rope. (4) When the length of the layer of racking turns is equal to the diameter of the rope, end the layer of racking turns with a half hitch around the second rope. (5) work half hitch tight. (6) Add a layer of riding turns; the riding turns are laid in the groove between the wrapping turns and pulled tight but not so tight as to separate the wrapping turns of the first layer. (7) Add frapping turns; reeve the end of the twine between the ropes at the other end of the wrappings; pull tight. (8) Use a square knot to end the frapping turns: reeve the ends of the twine between the ropes again; tie first half knot of the square knot; pull the half knot and the frapping turns tight. (9) Reeve the ends of the twine between the ropes again; tie the second half knot of the square knot. (10) Pull the second half knot tight so that the square knot is between the strands of the rope. Cut of the ends of the twine.

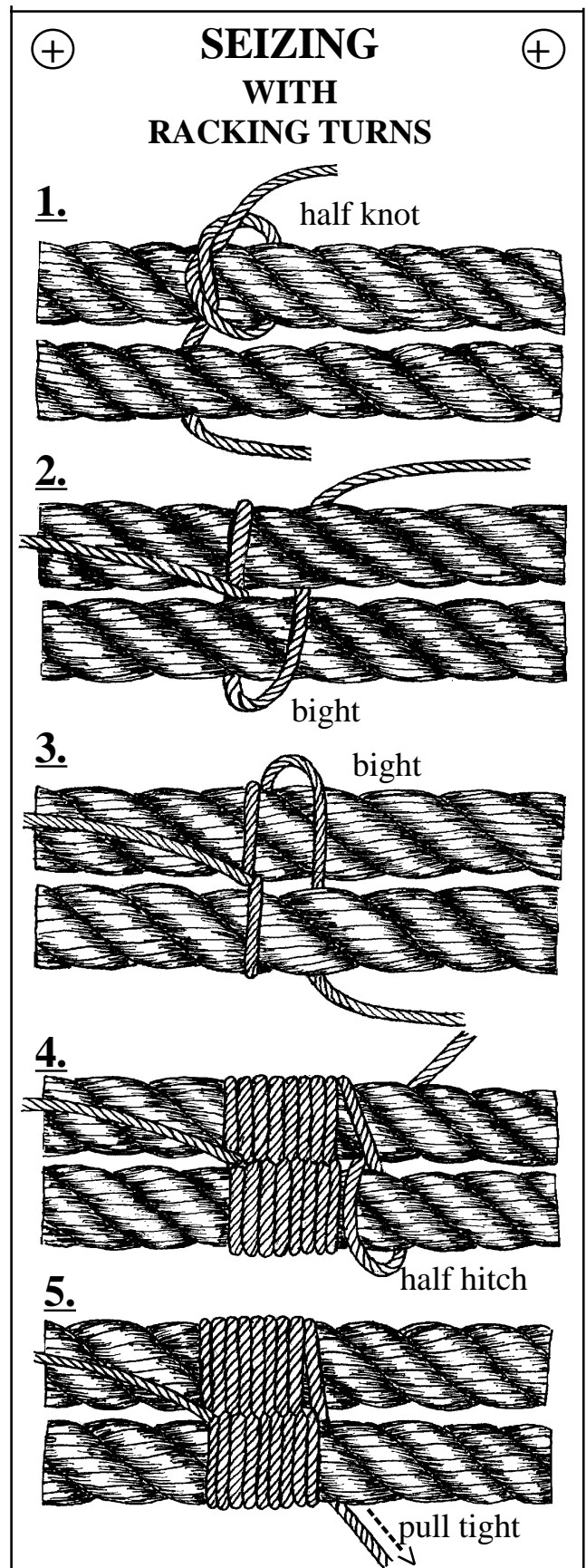



6.

riding turns

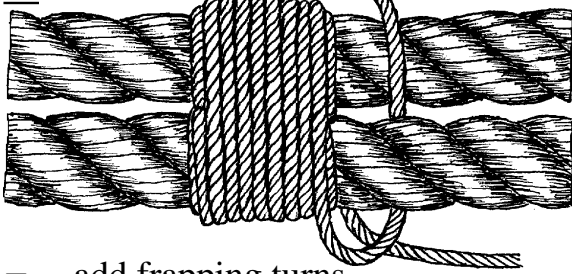

7.

add frapping turns

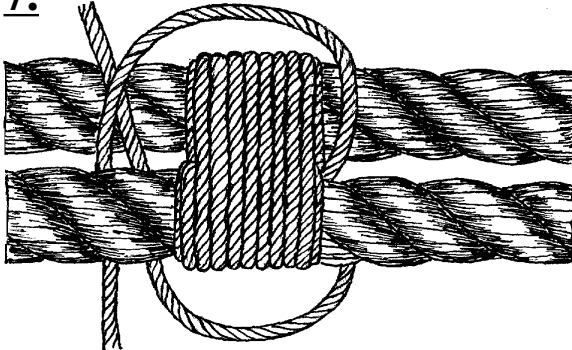

8.

tie square knot

half knot

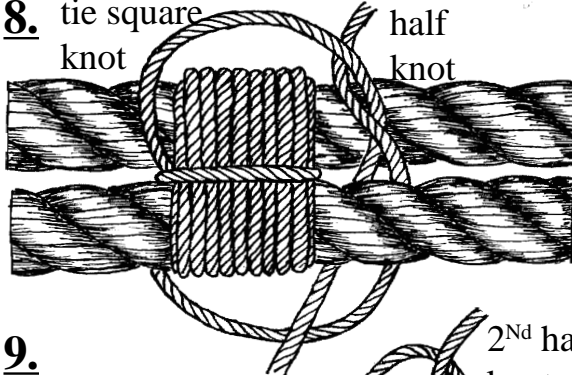

9.

2nd half knot

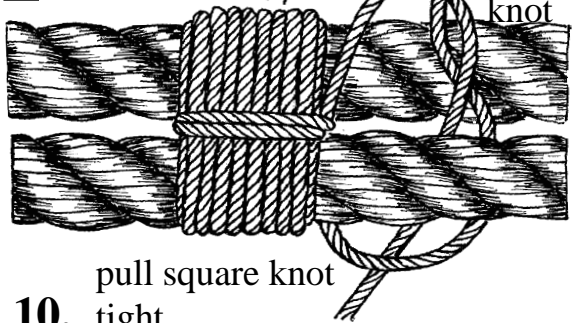

10.

pull square knot tight

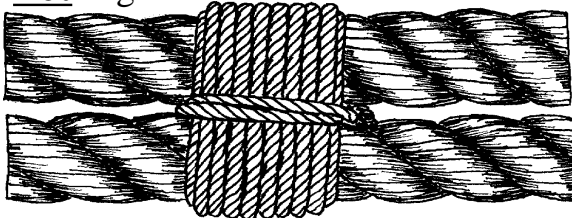

and cut off ends



[NOTES]



FIDS:

A fid is a tool that is used to open the lay of a rope when working a splice or to loosen knots.

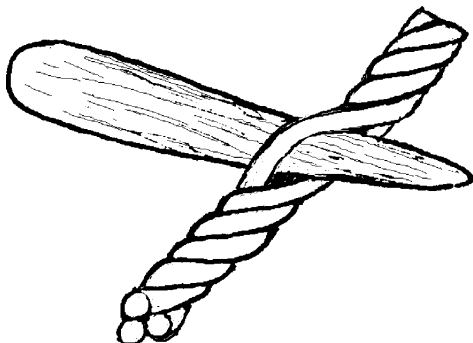

MAKING A WOODEN FID:

Split out an 8 inch by 3/4 inch piece of close grained, smooth, hardwood. Carve and smooth the piece to the shape shown in the diagram.



MAKING METAL FIDS:

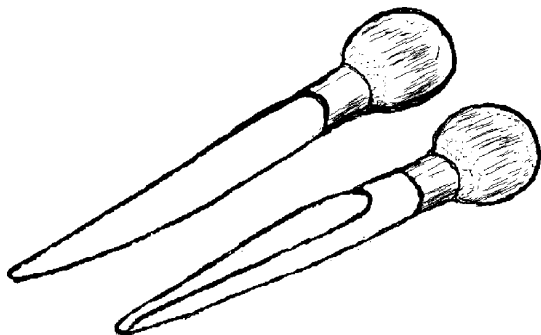

Materials:

- 1 --- 8 inch * 1/2 inch copper tubing or steel electrical conduit.
- 2 --- 1 inch diameter * 3 inch long piece of smooth grained hardwood.
- 2 --- 4D finishing nails.

Construction:

Cut the tubing diagonally into two pieces as shown in the diagram (Use a hacksaw).

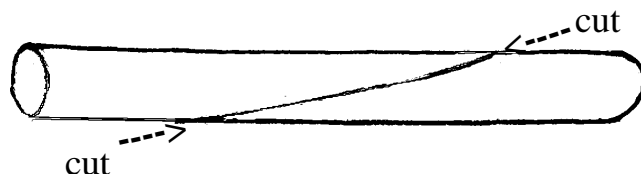

Making a Closed Fid:

STEP 1: Use a triangular file to enlarge the diagonal opening in one of the halves of the tubing. File the opening to the shape indicated by the dotted lines in the diagram.



STEP 2: Close the diagonal opening. Using light taps with a hammer gently roll the two edges toward each other to form the tubing into a cone. (When the two edges of the opening meet the seam in the tubing should be straight).

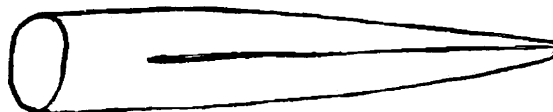

STEP 3: Solder the edges of the opening together.

3A] Clean the edges of the opening with steel wool.

3B] Spread soldering paste along the cleaned edges.

3C] Solder the seam. Use a propane torch to apply heat to the side of the fid that is opposite the seam. (Heating the tube from the opposite side, will ensure that metal is heated all the way through so that the solder will flow into the seam and not just spread out on the surface.) As you heat the tubing test the seam for the proper temperature by touching the solder to the seam. When the solder starts to melt and flow into the seam, move the solder along the seam until the entire seam is filled with solder.

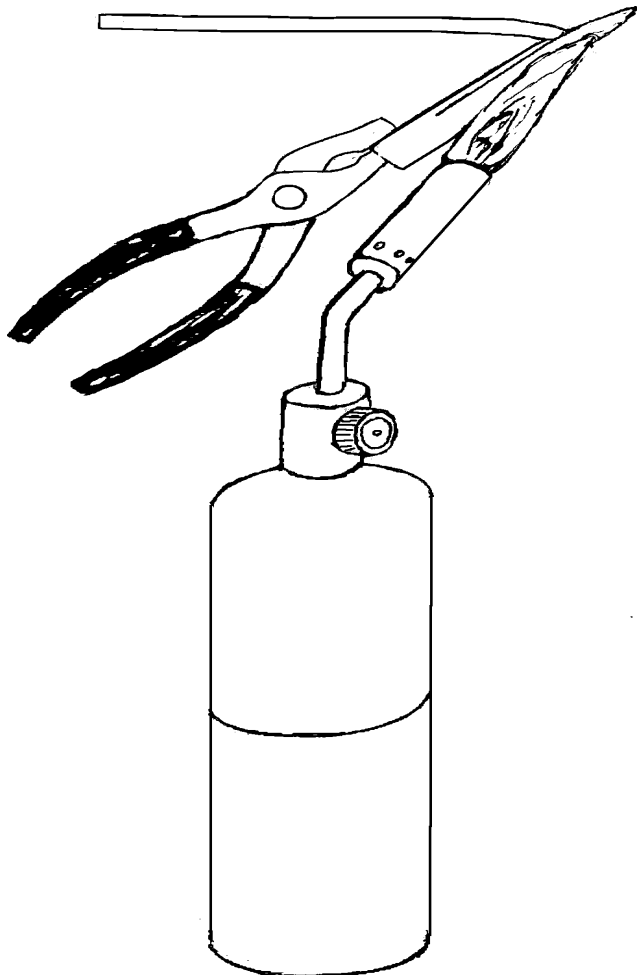

STEP 4: Cleanup the seam with steel-wool and a file. Make sure that there are no sharp edges to catch or cut the rope fibers when the fid is being used.

Making an Open Fid:

STEP 1: Enlarge the diagonal opening of the other piece of tubing by setting the tubing on end and forcing a rod into the opening. When the rod is forced into the opening, the cross section of the tubing should become "U" shaped.

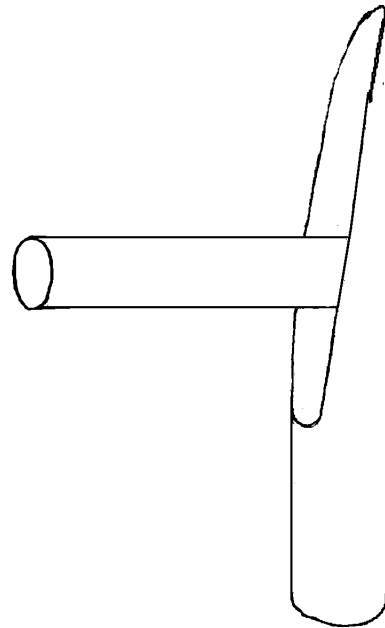

STEP 2: With a round file, enlarge the diagonal opening to the shape shown by the dotted line.





STEP 3: Smooth all rough and sharp edges with a file and steel-wool.

STEP 4: Gently tap the edges of the opening toward each other so that a cross section anywhere along its entire length will be "U" shaped.

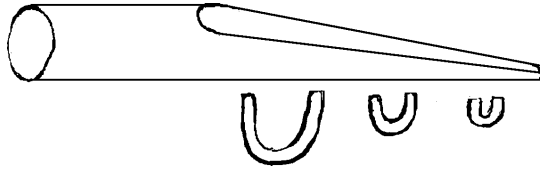

Making Handles For Fids:

STEP 1: Carve one end of a 1 inch diameter * 3 inch long piece of wood so that it will fit snugly into the end of the fid.



STEP 2: Attach handle to fid.

2A] Drill a small hole into the side of the fid about 1/2 inch from the end.

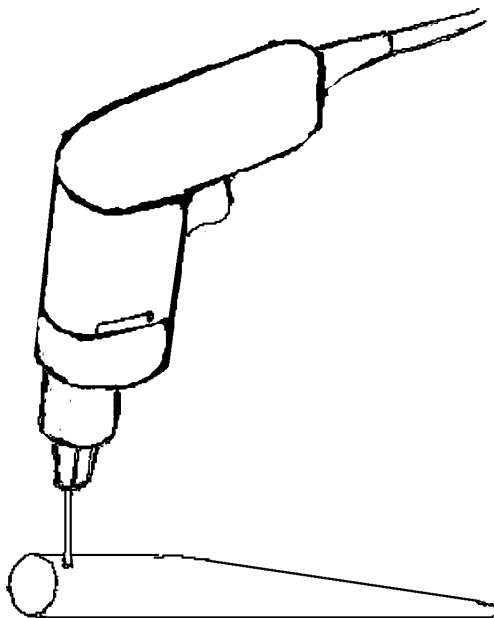

2B] Insert the handle into the end of the fid. Then drive a finishing nail through the hole into the wood of the handle.

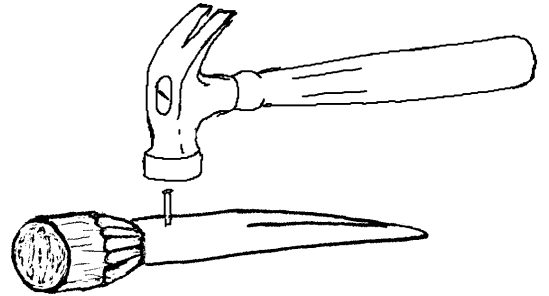

2C] Cut the nail off close to the side of the fid. Then file the nail down so that it is smooth and even with the surface.

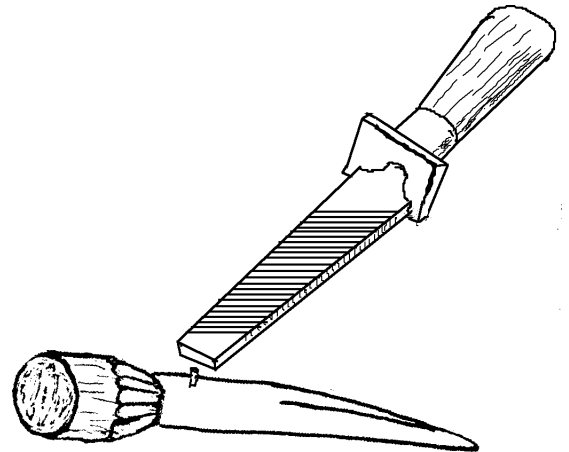

STEP 3: Finish the handle. Here is a chance to be creative. You can carve a simple rounded handle or let your imagination take over.

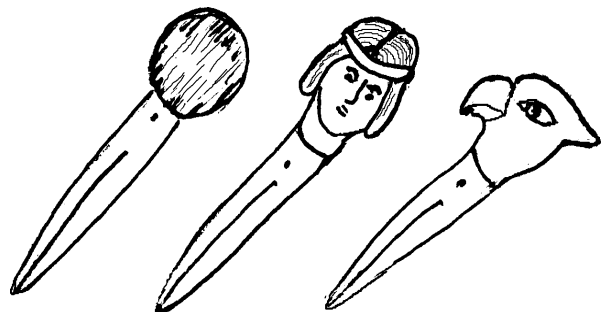



JAPANESE SQUARE

LASHINGS:

Comments — The Japanese Square Lashings are a group of similar lashings that are all tied in a similar manner. The main difference is in the way each lashing is started.

The simplest and easiest form of the Japanese square lashing is tied by looping the center of the rope around the vertical spar and carrying the stands parallel to each other while taking the wrapping turns. The frapping turns are taken by separating the ends of the rope and taking them in opposite directions.

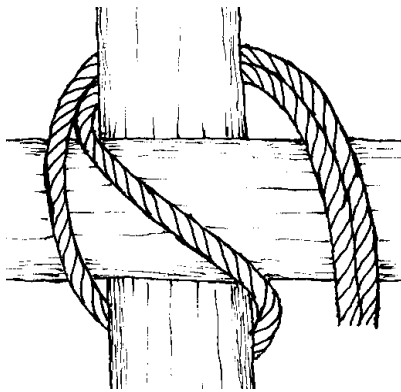

The Mark II Japanese Square Lashing is tied by looping the center of the rope of the upright spar and then forming the wrapping turns by taking the ends of the rope in opposite directions.

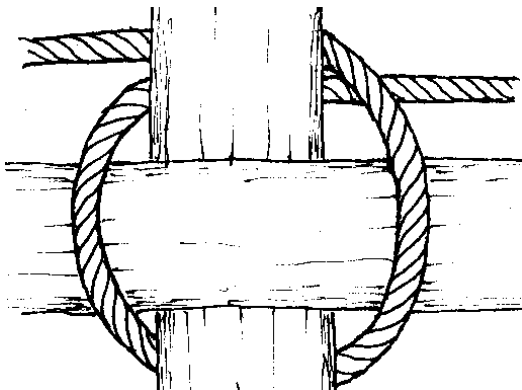

The Mark III is the same as the Mark II but a clove hitch is tied around the up right spar when starting the lashing.

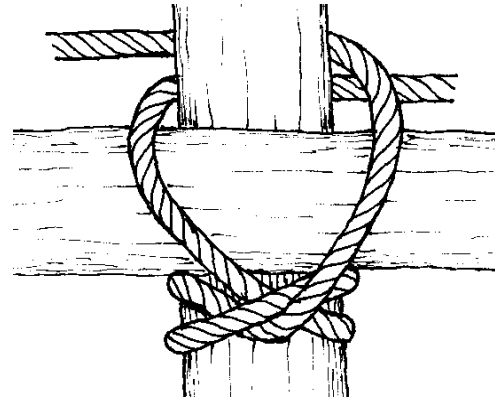

The Mark III is the most secure of the three Japanese square lashings because the clove hitch helps to prevent the lashing from shifting along the vertical spar.

Narration -----(For Japanese square lash knot-board.) (1) Start the lashing by looping the center of the rope around the vertical spar so that the loops under the horizontal spar. (2) Start the wrapping turns by leading the ends around the spars so that the two strands of the rope are parallel to each other. (3) When making the wrapping turns the two strands of the rope are lead around the spars at 90° to the spars; do not allow the strand to cross, be sure to keep the strands parallel. (4) Complete the wrapping turns by leading the rope strand around the vertical pole. (5) Start the frapping turns by separating the strands so that one strand is above the horizontal spar and the other strand is below the horizontal spar. (6) Lead the frapping strands in opposite directions. (7) Make two complete frapping turns; pull each turn tight as it is made; tie the first half knot of the ending square knot. (8) Tie the second half knot of the square knot to complete the lashing. (9) For safety add half hitches; The half hitches prevent the square knot from upsetting.

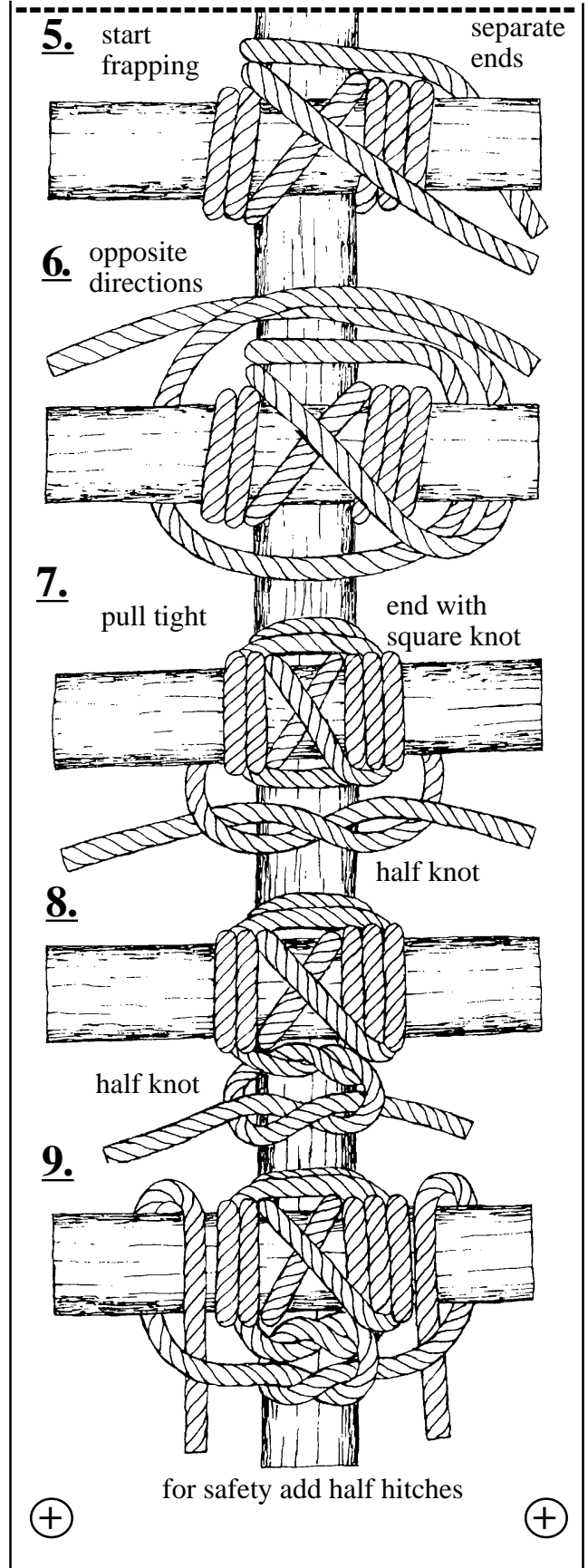
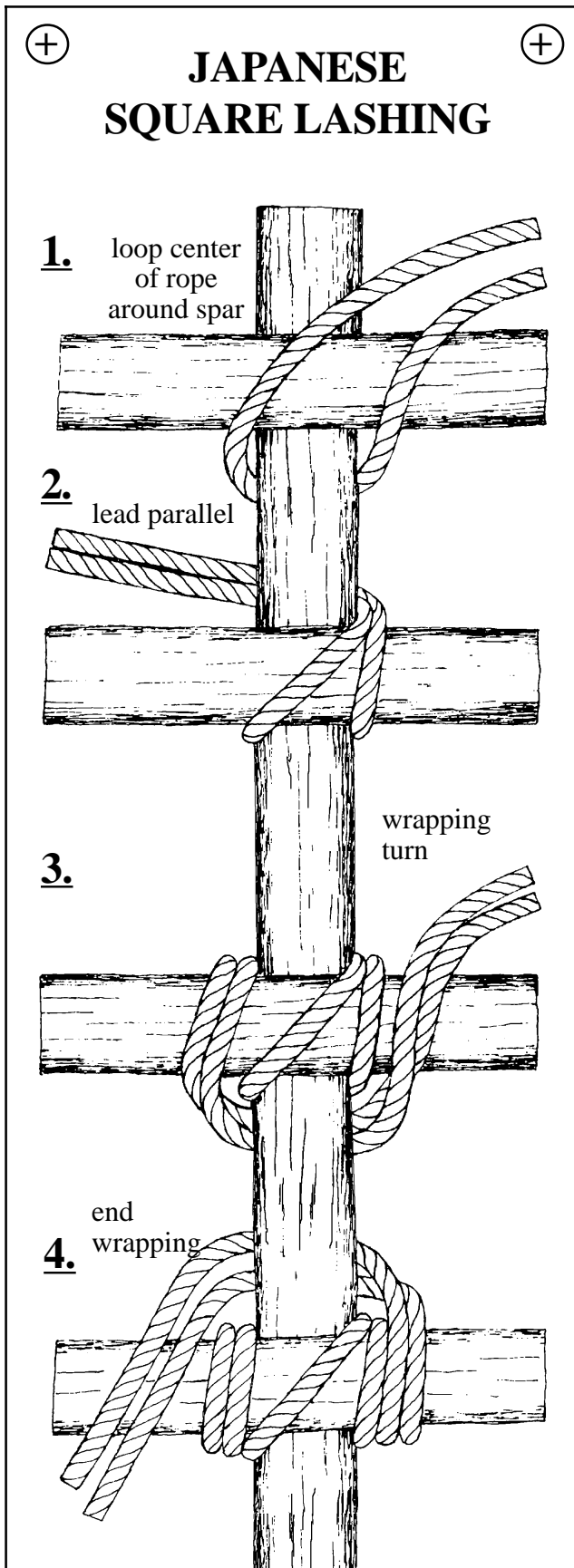



⊕ JAPANESE SQUARE LASHING MARK II ⊕

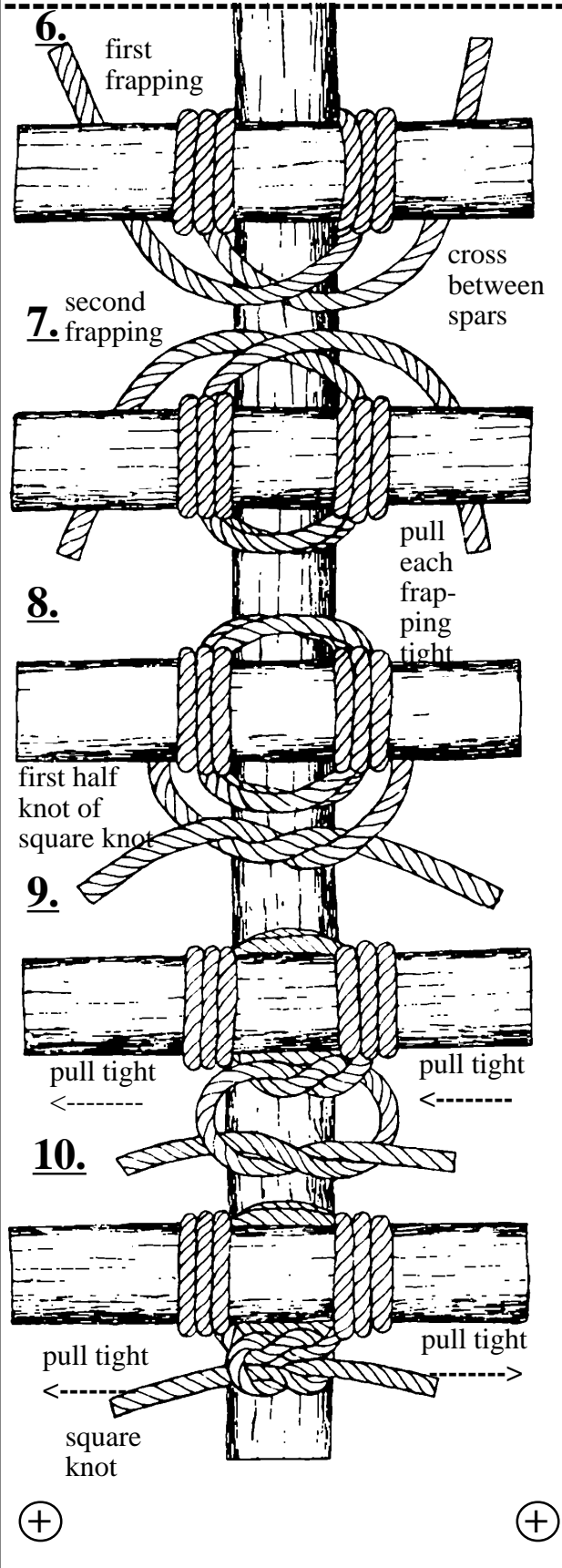
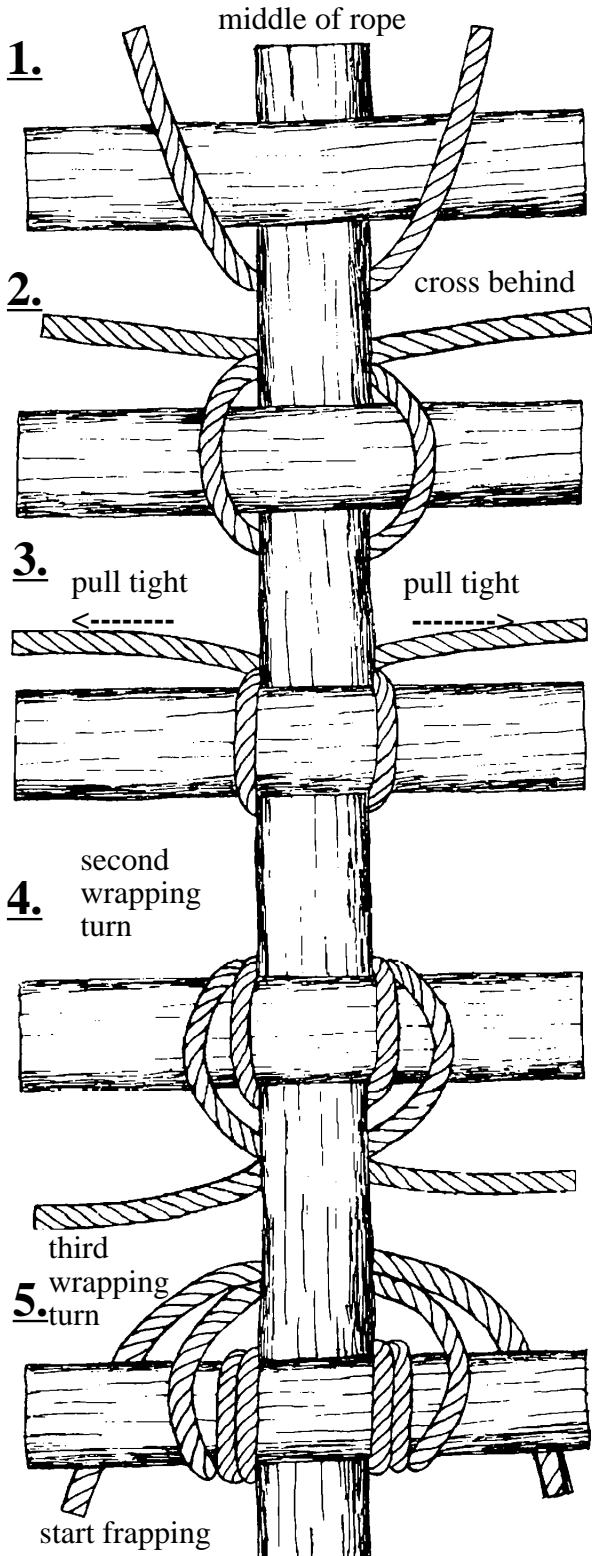



Narration --- (For Japanese square lash, mark II knotboard.) (1) Start the lashing by tying the center of the rope around the vertical spar with a clove hitch so that the clove hitch is under the horizontal spar. (2) Make the first wrapping turn by leading the ends up over the front of the horizontal spar and then in opposite directions behind the vertical spar. (3) Pull the strands tight but do not allow them to cross each other. (4) Add the second wrapping turn by leading the ends of the rope down over the front of the horizontal spar and then in opposite directions behind the vertical spar. (5) Complete the frapping turns by leading the ends of the rope up over the front of the horizontal spar and then in opposite directions behind the vertical spar. Position the strands of rope for starting the frapping turns by leading them behind the horizontal spar. [NOTE] When pulled tight the strands will cross behind the vertical spar.

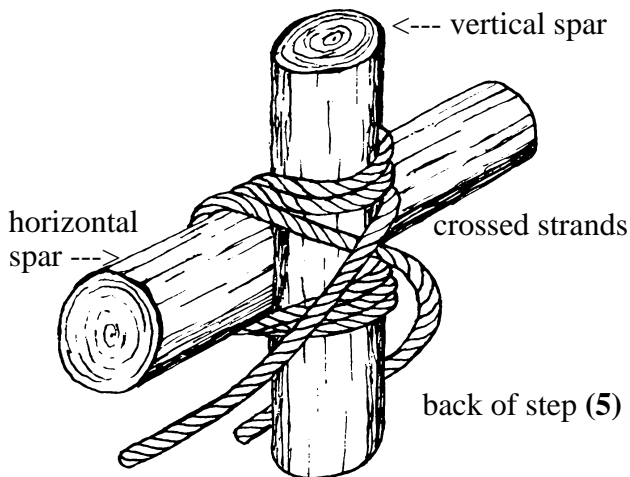

(6) Lead the frapping strands in opposite directions below and in front of the vertical spar and in front of the vertical spar and then behind the horizontal spar. (7) Make the second frapping turn by leading the ends above and in front of the vertical spar and then behind the horizontal spar; pull each turn tight as it is made. (8) **End** the second frapping turn by tying the first half knot of the ending square knot. (9) Complete the ending square knot by adding a second half knot. (10) Pull the square knot tight [NOTE] For safety add half hitches around the horizontal spar to either side of the square knot; The half hitches prevent the square knot from upsetting.

MARLIN SPIKE HITCH:

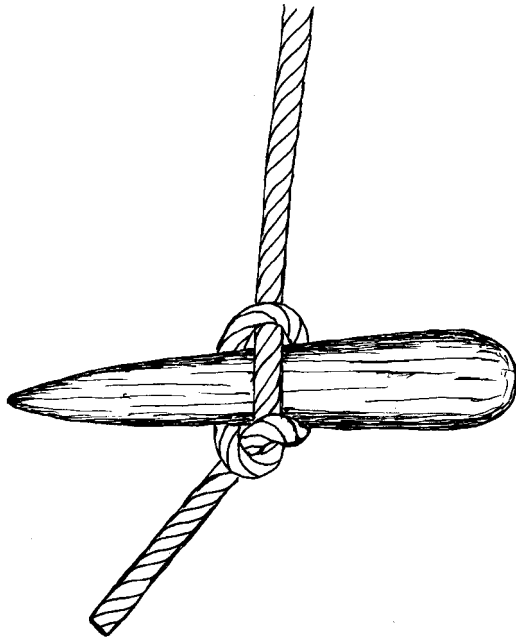

Description — A loop formed by a half hitch around a bight in the standing part of the rope.

Use — To temporarily hold a toggle (a Marlin Spike) so that a rope can be pulled tight; as a mooring hitch that can be dropped over the end of a stake or pole; to hold the rungs of a rope ladder.

Comments — A secure temporary hitch that can be easily spilled by removing the toggle. The Marlin Spike Hitch gets its name from the practice of using it around a Marlin Spike or similar tool to tighten knots and servicing.

Other Names — Slip Noose; especially when the half hitch is pulled closed around the bight.

Narrative ---- (For **marlin spike** knotboard) (1) Form an overhand loop. (2) Then form a bight in the standing part. (3) Place the bight under the overhand loop. (4) Then reeve the bight through the underhand loop. (5) Pass a toggle through the eye of the bight (6) and pull tight.

MARLIN SPIKE HITCH

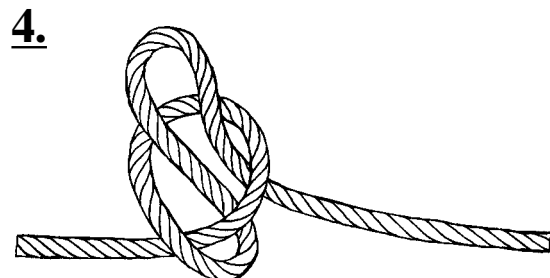
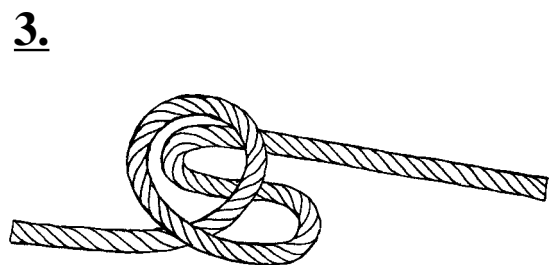
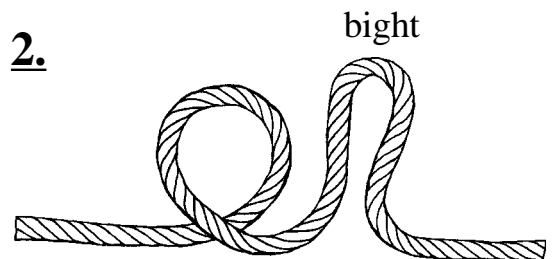
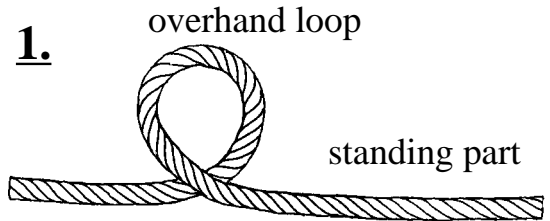



5.

toggle

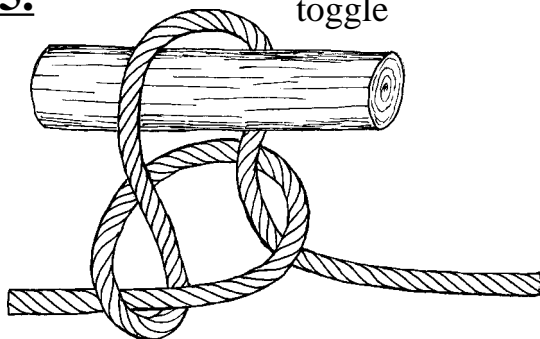

6.

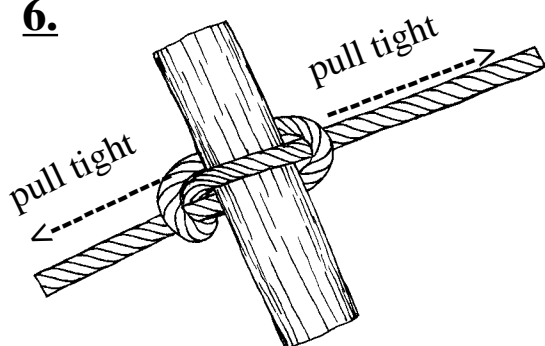

MARLIN SPIKE LADDER

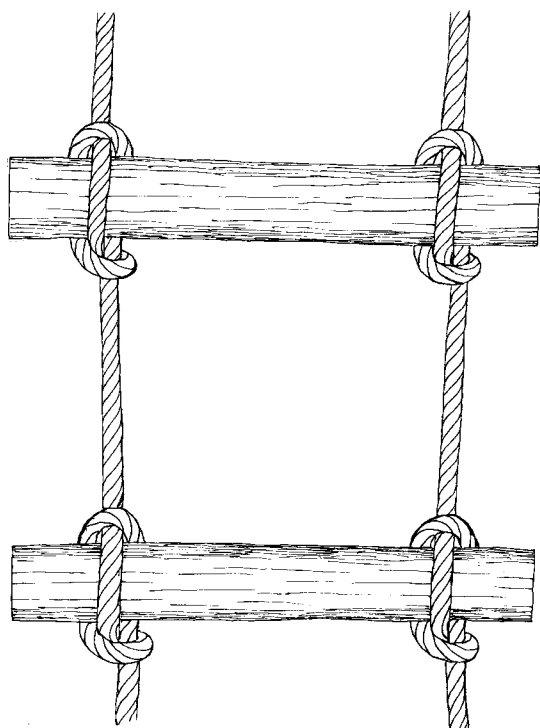

SLIP NOOSE:

Description ---- An overhand knot tied around its standing part.

Use ---- As a sliding loop for a snare; as a toggled stopper knot.

Comments ---- Related to the overhand knot. Often confused with the slip knot.

Narrative ---- Tie by folding an overhand loop over the standing part and pulling a bight of the standing part through the eye of the overhand loop. (See marlin spike hitch.)

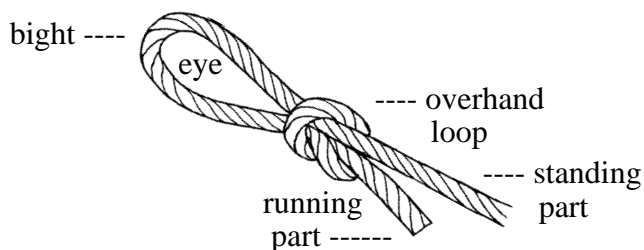

SLIP KNOT:

Description ---- An overhand knot tied around its running part.

Use ---- As a stopper knot.

Comments ---- Related to the overhand knot. Often confused with the slip noose.

Narrative ---- Tie by folding an overhand loop over the running part and pulling a bight of the running part through the eye of the overhand loop. (See marlin spike hitch.)

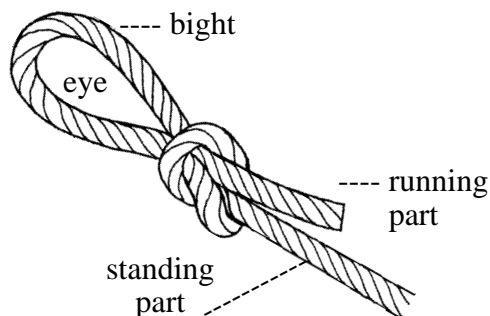

FOOTROPE KNOT

Description: a three strand knot that looks somewhat like a turk's head knot.

Comments: This knot was tied in the "footrope" (the rope that was tied under the yard arm for the sailors to stand on when they were setting the sails) to prevent the sailors' feet from slipping along the footrope.

Use: as a stopper knot in the end of a rope.

STEP 1: Unlay 4 to 5 turns of the lay. **STEP 6:**

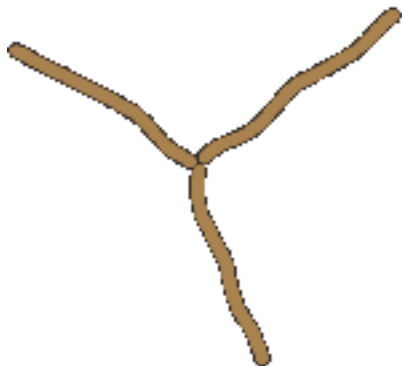

STEP 11:



STEP 2: Tie a loose crown knot.



STEP 7: Tie a wall knot under the crown knot but tuck the strands up through the center of the crown knot.



STEP 12:



STEP 3:



STEP 13: Work tight and finish by combing out the fibers to form a tassel of relay the strand and whip the end of the rope.

STEP 4:



STEP 8:



STEP 5:



STEP 9:



STEP 10:



CAMP STOOL:

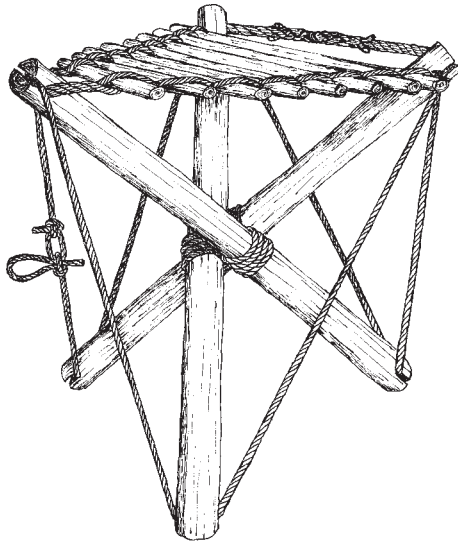

MATERIALS:

- 3 — 2 Foot * 2 inch poles
- 20 — 1/2 inch diameter sticks (various lengths)
- 1 — 3/8 inch * 5 foot rope
- 1 — 1/4 inch * 12 foot rope

CONSTRUCTION:

STEP 1: Cut a groove 1 inch deep and 3/8 inch wide in each end of the 2 foot poles. Be sure that the grooves are in the same direction.

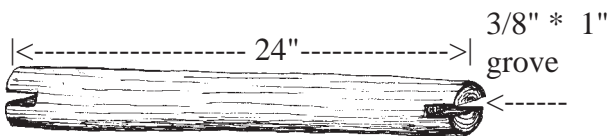

STEP 2: Lash the 2 foot pole together at their centers with the 1/4 inch * 12 foot rope. Use the equal shear tripod lash shown here.

2A1 Tie a clove hitch around one of the poles; secure the end by wrapping it around the standing end.

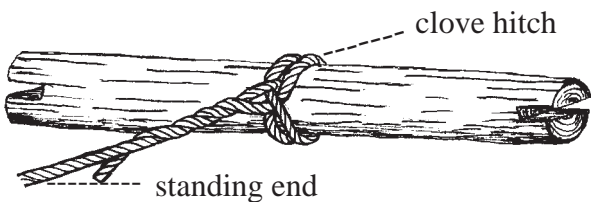

2B1 Take 4 wraps around the 3 poles; follow the pattern shown for each wrap.

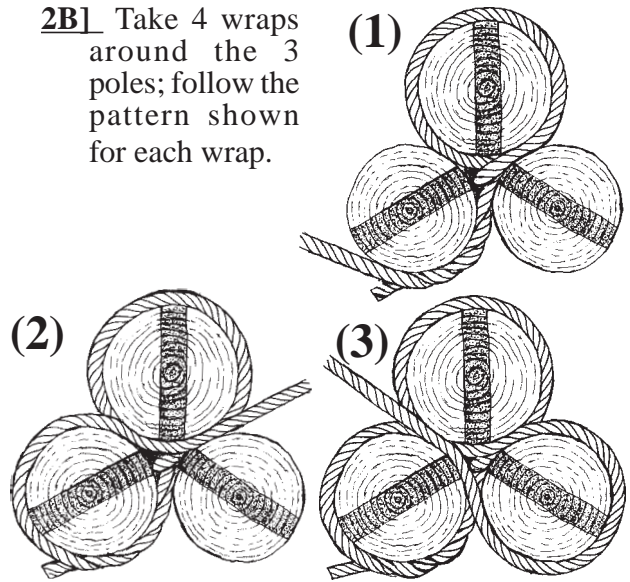

2C1 Take 2 frapping turns behind each pole.

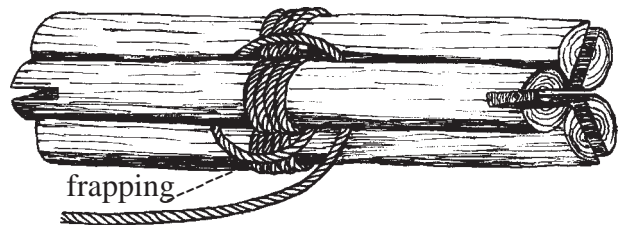

2D1 End the lashing with a clove hitch around one of the poles.

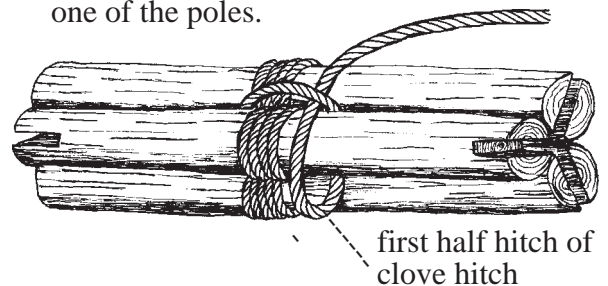

2E1 Set the tripod up by rotating each leg.

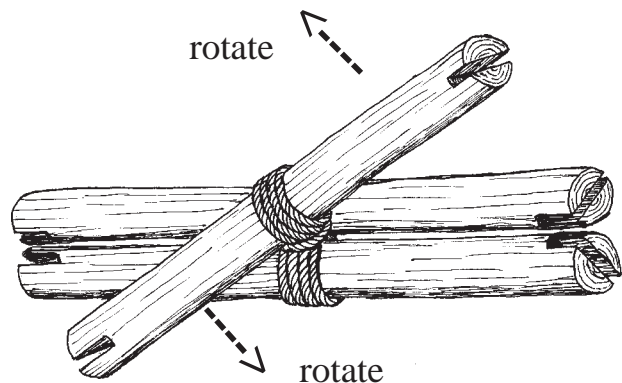



STEP 3: Prepare the seat support rope by marking the middle of the 3/8 inch * 5 foot rope by tying a piece of twine around it. Then form a loop that has a 42 inch circumference by temporarily tying the ends of the rope together.

STEP 4: Place the seat support rope in the groves at the top of the poles so that the middle of the rope is in one of the groves. Adjust the ends poles so that they are evenly spaced around the loop.

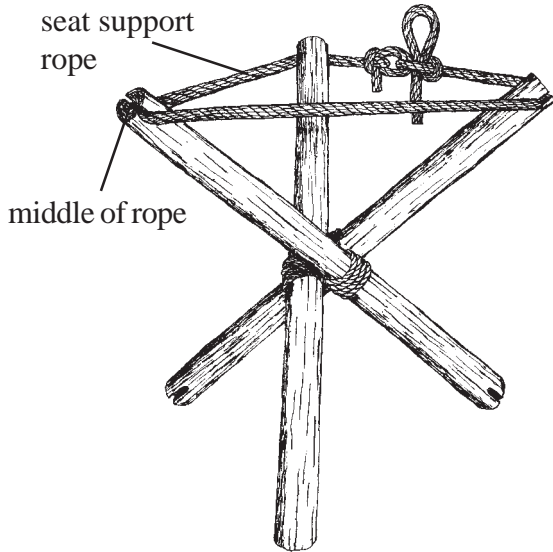

STEP 5: Add the bracing rope. Tie a bowline into one end of the 1/4 inch * 10 foot rope. Then weave the rope back and forth between the ends of the tripod poles; follow the pattern shown in the diagram. End by tying a slippery half hitch through the eye of the bowline.

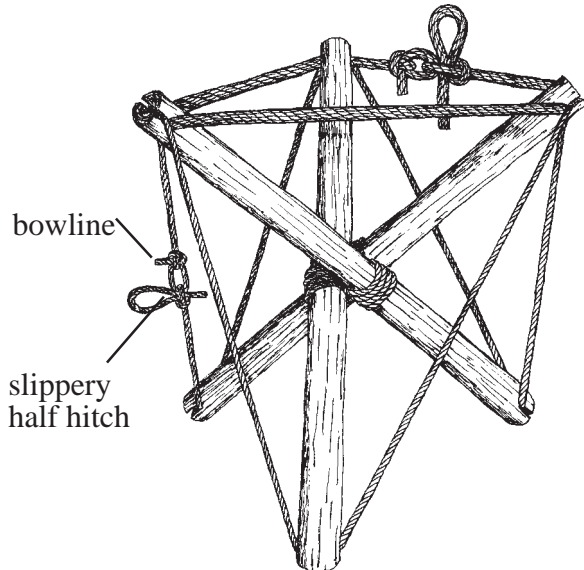

STEP 6: Assemble the seat.

6A] Lift one strand of the lay of the seat support rope on either side of the pole that is at the midpoint of the rope loop.

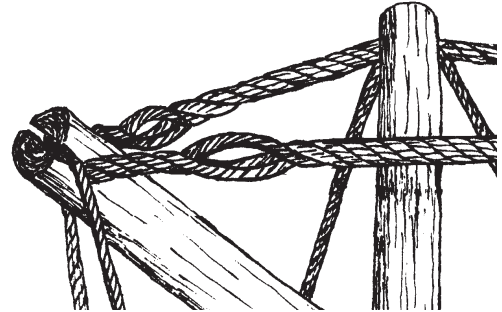

6B] Slide the ends of a 1/2 inch stick under the lifted strands of the seat support rope.

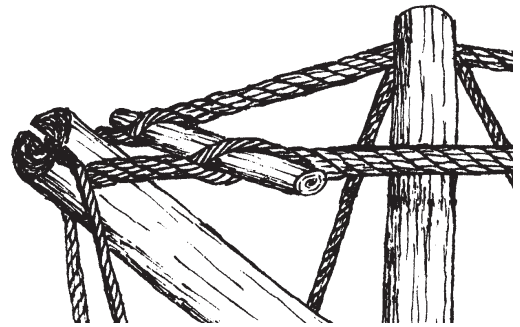

6C] Lift the next strand of the lay of the rope on either side of the pole that is at the midpoint of the seat support rope .

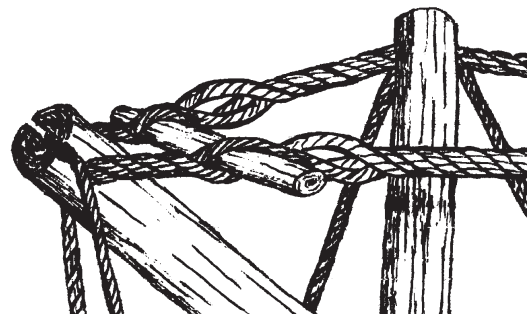

6C] Insert the next 1/2 inch stick.

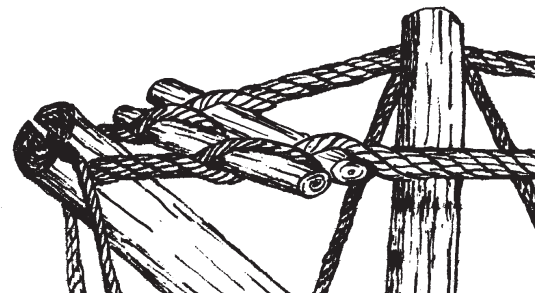

[NOTE] To keep the ends of the tripod poles at a equal distance from each other as the seat is being constructed, the temporary knot that joins the two ends of the seat support rope will need to be retied several times.

6E] Continue in this manner until the seat is the desired size.

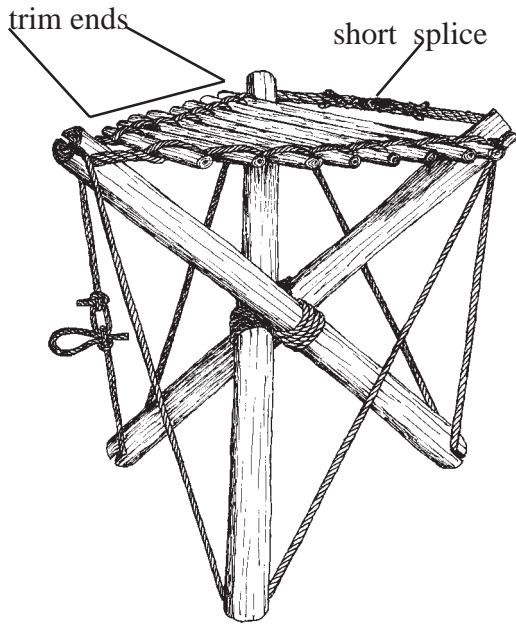

6F] Permanently join the 2 ends of the rope loop with a short splice.

6G] Trim the ends of the 1/2 inch sticks so that they extend about 2 1/2 inches beyond the rope.

[NOTE] By removing the 1/4 inch brace rope, this stool can be folded for transport and storage.

[NOTES]





MONKEY'S PAW: COIL STYLE

Narration ---- (For **monkey's paw coil stile** knot-board.) (1) Form the first coil by stacking three loop on top of each other. (2) Insert core into center of coil. (3) Start second coil by forming a small loop at the bottom of the first coil. (4) Pass the running end behind and (5) across the front to for the first loop of the second coil. (6) Add the second and third loops of the second coil. (7) Start the third coil by reeving the running end through the top of the first coil and (8) then reeve the running end through the bottom of the first coil. (9) Add the second and third loops of the third coil. (10) Work all coils tight over the core.

[NOTE] Join the two ends of the monkey's paw with an eye splice, a short splice, or a seizing.

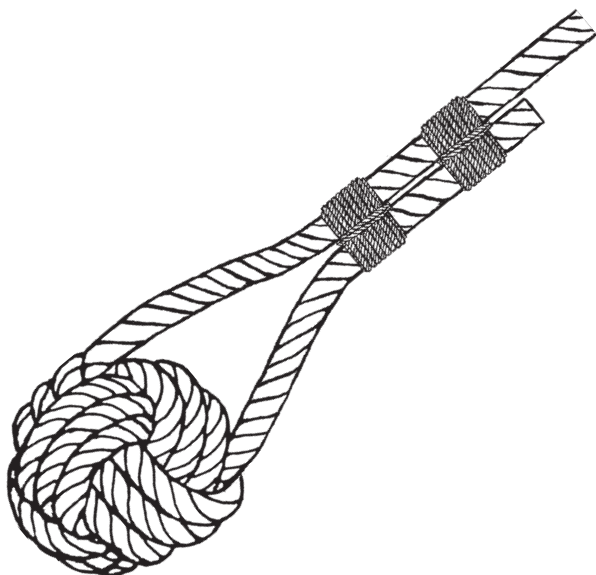

+
MONKEY'S PAW
+

(coil style)

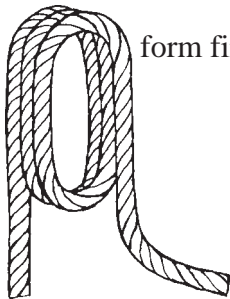
1.

form first coil

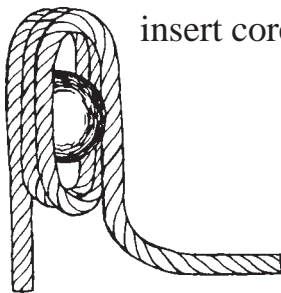
2.

insert core

start second coil

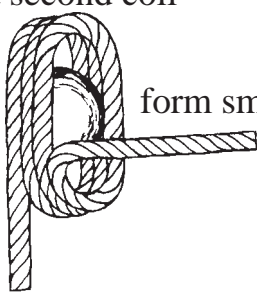
3.

form small loop

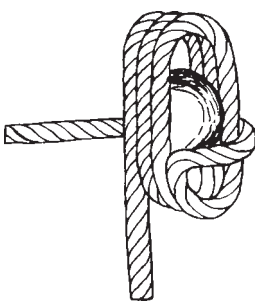
4.

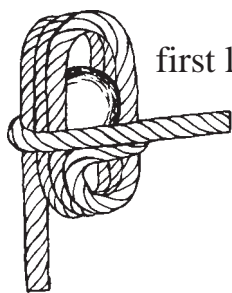
5.

first loop

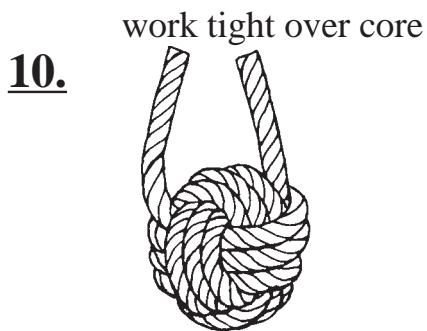
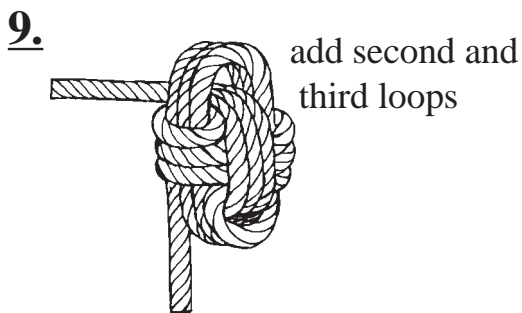
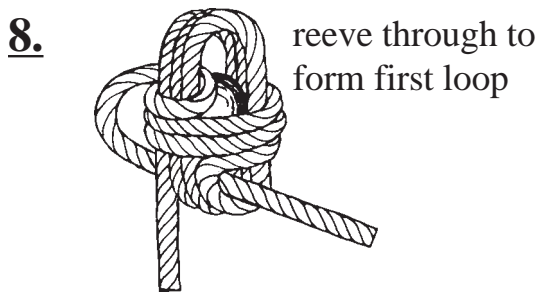
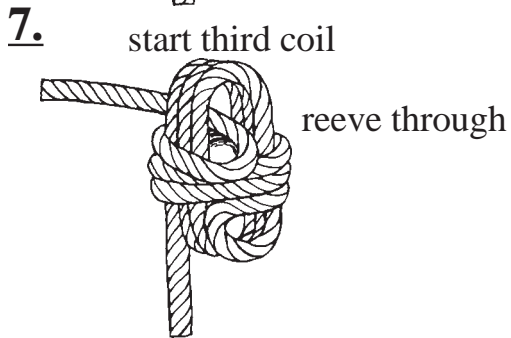
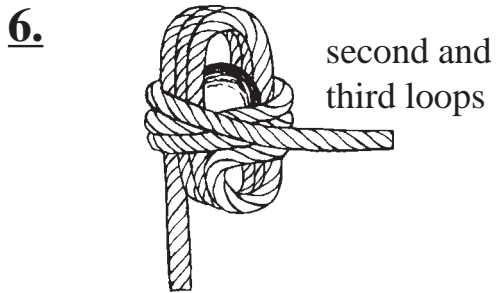

[NOTES]





Flag Pole Cleat:

A cleat is a device used to temporarily secure a line. When valuable equipment such as boat is being tied off, a commercially made cleat should be used. However, when a rustic appearance is desired a temporary cleat can be made with rope and wood.

Green Stick Cleat:

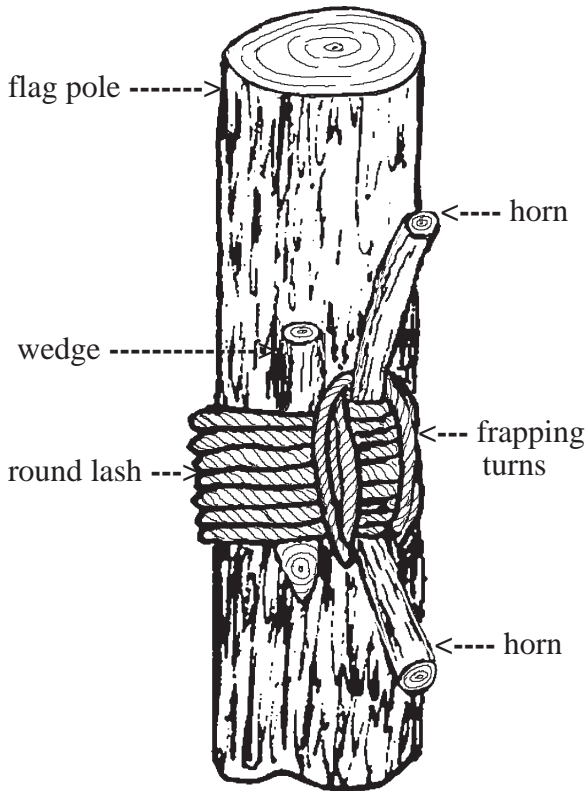

[Step 1] Round lash a piece of flexible green wood or a naturally curved piece of wood to the flag pole to make the horns of the cleat.

[Step 2] Tighten the round lashing by driving a small wedge on either side of the cleat.

[Step 3] Use frapping turns to raise the horns of the cleat.

Dry Wood Cleat:

Suggestion 1 ----

If only dry wood is available a cleat can be made as shown in the following diagrams:

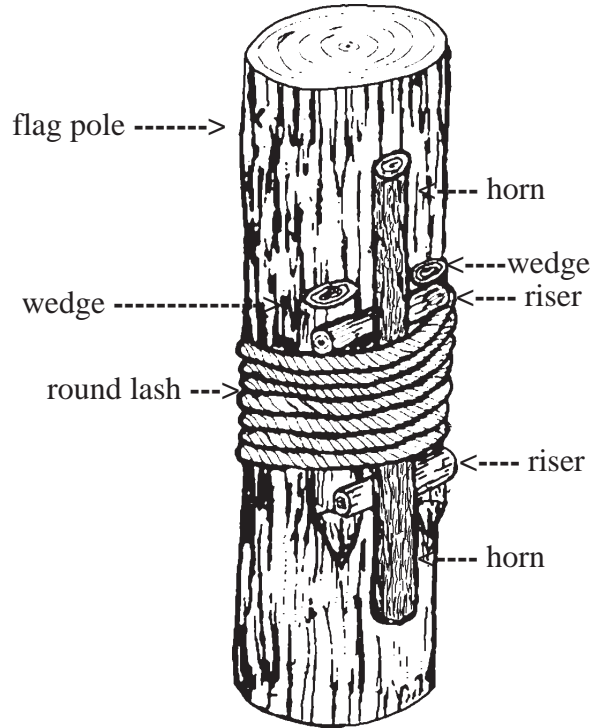

[Step 1] Round lash a stick of suitable size to the flag pole to make the horns of the cleat.

[Step 2] Raise the horns by forcing short risers under each horn.

[Step 3] If needed tighten the round lashing by driving a small wedge on either side of the cleat.

Suggestion 2 ----

Preshape the cleat from a piece of limb wood .

[Step 1] Split a 3 inch diameter by 8 inch piece of limb wood in half.

[Step 2] Use an ax and knife to shape the horns on either end of split piece of wood.

[Step 3] Round lash the cleat to the flag pole.

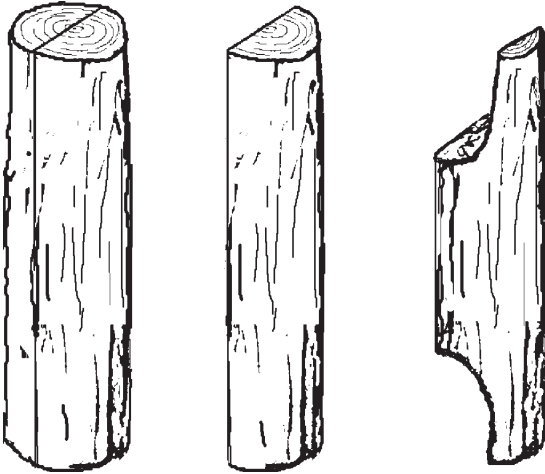

[Step 4] Tighten the round lashing by driving a small wedge on either side of the cleat.

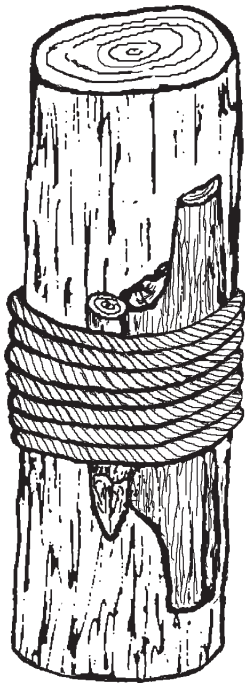

Precut Cleats:

A cleat can be made from hard wood lumber by sawing it to the desired shape and then round lashed to the flag pole. Small wedges are used on either side of the cleat to tighten the round lashing and to stabilize the cleat.

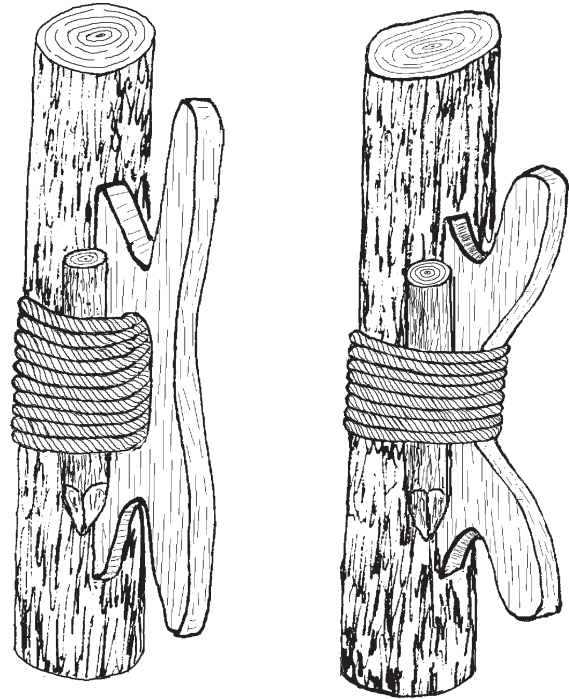

Making Wedges:

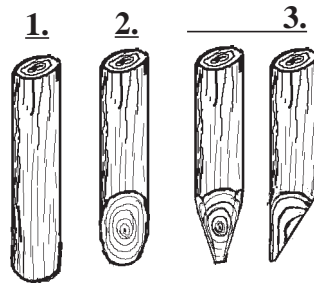

[Step 1] Cut to size. Length --- slightly longer than the width of the round lashing. Diameter --- slightly larger than the gap formed between the rope, the flag pole, and the cleat.

[Step 2] Cut one end off at an angle.

[Step 3] Taper the sides of the point so that the point of the wedge is on one side.



ROPE WRENCH:

A rope wrench is a simple tool that can be used to tighten the ropes of a lashing. Use a crochet stick that is about 18 inches long and 1 1/2 inches in diameter; the crotch should be about 6 inches from the end.

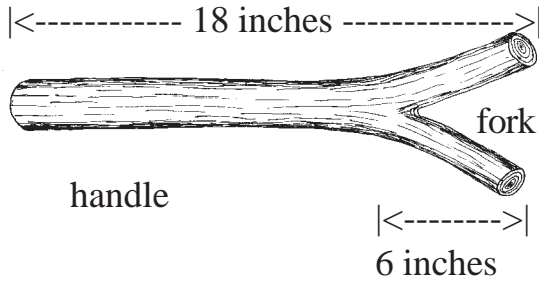

Using A Rope Wrench:

[STEP 1] Use the rope wrench by placing it over the pole next to the rope that is to be tightened.

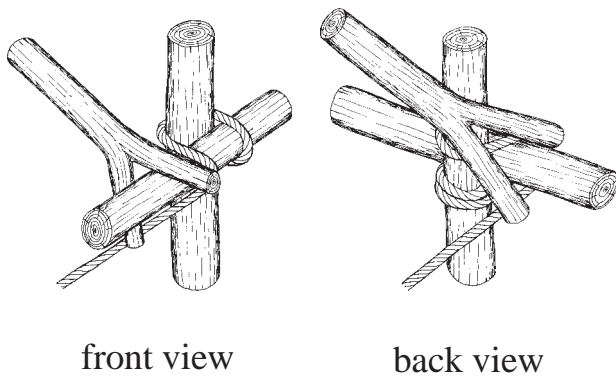

[STEP 2] Wrap the rope around the fork of the wrench.

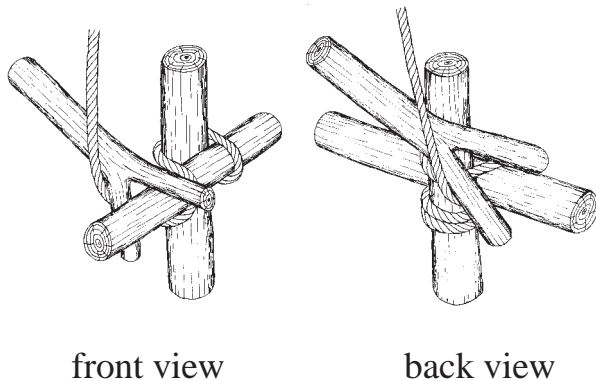

[STEP 3] Make one or two wraps around the handle of the wrench.

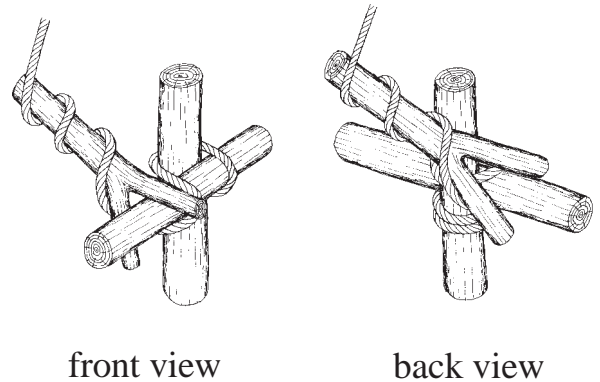

[STEP 4] Grasp the handle so that you are holding the rope firmly to the handle; then rotate the wrench around the pole.

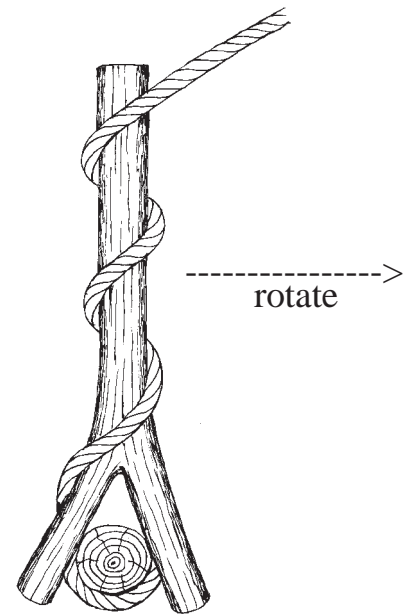

[NOTE] Tighten each turn of a lashing as it is made. The friction between the rope and the pole is too great to tighten more than one turn at a time.

Maintain the tightness of the rope by keeping a small amount of tension on it or by pressing the rope firmly against one of the poles while taking the next turn around the poles.

Be careful that the rope is not tightened so tight that the fibers of the rope begin to break.



NETTING:

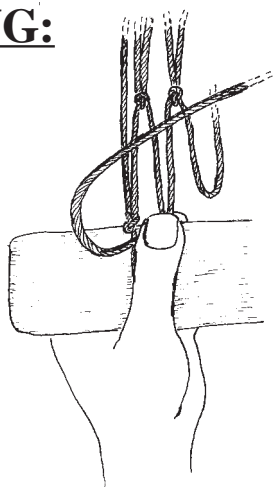

The making of netting is an ancient craft. Many prehistoric cultures used netting for a verity of uses, storage bags, fencing, hammock, just to name some and of course the obvious use as a fish net. No matter what the netting was used for, the knitting of the mesh was done by tying a series of loops in some type of twine.

In one method, the basic knot used was the sheet bend. To form and tie the loops a knitting shuttle and a spacer (gauge) were used.

NETTING TOOLS:

The size of the shuttle and gauge that is needed will depend on the project that you are working on. The size of the shuttle and gauge given in the following directions is a convenient size for many projects and is also a good size to use for practicing the craft of netting. Shuttles and gauges of different sizes can be made by changing the size of the materials used.

Knitting Shuttle:

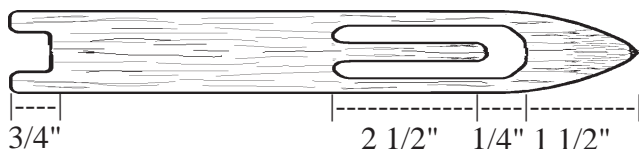

cross sections



Make the knitting shuttle from a 1/4 inch * 1 inch * 12 inch piece of smooth grained hard wood. Carve and sand the shuttle to the shape shown in the diagram. Leave the shuttle unfinished; varnish or paint has a tendency to become sticky.

Knitting Gauge:

Make the knitting gauge from a 1/4 inch * 1 1/4 inch * 12 inch piece of smooth grained hard wood. Carve and sand the gauge to the shape shown in the diagram. Leave the gauge unfinished; varnish or paint has a tendency to become sticky.

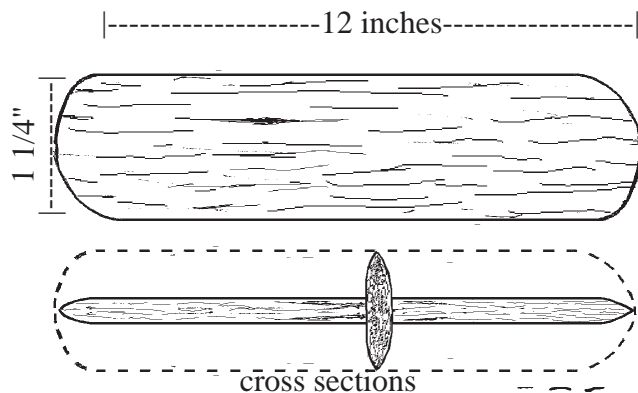

Filling The Knitting Shuttle:

STEP 1: Fill the shuttle with twine. Start by tying a single hitch around the tongue of the shuttle and then pass the twine through the notch.

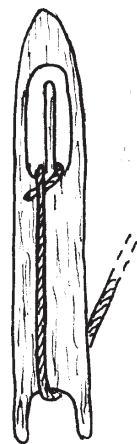

STEP 2: Turn the shuttle over, loop the twine around the tongue and then through the notch.



STEP 3: Continue turning the shuttle from side and looping the twine around the tongue until the shuttle is filled.

[NOTE] To prevent synthetic twine from fraying, use a candle flame to cut and fuse the ends.

[WARNING] Using a butane cigarette lighter to cut or fuse synthetic rope or twine may cause the lighter to over heat and explode.

DIAMOND MESH NETTING:

Diamond mesh netting is the easiest of the two forms of mesh to make. Square mesh netting will be dealt with latter.

CASTING ON: To start diamond mesh netting the first row of mesh loops is cast on to a loop of some kind. The kind of loop used depends on the project; a ring, grommet, frame or loop of twine may be used. The following directions are for casting on to a ring but the same steps may be used for any starting loop.

STEP 1: Tie the end of the twine to the ring with a clove hitch stopped with two half hitches.

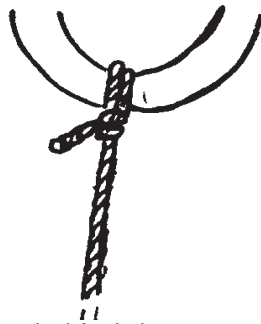

STEP 2: Place the twine behind the gauge then bring the twine in front of the gauge and to the right.

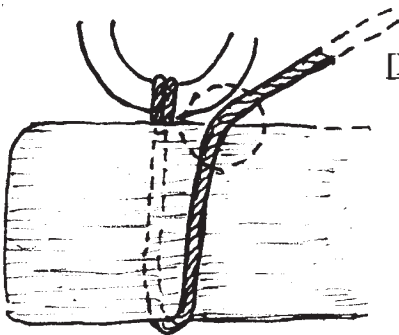

[NOTE]: The dotted circles in each of the diagrams is used to show the position of the thumb and finger of the left hand.

STEP 3: Reeve the twine through the ring from the front to the back so that an overhand loop is formed.

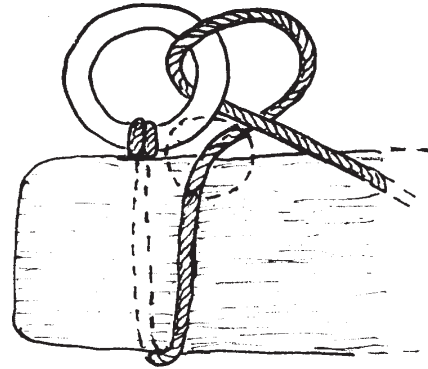

STEP 4: Pull the twine to the left to tighten the twine around the ring and the gauge.

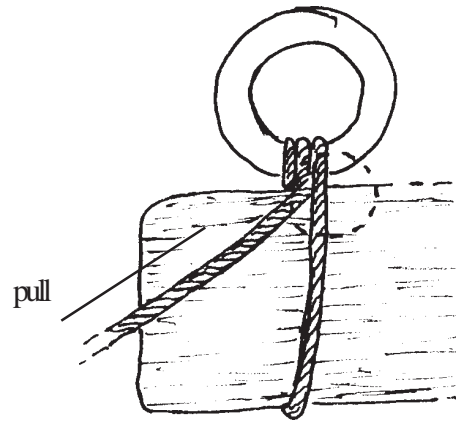

STEP 5: Lay the twine across the ring from left to right.

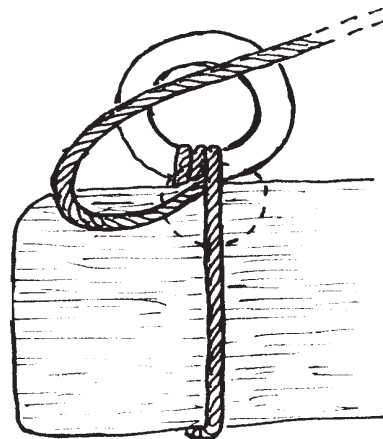

STEP 6: Reeve the twine through the ring from the back to the front.

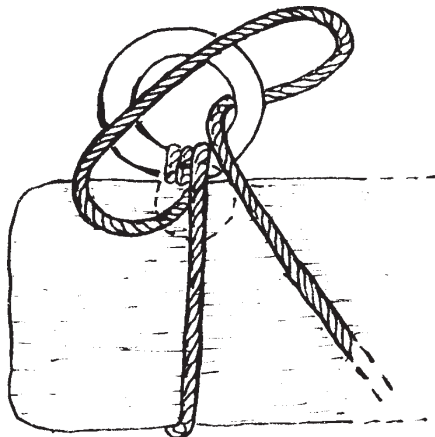

STEP 7: Place the twine behind the gauge; then pull the twine downward to tighten the twine around the ring. This forms a lark's head knot around the ring.

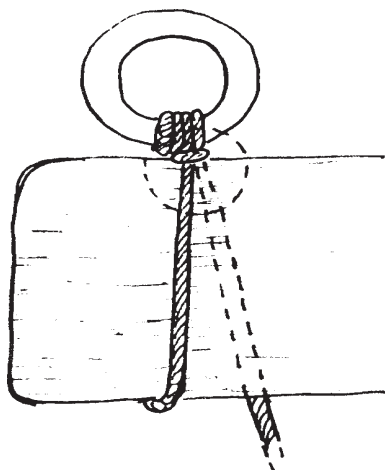

STEP 8: Repeat steps 2 through 7 for each additional loop required for the project.

KNITTING A ROW OF MESH:

Netting is made by knitting roes of mesh using a shuttle and a gauge. The gauge is used to determine the size of the mesh, and the shuttle is used to hold the twine and form and tie the mesh loops. The basic knot used in netting is the sheet bend. The following diagrams illustrate the tying of the sheet bend as it is used for knitting a net.

STEP 1: Bring the twine down and up the back of the gauge. Then pick up the next loop by passing the shuttle through the loop from front to back.

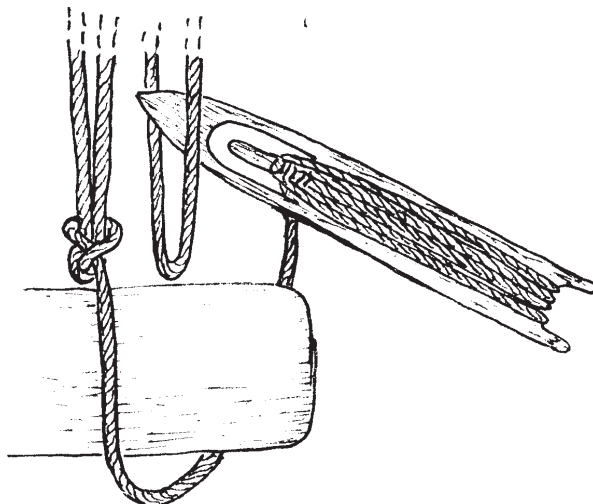

STEP 2: Pull the twine to the left to tighten the twine around the gauge. Use the thumb and finger of the left hand to hold the twine in place.

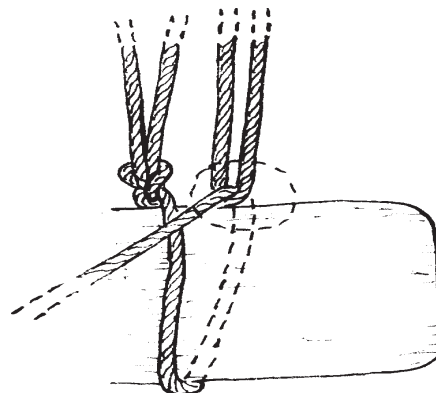

STEP 3: Lay a loop of twine over the loop just picked up.

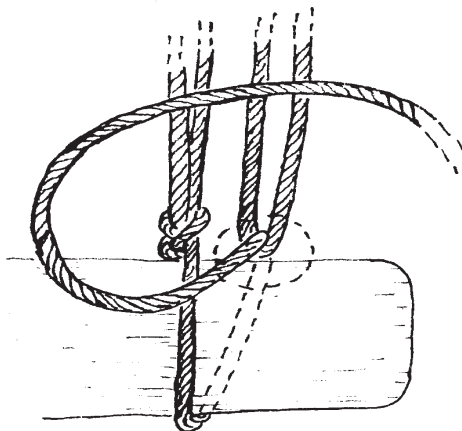

STEP 4: Pass the shuttle in back of the picked up loop and the through the loop that was laid on top.

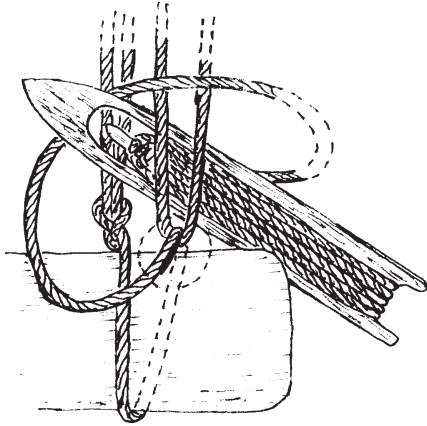

STEP 5: Pull the twine downward and slightly to the right to tighten the knot.

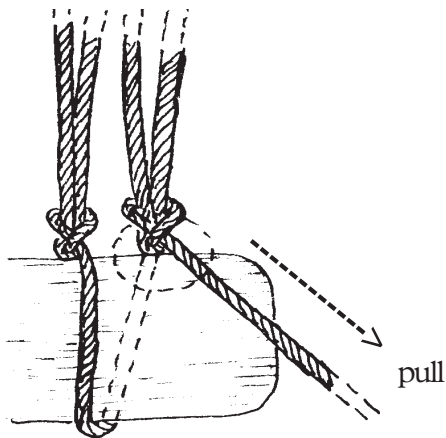

STEP 6: Repeat steps 1 through 5 for each loop in the row.

STARTING A NEW ROW:

STEP 1: When the end of a row of mesh is reached, slide the accumulated loops off the gauge, turn the work piece over so that the running end of the twine is on the left side of the work piece.



STEP 2: Wrap the twine around the gauge from front to back; pick up the first loop by passing the shuttle through the loop from back to front.

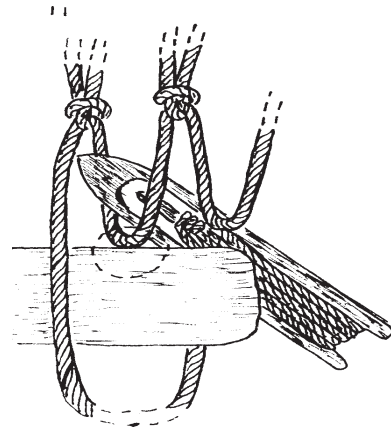

STEP 3: Knit the loop in place by following the directions for knitting a row of mesh.

ADDING A LOOP:

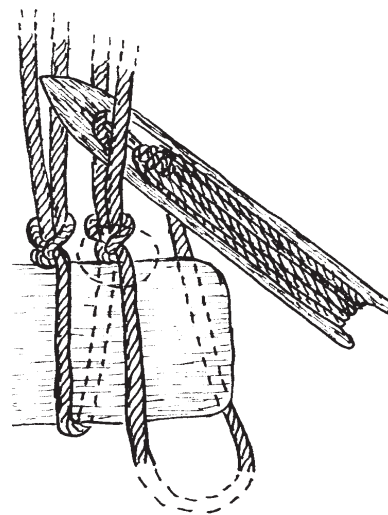

For some projects it is necessary to increase the width of the netting part way through the project. The width of the netting is increased by adding loops of mesh.

A loop is added by picking up the same loop a second time so that two loops are formed in the new row of mesh are tied to the same loop in the previous row of mesh.

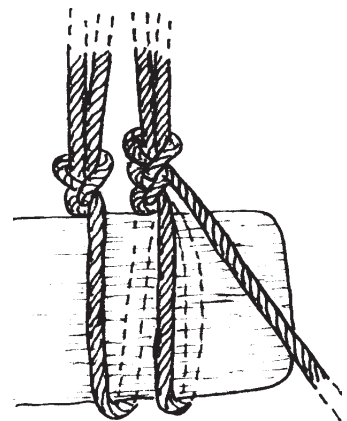

PROLONG KNOT

DESCRIPTION:

A flat knot that is made by interweaving two strands of rope.

USE:

As stair tread, mat, or chafing gear; also as a decorative knot in a two strand lanyard.

COMMENTS:

The prolong knot gets its name from the fact that it can be extended to any length.

TYING:

STEP 1:

Place the center of the rope over a peg or hook and tie a loose half knot.

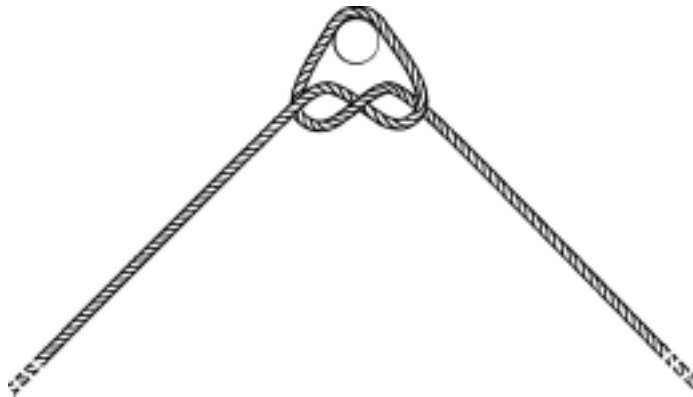

STEP 2:

Extend the half knot as shown.

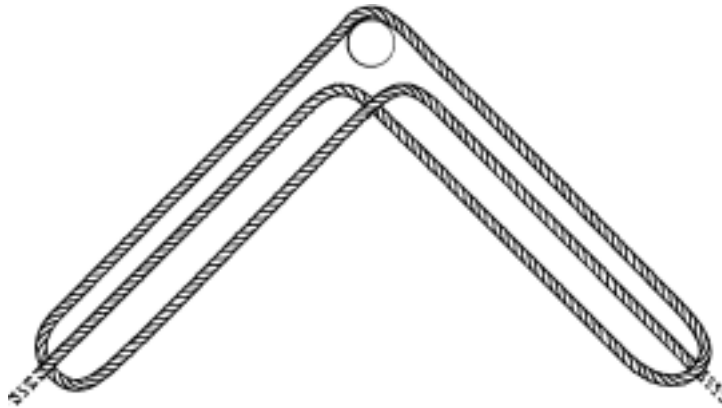

STEP 3:

Twist the left loop and extend it to the right side.

[NOTE] This will start the over under pattern of the weaving.

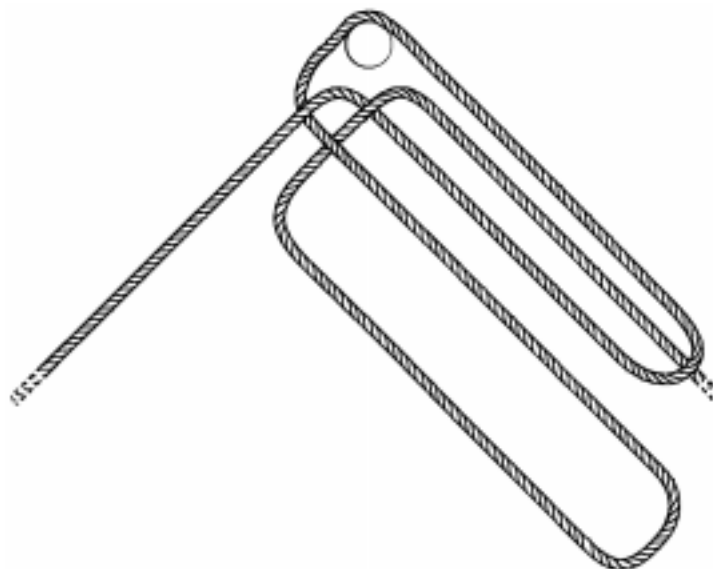

STEP 4:

Twist the right loop and extend it to the left side so that it is over the first extended loop.

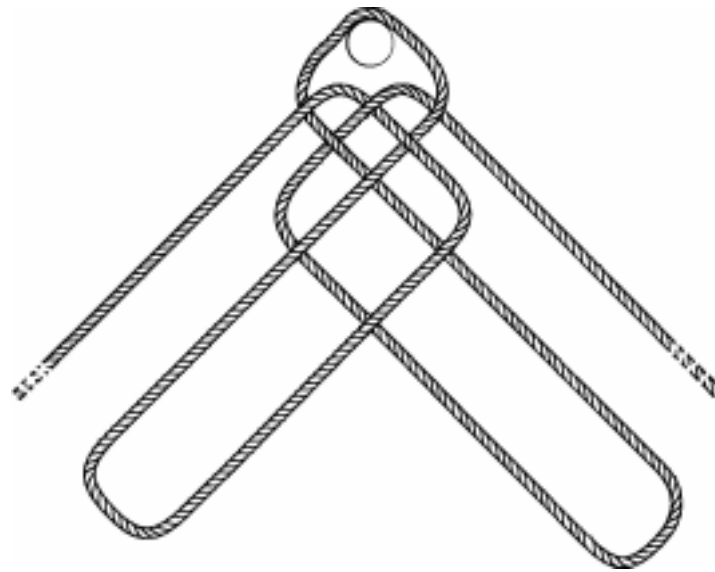

STEP 5:

Weave the left strand to the right in the pattern shown.

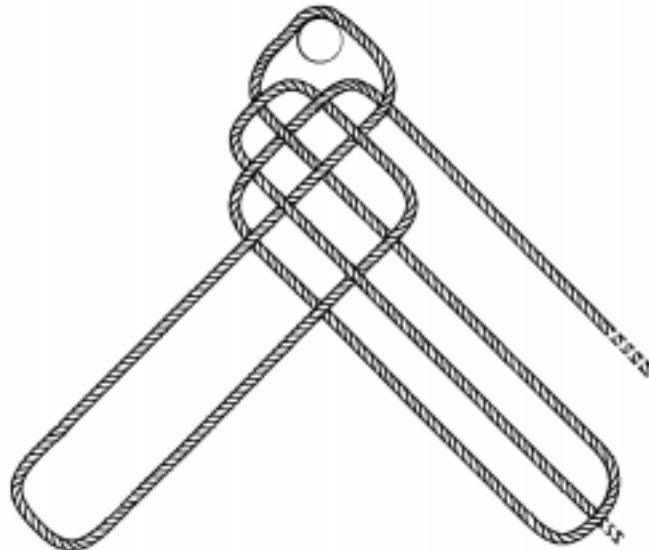

STEP 6:

Weave the right strand to the left in the pattern shown.

[NOTE] This completes the four bight prolong knot. At this stage it may be ended and worked firm (over tightening distorts the knot) or the strands may be doubled as shown in later diagrams.

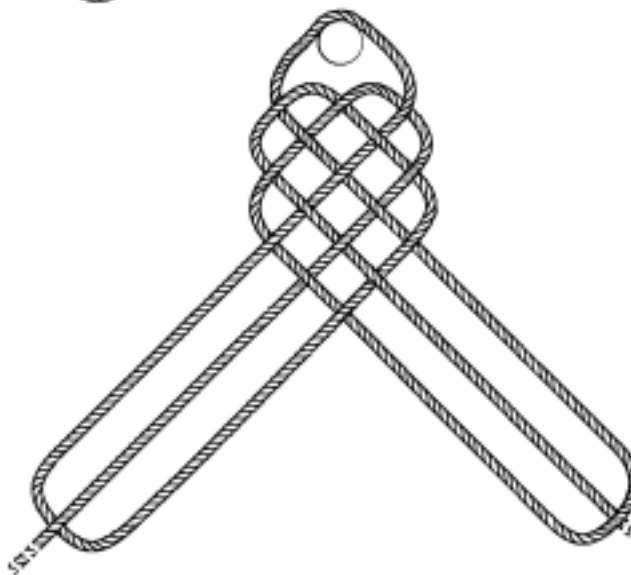

STEP 7:

Twist the left loop and extend it to the right side.

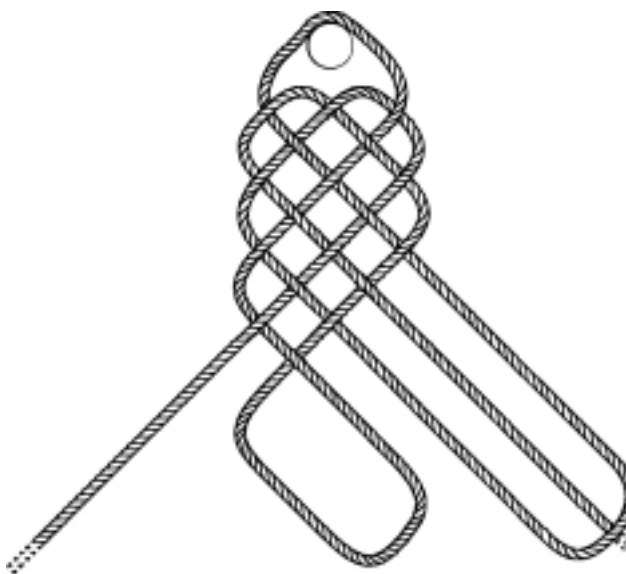

STEP 8:

Twist the right loop and extend it to the left side so that it is over the first extended loop.

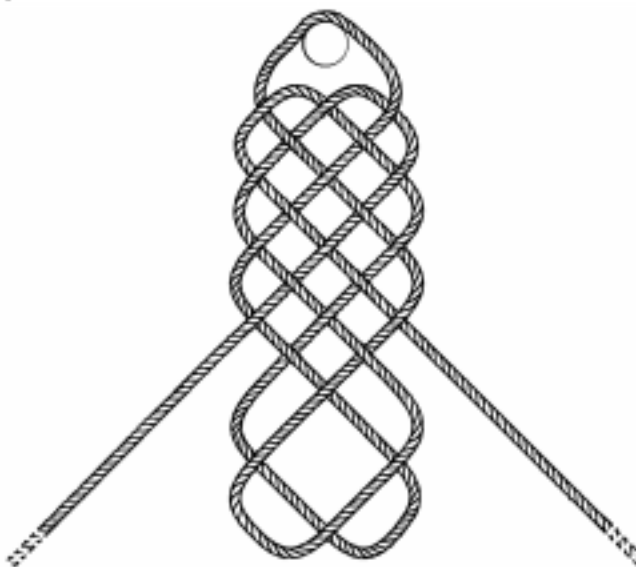

STEP 9:

Weave the right strand to the left in the pattern shown.

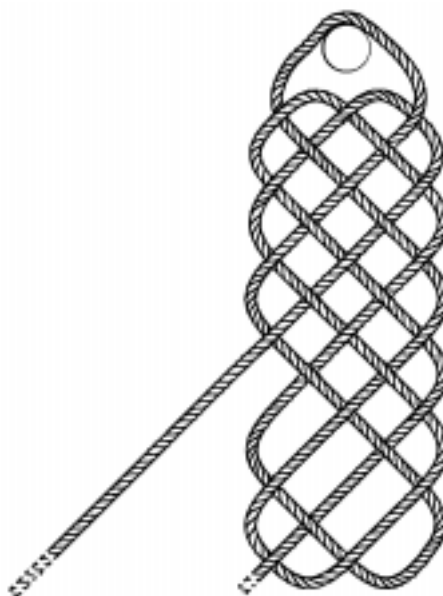

STEP 10:

Weave the left strand to the right in the pattern shown. This completes the 7 bight form of the prolong knot.

[NOTE] The prolong knot can be extended three bights at a time by repeating steps 7 through 10 for each extension.



STEP 11:

Start doubling the strands by chacing (following) the opposite strand.



STEP 12:

Complete doubling the strands. Then work the knot into a firm mat . Do not over tighten the strands as this will distort the mat.

[NOTE] The ends of the strands can be hidden by sewing them to the adjacent strand on the underside of the mat.





LIFE BASKET:

Description ---- A body harness made by combining a bowline on a bight and a french bowline.

Use ---- To lower a severely injured person when a life threatening situation exists.

Comments ---- The life basket is a secure harness that can be used to move an injured person that is weakened or unconscious. However, unless there is a life threatening situation, such as a burning building or immediate danger of avalanche, you should wait for a trained rescue team.

If you attempt to use the life basket, do not allow the rope to slide through your hands as you lower the injured person. The friction caused by the sliding rope can cause severe painful rope burns and loss of control of the rope. The rope must be let out in a hand over hand manner to insure a safe, controlled descent.

Narration ---- (1) Tie a bowline on a bight. Place one loop of the bowline on a bight around each leg. [NOTE] (The bowline on a bight should be large enough so that when it is in place the knot should be close to the victims belt buckle. Be sure to leave the running part of the rope extending about 3 feet beyond the knot.)

1.

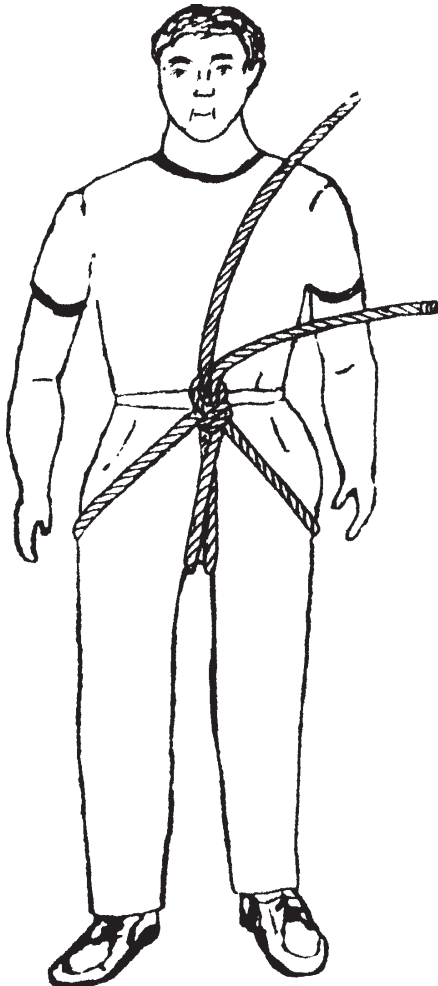

2.



(2) Take a half hitch around the victims chest.

- (3) Form a bight in the standing part by pulling it under the right hand part of the half hitch so that an underhand loop is formed around the cross point of the half hitch.

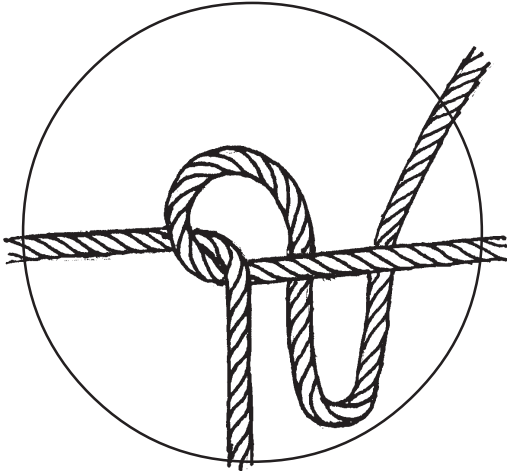

- (6) Take the slack out of the running part of the rope and fold it over to form interlocking bights.

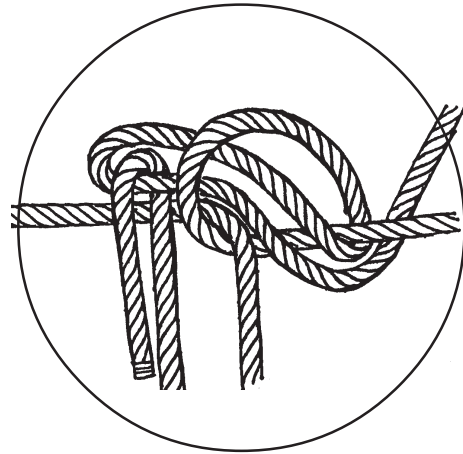

- (4) Fold the bight around and reeve it through the eye of the underhand loop.

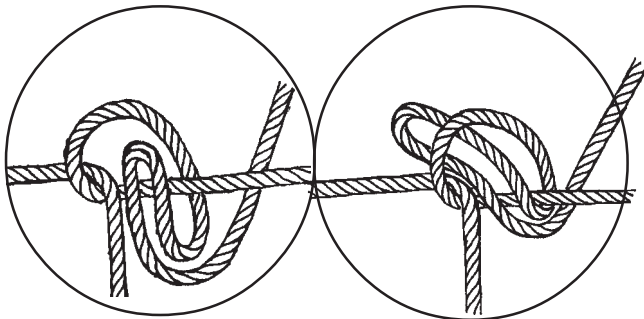

- (7) Pull on the standing part so that the bight in the running part of the rope is pulled through the eye of the underhand loop and the underhand loop flips over and tightens around the bight to form a French Bowline.

- (5) Reeve the running part of the rope through the bight.

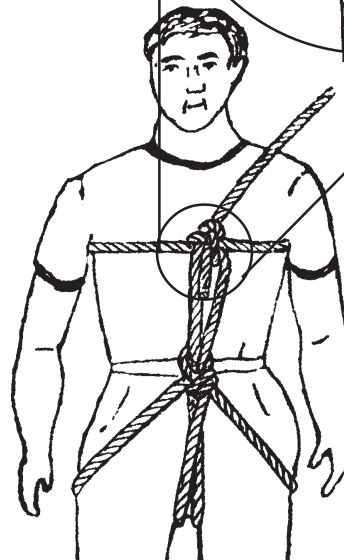
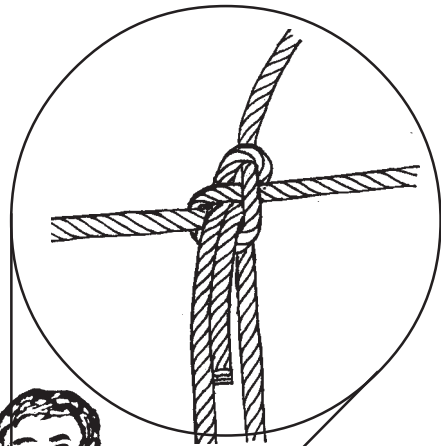
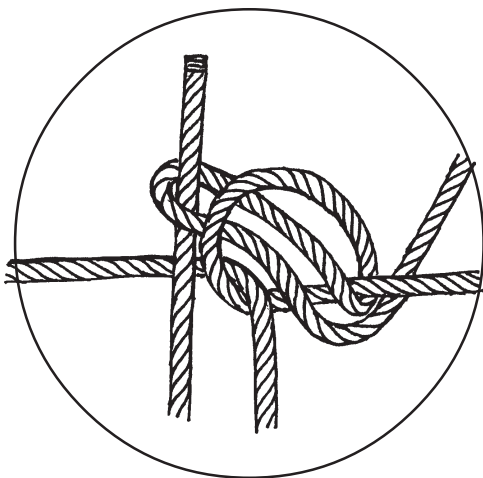

SPHERICAL KNOB COVERING

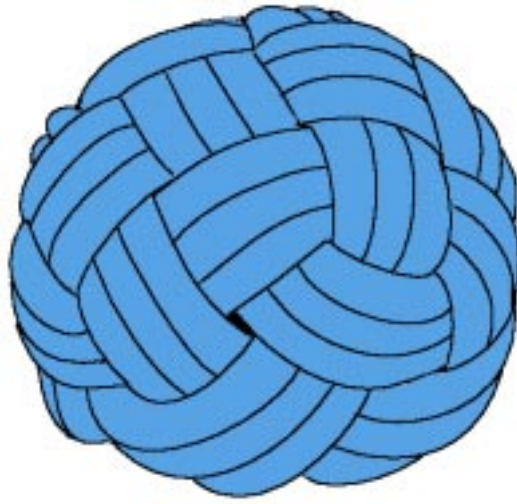

This knot is used to cover knobs. One example would be to cover a knob at the end of a walking stick.

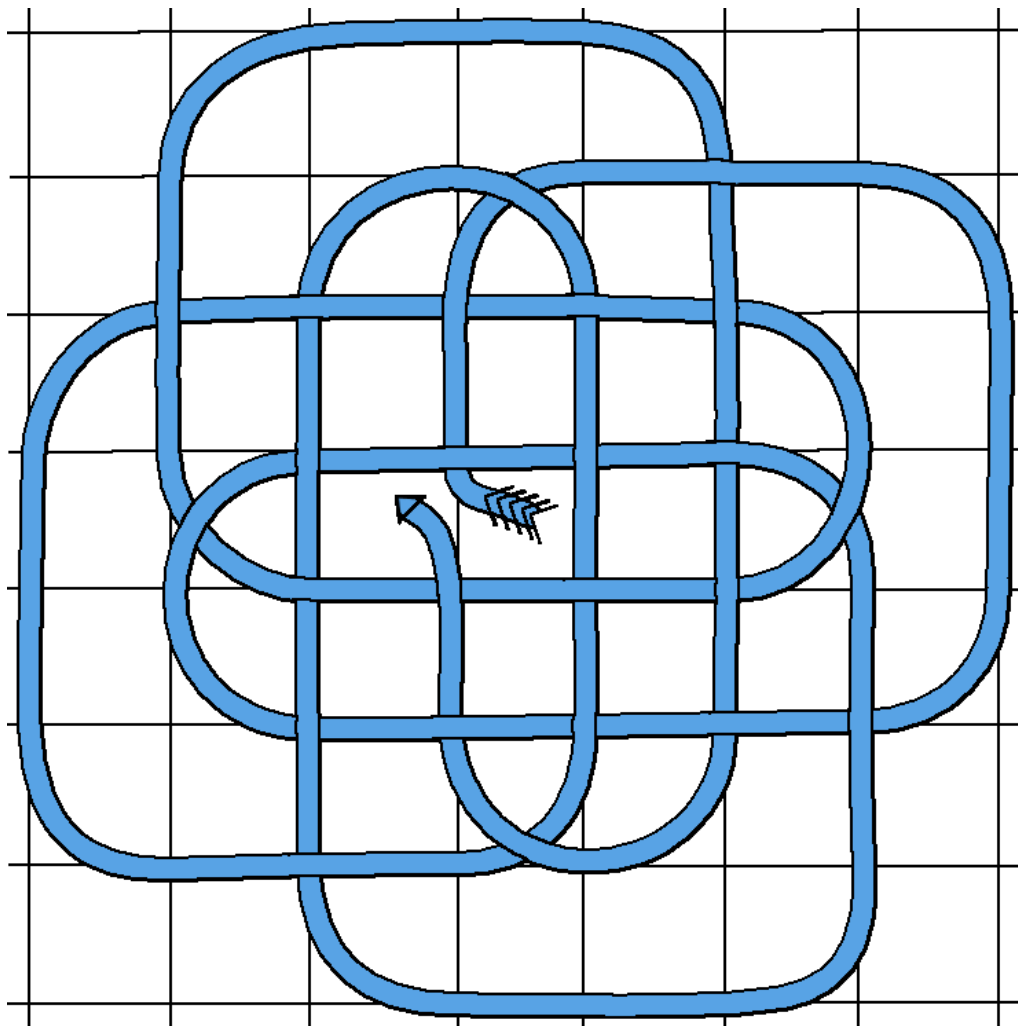

The length of cord needed to tie the knob covering knot depends on the size of the cord and the number of times the pattern is to be chased. A good length to start with is 8 times the circumference of the knob for each time the pattern is to be chased. [Example: a one inch knob has a circumference of a little over 3 inches. To cover a one inch knob it would require about 25 inches of cord for each time the pattern is chased. The pattern should be chased at least 2 times. This means that about 50 inches of cord would be used to cover a 1 inch knob.

The knob covering knot is difficult to tie “in hand” the easiest method of tying it is to make a copy of the diagram and fasten the diagram to a work board. Start by pinning the middle of the cord to the feathered end of the arrow in the diagram. Then following the path indicated, pin the cord to the diagram. Be sure to follow the over/under pattern indicated in the diagram. Studying the following partial diagrams may help.

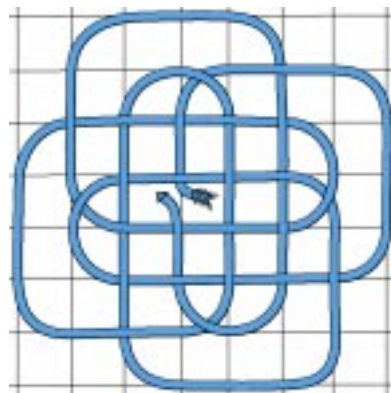
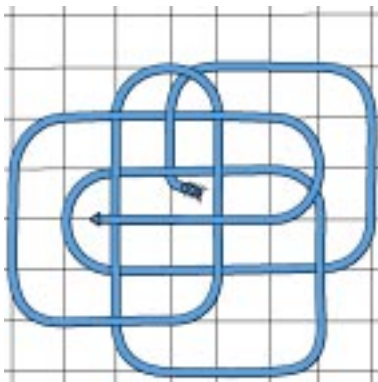
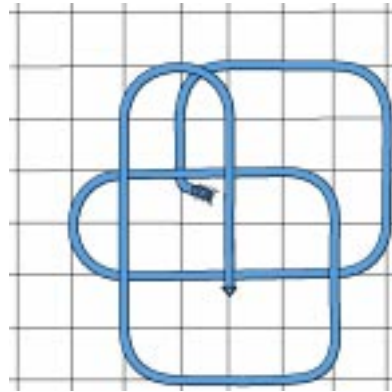
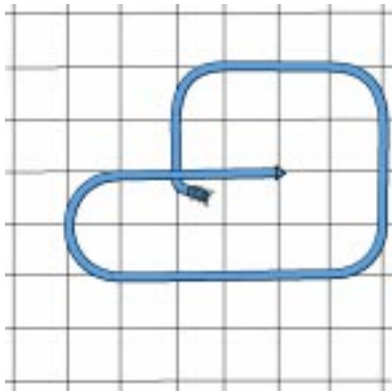

After the knot is tied on the work board unpin it and work it loosely into shape over the knob. Then chase the pattern the required number of times. Next work the knot tight around the knob. Do not rush this stage. When the knot is tight cut off the ends of the cord and push the ends into the knot.

To preserve the knot, it may be varnished or painted.

Walking Stick:

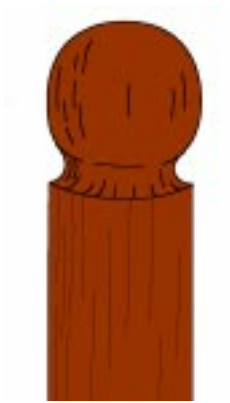

Carve a knob on the end of the walking stick.

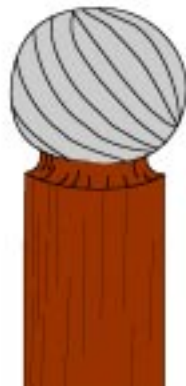

If desired, the size of the knob can be increased by wrapping it with tape.



Tie the covering knot and work it tight over the knob.



CROWN KNOT:

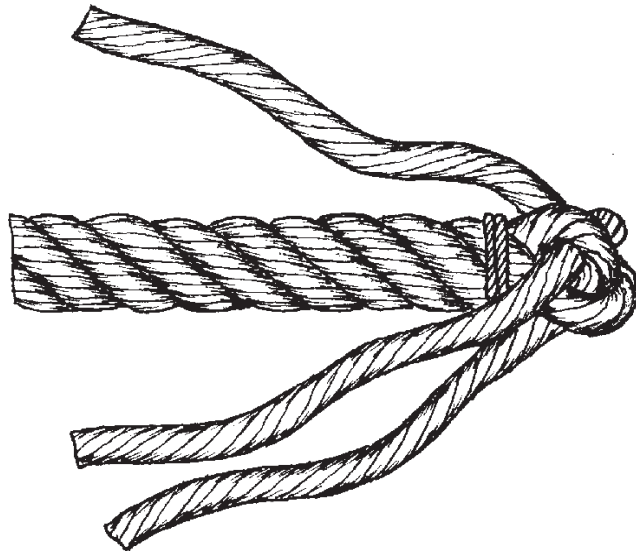

Use ---- To tie of the end of a rope so that it does not unlay. ----- To begin a back splice. ---- As part of several multiple strand knots.

Narration ---- (For **crown knot** knotboard.) (1) Tie off the rope 6 complete lays from the end. (2) Unlay the rope to the tied off point. (3) Place the end of one of the unlayed strand between the other two unlayed strands; (4) press the strand firmly between the strands so that a loop is formed. [NOTE] As you are looking at the end of the rope work counterclockwise around the rope . (5) Fold the second strand over the first strand. [NOTE] This will hold the loop in the first strand in place. (6) Reeve the end of the third strand through the eye of the loop. (7) Fold the third strand over the second strand. [NOTE] This will hold the second strand in place. (8) Pull the loop closed. [NOTE] Work and pull all three strands until the knot is even and symmetrical.

(+)
(+)

CROWN KNOT

1.

6 5 4 3 2 1

tie off
2.

unlay
3.
4.
5.



6.

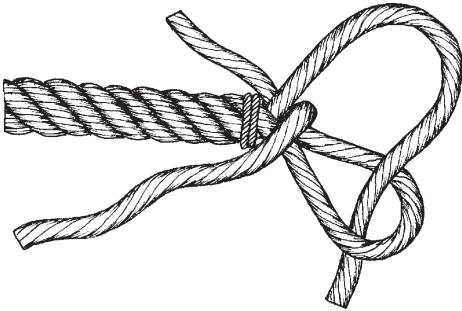

7.

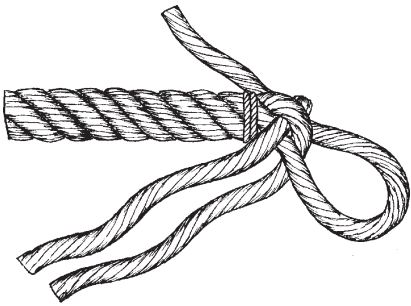

8.

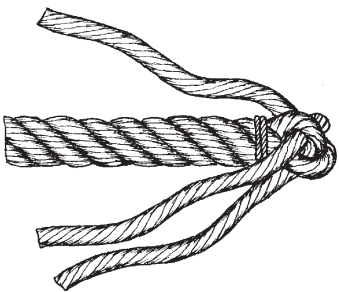

pull all
strands
snug and
even

[NOTE]



WALL KNOT



Use ---- To tie of the end of a rope so that it does not unlay. ---- As part of several multiple strand knots.

(1) Tie off the rope 6 complete lays from the end



(2) Unlay the rope to the tied off point.



NOTE: work the knot in a counterclockwise direction as you look at the end of the rope.

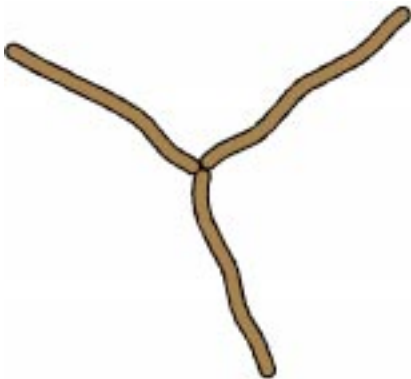

(3) Place the end of one of the unlayed strands under the strand to its left. (Hold the loop open as you work the knot).



(4) Place the second strand under the first and third strand.



(5) Place the third strand under the second strand.



(6) Reeve the end of the third strand up through the loop formed in the first strand.

[A]



[B]



(7) work tight.



ALAMAR KNOT

The alamar knot is a decorative knot related to the pretzel. The pretzel knot is tied in a single strand; the alamar knot is tied by doubling the strands as shown in [Step 1]

[Step 1] Double the strand as shown.

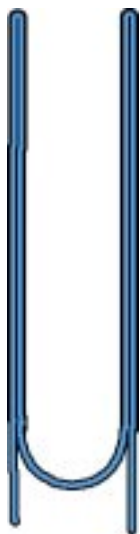

[Step 2]



[Step 3]



[Step 4]



[Step 5] Add tassels or other end decorations.





[Home](#)
[E-Mail](#)



ROPE WORKS ©1996 Gerald L. Findley, all rights reserved

LINKS



[The International Guild of Knot Tyers](#)

[The International Guild of Knot Tyers, Texas Branch](#)

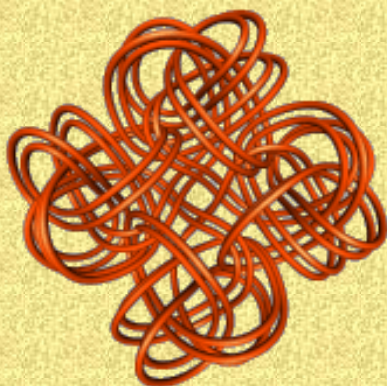

[Knots on the Web](#)

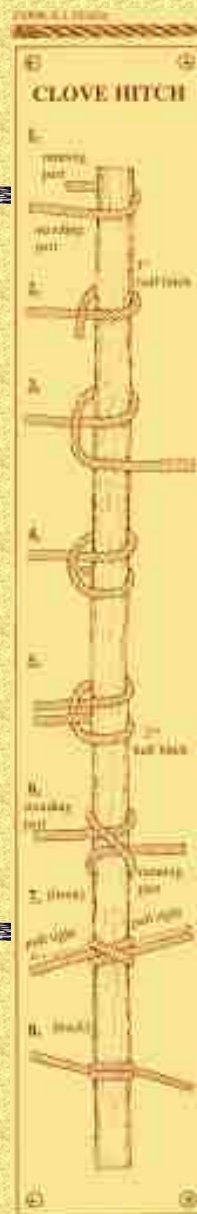



U.S. Scouting Service Project

The MacScouter

Welcome to Scouting Resources Online

U.S. MACSCOUTER

[Home](#)
← [GUESTBOOK](#) →
[E-Mail](#)



ROPE WORKS ©1996 Gerald L. Findley, all rights reserved

**The following topics about rope making
are covered in :**

ROPE WORKS

MATERIALS:

Any of the following materials may be used to make rope: binder twine, bailer twine, plastic twine, jute twine, yarn, string, or plastic bags. Just about any material that is made up of long flexible strands or that can be cut into strands can be used to make rope. However, only twines of proven strength should be used to make rope that will be expected to carry a load or lash a structure.

TYPE OF ROPE:

The type of rope that is explained in this book is three strand laid rope. This type of rope is made by twisting three strands of fiber in one direction and then laying the three strands together by allowing the strands to twist together in the opposite direction.

A SIMPLE ROPE MACHINE:

The twisting and laying can be done by hand but this takes a long time. To speed up the operation a machine is needed.

A rope machine consists of two devices; one that twists the three strands, the twisting end; and one that is used to lay the twisted strands together, the laying end.

ROPE WORKS has a set of diagrams showing a simple machine that can be made from scrap lumber and coat hanger wire.

SETTING UP A ROPE MACHINE:

After the two ends of the rope machine are positioned, tie the end of the twine to the laying end hook. Then hook the twine over one of the hooks on the twisting end, then back to the laying end hook. Continue back and forth until each of the three hooks on the twisting end have two lengths of twine on it. Be careful to keep the tension equal on all lengths of twine.

TWISTING THE STRANDS:

After the machine is set up, turn the cranks on the twisting end so that the cranks are turning clockwise as you are looking at the crank handles. It is a good idea to mark this direction on the frame of the machine.

Twist the strands until they become firm and resist further twisting. If the strands are not twisted tight enough the rope will be loose. On the other hand if you twist the strands too tight the strands will kink. Kinked or loose strands will weaken the rope. Experience will teach you when the amount of twist is just right.

[NOTE] During the twisting the laying end must not be turned.

[NOTE] While twisting and laying a modest amount of tension must be kept on the rope.

LAYING THE ROPE:

To lay the rope a rope-wrench will be needed. A rope-wrench can be made from a crotched stick.

The actual laying of the rope is done by turning the laying end crank in a counterclockwise direction and moving the rope-wrench toward the twisting end.

MAKING A GEARED ROPE MACHINE:

A geared rope machine not only speeds up the process of making rope but can also be used to make rope several inches in diameter.

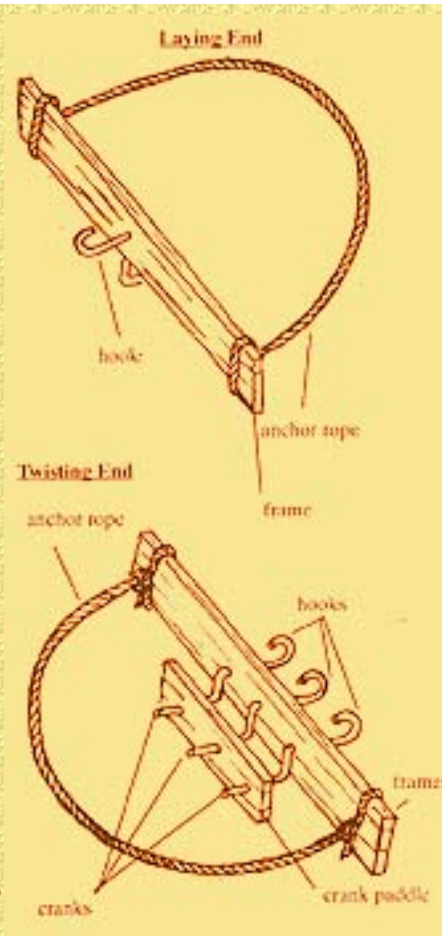

The patterns and instructions included in **ROPEWORKS** are for building a wooden geared rope machine that has a 3:1 gear ratio. This rope machine can be constructed with hand tools.

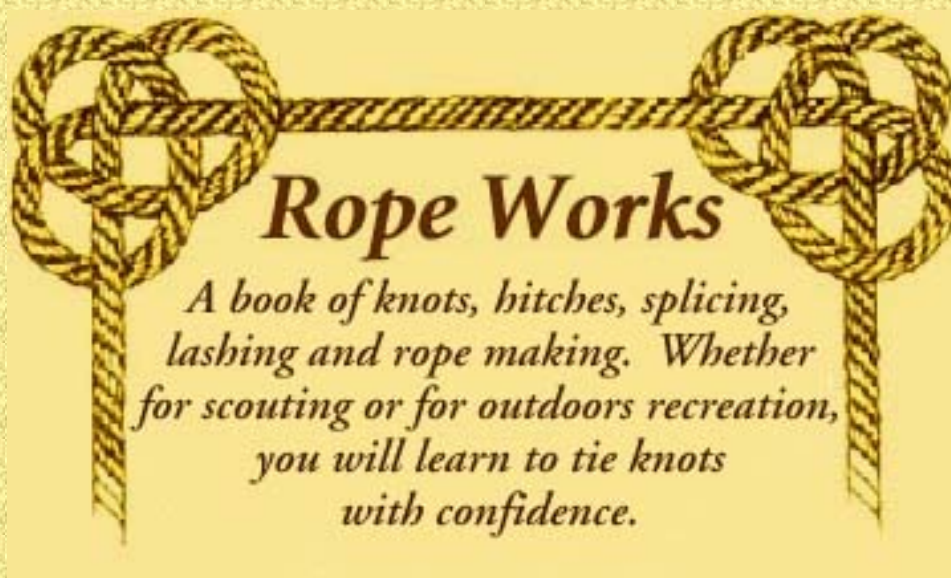
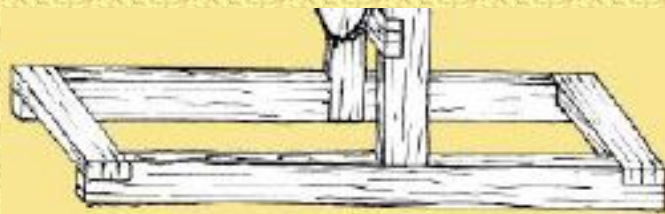

Order a copy of RopeWorks now !





Gerald L. Findley, all rights reserved

ROPE WORKS ©1999

Lashing

Lashings are used to join poles or spars when building pioneering structures. These structures can be functional, such as tables, bridges, and towers or decorative such as gateways. The only limit as to the type of structure is the imagination of the builder.

Correctly tied lashings in pioneering structures are essential for safety. When young people see an interesting structure they charge up and over with no thought as to the soundness of the structure. This places the responsibility for a safe structure directly on the builder.

The following topics about lashing are covered in :

ROPE WORKS

Square Lashing
Diagonal Lashing
Tripod Lashing With Racking Turns
Tripod Lashing With Plain Turns
Shear Lashing With Racking Turns
Shear Lashing With Plain Turns
Shear Lashing Quick
Round Lashing
Round Lashing West Country
Floor Lashing



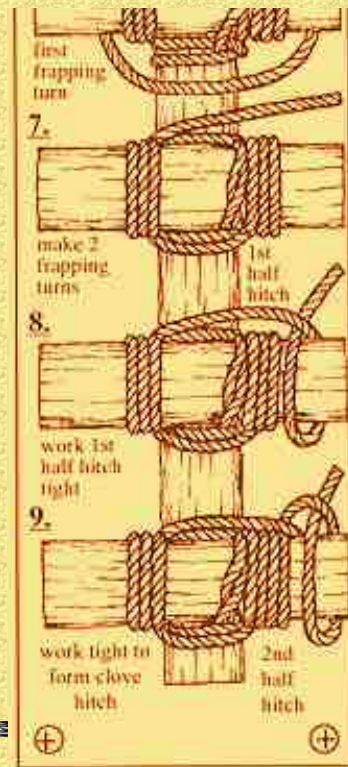
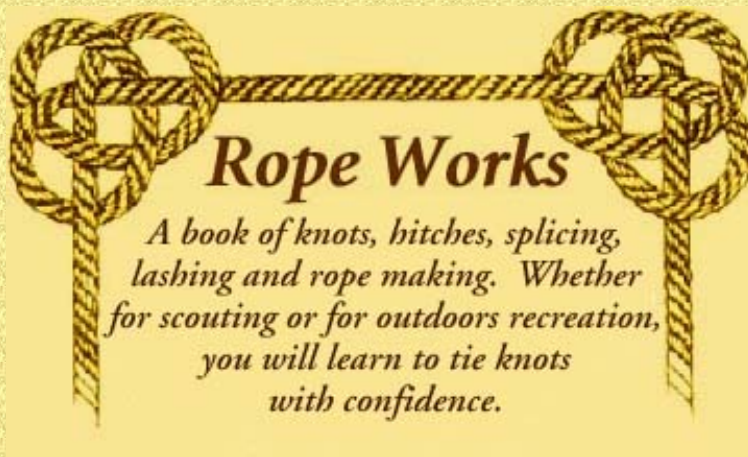

Order a copy of RopeWorks now !



Home
E-Mail





Gerald L. Findley, all rights reserved

Splicing

Splicing is used to join ropes together by interweaving the strands of the rope. Splicing is the safest way to fasten two ropes together or to form a loop. Knots could also be used to do these jobs but knots weaken the rope by as much as 30 to 55 percent of the original strength of the rope. However, with a splice the rope is 85 to 90 percent as strong as the original rope. Splicing should be used whenever there is a concern about safety or when the loop or joint is going to be left in the rope.

[NOTE] After a splice is started or after each round of tucks, fold the strands back over the work. You will notice that there is one strand going in and one strand coming out between each of the strands of the standing end. If this configuration does not exist you have made a mistake; trace the strands back and correct the mistake or pull strands out and start over.

The following topics about splicing are covered in :

ROPE WORKS

Crown Knot
Back Splice
Eye Splice
Short Splice
Adding A Round Of Tucks
Ending A Splice

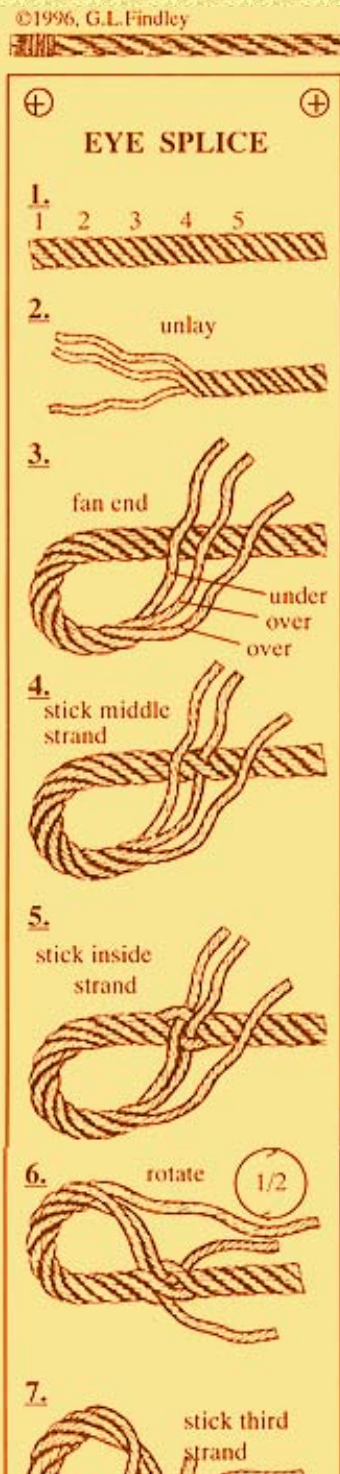

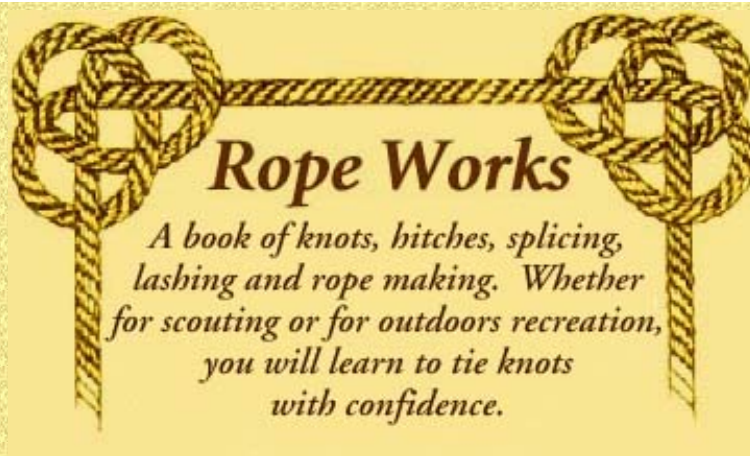

Order a copy of RopeWorks now !

[Home](#)
 [GUESTBOOK](#) 
[E-Mail](#)

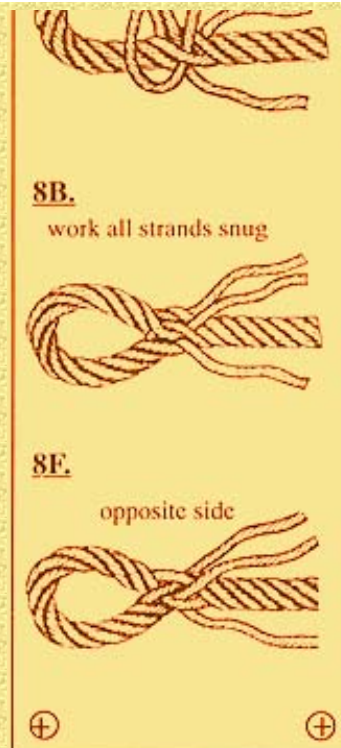

Splicing



ROPE WORKS ©1996

Gerald L. Findley, all rights reserved

Knots

The use of rope in the workplace was common practice until the midpoint of this century. At that time, modern materials handling techniques started to be used and the use of ropes declined. Along with this decline in the use of ropes in the work place there was also a decline in the knowledge of how to use rope safely.

The more common uses of rope by the average person is the securing of a load to a personal vehicle or for recreational purposes. Both of these uses require a knowledge of how to choose and tie safe, secure knots. If this knowledge is not available, the consequences can be devastating, resulting in personal injury or the loss of personal equipment.

For the last 35 years I have been learning and teaching about rope. My experience in teaching about rope has shown me that most people must be shown how to tie a knot in small, sequential steps, and they must be shown many times before they can tie a knot with confidence.

In preparing this book I have attempted to design a set of teaching aids that present each selected knot, splice, or lashing in small, sequential steps. These teaching aids enable the learner to study each step and to duplicate it with a length of practice rope.

The knots, splices and lashings presented in this book were selected because of their use by the Boy Scouts of America and others who are interested in outdoor recreation.

The following knots and hitches are covered in :

ROPE WORKS

- Whipping (3 methods)
- Service
- Grapevine Service
- Ringbolt Hitching
- Seizing
- Seizing With Racking Turns
- Figure Eight
- Figure Eight On A Bight
- Stevedore Knot
- Stopper Knot
- Square Knot
- Water Knot
- Sheet Bend
- Double Sheet Bend
- Sheet Bend (Short End)
- Bowline
- Bowline On A Bight

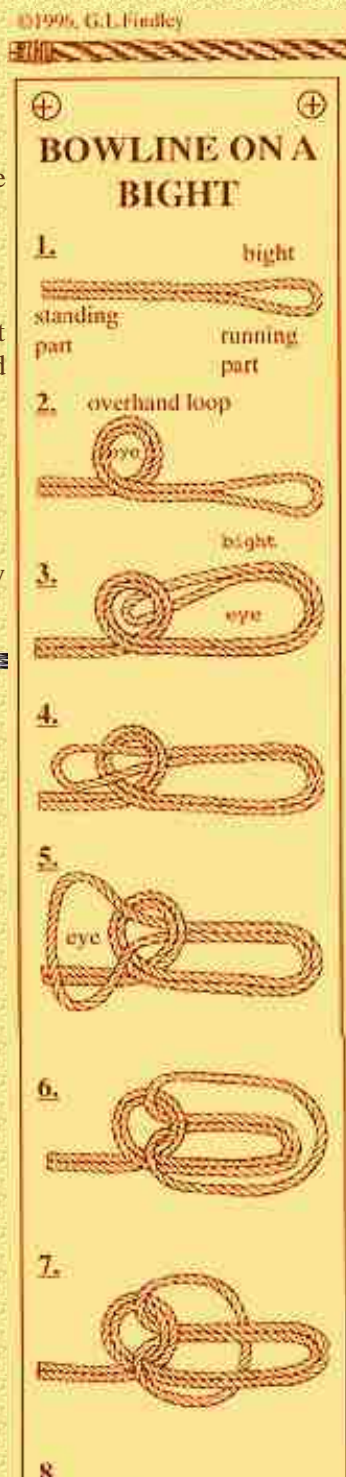

French Bowline
Lineman's Loop
Sheepshank
Trumpet Knot
Sheepshank (Quick)
Clove Hitch
Constrictor Knot
Monkey's Paw
Turk's Head
Two Half Hitches
Taut-line Hitch
Timber Hitch
Mooring Hitch
Marlin Spike Hitch
Marlin Spike Ladder
Anchor Bend
Belaying To A Cleat
Jug Knot

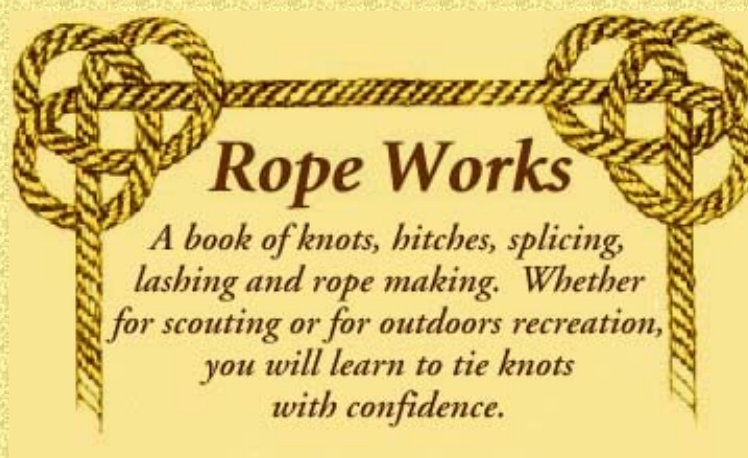
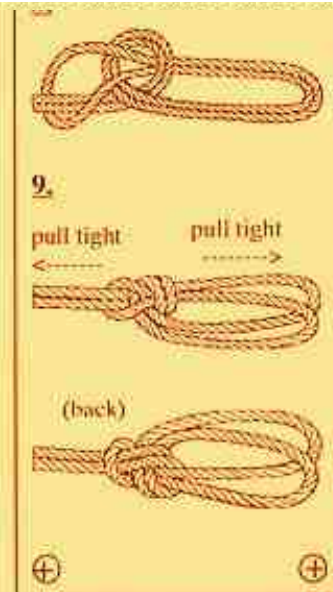

Order a copy of RopeWorks now !



Home
E-Mail





ROPE WORKS ©1996 Gerald L. Findley, all rights reserved

INTRODUCTION

ROPE WORKS is a book that evolved to meet the needs of Scouts and Scouters. ROPE WORKS' 97 pages are bound in a plastic comb binding that allows it to lay flat while in use. Its 6 inch by 8 1/2 inch size makes it convenient to carry as a reference source. ROPE WORKS provides detailed step by step illustrations in a knot board layout. The knot board layout clearly shows each step required to tie a knot. The detailed steps allows the user of ROPE WORKS to learn the art of **knot tying, splicing, and lashing** without the constant supervision of an instructor. The table of contents, glossary of terms and complete index will help you find and tie the knots you need.

Twenty-two pages of ROPE WORKS are devoted to **rope making** and the building of a **geared rope machine**.

View our sample illustrations to see what we are talking about. Then order your copy of Rope Works today by using the handy mail in **order form** found at our Ordering Information button.

KNOT SAFETY

If a knot is improperly tied or a wrong knot is used, an unsafe condition is created. Therefore it is not just enough for the teacher to teach someone how to tie a knot correctly, but it is also necessary to teach them how to use the knot correctly. Likewise it is the student's responsibility to learn how to correctly tie and use the knot. If either the teacher or the student does not accept their responsibility they are endangering themselves and others.

The most commonly used rope is right hand-lay rope; that is as you are looking at the rope, it appears to twist to the right and away from you. Because of the right-hand lay of most rope, the majority of knots hold best when tied in a right hand manner. If the knot is tied in a left-hand manner or the mirror image of its usual form, the knot may fail because the right-hand twist of the rope may cause the knot to loosen or spill more easily. This is especially true if the tension on the rope is repeatedly changed.

Thanks and safe tying.





[←](#) [Home](#) [→](#)
[GUESTBOOK](#)
[E-Mail](#)

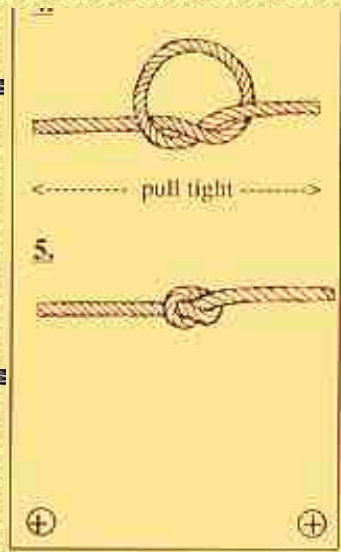



 Sign Up Steps

1. Review Selections Please sign in to bCentral.com

2. Sign In with Microsoft  .NET Passport

3. Contact Information  Register for a new Passport or Sign-in

4. Terms of Service

5. Online Purchase

6. Invoice Confirmation

- **If you dont already have a .NET Passport:**
[Create a new Passport](#) for your bCentral.com account

- **Current bCentral Customers, or if you have an existing Passport** that you want to use with your bCentral.com account:



Note: Only one .NET Passport may be associated with your bCentral account. Once a .NET Passport is associated with a bCentral account, you will be unable to change it. If you are creating a bCentral business account accessible by more than one person at your business, we suggest creating a .NET Passport for your business to use exclusively with bCentral. For more information on Microsoft .NET Passport, please see <http://www.passport.net/>.

[About bCentral](#) | [Customer Service](#) | [Terms of Service](#) | [Advertise](#) | [Privacy Statement](#) | [Help](#)

Copyright © 2004 Microsoft Corporation All Rights Reserved

[Home](#) |

Search for

Manage & Analyze your Web Site Traffic with FastCounter Pro

Online Services

[Online Services](#)

Internet Marketing

[Sales Leads](#)

[Search Engine](#)

[Submissions](#)

[E-mail Marketing](#)

[Business Listings](#)

[Web Site Traffic](#)

[Banner Advertising](#)

Web Sites & Commerce

[Web Hosting](#)

[E-commerce Solutions](#)

[Site Traffic Analysis](#)

[Web Collaboration](#)

[Appointment Scheduling](#)

More Business Tools

[Products Overview](#)

Events & Support

[Events Overview](#)

[Support Overview](#)

[Site Map](#)

Monitor the effectiveness of your Web site in real-time

Make sure your Web site is working for you! FastCounter Pro is our easy to use and affordable traffic analysis service that allows you to monitor your Web site traffic. Use this information to your advantage and improve the design and efficiency of your Web site. FastCounter Pro allows you to:

- Monitor the success of your Web site in real-time
- Measure the ROI of your advertising campaigns
- Track your conversions to see how valuable your traffic is
- Find out which referrer sends you the most sales
- See which keyword phrases are being used in search engines to find your site
- Collect data about the operating systems and browsers of your visitors
- Get online support 24x7

[Check out our live demo of FastCounter Pro!](#)

FastCounter Pro — Monthly Plan — Free 30 Day Trial

US \$19.95/month - Includes up to 50,000 page views/month
(\$.30 per 1,000 page views above 50,000/month)

[More Information](#)

[Contact Microsoft](#)

- ["More Info & Product Details](#)
- ["Start FastCounter Pro Live Demo](#)
- ["FastCounter Pro FAQs](#)
- ["FastCounter Pro How-To Guide](#)
- ["Support For FastCounter Pro](#)
- ["Online Services Privacy Policy](#)
- ["Online Services Terms of Service Policy](#)

Questions about Microsoft products?

Call (877) 637-8159
(9am - 9pm ET Daily)

[Please contact me with more info on how
FastCounter Pro can help meet my needs](#)



[Manage Your Profile](#) | [Free Newsletter](#) | [Contact Us](#)

©2004 Microsoft Corporation. All rights reserved. [Terms of Use](#) | [Trademarks](#) | [Privacy Statement](#)

[Home](#) |

Search for

Manage & Analyze your Web Site Traffic with FastCounter Pro

Online Services

▶ [Online Services](#)

Internet Marketing

▶ [Sales Leads](#)

▶ [Search Engine Submissions](#)

▶ [E-mail Marketing](#)

▶ [Business Listings](#)

▶ [Web Site Traffic](#)

▶ [Banner Advertising](#)

Web Sites & Commerce

▶ [Web Hosting](#)

▶ [E-commerce Solutions](#)

▶ [Site Traffic Analysis](#)

▶ [Web Collaboration](#)

▶ [Appointment Scheduling](#)

More Business Tools

▶ [Products Overview](#)

Events & Support

▶ [Events Overview](#)

▶ [Support Overview](#)

▶ [Site Map](#)



Make sure your Web site is working for you! FastCounter Pro is our easy to use and affordable traffic analysis service that allows you to monitor your Web site traffic. Use this information to your advantage and improve the design and efficiency of your Web site. FastCounter Pro allows you to:

- Monitor the success of your Web site in real-time
- Measure the ROI of your advertising campaigns
- Track your conversions to see how valuable your traffic is
- Find out which referrer sends you the most sales
- See which keyword phrases are being used in search engines to find your site
- Collect data about the operating systems and browsers of your visitors
- Get online support 24x7

[Check out our live demo of FastCounter Pro!](#)

FastCounter Pro — Monthly Plan — Free 30 Day Trial

US \$19.95/month - Includes up to 50,000 page views/month
(\$.30 per 1,000 page views above 50,000/month)

[More Information](#)

[Contact Microsoft](#)

- ["More Info & Product Details](#)
- ["Start FastCounter Pro Live Demo](#)
- ["FastCounter Pro FAQs](#)
- ["FastCounter Pro How-To Guide](#)
- ["Support For FastCounter Pro](#)
- ["Online Services Privacy Policy](#)
- ["Online Services Terms of Service Policy](#)

Questions about Microsoft products?

Call (877) 637-8159
(9am - 9pm ET Daily)

[Please contact me with more info on how
FastCounter Pro can help meet my needs](#)

[Manage Your Profile](#) | [Free Newsletter](#) | [Contact Us](#)

©2004 Microsoft Corporation. All rights reserved. [Terms of Use](#) | [Trademarks](#) | [Privacy Statement](#)