



Survival tip &
Plant of the
month



Nutrition



Classes &
Outings



Books



Pathfinder



Links

John's Resume



Dining
on the
Wilds



Wild Edible Plants.

Dining on the Wilds



"They are pulling the wool over **your** eyes.
The issue is the new ['Adventure Pass'](#) initiated by the United States Forest Service, and the victims are the taxpayers. "
California Assemblyman BRETT GRANLUND



"The government's decision to not prosecute violators seems to confirm that the **fee** demonstration program is essentially a toothless tiger which the public can eradicate." [Tucson Weekly](#)

NEW SHAREWARE [spelling dictionaries](#) in the books section

Dining on the Wilds

Learning Nature through Wild Edible Plants and Ethnobotany

This set of pages will give you . . .

1. [WHY?](#) learn wild edible plants
2. [DESCRIPTION](#) of the video course
3. [Table of contents](#)
4. [WHO](#) made it?
5. [OTHERS](#) say
6. [Cover](#) (25KB)
7. How to [ORDER](#)



Free!

Download
Netscape

SDA
TOP
40

[see for yourself](#)

[privacy](#)

Copyright ©
1996, 2001
[John Goode](#)
JEG
Development



Dining on the Wilds

- Takes you inside the classroom for an interesting graphic slide presentation which gives you a close-up look at the identification of many wild edible plants, herbs and mushrooms of North America.
- Come along on live field trips. Observe and enjoy plants in their natural habitat. Learn how to use these natural, nutritive items.
- Taste the fun of a cooking class where unique recipes are demonstrated. You are in for a truly mouth watering treat.
- Watch the fun as students bring family and friends to a gourmet buffet where everyone brings home made dishes containing at least one wild ingredient.
- Listen to student comments as to why they enrolled in the class and why some have come back repeatedly.

[Others say](#)

I have thoroughly enjoyed Dining on the Wilds. The tapes have been a great help. They are very informative. ...

Sincerely,
Susie Teague
[Cedar Creek Nature Studies](#)

- This video set is a unique, fun and educational experience that your whole family will enjoy viewing over and over again.



[\[Why learn wild edible plants?\]](#) [\[Table of contents \]](#) [\[About the presenters\]](#) [\[Cover 25KB\]](#)



Dining on the Wilds **is brought to you by**



Miriam Darnall-Kramer [18K]

- Author of Wild Plants to Eat correspondence course and 6 other related courses.
- Co-author of Wild Plants to Eat workbook and slide set.
- Associate director of the former International Wilderness Club.
- Extensive classroom and field experience teaching about wild edible plants in 27 states, Canada and Peru.
- Listed in Who's Who in American Women.
- Secretary-treasurer of Forage Ahead.



John Goude[16K]

- Has studied wild edible plants for 28 years in 12 states.
- Has taught wild edible plants in 7 states.
- San Gorgonio Wilderness Assoc. interpretive specialist, (on strike) in wild edible plants. [Hug-A-Tree and Survive teacher](#)
- [Rabbitstick rendezvous](#) of Society for Primitive Technology teacher.
- President of Forage Ahead, a wild edible plant enthusiasts club.
- Has cataloged and cross indexed over 500 North American wild edible plants.
- Served as president of Riverside California Chapter of International Wilderness Club.

[\[Dining on the Wilds top \]](#) [\[Reasons to learn Wild edible plants\]](#) [\[Table of contents\]](#) [\[Cover25KB \]](#)



Tell us what you think:

Required fields = *

Your name: *

Your e-mail address: *

Comments:



This [SurvivalRing](#) site is owned by
[John Goude](#).

Want to join the [SurvivalRing](#)?



[\[Skip Prev\]](#) [\[Prev\]](#) [\[Next\]](#) [\[Skip Next\]](#) [\[Random\]](#) [\[Next 5\]](#) [\[List Sites\]](#) [\[Home\]](#)



(Reset date July 1, 1997)

Copyright © 1996-2001 John Goude
webmaster@edibleplants.com

When E-mailing do not remove the anti spam * from the subject line.

If you would like to use something on this site please E-mail a request to use it. So far almost all requests made before use have been granted. It is nice to know when we have helped someone else get their message out.



Experience nature as God intended. Taste it !
Click here to learn about wild plants you can eat and enjoy.
Dining on the Wilds a six session video course.



Survival Tip

A C O R N S

California black oak
Quercus kelloggii



Warning

Unprocessed acorns usually have toxic quantities of tannin and may shutdown the digestive track. Proper leaching removes the tannin making them a major wild food item.

The most common steps in leaching are

- shelling the nuts
- removing the inner skin
- grinding the nuts
- cold water leaching allows the acorn meal to thicken when cooked

Hot water leaching is faster and more common with "modern" experimenters but does not thicken or act as a binder (like eggs or gluten) when cooked.

California black oak acorns usually are harvested in October to December

A Method of Cold Water Leaching

Shell the acorns in your favorite way. Some suggestions step on them with hard shoes until you hear a pop sound. Drive over them. Use a nut cracker (dried acorns are more brittle). Crack with a hammer or rock. Soak them in water until they split open (about 2 weeks to a month).

Place about a cup of shelled nuts in a 1 quart blender and fill it with water. Jog the blender for 5 to 15 seconds at a time to knock off the skins. Stop the blender and skim the skins from the surface when there are enough to skim. Repeat the jogging and skimming until no more skins float to the surface.

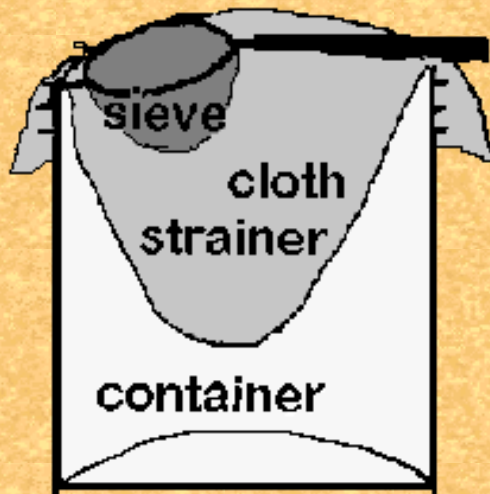

Grind the nuts in the blender to a fine meal. The water will turn milky white. Pour the nuts and water into a large container with a fine cloth strainer (or 5 gal nylon paint strainer) through a sieve. The part staying in the sieve needs to be ground again. The meal that stays in the cloth strainer needs more leaching. The very fine sediment that goes through the cloth thickens when it is cooked. When all the nuts are ground and pass through the sieve, move the cloth strainer and meal to another container of cold water and agitate the meal more fine sediment will cloud the water. After letting it set for about 10 min. remove the meal from the water and pour the water into the first container of murky water. Fill the second container with water again and put the meal into the fresh cold or warm water. The water may need to be change again.

Let the first container of murky water settle for 2 hours to overnight and change the water but keeping the sediment. This water changing may need to be done more than once. When the leaching water is poured off test for tannin by cooking equal amounts of meal and taste for tannin (bitter after taste and/or dry feel to the mouth). Cooking brings out the tannin taste. If there is no tannin taste pour the sediment into the strainer with the rest of the leached meal and let it drain. The acorns are now leached

A c o r n B r o w n i e s

2 cups drained but wet cold water leached acorn flower
 1 cup chopped walnuts
 1 cup fruit juice concentrate or honey
 1/2 cup water with
 1 teaspoon baking soda

mix water and baking soda first then mix with other ingredients. Bake in a greased pan at 350F for 45 min. Cool and serve

White man's wiwish

(wiwish is a Cahuilla name for acorn mush)

1 cup of drained but wet cold water leached acorn flower
 1 cup water (some acorns need more some less)
 1/4 to 1/2 teasp. Salt (to taste)

1/4 cup sweetener honey or fruit juice concentrate (optional)

Mix ingredients together and bring to a boil, or until wewish thickens.

Because some search engines penalize for "over use of words"
"nuts" has been used in place of a c o r n s .



[Order](#) [Home](#) [Books](#)

Copyright © 1996, 1998 John Goude

JEG Development info@edibleplants.com

When E-mailing do not remove the anti spam * from the subject line.



[Survival tip & Plant of the month](#)



[Nutrition](#)



[Classes & Outings](#)



[Books](#)



[Pathfinder](#)



[Links](#)

[John's Resume](#)



[Dining on the Wilds](#)



Wild Edible Plants.

Dining on the Wilds

Three empty rectangular boxes with red borders, stacked vertically.

"They are pulling the wool over **your** eyes. The issue is the new [Adventure Pass](#) initiated by the United States Forest Service, and the victims are the taxpayers. " California Assemblyman BRETT GRANLUND



"The government's decision to not prosecute violators seems to confirm that the **fee** demonstration program is essentially a toothless tiger which the public can eradicate." [Tucson Weekly](#)

NEW SHAREWARE [spelling dictionaries](#) in the books section

Dining on the Wilds

Learning Nature through Wild Edible Plants and Ethnobotany

This set of pages will give you . . .

1. [WHY?](#) learn wild edible plants
2. [DESCRIPTION](#) of the video course
3. [Table of contents](#)
4. [WHO](#) made it?
5. [OTHERS](#) say
6. [Cover](#) (25KB)
7. How to [ORDER](#)



Free!

Download
Netscape

SDA
TOP
40

[see for yourself](#)

[privacy](#)

Copyright ©
1996, 2001
[John Goode](#)
JEG
Development



Dining on the Wilds

- Takes you inside the classroom for an interesting graphic slide presentation which gives you a close-up look at the identification of many wild edible plants, herbs and mushrooms of North America.
- Come along on live field trips. Observe and enjoy plants in their natural habitat. Learn how to use these natural, nutritive items.
- Taste the fun of a cooking class where unique recipes are demonstrated. You are in for a truly mouth watering treat.
- Watch the fun as students bring family and friends to a gourmet buffet where everyone brings home made dishes containing at least one wild ingredient.
- Listen to student comments as to why they enrolled in the class and why some have come back repeatedly.

[Others say](#)

I have thoroughly enjoyed Dining on the Wilds. The tapes have been a great help. They are very informative. ...

Sincerely,
Susie Teague
[Cedar Creek Nature Studies](#)

- This video set is a unique, fun and educational experience that your whole family will enjoy viewing over and over again.



[\[Why learn wild edible plants?\]](#) [\[Table of contents \]](#) [\[About the presenters\]](#) [\[Cover 25KB\]](#)



Dining on the Wilds **is brought to you by**



Miriam Darnall-Kramer [18K]

- Author of Wild Plants to Eat correspondence course and 6 other related courses.
- Co-author of Wild Plants to Eat workbook and slide set.
- Associate director of the former International Wilderness Club.
- Extensive classroom and field experience teaching about wild edible plants in 27 states, Canada and Peru.
- Listed in Who's Who in American Women.
- Secretary-treasurer of Forage Ahead.



John Goude[16K]

- Has studied wild edible plants for 28 years in 12 states.
- Has taught wild edible plants in 7 states.
- San Gorgonio Wilderness Assoc. interpretive specialist, (on strike) in wild edible plants. [Hug-A-Tree and Survive teacher](#)
- [Rabbitstick rendezvous](#) of Society for Primitive Technology teacher.
- President of Forage Ahead, a wild edible plant enthusiasts club.
- Has cataloged and cross indexed over 500 North American wild edible plants.
- Served as president of Riverside California Chapter of International Wilderness Club.

[\[Dining on the Wilds top \]](#) [\[Reasons to learn Wild edible plants\]](#) [\[Table of contents\]](#) [\[Cover25KB \]](#)





Tell us what you think:

Required fields = *

Your name: *

Your e-mail address: *

Comments:

	<p>This SurvivalRing site is owned by John Goude.</p> <p>Want to join the SurvivalRing?</p>	
---	---	---

[\[Skip Prev\]](#)[\[Prev\]](#)[\[Next\]](#)[\[Skip Next\]](#)[\[Random\]](#)[\[Next 5\]](#)[\[List Sites\]](#)[\[Home\]](#)



(Reset date July 1, 1997)

Copyright © 1996-2001 John Goude
webmaster@edibleplants.com

When E-mailing do not remove the anti spam * from the subject line.

If you would like to use something on this site please E-mail a request to use it. So far almost all requests made before use have been granted. It is nice to know when we have helped someone else get their message out.



If you became stranded or lost in the wilderness, would you starve?
Click here to learn about wild plants you can eat and enjoy.
Dining on the Wilds a six session video course.



North by the moon

How would you find north?

The moon is a compass or more accurately a pointer to the north star. So if you can see the moon you should be able to find north. There are two ways to do this.

On a fairly full moon you can see a crescent of shadows. The finger in the crescent points to the north.

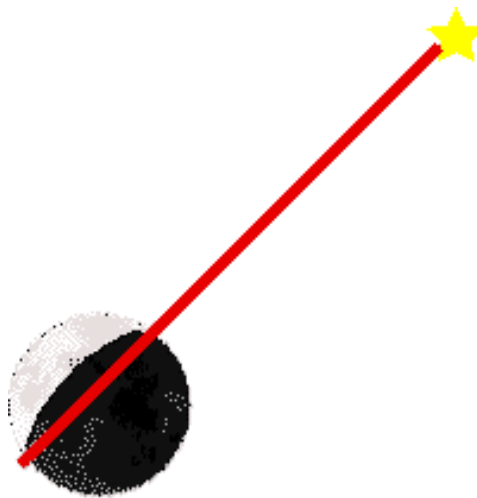

When the moon is at a phase where you can see where the shadow starts you can find north by making an imaginary line from the tips of the shadow to the north star. Or where the north star is. If you notice how far this is at night, you can measure this same distance in the day to find north

The moon rises about 52 minutes later each night. The entire cycle takes about a month (29.5 days).

[Dining on the Wilds home](#) Copyright © 1997 John Goude
JEG Development info@edibleplants.com

When E-mailing do not remove the anti spam * from the subject line.

Wild Edible Plant Nutrition (per 100 grams)

Name	Calories	Protein	Fat	Calcium	Phosphorus	Iron	Sodium	Potassium	Vitamin A	Thiamin	Riboflavin	Niacin	Vitamin C
	(grams)	(mg)	(mg)	(mg)	(mg)	(mg)	(mg)	(mg)	(I.U.)	(mg)	(mg)	(mg)	(mg)

Warning: Some of these plants have toxic parts or are toxic until prepared properly. (Cherry pits contain cyanide.) Before you eat any wild plant make sure of its identity and that it has been prepared properly. Some people may have bad reactions to some plants (allergies etc.). This list has some that I have not seen in any wild edible plant book yet. The cardinal edibility rule is "KNOW BEFORE YOU EAT". However do not be afraid of wild edible plants, because it is a fascinating study, but please be wise and careful.

A * by a plant name means there is not agreement, among people who study wild edible plants, on the edibility of this plant.

Alfalfa <i>medicago sativa</i>	52	6.0	0.4	12	51	5.4	--	--	3,410	0.13	0.14	0.5	162
Amaranth <i>Amaranthus spp</i>	42	3.7	0.8	313	74	5.6	--	411	1,600	0.05	0.24	1.2	65
Arrowhead <i>Sagittaria spp.</i>	107	5.0	0.3	13	165	2.6	--	729	--	1.60	0.40	1.4	5
Asparagus <i>Asparagus officinalis</i>	20	2.2	0.2	21	50	0.6	1	183	900	0.16	0.18	1.4	26
Bamboo <i>Bambusa spp.</i>	27	2.6	0.3	13	59	0.5	--	533	20	0.15	0.07	0.6	4
Beechnut, American <i>Fagus grandifolia</i>	568	19.4	50.0	--	--	--	--	--	--	--	--	--	--
Beggarticks <i>Bidens bipinnata</i>	33	2.8	0.6	111	39	2.3	--	--	--	--	--	--	--
Blackberry <i>Rubus spp.</i>	58	1.2	0.9	32	19	0.9	1	170	200	0.03	0.04	0.4	21
Blueberry <i>Vaccinium spp.</i>	62	0.7	0.5	15	13	1.0	1	81	100	0.03	0.06	0.5	14
Burdock, Great <i>arctium lappa</i>	89	2.5	0.1	50	58	1.2	30	180	--	0.25	0.08	0.03	2
Butternut <i>Juglans cinerea</i>	629	23.7	61.2	--	--	6.8	--	--	--	--	--	--	--

Wild Edible Plant Nutritional Table

Cherry, Sour Red <i>Prunus cerasus</i>	58	1.2	0.3	22	19	0.4	2	191	1,000	0.05	0.06	0.4	10
Cherry, Sweet <i>Prunus avium</i>	48	0.9	0.2	15	13	0.3	1	130	60	0.02	0.02	0.2	3
Chestnut <i>Castanea spp.</i>	194	2.9	1.5	27	88	1.7	6	454	--	0.22	0.22	0.6	--
Chicory <i>Cichorium intybus</i>	20	1.8	0.3	86	40	0.9	--	420	4,000	0.06	0.10	0.5	22
Chives <i>Allium schoenoprasum</i>	27	2.7	0.6	83	41	0.8	--	--	--	0.10	0.06	0.5	32
Chufa, or Yellow Nut Grass <i>Cyperus esculentus</i>	311	4.4	17.2	59	155	2.4	--	--	--	0.90	--	--	--
Crabapple <i>Pyrus spp.</i>	68	0.4	0.3	6	13	0.3	1	110	40	0.03	0.02	0.1	8
Cranberry, Large <i>Vaccinium macrocarpon</i>	46	0.4	0.7	14	10	0.5	2	82	40	0.03	0.02	0.1	11
Dandelion greens raw <i>Taraxacum officinale</i>	45	2.7	0.7	187	66	3.1	76	397	14,000	0.19	0.26	--	35
dandelion greens, cooked <i>Taraxacum officinale</i>	33	2.0	--	140	42	1.8	--	--	11,000	0.13	0.16	--	18
Dayflower <i>Commelina spp.</i>	43	2.3	0.4	210	52	--	--	--	--	--	--	--	--
Day Lily <i>Hemerocallis fulva</i>	42	2.0	0.4	87	176	1.2	24	170	3,000	0.16	0.21	0.8	88
day lily buds, raw*	42	2.0	--	87	176	1.2	--	--	3,000	0.16	0.21	0.08	88
Dock <i>Rumex spp.</i>	28	2.1	0.3	66	41	1.6	5	338	12,900	0.09	0.22	0.5	119
Dock, Curly <i>Rumex crispus</i>	21	1.5	0.3	74	56	5.6	--	--	1,385	0.06	0.08	0.4	30
Duckweed <i>Lemna spp.</i>	18	2.1	0.3	142	4	--	--	--	560	0.06	0.13	0.6	5
Elderberry, Common <i>Sambucus canadensis</i>	72	2.6	0.5	38	28	1.6	--	300	600	0.07	0.06	0.5	36
Fennel <i>Foeniculum vulgare</i>	31	2.9	0.5	114	54	2.9	--	338	1,566	0.12	0.15	0.7	34
Filaree <i>Erodium cicutarium</i>	--	2.5	--	--	--	--	--	--	7,000	--	--	--	--

Wild Edible Plant Nutritional Table

Filbert, or Hazelnut <i>Corylus americana</i>	634	12.6	62.4	209	337	3.4	2	704	--	0.46	--	0.9	--
Galinsoga, or Quick Weed <i>Galinsoga parviflora</i>	42	3.2	0.5	245	45	7.1	--	--	1,120	0.11	0.27	2.1	30
Garlic <i>Allium spp.</i>	137	6.2	0.2	29	202	1.5	19	529	trace	0.25	0.08	0.5	15
Grape, Concord <i>Vitis spp.</i>	69	1.3	1.0	16	12	0.4	3	158	100	0.05	0.03	0.3	4
Ground Cherry, or Husk Tomato <i>Physalis spp.</i>	40	1.6	0.5	10	34	0.9	--	--	25	0.90	0.04	2.4	6
Hickory (nuts) <i>Carya spp.</i>	673	13.2	68.7	trace	360	2.4	--	--	--	--	--	--	--
Honewort, or Wild Chervil <i>Cryptotaenia spp.</i>	18	2.0	0.1	81	45	1.8	7	490	488	0.15	0.20	0.5	60
Horsetail, Common * <i>Equisetum arvense</i>	20	1.0	0.2	58	93	4.4	--	--	180	--	0.07	5.6	50
Jerusalem Artichoke (raw) <i>Helianthus tuberosus</i>	77	2.3	0.1	14	78	3.4	--	--	20	0.20	0.06	1.3	4
Knotweed <i>Polygonum spp.</i>	64	3.6	0.3	150	48	--	--	--	--	--	--	--	--
Kudzu (roots) <i>Pueraria lobata</i>	113	2.1	0.1	15	18	0.6	--	--	--	--	--	--	--
Lamb's-Quarters (raw) <i>Chenopodium album</i>	43	4.2	0.8	309	72	1.2	--	--	11,600	0.16	0.44	1.2	80
lamb's quarters, cooked	32	3.2	--	258	45	0.7	--	--	9,700	0.10	0.26	0.9	37
Leek, or Ramp (bulbs) <i>Allium spp.</i>	52	2.2	0.3	52	50	1.1	5	347	40	0.11	0.06	0.5	17
Mallow <i>Malva spp.</i>	37	4.4	0.6	249	69	12.7	--	--	2,190	0.13	0.20	1.0	35
Mallow, High <i>Malva sylvestris</i>	28	3.6	1.4	90	42	3.7	--	--	1,989	0.17	0.29	0.5	24
Maple (sugar) <i>Acer saccharum</i>	348	--	--	143	11	1.4	14	242	--	--	--	--	--

Wild Edible Plant Nutritional Table

Mexican Tea * <i>Chenopodium ambrosioides</i>	42	3.8	0.7	304	52	5.2	--	--	1,210	0.06	0.28	0.6	11
Milkweed * <i>Asclepias syriaca</i>	--	0.8	0.5	--	--	--	--	--	--	--	--	--	--
Mint <i>Mentha spp.</i>	32	3.0	0.7	194	48	3.8	2	179	1,296	0.13	0.16	0.7	64
mint <i>Mentha sp.</i> , raw	32	3.0	--	194	48	3.8	--	--	1,296	0.13	0.16	0.7	64
Mugwort, Common * <i>Artemisia vulgaris</i>	35	5.2	0.8	82	40	1.5	--	--	1,284	0.15	0.16	3.0	72
Mulberry, White <i>Morus alba</i>	53	1.7	0.4	30	32	3.7	37	152	--	0.03	0.06	0.7	5
Mustard (greens) <i>Brassica spp.</i>	23	2.2	0.4	138	32	1.8	18	220	5,800	0.80	0.14	0.6	48
mustard greens <i>Brassica sp.</i> , raw	23	2.2	--	138	32	1.8	--	--	5,800	0.80	0.14	0.6	48
bird's rape <i>Brassica rapa</i>	32	3.6	--	252	62	3.0	--	--	1,355	0.12	0.29	1.1	118
Nettle, Stinging <i>Urtica dioica</i>	65	5.5	0.7	--	--	--	--	--	6,500	--	--	--	76
stinging nettles, raw*	65	5.5	--	--	--	--	--	--	6,500	--	--	--	--
NEW ZEALAND SPINACH (leaf) <i>Tetragonia tetragonioides</i>	19	2.2	3	54	46	1.6	159	795	4300	0.04	0.17	0.6	30
Oak (acorns) <i>Quercus spp.</i>	48	0.2	0.1	12	314	0.2	--	--	6	0.02	0.40	0.5	0
(dried acorns) <i>Q. lobata.</i>	--	4.9	5.5	--	--	--	--	--	--	--	--	--	--
(dried acorns) <i>Q. garryana.</i>	--	3.9	4.5	--	--	--	--	--	--	--	--	--	--
(dried acorns) <i>Q. douglasii.</i>	--	5.5	8.1	--	--	--	--	--	--	--	--	--	--
(dried acorns) <i>Q. chrysolepis.</i>	--	4.1	8.7	--	--	--	--	--	--	--	--	--	--
(dried acorns) <i>Q. agrifolia.</i>	--	6.3	16.8	--	--	--	--	--	--	--	--	--	--
Calif black oak (dried acorns) <i>Q. kelloggii.</i>	--	4.6	18.0	--	--	--	--	--	--	--	--	--	--

Wild Edible Plant Nutritional Table

Pawpaw <i>Asimina triloba</i>	85	5.2	0.9	--	--	--	--	--	--	--	--	--	--
Pecan <i>Carya illinoensis</i>	610	11.0	84.0	86	341	0.8	--	712	150	1.00	0.15	1.1	2
Peppergrass <i>Lepidium spp.</i>	32	2.6	0.7	81	76	1.3	14	606	9,300	0.08	0.26	1.0	69
garden cress <i>Lepidium sp.</i> , raw	32	2.6	--	81	76	1.3	--	--	9,300	0.08	0.26	1.0	69
garden cress, cooked, short time	23	1.9	--	61	48	0.8	--	--	7,700	0.06	0.16	0.8	34
garden cress, cooked, long time	22	1.8	--	58	44	0.7	--	--	7,000	0.04	0.15	0.7	23
Persimmon <i>Diospyros virginiana</i>	127	0.8	0.4	27	26	2.5	1	310	--	--	--	--	66
Poke (Cooked Shoots) <i>Phytolacca americana</i>	20	2.3	4	53	33	1.2	--	--	8,700	0.07	0.25	1.1	82
Prickly Pear <i>Opuntia humifusa</i>	42	0.5	0.1	20	28	0.3	2	166	60	0.10	0.30	0.4	22
Primrose-Willow <i>Jussiaea spp.</i>	41	3.3	0.4	57	300	12.7	--	--	3,555	0.00	0.01	2.8	3
Purslane (raw Stems and leaves) <i>Portulaca oleracea</i>	21	1.7	0.4	103	39	3.5	--	--	2,500	0.03	0.10	0.5	25
purslane, stems & leaves, cooked	15	1.2	--	86	24	1.2	--	--	2,100	0.02	0.06	0.4	12
Rape, or Field Mustard <i>Brassica rapa</i>	32	3.6	0.6	252	62	3.0	--	--	1,355	0.12	0.29	1.1	118
Raspberry, Black <i>Rubus occidentalis</i>	57	1.2	0.5	22	22	0.9	1	168	130	0.03	0.09	0.9	25
Raspberry, Red <i>Rubus idaeus</i>	73	1.5	1.4	30	22	0.9	1	199	--	0.03	0.09	0.9	18
Rice, Wild <i>Zizania aquatica</i>	353	14.1	0.7	19	339	4.2	7	220	--	0.45	0.63	6.2	0
Sheep Sorrel <i>Rumex acetosella</i>	77	1.9	--	55	82	5.0	--	--	--	--	--	--	--
Shephtrd's Purse raw <i>Capsella bursa-pastoris</i>	33	4.2	0.5	208	86	4.8	--	394	1,554	0.25	0.17	0.4	36

Sow Thistle, Common <i>Sonchus asper</i>	20	2.4	0.3	93	35	3.1	--	--	2,185	0.70	0.12	0.4	5
Soybean <i>Glycine max</i>	400	35.1	17.7	226	546	8.5	--	1,504	6	0.66	0.22	2.2	0
Strawberry, Wild <i>Fragaria spp.</i>	37	0.7	0.5	21	21	1.0	1	164	60	0.03	0.07	0.6	59
Sunflower (seed) <i>Helianthus annuus</i>	560	24.0	47.3	120	837	7.1	30	920	50	2.00	0.23	5.4	--
Vegetable Oyster, Salsify <i>Tragopogon porrifolius</i>	89	1.4	0.2	48	50	1.4	--	--	--	0.04	0.04	0.3	10
Violet (leaves raw) <i>Viola spp.</i>	--	--	--	--	--	--	--	--	8,200	-	-	-	210
Walnut, Black <i>Juglans nigra</i>	628	20.5	59.3	trace	570	6.0	3	460	300	0.22	0.11	0.7	--
Watercress (raw) <i>Nasturtium officinale</i>	19	2.2	0.3	151	54	1.7	52	282	4,900	0.08	0.16	0.9	79
Water Hyacinth <i>Eichhornia crassipes</i>	30	0.5	0.1	--	--	--	--	--	--	--	--	--	--
Water Primrose <i>Jussiaea repens</i>	43	2.5	1.0	144	65	8.0	--	--	1,725	0.04	0.12	0.8	87
Water Shield <i>Brasenia schreberi</i>	10	0.7	0.2	9	23	2.0	--	--	6	0.03	0.03	0.3	0
Wood Sorrel <i>Oxalis spp.</i>	--	0.9	--	--	--	--	--	--	2,800	---	--	--	--
Yucca (flowers) <i>Yucca aloifolia</i>	33	3.1	0.2	47	73	0.5	--	--	10	0.14	0.09	0.6	--

Most of the data for this table comes from "Mother Earth News 7-8/86" and "Temalpakh".

Fc 38864
LE FastCounter



ORDER



BOOKS

[Order](#) [Home](#) [Books](#)

Copyright © 1996, 2001 [John Goude](#)

JEG Development

When E-mailing do not remove the anti spam * from the subject line.

- [Wilderness Survival class March - April 2004](#)
- [Wild edible plant classes April. - May. 2004](#)
- [Maps](#)
- [Agave festival April](#) is sponsored by some friends of mine.
- [E-mail](#) for custom survival and edible plant classes.(When E-mailing do not remove the anti spam * from the subject line.)

I have done special classes and lectures for

schools, homeschool groups, church outings, search and rescue, sheriff's posse, garden clubs, Pathfinder and scout groups, summer camps, outdoor schools, etc.

Wild Edible Plants Class

Class Content:

- Over 200 California Wild Edible Plants
- Identification
- Edible Parts
- Habitat
- Season
- Nutritive value
- Food preparation in field and kitchen

(In addition: edibility rules, basics for eating wild plants safely, primitive cookery, mushrooms, poisonous plants, herbal usage of the wild edibles, and much more.)

Class includes:

- Lectures
- Demonstrations
- "Wild" banquet
- Slides
- Food Sampling
- Certificate of Achievement
- Displays
- two Field trips
- Wild food cookery demonstrations



Instructors:

Miriam Kramer

is author of Wild Plants to Eat correspondence course, co-author of Wild Plants to Eat Workbook and slide set, and is featured on the six-hour "Dining on the Wilds" video set. She was associate director of the former International Wilderness Club, and has extensive classroom and field experience teaching about edible wild plants in 30 states, Canada, and Peru. She was listed in Who's Who in American Women and similar publications.

John Goude

has studied edible wild plants for 35 years in 16 states, has taught wild edible plants in four states, is a U. S. Forest Service volunteer interpretive specialist, has taught at Rabbitstick rendezvous of Society of Primitive

Technology, President of Forage Ahead, a wild edible plant enthusiasts club, has cataloged and cross indexed over 500 North American wild edible plants, was president of Riverside California Chapter of International Wilderness Club, produced the six-hour "Dining on the Wilds" video set.

The following assistants and guest speakers add the fine touches to the Loma Linda class to make it an exciting learning experience **Doug Vonkrieglstein, Evie Roach, and Duke Petersen** and others. .

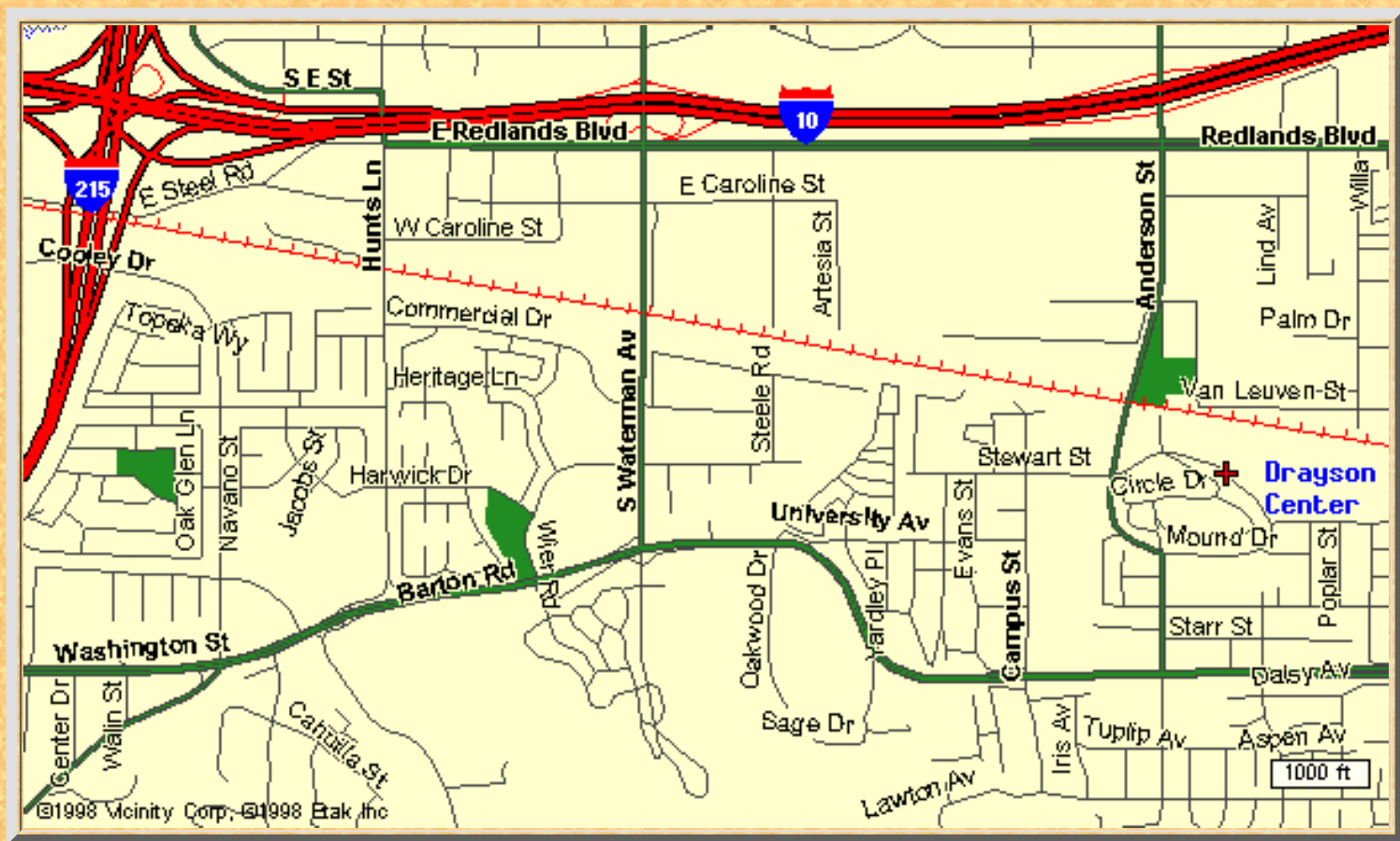

Click on the map to browse

LOMA LINDA CLASS INFORMATION, CALL: [E-mail](#)

When E-mailing do not remove the anti spam * from the subject line.

Date and Time: April 12 - May 17 (2 Sunday field trips) Monday, 6:30 to 8:30 PM.

Place: Loma Linda University Drayson Center, 25040 Stewart Street

Cost: \$89 (includes textbook, handouts. food samples, etc.)

DIRECTIONS: Drayson Center is on Stewart St. about 2 blocks east of Anderson, (south of I-10) in Loma Linda

Wilderness Survival Class

Date: March 1 - April 5, 2004

Time: Monday evenings, 6:30 to 8:30 + (plus 2 Sunday field trips)

Place: Loma Linda University Drayson Center

Cost: \$65 includes materials

Class Content:

- Survival concepts
- Navigation
- Fire building
- Planing
- Signaling
- Water purification
- Leadership skills
- Weather
- Primitive skills
- Shelter building
- and more

Instructor:

John Goude has been a Pathfinder leader for more than 30 years. He has taught wilderness survival at Camp Cedar Falls, Rabbitstick, Winter Count Renezvous and SAR City (a major desert search and rescue training program). He is a certified Hug-a-Tree and Survive teacher. Most of all he has lived through real survival situations and brought those with him back safely.



[HomeBooks](#)

Copyright © 1996, 2004 John Goude

JEG Development info@edibleplants.com

When E-mailing do not remove the anti spam * from the subject line.

Pictures from the Second Annual Agave Harvest

Digging the
agave with a
mountain
mahogany
digging
stick.



Digging sticks were also made from

- Ironwood
- Toyon
- Oak



After digging the leaves are removed.

The leaves are also used in the roasting pit to keep dirt out of the food.

This years dates are
April 29, 2000 10:00 am Dig
May 5, 2000 Start pit backing
May 6, 2000 noon Eating

For more information and fees contact:
Malki Museum
11-795 Fields Road
Banning, CA 92220
909-849-7289

[Agave Digging event](#)
[Malki Museum](#)



[HomeBooks](#)

Copyright © 1999, 2001 John Goude
JEG Development webmaster@edibleplants.com
When E-mailing do not remove the anti spam * from the subject line.

Dining on the Wilds Wild Edible Plant Books etc.



[Edible and Poisonous Plants of the Western States](#) (flash cards)



[Edible and Poisonous Plants of the Eastern States](#) (flash cards)



[Nature Bound Pocket Field Guide](#)



[Wild Plant Cookbook](#)



[A Taste of Nature](#)



[Common Edible and Useful Plants of the West](#)



[Edible and Useful Plants of California](#)



[A Field Guide to Edible Wild Plants of Eastern and Central North America](#)
Peterson Field Guide 23



[Wild Edible Plants of Western North America](#)



[Oaks of North America](#)



[Sea Vegetables: Harvesting Guide & Cookbook](#)



[Temalpakh: Cahuilla Indian knowledge and usage of plants](#)



[Berry Picker](#)

Computer Spelling Dictionaries (shareware)
[North American Plants Bible](#)



Edible and Poisonous Plants of the Western States

Edible and Poisonous Plants

Of The Western States

This deck of plant identification cards by Calvin P. Burt and Frank G. Heyl Lake includes the more important edible(45) and poisonous(9) plants of the Western States. Full-color pictures combined with detailed descriptions enable the collector to identify these plants in their native habitats. \$7.95

ORDER



BOOKS

[Order](#) [Home](#) [Books](#)



Edible and Poisonous Plants of the Eastern States

Edible and Poisonous Plants of the Eastern States

This deck of plant identification cards by Calvin P. Burt and Frank G. Heyl Lake includes the more important edible(44) and poisonous(8) plants of the Eastern States. Full-color pictures combined with detailed descriptions enable the collector to identify these plants in their native habitats.

\$7.95

ORDER



BOOKS

[Order](#) [Home](#) [Books](#)

Copyright © 1998 [John Goude](#)

JEG Development

When E-mailing do not remove the anti spam * from the subject line.

Nature Bound Pocket Field Guide

by Ron Dawson

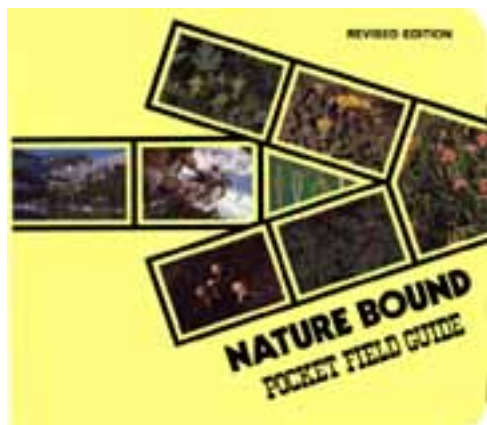

This is a large pocket size book (335 pages) on wilderness skills, survival and first aid (80 pages) with most of the book about wild edible plants(176 pages) and poisonous plants(76 pages). Each plant has a full page (4.5" X 5") description of the plant and uses etc. and a full page color photograph of the plant.

This book covers 80 edible and 34 poisonous plants. There are general preparation directions but no recipes.

ISBN 0-8163-1072-6

\$13.95



[Order](#) [Home Books](#)

Copyright © 1998 [John Goude](#)

JEG Development

When E-mailing do not remove the anti spam * from the subject line.

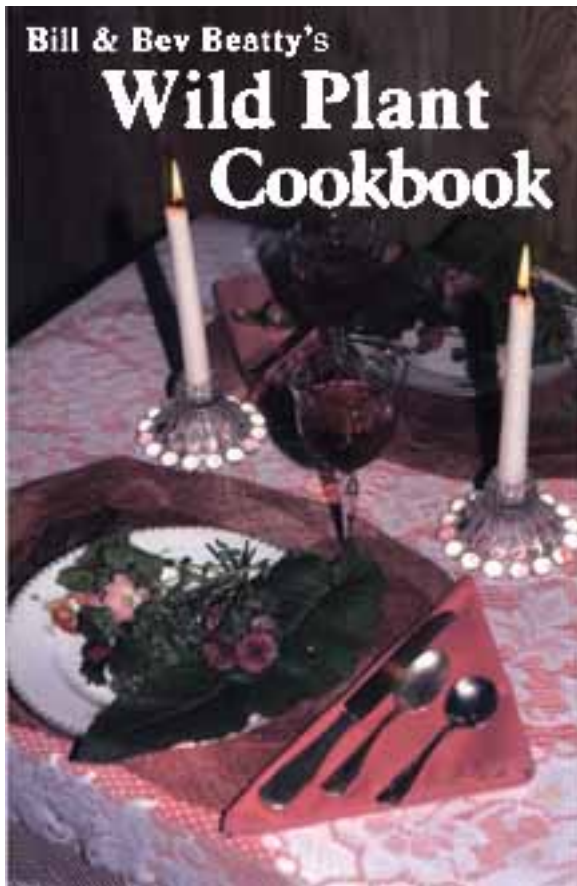

Wild Plant Cookbook

Bill and Bev Beatty shared this work with Bill doing most of the writing and Bev the illustrations. It is a very attractive book, written with philosophical insight and combining nutrition, economy, good tasting recipes, and fun. This book is a perfect resource for those interested in good health and food self-sufficiency, who want to know the vitamins and minerals our bodies need and which wild plants contain them. 174 pages
87961-159-6
\$8.95



[Order](#) [Home Books](#)

Copyright © 1998 [John Goude](#)

JEG Development

When E-mailing do not remove the anti spam * from the subject line.

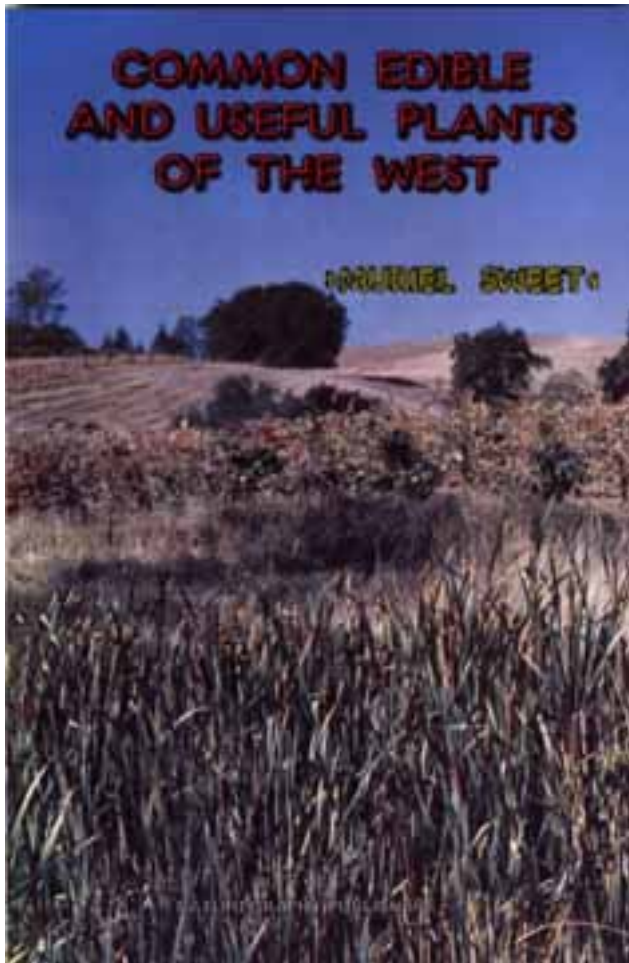

Common Edible and Useful Plants of the West

by Muriel Sweet

Covers more than 100 plants in 64 pages. Each plant has a good line drawing. There are no recipes.

Some plants in this book are not covered in other books that I have found to be edible. Many books do not fully cover the often edible cambium layer of plants.

ISBN 0-87961-046-8

firsts \$5.95

seconds \$4.95



[Order](#) [Home Books](#)

Copyright © 1998 [John Goude](#)

JEG Development

When E-mailing do not remove the anti spam * from the subject line.

Edible and Useful Plants of California

by Charltte Bringle Clarke

This book is a very good identification book that covers more than 220 plants in 280 pages. It has very good line drawings for most plants, with a section of color plates of 48 plants. There are many recipes.

ISBN 0-520-03267-5

\$14.95

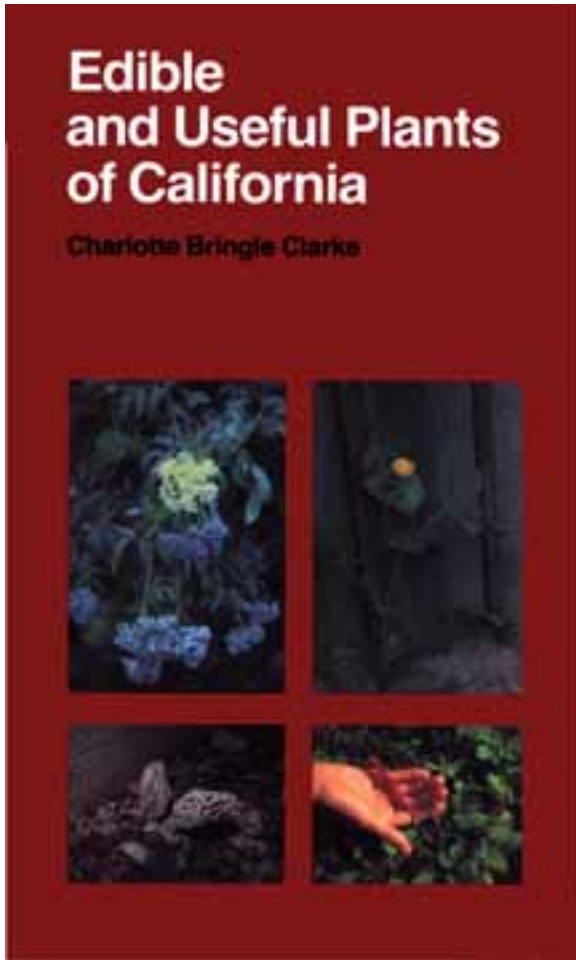

ORDER



BOOKS

[Order](#) [Home](#) [Books](#)

Copyright © 1998 [John Goude](#)

JEG Development

When E-mailing do not remove the anti spam * from the subject line.

A Field Guide to Edible Wild Plants of Eastern and Central North America

Peterson Field Guide 23
by Lee Allen Peterson

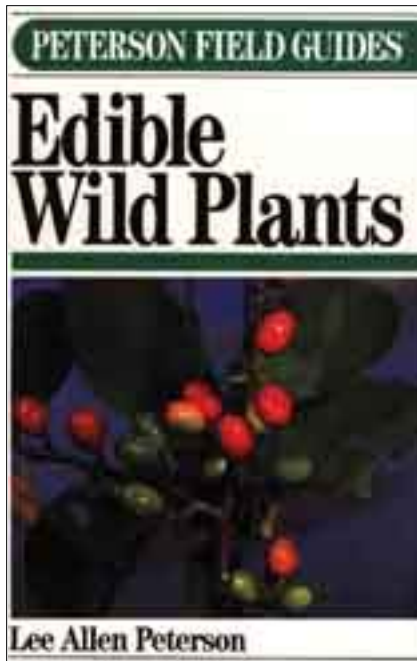

Descriptions and illustrations of more than 370 edible wild plants found in eastern and central North America, plus 37 poisonous look-alikes

Over 400 drawings and 78 color photographs show precisely how to recognize each species

14 habitats are described in full detail, with plants in each habitat listed by season for easy collecting

Preparation directions for 22 different food uses, including cereals, jams and jellies, teas, and many others

In my opinion this is the best for the east. It is the book I used extensively when I lived in Michigan and Ohio, and studied plants in surrounding states. This book has use symbols in the margin that indicate the use of the plant.

ISBN 0-395-31870-X
\$18.00



[Order](#) [Home Books](#)

Copyright © 1998 [John Goude](#)

JEG Development

When E-mailing do not remove the anti spam * from the subject line.

Wild Edible Plants of Western North America



A husband and wife team with Donald Kirk author and Janice Kirk illustrator. Nearly 2000 species of wild edible plants found in the western United States and in southwestern Canada and northwestern Mexico are covered in 343 pages. Various methods of preparing wild foods and careful warnings to avoid poisonous plants are given.

This book is the most complete book for western North America (west of the rockies). Its weakness is that the line drawings sometimes try to cover more than one species in one drawing thus making it hard to identify the plant with certainty. There are no recipes. Overall this is the best for the west.

ISBN 87961-036-0,
Firsts \$8.95
Seconds \$7.95



[Order](#) [Home Books](#)

Copyright © 1998 [John Goude](#)

JEG Development

When E-mailing do not remove the anti spam * from the subject line.

Oaks of North America

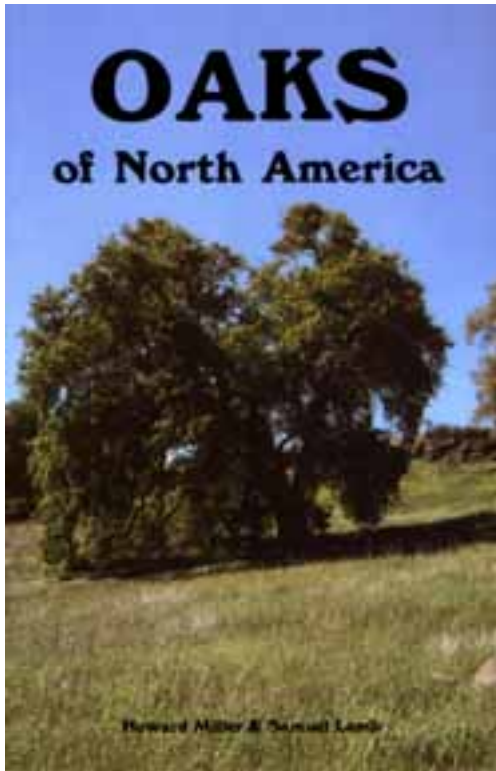

Howard Miller and Samuel Lamb had forestry careers, but were partial to the oaks. Their book has three major parts: history and uses of oaks, oaks of the East, and oaks of the West. Very helpful in identification are the keys for each section of oaks. The authors often trekked hither and yon in search of each species to photograph the oak and its leaf, acorn, and bark. Accompanying each is an informative chapter of description, details of identification, growth habitat, and excellent range maps. They mention ways each species is useful and unique from the other oaks. 328 pages.

ISBN 87961-137-5
\$12.95.



[Order](#) [Home Books](#)

Copyright © 1998 [John Goude](#)

JEG Development

When E-mailing do not remove the anti spam * from the subject line.

Sea Vegetables:

Harvesting Guide & Cookbook.

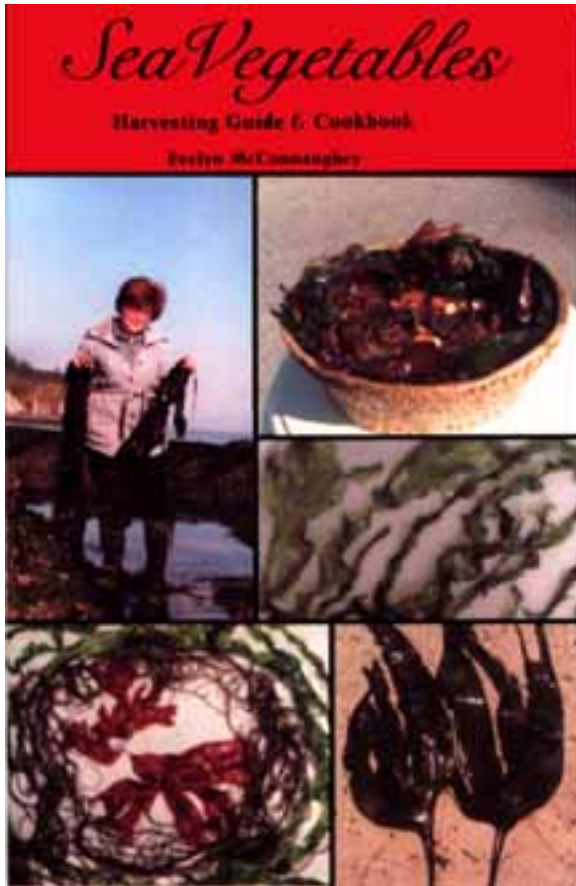

Evelyn McConnaughey is author of this complete guide to foraging and preparing highly nutritious sea vegetables. Classification, where they grow, harvesting, storage, tables of nutritional equivalents, protein comparisons, and numerous recipes are given in her book. Next time you have an outing to the coast, save some money on your food bill and try nature's bounty. 244 pages.

ISBN 87961-151-0
\$9.95.



[Order](#) [Home](#) [Books](#)

Copyright © 1998 [John Goude](#)

JEG Development

When E-mailing do not remove the anti spam * from the subject line.

Temalpakh

Cahuilla Indian knowledge and usage of plants

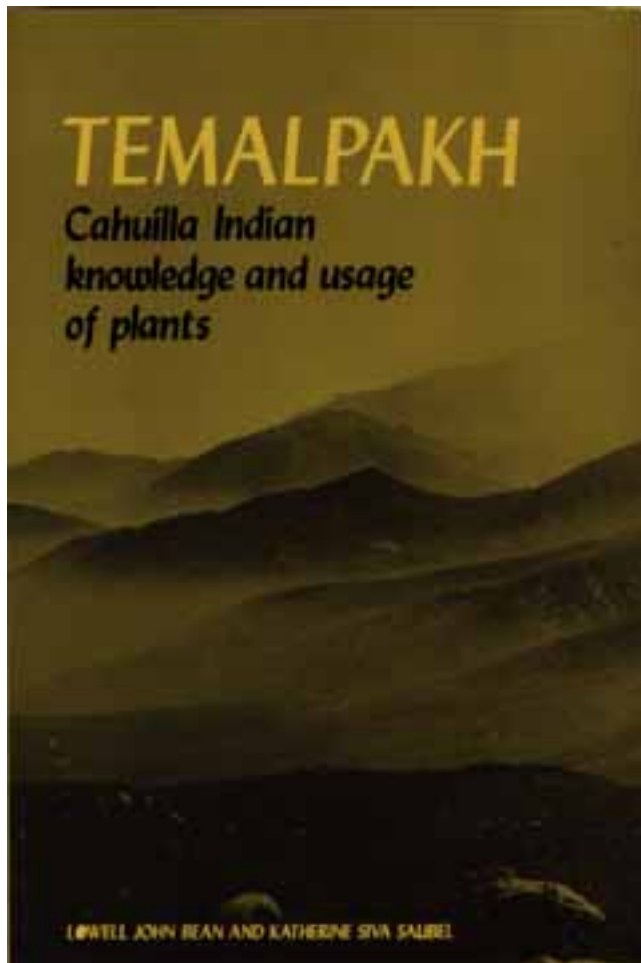

Temalpakh means "from the earth". This book is an excellent resource for how the Cahuilla Indian tribe of southern California used plants. The range is from San Bernardino Mountains south and from inland areas to the Salton Sea. It covers uses of more than 250 plants in 225 pages. It is not intended to be an identification book.

\$15.95

ORDER



BOOKS

[Order](#) [Home Books](#)

Copyright © 1998 [John Goude](#)

JEG Development

When E-mailing do not remove the anti spam * from the subject line.

Berry Picker

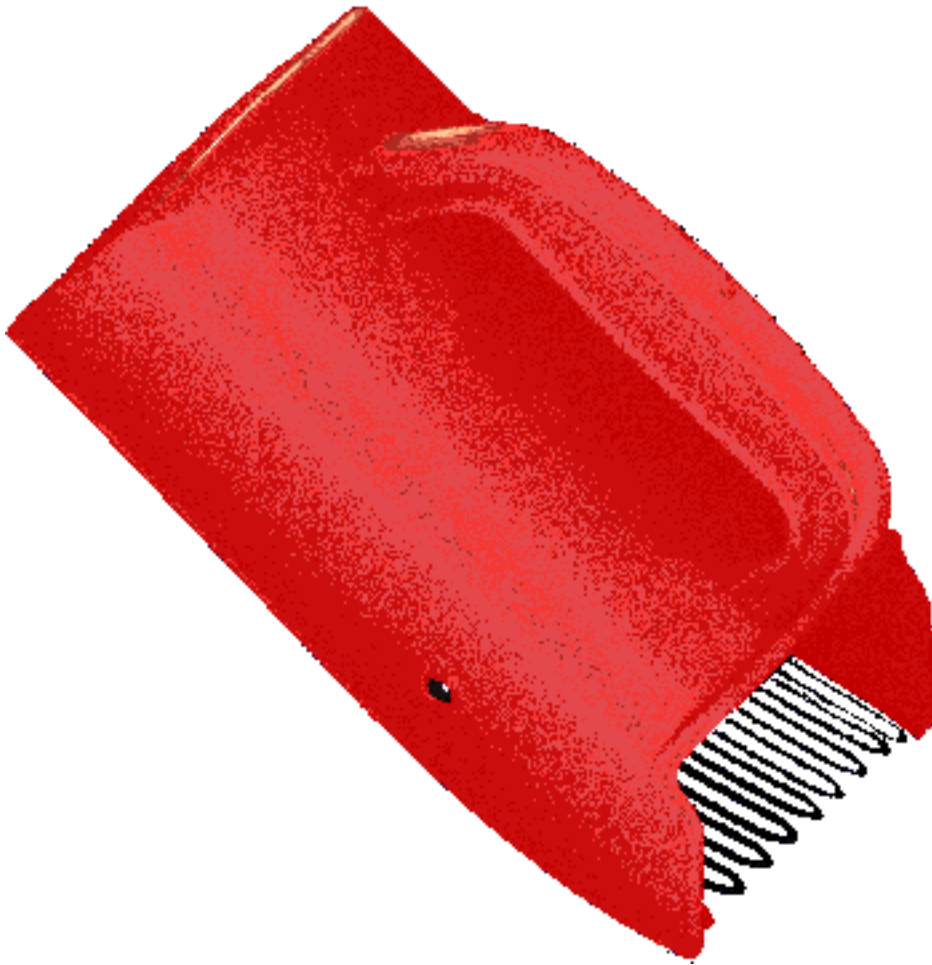

In the old days of Scandinavia the bear was a very respected animal and was closely watched. The people noticed how the bear picked berries and made a device like a bears paw to gather their berries too. Over the years the materials have changed but the principle remains unchanged.

This berry picker can pick some kinds of berries 2 to 10 times as fast as normal hand picking. I have found it to be good for blue berries, rose hips, choke cherries, hawthorn berries, kinnikinnick

Was \$29.95
\$14.95 NOW HERE.

ORDER wild edible plant and survival books



[Order](#) [HomeBooks](#)

A promotional banner for the book 'Dining on the Wilds' by John Goude. On the left is a small image of the book cover, which features a person in a field. To the right of the cover, the title 'Dining on the Wilds' is written in a stylized, red, serif font. Below the title, the word 'BOOKS' is written in a large, bold, black, sans-serif font. To the left of the book cover, the text 'ORDER wild edible plant and survival books' is written in red. Below the book cover, the text 'Order HomeBooks' is written in blue, with 'Order' and 'HomeBooks' underlined.

Copyright © 1998 , 2001 [John Goude](#)

JEG Development

When E-mailing do not remove the anti spam * from the subject line.

Botanical name spelling dictionary

The plants of North America are numerous and have unusual spellings by the common English vocabulary standards. Often one only reads the name making it harder to remember how it is spelled. Being a creative speller anyway I decided to make this list of plant names so that my spelling checker will stop bugging me about them.

This list is only for North America. It was not intended to have plant names from other places. However it would have parts of names from other places

To use this list your spelling checker will need to:

- Be able to have 4 custom dictionaries open at a time.
- Custom dictionary size of up to 107 kb In this case about 10,000 words
- Accept word lists in its custom dictionary

The following files are made from this zip file.

readme.txt	installation instructions, etc.	2 kb
famssp.dic	family, sub species names, etc.	44 kb
genera.dic	genera names	69 kb
speic1.dic	species names a-l	107 kb
speic2.dic	species names m-z	97 kb

[E-mail for a trial](#) the zip file 103 kb (\$5 if you keep it)

Please indicate if you can not have attached files in your return e-mail. If you do not have unZIP software let me know.



[Home](#)

Copyright © 1999 [John Goude](#)
JEG Development

When E-mailing do not remove the anti spam * from the subject line.

Bible spelling dictionary

The Bible has many words not found in most computer spelling dictionaries. Being a creative speller anyway I decided to make this list of Biblical words so that my spelling checker will stop bugging me about them.

This list is mainly for KJV, NKJV, NIV, ASV versions. It includes many of the common book abbreviations too.

To use this list your spelling checker will need to:

- Be able to have at least one custom dictionary open.
- Custom dictionary size of up to 57 kb In this case over 6,000 words
- Accept word lists in its custom dictionary

The following files are made from this zip file.

readme.txt	installation instructions, etc.	2 kb
bible.dic	List of Bible words	57 kb

[E-mail for a trial](#) the zip file 21 kb (\$5 if you keep it)

Please add "NO ATTACH" to the subject line if you can not have attached files in your return e-mail.

Please add "NO ZIP" to the subject line if you can not unzip files.

The auto responder will e-mail the file back to you immediately if you can have attached files and zipped files.

John Goude's Pathfinder stuff



[\[Honor patches\]](#)



[\[Experimental Internet honor\]](#)



[\[Improved Edible Wild Plant honor\]](#)

[My pathfinder friends](#)



[Home](#)



Notice: This page is NOT official. The honors presented here are only recommendations from someone who has been a staff member in Pathfinders for more than 20 years. If you like the innovations you see please refer this sight to other leaders. If you have any suggestions or comments please E-mail me.



[This Pathfinders International Ring Site](#)

is owned by [John Goude](#).

Click for the

[\[Previous\]](#) [\[Random\]](#) [\[Next Site\]](#) [\[Skip Next\]](#) [\[Next 5\]](#)

Want to join the ring? Click here for [info](#).



	This Sabbatarian Webring site is owned by Dining on the Wilds .	
Sabbatarian Ring	[Skip Prev] [Prev] [Next] [Skip Next] [Random] [Next 5] [List Sites]	Next Site
	Want to join the Sabbatarian Webring ?	

Copyright © 1998 John Goude



Pathfinder honor emblems





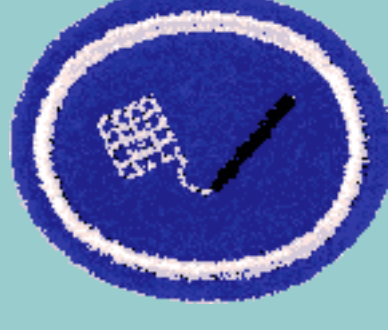
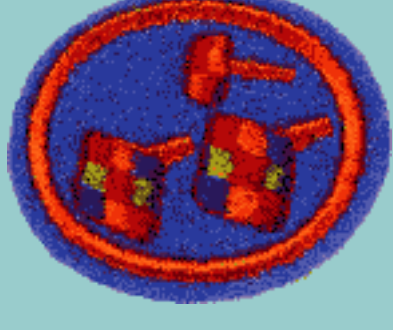











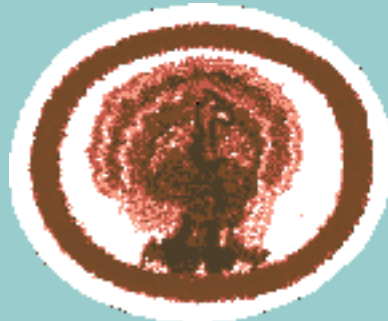

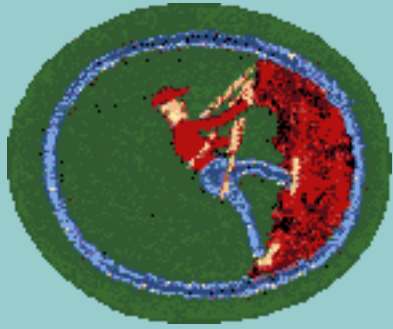

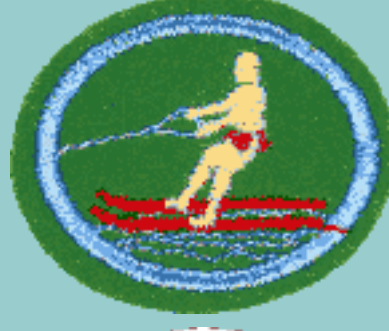

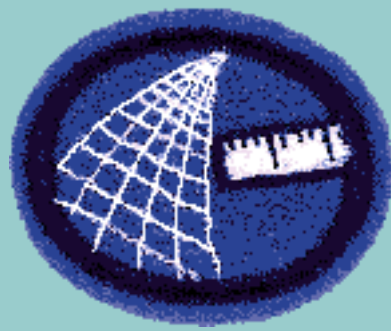



Copyright © 1997, 2000 John Goude

These took many hours to scan and edit. Please get permission before using these graphics on the internet. My usual conditions are a scanning credit and a link to my home page. You have my permission to use these for printing and displaying such as in Pathfinder fair booths.

info@edibleplants.com

When E-mailing do not remove the anti spam * from the subject line.

(proposed) Internet Pathfinder honor



1. Define the following terms in the context of the Internet: URL, TCP/IP, HTML, homepage, site, hit (on a page), E-mail, browser, search engine, directory, bookmark, surfing, animation, GIF, JPEG, background ,Internet Phones, FTP, HTTP, Newsgroups, gopher?.
2. Write a page, without the aid of a HTML editor, using these commands properly
<HTML>
<HEAD>
<TITLE>
<BODY>

<A HREF...>
3. What are frames, tables, and lists. Explain the differences between them. What are META statements used for? There are many text formatting commands. Describe how to use some of them. (H1-6, B, STRONG, I, EM, P, BR, HR)
4. Develop a personal homepage about yourself and your interests containing a graphic file and a link to another file.
5. Participate in making or updating a homepage for your Pathfinder club, church, or school.
6. Do research on the Internet on a topic of interest to you using Search Engines and links and give a report (oral or written) on what you found. Or visit 25 Internet sites of which 5 would be church related. Give a report on the sites telling what you like or don't like about each site. Rate them on design (organization, use of graphics, overall visual appeal, ease of use etc.) and content,
7. What are some dangers on the Internet? How can you avoid them? Discuss some ways that can help protect you from those dangers.
8. For at least a month use E-mail to exchange messages with a pathfinder in another country.

SKILL LEVEL 2

(proposed) Advanced Internet Pathfinder honor

1. Write a web site, without the aid of a HTML editor, of at least 3 pages in HTML using these commands properly <HTML>
<HEAD>
<TITLE>
<BODY>
 using GIF and JPEG files

<A HREF...> for internal links, links to other files in your site and links to files in other sites.
The site should include frames, tables, ordered lists and unordered lists.

Use text formatting commands such as. (H1-6, B, STRONG, I, EM, P, BR, HR)

<META ...>

2. Install and setup, for use with an Internet service provider, a browser and E-mail program on a computer.
3. Give a brief history of the Internet.
4. Make an animated GIF image and one using a transparent color.
What can be done to make GIF files load from the web faster.
When is it better to use:
 - a. JPEG image files
 - b. GIF image files?
5. Use FTP and news groups

SKILL LEVEL 3

[Pathfinders homepage](#)

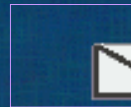

[E-mail John Goude](#)

When E-mailing do not remove the anti spam * from the subject line.



Proposed modifications

Edible Wild Plant Honor



1. Identify in the wild 15 edible wild plants.
2. Identify in the wild or from pictures
 - 5 trees and
 - 5 shrubs which are edible.
3. Identify, prepare and eat
 - 3 kinds of wild berries or fruits,
 - 3 salad plants or seeds
 - 3 potherbs,
 - 2 tubers (or roots)
4. From two of the plants below, demonstrate at least one way how to prepare and eat that plant, and explain how you can prepare the other parts.
 - 5 parts of the cattail for food (root preparation required)
 - 4 parts of milkweed
 - 4 parts of daylily
 - 3 parts of yucca
 - 3 stages of a mesquite, or screwbean
 - acorns for food,
 - thresh and winnow seeds from plants such as lambs' quarters, amaranth, dock, or grass;
 - other major wild edible plants in your area if none of the above are available
5. Tell a Bible or church history story that involves poisonous or wild edible plants or where such knowledge would have been useful (2 Kings 4:38-41). Or find a Bible object lesson in a wild edible plant.
6. The roots of what 2 water plants were dried and ground into meal by the Indians? Or name 2 wild plants used as staple food items by the indigenous people of your area and tell how they stored and prepared them.

7. What is the cardinal edibility rule?

What is the general edibility rule for berries? List an exception.

[black and blue, red, and white]

What is the general edibility rule for plants with milky sap? List an exception.

8. Identify 3 poisonous plants in your area that no part can be made edible. Tell how you would recognize water hemlock (*Cicuta* sp.) and poison hemlock (*Conium* sp.)? Tell why mushrooms so very dangerous to eat?

Please give your [feed back](#) on this honor (roughly equivalent to a BSA merit badge). Could it be taught in your area to 10 to 15 year olds?

When E-mailing do not remove the anti spam * from the subject line.

Some have suggested that an advanced honor be made moving the threshing and poisonous plants to an advanced honor

[\[Why Change\]](#)

[\[Answers\]](#)



[Home](#)

Copyright © 1996, 2001 John Goude

JEG Development





Why change the Edible Wild Plant Honor



- The current honor teaches Pathfinders to do **high risk** activities. In the book Poisonous Plants of California the statement is made that,

"Of all poisonous plants in California, toxic mushrooms cause the most serious illnesses and nearly all the fatalities to humans."

Some mushrooms in the United States are so toxic that people have **died** from the mushroom toxin transferred by a knife to edible plants. Do you really want to teach your Pathfinder's to engage in the high risk activity of wild mushroom eating? I do not want to be responsible for getting someone into something that could kill them or put them in the hospital and have liver damage to live with for the rest of their life.

- The current honor was written with only the eastern states in mind. Many of the required plants do not grow wild in the west.
 - It is strange to beg a stranger to allow a edible wild plant class to dig up their prized bed of day lilies. They often reply, "These gorgeous flowers are not wild! Go get some real wild plants." Even in the east day lilies are not native they only grow where they have been introduced.
 - There are many areas that milkweed does not grow at all. But yet the honor **requires** it to be eaten.

This honor was originally written by someone I have great respect for, but he had studied wild edible plants mainly in the east when he wrote it. Is it time to update this honor to be safe and less regional ? How would the proposed changes effect those teaching it in the far north of Alaska and Canada? I would like some feedback from there.

[\[Proposed Honor\]](#) [\[Official Version\]](#)

[\[Answers\]](#)



[Home](#)

Copyright © 1998 John Goude

JEG Development 



Edible Wild Plant Honor Answers



4. From two of the plants below, demonstrate at least one way how to prepare and eat that plant, and explain how you can prepare the other parts.

- 5 parts of the cattail for food (root preparation required), root, shoot, cattail, pollen, rhizome
- 4 parts of milkweed, (all parts are poisonous until cooked) young leaves, buds, flowers, young pods
- 4 parts of daylily, tubers, shoots, buds, flowers
- 3 parts of yucca, flower stalk, flower, seed pod
- 3 stages of a mesquite, flower, green pods, mature pods
- [acorns for food](#)
- lambs' quarters, amaranth, dock, or grass; thresh, winnow the seeds, tender leaves and stems can be eaten raw or cooked.
- or other major wild edible plants in your area if none of the above are available

5. Tell a Bible or Church history story that involves poisonous or edible wild plants or where such knowledge would have been useful. Or find a Bible object lesson in a wild edible plant.

Gen. 13:18 (ASV) And Abram moved his tent, and came and dwelt by the oaks of Mamre, which are in Hebron, and built there an altar unto Jehovah.

Gen. 14:12-13 (ASV) And they took Lot, Abram's brother's son, who dwelt in Sodom, and his goods, and departed. 13 And there came one that had escaped, and told Abram the Hebrew. Now he dwelt by the oaks of Mamre, the Amorite, brother of Eshcol, and brother of Aner. And these were confederate with Abram.

Gen. 18:1 (ASV) And Jehovah appeared unto him by the oaks of Mamre, as he sat in the tent door in the heat of the day.

(Do you think Abram ate the acorns? There is archaeological evidence that they were eaten back then.)

II Kings 4:38-41 (NIV) Elisha returned to Gilgal and there was a famine in that region. While the company of the prophets was meeting with him, he said to his servant, "Put on the large pot and cook some stew for these men."

39 One of them went out into the fields to gather herbs and found a wild vine. He

gathered some of its gourds and filled the fold of his cloak. When he returned, he cut them up into the pot of stew, though no one knew what they were. 40 The stew was poured out for the men, but as they began to eat it, they cried out, "O man of God, there is death in the pot!" And they could not eat it. 41 Elisha said, "Get some flour." He put it into the pot and said, "Serve it to the people to eat." And there was nothing harmful in the pot.

Matt 3:4(NIV) John's clothes were made of camel's hair, and he had a leather belt around his waist. His food was locusts and wild honey. (Locusts are carob or a similar bean pod.)

Lichens are an edible plant that is a blend of two plants depending on each other. So Jesus is a blend of divine and human.

Luke 1:35 (NIV) The angel answered, "The Holy Spirit will come upon you, and the power of the Most High will overshadow you. So the holy one to be born will be called the Son of God.

John 1:1-5 (NIV) In the beginning was the Word, and the Word was with God, and the Word was God. 2 He was with God in the beginning. 3 Through him all things were made; without him nothing was made that has been made. 4 In him was life, and that life was the light of men. 5 The light shines in the darkness, but the darkness has not understood it.

John 1:9-14 (NIV) The true light that gives light to every man was coming into the world. 10 He was in the world, and though the world was made through him, the world did not recognize him. 11 He came to that which was his own, but his own did not receive him. 12 Yet to all who received him, to those who believed in his name, he gave the right to become children of God-- 13 (JEG) children born not of natural descent, nor of their human decision or someone else's will, but born of God. 14 The Word became flesh and made his dwelling among us. We have seen his glory, the glory of the One and Only, who came from the Father, full of grace and truth.

Most acorns are very BITTER and need to be washed of their bitterness before they are useful. So we must be washed of our bitterness of sin to be useful to God.

Ps 51:2-3 (NIV) Wash away all my iniquity and cleanse me from my sin. 3 For I know my transgressions, and my sin is always before me.

Ps 51:6-7 (NIV) Surely you desire truth in the inner parts; you teach me wisdom in the inmost place. 7 Cleanse me with hyssop, and I will be clean; wash me, and I will be whiter than snow.

Ps 51:10-13 (NIV) Create in me a pure heart, O God, and renew a steadfast spirit within me. 11 Do not cast me from your presence or take your Holy Spirit from me 12 Restore to me the joy of your salvation and grant me a willing spirit, to sustain me. 13 Then I will teach transgressors your ways, and sinners will turn back to you.

Titus 3:4-7 (NIV) But when the kindness and love of God our Savior appeared, 5 he

saved us, not because of righteous things we had done, but because of his mercy. He saved us through the washing of rebirth and renewal by the Holy Spirit, 6 whom he poured out on us generously through Jesus Christ our Savior, 7 so that, having been justified by his grace, we might become heirs having the hope of eternal life.

Cleavers stick to your clothes. That is how God wants us to stick to Him and to the good.

Rom 12:9 (ASV) Let love be without hypocrisy. Abhor that which is evil; cleave to that which is good.

Deut 10:20 (KJV) Thou shalt fear the LORD thy God; him shalt thou serve, and to him shalt thou cleave, and swear by his name.

(NIV) Fear the LORD your God and serve him. Hold fast to him and take your oaths in his name.

Deut 30:20 (KJV) That thou mayest love the LORD thy God, and that thou mayest obey his voice, and that thou mayest cleave unto him: for he is thy life, and the length of thy days: . . .

(NIV) and that you may love the LORD your God, listen to his voice, and hold fast to him. For the LORD is your life, and he will give you many years in the land . . .

Josh 23:8 (KJV) But cleave unto the LORD your God, as ye have done unto this day.

(NIV) But you are to hold fast to the LORD your God, as you have until now.

Acts 11:23 (KJV) Who, when he came, and had seen the grace of God, was glad, and exhorted them all, that with purpose of heart they would cleave unto the Lord.

(NIV) When he arrived and saw the evidence of the grace of God, he was glad and encouraged them all to remain true to the Lord with all their hearts.

See also Josh 22:5 , Deut 11:22 , Deut 13:4 (KJV)

Tumbleweed God blows the wicked like wind blows tumbleweed.

Ps 83:13 (NIV) Make them like tumbleweed, O my God, like chaff before the wind.

Isa 17:13 (NIV) Although the peoples roar like the roar of surging waters, when he rebukes them they flee far away, driven before the wind like chaff on the hills, like tumbleweed before a gale.

This is a start but God has given you many more think up some yourself.

6. The roots of what 2 water plants were dried and ground into meal by the Indians? Or name 2 wild plants used as staple food items by the indigenous people of your area and tell how they stored and prepared them.

Cattail, arrowhead, bulrush

7. What is the cardinal edibility rule?

Positively identify every plant that you eat and know it is edible and how to prepare it.

What is the general edibility rule for berries?. [black and blue, red, and white]

90% of black or blue berries, half of red berries, 10% of white berries are edible.
For berries the rule is

Black and blue are good for you.
Red use your head.
White don't bite.

Andrew Manthe

List an exception Raw poke berries (seeds) and nightshade berries and black and poisonous,

Western snow berries are white and edible but if they are not ripe they are bitter and give you a sore throat.

Symphoricarpos mollis poisonous Eastern snow berries will make you vomit.

Symphoricarpos albus

What is the general edibility rule for plants with milky sap?

Plants with a milky sap are usually not edible.

List an exception. Milk weed (cooked), dandelion, salsify, wild lettuce, figs, lettuce, mulberry, etc.

8. Identify 3 poisonous plants in your area that no part can be made edible.

Tell how you would recognize water hemlock and poison hemlock?

Water and poison hemlock are in the carrot family both usually have purple spots.

Water hemlock has veins running to the notch of the leaves and has hollow roots that often contain a yellow liquid.

Tell why mushrooms so very dangerous to eat?

Some people with PhDs in mycology (mushroom study) have been killed by mistakenly eating poisonous mushrooms. Other people have died after eating food cut with a knife that had not been washed after it cut poisonous mushrooms. The Bible never mentions them as a food acceptable for people.



Experience nature as God intended. Taste it !
Click here to learn about wild plants you can eat and enjoy.
Dining on the Wilds a six session video course.



Survival Tip

A C O R N S

California black oak
Quercus kelloggii



Warning

Unprocessed acorns usually have toxic quantities of tannin and may shutdown the digestive track. Proper leaching removes the tannin making them a major wild food item.

The most common steps in leaching are

- shelling the nuts
- removing the inner skin
- grinding the nuts
- cold water leaching allows the acorn meal to thicken when cooked

Hot water leaching is faster and more common with "modern" experimenters but does not thicken or act as a binder (like eggs or gluten) when cooked.

California black oak acorns usually are harvested in October to December

A Method of Cold Water Leaching

Shell the acorns in your favorite way. Some suggestions step on them with hard shoes until you hear a pop sound. Drive over them. Use a nut cracker (dried acorns are more brittle). Crack with a hammer or rock. Soak them in water until they split open (about 2 weeks to a month).

Place about a cup of shelled nuts in a 1 quart blender and fill it with water. Jog the blender for 5 to 15 seconds at a time to knock off the skins. Stop the blender and skim the skins from the surface when there are enough to skim. Repeat the jogging and skimming until no more skins float to the surface.

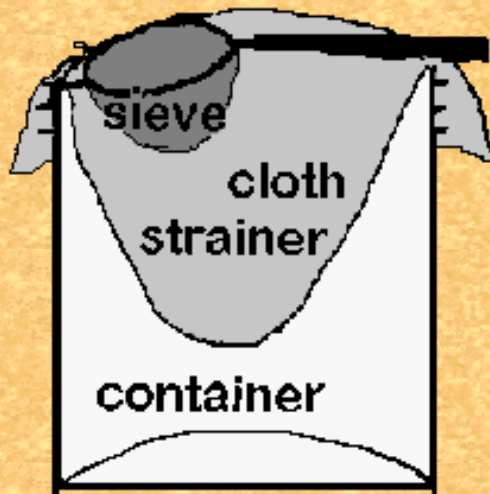

Grind the nuts in the blender to a fine meal. The water will turn milky white. Pour the nuts and water into a large container with a fine cloth strainer (or 5 gal nylon paint strainer) through a sieve. The part staying in the sieve needs to be ground again. The meal that stays in the cloth strainer needs more leaching. The very fine sediment that goes through the cloth thickens when it is cooked. When all the nuts are ground and pass through the sieve, move the cloth strainer and meal to another container of cold water and agitate the meal more fine sediment will cloud the water. After letting it set for about 10 min. remove the meal from the water and pour the water into the first container of murky water. Fill the second container with water again and put the meal into the fresh cold or warm water. The water may need to be change again.

Let the first container of murky water settle for 2 hours to overnight and change the water but keeping the sediment. This water changing may need to be done more than once. When the leaching water is poured off test for tannin by cooking equal amounts of meal and taste for tannin (bitter after taste and/or dry feel to the mouth). Cooking brings out the tannin taste. If there is no tannin taste pour the sediment into the strainer with the rest of the leached meal and let it drain. The acorns are now leached

A c o r n B r o w n i e s

2 cups drained but wet cold water leached acorn flower
 1 cup chopped walnuts
 1 cup fruit juice concentrate or honey
 1/2 cup water with
 1 teaspoon baking soda

mix water and baking soda first then mix with other ingredients. Bake in a greased pan at 350F for 45 min. Cool and serve

White man's wewish

(wewish is a Cahuilla name for acorn mush)

1 cup of drained but wet cold water leached acorn flower
 1 cup water (some acorns need more some less)
 1/4 to 1/2 teasp. Salt (to taste)

1/4 cup sweetener honey or fruit juice concentrate (optional)

Mix ingredients together and bring to a boil, or until wewish thickens.

Because some search engines penalize for "over use of words"
"nuts" has been used in place of a c o r n s .



[Order](#) [Home](#) [Books](#)

Copyright © 1996, 1998 John Goude

JEG Development info@edibleplants.com

When E-mailing do not remove the anti spam * from the subject line.



[Survival tip & Plant of the month](#)



[Nutrition](#)



[Classes & Outings](#)



[Books](#)



[Pathfinder](#)



[Links](#)

[John's Resume](#)



[Dining on the Wilds](#)



Wild Edible Plants.

Dining on the Wilds

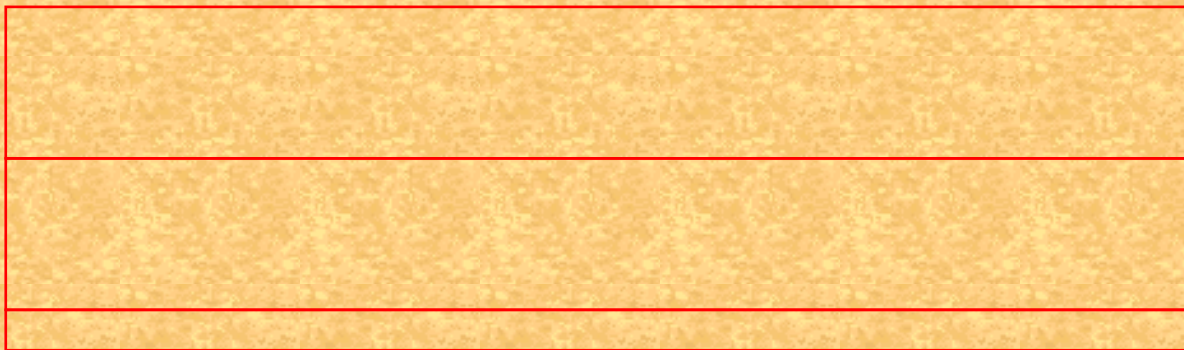

"They are pulling the wool over **your** eyes. The issue is the new '[Adventure Pass](#)' initiated by the United States Forest Service, and the victims are the taxpayers. "
California Assemblyman BRET GRANLUND



"The government's decision to not prosecute violators seems to confirm that the **fee** demonstration program is essentially a toothless tiger which the public can eradicate." [Tucson Weekly](#)

NEW SHAREWARE [spelling dictionaries](#) in the books section



[Free! Download Netscape](#)



[see for yourself](#)

[privacy](#)

Copyright ©
1996, 2001 [John](#)

[Goude](#)
JEG
Development

Dining on the Wilds

Learning Nature through Wild Edible Plants and Ethnobotany

This set of pages will give you . . .

1. [WHY?](#) learn wild edible plants
2. [DESCRIPTION](#) of the video course
3. [Table of contents](#)
4. [WHO](#) made it?
5. [OTHERS](#) say
6. [Cover](#) (25KB)
7. How to [ORDER](#)



Dining on the Wilds

- Takes you inside the classroom for an interesting graphic slide presentation which gives you a close-up look at the identification of many wild edible plants, herbs and mushrooms of North America.
- Come along on live field trips. Observe and enjoy plants in their natural habitat. Learn how to use these natural, nutritive items.
- Taste the fun of a cooking class where unique recipes are demonstrated. You are in for a truly mouth watering treat.
- Watch the fun as students bring family and friends to a gourmet buffet where everyone brings home made dishes containing at least one wild ingredient.
- Listen to student comments as to why they enrolled in the class and why some have come back repeatedly.
- This video set is a unique, fun and educational

[Others say](#)

I have thoroughly enjoyed Dining on the Wilds. The tapes have been a great help. They are very informative. ...

Sincerely,
Susie Teague
[Cedar Creek Nature Studies](#)

experience that your whole family will enjoy viewing over and over again.

[\[Why learn wild edible plants?\]](#) [\[Table of contents \]](#) [\[About the presenters\]](#) [\[Cover 25KB\]](#)



Dining on the Wilds **is brought to you by**



[Miriam Darnall-Kramer](#) [18K]

- Author of Wild Plants to Eat correspondence course and 6 other related courses.
- Co-author of Wild Plants to Eat workbook and slide set.
- Associate director of the former International Wilderness Club.
- Extensive classroom and field experience teaching about wild edible plants in 27 states, Canada and Peru.
- Listed in Who's Who in American Women.
- Secretary-treasurer of Forage Ahead.



[John Goude](#)[16K]

- Has studied wild edible plants for 28 years in 12 states.
- Has taught wild edible plants in 7 states.
- San Gorgonio Wilderness Assoc. interpretive specialist, (on strike) in wild edible plants. [Hug-A-Tree and Survive teacher](#)
- [Rabbitstick rendezvous](#) of Society for Primitive Technology teacher.
- President of Forage Ahead, a wild edible plant enthusiasts club.
- Has cataloged and cross indexed over 500 North American wild edible plants.
- Served as president of Riverside California Chapter of International Wilderness Club.

[\[Dining on the Wilds top \]](#) [\[Reasons to learn Wild edible plants\]](#) [\[Table of contents\]](#) [\[Cover25KB \]](#)



Tell us what you think:

Required fields = *

Your name: *

Your e-mail address: *

Comments:



This [SurvivalRing](#) site is owned by
[John Goude](#).

Want to join the [SurvivalRing](#)?



[\[Skip Prev\]](#)[\[Prev\]](#)[\[Next\]](#)[\[Skip Next\]](#)[\[Random\]](#)[\[Next 5\]](#)[\[List Sites\]](#)[\[Home\]](#)



(Reset date July 1, 1997)

Copyright © 1996-2001 John Goude
webmaster@edibleplants.com

When E-mailing do not remove the anti spam * from the subject line.

If you would like to use something on this site please E-mail a request to use it. So far almost all requests made before use have been granted. It is nice to know when we have helped someone else get their message out.

[Dining on the Wilds home](#)

Wild Edible Plants etc. Links

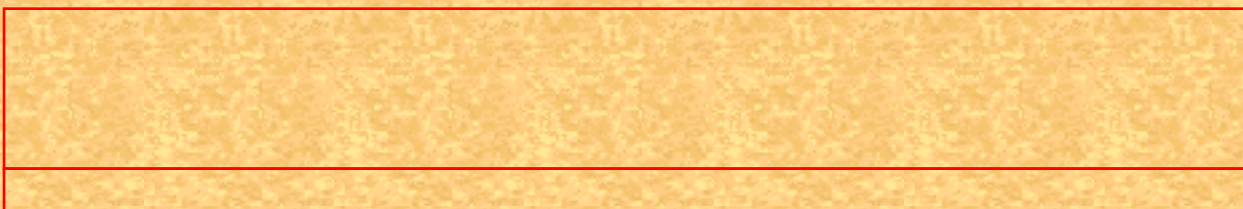

These links are to sites of interest, not an endorsement of the authors or ideas of these pages.

[Search Engines and web promotion](#)

Does the [Federal Government](#) really have a surplus?
Write your [Congress Representatives](#) about it.

Wild Edible Plants

News letters

[Wild Food Forum](#)

[Food Adventures - Edible Plants](#) - Dr. John Kallas Ph.D.

["Wildman" Steve Brill](#) New York naturalist

[Back Country Rangers](#) lists the edibles of the Sierras.

[Cimarron Frontiers](#) wild edible plants and biointensive gardening

[School of Self-Reliance Christopher and Dolores Nyerges](#)

[NativeTech](#): Native American Technology Plant page

[Country Life Herb discussion board](#)

[ANBG \(Australian National Botanic Gardens\)- Australian Aboriginal Trail](#)

[Aboriginal Plant Use in South-Eastern Australia](#)

[A Taste of Nature](#) A book about common Wild Edible Plants

[Naturegraph Publishers](#) Print many fine books on nature wild edibles and American Indian ways.
[pawpaws and persimmons](#)

[How's Pinenuts](#)

[My Wild Friends](#) Free Food From Field and Forest

[Edible and Medicinal Plants of Southern Illinois](#) Belleville East High School

[Southeastern Edibles J. T. Dabbs, III](#)

Data Bases and References

[American Indian Ethnobotany Database](#)

[Phytochemical and Ethnobotanical Databases](#)

[Plant name/range data base \(USAggriculture\)](#) Plant names botanical, common, abbreviation, family, range map, states

[MPNADB](#): Medicinal Plants of Native America Data Base

[UCMP Glossary of Natural History Terms, #8 Botanical Terms](#)

[Ethnobotany resources Seattle Public Library](#)

[Poisonous Plants pictures](#) Cornell

[California Black oak data/pictures](#)

[University of Wisconsin Virtual Foliage](#) Home Page leads to very large gopher site of plant pictures.

[University of California Berkeley](#) 20,000 images of California plants

Sources and information of native or wild plants

[Native American Seed](#)

[RNGR USDA Forest Service](#) Reforestation, Nurseries, and Genetic Resources

[Wild Blueberry Association of North America](#)

[California Native Plant Society](#)

[CIEER](#) Centre For International Ethnomedicinal Education and Research

[CalFlora](#)

Wilderness Survival.

[BOSS Boulder Outdoor Survival School](#)

[SARBC](#) Search and Rescue Society of British Columbia - Lost in the Woods - The 9 Rules for Survival

[Hug-A-Tree and Survive](#)

[Survival bible 2001](#)

[Hoods Woods Wilderness school](#)

[Simply Survival](#) northwest

[Aboriginal Living Skills School](#), Cody Lundin

[Mountain Man Survival](#)

Early Technology links

[Rabbitstick rendezvous](#)

[PrimitiveWays](#)

[Rabbitstick / Wintercount Pictures](#) (+ other gatherings)

[Boomerangs and links](#)

[The Paleolithic Diet Page of links](#)

[SPT](#) Society of Primitive Technology with online articles

[NativeTech](#): Native American Technology and Art

[Tom Brown](#) Tracking School

[Hollowtop Outdoor Primitive School](#)

[Windsong Primitives](#) formerly the TRIBE

[Drop spindles](#) Lollipops are handpainted handspindles

E-mail groups

[Subscribe](#) wild edible plants forageahead e-mail group [Unsubscribe](#)

[Subscribe](#) Southern California early technology e-mail group [Unsubscribe](#)

[Tom Brown Tracker Mailing List](#)

[Primitive Skills Group](#)

[Appalachian Trail / Ice age trail / Pacific Crest Trail](#)

[Herbal resources and e-mail groups](#)

[ForageAhead Wild Edible plant Group](#)

Herb links

[Cedar Creek Nature Studies](#)

[Mountain misery](#) the Indian medicine plant the herbalists FORGOT

[Meydrech Family Herbal](#)

[Red sage](#) interactive CD-ROM guide to medicinal plants.

[Alternative Nature Online Herbal](#) MANY links and resources

[Herbs For Health](#)

[Mom`s Herb Kitchen](#)

[Mears' Candida Fighters](#)

[California School of Traditional Hispanic Herbalism](#)

Home School

[Moore Foundation](#)

[Home Study International](#)

[The Sycamore Tree Homeschool and Catalog](#)

[Home Education Network Radio](#)

[Home Learning Around Pittsburgh](#)

Outdoor Links.

[Hiking Las Vegas](#) get away from all that artificial stuff

[Alex's OutDoor LinXs](#)

[Canoe Saskatchewan](#)

Outdoor Magazines.

[Backwoods Home Magazine](#)

[Canoe & Kayak Magazine](#)

[Outdoor Online](#)

[GORP Great Outdoor Recreation Pages](#)

Knot and rope work links.

I have taught so many people how to tie knots I must put in a few knot links.

[Animated knots BSA 42 UK](#)

[Knots illustrated](#)

[Lashing](#)

[Ropeworks knots, hitches, splicing, lashing and rope making.](#)

[International Guild of Knot Tyers](#)

[Flip Flop Winch](#)

Cool Nature and Science links

online book about the [Star Date](#) University of Texas

[Aurora borealis](#) Brought to you by [\(GEDDS\) Geospace Environment Data Display System](#)

[Mars Pathfinder project](#)

[Tide Tables for USA](#)

[NOAA Tide Tables](#) More compleate and complicated

[Hawaii volcanos](#)

[History of Mathematics](#)

[Reeko's Mad Scientist Lab](#) (for Kids) (optimized for greedy Microsoft)

Evolution

[Darwinian Theory and Natural History](#)

[Experimental Support for the Design UC Santa Barbera](#)

[Book Excerpt by Phillip Johnson](#) who has an interesting way of looking at this subject.

[brush FIRE](#) can be good (California Native Plant Society)

Preparedness

[Pioneer Emergency Preparedness Supplies](#)

Other links.

[The Bottle Inn](#) of Dorset England hosts [The World Nettle Eating Championship](#)

[Viewers for Quality Television](#)

[Giardia lamblia](#)

treating [Hypothermia equipment](#)

[medieval collectibles](#)



[Desert SW USA](#)

[OCB Tracker Powwow's etc.](#) (California Native News)

[Frontier and Pioneer days of the American West](#)

[Jeff Davis Show and New World Order](#)



[World Wide Wilderness Directory](#)



[Information and
articles on a wide
range of outdoor
activities](#)

[San Gorgonio Wilderness Association](#)

[REI Home](#)

[Nature is calling](#) road side stop

[The Veg Web Board](#) Cooking over a Campstove

[Thermos Cooking \(Kurt Saxon\)](#)

[Cindy Renfrow Medieval cooking](#) Natural History photographer's addresses Gordon Thomas

[La Sierra University](#)

[Loma Linda University](#)

[North American Pathfinders](#)

[Pathfinders](#)

[Boy Scouts of America](#)



Maintaining a links page is a lot of work. If there are dead links here, please let it be known.

Tell us what links (URL) we should evaluate to include here.

Link exchanges are preferred.

Your name:

Your e-mail address:

Comments:

[Matt's Script Archive](#)

[Dining on the Wilds](#)

is listed on these search engines

[Surf Point](#)

[Starting Point](#)

[Link Trader](#)

[Lycos Pro](#)

[Lycos](#)

[Infoseek](#)

[Excite](#)

[Magellan](#)

[Web Crawler](#)

[Hot Bot](#)

[Alta Vista](#)

[Open Text](#)

[Yahoo](#)



PromoteOne	Click Here 
-------------------	--

[Tools for Searching the Internet](#)

[Click Here to Search
the Web with](#)

Copyright © 1998, 2001 [John Goude](#)

When E-mailing do not remove the anti spam * from the subject line.

Winter Count

February 10-16, 2002 and
February 16-22, 2003



Rabbitstick

September 15 -21, 2002
and
September 14-20, 2003



Come and celebrate our **Rabbitstick**! Join other potters, knappers, archers, atlatlers, felters, trackers, foragers, drummers, basket makers, hide-scrapers, tanners, storytellers, fire dancers, and many, many other primitive technologists and enthusiasts for 7 days of classes and fun on the historic Henry's Fork of the Snake River.

Named after a simple tool used extensively by western natives and, in a modified version, by aborigines all over the world, the rabbitstick leads the world as one of man's earliest and longest lasting tools. As each ancient hunter would pass his knowledge and insights on to the younger generations, so to have people come to our gatherings to share their lessons and insights with other instructors and students. Come and experience the tradition! **in Rexburg, Idaho**

**September 15 -21, 2002 and
September 14-20, 2003**

Cost \$245 now thru Sept. 1 \$50 more after Sept. 1

Winter Count is a similar conference but is a dry camp (no river) about 50 miles from Phoenix Arizona off Maricopa Rd.

**February 10-16, 2002 and
February 9-15, 2003**

Cost \$245 Late registration or gate \$50 more

No Drugs, Alcohol, or Pets

Fee covers Camping, 2 meals per day, and basic instruction.

Fee does not include project material fees that may range from free to \$100.

Names of all people in your

party" _____

Mailing Address:

Phone: _____

E-mail: _____

How will you be traveling to the site?

- Walk • Bus • Drive • Hitch • Plane • Other

What type of lodging will you be using?

- Camper • Tepee • Yurt • Truck/Van • Hotel • Anywhere

When do you plan to arrive?

Do you plan to use our shuttle from Idaho Falls? • No • Yes

(If yes, please send us your travel itinerary)

Cost: (Number of people in your party X \$245 or \$50 more if after Sept. 1)

Shuttle fee from airport (if applicable): Total due:

- Check or Money Order enclosed

- Charge credit card # _____

Exp. Date: ____/____

Signature: _____

*When completed, send form with check or money order payable to
Backtracks*

P.O. Box 905,

Rexburg, Idaho 83440.

Upon registration, you will be sent additional information and travel instructions. Questions.' Call us at (208) 359-2400.

Because this page is not sponsored or maintained by Backtracks the fees presented here are not binding on the sponsor of the event or anyone else.

[BOSS Boulder Outdoor Survival School Pictures of Rabbitstick by "Roadkill"](#)

[E-mail Backtracks](#)

Brought to you by [Dining on the Wilds](#)

E-mail [JEG Development](#)

When E-mailing do not remove the anti spam * from the subject line.



Experience nature as God intended. Taste it !
Click here to learn about wild plants you can eat and enjoy.
Dining on the Wilds a six session video course.



Mountain misery

Chamaebatia foliolosa



Mountain misery was used by the Indians of the Sierras as a medicine for various diseases like flues, colds, coughs, etc.

Take one leaf cluster of 4 or 5 leaves and steep it in a cup of hot water for 15-20 min. at the first symptoms of an illness. Somehow drink the tea. Some have found it useful as aroma therapy.

The first time I tried this plant, I had just come back from a rendezvous and many people had an illness that started as a fever and weakness progressing to a cough and laryngitis. I noticed one day that I was coming down with the symptoms that others had started with and been sick for more than a week. At the rendezvous I had been trading Mountain misery and had some left. So I made a cup of tea and drank it just before I went to bed. That night I woke up feeling very hot. In the morning the fever had left and I never did get the rest of the symptoms that the others had gotten.

I have tried this remedy several times since then, and usually it works but two times it apparently did nothing for me. It seems

to work better on respiratory system flues better than on digestive system flues. It has not worked on colds (a respiratory infection without much fever or generalized aches).

The common name "Mountain misery" was given to this low growing plant because its resinous leaves leave sticky resin on every thing they touch. Some people think the resin has an unpleasant medicine odor.

If you would like to try this ancient but potent Indian herbal remedy on your misery send \$5 to: Please make checks and money orders payable to JEG Development.



Mountain misery
13378 California St.
Yucaipa, CA 92399

909-797-5912

info@edibleplants.com

When E-mailing do not remove the anti spam *
from the subject line.



ORDER



BOOKS

[Order](#) [Home Books](#)

Copyright © 1998, 2001 John Goude

JEG Development webmaster@edibleplants.com

When E-mailing do not remove the anti spam * from the subject line.

Flip Flop Winch

Mors Kochanski taught me this one and gave his blessing to put it on the web. It is his modification of a Finnish windless

In these pictures the logs have been shortened. In real life they should be as big as you can work with. The lever is practical up to about 8 ft. or 2.5m long. The longer the winch log the more stable this device is but too long makes it so stable you can not turn or flip it

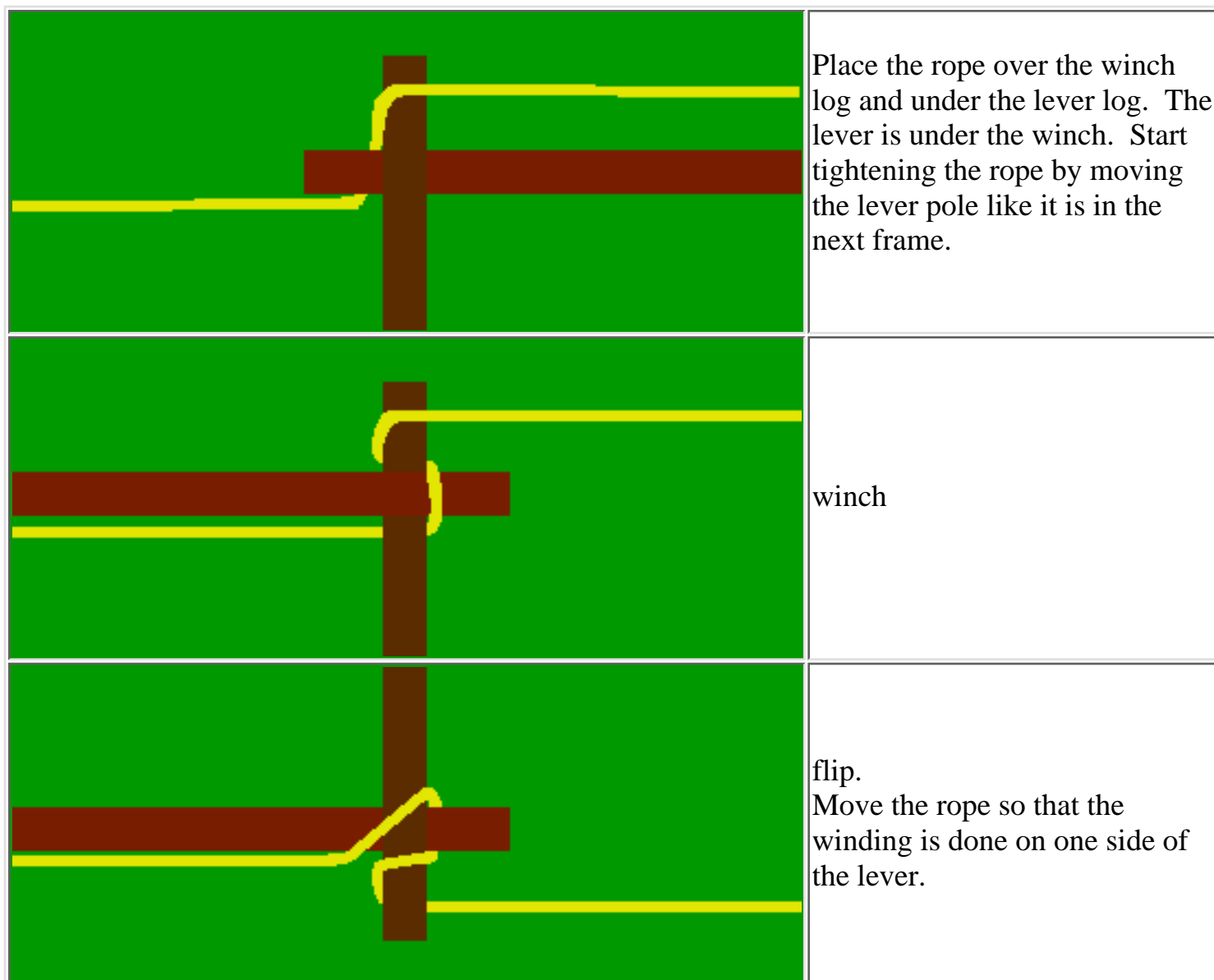

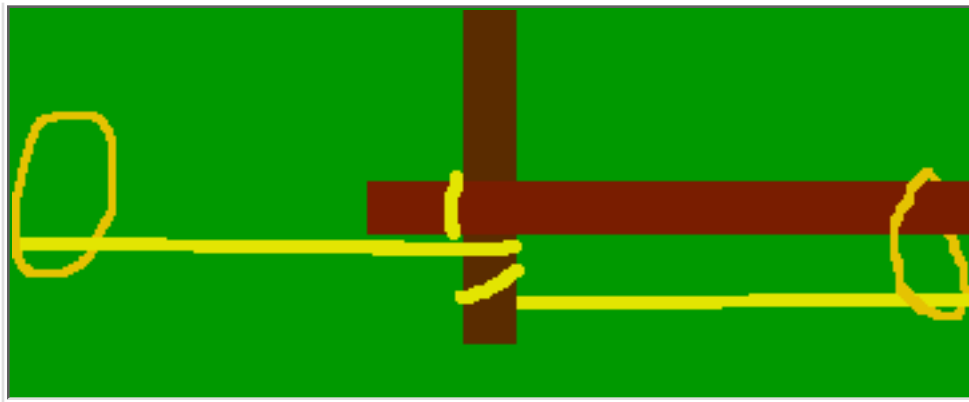

winch.
Continue flipping the winch pole and winding with the lever pole until you have winched your load to where you want it.

- If you are winching alone tie 2 keeper loops of cord around the lever and the rope so that you can flip. If you have a helper one of you flip and the other winch.
- Remember the winch is going to move toward the anchor at half the rate that the load does.



[Order](#) [Home Books](#)

Copyright © 1999 John Goude

JEG Development info@edibleplants.com When E-mailing do not remove the anti spam * from the subject line.

John Goude

**12975 Second St.
Yucaipa, CA 92399-5605
(909) 797-5912**

EDUCATION:

- BS, Computing Information Systems, Loma Linda Univ. (La Sierra University)
- AS, Engineering Physics, Loma Linda University(La Sierra University)

COMPUTER EXPERIENCE

Digital VAX/VMS RSTS/E P/OS

Data General AOS/VS

Harris VOS

PC's MS DOS Windows 3.1 Windows95/98

IBM AIX

Languages: HTML, VAX BASIC, Microsoft BASIC, Visual BASIC, C, Pascal, FORTRAN, DIBOL, COBOL, Datatrieve, INFO, VAX11 Macro.

File Systems: RMS, FMS (Transcomm), DMS-500, CDD(Common Data Dictionary), PCFile

WORK EXPERIENCE:

Consultant
October 1990
to Present

for **JEG Development** on MS-DOS, VMS, Windows 3.1, Windows 95/98, using, BASIC, C, HTML, Word Perfect, Word for Windows, etc. Installing, repairing and upgrading systems. Designing and writing Web pages. Some clients have been Digital Equipment Corp., L. N. Enterprises, Anderson Scientific, Mother Natures Goodies, Peoples Choice Foundation, etc.

Programmer Analyst
April 1990 to
September 1990

for **Briareus Corporation** did software telephone support for XENIX, AIX and IRIS General ledger systems. Designed and wrote software enhancements. Software maintenance over network.

System Manager

February 1988

to

September 1989

for **Krupp/Taylor FCB** did system generations on PDP11 network running RSTS and LINK, maintenance programming on job costing. Reorganized backup routine. Did user support for WORD-11, DIGICALC and business systems. Automated the incentive program. Maintained the PBX control key. Connected and traced communication lines. Installed an Apple Talk network.

System Manager

February 1987

to

February 1988

for **Alumni Association of the School of Medicine of Loma Linda University Inc.** set up operations for a VAX set up user terminals and accounts using WORD-11 and Acorn nonprofit corporation donor tracking software.

System Manager and Programmer

October 1984

to

February 1988

for **Loma Linda University** managed a Data General MV4000 running AOS/VS, a Harris 100, a Data General NOVA running MIIS (like MUMPS). Did system generations. Designed and programmed student information package in **INFO** (a 4th GL). RS232 and centronics parallel work. Designing and programming systems for survey entry and analysis.

System Manager

and

Programmer Analyst

December 1980

to June 1984

for **H. H. Cutler Co.** coordinated operations on the PDP11. Customized and Maintained Accounts Payable and Fixed Assets Packages using FMS (Transomm's). System Manager for WORD-11 under RSTS/E, Team lead the development of a data collection network using micros and the PDP. Invented an improvement for TI810 printers. Performed a system study to upgrade from a PDP11 to include ABLE's Megabox and a VAX. Installed and debugged the Megabox and coordinated the VAX installation. Did the system generations.

System Manager

Installed, maintained and tuned VMS, Datatrieve, COBOL, BASIC, FMS (Forms Management System), Digicalc, CDD (Common Data Dictionary), WORD-11 on a VAX running VAX/VMS. Transferred the WORD-11 speck sheet application to the VAX. Deciphered WORD-11 internals to optimize the use of WORD-11 directories, standardized RS232 lines, wrote security software for the modem lines, maintained software on the VMS micro network, installed and assisted users on MS/DOS computers. Interacted with outside sales and service people.

Programmer Analyst

July 1978 to
September 1980

for **Amos Press Inc.** debugged an inventory package using FMS (Transomm's File Management system). Redesigned and rewrote it to interface with general ledger and job cost accounting using BASIC-Plus and DMS-500.

PERSONAL DATA:

Hobbies include backpacking, youth groups, crafts, 4X4, wild edible plants, and nature study in general. Ham call KE6VUB

Producer of "Dining on the Wilds" video course.

References Available on Request.

E-mail [John Goude](#)

When E-mailing do not remove the anti spam * from the subject line. [Picture](#)



The COURTS have ruled Adventure Pass is discretionary (not mandatory)

The court was ambiguous as to whether the rest of the recreation fee demonstration program being discretionary.

Let's whet your kids' appetite for spectator sports in the national forest. [Click here](#) to see what [smokeybear.com](#) coloring book wants your kids to think are good forest activities.



US Forest Service Adventure Pass

The US Forest Service in Southern California tells volunteers

You gave, NOW GIVE MORE!

They falsely announce to the world that volunteers are exempt from the [Adventure Pass](#) and then tell them they must buy a pass if they use the forest when off duty. Many volunteers are just scraping by financially such as students, under employed, etc., and would have to borrow the money for a pass, but the

bureaucrats can not see that problem because they sit behind a desk and draw a full time government pay check. All they can see is the potential income from adventure pass sales to volunteers and every one else. It is another example of BIG Government greed and a slap in the face of people who freely give their time and personal resources to maintain the National Forest and try to make it a nice place for everyone to visit. Perhaps being that this is just one of many test programs, they are testing volunteers to see how much they will take before it hurts the rate of volunteering. If volunteer programs fall flat where they pull this trick then they will know this particular program will not work.

Did you know that many projects are done mainly by volunteer labor but the signs are set to make one believe that the labor is paid for by adventure pass money.

Services that have been performed for decades now have signs on them claiming the service is paid for by adventure pass money. For example: there is a trash dumpster at Therman Flats Picnic area that has been there since the early 1970's that got an Adventure Pass Funding sign. (That sign has been removed to prove this page untrue.)

One of the Forest Service web pages claims "The number of repeat violators of the Adventure Pass

program is very low. Of 47,000 Notices of Non-compliance issued during the past year, about 30 individuals, or 0.07% are considered repeat offenders. These individuals have three or more Notices of Non-compliance and have made no attempt to remedy the situation through payment of fees." However they refuse to ticket me in my area because they know I will not pay. In other words if they think you will not pay they will not ticket. This makes compliance appear to be higher than it really is. I have seen a FS person giving out tickets and pass my vehicle (He had heard me tell someone about the discretionary nature of the pass and commented about it to them). I got no ticket and therefore no statistic either. I know other people that do not get tickets anymore either. It seems that they have a list of do not ticket vehicles.

Most of the money collected goes to collections and enforcement. 20% goes to the treasury. Each year the treasury gets 4% more of the take. So is the second year the treasury gets 28%. That leaves about 12% of the fees to go to projects. The next year only about 8% will go to projects. This is a very bad deal for the Forest Service and us tax payers. Now Congress has cut from the FS budget the amount they collected from the demonstration fee. So they are no further ahead than if there never was a fee. They can make it appear that they have more money and can give "new" services because they cut back on waste somewhere else.

Since Congress has been cutting VERY DEEPLY into the Forest Service Budget especially since 1994 the Forest Service has been strapped for funds to the point of greatly increasing the danger of disastrous fires. They are caught in the middle on this one. Is the answer to increase the cost of volunteering?

Democrats George Miller (CA) and Earl Blumenauer (OR) are leading the charge to divert more of your taxes from the Forest Service and charging you to go on your land. Another sneaky way to increase taxes so that BIG government can get BIGGER to control you more.

Should you have to pay to inspect how your trustee is caring for your land?

Do you take care of your National Forest as if you were going to invite guests over?

- It is my opinion that they would do better to charge market value or at least charge actual costs for mining claims, grazing, and wood cutting and logging permits instead of almost giving these away. (Oh yes, these funds go into a black hole and never return to this Forest or any National Forest.) These fees are set by congress and the agency has no say in how much they will charge. Perhaps a better way would be to have a minimum fee set by congress and give the agency the option to charge as much more as their costs require.
- We need to get congress to reinstate the Forest Service share in the budget so that they can hire people instead of giving these people welfare and not letting them work. Congress should mandate that **all** use and entrance fees stay in the government service that generated the fee.
- I think that if a volunteer gives 10 to 20 hours or more of non court ordered civil service volunteer time the Forest Service should then grant that volunteer an unrestricted (usable during off time) administrative pass or an adventure pass good for one year. Some other worthy volunteers are search and rescue, sheriff citizen patrol, fire fighters etc. Many of these volunteers have to buy most of their own equipment and training. Is it fair to expect them to give more than they already are giving?

The president of a local search and rescue organization (All volunteers) informs me that they have to pay the fee while training or searching for someone in the National Forest. The Forest Service

tells me through my congressman that they do not. Who do you believe?

Other search and rescue volunteers have told me "I'm with the Sheriff's Search and Rescue team and am also irked at having to pay to hike in my call-out area. On searches and trainings we're not supposed to have to have an Adventure Pass for the forest service to waive tickets. But, we have to call them ahead and let them know so they won't do it (like they own the forest???)

"However, a lot of us like to do personal trail familiarization hikes in our call-out area and adjoining call-out areas. For those we have to have the almighty Pass."

Do you want search and rescue to be familiar with the area when your child is lost?

Most of time I have gone in to get an administrative pass to prepare for a program or class field trip, it has taken 30 to 40+ minutes to get the pass even though I called ahead. I still had to arrange to go in to the office during office hours. (April 1999 was a very fast one it only took about 5 minutes in the office.)

What can you do about it? Write e-mail to the Forest Service and your congressman is a good start. You can print out and display [protest art](#). The Forest Service claims to Congress that we the people enjoy paying these new TAXES. Have you told your congress representative the level of your GREAT joy in paying for this tax diversion?



(I do not necessarily agree with the opinions of any link.)

[Tucson Weekly](#) Said the fees are a toothless tiger.

[DoI Report to Congress](#)

[Forest Service Report to Congress](#)

[New Forest Fee is Double Billing](#) editorial by California Assemblyman BRETT GRANLUND

[Parking on state highways in National Forests](#)

[Parking on state highways in National Forests Legislative Counsel opinion](#)

["Adventure" Pass a Violation of California's Constitution?](#)

[HR786](#) Sponsored by [Rep. Bono](#) 106 congress bill will eliminate the fees in national forests

[HR2295](#) Sponsored by [Rep. Capps](#) 106 congress bill will eliminate the fees in national forests and allocate funds to the recreation budget.

E-mail links:

[US Forest Service](#)

[US Congress members](#)

[Congressional E-mail addresses](#)

[E-mail House Committee on Agriculture](#)

[Congressman Jerry Lewis 40 CA](#)

Other user fee (double tax) sites :

[Fees for the Angeles National Forest](#)

[Free Our Forests](#)

[Free Our Parks & Forests](#)

[Wild Wilderness](#)

[Who owns the land of the National Forest?](#)

This form does not send an e-mail message to me.

Tell The US Forest Service what you think about: Recreation Fee Demonstration

Your name:

Your e-mail address:

Comments:

[Matt's Script Archive](#)

Privacy Act Notice: Your name and email address are requested only so that the Forest Service can respond to your comments. Providing this information is voluntary.

If you think that I am all wet in my protest in this experimental Adventure Pass issue, drop me [John Goude](#) a line. When E-mailing do not remove the anti spam * from the subject line.

I have gladly served with the Forest Service as a Volunteer Interpretive Specialist for 5 summers mainly leading nature walks for the general public and have given school programs during the rest of the year. This means that at times I need to go into the National Forest when not giving a program to prepare. Technically I am not on duty and need a pass. Very often things I use in a program happen when I am in the National Forest not planning a program. As experienced outdoors people know, one can not plan most of these types of encounters with nature. In my thinking they make or break an interpretive presentation.

For example: One time I was backpacking on the Sugarloaf mountain in the San Bernardino mountains. During the evening we were watching the stars and a very bright meteor went streaking across the sky. It suddenly exploded and filled the moon less dark night sky with bright light! Can such a story add to a star watch when there are meteors streaking across the sky? Can

you plan such an encounter with nature?

In the ceremony on 10/26/97 where they acknowledged the other volunteers including many of the ones planning on not being present, the Forest Service decided to single me out and refused to publicly acknowledge any of my volunteer time, of about 100 hours. After the ceremony I was told it was because of my non public protest of volunteers having to buy Adventure Passes. Up to that time I had kept my protest to be within the organization. I have now gone public with this page because of this move on their part.

As the bumper sticker a fellow volunteer gave me says:

Can't see the forest for the fees

I invite you to check out the rest of my internet site for [Dining on the Wilds](#). Copyright © 1997, 1998, 1999

[John Goude](#)

When E-mailing do not remove the anti spam * from the subject line.

Recreation Fee Pilot Project Adventure Pass protest art

Click on the picture for a larger printable view.



The Forest Service threatened me with legal action unless I removed "Smokey the Bandit". So he is no longer available.

[Adventure Pass](#)





**The courts have ruled
that the
ADVENTURE
PASS
is
Discretionary
(optional)
I choose not to DISPLAY
this NEW TAX**



**Yum! Yum!
Endangered
Wild Flowers !**

**\$1.35
month**

**Recreation
Fee Pilot
Project**

Humans \$5.00 a day

Granlund's position confirmed on Nat'l Forest Adventure Pass

from The Valley Messenger, November 1998, Vol. 25, No. 11 (used by permission)

Assemblyman Brett Granlund (R – Yucaipa), announced that he has received a legal opinion from the California Legislative Counsel that confirmed his position that California residents do not have to have a National Forest Adventure Pass to park on the state highways right-of-ways within a national forest.

Granlund's 65th Assembly District, including Big Bear City, Running Springs, Angelus Oaks and other communities in and around the San Bernardino National Forest, has received hundreds of telephone calls and a petition that contained more than 8,000 signatures from residents and visitors complaining about the new unfair taxation.

The National Adventure Pass program requires a \$5 daily, or \$30 annual, pass for any vehicle that is parked along the roadway to display the pass in their vehicle.

Granlund said the opinion stated: "The Forest Service of the United States Department of Agriculture may not issue a citation for a violation of the fee provisions of the federal Recreational Fee Demonstration Program for a vehicle that is parked on the right-of-way of a portion of State Highway Route 38 within certain National Forests without displaying a National Forest Adventure Pass, unless there are additional facts indicating that a recreational use of the forest has occurred."

The opinion gave an example that persons driving on State Highway 38 from Big Bear City en route to the City of Redlands could have their vehicles break down on the state highway right-of-way within the forest and leave the vehicles in order to search for assistance.

Another example Counsel Gregory cited was a person who might become drowsy while driving through the forest, park his or her vehicle by the side of the highway and go for a walk in order to stir himself or herself awake, all without leaving the highway right-of-way.

During this year's Legislative session, Granlund authored a resolution that requested that the U.S. Congress rescind the Forest Service's authority to sell passes and issue \$100 citations to violators of the program.

Assembly Joint Resolution (AJR) 77 encourages the president and the Congress of the United States to enact the Forest Tax Relief Act, authored by Representative Mary Bono. AJR 77. was unanimously passed by the state Assembly and Senate and approved by the governor.

The opinion said that, at a minimum, any citation would need to include additional facts indicating that a recreational use of the forest has occurred, such as: a statement that the alleged violator was observed walking into the forest after having parked the vehicle.

Granlund said that the opinion cited a similar case addressed by a federal court, (*U.S. vs. Maris*) where the court held that merely driving through a national forest was not a recreational use.

Granlund said this opinion was valid on any state road through all national forest land and

Highway 38 was only used as an example. He also said that it is the job of the Forest Service to prove that a recreational use happened. To the best of his knowledge, the U.S. Forest Service and the State of California have never signed any agreement on this issue.

"This fee program," said Granlund, "is a recreational pass and not a vehicle pass. It is the obligation of the Forest Service to give citations to people not vehicles."

[Adventure Pass](#)

Legislative Counsel of California

Highways: San Bernardino National Forest - #16919

Dear Mr. Granlund:

QUESTION

May the Forest Service of the United States Department of Agriculture issue a citation for a violation of the fee provisions of the federal Recreational Fee Demonstration Program for a vehicle that is parked on the right-of-way of a portion of State Highway Route 38 within the San Bernardino National Forest without displaying a National Forest Adventure Pass?

OPINION

The Forest Service of the United States Department of Agriculture may not issue a citation for a violation of the fee provisions of the federal Recreational Fee Demonstration Program for a vehicle that is parked on the right-of-way of a portion of State Highway Route 38 within the San Bernardino National Forest without displaying a National Forest Adventure Pass, unless there are additional facts indicating that a recreational use of the forest has occurred.

ANALYSIS

Section 315 of Title III of the Omnibus Consolidated Rescissions and Appropriations Act of 1996 (P.L. 104-134; hereafter Section 315) requires the United States Secretary of Agriculture (hereafter the secretary), acting through the Forest Service of the United States Department of Agriculture (hereafter the Forest Service), to implement, until September 30, 1999, a Recreational Fee Demonstration Program (hereafter the demonstration program) on selected federal lands to demonstrate the feasibility of user-generated cost recovery for the operation and maintenance of recreational areas on those lands (Sec. 315(a) and (f)). Under the demonstration program, the secretary is required to charge and collect fees for admission to, or for the use of, the selected outdoor recreation sites (Sec. 315(b)(1)) and to establish those fees based upon a variety of cost recovery and fair market valuation methods (Sec. 315(b)(2)). The fees are imposed in lieu of fees charged under any other provision of law (Sec. 315(d)(2)). Eighty percent of the amount collected under the demonstration program is required to be used for activities at the site from which the funds are collected and 20 percent is required to be used by the agency that administers the site (Sec. 313(c)(1)(A) and (3), and (c)(2)(A) and (B)).

The secretary is authorized to assess a fine of not more than \$100 for any violation of the demonstration program's fee provisions (Sec. 315(b)(5)). Section 261.15 of Title 36 of the Code of Federal Regulations (hereafter Section 261.15) makes it a crime, punishable by a fine of not more than \$100, to fail to pay any fee established for admission or entrance to, or use of, any national forest site, facility, equipment, or service furnished by the United States. Thus, failure to pay a fee imposed under the demonstration program is prosecutable as a violation of Section 251.15.

The Forest Service has informed us that in the San Bernardino National Forest (hereafter the forest), among other national forests in southern California, it has implemented the demonstration program as the Southern California fee Demonstration Project (hereafter the project). Under the project, fees are collected through the issuance of a "National Forest Adventure Pass" (hereafter the pass). According to the official literature of the Forest Service describing the project, the pass is issued as a daily pass for \$5 or an annual pass for \$30, and is required to be displayed on a vehicle only when the vehicle is parked within the forest for recreational purposes. The Forest Service enforces the fee provisions of the project by posting a citation on vehicles found not displaying the pass in violation of the project's fee provisions.

The citation issued to enforce the project's fee provisions provides for identification of the issuing officer, the alleged violator (hereafter the person), and the person's vehicle, describes the offense, and provides a space for the officer to describe the location of the vehicle. The offense is described in a "Description" section with two sentences that read: "This vehicle is not displaying a valid National Forest Adventure Pass as required by the Southern California Fee Demonstration Project. This Project is authorized by Section 315 of Public Law 104-134." A set of instructions provided on the citation inform the person that he or she has 14 days to correct the violation and that failure to correct may result in a fine of not more than \$100. According to the instructions, the person may correct the violation by re returning the notice to the project headquarters in San Bernardino with (1) a daily pass, (2) certain evidence of possession of an annual pass, (3) the purchase price of a daily pass, or (4) an explanation supporting the contention that the citation was issued in error.

An issue that arises at this point is whether a citation may be imposed for failure to display a pass, in view of the fact that both Section 315 and Section 261.15 authorize punishment for failure to pay certain fees, but not expressly for failure to redisplay a pass. In that regard, it has been held that the power of an administrative agency to administer a congressionally created and funded program necessarily requires the formulation of policy and the making of rules to fill any gap left, implicitly or explicitly, by Congress (*Morton v. Ruiz* (1974) 39 L.Ed.2d 270, 292). If a court determines that Congress has not directly addressed the pre issue question at issue, or that the statute is silent or ambiguous with respect to the specific issue, the question for the court is whether the agency's answer is based on a permissible construction of the statute (*Chevron U.S.A. v. Natural Res. Def. Council* (1984) 81 L.Ect.2d 694, 703).

Nothing in either Section 315 or Section 261.15 prescribes the method for enforcing the fee provisions of the demonstration program. Thus, applying the holdings set forth above, our view is that any reasonable method of enforcing the fee provisions that is consistent with the purposes of the demonstration program would be authorized. Because the literature distributed by the Forest Service advises purchasers of the pass that the pass is to be displayed on the purchaser's vehicle, we think that it is reasonable for the Forest Service to deem the failure to display the pass when parked within the forest for recreational purposes to be rebuttable evidence that the pass was not purchased and that, consequently, the fee was not paid. Accordingly, we conclude that the Forest Service's decision to enforce the fee provisions of the project by requiring the purchase and display of a pass is reasonable and, there ore, authorized.

However, citing a vehicle for a violation of the project's fee provisions when the vehicle is parked on the right-of-way of State Highway Route 38 raises the question of whether probable cause exists for that issuance. There is no provision of federal law that sets forth the standard of probable

cause for issuing the citations in question. However, the procedure and practice for the conduct of proceedings involving petty offenses, such as a violation of the project's fee provisions, (*1) is governed by Rule 58 of the Federal Rules of Criminal Procedure (Fed. Rules Cr. Proc., Rule 58, 18 U.S.C.A.; hereafter Rule 58). Under that procedure, a trial is authorized to proceed on an indictment, information, or complaint, in the case of a misdemeanor, or on a citation or violation notice in the case of a petty offense (Rule 58(b)(1)). Thus, at the initial stage of federal criminal procedure for petty offenses, a citation serves the same function as a complaint; that is, it provides support for the decision to continue prosecuting the alleged offense (see *Jaben v. U.S.* (1965) 14 L.Ed.2d 345, 353). Therefore, we think that the standards established for probable cause to issue a complaint are applicable to citations.

The United States Supreme Court has stated that a complaint must provide the affiant's answer to the magistrate's hypothetical question, "What makes you think that the defendant committed the offense charged?" (Ibid.). The complaint is required to present enough information to enable a judgment that the charges are not capricious and are sufficiently supported to justify bringing into play the further steps of the criminal process (Ibid.). At a minimum, the complaint is required to follow the statutory language describing the offense charged and relate the essential facts constituting that offense (*Bytes v. U.S.* (9th Cir. 1964) 327 F.2d 825, 835).

The offense in question is utilizing the recreational facilities of the forest without having paid the recreational use fee. The essential elements of the offense are that (1) a vehicle has been parked (2) within the forest (3) for a recreational purpose (4) without displaying a pass.

When a vehicle is found parked without a pass on, for example, a forest road, a campground, or a trailhead parking lot, the third element listed above is supported by the reasonable inference that the purpose for parking the vehicle at that location was to use the recreational facilities of the forest.

However, in the case of parking within the forest on the right-of-way of State Highway Route 38, which is a major artery through the area, that presumption is much less supportable because there are many possible alternative explanations for having parked at that location. A person driving on State Highway Route 38 from Big Bear City en route to the City of Redlands, for example, with no intention of using the recreational facilities of the forest, could have his or her vehicle break down on the state

highway right-of-way within the forest and have to leave the vehicle in order to search for assistance. As another example, a person might become drowsy while driving through the forest, park his or her vehicle by the side of the highway, and go for a walk in order to stir himself or herself awake, all without ever leaving the highway right-of-way.

Therefore, it is our view that probable cause to issue a citation is not present on the basis that the vehicle is parked within the forest on the right-of-way of State Highway Route 38, because the circumstance above does not support the element of the offense requiring recreational use of the forest. We think that, at a minimum, the citation would need to include additional facts indicating that a recreational use of the forest has occurred, such as, for example, a statement that the alleged violator was observed walking into the forest after having parked the vehicle.

A similar question was addressed by a federal district court in a recent case, where the court held that merely driving through a national forest area on a public highway was not a recreational use of that area and was, therefore, not subject to the exaction of the demonstration program's user fee (U.S. v. Maris (D.Or. 1997) 987 F.Supp. 865, 868).

In the Maris case, the defendants entered the Oregon Dunes National Recreation Area of the Siuslaw National Forest by driving on South Jetty Road, a public highway, en route to accessing public coastal lands (Ed., at p. 866). There was no evidence that the defendants used the forest in any way other than driving on South Jetty Road to get through the forest to their destination (ibid.). The defendants were charged with violating Section 261.15 by failing to pay, upon entering the national forest, the user fees imposed under the demonstration program (Ibid.).

The district court construed the language of Section 315 as granting authority that is limited to recreational use fees and may not be extended to include imposing tolls for the use of public highways that run through forest lands (Id., at p. 867). The court also found that, in any case, imposition of those tolls would be prohibited under former Section 932 of Title 43 of the United States Code (hereafter Section 932) on South Jetty Road because that route was established prior to October 21, 1976 (Id., at pp. 867-868). Section 932, which remains in effect for those rights-of-way existing prior to October 21, 1976, granted the right-of-way for the construction of highways over public land not reserved for public use and thus prohibits tolls on those preexisting rights-of-way (Ibid.).

The facts in the question presented here are similar to those present in the Maris case, that is, State Highway Route 38 is a public highway and the activity in question is parking on that highway at a location that is within the forest, an apparently nonrecreational use of the forest that is similar to the one at issue in the Maris case. We think that a court faced with those facts, and nothing more, would find that parking on a public highway on a location that is within a national forest is not itself a recreational use for which a fee is authorized under Section 315

Accordingly, it is our opinion that the Forest Service of the United States Department of Agriculture may not issue a citation for a violation of the fee provisions of the federal Recreational Fee Demonstration Program for a vehicle that is parked on the right-of-way of a portion of State Highway Rout 38 within the San Bernardino National Forest without displaying a National Forest Adventure Pass, unless there are additional facts indicating that a recreational use of the forest has occurred.

Very truly yours,
Abel Munoz
Deputy Legislative Counsel

(*1) A "petty offense" is defined as, among other things, an infraction for which the maximum fine is not greater than \$5,000 (18 U.S.C.A. Secs. 19 and 3571(b)(6) and (7)). Because a violation of the project's fee provisions is punishable by a fine o not more than \$100 (Sec. 315(b)(5); see also 36 C.F.R. 261.15), we conclude that it is a "petty offense" under the Federal Rules of Criminal Procedure.

Privacy Statement for Dining on the Wilds

Dining on the Wilds has created this privacy statement in order to demonstrate our firm commitment to privacy. The following discloses the information gathering and dissemination practices for this Web site: [Dining on the Wilds](#)

Information Automatically Logged

We use your IP address to help diagnose problems with our server and to administer our Web site. Your IP address is also used to gather broad demographic information.

- We check your country
- Day and time of visits
- Your operating system type
- Browser type and version

so that we can make this site work for the most number of people. We do not keep these records they go to make an overall picture of the use of this web site.

Cookies

We DO NOT set or read cookies in your computer. Any cookies requested from this site are from advertisers.

We prefer to surf the Internet with cookies turned off (except to selected sites) and encourage you to do the same.

Advertisers

We use an outside ad company to display ads on our site. These ads may contain cookies. Currently we do not use cookies in other parts of our web site. Cookies received with banner ads are collected by our ad company, and we do not have access to this information.

External Links

This site contains links to other sites. **Dining on the Wilds** is not responsible for the privacy practices or the content of such Web sites.

E-mail addresses

We have forms that require E-mail addresses.

1. These addresses are used only to reply to messages sent to us.
2. We do not put them in address books where viruses might get to them.
3. The address or name is not put on a mass mailing list or sold to anyone.
4. If you do not mind us putting your E-mail address in an address book or mailing list please use an E-mail link.

5. This site has one form that sends e-mail messages to the US Forest Service E-mail comments address. We do not know what you send or keep a record of the number of messages sent.

Choice/Opt-Out

1. You can send email to info@edibleplants.com
When E-mailing do not remove the anti spam * from the subject line.
2. You do not need to fill out any form on this web site.

Data Quality/Access

This site gives users the following options for changing and modifying information previously provided:

1. You can send email to info@edibleplants.com
When E-mailing do not remove the anti spam * from the subject line.

Contacting the Web Site

If you have any questions about this privacy statement, the practices of this site, or your dealings with this Web site, you can contact:

info@edibleplants.com

When E-mailing do not remove the anti spam * from the subject line.

Generated by [Privacy Wizard](#)



If you became stranded or lost in the wilderness, would you starve?
Click here to learn about wild plants you can eat and enjoy.
Dining on the Wilds a six session video course.



Medical Search Engine
Medline, Cochrane, Trip & more
Global Research Monitor



www.medndx.com

LinkExchange



WHY STUDY WILD EDIBLE PLANTS

1. SURVIVAL

If you were lost in the wilderness for a long time would you survive? With the current enthusiasm for backpacking and wilderness living, there is an increased probability of people getting lost. If you were lost in the wilderness would you starve? People have starved to death while tramping on hundreds of wild edible plants. This could happen to anyone if they had no knowledge of what to eat in the wilds. Don't let this happen to you!

2. DISASTER

If you were cut off by a natural disaster or civil unrest from getting food from the market, would you go hungry? During war many people have survived from lack of their normal food because they knew about wild edible plants. I know a German lady who ate many dandelions during World War II, and the Finnish used cambium of trees to stretch their flour supply.

3. BACKPACKING and WILDERNESS OUTINGS

One way to cut down weight on that backpack trip is to depend on wild edibles for a portion of your food. After days of dehydrated food--a fresh wild salad is a real treat! Do you really like **MREs** (meals ready to eat) anyway? I find that looking for plant friends as I walk along keeps my mind active and makes the walk even more enjoyable. While you are out there exploring, why not explore with your taste buds too. (note: some wilderness areas and parks have strict restrictions on picking any plant. Check with the proper people before picking plants.)

4. ECONOMY

With supermarket prices so high, wild edible plants can be a great budget stretcher, and who doesn't like something **free**.

5. NUTRITION

Wild edible plants are so rich in vitamins and minerals that they have been called a tonic rather than a food. Some of these plants are richer sources of nutrients than domestic plants.

6. ECOLOGY

You will become more aware of ecology which is discovering how the life cycle of plants relates to the life

cycles of other plants and animals. Hopefully, you will also become a conservationist and perhaps even a gardener.

7. HISTORY

You will have more appreciation for the Native American's old ways and want to help keep some of these ways alive through the study of ethnobotany.

8. MEDICINAL

With herbal medicine gaining in popularity it is beneficial to learn not only the edible properties of a plant but also its medicinal value. You might also find yourself in a situation where no doctor is available. Not only is your health benefited but also your pocketbook!

9. VARIETY

So if you are tired of eating the same foods week after week wild edible plants can add a pleasant change to your menu. You will have fun discovering a greater depth of food flavors as you eat more and more wild edible plants.

10. GOURMET

Wild edible plants can be made into exotic gourmet dishes. If you want to do something different have a "wild" party and invite your neighbors in. They will be amazed at how delicious your wild edibles can be.

11. HOBBY

Studying wild edible plants is a very fascinating hobby. With 300,000 plants in the world and 120,000 considered edible you won't run out of something to do for a long time. You will become attuned to the wild plants that are edible and will look upon them as friends.

12. SPIRITUAL

Nature study is an excellent way to learn about the Creator and is very restful to the soul who will take the time to listen to Him through the things He made.



[Order](#)



[Home](#)



[Books](#)



Copyright © 1996, 2001 [John Goude](#)

JEG Development

When E-mailing do not remove the anti spam * from the subject line.

Wild Edible Plants.

Dining on the Wilds

"They are pulling the wool over **your** eyes.
The issue is the new '[Adventure Pass](#)' initiated by the United States
Forest Service, and the victims are the taxpayers. "
California Assemblyman BRETT GRANLUND



"The government's decision to not prosecute violators seems to confirm that the fee
demonstration program is essentially a toothless tiger which the public can eradicate."
[Tucson Weekly](#)

NEW SHAREWARE [spelling dictionaries](#) in the books section

Dining on the Wilds

Learning Nature through Wild Edible Plants and Ethnobotany



This set of pages will give you . . .

1. [WHY?](#) learn wild edible plants
2. [DESCRIPTION](#) of the video course
3. [Table of contents](#)
4. [WHO](#) made it?
5. [OTHERS](#) say
6. [Cover](#) (25KB)
7. How to [ORDER](#)



Dining on the Wilds

- Takes you inside the classroom for an interesting graphic slide presentation which gives you a close-up look at the identification of many wild edible plants, herbs and mushrooms of North America.
- Come along on live field trips. Observe and enjoy plants in their natural habitat. Learn how to use these natural, nutritive items.
- Taste the fun of a cooking class where unique recipes are demonstrated. You are in for a truly mouth watering treat.
- Watch the fun as students bring family and friends to a gourmet buffet where everyone brings home made dishes containing at least one wild ingredient.
- Listen to student comments as to why they enrolled in the class and why some have come back repeatedly.
- This video set is a unique, fun and educational experience that your whole family will enjoy viewing over and over again.

[Others say](#)

I have thoroughly enjoyed Dining on the Wilds. The tapes have been a great help. They are very informative.
...

Sincerely,
Susie Teague
[Cedar Creek Nature Studies](#)

[\[Why learn wild edible plants?\]](#)[\[Table of contents \]](#) [\[About the presenters\]](#)[\[Cover 25KB\]](#)



Dining on the Wilds **is brought to you by**



Miriam Darnall-Kramer [18K]

- Author of Wild Plants to Eat correspondence course and 6 other related courses.
- Co-author of Wild Plants to Eat workbook and slide set.
- Associate director of the former International Wilderness Club.
- Extensive classroom and field experience teaching about wild edible plants in 27 states, Canada and Peru.
- Listed in Who's Who in American Women.
- Secretary-treasurer of Forage Ahead.



John Goude[16K]

- Has studied wild edible plants for 28 years in 12 states.
- Has taught wild edible plants in 7 states.
- San Gorgonio Wilderness Assoc. interpretive specialist, (on strike) in wild edible plants.
[Hug-A-Tree and Survive teacher](#)
- [Rabbitstick rendezvous](#) of Society for Primitive Technology teacher.
- President of Forage Ahead, a wild edible plant enthusiasts club.
- Has cataloged and cross indexed over 500 North American wild edible plants.
- Served as president of Riverside California Chapter of International Wilderness Club.

[\[Dining on the Wilds top \]](#) [\[Reasons to learn Wild edible plants\]](#) [\[Table of contents\]](#)[\[Cover25KB\]](#)

1



Tell us what you think:

Required fields = *

Your name: *

Your e-mail address: *

Comments:

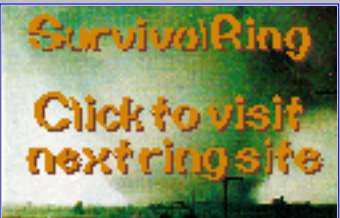
	<p>This SurvivalRing site is owned by John Goude.</p> <p>Want to join the SurvivalRing?</p>	
<p>[Skip Prev][Prev][Next][Skip Next][Random][Next 5][List Sites][Home]</p>		



(Reset date July 1, 1997)

Copyright © 1996-2001 John Goude
webmaster@edibleplants.com

When E-mailing do not remove the anti spam * from the subject line.

If you would like to use something on this site please E-mail a request to use it. So far almost all requests made before use have been granted. It is nice to know when we have helped someone else get their message out.

Dining on the Wilds

Table of Contents

Six professional videos with views of over 300 North American wild plants

Tape 1

Type	Section title	Time
Slide Set	<u>Edible Wild Plants of the Yard</u>	36:20
Demonstration	Threshing	4:38
Slide Set	<u>Herbs</u>	7:20
	Interviews	2:45

Tape 2

Slide Set	<u>Edible Wild Plants of the Roadside and Meadows</u>	31:09
Slide Set	<u>Edible Wild Plants of the Northwest</u>	6:42
Demonstration	Yucca	3:51
Lecture	Primitive Cooking	5:00
Field Identification	Yard & Roadside	15:15

Tape 3

Lecture	Eating Wild Plants Safely and Edibility Rules	11:41
Slide Set	<u>Edible Wild Plants of the Woodlands</u>	44:24
Demonstration	Acorn Processing	3:44
Field Identification	Mountains Spring	11:00

Tape 4

Slide Set	<u>Edible Wild Plants of the Desert</u>	29:55
Demonstration	But Prickly Pears have Spines	3:08
Slide Set	<u>Edible Wild Plants of the Mountains</u>	11:24
Demonstration	Utilizing Edible Wild Plants	16:27

Tape 5

Slide Set	<u>Edible Wild Plants of the Sea Coast</u>	10:49
Slide Set	<u>Edible Wild Plants of Wet Places</u>	12:44
Demonstration	Cattails are the Supermarket	3:38
Slide Set	<u>Poisonous Plants</u>	19:30
Lecture	Avoiding Plant Poisonings	3:55

Tape 6

Slide Set	Edible Wild Plants of the Eastern and Central North America	36:34
Slide Set	Edible Wild Mushrooms	8:45
Demonstration	Eat Your Flowers too	9:00
	Wild Banquet	7:43

[\[About the presenters\]](#)

[\[Cover 25KB\]](#)



[Order](#)



[Home](#)



[Books](#)

Copyright © 1996-1998 John Goude webmaster@edibleplants.com

When E-mailing do not remove the anti spam * from the subject line.

Edible Wild Plants of the Yard

WARNING: A plant on the list just means that it is discussed on the video. This does not mean that it is edible. Some plants in an edible list are toxic until prepared correctly or have toxic parts. **KNOW before you eat !**

Dandelion

Plantain
Narrow leaf plantain
Clover
Grass
Wild oats
Foxtail barley
Curly dock
Sour dock
Dock
Sheep sorrel
Lady's thumb
Lambsquarters
Strawberry blite
Orach

Amaranth

Domestic Amaranth
Wild lettuce
Prickly wild lettuce
Sow thistle

Chickweed

Mustard
Winter cress
Wild radish
Shepherd's purse
Peppergrass
Mallow

Purslane

Filaree
Russian thistle

Taraxacum officinale

Plantago major
Plantago lanceolata
Trifolium, Medicago species

Avena fatua
Setaria SPP
Rumex crispus
Rumex
Rumex
Rumex acetosella
Polygonum SPP
Chenopodium album
Chenopodium capitatum
Atriplex patula

Amaranthus

Amaranthus
Lactuca tatarica
Lactuca serriola
Sonchus asper

Stellaria media

Brassica rapa
Barbarea
Raphanus sativus
Capsella bursa-pastoris
Lepidium virginicum
Malva neglecta

Portulaca oleracea

Erodium cicutarium
Salsola iberica, Kali tenuifolia

Remember, YOU are a caretaker of these plants.

[\[Return\]](#)

Herbs

WARNING: A plant on the list just means that it is discussed on the video. This does not mean that it is edible. Some plants in an edible list are toxic until prepared correctly or have toxic parts. **KNOW before you eat !**

Yarrow	<i>Achillea millefolium</i>
Chamomile	<i>Matricaria chamomilla</i>
Purple cone	<i>Agustifolia purpurea</i>
Gill over the ground .	<i>Glecoma hederacea</i>
Mullein	<i>Verbascum thapsus</i>
Yerba santa	<i>Eriodictyon californicum</i>
Eucalyptus	<i>Eucalyptus SPP</i>
Horsetail	<i>Equisetum SPP</i>
Oregon grape	<i>Mahonia (Berberis)</i>
Yerba Buena	<i>Satureja douglasii</i>
Bearberry	<i>Arctostaphylos uva-ursi,rubra,alpin</i>
Ginkgo biloba	<i>Ginkgo biloba</i>
Mugwort	<i>Artemisia</i>
Mountain misery	Chamaebatia foliolosa

Remember, YOU are a caretaker of these plants.

[\[Return\]](#)

Edible Wild Plants of the Roadside and Meadows

WARNING: A plant on the list just means that it is discussed on the video. This does not mean that it is edible. Some plants in an edible list are toxic until prepared correctly or have toxic parts. **KNOW before you eat !**

Cleavers	<i>Galium aparine</i>
Stinging nettle	<i>Urtica gracilis</i>
Watercress	<i>Nasturtium officinale</i>
Brooklime	<i>Veronica americana SPP</i>

Monkey flower	Mimulus guttatus
Chicory	Cichorium intybus
Salsify	Tragopogon SPP
Queen Anne's lace	Daucus carota
Fireweed	Eqilobium angustifolium, latifolium
Evening primrose	Primula SPP
Thistle	Cirsium SPP (31)
Milk thistle	Silbum marianum
Wild onions	Allium
Burdock	Arctium minus, lappa
Milkweed	Asclepias
Jerusalem artichoke	Helianthus tuberosus
Day lily	Hemerocallis aurantiaca
Vetch	Vicia SPP
Chia	Salvia columbariae
California Bay	Umbellularia californica
Sage (black/blue)	Salvia mellifera
Horehound	Marrubium vulgare
Hottentot Fig	Mesembryanthemum edule
Ice plant	Capobrotus edule
Tarweed	Madia glomerata, sativa
Sunflower	Helianthus annuus
Wild aster/Oxeye daisy	Aster ledophyllus
Goldenrod	Solidago missouriensis
Pineappleweed	Matricaria matricarioides
Chamomile	Anthemis SPP
Mullein	Verbascum thapsus
Asparagus	Sagittaria SPP, Asparagus officinalis

Remember, YOU are a caretaker of these plants.

[\[Return\]](#)

Edible Wild Plants of the Northwest

WARNING: A plant on the list just means that it is discussed on the video. This does not mean that it is edible. Some plants in an edible list are toxic until prepared correctly or have toxic parts. **KNOW before you eat !**

Avalanche lily	Erythronium grandiflorum ssp.
Yellow bells	Fritillaria pubica
Bear grass	Xerophyllum tenax
Strawberry blite	Chenopodium capitatum
Skunk cabbage	Lysichiton americanum
Devil's club	Echinopanax horridum or(Oploanax h)
Clitonia	Clintonia borealis
Twist stalk	Streptopus SPP
Buffaloberry	Shepherdia SPP
Bunch berry	Cornus canadensis
Mountain ash	Sorbus SPP (Pyrus)
Salal	Gaultheria shallon
Bearberry	Arctostaphylos uva-ursi,rubra,alpin
Licorice	Glycyrrhia lepidota

Remember, YOU are a caretaker of these plants.

[\[Return\]](#)

Edible Wild Plants of the Woodlands

WARNING: A plant on the list just means that it is discussed on the video. This does not mean that it is edible. Some plants in an edible list are toxic until prepared correctly or have toxic parts. **KNOW before you eat !**

Violet	Viola purpurea, pedunculata SPP
woodsorrel	Oxalis SPP
Bracken fern	Pteridium aquilinum
Wild ginger	Asarum SPP
Miner's lettuce	Claytonia perfoliata (Montia)
Lomatium	Lomatium SPP

Brodiaea	Brodiaea pulchella	
Mariposa lily/fairy lantern/star tulip	Calochortus nuttallii,gunnisonii	
Lily	Lilium Pardalinum	
Solomon's seal	Polygonatum SPP	
False Solomon's seal	Smilacina SPP	
Trillium	Trillium ovatum SPP (4)	
Shooting stars	Dodecatheon hendersonii	
Alum root	Heuchera SPP (28)	
Waterleaf	Hydrophyllum occidentale	
Indian paintbrush	Castilleja	
Horsetail	Equisetum SPP	
Spearmint	Mentha spicata	
Peppermint	Mentha piperita	
Pennyroyal	Hedeoma pulegioides	
Coyote mint	Monardella villosa	
Henbit	Lamium amplexicaule	
Field mint	Mentha	
Rose	Rosa californica, arkansana	
Redbud	Cercis occidentalis	
Sumac	Rhus hirta, typhina,glabra,copallina	
Squawbush	Rhus trilobata	
Lemonade berry	Rhus integrifolia	
Sugarbush	Rhus ovata	
Manzanita	Arctostaphylos	
Wild strawberry	Fragaria virginiana	
Raspberry	Rubus Leucodermis	
Thimbleberry	Rubus parviflorus	
Blackberry	Rubus	
Blueberry	Vaccinium occidentale	
Serviceberry	Amelanchier SPP (24)	
Toyon	Heteromeles arbutifolia	
Currant	Ribes SPP	
Gooseberry	Ribes roezlii, velutinum	
Mulberry	Morus SPP	
Western snowberry.	Symphoricarpos occidentalis SPP	The eastern species causes vomiting (Symphoricarpos albus)

Barberry	<i>Crataegus berberifolia</i>
Oregon Grape	<i>Mahonia (Berberis)</i>
Grape	<i>Vitis californica</i> , SPP
Elderberry	<i>Sambucus melanocarpa</i> , <i>mexicana</i>
Hawthorne	<i>Crataegus</i> SPP
Hackberry	<i>Celtis douglasii</i> , <i>pallida</i>
Pin Cherry	<i>Prunus pensylvanica</i>
Sour Cherry	<i>Prunus cerasus</i>
Holly leaf Cherry	<i>Prunus ilicifolia</i>
Chokecherry	<i>Prunus virginiana</i>
Indian plum	<i>Oemleria cerasiformis</i>
Cascara/coffeeberry	<i>Rhamnus californica</i> , <i>purshiana</i>
Deer bush	<i>Ceanothus</i>
Aspen	<i>Populus</i> SPP
Willow	<i>Salix</i> SPP
Maple	<i>Acer</i> SPP
Butternut	<i>Juglans cinerea</i>
Hazel nut	<i>Corylus cornuta</i> , <i>americana</i>
Chinquapin	<i>Castanopsis</i> <i>chrysophylla</i> , <i>sempervire</i>
	<i>Chrysolepis sempervirens</i>
Digger pine	<i>Pinus sabiniana</i>
Sugar pine	<i>Pinus lambertiana</i>
Pinyon pine	<i>Pinus</i> <i>monophylla</i> , <i>quadrifolia</i> , <i>edulis</i>
White oak	<i>Quercus alba</i>
Black oak	Quercus kelloggii
Live oak	<i>Quercus chrysolepis</i>

Remember, YOU are a caretaker of these plants.

[\[Return\]](#)

Edible Wild Plants of the Desert

WARNING: A plant on the list just means that it is discussed on the video. This does not mean that it is edible. Some plants in an edible list are toxic until prepared correctly or have toxic parts. **KNOW before you eat !**

Prickly pear	Opuntia SPP
Cholla	Opuntia SPP
Barrel cactus	Ferocactus acanthodes, Echinocactus
Organ pipe/ apple/ saguaro cactus	Lemaireocereus thurberi(organ)/Cereus giganteus (Sagaro)
Ocotillo	Fouquieria splendens
Joshua tree	Yucca brevifolia
Yucca;	Yucca SPP
Nolina	Nolina bigelovii, microcarpa
Agave	Agave SPP (10)
Juniper	Juniperus SPP
Jojoba	Simmondsia chinensis
Desert willow	Chilopsis linearis
Palo verde	Cercidium floridum
Honey mesquite	Prosopis glandulosa
Screwbean mesquite	Prosopis pubescens
Ironwood	Olneya tesota
Catclaw/Acacia	Acacia SPP
Desert apricot	Prunus fremontii
Fan palm	Washingtonia filifera
Date palm	Phoenix SPP
Ephedra	Ephedra SPP
Cresote bush	Larrea divaricata
Bladder pod	Isomeris ardorea
Chuparosa	Beloperone californica
Apricot Mallow	Sphaeralcea ambigua
Wild parsley	
Tansy mustard	Descurainia pinnata
Tumbling mustard	Thelypodopsis SPP
Prince's plume	Stanleya elata, pinnata
Desert candle	Caulanthus crassicaulis
Black sage	Salvia mellifera
White sage	Salvia apiana
Blue sage	Salvia
Desert lavender	Hyptis emoryi
Indian paintbrush	Castilleja
Pincushion	Coryphanta vivipara

Blazing star	<i>Liatris punctata</i>
Desert lily	<i>Hesperocallis undulata</i>
Coyote gourd	<i>Cucumrbita foetidissima</i>
Desert sunflower	
Buckwheat	<i>Eriogonum fasciculatum</i>
Desert trumpet	<i>Eriogonum inflatum</i>
Wild rhubarb	<i>Rumex hymenosepalus</i>

Remember, YOU are a caretaker of these plants.

[\[Return\]](#)

Edible Wild Plants of the Mountains

WARNING: A plant on the list just means that it is discussed on the video. This does not mean that it is edible. Some plants in an edible list are toxic until prepared correctly or have toxic parts. **KNOW before you eat !**

Camas	<i>Camassia quamash, scilloides</i>
Marsh marigold	<i>Caltha SPP (20)</i>
Green gentian	<i>Frasera speciosa</i>
Yampah	<i>Perideridia gairdneri</i>
Bistort	<i>Ramalina bistorta</i>
Solomon's seal	<i>Polygonatum SPP</i>
False Solomon's Seal	<i>Smilacina SPP</i>
Bitterroot	<i>Lewisia redivia</i>
Balsam root	<i>Balsamorhiza</i>
Fritillary	<i>Fritillaria SPP (19)</i>
Sierra primrose	<i>Oenothera SPP</i>
Snowplant	<i>Sarcodes sanguinea</i>
Orchids	<i>Habenaria SPP</i>
Broomrape	<i>Boschniaka SPP, Orobanche SPP</i>
Cow parsnip	<i>Heracleum lanatum, maximum</i>
Angelica	<i>Angelica SPP</i>
Sweet cicely	<i>Osmorhiza SPP</i>
Honeysuckle	<i>Lonicera SPP</i>
Sierra gooseberry	<i>Ribes roezlii, velutinum</i>
Dudleya or live forever . .	<i>Dudleya saxosa</i>
Soap plant	<i>Chlorogalum SPP</i>

Remember, YOU are a caretaker of these plants.

[\[Return\]](#)

Edible Wild Plants of the Sea Coast

WARNING: A plant on the list just means that it is discussed on the video. This does not mean that it is edible. Some plants in an edible list are toxic until prepared correctly or have toxic parts. **KNOW before you eat !**

Nasturtium	Tropaeolum majus
Candy flower	Montia sibirica
Monkey flower	Mimulus guttatus
Sea rocket	Cakile maritima, edentula
Toothwort	Dentaria SPP (4)
Rock cress	Arabidopsis Heynh
New Zealand spinach	Tetragonia tetagonioides
Red maids	Calandrinia ciliata
Glasswort	Salicornia subterminalis
Arrow grass	Triglochin SPP
Saltbush	Atriplex SPP
Sea blite	Suaeda californica
Ice plant	Gasoul
Coltsfoot	Crystallinum(Mesembryanthemu
Pennywort	Petasites SPP
Redwood sorrel	Rumex
Pitcher sage	Salvia azurea
Wild celery	Angelica lucida
Fennel	Foeniculum vulgare
Wild rye	Elymus tritcoides
Madrone	Arbtusus menziesii, arizonica
Kelp	Alaria SPP
Sea lettuce	Ulva lactuca

Remember, YOU are a caretaker of these plants.

[\[Return\]](#)

Edible Wild Plants of Wet Places

WARNING: A plant on the list just means that it is discussed on the video. This does not mean that it is edible. Some plants in an edible list are toxic until prepared correctly or have toxic parts. **KNOW before you eat !**

Water lily	<i>Brasenia schreberi</i>
Fragrant lily	
Yellow Pond lily	<i>Nuphar lutea</i>
Reed grass	<i>Phragmites communis</i>
Phragmites	<i>Phragmites SPP</i>
Bamboo	<i>Arundinaria SPP</i>
Bamboo shoot	<i>Arundinaria SPP</i>
Sedge	<i>Carex (2000)</i>
Nutgrass	<i>Cyperus esculentus, rotundus</i>
Bur reed	<i>Sparganium simplex</i>
Bulrush	<i>Scirpus SPP</i>
Calamus	<i>Acorus calamus</i>
Arrowhead	<i>Sagittaria latifolia</i>
Indian rhubarb	<i>Peltiphyllum peltatum</i>
Cattail	Typha latifolia, angustifolia

Remember, YOU are a caretaker of these plants.

[\[Return\]](#)

Poisonous Plants

Oleander	<i>Nerium oleander</i>
Jimson weed	<i>Datura SPP</i>
California poppy	<i>Eschscholizia SPP</i>
Castorbean	<i>Ricinus communis</i>
Poison hemlock	<i>Conium maculatum</i>
Water hemlock	<i>Cicuta maculata</i>
Iris	<i>Iris SPP</i>
Nightshade	<i>Solanum nigrum SPP</i>
Wild tobacco	<i>Nicotiana SPP</i>
Lupine	<i>Lupinus SPP</i>

Sweet pea	Lathyrus odoratus
Scotch broom	Cytisus scoparius
Lantana	Lantana camara
Dogbane	Apocynum SPP
Death camas	Zigadenus venenosus
Foxglove	Digitalis purpurea
False hellebore	Veratrum
Baneberry	Actaea rubra, pachypoda
Bleeding heart	Dicentra spectabilis
Steer's head	Dicentra uniflora, pauciflora
Larkspur	Delphinium SPP
Monk's hood	Aconitum SPP
Buckeye	Aesculus californica
Morning glory	Ipomoea/ Convolvulus SPP
Crowfoot	Ranunculus SPP
English ivy	Hedera helix
Mistletoe	Phoradendron SPP
Poison oak	Rhus SPP

Remember, YOU are a caretaker of these plants.
Even though these are poisonous they have their place.
(Deer eat poison oak/ivy.)

[\[Return\]](#)

Edible Wild Plants of the Eastern and Central North America

WARNING: A plant on the list just means that it is discussed on the video. This does not mean that it is edible. Some plants in an edible list are toxic until prepared correctly or have toxic parts. **KNOW before you eat !**

Pennsylvania and winter cresses	Barbarea
Pokeweed	Phytolacca americana
Spiderwort	Tradescantia pinetorum,occidentalis
Jewelweed	Impaties SPP
Wild garlic/onion/leek	Allium

Water hyacinth	Eichhornia cassipes
Pickeralweed	Pontedria cordata
Saw palmetto	Serenoa repens
Cutleaf toothwort	Dentaria lacineata SPP
Indian cucumber	Medeola virginiana
Spring beauty	Claytonia SPP (20)
Dogtooth violet/trout lily	Erythronium americanum
Hog peanut	Amphicarpaea bracteata
Groundnut	Apios americana
Rue anemome	Anemonella thalictroides
Wild potato	Ipomoea pandurata
Jack in the pulpit	Arisaema atrorubens
Greenbriar/Carrion flower	Smilax SPP
Sassafras	Sassafras albidum
Wintergreen	Gaultheria procumbens
Reindeer moss/rock tripe	Cladonia SPP Umbilicaria SPP
Maple	Acer SPP
Black walnut	Juglans nigra
Blueberries/huckleberries	Vaccinium occidentale
Dewberries	Rubus SPP
Viburnam	Viburnam SPP
Partridgeberry	Mitchella repens
Ground cherry	Physalis SPP
May apple	Podophyllum peltatum
Persimmon	Diospros virginiana
Pawpaw	Asimina triloba
Passion fruit	Passiflora incarnata

Remember, YOU are a caretaker of these plants.

[\[Return\]](#)

Edible Wild Mushrooms

In *Poisonous Plants of California* the statement is made that "Of all poisonous plants in California, toxic mushrooms cause the most serious illnesses and nearly all the fatalities to humans. Those who gather and eat mushrooms should use every precaution to ensure that their mushrooms are correctly identified and known to be edible."

There is no simple test for recognizing toxic mushrooms. Do not listen to old wives tales such as

whether a piece of silver turns black when cooked with a mushroom. Examine very carefully and when in doubt don't. There is an old folk saying that goes like this: "There are old mushroom hunters, and there are bold mushroom hunters--but there are no old, bold mushroom hunters.

WARNING: A plant on the list just means that it is discussed on the video. This does not mean that it is edible. Some plants in an edible list are toxic until prepared correctly or have toxic parts. **KNOW before you eat !**

deadly amanita

death angel

Puffball

Giant puffball

Morel

Half morel

Inky cap

King boletus

Oyster

Sulphur

Amanita SPP

Amanita phalloides

Lyoperdonn pyriforme

Mycenastrum corium

Morchella SPP

Morchella semilibera

Coprinus atramentarius

Boletus edulis

Pleurotus ostreatus

Laetiporus sulphureus

Remember, YOU are a caretaker of these plants.

[\[About the presenters\]](#)

[\[Cover 25KB\]](#)



[Order](#)



[Home](#)



[Books](#)

[\[Return\]](#)

[\[Dining on the Wilds top\]](#) Copyright © 1996 John Goude

JEG Development webmaster@edibleplants.com

When E-mailing do not remove the anti spam * from the subject line.



Experience nature as God intended. Taste it !
Click here to learn about wild plants you can eat and enjoy.
Dining on the Wilds a six session video course.



Survival Tip

Dandelion

Taraxacum officinale



Dandelions, now one of the most despised of plants, were first brought to America by the Pilgrims because they had heard that there was not enough food here to feed Europeans. The British colony James Town nearly starved to death because "gentlemen" do not do farm work. Word of this disaster got back to the Pilgrims so they decided to bring European food and medicinal plants that grow well there. Sure enough dandelions grow well everywhere in America too.

Why did they choose the dandelion? Even though it has milky sap there is no part of this plant that is toxic (unless it has been poisoned with things like weed killer) (Many plants that have milky sap are toxic.) One can eat:

- Roots
- Crown (where the leaves connect to the root)



- Leaves
- Flower buds
- Flowers

I have never known anyone who liked to eat the fluffy seed balls.

The leaves are somewhat bitter if picked at the wrong time of the year or the growing conditions are not right. They are best if picked in the cool seasons or if they grow in the shade. They make a nutritious addition to a salad. The salad will taste much better if there are non bitter greens in it too.

The roots are good cooked like carrots. Some peoples favorite way to eat them is to parch and grind them to use instead of coffee. The bitters are thought to make it to be good for liver, gallbladder, spleen and kidney ailments. Because of it's high iron content it is a good blood builder.

Some say the sap will remove warts.

Perhaps that is why the ancient languages called this plant the disorder (tarax) remedy (ac) to make our modern botanical name Taraxacum.

Dining on the Wilds video course has much more information about Dandelions.



[Order](#) [Home](#) [Books](#)

Copyright © 1999 John Goude

JEG Development info@edibleplants.com

When E-mailing do not remove the anti spam * from the subject line.

Survival Tip

Amaranth

Amaranth an annual grows up to about 6 ft [by the royal measure of king George III], (2meters) [for everyone else] with course alternating oval pointed leaves. Often the tap root has a reddish color. From the base of the leave stems grow the seed spikes. The tiny black seeds are surrounded by sharp bristly bracts which need to be removed before eating See the threshing / winnowing demonstration on video 1 of [Dining on the Wilds](#) .

Amaranth or Lamb's Quarters Seed Bread

3 1/2 cup flour (some ww good)
1/2 cup amaranth or lamb's quarters seed (put in blender or grinder to make fine flour)
3 T honey or sugar
1 1/4 t salt
1 package quick rise yeast
3/4 cup milk, substitute or water
1/4 cup water
2 T oil or margarine

Combine 3 1/2 cups flour and salt in large bowl, set aside. Combine milk, 1/4 cup water and oil in sauce pan. Bring milk mixture to 125-130 F degrees over low heat. Cool to lukewarm. Add sugar and yeast. Stir in lambs quarters flour and other dry ingredients adding to wet ingredients slowly, mixing in enough remaining 1 cup flour to make soft dough. On lightly floured surface knead 4 minutes. Let rise 1 hour in covered

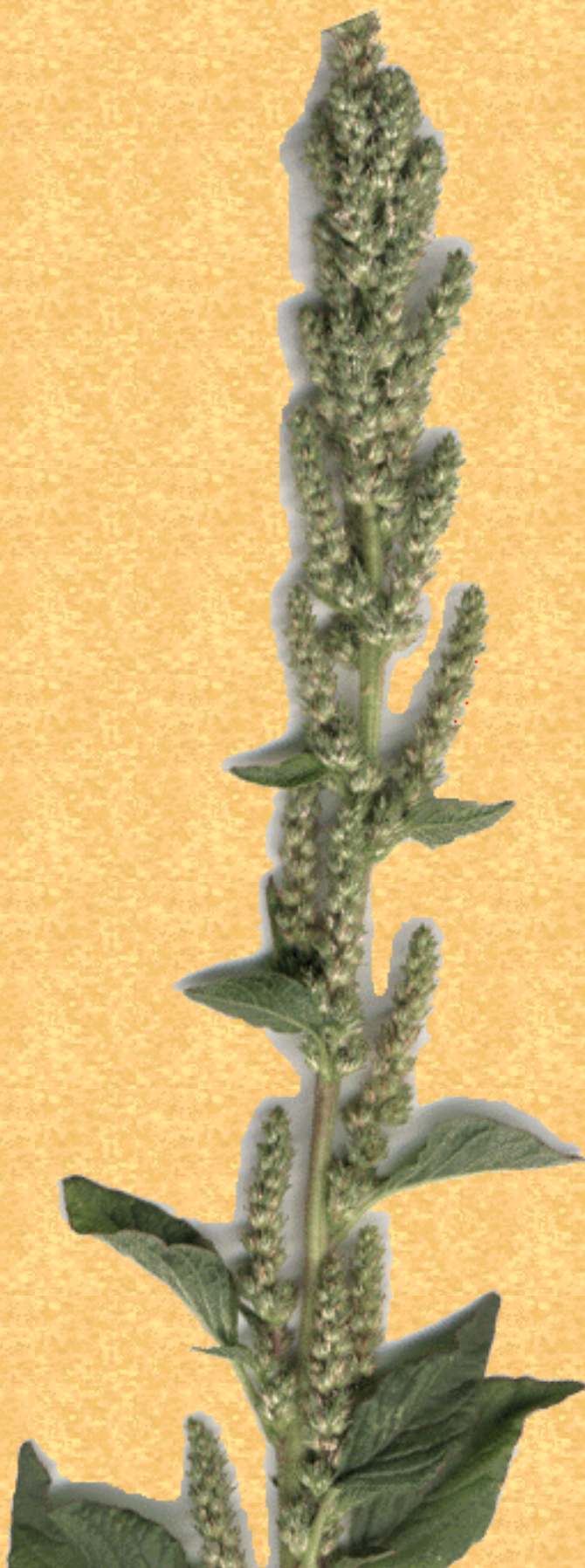



bowl in a warm place. Push down and knead. Make loaves or rolls. Let rise until double in bulk and bake at 325o for 30-45 minutes.

--Ed Hackie, Dining on the Wilds Manual

In the spring and early summer cook the greens as you would spinach. Or eat them in a salad.

amaranth seed heads



Please e-mail me your method of threshing and recipes.



When E-mailing do not remove the anti spam * from the subject line.



[Order](#) [Home](#) [Books](#)

Copyright © 1996, 1998 John Goude
JEG Development info@edibleplants.com

When E-mailing do not remove the anti spam * from the subject line.

Survival Tip

Chickweed

Stellaria media

Is an annual herb with slender stems that are up to about a foot long. It has smooth stems with 1 row of tiny hairs growing in a row on one side of the stem that switches sides at each pair of opposite (oval with a point at the end) leaves. The flowers are small and white with 5 petals that are so deeply notched that they look like 10 petals. The flowers open mainly on sunny days. Chickweed likes to grow in moist shady soil in the cool/cold seasons of the year. The sap is not milky. Some people think it looks similar to the toxic sandwort.



Chickweed has a very mild taste but can be quite stringy; so cut the stems in short lengths and enjoy a fresh wild salad rich in iron and Vitamin C. It can also be cooked or used to make a chickweed bread

2 cups of chopped chickweed leaves and stems.
¼ cup minced onion
2 tablespoons oil
2 tablespoons honey or fruit juice concentrate
1 teaspoon salt
3 cups wheat flour
¾ cup warm water
1 packet yeast

Sauté onion and chickweed until tender (not brown). Dissolve honey and yeast into the warm water and then the salt. Mix the yeast mixture with the sautéed chickweed and onions and slowly add the flour until the dough no longer sticks to your fingers. Form into a ball and let it rise to twice its volume. Shape into loaves and let rise again. Bake at 375F for 40-45 minutes.

Chickweed has been used to treat bronchitis, coughs, colds, hoarseness., it has been used as a diuretic for kidney and bladder problems. Many herbalists use chickweed to help in weight control because they claim it

dissolves fat deposits and fatty tumors.

Externally, it is used in the form of a poultice or ointment and applied to boils, ulcers and abscesses. The fresh juice has also been used to dissolve warts and other skin growths.



[Order](#) [Home](#) [Books](#)

Copyright © 1996, 1998 John Goude

JEG Development info@edibleplants.com [[Dining on the Wilds home](#)]

[[Dining on the Wilds Cover 25KB](#)]

Copyright © 1996 John Goude

JEG Development info@edibleplants.com



[\[How to order\]](#) [\[Dining on the Wilds\]](#)

Copyright © 1996 2001 John Goude

JEG Development webmaster@edibleplants.com

When E-mailing do not remove the anti spam * from the subject line.

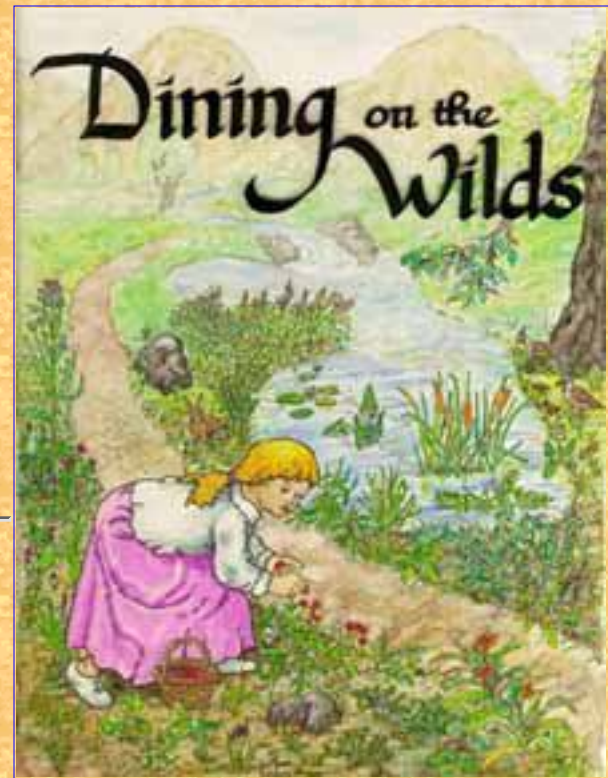



Survival Tip

P u r s l a n e P o r t u l a c a o l e r a c e a

Portulaca oleracea is a smooth low growing succulent plant with reddish stems and underside of leaves, alternate leaves. It has small yellow flowers which produce many sand size black seeds. It often grows in gardens and fields as a weed. Make sure that the purslane is well washed of dirt and grit (usually best to wash it in a bowl of water). (Careful often this plant is the target of the herbicide in some agricultural operations.)

One thing that makes this plant special is that the fat it does have contains omega-3 fatty acids, which some research indicates is useful in preventing heart attacks. Have you been scorning the plant that could keep your heart? It has also been used to treat arthritis and inflammation.

"I have made a satisfactory dinner off a dish of Purslane which I gathered and boiled. Yet men have come to such a pass that they frequently starve, not from want of necessaries, but for want of luxuries." - Henry David Thoreau

P U R S L A N E R A T A T O U I L L E

2 cups chopped purslane
1/2 cup chopped onion
1/2 bell pepper
2 cups canned or fresh tomatoes
1-4 oz can of sliced mushrooms
Salt to taste
Sprinkle of garlic powder

Soy sauce (optional)

Cook purslane, onion and pepper until tender. Add remaining ingredients and simmer a few minutes. Rice can be added to the mixture if desired and cooked for 20-40 minutes.

Replace the lettuce in any salad with fresh raw p u r s l a n e!

[Texas Agricultural Extension Service](#)

[Zov's Lebanese Fattouch Salad with Purslane](#)



[Order](#) [Home](#) [Books](#)

Copyright © 1997, 2001 John Goude
JEG Development info@edibleplants.com



Experience nature as God intended. Taste it !
Click here to learn about wild plants you can eat and enjoy.
Dining on the Wilds a six session video course.



Survival Tip

Violets

Viola papilionacea



Violet leaves are an excellent source for vitamins A and C. Some have 8,200 IU vitamin A and 210 mg vitamin C per 100 grams.

I like them best in salads or used like lettuce in sandwiches. The leaves and flowers make a salad beautiful and much more nutritious.

If you must cook them, you can use them like okra to thicken soup. Or add them to omelets. Or try some old colonial favorites, candy them by dipping them in beaten egg white and then into powdered sugar. Then set them out to dry. Violet vinegar was made by soaking violet flowers in vinegar.



Crushed violets have been used as poultices for boils, swellings and many skin diseases.

The mountain violet *Viola purpurea* is also called "johnny-jump-up" has a yellow front and purple back is edible.

Pansies a botanically similar plant are also edible, if they have not been poisoned with pesticides.

Warning

Violet roots and some yellow violets are emetic. (cause vomiting) African violets are mildly toxic. Violets with deeply cut leaves, such as the Birdfoot violet *Viola pedata*, look very much like the toxic Larkspur *Delphinium* or Monkshood *Aconitum*. The flowers are quite different so wait for the flowers to come out before eating violets with deeply cut leaves.

Some violets are rare or endangered so make sure that the violets you eat are abundant.



[Order](#) [Home](#) [Books](#)

Copyright © 1999 John Goude

JEG Development info@edibleplants.com When E-mailing do not remove the anti spam * from the subject line.

Survival Tip

Miners Lettuce

Claytonia perfoliata
Former name: Montia perfoliata
C. parviflora
C. exigua
C. rubra

Is an annual herb with slender stems and bracts that usually completely surround the stem forming a disk it is in the same family as purslane (see a later plant of the month) and in the same genus as the many springbeauties. Not all miners lettuce is green. I have seen it in a purplish or brownish green. It ranges from Alaska to Mexico, California to South Dakota, and is also found in New Hampshire .

Miners lettuce is named after the California gold rush miners who ate it to get their vitamin C to fight scurvy. Imagine how thankful the miners were when this plant came up in the spring. The winter has just past and they all have red bleeding gums and loose teeth. Many of them have sores that will not heal. Rejoicing that spring has come, feasting on a salad of miners lettuce that cures them of those miseries brought on by scurvy. If they had only known about pine needles and straw berry leaves they would have had plenty of vitamin C.



Miner's lettuce at its best



later in bloom and going to seed



Enlarged flower

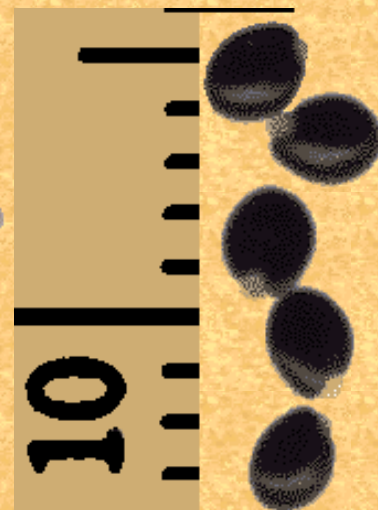

seeds are about 2mm across.



ORDER



BOOKS

[Order](#) [Home](#) [Books](#)

Copyright © 1997, 1998 John Goude

JEG Development info@edibleplants.com

When E-mailing do not remove the anti spam * from the subject line.

Survival Tip

Toyon

Christmas berry

California holly

(Heteromeles arbutifolia)



Toyon berries become ripe in late November or early December are native to most of California. They can ripen as early as September and can remain on the bush until April. The berries are mealy and are almost tasteless. They taste similar to a cheap very starchy cherry pie or an over ripe mealy dry apple. They are something to eat that does not taste bad in the winter though. They are in the same class as their family member delicious apples not very good and not very objectionable. I have tried making a jam from these berries but it was not what I would call a great success. It might have been better if mixed with a strong tasting fruit like cranberries.

These bushes gave Hollywood its name because they grow abundantly on the dry hills behind Hollywood California. In my opinion Toyon is a much better bush to put in the median strip of freeways than the deadly toxic, air poisoning, introduced Oleander that Caltrans seems to love so much. (Some people are so sensitive to Oleander that they can not live near it and remain healthy.) Toyon is an evergreen that makes a nice edible "child safe" decoration. (Some toxic Christmas decorative plants Holly, Mistletoe, Poinsettia) [Please do not send e-mail saying Poinsettia is

not toxic. Poinsettia causes vomiting]

Notice the small barbs on the leaves. The whitish pith of the berries. This small leaf and berry are at about X 2 magnification.





[Order](#) [Home](#) [Books](#)

Copyright © 1996, 1998 John Goude

JEG Development info@edibleplants.com

When E-mailing do not remove the anti spam * from the subject line.



Experience nature as God intended. Taste it !
Click here to learn about wild plants you can eat and enjoy.
Dining on the Wilds a six session video course.



Survival Tip

Honey? Mesquite

Prosopis glandulosa



The first time I gathered and tried to eat Honey? Mesquite was not good tasting. It was nauseatingly sour! Then I found out that some trees (bushes) are that way. So that is why even the horses didn't eat the beans before I got to them! I had gotten them from a horse farm. Since then I have eaten and enjoyed the pleasantly sour Honey Mesquite in a number of ways.

To some Indian tribes they were such an important food item they named the months by the stage of the mesquite. They would eat the buds, flowers and pods. The bean pods ripen between July and September. The seeds themselves are VERY hard, so the pod is the part eaten.

One of the biggest destroyers of mesquite is the Beef industry, because ranchers want the water to grow grasses for the cattle. So they destroy these nutrition laden bushes. (This industry has driven many other plants to near extinction usually because of lack of knowledge.)

Mesquite Carrot Soup

Serves Two to Three

by Jolene Allred

2 tablespoons butter 1 cup mesquite broth
3 cups sliced carrots
½ cup chopped onion 1 cup whole milk
1 large clove garlic, minced Fresh ground white pepper
½ cup water

In a large saucepan with a lid, melt the butter. Quickly sauté the carrot, onion, and garlic. Add the water, cover the pan, and simmer until tender. Puree carrots in blender or food processor. Return to saucepan. Add mesquite broth and milk. Season with fresh ground white pepper. Heat. Recipe is easily doubled.



Basic Mesquite Broth

(Wet Method)

This sweet, caramel-like broth is the basis for many delicious recipes.

4 cups broken mesquite pods 8 cups water

Place the broken mesquite pods in a large pot, cover with the 8 cups of water, cover, and boil for one hour. Cool. Wring and tear the pods in the broth, stirring and mashing the sweet pith into the liquid. Or put one cup of the pods and just a little of the broth into a food processor fitted with a steel blade and whirl until the pods are shredded. Repeat until all pods are shredded. Return the material to the broth and stir. The object is to get as much of the pulp into the broth as possible. Drain off the liquid and discard the fiber. Simmer the liquid uncovered until reduced to 3 cups.

[Texas Through Time, recipes using Mesquite Beans by John Igo](#)
[Ethnobotany Cafe Mesquite Connection](#)



[Order](#) [Home](#) [Books](#)

Copyright © 1997 John Goude

JEG Development info@edibleplants.com

When E-mailing do not remove the anti spam * from the subject line.



Experience nature as God intended. Taste it !
Click here to learn about wild plants you can eat and enjoy.
Dining on the Wilds a six session video course.



Survival Tip

Cattail

Typha agustifolia



Cattails are one of the most versatile and wide spread wild edible plants that there are. They grow in desert water holes, mountain ponds, roadside ditches, northern swamps. The two main species that grow in America are *Typha latifolia* and *T. agustifolia*. I have scanned the less common *T. agustifolia* because I can get reasonable amounts of it on my scanner. The *T. latifolia* is much larger (3 to 5 meters tall [10 to 15 feet]) I understand that a species even grows in Australia. Let us explore some of the parts of this incredible plant.

At the very top is the staminate or pollen part of the cattail. It is good eating. Further down there is a distinct break and the undeveloped seed or fluff part. The lower part is good before it turns any brown. After any part of it turns brown it is tough and fibrous. You can cook both parts as you would cook corn on the cob. Some say it tastes like the cob. When they are at this stage, some people call them kittens tails.

To collect some pollen, cover the cattail with a large plastic bag and beating the pollen out of the staminate. After beating the pollen out, you can cut the cattail because the lower part is good for cooking yet. Often they break while beating them. A little of the pollen can be added to other flour to make bright yellow bread or pancakes. This pollen is high in protein like most pollens.

The shoots of the cattail. can be yanked and eaten raw or cooked. If you eat them raw, I recommend that you sterilize them with Clorox or other pathogen killer.

Look at the cross section of a root. See the starch laden central core to the root. The outside layer is entirely fiber. To get the starch from the fibrous core; first by peeling off the outside





layer and cutting away bruised parts where mud and sand have gotten into the root. Then tease the fibers apart so they release the starch by pounding them in a mortar or by crushing and teasing them in a bowl of water. The water becomes ropy and slippery. Let the starch settle out and pour off the water and dry the starch and you have nutritious flour. When living off the land I have just cooked the root cores and chewed the starch out of them.

ORDER



BOOKS

[Order](#) [Home](#) [Books](#)

Copyright © 1996 John Goude
JEG Development info@edibleplants.com



If you became stranded or lost in the wilderness, would you starve?

Click here to learn about wild plants you can eat and enjoy.

Dining on the Wilds a six session video course.



Poison Ivy / Oak Treatment

Toxicodendron (Rhus)

They have finally separated poison oak/ivy/sumac into their own genus.

1. Take Manzanita *Arctostaphylos sp.* branches, leaves, flowers, berries and all, pack them tightly into a kettle
2. Cover them with water and simmer for about an hour.
3. Let the solution cool and remove the plant parts.
4. Sponge the solution onto the *Rhus* rash. In a few hours the itching should have gone away.
5. Apply the solution 2 or 3 times a day until the rash is gone. For me it takes 3 to 5 days and without treatment it takes 3 to 5 weeks). It is important to get the rash as soon as it starts. Once it does more damage the longer it takes to heal.

An Emergency Room MD (took the class Dining on the Wilds is based on) went to a survival school. Someone there got Poison ivy on both sides of the body. The victim wanted to treat it herbaly so He pulled out his Manzanita and the victim treated one side with the Manzanita solution and the other side with Jewelweed. The Manzanita side healed faster than the Jewelweed side.

Several Indian tribes used the Manzanita or uva-ursi leaves to treat poison oak.

A survival teacher friend of mine says oak bark works in the above method too. He claims that it is the tannin that does the trick. Well good tanning to you if you get poison ivy / oak. There is some evidence that Uva ursi *Arctostaphylos uva-ursi* works well too.

BTW deer and goats like to eat poison ivy / oak. Therefore deer hunters must value the Poison ivy /oak?

for some pictures go to

[Manzanita](#)
[Pacific Poison Oak](#)

ORDER



BOOKS

[Order](#) [Home](#) [Books](#)



Copyright © 1996, 2001 John Goude

JEG Development info@edibleplants.com

When E-mailing do not remove the anti spam * from the subject line.

What others have to say about [Dining on the Wilds](#)

Contents of this page:

[Larry D. Olsen](#), Author "*Outdoor Survival Skills*"

[Mel and Becky](#) *Homeschoolers*

[Arthur Schwartz](#) host of *With Food Talk* on WOR Radio

[Natural Health magazine](#) 7-8/96

[Shooting Industry](#) 10/96

[Soldier of Fortune](#) magazine.

Larry D. Olsen, Author "*Outdoor Survival Skills*"

"*Dining on the Wilds*" is a program designed to teach. I have reviewed the material and find it to be extensive, informative and a pleasurable experience. The teachers seem to know what they're talking about.

If you really want to learn about edible wild plants "*Dining on the Wilds*" will not only get you started but will lead you to excellence in identification, harvesting and preparation of literally hundreds of edible and useful plants in the wilds.

Signed,

Larry D. Olsen, Author "*Outdoor Survival Skills*"

A Homeschooler

"It's amazing! Even our 4 and 6 year old children are learning faster than some adults by watching *Dining on the Wilds* video set. Our homeschooler age 12 wants to make your course part of his schooling. I'm confident our children could survive, if they had to, by dining on the wilds!"

Mel and Becky in Florida

Hi John:

Are you the same John Goude that produced the *Dining on the Wilds* video set? I recently purchased them and find them a good resource.

Best Regards,

Bo Gulledge

University of South Florida

Arthur Schwartz, host of "**Arthur Schwartz With Food Talk**" and "**Sunday Food Talk**" on WOR radio in New York

"Dining on the Wilds", It's an impressive presentation.

author of "**Cooking in a Small Kitchen**", "**What to Cook When You Think There's Nothing in the House**" , and "**Soup Suppers**"

Natural Health magazine 7-8/96

"... the incredibly informative guide covers everything from foraging desert treats to identifying poisonous plants."

Shooting Industry 10/96

"'Dining on the Wilds' teaches hunters to live off the land and to supplement their wild game meals with wild edible plants."... "'Dining on the Wilds' could also be useful in a survival situation where the only food available is what nature provides."

Soldier of Fortune magazine.

DINING ON THE WILDS

As a practicing roadside ruminant, it is easy to spot writers who have read a couple "survival" handbooks from those who routinely graze nature's veggie patch. Aside from the green things stuck in their teeth, we mean.

Although we make light of it, knowing what you can eat in the wild and what will kill you is serious business. It's not something you want to learn by trial and error when the time comes. It's a skill best learned beforehand, from someone who knows.

The *Dining on the Wilds* video series of six tapes, complete with a syllabus and *Wild Plants to Eat* workbook, is the best thing we've seen come down the pike that isn't actual field experience.

Presented by folks with excellent been-there-done-that credentials, the video series is lucid, entertaining and sound education. It covers the full subject: wild edibles of the yard, roadside and meadow, seacoast, wetlands, desert, mountains, mushrooms, poisonous plants, herbs; plus specific treatment of the Northwest and Eastern and Central regions and demonstrations of such arts as threshing and handling acorns, yucca, cattail, prickly pear and domestic flowers - more than 300 in all.

We're admitted tool freaks, but when it comes to wilderness survival, knowledge is more important than tools: Knowledge will never break, sink or be left at camp. And keeping your belly full is the

most important consideration.

[\[Dining on the Wilds \(frame\)\]](#) . [\[Dining on the Wilds \(no frame\) \]](#)

Dining on the Wilds

Miriam Kramer

Miriam Kramer's edible wild plant ventures began in 1966 in Paducah, Kentucky. Miriam's late husband, Jack Darnall, had been invited by their church to teach a wilderness survival seminar. Since Miriam had taken Botany courses and had a big interest in wild flowers she was asked to teach the edible wild plant portion.

After that first wilderness camp the news spread like wildfire and soon they were getting calls to conduct camps all over the U.S. For a number of years they used vacation time to teach the camps, but finally had to devote full time to the project, and conducted camps and seminars all over the U.S. and a few foreign countries. Miriam has taught edible wild plants in 27 states as well as Peru and other faraway places.

Besides conducting week long camps and weekend seminars they developed the International Wilderness Club, made a 16 mm movie Prepare for the Storm, published the Surviving Journal and later the Come Out publication. Together they wrote the Wilderness Survival Manual and the Wild Plants to Eat Workbook, and Miriam wrote the Dining on the Wilds Reference Manual. They also produced the popular Wild Plants to Eat slide as well as the Mushrooms to Eat slide set. Miriam has also written 8 correspondence courses on edible wild plants, survival, herbs and natural remedies.

Besides being featured in newspaper articles, Miriam has had several articles published in journals, and has been listed in "Who's Who in American Women" and several similar publications.

Early on Miriam decided there was a need to share the knowledge of the experts so with \$25.00 she started a mail order book business, Outdoor Eduquip, which has been stated to have the most complete inventory of books, visuals, and videos on edible wild plants, herbs, backpacking, mountaineering, survival and country living available.

Miriam currently is the head teacher of a wild edible plant class for Loma Linda University. The class has become very popular not only with the locals but with individuals coming from outlying areas as far away as 100 miles. The class appeals to a large spectrum of people (ages 5-85) from notable doctors to old ladies with walkers, and has had sessions of up to 65 in attendance.



[[Dining on the Wilds \(no frams\)](#)] . [[Dining on the Wilds \(frams\)](#)]

[[Cover 25KB](#)] Copyright © 1996, 2003 John Goude

JEG Development webmaster@edibleplants.com

When E-mailing do not remove the anti spam * from the subject line.

Dining on the Wilds

John showing a friend how to eat Dudleya

- Occupation:
Computer consultant

- Education:
BS Computer Science

- height 5' 11"
- Single
- Left handed



- Other interests include:
4 X 4, Pathfinders (a church scouting type group), crafts, camping, hiking, cross country skiing, inventing things, ham radio KE6VUB, whistling

-
- When I was 6 my Mother fixing Lambs Quarters to eat and about had to use force to get me to eat "those weeds". We also ate Giant puff ball mushrooms, Black walnuts, butter nuts, hickory nuts, and mulberries etc. from our farm in Michigan.

When I was 9 we moved to Africa as missionaries. I remember her telling the grounds people to mow a lawn. They replied "Oh no, madam, that is food!" We ended up eating that food, "African spinach" (amaranth), and other foods that grew "wild".

When I was 12 we toured Europe. I remember eating stinging nettles and wild berries in Finland and Sweden. The stinging nettle was another contest of the wills because I had been reintroduced to them by the touch method.

In high school I joined the Outdoor Life book club and got every book they had on wilderness survival. I had no mentor to help me learn the plants, so I didn't get very far in learning them then. I also learned from biology class that biologist didn't know what they were talking about. In some areas I knew more than the teacher just by keeping my eyes open and looking around.

In college I took a course called Wilderness Camping and Survival, became friends with Harry Hails, who taught the edible plant portion and went all around the Southern California with him looking for edible plants. One time we went on a camp out that Miriam Darnall

was leading.

- I have studied and/or taught* wild edible plants for 31 years in several states, California*, Michigan*, Ohio*, Arizona*, Nevada, Colorado*, Utah, Idaho*, Kentucky, Wisconsin, Oregon*, Washington, New Mexico*, Colorado*, Arkansas*, Ontario*, New York, Massachusetts*, Pennsylvania, North Carolina, Missouri, Illinois (Indiana, Minnesota, West Virginia, Nebraska to a lesser extent).
- I have taught at
 - outdoor schools
 - summer camps
 - church outings
 - U. S. Forest Service interpretive Specialist volunteer 5 years
 - Rabbitstick and Winter count rendezvous of Society for Primitive Technology a group dedicated to keeping the knowledge of primitive skills alive.
- I have been co-teaching it at Loma Linda University with Miriam Darnall-Kraimer for 10 years.

Copyright © 1996, 2001 John Goude

JEG Development webmaster@edibleplants.com

When E-mailing do not remove the anti spam * from the subject line.

John Goude's Pathfinder links



This page is links to pages of people who have served Pathfinders with me and to Pathfinders of the clubs I have served in while I was there. If you have been in any of the clubs listed during the dates listed please let me know your URL.

Corona, CA	1970-1977 1984-1985	Instructor, Counselor Counselor
Piqua, OH	1978-1980	Director
Grand Rapids, MI	1980-1984	Counselor
Loma Linda Campus Hill, CA	1985-1987 1991-1992 1996-1998	Counselor Deputy Director, Outdoor Activities Leader
Culver City, CA	1987-1989	Deputy Director
Yucaipa, CA	1997-Present	Deputy Director

Steve Timm [SDAnet Moderator](#)

Sam and Helen Young [Family Schools Foundation](#)



[Home](#)



The Debt To the Penny



[More About
The Public Debt](#)

 [Printable Version](#)

[Savings Bonds](#)

[TreasuryDirect
Accounts and
Information
Savings Bonds Tools](#)

[Treasury Bills, Notes,
and Bonds](#)

[Auction Information
Electronic Services](#)

[The Public Debt](#)

[SLGS](#)

[Government Securities
Market Regulation](#)

[Resources](#)

[Site Map
Search
Forms
FAQs
Contact Us
Mailing Lists](#)

[About Us](#)

Current	Amount
05/07/2004	\$7,131,316,785,832.04
Current Month	
05/06/2004	\$7,133,629,790,637.80
05/05/2004	\$7,127,985,763,866.20
05/04/2004	\$7,124,773,711,006.15
05/03/2004	\$7,105,796,969,042.55
Prior Months	
04/30/2004	\$7,133,789,490,581.43
03/31/2004	\$7,131,067,950,647.32
02/27/2004	\$7,091,943,110,094.84
01/30/2004	\$7,009,234,605,728.06
12/31/2003	\$7,001,312,247,818.28
11/28/2003	\$6,925,065,499,881.34
10/31/2003	\$6,872,675,839,106.67
Prior Fiscal Years	
09/30/2003	\$6,783,231,062,743.62
09/30/2002	\$6,228,235,965,597.16
09/28/2001	\$5,807,463,412,200.06
09/29/2000	\$5,674,178,209,886.86
09/30/1999	\$5,656,270,901,615.43
09/30/1998	\$5,526,193,008,897.62
09/30/1997	\$5,413,146,011,397.34
09/30/1996	\$5,224,810,939,135.73
09/29/1995	\$4,973,982,900,709.39
09/30/1994	\$4,692,749,910,013.32
09/30/1993	\$4,411,488,883,139.38
09/30/1992	\$4,064,620,655,521.66
09/30/1991	\$3,665,303,351,697.03

[Law and Guidance](#)
[FOIA](#)
[Privacy and Legal Notices](#)

09/28/1990	\$3,233,313,451,777.25
09/29/1989	\$2,857,430,960,187.32
09/30/1988	\$2,602,337,712,041.16
09/30/1987	\$2,350,276,890,953.00

SOURCE: BUREAU OF THE PUBLIC DEBT

Looking for more historical information? Visit the Debt [Historical Information](#) archives.

Updated May 10, 2004

Contacting the Congress

Online Directory for the 108th Congress

[¿Quiere ponerse en contacto con miembros del Congreso en Español?](#)

Contacting the Congress is a very up-to-date database of congressional contact information for the 108th Congress. As of April 6, 2004 there are 524 email addresses (of which 443 are Web-based email homepages), and 539 WWW homepages known for the 540 members of the 108th Congress. More traditional ground mail addresses are available for all Congressmembers.

[Find Who Represents You In Congress](#)

[Email your Members of Congress](#)

[Power Search](#)

[Congressional Schedule](#)

[Congressional Leadership](#)

[Committees & Subcommittees](#)

[Site FAQ](#)

[What's New](#)

[Misc. Govt. Sites](#)

[Awards](#)

[Downloads](#)

Find your members of Congress by clicking on your state on the map to the right or filling out the following form:

- **Address Search:** Enter your address to determine who represents you in Congress.
- **ZIP Code Search:** Don't feel comfortable submitting your address? Enter just your 5 or 9 digit ZIP code!
- **State Search:** Select just your state to list your state's Congressional delegation.
- **City Search:** Enter a city and state (*without* a ZIP code) to identify the members of Congress representing that city.

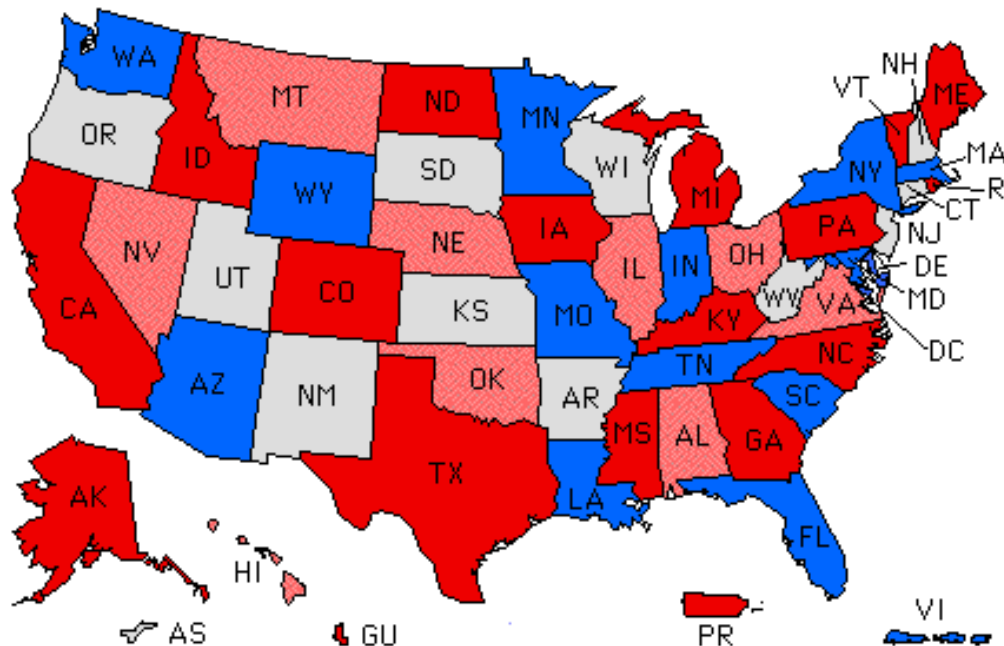

Click on the above graphic or your state name below:

- [\[Alabama\]](#), [\[Alaska\]](#), [\[American Samoa\]](#), [\[Arizona\]](#), [\[Arkansas\]](#),
[\[California\]](#), [\[Colorado\]](#), [\[Connecticut\]](#), [\[Delaware\]](#), [\[District of Columbia\]](#), [\[Florida\]](#), [\[Georgia\]](#), [\[Guam\]](#), [\[Hawaii\]](#), [\[Idaho\]](#), [\[Illinois\]](#),
[\[Indiana\]](#), [\[Iowa\]](#), [\[Kansas\]](#), [\[Kentucky\]](#), [\[Louisiana\]](#), [\[Maine\]](#),
[\[Maryland\]](#), [\[Massachusetts\]](#), [\[Michigan\]](#), [\[Minnesota\]](#), [\[Mississippi\]](#),
[\[Missouri\]](#), [\[Montana\]](#), [\[Nebraska\]](#), [\[Nevada\]](#), [\[New Hampshire\]](#), [\[New](#)

Street Address:

City:

State:

Zip Code: +

>2876442

visitors since
March 12, 1995.

Latest Update to
Contact

Information: April
6, 2004



Privacy Statement: Be assured that we do not keep any of your personal information on-line in any way. This information is gathered solely for the purpose of establishing who represents you in Congress and to allow you to contact them electronically.

[Jersey](#)], [[New Mexico](#)], [[New York](#)], [[North Carolina](#)], [[North Dakota](#)], [[Ohio](#)], [[Oklahoma](#)], [[Oregon](#)], [[Pennsylvania](#)], [[Puerto Rico](#)], [[Rhode Island](#)], [[South Carolina](#)], [[South Dakota](#)], [[Tennessee](#)], [[Texas](#)], [[Utah](#)], [[Vermont](#)], [[Virginia](#)], [[Virgin Islands](#)], [[Washington](#)], [[West Virginia](#)], [[Wisconsin](#)], [[Wyoming](#)]

NOTE: The above map graphic and the client-side imagemap contained in this this HTML document are copyright © 1997 Juan Cabanela. They and any derivative works may not be used in any publication (including WWW-based publications) without the express written permission of Juan Cabanela.

Webpages on the Contacting the Congress website (including this one) are ©Copyright 2003 [Juan Cabanela](#). Portions of this webpage may have been generated by software licensed from [Congress Merge](#) and are ©Copyright 2003 Congress Merge. All Rights Reserved.

Edible Plants, Wild Foods and Other Foragables of North America. Expertise, Workshops, Training, Research, Curriculum Development, Newsletter. John Kallas, Director. We take people into nature and show them how to use wild plants and other foragables for food. "Stalking the wild asparagus" with...

Wild Food Adventures

Institute for the Study of Edible Wild Plants and Other Foragables

John Kallas, Ph.D., Director, Educator, Researcher

4125 N Colonial Ave, Portland, OR 97217-3338

Phone: (503) 775-3828 e-mail: mail@wildfoodadventures.com

You are here: <http://www.wildfoodadventures.com>

Home
You Are Here

Bookstore

Newsletter

Primer

Workshops

Wild Food Intensives

NC Wild Food Weekend
April 2-4, 2004

Native Shores Rendezvous
May 7-10, 2004

GingerRoot Rendezvous
June 25-28, 2004

 **John Kallas, Ph.D.**

 **Book Reviews**

 **Film & Video
Support Services**

 **Euell Gibbons**

Hire Us For...
Speeches
Presentations
Training Programs
Custom Research
Curriculum Dev

Wild Food Adventures

Provides expertise in wild edible plants through workshops, expeditions, teaching events, presentations, outdoor guiding, and outfitting anywhere in North America. Technical advising, curriculum development, and custom research services are also available. Emphasis is on the past, present, and future uses of wild edible plants and other foragables. We also offer publications: the Wild Food Adventurer newsletter, a national publication on wild foods. The Wild Food Primer, a guide to studying wild foods. And a bookstore complete with reviews of the best books available.

Our Mission

Is to help people connect with the Earth, Earth culture, human history, and the future through the study of edible plants in

Areas of Expertise

Edible wild plants and other foragables of North America. Wild foods of Native Americans. The role wild foods play in recreational and unplanned survival. Wild Gourmet Garden Vegetables. Plant identification. Poisonous plants. Sea vegetables. Processing wild foods. Nutrition of wild foods. Research in these areas is continually being conducted.



Help us Communicate with You

If you want regular updates on wild food events, books and publications, E-mail us leaving your name, mailing address, and phone number. If you'd like, also tell us why you are interested in wild edible plants.

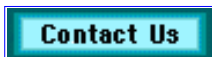

natural settings. People who genuinely make these connections will live more sustainable lifestyles and be better caretakers of the environment.

Our mission is also to partner with and assist original North Americans in their efforts to restore and revitalize traditional foodways. Foodways involve the identification, collection, transportation, processing, storage, retrieval, and use of traditional wild foods. We strive to honor and preserve the wild food knowledge, experiences, and wisdom of original North Americans.

Edible Wild Plants and other Foragables Defined

Edible wild plants are wild plants with one or more parts that can be used for food if gathered at the appropriate stage of growth, and properly prepared. Foragables are natural objects that cannot run off when you approach. They may include edible plant and animal life.



Workshops and Rendezvous involve trips to a variety of habitats. We visit city streets, parks, forests, mountains, coastal habitats, farms, lakes, swamps and more. Some times we look, sometimes we process foods, sometimes we snack, and sometimes we feast. We always have fun with wild foods!

Wild Edible Plant Keyword Descriptors:

Botany, ethnobotany, Native American Indian ethnobotany, wild edible plants, wild food plants, poisonous plants, adventure education, experiential education, wilderness education, outdoor education, primitive living skills, primitive technology, prehistoric Earth skills, outdoor survival skills, wilderness survival, edible cuisine, raw food, living food, wild cuisine, wild gourmet garden vegetables, volunteer vegetables, sustainability, sustainable living, voluntary simplicity, simple living, wildcrafting, special forest products, permaculture, and deep ecology.

© John Kallas, Wild Food Adventures

No part, content, illustration, or graphic from this site may be copied, transferred, or reproduced without written permission.

[Contact Wildman](#)

**Learn About
Foraging
with Naturalist
"Wildman"
Steve Brill**



*Caricature by
[Marian Oken](#)*

Public Events

[The 2004 Calendar](#)
[To Sign Up for a Tour](#)
[Travel Directions/Times](#)

Private Events

[School Curriculum](#)
[Birthday Parties](#)
[Library Program](#)
[Scout Program](#)
[Garden Club Program](#)
[Day Camp Program](#)

References

[Resumé](#)
[Letters of Recommendation](#)
[Children's Letters](#)

WILD FOOD!

**LEARN ABOUT EDIBLE AND MEDICINAL
WILD PLANTS AND MUSHROOMS,
NATURE, AND ECOLOGY**

With New York's [Best-Known](#)
Naturalist

"Wildman" Steve Brill



"Wildman" puts the bite on [Japanese Knotweed](#)

Media

[My Arrest](#)
[Press Clippings](#)
[TV Clips](#)
[Book Reviews](#)
[Wildman's Wedding](#)
[Wildman Radio](#)
[Public Access TV Show](#)

For Sale

[Books](#)
[Video Series](#)
[17-Power Loupe](#)

Foraging

[Wild Plants](#)
[Wild Mushrooms](#)

Cooking

[Plant Recipes](#)
[Mushroom Recipes](#)

[GreenLinks](#)
[The Brillophone](#)
[Steve's Chess Games](#)
[Home](#)

[Contact Wildman](#)

THE PURPOSE of [this hands-on program](#) is to learn about the environment and get back in touch with nature. By [studying foraging and nature](#), we enjoy our renewable resources and reaffirm our commitment to preserving and rebuilding our ecological riches.

Here are all the resources you need to learn about foraging...

Check out the [tour calendar](#) to attend field walks and other events throughout the northeast.



Get information about [travel directions, meeting places and times](#).



Find out [how to sign up and what to bring](#).



Learn about the many common, renewable, edible and medicinal [wild plants](#) growing in your neighborhood.



Find out how you may safely identify, collect, and use our delicious, healthful [wild mushrooms](#).



Enjoy my tasty, innovative vegetarian [wild plant recipes](#) and [mushroom recipes](#).



Arrange a private tour or presentation for a [school](#), [birthday party](#), [camp](#), [scout troop](#), [garden club](#), or [library](#), or to discover what's growing on your property.



My [resumé](#) provides extensive background information.



Letters of recommendation from [teachers](#) and [kids](#) add another perspective on my background and work.



The [press clippings](#) page supplies entertaining and informative coverage by diverse journalists.



Don't miss the hilarious press and media coverage of [my arrest](#) by undercover NYC park rangers, for eating a [dandelion](#) in Central Park!



Watch [TV clips](#) of my best current and archival appearances on local, national, and international news and talk shows, plus my [public access show](#).



Listen to [radio clips](#) from news and talk show appearances, plus archives of my popular NY environmental listener-sponsored radio series.



You'll also enjoy reading excerpts and [reviews](#) from my critically acclaimed [books](#), which you may [purchase](#), autographed (along with [other](#) foraging items):



[*1. Identifying and Harvesting Edible and Medicinal Plants in Wild \(and Not-So-Wild\) Places*](#)



[2. Shoots and Greens
of Early Spring in
Northeastern North America](#)



[3. The Wild Vegetarian
Cookbook](#)



[4. Stalking
the Wild Dandelion](#)

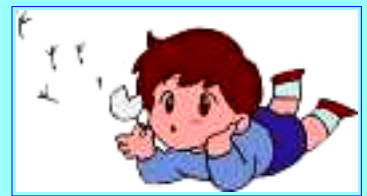

[Watch excerpts](#) of both my videos series--*Foraging with the "Wildman,"* [on sale now,](#) and *The Wild Vegetarian Kitchen* , [on sale](#) soon.



If you're romantically inclined, you'll love the articles about my 2001 wild [wedding](#) to Leslie-Anne Skolnik.



Like original, off-beat,
all-natural music, unusual
instrumentation, or jazz?
Then the [Brillophone](#) page is
for you!



Enjoy chess? Then check out
some of the best [tournament
games](#) from my
pre-"Wildman" days.



Finally, discover the best
related sites on the web, on
my [GreenLinks](#) page.



Happy Foraging!

"Wildman" Steve Brill
wildmansteve@bigfoot.com

phone: (914) 835-2153



BackCountryRangers.com

Studying Human Impact's Effect On The Planet

BackcountryRangers Options



12,112 folks have traveled to this destination!
Including you!

Sponsored by [N1010 Productions](#)

You are at: www.BackCountryRangers.com



- [Home](#)
- [Time-Timing](#)
- [Activities](#)
- [Wild Food](#)
- [Articles](#)
- [Otis' General Store](#)
- [Features](#)
- [Contact Us](#)

School of Self-reliance



Click the above image to go to Christopher's **current class and outing schedule**



The School of Self-reliance operates from Los Angeles, in the L.A. County area of southern California. We research, test, teach / guide, and publish in all aspects of self-reliance. We also sell useful [products](#).

Outdoor skills include wild food foraging, primitive tools, and orienteering. Home skills include recycling, conserving, sustenance-making, and gardening.



See our ebay auctions!

[See eBay](#)

Fill in your e-mail address to receive our html e-newsletter!
(or, you may, gasp, unsubscribe here)

[Subscribe](#) [Unsubscribe](#)

[Powered by YourMailinglistProvider.com](#)

YourMailinglistProvider promises privacy!

37491

Counter restarted February 2002

© 2002 Dolores L. Nyerges, all rights reserved



An internet resource for indigenous ethno-technology focusing on the arts of Eastern Woodland Indian Peoples, providing historical & contemporary background with instructional how-to's & references.



...revising use of the term "*primitive*" with respect to [Native American Technology and Art](#)

ARTICLES

- [Beads & Beadwork](#)
- [Birds & Feathers](#)
- [Clay & Pottery](#)
- [Leather & Clothes](#)
- [Metalwork](#)
- [Plants & Trees](#)
- [Porcupine Quills](#)
- [Stonework & Tools](#)
- [Weaving & Cordage](#)

SPECIAL

FEATURES

- [Games & Toys](#)
- [Food & Recipes](#)
- [Poetry & Stories](#)
- [Virtual Woodland Tour](#)

OTHER

RESOURCES

- [Contemporary Issues in Art](#)
- [Seminole Clothing](#)
- [Ojibwe Culture & Language](#)
- [Discussion Forums](#)
- [Instructional Pamphlets](#)
- [Internet Links](#)

Can't find it?
Try looking in the [Site Index](#)

ALL GRAPHICS AND
TEXT ON THE
NATIVETECH WEBSITE

NATIVETECH NEWS

[Click >>>> More Native News Sources](#)

Tribal News

[Click >>>> More Tribal News](#)

In the Arts

[Click >>>> More Native Arts News](#)

Powwows & Festivals

[Click >>>> More Powwow News](#)

[Powered by Moreover.com](#)

NativeTech BOOKPAGES

-  [Article Bibliographies & Books to Buy On-Line](#)

Please visit my personal page, [Waaban Aki Crafting](#)

[NativeTech VIRTUAL POSTCARDS](#)

NativeTech POLL

What is your view on the Indian Arts and Crafts Act?

[NativeTech SEARCH](#)



For a graphical link to NativeTech from your web page, Please use: [Banner image](#) or [Button image](#) or [Small Button image](#)



© 1994 - [Tara Prindle](#)
(unless specifically cited
otherwise)

[CLICK HERE for copyright
restrictions & use policy](#)

**This site is hosted by
NativeWeb. Your
donations to Nativeweb
help them to promote
Indigenous resources,
inform the public about
Indigenous cultures and
issues, and to facilitate
communications
between Indigenous
peoples and
organizations supporting
their goals and efforts.
Please see their [donation
page](#) to find out ways
you can help.**





Discussions

Choose a board:

- [baking & cookery](#)
- [classifieds](#)
- [garden](#)
- [herbs](#)
- [home dairy](#)
- [homesteading](#)
- [livestock](#)
- [off-grid power](#)

Featured Product



Special Value on Clear Lincoln Drape lamps.

These new lamps have the old style lox-on burner/chimney and the burner may be tarnished. Save \$40. Special price \$69.95. (#C619203) [Click here.](#)

Love simple living? Get how-to hints and "member only" specials by entering your e-mail address here!

Your Email:

Yes! I would also like to become a member of "[Lehman's Life](#)" e-mail community!

Newsletter is provided by [Lehmans.com](#); your email address will **not** be sold.



Picture taken by reader **J. Beaverson** from **Bowling Green, OH.**

Submit *your* photos here: newsletter@lehmans.com

Learn How To:

Did you miss last month's machinery sale when thousands gather to gawk, gossip, and trade on the Kidron auction grounds? Don't worry, you can redeem yourself in two days, on April 3rd. This opportunity won't arrive again until August.

Don't forget our little "event calendar" over there on the left-hand side of Countrylife.net for other upcoming events and directions.

Meanwhile, the current newsletter is about spring, with light articles from our writers on the character and characters of this season.

Enjoy!
Michael Young
Editor-at-Large

P.S. -- For product-specific questions or if you need help from Lehmans.com, please email info@lehmans.com.

---- Feature Articles -----

After a hiatus, Sarah Matthess, our Irish correspondent (we have connections everywhere!) pens us an update, with a few notes on the character of country people. [Click here.](#)

Spring, youth, and ... fishing in Texas. Carolyn Ellis sends us more details on the country life as experienced by her active clan! [Click here.](#)

"Suddenly we found ourselves, life-long inlanders, with three weeks to sell our home, pack, tidy up loose ends,

Features

[Click here](#) for a complete list of articles!

Cooking & Baking

How would you make the holidays special on a budget if you were an American au-pair in London? Okay, maybe it's not a question you ask yourself every day. But there is an answer, and the inimitable Mrs. Restino shares her thoughts and story, along with recipes. [Click here](#)

Gardening

Introducing Rene Ammudsen, an interesting new addition here. Rene lives on an almost-deserted little rocky island with her family, where they help tend one of the few remaining operational lighthouses in Canada. Here, Rene discusses the challenges of gardening in such a rough environment, and the benefits of one particular plant, the Jerusalem Artichoke. [Click here](#)

Growing & Using Herbs

You don't have to invest in store bought stuff to make your home smell nice. There are plenty of 'naturals' to do the trick. Marcy Goldman returns with this article on creating your own home scents. [Click here](#)

Home Dairying

Mary Jane Toth is back, this time with answers to your questions about cheese-making. Soft cheese, hard cheese, what kind of rennet you should use (and what kind you shouldn't use), and more; find your answers! [Click here](#)

Odds & Ends

Spring, youth, and ... fishing in Texas. Carolyn Ellis sends us more details on the country life as experienced by her active clan! [Click here](#)

Raising Livestock

New (to us) writer C.J. Mouser shares her humorous recent experiences in the gilt (that's a young female pig, for those of you unwise in the ways of swine) delivery room, complete with haywire electric fences and slumbering help. [Click here](#)

Old-time skills & crafts

The smart folks from Lehman's life tackle those practical problems of self-sufficiency that the text books

and travel sight-unseen to whatever lighthouse we were assigned." So writes Rene Ammundsen, in the fascinating story of how her family landed on a rocky outcropping in the stormy North Pacific. [Click here](#).

leave out. (Not that there is single text book on "self-sufficiency".) This month, Lehman's life subscribers discuss sock darning. [Click here](#)

Off-the-grid

"Suddenly we found ourselves, life-long inlanders, with three weeks to sell our home, pack, tidy up loose ends, and travel sight-unseen to whatever lighthouse we were assigned." So writes Rene Ammundsen, in the fascinating story of how her family landed on a rocky outcropping in the stormy North Pacific. [Click here](#)

[Find more articles, click here!](#)

[Home](#)

[About](#)

[Articles](#)

[Feedback](#)

[Terms & Conditions](#)

[Advertise](#)

[Tell Your Friends](#)

Internet [Pizazz](#) presents

[A Taste Of Nature;](#)

Edible Plants of the Southwest and How to Prepare Them. © 1994

Kahanah Farnsworth, author.

[Introduction to the book](#)

[FREE recipe for edible native plants.](#)

[Orach Quiche á la Greek!](#)

(Be prepared to give your email address)

Edible wild plants are free food. You will be glad to know which wild plants are edible if you spend long days camping, backpacking, walking on hunting expeditions, or fishing trips. Learn how to harvest wild plants while trapping, foraging or roughing it. Edible flowers and edible roots can be eaten during survival exercises, mountain climbing, rock climbing or even river rafting! Edible plants are useful to many people who engage in activities such as filming on location, photography, reconnoitering, doing surveys and many other outdoor activities! Edible parts of plants include flowers, roots, tubers, leaves, fruit, nuts, shoots and even the occasional stem or branch. [*This website editor has even eaten wild plants while dieting.*]

This book tells you how to identify edible plants and provides gourmet recipes for native plants! The author has illustrated the book with drawings for every plant. The illustrations are clear and simple, making it easier to identify each plant. This book makes a wonderful gift for the person who has everything- a birthday, holiday, or "anything" gift to make someone feel special.

The information on these pages is provided as a free service in the hopes that you will purchase the fine book "A Taste of Nature" by Kahanah Farnsworth.

Disclaimer:

The production and promotion of these web pages is entirely the responsibility of Internet Pizazz who holds the copyright. Any actions taken online are entirely the responsibility of Internet Pizazz and no acts online are the responsibility of the author of the book, the hardcopy publisher or of any affiliates related to either of them in any way. Please direct praises or comments of any kind to tepbp@pizazz8.com Thank you! (And be sure to remove the numeral 8 from the end of the address before sending email. This is a defense against bulk email, also known as junkmail or SPAM.)

This document and related documents and images are property of Internet Pizazz © 1996 - 2001

**New
Releases**

**About
Naturegraph**

**Browse
Catalog**



**Information
on getting
printing done**

Books for a better world

For more information and ordering, please contact:

**Naturegraph Publishers,
Inc.**

**P.O. Box 1047
3543 Indian Creek Road
Happy Camp, CA 96039
1-800 390-5353 or (530) 493-5353
Fax: (530) 493-5240
[Email:nature@sisqtel.net](mailto:nature@sisqtel.net)**



Welcome to our home on the Web!
Between January 1997 and 1999 we had **6000** visitors.

Since January 14, 1999, **00005337**
have visited our page.

SOME OF THE THINGS YOU'LL FIND HERE

- [Personal Information](#)
 - [Growing Pawpaws](#)
 - [Pawpaw Recipes](#)
 - [Persimmon Recipes](#)
 - [A Source for Pawpaw Pulp!!](#)
 - [Elderberry Recipes](#)
 - [Cherokee Inspired gourd art](#)
 - ...and an excellent book that includes pawpaws and persimmons [Uncommon Fruits Worthy of Attention](#) 
-

Personal Information

We've lived on these five acres in central Kentucky for thirty years with our daughters, Abby and Molly. Abby and Molly have now graduated from the University of Kentucky. We built our home out of stone found on this property using a modified slip form method described in Helen and Scott Nearing's [The Good Life](#).  We're very happy with the outcome. Incidentally, this book is an essential addition to your library if you plan for or dream of a more self-sufficient future. We've also watched in amazement as a bare piece of cow pasture has transformed into a veritable Eden through our benign neglect.

We grow pawpaws, persimmons, elderberries and Mayapples for our own enjoyment. We are interested, however, in developing a pawpaw orchard and selling both fruits and trees. We've made some wonderfully delicious pawpaw custards, ice creams and pies. We've also made an elderberry wine that is reminiscent of Miers 44--only better. Please share your experiences and recipes with us. Thanks

[Top of the page](#)

There's lots more Pawpaw information on the Web, and here are three particularly good links:

- [Dr. Desmond Layne's Pawpaw Fact Sheet](#)
 - [Great New Pawpaw site from Kentucky State University](#)
 - [Pawpaw Narrative](#)
-

If you want to talk pawpaws, elderberries, persimmons, Mayapples or owner-built homes, here's how to reach us:

Home: Berry and Jeannie, Waddy, KY 40076



or
Feel free to drop us a
line, [Jeannie and Berry](#)

Growing Pawpaws

I have claimed in the past that it was a bad idea to buy bare rooted Pawpaw trees from a nursery. I'd like to amend that advice. I just attended the Pawpaw field day at Kentucky State University in Frankfort KY (10/21/99), and had the pleasure of meeting Annie Black and Diana Lalani of Hidden Springs Nursery in Cookeville TN. You can feel safe ordering bare rooted pawpaws from them, as they are very knowledgeable, and take great care in digging their trees. Contact them at Hidden Springs Nursery, 170 Hidden Springs Lane, Cookeville, TN 38501. Another nursery that knows its pawpaws is One Green World, 28696 S. Cramer Rd., Molalla, OR 97038-8576. Ask for their catalog. Once you get your pawpaw, you'll need to protect it from the sun for a year or two. Build a little lattice shelter; use the translucent plastic protectors sold by some nurseries; or, prop a cedar or

pine on the south side of your new tree to protect it from intense sunlight. I buy the cheapest three-legged tomato cages, and place them over the young trees. I then put a white kitchen garbage bag over the cage and poke some holes in the top to keep too much heat from building up. The tree will do well in full sun after that second year.

Do you have some seed from a pawpaw you really enjoyed? Clean it well and place in moist sphagnum peatmoss in a baggy in your refrigerator over the winter. Never let the seed dry out. By late February or early March, the seed will have been stratified long enough to sprout. The best pot to start your seed in is a 12" length of 4" plastic sewer pipe. The plastic base of a 2 liter soft drink bottle makes an excellent bottom for this pot. Fill the pot with growing medium or top soil and plant the seed about an inch deep. The reason you need this tall skinny pot is because when the seed sprouts it sends down a ten inch tap root before you ever see anything. The seed itself should stay in the soil while the first leaves emerge. These aren't cotyledons, but true leaves. Usually, when the seed itself emerges from the top of the soil, it means your pot wasn't deep enough, and the tap root pushed the seed out of the soil. Don't expect to see anything for quite a while. Keep the soil moist, and don't give up until almost September. The seed will sprout sooner in a greenhouse, but always requires the four months or more of stratification.

You found a patch that produces really fine fruit and you want to dig a small sprout for transplanting? Most pawpaw patches consist of a parent tree and many root suckers. Digging these root suckers is usually unsuccessful because there isn't much of a tap root. Best wait for the fruit and plant the seeds. Another unusual characteristic of the pawpaw is that it should be transplanted when it is not completely dormant. This is because in the dormant state, the root is also dormant (unlike most deciduous trees). If it's wounded at all during the transplant, rot or disease will set in and the tree will die.

Pawpaws aren't real easy to grow, but they're well worth the trouble both as an ornamental and fruit tree.

[Top of the page](#)

Cherokee inspired gourd art

HERE ARE A COUPLE SAMPLES OF ABBY'S WORK. THEY MAKE WONDERFUL AND UNIQUE GIFTS. SHE HAS LARGE AND SMALL GOURDS AVAILABLE. THE DESIGNS ARE BURNED INTO THE GOURD AND COLORED WITH ACRYLIC PAINT. I'LL SHOW YOU MORE AT A LATER DATE.



Drop Abby
an email line: [Gourd Art](#) or, visit
her [HomePage](#) to see more
gourd art and learn more
about it.

Please, feel free to drop us an email
line: [Jeannie and Berry](#)



There is a person who sells Pawpaw pulp...

And his name is Chris Chmiel. Chris, called "Dr. Pawpaw" around Albany, OH, is extremely knowledgeable about all aspects of pawpaw culture and use. Here's what he says about his pawpaw pulp product: "I am selling the 1 pound bags for \$4.50. The 2 pound bags are \$8.00. I am also willing to ship small quantities, because I have a better shipping system. I am also willing to ship fresh fruit boxes of the pawpaws for \$5.00 a pound, which is 4 to 6 fruit. Contact [Dr. Pawpaw](#), with your questions and orders. If you want

the fresh fruit, you'd better contact him in August or September.

[Top of the page](#)



Goods From



The Woods

www.Pinenut.com

Goods From The Woods

**14125 Hwy C
Licking, Mo.
65542**

Put your hands on the earth and start working to heal.

Our Mission Statement:
tu ba be - **live high in**

pine nut tree (to be high, a pinon must be old growth)

NEW - Pinon Die off news

Pinus Monophylla-(pinon)or(pinyon)

Need more than 100 years to reach pine nut producing maturity.



Pinon Pinon Pine Nuts | Wild Plant Nursery and Growers Goup | **order- page**

The Pine Nut Season is over, but we getting our WILD/Organic Certification for our farm and will some native plants for sale

Pinon Penny's Pine Nut Work

[SITE INDEX](#)



I started working stop deforestation treatments on U.S. public lands in 1999. Let me show you my public lands pinon pine nut [chronology](#). Look at the potential [value of pinyon pine nuts](#) from public lands in the United States. Would you like to know all about, [which pines](#) produce good pine nuts, or about the [native people](#) used pinon pine nuts as a primary food source? Maybe, you would like to know about [cooking](#) with pinenuts or about [food values](#) for various pine nuts. If you are a [raw food](#) consumer, we would love your input for the raw soft shelled pinon pine nut page. We are getting a lot of requests for information on [growing pinon](#) or pinyon trees. We will also soon have a page with research articles on pinon pine nuts. We would also like to invite you to learn about bio-diversity and conservation using [non-timber forest products](#).

Prior to World War II, 8 million pounds of **pine nuts** came from the Southwestern US. What happened to America's pine nut forests? ([History of US Pinon Pine Nuts and Public Lands](#)) Pinon nuts represent a healthy, sustainable use of your public lands in the Western United States

pinenuts@pinenut.com

Community Forestry, Wild Native Plant Nursery Project - A Wildcrafter's Nursery Growers Group



Bio-diversity conservation
We are a certified Wild Native Nursery in Missouri. Soon we hope to have our Organic Crops Certification and Wild Harvest Certification. Forest plants sold on this site, are harvested in a respectful, responsible manner. We are trying to help people find economic ways



[SITE INDEX](#)

This site has a lot of information please start here!!

[Current Condition of Pinon Sytems](#)

- [Public Lands and Pine Nut in The Southwestern US](#)

[Let's consider the role of biodivesity in forest health and wild fire.](#)

- [Page 1 Internal Link 3](#)

[Global Market for pine nuts](#)

[Pine Nut Information for Raw Food Community](#)

[History of US Pine nut Public Lands](#)

[growing pinon pinyon Pine Trees](#)

Forest Work - Ozarks

Plants in Propagation

Roots, seeds and plants

UNDER- Developmen



Page 7

[**Letters and Legal Actions - to create wiser use of our public lands**](#)[Letter 2000](#)

[Letters 2001](#) [Letters 2002](#)

[Letters 2003](#)

Legal Actions

[Mt. Wilson Appeals](#)

[Mt. Wilson Complaint](#)

[~~~Native Americans Letter TO BLM~~~](#)

[Back to the Top](#)

This div should be at the bottom of the page.

Insert copyright information here.

Edible Wild Plants



[Click to learn more about "My Favorite Plants"](#)

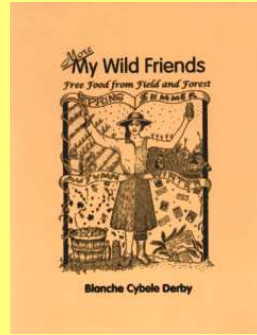

[Click here to learn about "More My Wild Friends"](#) (second in the series).

[Upcoming Events](#)

[To the order form](#)

Two books available: "My Favorite Plants" and "More My Wild Friends"

With the success of "My Wild Friends"(out of print), Blanche has now released "More My Wild Friends" AND "My Favorite Plants".

My Favorite Plants

NEW! "old" book revived Because several people have expressed their wish to own the now out of print "*My Wild Friends*", I decided to excerpt the "best of the best" from that book into a "new" one, "*My Favorite Plants*". I extracted essays and recipes on the plants I use the most.

If you missed the first book, here's a chance to get valuable information on plants such as nettle, chickweed, cattails etc.

Don't buy this book if you already have "*My Wild Friends*"; aside from a few new drawings and recipes, it's basically the same book. But if you don't own "*My Wild Friends*", this just might be the perfect solution.

Cost: \$17 (+.85 MA tax) + \$5 shipping.

132 pps. 6"x9";

A perfect companion to "*More My Wild Friends*".

My Wild Friends is now out of print - see My Favorite Plants instead.

My Wild Friends

Free Food From Field and Forest

Written and illustrated by

Blanche Cybele Derby

Have you ever eaten black locust flowers, cattail buds, or stinging nettle leaves? These are just some of the common "weeds" discussed in this book that are free, plentiful, and easy to prepare.

Using wild plants as food has become more popular, as people realize how tasty and nutritious they are. While this book is a culinary adventure of exploring New England's fields and forests for unusual foods, web visitors from around the world will

recognize "weeds" that may well have originated from their backyards.

My Wild Friends includes:

- the author's personal stories and observations about her favorite plants
- over 100 beautiful illustrations
- over 50 recipes
- information on plant habitats, best parts to use, and best times to harvest
- extensive bibliography
- 264 pages; 6"x9"
- comb binding so book lays flat

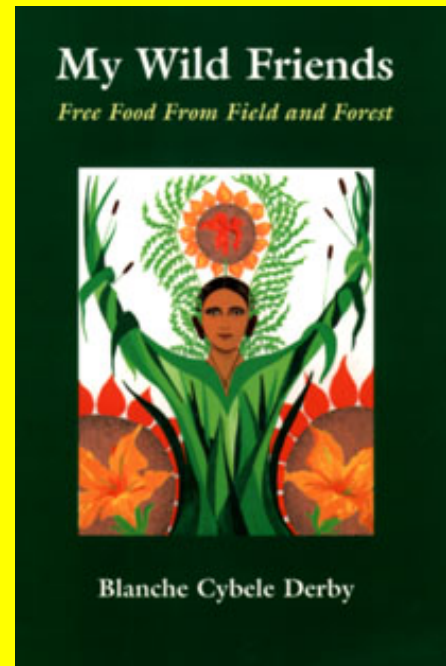

What people are saying about "*My Wild Friends*"

Review by **Shannon Younger**

"The other day a wondrous treat arrived in my mail box; a book titled **My Wild Friends** by list member **Blanche Derby**. I have to say, I was charmed and enchanted almost instantly by this tome. The illustrations are all done by Blanche and harkens back to the days of the turn of the last century when children's and young adult's books were complimented with artwork by the likes of Arthur Rackam or Howard Pyle. My son, who is speech delayed, babbled on incessantly about the pictures, wanting to know more about the scenes and the plants. The prints are creative, intuitive and very imaginative. They draw the reader into the book. I caution you to look at each illustration with care though, because you will find additional allusions to the plants hidden in the picture, some are very subtle and some not so subtle. Leave's and flower's motifs are repeated in the design work. You will find references to several cultures in the artwork as well. The work is very delightful and whimsical, and as you can see I am very enthusiastic about the entire book.

The text is useful and reads easily, and is a down right pleasure too! Blanche makes a point to tell the reader that this is not a field guide. Ohhh Dear Blanche to my mind it is so much more though. Through Blanche's stories and pages I have learned more about Ben Charles Harris, a wild edible plant author and guru from decades past. I had only known of him from books in the library and now he is a real, 3-dimensional personality come to life.

There are many plants covered in the book. Organized by chapter per plant or grouping of plants in the case of edible flowers. With each chapter the reader is introduced to the plant with a jewel of an essay, and I do mean jewel here, pun intended. Blanche shows you many facets of each special plant friend. She weaves a story and sometimes she includes a special bit of lore or legend, as well as giving the reader insights into why she finds this plant to be special. My personal favorite character in the book is the "Orchard Cat" who made the Apple Orchard part of his territory. These chapters are sneaky, before you realize it, you have learned or reviewed much information in a painless and enjoyable manner. She does cover several plants that one does not often find in foraging books, along with the favorites. Best of all the reader will see these plant friends in a very different light (more intimate view) after having read the book.

Blanche also gives tips on harvesting and preparing each plant for eating. I have tried several of her recipes already with things available at the grocery store (we have about 6 inches of snow on the ground at the moment). The recipes are simple, easy to prepare and very tasty. My children were able to help with the preparation and it became a family project, making this book a good resource for homeschooling. The Cranberry (Apple) Bread was a big hit here! This was probably the easiest Cranberry bread recipe I have ever made, and I am one of those people who wait all year long for cranberry season when these fruits are available fresh in the market. Each chapter has at least one recipe and often there will be other ideas on preparation written into the text. Also included with each chapter is a run down on basic information. This page appears at the very beginning of the chapters and lists: Scientific Name, Family, Also Known As, Habitat, Parts Used, Season, and any Cautions. Blanche has

included a very useful bibliography in "My Wild Friends." Here I emphasize the word useful, because she gives a paragraph description of what each book listed is about and what you can expect to find in the book information wise. She obviously spent a goodly amount of time crafting this section of the book as well. It was nice to receive a book with a penned and personal note in the front cover, making the book all that more special. Blanche, bravo and a resounding "two thumbs up." Thank you for hours of reading pleasure, learning and good eats. ..." Review by **Shannon Younger**, writing on the "[Wild Forager](#)" list forum

[To the order form](#)

More My Wild Friends

Free Food From Field and Forest

Written and illustrated by

Blanche Cybele Derby

Do You Know.

- what weed is a main ingredient in the national dish of Colombia?
- what plant is an important part of an anti-cancer formula?
- which flowers to use in a salad?
- how to find spices for free?
- that the oil from this plant is effective against PMS?

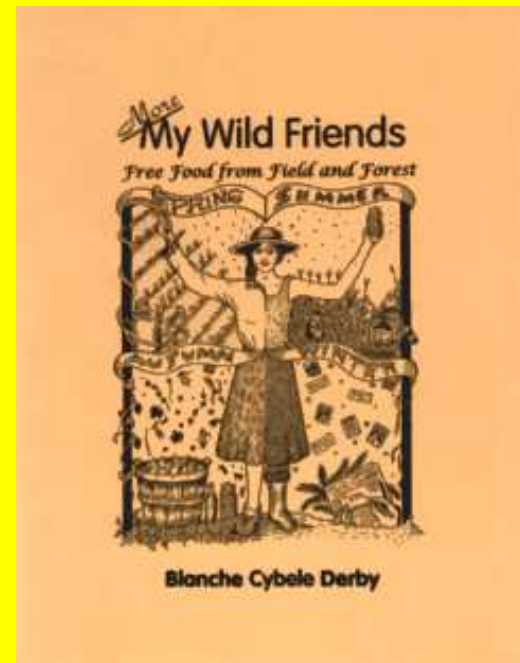

This supplement to My Wild Friends introduces a whole new group of common plants with uncommon stories to tell. More My Wild Friends combines fascinating facts and recipes with information on plants that are plentiful and available. They have much to offer and this book tells how they can be used to enrich our lives. Inside this book you will find:

- the author's personal stories and observations about plants
- over 40 detailed black and white illustrations
- over 30 recipes
- information on plant habitats, best parts to use, and best times to harvest
- annotated bibliography

114pps., 6"x 9" \$12.(+MA tax .60) + \$5. Shipping

excerpt from "I'm a Crusader for This Invader" chapter:

The Division of Fisheries and Wildlife recently published A Guide to Invasive Plants in Massachusetts, a booklet that features 17 of the most problematic imported plants that threaten to usurp the territories of native plants and animals. Each plant is illustrated with a beautiful color photo and description. Many of these are well-known intruders like bittersweet but lesser-known culprits are also showcased. One of these is Autumn Olive (*Elaeagnus umbellata*), an Asian shrub that was introduced into this country in 1830. After being here for over 160 years, why is this plant now on the state's "hit list? ...

recipe from "Its Food! It's Medicine! It's Sheep Sorrel" chapter:

Sorrel Soup

2 cups uncooked sheep sorrel/wood sorrel leaves; (wood sorrel flowers are o.k.)

1/2 cup sautéed onions
Dash of pepper/nutmeg
3 cups vegetable or chicken broth
2 medium potatoes (optional)

Mix ingredients in saucepan and simmer until potatoes are soft.
This serves 3; the recipe can be doubled.

[To the order form](#)

Edible Wild Plants: Upcoming Events

WALKS/TALKS IN '04

--Join me in exploring the weeds around us! This list will be added to as the spring progresses. Check it periodically. All events are in MA +free unless otherwise noted. For more info e-mail:qs2t@hotmail.com

- Coming soon!! Watch for excerpts from my video *Edible Plants: Wild and Tame* on Easthampton, (and maybe Northampton + Amherst) cable TV.
- Thurs April 22: (Earth Day) Slide show, Goldthread Herbal Pharmacy, 267 Pleasant St Northampton; 6:30pm
- Sun May 16: Show 'n tell Pioneer Valley Pond and Koi Club 94 Gillette Av. Spfld (not open to public)
- Sat May 22: Walk @ Great Falls Discovery Center, Avenue A, Turner's Falls; 9:30am-11:30 pm; \$12 (snack included)
- Sun May 23: Walk @ Fannie Stebbins Refuge, Bark Haul RD, Longmeadow ; 3:30-5:00 followed by a potluck in Suffield CT.
- (tentative date) Sat June 5 (raindate Sun June 6): Walk the Blueberry Patch, 1672 Main Rd W. Granville; 1-3
- Sun June 13: Walk @ Spirit in Nature, Westhampton; 1-3
- Sat Sept 11: Walk @ Spirit in Nature, Westhampton; 1-3

Artist and author **Blanche Cybele Derby** has supplemented her diet with wild plants for over thirty years. She has lectured and led many wild weed walks, and writes about many edibles for her local newspaper. An enthusiastic practitioner of what she preaches, she hopes that this book will inspire others to become more involved in the natural world. [Click here to contact her](#)

For ordering information, [go to the order form](#)

Other related links for you to check out

- [Edible Plants: Dining on the Wilds](#)
- [Edible Wild Plant/Mushroom Walks and Courses](#)
- [Edible Wild Plants by Melana Hiatt](#)
- [Foraging and Ethnobotany Links Page](#)
- [Foraging the Edible Wild](#)
- [Foraging with the Wildman](#)
- [Outdoor Eduquip](#) - Educating & Equipping you to enjoy nature. [Plant Sources of Life](#)
- [Susun Weed](#) Herbal Medicine - the Wise Woman Way
- [Wildcrafting with Ila.com/](#) an excursion through the bounty of the Great Smoky Mts.
- [Weeds and Wild Things by Barbara Hall](#)

- [The Wild Foods Forum](#) ... the key to using nature's foods ...

"Free Food from Forest" is hosted by [TagYerit](#)



©1997-2004 Blanche Derby

Edible and Medicinal Plants of Southern Illinois

"Nature's pharmacy" or "nature's fruit market" may be the best way to explain it. Long before there were modern medical centers or supermarkets, the inhabitants of Southern Illinois survived by "living off the land." The forests, wetlands, and grasslands of Southern Illinois are a rich source for edible and medicinal plants. Imagine getting a fever or an infection and not having a doctor to call or an emergency room nearby. The early inhabitants had to be creative to prevent starvation or survive disease.

Many early inhabitants did not survive disease, but occasionally some remedy would work to ease suffering and would then be considered a "medicine." Even after there were doctors, many of the "medicines" used were derived directly from plant products. The doctor would often take extracts from plants with a mortar and pestle to prepare powders, ointments, or pills. Many plants are still used today, in some form, to eliminate suffering.



The following rules **MUST** be observed when collecting and eating wild plants:

- Study with an expert or take the plant to an expert for proper identification.
- After positive identification of an edible plant, taste only a small amount. This will prevent allergic reactions to previously unused plant products.
- The purpose of the information in the plant reports is not to recommend

or endorse herbal medication, self diagnosis or self medication. If you are ill, seek the advice of a physician. The information is provided as historic reference and not scientific fact.

- Practice conservation. Never collect more plants than you intend to use and never pick endangered or threatened plant species.
- Avoid harvesting plants from polluted ground. Roadsides or areas along railroad tracks are often polluted with herbicides or tainted with chemicals such as lead or benzene. Be careful!!
- Wash and cook all plants carefully.

The plants listed below have parts that are edible or may be medicinal. The list will be updated regularly. Click on the plants that are underlined to read more information about their uses.

<u>Artichoke, Jerusalem</u>	Birch	<u>Blackberries</u>	<u>Bloodroot</u>	Blueflag, Iris
<u>Burdock</u>	<u>Butterflyweed</u>	<u>Black Locust</u>	<u>Basswood, American</u>	Black Haw
<u>Cinquefoil</u>	Cabbage, skunk	<u>Carrot, wild</u>	<u>Cattails</u>	<u>Cherries, Wild Black</u>
Crabgrass	<u>Chickweed</u>	<u>Chicory</u>	Cleavers/bedstraw	<u>Clover</u>
<u>Crabapples</u>	Cranesbill	Cow-parsnip	<u>Creeper, Virginia</u>	<u>Dandelion</u>
<u>Dewberry</u>	<u>Daylily</u>	<u>Dogwood, Flowering</u>	Dog-tooth violet	<u>Elderberry</u>
<u>Evening primrose</u>	<u>Goatsbeard</u>	<u>Ginger, wild</u>	Goldenrod	<u>Goldenseal</u>
<u>Grapes, Wild</u>	<u>Garlic, wild</u>	<u>Ground ivy</u>	<u>Gooseberry</u>	<u>Hazelnuts</u>
<u>Ginseng, American</u>	<u>Hawthorn</u>	<u>Honeysuckles</u>	<u>Hackberry</u>	<u>Henbit</u>
<u>Hickory</u>	Jimsonweed	<u>Jack in the pulpit</u>	<u>Kentucky Coffeetree</u>	<u>Lady's slipper</u>
<u>Lamb's quarter</u>	Lettuce, wild	<u>Lilies, water</u>	<u>Lily, day</u>	<u>Sugar Maple</u>
<u>May apple</u>	<u>Milkweed</u>	<u>Mints/pennyroyal</u>	<u>Mullein</u>	<u>Mustard, black</u>
<u>Mulberry, Red</u>	<u>Ox-eye daisy</u>	<u>Pawpaw</u>	<u>Peppergrass</u>	<u>Purslane</u>
<u>Plantain</u>	<u>Persimmon</u>	<u>Pokeweed</u>	<u>Prickly pear cactus</u>	<u>Redbud</u>

Roses, wild	Sheep Sorrel	Self-heal	Sassafras	Shepherd's purse
Snakeroot	Sorrels, wood	Spiderwort	Spring beauties	Star of bethlehem
Soloman's Seal	Sunflower	Smartweed	Sumacs	Strawberry, Wild
Tartarian Honeysuckle	Thistle, bull	Touch me nots	Violets	Walnut
Willow	Witchhazel	White Oak	Yarrow	Yucca



[top of page](#) / [home](#) / [credits](#)

NetworkSolutions®

This Site is Under Construction and Coming Soon.

❖Sponsored Links

[Perennials](#)

Set your garden ablaze with color! New roses and perennials from J&P.

www.jacksonperkins.com

[Burpee Seeds and Plants](#)

Superb quality plants and seeds. Free shipping on orders over \$30.

www.Burpee.com/

[Five Star Perennials](#)

Larger plants that make an instant impact in your garden. Great Value.

ParadiseGarden.com

[Rose Gardening](#)

500 varieties bush and climbing plants. Newest to the oldest roses.

www.heirloomroses.com

[Garden Center](#)

Save \$20 off \$40 order aff Seeds Plants Trees & More

gurneys.com

❖Search These Related Topics

[Plants](#)

[Perennials](#)

[Gardening](#)

[Garden plants](#)

[House plants](#)

[Indoor plants](#)

[Houseplants](#)

[Environment](#)

[Horticulture](#)

[Container gardening](#)

[Garden flower](#)

[Rose gardening](#)

[Aquatic plants](#)

[Vegetable gardening](#)

[Herb gardening](#)

[Environmental science](#)

[Artificial plants](#)

[Outdoor recreation](#)

[Garden](#)

[Environmental engineering](#)

[Nursery](#)

[Water plants](#)

[Garden centers](#)

[Sustainable development](#)

[Ornamental tree](#)

[Parasite](#)

[Shrubs](#)

[Geraniums](#)

[Garden stores](#)

[Ecotourism](#)

[Flower gardening](#)

[Air plants](#)

[Artificial grass](#)

[Potted plants](#)

[Life science](#)

[Synthetic grass](#)

❖Other Popular Categories

[Travel](#)

[Financial Planning](#)

[Business and Finance](#)

[Health and Beauty](#)

[Health Products](#)

[Car Rental](#)

[Debt](#)

[Affiliate Program](#)

[Skin Care Products](#)

[Vitamins](#)

[Hotels](#)

[Credit Cards](#)

[Student Loans](#)

[Exercise Equipment](#)

[Weight Loss Drugs](#)

[Airline](#)

[Loans](#)

[Stocks](#)

[Hair Replacement](#)

[Joint Pain Relief](#)

❖Try a Search:

**BUY A DOMAIN
AS LOW AS \$14⁹⁹**

www.

[.com](#) [.net](#) [.org](#)

[.biz](#) [.info](#) [.us](#)

- FREE Search
- FREE 24x7 Support
- FREE online Account Management

**Earn
1,000 miles**
[CLICK HERE](#)

[Alt Text](#)

**Earn
1,000 miles**
[CLICK HERE](#)

Build Your Business:

[Get listed in top search engines](#)

[Special web site hosting offer](#)

[Forward visitors to your web site](#)

[Incorporate Your Business](#)



websitepros. **Get the QuikPage
Web site &
Marketing Package** just **\$54.95/month!**

[Alt Text](#)

[Trademark Free Zone](#), [Review our Privacy Policy](#), [Service Agreement](#), [Legal Notice](#)

Copyright 2004 Network Solutions. All rights reserved.

The herb database has moved. The new location is <http://herb.umd.umich.edu>. You will be taken there automatically in 5 seconds. Please update your bookmarks.

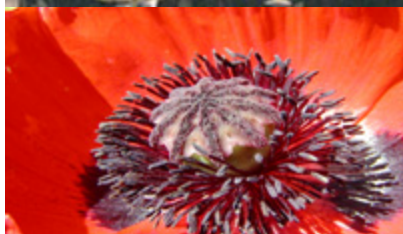

Native American Ethnobotany

A Database of Foods, Drugs, Dyes and Fibers of Native American Peoples, Derived from Plants.

Your search string may contain "AND" or "OR" in capitals.

For example: *maple AND eye medicine*

Search String:

For information about the database, click [here](#).

Contact Information

Dan Moerman
2134 CASL Annex
4901 Evergreen Rd
Dearborn MI 48198
dmoerman@umich.edu

You are visitor number **102780** since May 14, 2003.

[About UM-Dearborn](#) • [Academic Programs](#) • [Centers, Programs, and Attractions](#)

[Prospective Students](#) • [Alumni and Friends](#)

[Current Students](#) • [Faculty and Staff](#)

[Search](#) • [Site Map](#) • [Admissions](#) • [Contact Us](#) • [UM-Dearborn Directory](#)



Dr. Duke's Phytochemical and Ethnobotanical Databases

WARNING

Specific Queries of the Phytochemical Database

[Queries indicated in **green** new queries that search the most recent version of the database]

Plant Searches

[Chemicals and activities](#) in a particular plant.

[High concentration chemicals](#).

[Chemicals with one activity](#).

[Ethnobotanical uses](#).

List chemicals and activities for a [plant](#).

Chemical Searches

Plants with a chosen [chemical](#).

Activities of a chosen [chemical](#).

List activities and plants for a [chemical](#).

Activity Searches

Plants with a specific [activity](#).

Search for plants with several [activities](#).

Chemicals with a specific [activity](#).

Lethal dose (LD) information for a [chemical](#).

Search for plants/chemicals with one or more [activities](#).

Search for plants/chemicals with a [superactivity](#).

Ethnobotany Searches

[Ethnobotanical uses](#) for a particular plant.

[Plants](#) with a particular ethnobotanical use.

Database References

[Reference citations.](#)

Browsable databases:

EcoSys	Plant ecological ranges	AceBrowser WebAce
EthnobotDB	Worldwide plant uses	AceBrowser WebAce
FoodplantDB	Native American food plants	AceBrowser WebAce
MPNADB	Medicinal plants of Native America	AceBrowser WebAce
PhytochemDB	Plant chemicals	AceBrowser WebAce

Documents

Dictionaries

[Tico Ethnobotanical Dictionary.](#)

Mini-Courses

[Syllabus](#) for Medical Botany Course taught by Jim Duke.

Other Databases of Interest

Taxonomic Databases

[USDA Germplasm Resources Information Network \(GRIN\)](#)

Medicinal and Poisonous Plants

[U. Maryland](#)

Moerman Database - U. Michigan

[American Indian Ethnobotany Database](#)

Plants and Cancer Treatments - U. Indiana

[Cyberbotanica](#)

Nutritional Databases

[USDA Food and Nutrition Information Center](#)

- [USDA - NCI Carotenoid Database](#)
- [Food Composition Data](#)

[Med Access Nutrition Database](#)

- [Nutrition Analysis Tool v1.1](#)

Reference Database

AGRICOLA--plant genetics subset [[query](#) | [about](#)]

Other Links of Interest

The Cancer Chronicles

[Serious Consideration of Alternative Ideas](#)

Phytopharmacognacy

[Phytochemistry and Pharmacognosy Research Group at Middlesex University](#)

Non Timber Forest Products

WARNING

Send comments or suggestions on the content of these pages to:

Jim Duke
Green Farmacy Garden

8210 Murphy Road
Fulton, MD 20759

or

Mary Jo Bogenschutz: bogie@hawaii.rr.com

Last updated: 28 April 2004

Looking for GDR?

The ARS Genome Database Resource (GDR) was permanently decommissioned on April 15, 2002.

All resources formerly at GDR, including ACEDB databases, newsletters and documentation, are available elsewhere. Check [Google](#) or other web search services for their current locations. **Please update your bookmarks!**

Note that RiceGenes has been superseded by [Gramene](#), a comparative database for the grasses.

The [MapPop](#) software package is available from Todd Vision at the University of North Carolina.

UCMP Glossary: Botany



| [Phylogenetics](#) | [Geology](#) | [Biochemistry](#) | [Cell biology](#) |
[Ecology](#) | [Life history](#) | [Zoology](#) | **Botany** | [Paleogeography](#) |

adventitious roots -- A root that grows from somewhere other than the primary root, for example, roots that arise from stems or leaves.

alternation of generations -- Life cycle in which **haploid** and **diploid** generations alternate with each other.

anemophily -- Seed plants which are pollinated by wind are said to be anemophilous.

angiosperm -- n. A group of plants that produce seeds enclosed within an ovary, which may mature into a fruit; [flowering plants](#).

anther -- The pollen producing tip of a **stamen**; part of a flower. [More info?](#)

antheridium -- The organ on a [gametophyte](#) plant which produces the sperm cells.

anthophyte -- A flowering plant, or any of its closest relatives, such as the Bennettitales, Gnetales, or Pentoxylales.

apical meristem -- Group of cells at the growing tip of a branch or root. It divides cells to create new tissues.

archegonium -- The organ on a [gametophyte](#) plant which produces the egg cell, and nurtures the young [sporophyte](#).

axil -- The angle formed between a leaf stalk and the stem to which it is attached. In flowering plants, buds develop in the axils of leaves.

bipinnate -- Describing a pinnate leaf in which the leaflets themselves are further subdivided in a pinnate fashion.

bisporangiate -- When a flower or cone produces both **megaspores** and **microspores**, it is said to be bisporangiate. Most flowers are bisporangiate.

blade -- Any broad and flattened region of a plant or alga, which allows for increased photosynthetic surface area.

bract -- Any reduced leaf-like structure associated with a cone or flower.

bryophyte -- Plants in which the **gametophyte** generation is the larger, persistent phase; they generally lack conducting tissues. Bryophytes include the Hepaticophyta (liverworts), [Anthocerotophyta](#) (hornworts), and Bryophyta (mosses).

carpel -- A unit of the **pistil**; it is evolutionarily a modified leaf.

cataphyll -- In [cycads](#), a scale-like modified leaf which protects the developing true leaves.

columella -- A small column of tissue which runs up through the center of a spore capsule. It is present in [hornworts](#), mosses, and some rhyniophytes.

compound leaves -- n. Leaves with two or more leaflets attached to a single leaf stem.

cotyledon -- n. The "seed leaves" produced by the embryo of a seed plant that serve to absorb nutrients packaged in the seed, until the seedling is able to produce its first true leaves and begin photosynthesis; the number of cotyledons is a key feature for the identification of the [two major groups of flowering plants](#).

elater -- A cell or part of a cell which assists in dispersing spores. The elaters change shape as they lose or acquire water, and they will then push against surrounding spores.

embryophyte -- Synonym for the [Plantae](#), as here defined. It includes all green photosynthetic organisms which begin the development of the sporophyte generation within the [archegonium](#).

enations -- Flaps of tissue such as those found on psilophytes.

endodermis -- Literally "inner skin", this is a layer of cells which surrounds the central core of vascular tissue, and which helps to regulate the flow of water and dissolved substances.

entomophily -- Seed plants which are pollinated by [insects](#) are said to be entomophilous.

epiphyte -- A [plant](#) which grows upon another plant. The epiphyte does not "eat" the plant on which it grows, but merely uses the plant for structural support, or as a way to get off the ground and into the canopy environment.

eustele -- When a plant's vascular tissue develops in discrete bundles, it is said to have a eustele. See also protostele and siphonostele.

fiber -- Elongated and thickened cell found in xylem tissue. It strengthens and supports the surrounding cells.

flower -- Collection of reproductive structures found in flowering plants. [More info?](#)

fruit -- In [flowering plants](#), the structure which encloses the seeds. True fruits develop from the ovary wall, such as bananas and tomatoes, though not all fruits are edible, such as the dry pods of milkweed or the winged fruits of the maple.

grain -- (1) The texture of wood, produced by the kinds of **xylem** cells present. (2) The **fruit** of a member of the [grasses](#).

guard cells -- Pair of cells which surround a **stomate** and regulate its size by altering their shape.

gymnosperm -- n. A plant that produces seeds, which are not enclosed; includes any [seed plant](#) that does not produce flowers.

gynostemium -- The central reproductive stalk of an [orchid](#), which consists of a **stamen** and **pistil** fused together.

habit -- The general growth pattern of a plant. A plant's habit may be described as creeping, trees, shrubs, vines, etc.

herb -- Generally any plant which does not produce wood, and is therefore not as large as a tree or shrub, is considered to be an herb.

heterosporangiate -- Producing two different kinds of **sporangia**, specifically microsporangia and megasporangia. Compare with **heterosporous**.

heterosporous -- Producing two different sizes or kinds of spores. These may come from the same or different sporangia, and may produce similar or different gametophytes. Contrast with **homosporous**, and compare with **heterosporangiate**.

holdfast -- Anchoring base of an alga.

homosporous -- Producing only one size or kind of spore. Contrast with **heterosporous**.

hypha -- n. Threadlike filaments that form the mycelium (body) of a fungus;
hyphae- pl.

inflorescence -- A cluster of flowers.

internode -- The region of a stem between two **nodes**, when there is no branching of the vascular tissue.

lamina -- Any broad and flattened region of a plant or alga, which allows for increased photosynthetic surface area.

leaf -- An organ found in most vascular plants; it consists of a flat **lamina** (blade) and a **petiole** (stalk). Many flowering plants have additionally a pair of small **stipules** near the base of the petiole.

leaf trace -- The strand of vascular tissue which connects the leaf veins to the central vascular system of the stem.

leaflet -- In a compound leaf, the individual blades are called leaflets.

magnoliid -- Any member of the basal assemblage of [flowering plants](#).

mannoxylic -- Wood in which there is a great deal of **parenchyma** tissue among the xylem is called mannoxylic. [Cycads](#) and **pteridosperms** have mannoxylic wood. Contrast with [pycnoxylic](#).

megaspore -- In plants which are **heterosporous**, the larger kind of spore is called a megaspore; it usually germinates into a female (egg-producing) **gametophyte**. Contrast with **microspore**.

meristem -- Group of undifferentiated cells from which new tissues are produced. Most plants have **apical meristems** which give rise to the primary tissues of plants, and some have **secondary meristems** which add wood or bark.

merophytes -- Group of cells which have all been produced from the same initial cell. Leaves and stems in particular are often built from specific patterns of merophytes.

microphyll -- A kind of leaf, specifically one which has a single, unbranched vein in it. Microphylls are only found in the [lycophytes](#).

microspore -- In plants which are **heterosporous**, the smaller kind of spore is called a microspore; it usually germinates into a male (sperm-producing) **gametophyte**. Contrast with **megaspore**.

mycorrhizae -- Symbiotic association between a [fungus](#) and the roots or rhizoids of a [plant](#). [More info?](#)

node -- The region of a stem between two **internodes**, where there is branching of the vascular tissue into leaves or other appendages.

ovary -- In [flowering plants](#), the part of the flower which encloses the **ovules**. When the ovary matures, it becomes the **fruit**.

ovule -- In [seed plants](#), the structure which gives rise to the seed.

paleoherb -- Any member of a group of basal [flowering herbs](#) which may be the closest relatives of the [monocots](#). They include the water lilies, Piperales, and Aristolochiales.

parenchyma -- A generalized cell or tissue in a plant. These cells may manufacture or store food, and can often divide or differentiate into other kinds of cells.

perennial -- A plant which continues to grow after it has reproduced, usually meaning that it lives for several years.

perianth -- The **sepals** and **petals** of a flower are together called the perianth; literally "around the anthers". [More info?](#)

peristome -- A set of cells or cell parts which surround the opening of a moss sporangium. In many mosses, they are sensitive to humidity, and will alter their shape to aid in spore dispersal.

petal -- One of the outer appendages of a flower, located between the outer **sepals** and the **stamens**. Petals often display bright colors that serve to attract pollinators.
[More info?](#)

phloem -- Nutrient-conducting tissue of vascular plants.

phragmoplast -- The cell plate formed during cell division.

phytomelanin -- a papery "sooty" black layer over the seed of plants in the [Asparagales](#), which includes agaves, aloes, onions and hyacinths. It is an important character for defining the group.

pinnately compound -- Leaves which are divided up like a feather are said to be pinnately compound.

pistil -- The central set of organs in a flower; it is composed of one or more **carpels**.
[More info?](#)

pith -- To severely damage the brain of a frog, also any central region of **parenchyma** tissue within a plant stem.

pits -- Thin regions of the cell wall in xylem conducting cells. Their structure is an important characteristic for recognizing different kinds of wood.

plasmodesmata -- Cytoplasmic connections between neighboring cells in plant tissues.

platyspermic -- Having seeds which are flattened and disc-like. Contrast with **radiospermic**.

plicate -- Folded like a paper fan, as in the leaves of palms, cyclanthoids, and some orchids.

pollen -- The **microspore** of [seed plants](#).

pollen tube -- In [seed plants](#), the extension of the male gametophyte as it emerges from the pollen grain in search of the female gametophyte.

pollination -- Process of transferring the pollen from its place of production to the place where the egg cell is produced. This may be accomplished by the use of wind, water, [insects](#), [birds](#), [bats](#), or other means. Pollination is usually followed by **fertilization**, in which sperm are released from the pollen grain to unite with the egg cell.

pollinia -- A mass of fused pollen produced by many [orchids](#).

protostele -- When a plant's vascular tissue develops in a solid central bundle, it is said to have a protostele. See also siphonostele and eustele.

pseudoelaters -- Moisture-sensitive cells produced in the sporangium of [hornworts](#).

pteridophyte -- Plant in which the **sporophyte** generation is the larger phase and in which the **gametophyte** lives an existence independent of its parent sporophyte. Pteridophytes are almost all vascular plants, and include the [lycophytes](#), [trimerophytes](#), [sphenophytes](#), and ferns.

pteridosperm -- An extinct group of [seed plants](#) which bore fern-like leaves.

pycnoxylic -- Wood in which there is little or no **parenchyma** tissue among the xylem is called pycnoxylic. Conifers and [flowering plants](#) have pycnoxylic wood. Contrast with [mannoxylic](#).

radicle -- The end of a plant embryo which gives rise to the first root.

radiospermic -- Having seeds which are round or ovoid. Contrast with **platyspermic**.

reticulate -- Interconnecting, like a network.

rhizoid -- n. A cellular outgrowth of a plant that usually aids in anchoring to the surface and increasing surface area to acquire water or nutrients; found in mosses, liverworts, and hornworts.

rhizome -- n. A horizontal underground stem, such as found in many ferns, where only the leaves may stick up into the air; sphenophytes (horsetails and their relatives) spread via rhizomes, but also produce erect stems.

root -- Usually the below ground portion of a plant. Contrast with **shoot**.

rosette -- A series of **whorls** of leaves or leaf-like structure produced at the base of the stem, just above the ground.

secondary growth -- Growth in a plant which does not occur at the tips of the stems or roots. Secondary growth produces wood and bark in [seed plants](#).

sepal -- The outermost structures of a flower. [More info?](#)

shoot -- Usually, the above ground portion of a plant, bearing the leaves. Contrast with **root**.

siphonostele -- When a plant's vascular tissue develops as a central cylinder, it is said to have a siphonostele. See also protostele and eustele.

spermatophyte -- A [seed plant](#).

sporangiophore -- A stalk to which sporangia are attached.

sporangium -- A chamber inside of which spores are produced through [meiosis](#).

sporophyll -- Any leaf which bears sporangia is called a sporophyll.

stamen -- Part of a flower, the tip of which produces pollen and is called the **anther**. [More info?](#)

stigma -- The sticky tip of a **pistil**. Or, the dense region of pigments found in many photosynthetic protists which is sensitive to light, and thus functions somewhat like a miniature eye. [More info?](#)

stipe -- A scientific term for "stalk".

stipules -- Paired appendages found at the base of the leaves of many [flowering plants](#).

stomata -- Openings in the epidermis of a stem or leaf of a plant which permit gas exchange with the air. In general, all plants except liverworts have stomata in their sporophyte stage.

streptophytes -- The [clade](#) consisting of the [plants](#) plus their closest relatives, the [charophytes](#).

strobilus -- A tightly clustered group of **sporophylls** arranged on a central stalk; commonly termed a "cone" or "flower".

style -- The narrow stalk of the **pistil**, located above the ovary but below the **stigma**.

synangium -- A cluster of sporangia which have become fused in development.

tepals -- When the **sepals** and **petals** of a flower are indistinguishable, they are referred to as tepals. Tepals are common in many groups of [monocots](#). [More info?](#)

thalloid -- Plants which have no roots, stems, or leaves are called thalloid, such as liverworts and [hornworts](#).

tracheophyte -- Any member of the clade of plants possessing **vascular tissue**; a vascular plant.

tree -- Any tall plant, including many conifers and [flowering plants](#), as well as extinct lycophytes and sphenophytes.

tuber -- An underground stem which has been modified for storage of nutrients, such as a potato.

turgor pressure -- Force exerted outward on a cell wall by the water contained in the cell. This force gives the plant rigidity, and may help to keep it erect. [More info?](#)

vegetative growth -- Growth of a plant by division of cells, without sexual reproduction.

venation -- The arrangement and pattern of veins in a leaf.

whorl -- An arrangement of appendages, such as branches or leaves, such that all are equally spaced around the stem at the same point, much like the spokes of a wheel or the ribs of an umbrella.

wood -- A **secondary** tissue found in [seed plants](#) which consists largely of xylem tissue.

xylem -- Water-conducting tissue of vascular plants.

Last updated:2004-04-20



Page has been moved or renamed. Please change your bookmarks.



Cornell University Poisonous Plants Informational Database



This is a growing reference that includes plant images, pictures of affected animals and presentations concerning the botany, chemistry, toxicology, diagnosis and prevention of poisoning of animals by plants and other natural flora (fungi, etc.).

- [Search Poisonous Plants database by name, species affected, primary poison, etc.](#)
- [Alphabetical listing of botanical names by genus and species](#)
- [Alphabetical listing of common plant names](#)
- [Toxic agents in plants](#)
- [Species of animals commonly affected](#)
- [Medicinal Plants for Livestock - Beneficial or Toxic?](#)
- [Frequently asked questions about poisonous plants](#)

Other Web sites concerning poison plants:

- [Indiana Plants Poisonous to Livestock and Pets](#)
- [University of Illinois Plants Poisonous to Animals](#)
- [University of Pennsylvania School of Veterinary Medicine Poisonous Plants Directory](#)
- [A phytochemical database with plants ranked by chemical content.](#)
- [Canadian Poisonous Plants Information System](#)
- [An American bibliographic database](#) (alphabetized).

Many original images were provided by Dr. Mary C. Smith of the Cornell College of Veterinary Medicine. Additional images, text and web pages by Dan Brown and staff. The students of Nutritional Toxicology (Animal Science 625) have also made large contributions through web pages created as term projects. The frequently asked questions is a compilation of some of the questions we have received via email over the years. If you have a question, please browse this list before asking.

Questions regarding content of these pages, contact [Dr. Dan Brown](#)

Home page: [Animal Science at Cornell University](#)

For problems or comments on this web page, contact the Animal Science [Webmaster](#)

511859

California Black Oak Characteristics

[back to California's Oak
Rangeland Species](#)

- [Scientific name](#)
- [Common names](#)
- [Height](#)
- [Mature Tree DBH \(Diam. at Breast Ht.- 4.5 ft. above ground\)](#)
- [Longevity](#)
- [Sprouting](#)
- [Acorn](#)
- [Foliage](#)
- [Shade Tolerance](#)
- [Fire Tolerance](#)
- [Elevation](#)
- [Associates](#)
- [Sites](#)
- [General Notes](#)



Scientific name

Quercus kelloggii Newb.

Common names

Black, California black oak

Height

60 to 90 feet

Mature Tree DBH (Diam. at Breast Ht.)

1 to 4 feet

Longevity

100-200 yrs., occasionally up to 500 yrs.

Sprouting

Excellent sprouter

Acorn

Matures second year; 1-1/2 in. long; thin cup over half the nut





Foliage

Deciduous; 5 in. long; 5-7 lobed; spiny leaf tips; dark yellow-green above and pale yellow-green below

Shade Tolerance

Intermediate tolerance as seedling and intolerant as tree matures



Fire Tolerance

Very sensitive to cambium being killed in hot fires

Elevation

200 to 6000 feet

Associates

Most common with tanoak, madrone, mixed conifer forest species; also with coast live oak, interior live oak, and blue oak

Sites

More common on forest sites; found on moister hardwood rangelands; well-drained soils

General Notes

Protected by Forest Practice Act on timberlands; commercial properties for finished lumber

[back to California's
Oak Rangeland
Species](#)

[back to top](#) | [IHRMP Home](#) | [Purpose](#) | [Personnel](#) | [Oak Assistance](#) | [Publications](#) | [IHRMP Funded Research](#) | [Other Links](#)

©Copyright, 2000. The Regents of the University of California. University of California Integrated Hardwood Range Management Program, UC Berkeley.
For questions and comments, contact [webmaster](#).



CalPhotos: Plants

more photos

[Plants](#)

[Fungi](#)

[Animals](#)

[People &
Culture](#)

[Landscapes &
Habitats](#)

[All CalPhotos](#)

more info

[About
CalPhotos](#)

[FAQ](#)

[Using the
Photos](#)

[Photographers](#)

[References](#)

[Lists of Photos](#)

Browse scientific names:

[A](#) | [B](#) | [C](#) | [D](#) | [E](#) | [F](#) | [G](#) | [H](#) | [I](#) | [J](#) | [K](#) | [L](#) | [M](#) | [N](#) | [O](#) | [P](#) | [Q](#) | [R](#) | [S](#) | [T](#) | [U](#) | [V](#) | [W](#)
| [X](#) | [Y](#) | [Z](#)

Browse common names:

[A](#) | [B](#) | [C](#) | [D](#) | [E](#) | [F](#) | [G](#) | [H](#) | [I](#) | [J](#) | [K](#) | [L](#) | [M](#) | [N](#) | [O](#) | [P](#) | [Q](#) | [R](#) | [S](#) | [T](#) | [U](#) | [V](#) | [W](#)
| [Y](#) | [Z](#) |

This form accesses **44,222** images of plants. A variety of organizations and individuals have contributed photographs to CalPhotos. Please be aware that these various contributors maintain copyright and follow the [usage guidelines](#) provided with each image.

To look for photos, choose a name from one of the lists above, or complete any combination of the fields below and then click *Search*. You can also use the [custom query form](#) for advanced queries.

Scientific Name

example: *Mimulus tilingii* (case unimportant)

Common Name

unimportant *case*

Photo Type

Location

free text description of place.

Country

US State

Cal. County

Collection

Photographer

Photo ID

CalPhotos is dedicated to the memory of [Brother Eric Vogel](#)



[Digital Library Project](#)
University of California, Berkeley
[Questions & Comments](#)



NATIVE AMERICAN SEED

...helping people restore the Earth!

[Shop for Seeds](#) [About Us](#) [Consulting Services](#) [Learning Naturally](#) [Gardener's Corner](#) [Medicine Pouch](#) [Home](#)

Main Page
Special Mixes
Wildflowers
Native Grasses
Conservancy Seeds
Grass Mixes
Books

Gifts & Music
Promotional Packets
Express Order
Print Order Form

Main Page
Who We Are
Why Natives?
From the Field to You

Main Page
Ecological Restoration
FAQ's
Our Clients

Main Page
Outdoor Classroom
For Teachers
Adult Education
Apprenticeships

Main Page
Bulletin Board
Planting Tips
Native Lawns
Resources

Main Page
Prairie History
Reading the Land
Mr. Johnson's Curse
Backyard Revolution

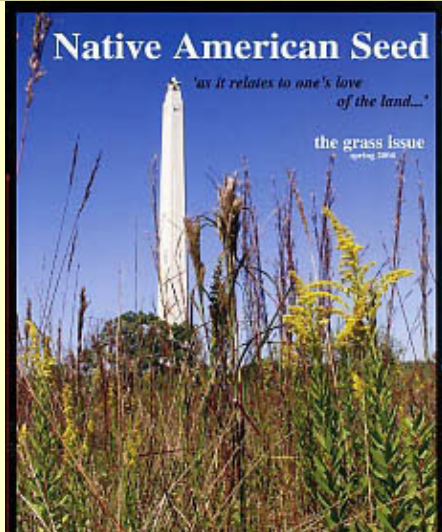

CELEBRATING ANOTHER SPRING...

Our annual spring "Grass Issue" catalog features a cover picture taken at the San Jacinto Monument near Houston. Why? This year, Native American Seed will be working together with the Texas Department of Parks and Wildlife to restore the health and vitality of the unspoiled prairie immediately surrounding this historic place. The rest of the story is told in the pages of the catalog, so if you're not already on our mailing list be sure to send us an [email](#) with your name and address.

Spring is the time to plant native grasses, whether you want to convert your lawn from high-maintenance, water-guzzling exotics to low-maintenance, environmentally friendly natives - or to begin restoring many acres of abused or overgrazed land. We've got all the materials and expertise you need, either right here on the website or just at the other end of a phone call.

Featured This Month



Our [Plant in Spring or Fall Mix](#) is a special blend of 14 perennials including not just the colorful Gayfeather shown here, but some of the most beautiful wildflowers that grow in our region - Standing Cypress, Pink Evening Primrose, Scarlet Sage, Foxglove and Butterfly Weed, to name just a few. Many of these beautiful species can also be used in cut-flower arrangements. Plant them this year and be patient as they develop strong roots in the soil, and enjoy their beauty as they flower for years and years to come.

▶ [Continue...](#)

Special Grass Mixes



If you're planning to establish native grasses in your lawn or on your acreage, spring is the time. Check out the [Planting Tips](#) in our Gardener's Corner for an overview of what's involved. Check the Grass Mixes and Native Grasses categories in the SHOP pages. And as always, you can give us a call if you need help deciding what's best for your combination of soils, temperatures and rainfall. **Pictured Here:** Our [Native Coastal Prairie Mix](#) comes from a conservation harvest we conducted on a sandy Gulf Coast Prairie. If you have acreage near the Gulf that you want to restore, it could be exactly the right mix for you.



NOT JUST BLUEBERRIES...

WILD BLUEBERRIES™



GET BLUE. GET HEALTHY.

TRADE SECRETS

- " [Foods that Fight Aging](#)
- " [Blueberries: A SuperFood](#)

MORE NEWS

- " [Learn About Our New Breakfast Berries™ Campaign](#)
- " [See Berry Burger Story](#) (PDF)

Healthy and delicious, Wild Blueberries have [The Power of Blue™](#). Get your daily dose with easy [recipes](#).

Put the [Power of Blue™](#) to work for you with [Trade Advantages](#), [Sources](#) & [Forms](#), The [Wild Blueberry Association](#) of North America and more.

[About Wild Blueberries](#) | [FAQs](#) | [Press](#) | [Links](#) | [Contact](#) | [Sources](#)

The CNPS home page is now [index.htm](#), please update your bookmarks.
You will be redirected to the index.htm page.
If the page does not refresh, [please click here to continue](#).

Welcome

[About CNPS](#)
[Membership](#)
[Native Plants?](#)
[Fun Activities](#)
[Great Ideas](#)

Action Alerts

Discussions

CNPS Inventory

On-line

CNPS Manual of

California
Vegetation

On-line

Programs, Etc.

[Conservation](#)
[Legislation](#)
[Newhall](#)
[NCCP-HCPs](#)
[UC Merced](#)

[Education](#)
[Plant Science](#)
[Local Flora](#)
[Rare Plants](#)
[Vegetation](#)
[Photography](#)

[Publications](#)
[Fremontia](#)
[Bulletin](#)
[Policy Archive](#)
[State Meetings](#)

[Native Plant](#)
[Conservation](#)
[Campaign](#)

[Events](#)

[Local Chapters](#)

California Native Plant Society



The mission of the California Native Plant Society is to increase understanding and appreciation of California's native plants and to conserve them and their natural habitats through education, science, advocacy, horticulture and land stewardship.

NEW [Inventory of Rare and Endangered Plants User Survey](#)

We want your opinion - please respond by May 14th, 2004

[2002-2003 CNPS Annual Report](#) (PDF, 335k)

[Resources for Professional Botanists](#)

[An Eye on Bush Administration Policies](#)

CNPS Office has moved to
2707 K Street, Suite 1
Sacramento, CA 95816-5113

The links in the navigation bar at left will take you into the main areas of California Native Plant Society (CNPS) web site. At the top of every page, just below the page title, you will find links to more in-depth information. At the bottom of every page are links to other site features such as search and a table of contents.

NEW The old Events & Sales link in the navigation bar has been divided. Now clicking on [Events](#) will take you to a page featuring CNPS Chapter and General events and announcements, such as field trips, wildflower shows, and symposiums. A separate [Plant Sales](#) link now takes you to information on CNPS Chapter and General plant sales. Also, there is now a [Jobs](#) link where you can find job announcements for Botany professionals.

The California Poppy (*Eschscholzia californica*) wildflower collage contains photos from San Felipe by William R. Hewlett, Antelope Valley by Sherry Ballard, Monterey County by Charles Webber, and The Pinnacles by Brother Alfred Brousseau. All poppy photos courtesy of the [Berkeley Digital Library](#).

[[CNPS Home](#)] [[Site Contents](#)] [[Search CNPS](#)]
[[Discussion Forums](#)]

[Plant Sales](#)

[Newsletters](#)

[Kid's Stuff](#)

[Photo Gallery](#)

[Bookstore](#)

[Jobs](#)

[Links...](#)



Dedicated to the preservation of California native flora

California Native Plant Society

2707 K Street, Suite 1 • Sacramento, CA 95816-5113

(916) 447-2677 • fax (916) 447-2727 • cnps@cnps.org

Copyright © 1999-2004 California Native Plant Society. All rights reserved.

the best free
MEDLINE on the web



Network

CENTRE FOR INTERNATIONAL ETHNOMEDICINAL EDUCATION AND RESEARCH

swatch⁺internet time



Home

About

FAQ's

Events

FAQ's - Frequently Asked Questions

FAQ 1. What colleges offer undergraduate or graduate education in the field of ethnobotany?



W. McClatchey, A. Paul, T. Flaster and V. McClatchey. 1999. An Evaluation of Educational Trends in Economic and Ethnobotany.

FAQ 2. What are some suggested readings or books about Ethnomedicine?

more FAQ's coming soon...

Scientific Societies



Society for Economic Botany
2002 Annual meeting
[Vol 55(2)]



International
Society of Ethnobiology



Society of Ethnobiology
[Abstracts]



[Abstracts]

Partners



Educational
Resources

- Discussion Forum
- Listserve
- Projects
- Education
- Resource Directory



[Medicinal Plants
of Madagascar](#)



[Plantas Medicinai
CD-ROM](#)



[Mayan Ethnomedical
Encyclopedia CD-ROM](#)



[Herbal Remedies
CD-ROM](#)



[Rainforest Researchers
CD-ROM](#)

CULTURAL DEBATES
Tom Snyder Productions



[[CONTACT US](#) | [Call for Newsworthy Items](#)]

[Copyright ©1998-01](#). CIEER, Inc. All rights reserved. CIEER is a 501 (c)(3) non-profit organization.

Information on this site is provided for educational purposes and is not meant to substitute for the advice provided by your own physician or other medical professional.

You should not use the information contained herein for diagnosing or treating a health problem or disease, or prescribing any medication. You should read carefully all product packaging. If you have or suspect that you have a medical problem, promptly contact your health care provider.





Calflora

Calflora provides information on wild California plants for conservation, education, and appreciation.

Thank you for your support.

[About Calflora](#)

[Why Registration?](#)

[Why a Fee?](#)

Welcome to Calflora, the on-line gateway to information about

wild plants in California. The pioneering Calflora database facilitates access to a wide array of information concerning California native plants via simple, easy-to-use search pages. Calflora serves the needs and interests of an expanding user community, bringing together professionals, scientists, educators, students and amateurs alike.

Calflora strives to constantly improve. To serve its users better, Calflora requires them to register. If you have not yet registered, click on the [Register as a User or Guest](#) link below. If you have already registered, click the [continue to Calflora](#) link below to login.

- [Register as a User or Guest](#)
- [I'm registered already, continue to Calflora](#)

Behind the scenes... we're making big changes in the Calflora database structure so it will be easier to make updates and add new data. We're doing our best to keep the online system running smoothly through this transition, but please let us know right away if you find bugs: calflora@calflora.org

Job Announcement:

[Executive Director](#)

(1/30/2004)



Fritillaria liliacea
© 1998 John Game



Many thanks to Brent Emerson for his help in hosting Calflora at www.electricembers.net

[About Us](#)

[| FAQ's |](#)

[Media Room](#)

[| Gallery |](#)

[Registration](#)

[| Calendar](#)

[BOSS Course Information |](#)

[BOSS Custom Courses](#)

BOULDER OUTDOOR SURVIVAL SCHOOL

*"BOSS teaches that in a world of dizzying technological change,
less can indeed be more" - USA Today*

Welcome to BOSS

On behalf of all of the instructors and staff here at BOSS, let me say "welcome" to our school and to our website. For over 35 years, people have come to BOSS to learn a field-based, hands-on curriculum of wilderness survival skills. Whether you want the physical challenge of our world-famous **Field Courses**, the intense instruction of our **Skills Courses**, or the adventurous journeys of our **Explorer Courses**, we are excited to give you the attention, personalized instruction, and quality you've come to expect from BOSS.



Quick Links:

[Home](#)

[Site Map](#)

Brochure

Contact Us

BOSS
Basics

About Us

BOSS Staff

BOSS History

BOSS Philosophy
Contact Information

What BOSS is NOT



REQUEST A
BROCHURE



DOWNLOAD OUR
COURSE CALENDAR



What Others Say...

"A step beyond Outward Bound... We recommend BOSS."

- *Men's Health Magazine*

" * * * * (top rating) ...the place to go to gain primitive survival skills."

- *The Ultimate Adventure Sourcebook*

"...the BOSS program is in a league of its own..."

-Shape Magazine

"BOSS is consistently head above the others as the most rewarding survival school."

-Fielding's The World's Most Dangerous Places

"After roughing it with the BOSS, you'll be ready for just about anything...."

- Men's Fitness Magazine

[Click here to read more from the media...](#)

"Congratulations, BOSS! You exceeded my expectations! The course was challenging, inspiring, and educational. Your instructors are top notch, the trip was well planned, and the scenery incredible."

- D. Williams, 7-Day Field Course alum

"The mosquito bites and the scratches are gone. The beard had been shaved, a few pounds have reappeared, but the feelings I experienced are still growing and getting stronger...I can't wait to return!"

- R. Baumann, 7-Day Field Course alum

"I've taken other outdoor and survival courses, but the BOSS courses were the best. The instructors were excellent and really cared about each participant."

- S. O'Conner, Survival Skills I, 7-Day Field Course, Desert Navigator and Mountain Navigator alumna

"The course was a life experience that was the hardest thing I have ever done. It was an experience for my spirit like very few things in our modern world – it taught me basic lessons of life and nature. I can't wait to do more courses with BOSS."

- J. Garey-Sage, 28-Day Field Course, Survival Skills I, Mountain Navigator and Desert Navigator alum

[Click here to read more from our alumni...](#)

Featured Courses: [28-day Field Course](#) | [Desert Astronomer](#) | [Survival Skills II](#) | [Hunter Gatherer](#)

Lost in the Woods The 9 Rules for Survival

SARBC

Search and Rescue Society of British Columbia

Lost in the Woods - The 9 Rules for Survival

by Gary O'Brien, SARBC

PREPARE YOURSELF and YOUR CHILD

Child survival needs adult assistance. You can help children learn what to do if they get lost in the woods, by discussing and practicing the "Rules for Survival".

Nobody ever expects to get lost, but it happens. Hopefully, this information will insure a safe return of your child should this misfortune ever occur.

The Rules are presented in a way which children can understand.

A definition of Survival:

Staying WARM and DRY, while waiting to be found.

1. Stay Together, DO NOT Separate - if with a friend or pet.



The reason for this rule is body heat. Cuddling up to a large dog or friend will help keep you warm. If with a dog, do not let it run loose, it can help you more by staying close and providing heat and companionship.

2. Stay in one place or area. DO NOT WANDER!



This is the MOST important rule of them all. If you wander - We Can not Find You. One reason is that people looking for you move very slowly while searching for clues. If you are out front running along, we won't be able to catch up. Another reason for not wandering is the possibility of falling and hurting yourself while travelling. Being lost and hurt could be tragic.

3. Keep Warm.



This rule means to keep warm with the clothes you are wearing. NEVER take any clothes off. Cover up all the exposed skin you can. If you are wearing a sweater or jacket, do it up. Watch out for your shoe laces. Branches have a tricky way of undoing them. The most important part of your clothing is a hat or something that covers your head. Over 70% of all your body heat escapes through your head.

4. Find a Cozy Waiting Place, Not a Hiding Place.



A cozy waiting place means, a warm place out of the wind and rain but not a place where searchers can not see you. Under a large tree is a good place.

5. Put Out Something Bright.



Put out something bright or make something to tell people searching for you where you are. Make a flag using what you have, but **Do Not Take Off Any Clothes** to do so. Some suggestions are white paper, money, hair ribbons, a strip from an orange garbage bag, etc. Spell the word "HELP" or "SOS" on the ground using rocks and sticks or make a large arrow with them, pointing to where you are. Do anything to attract attention!

6. Look Bigger For Searchers.



If possible, your waiting place should be near an open space. When you hear someone coming, move to the middle of the clearing and call. **Do Not Run** in the direction of the noise. If it is an aircraft you heard, lie down so the pilot has a bigger target to look at. Then wave with both your arms and legs, like making an angel in the snow. Stand up immediately after the aircraft has passed, as the ground can be very cold.

7. Do Not Lie on the Bare Ground.

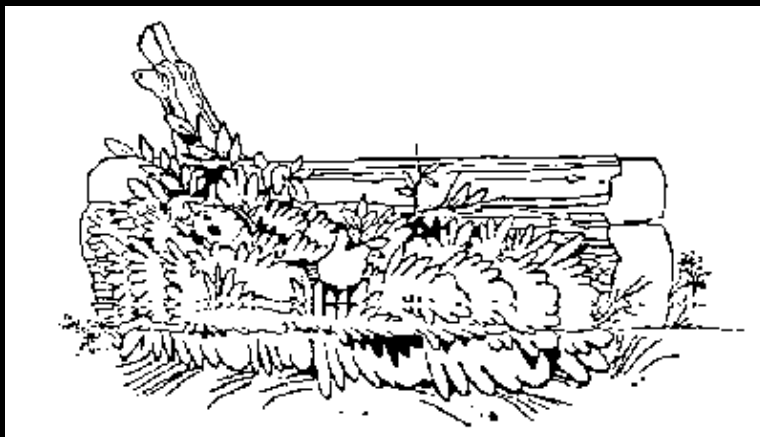

The only exception to this rule is the one above. Laying on the cold ground for a very short period of time, attracting attention, is OK. Being in direct contact with the ground for any length of time is dangerous. The cold ground can rob precious body heat from you. Build a mattress using available materials such as branches, moss, leaves, etc. This mattress should be as thick as the mattress you sleep on at home! After the mattress is completed, gather the same amount or more, of the same material and use it for the blankets. This is called a survival bed.

8. Do Not Eat Anything you are not sure of.



Do Not eat any berries, mushrooms or anything else unless you are 100% sure what they are. Being hungry is not too bad of a feeling compared with being violently sick. And remember, there won't be anyone there to look after you. You can go without food for a long time, but you cannot go without water.

9. **Stay Away from Large Rivers and Lakes.**



You must have drinking water to survive, but be careful where you get it from. Do Not go near any large bodies of water. Instead, drink from a water supply that is smaller than you are, so you can not fall in. Another source of water can be found on leaves in the form of dew.

[Back](#)

[Home Page](#) | [Index](#)

Last Updated: Wednesday, November 01, 1995
by [MCDPRI](#)

Hug-A-Tree National Headquarters



Last Updated 9/23/98

HUG-A-TREE and SURVIVE is a non-profit organization that was started in San Diego, California after a search for a nine-year-old boy who died in the local mountains. A group of the searchers put together an assembly program designed to tell a simple story that will teach young children very basic principles for staying safe in the wilderness. The story captures their interest and is easily remembered.

[History of Hug-A-Tree](#)

[Frequently Asked Questions](#)

[The Program](#)

[Links to other Hug-A-Tree sites](#)

Are you interested in:

- scheduling a presentation to your group, or
- becoming a presenter in San Diego County, or
- starting a Hug-A-Tree program in your area?

For further information about Hug-A-Tree Headquarters, becoming a presenter, or Hug-A-Tree activities in San Diego County, please send a SASE to Hug-A-Tree, PO Box 712739, Santee, CA 92072 USA.

© 1981-1998 Hug-A-Tree. All rights reserved.



Hoods Woods

Become a REAL Survivor!

Hoods Woods Has been offering the best survival information on the Internet since 1992 when Ron grabbed the Survival.com domain name. The domain wasn't just a name either, it described both a lifestyle and what Ron has been teaching and studying since the 1960's. A lot of dirt has been slept in and a lot of time went into bringing you the material on this site. We hope you'll enjoy it!

Ron and Karen Hood have filled this site with gobs of useful [FREE Wilderness Adventure information](#) and resources. Our goal is to make this important information available to everyone. One of our greatest pleasures are the [hundreds of "Thank You" messages](#) we get from our video students, readers and visitors. We know that as you read the information on these pages you will have questions and perhaps would like to share information. That is the purpose of our forum. We invite you to join the [Hoodlums group](#). You will discover a family of great folks willing to share and learn and teach.

The Forum is FREE!

[Click here to get your FREE 2004 Hoods Woods catalog !](#)

Drop on in for a visit at our new [ONLINE store](#) !

WE WON!

[Another Telly Award! Click here!](#)

[News Flash!](#)

[Lots'a new stuff!!](#)

[A few thoughts about the business of survival education.](#)

[Volume 3 - "Survival Kits" DVD is Ready!](#)

(and Re-edited)

[Check out our PAL LED light!](#)

[Cave Cooking 4 is Ready!](#)

[Learn about "Messin' with Meat"](#)

[See the new "Hood Hunter" Custom wilderness Blade](#)

[Hoods Woods wins ANOTHER Telly Award!](#)

[A new Hood joins the Family!](#)

[Read about it!](#)

[ARE YOU PREPARED?](#)

[Deploying to the Middle East?](#)

[Check Steve Doran's Article Here!](#)

Worried about the future?

You NEED to read the articles in our Library and join our FREE forum!

Readings

[Emergency Prep Basics.](#)

[Can the Dependency](#)

[Preparation FAQs](#)

[Don't Panic CBR](#)

- Check out our [customer comments](#).
- [Why should you buy our videos? Click here](#)

<p>What does Sports Afield Magazine think of our videos?</p> <p>Read the Review Here!</p>	<p>Private Label DVD's Available</p> <p>Read about it here</p>
---	--



Copyright ©1998 Hoods Woods. All rights reserved

[PRIVACY STATEMENT](#)

Last Updated
05/05/2004



Welcome to SimplySurvival.com

For over 20 years, Greg Davenport has conducted Leadership Reaction Courses and Wilderness Survival Education programs. Greg's finely honed unique approach to back country travel and survival sets the standard for teaching modern and primitive survival skills while advancing an individuals survival and improvising mind.

[To learn more about Greg's approach to survival click here.](#)

Simply Survival is the creation of [Greg Davenport](#) and is based on his many years of teaching Global Survival and wilderness experience.



Popular Store Item



This survival book collection contains 4 of Gregory Davenport's publications.

- [Wilderness Survival](#)
- [Wilderness Living](#)
- [Surviving Cold Weather](#)
- [Surviving Coastal & Open Water](#)

**On sale NOW
for only
\$53.44**

[Click to learn more](#)

Read what Others have had to Say about **Greg Davenport**

For Testimonials from previous Simply Survival students please [click here.](#)

[Sign up for our e-News by clicking here.](#)



Want to know what Greg is up to? Sign up here.

Simply Survival News

Nathan Jones, who represents Hydration Technologies (HTI), recently demonstrated a new water filter that is sure to revolutionize the water industry. The emergency water filtration system converts any water source (no matter how filled with dirt or biological pathogens) into pure drinkable water. It requires no pumping, doesn't clog, and uses a re-hydration formula that supplies much needed electrolytes and nutrients to the consumer. In the photograph below, Nathan demonstrates the XPack water filtration system using an extremely muddy water source. For more information on this product, go to [Hydration Technologies web site](#)



We have an extensive photo gallery that covers our various courses and programs.

Rick Arnold, an old friend and member of the Survival Incorporated team, stopped by during a recent trip to Washington State. Rick recently retired from the USAF SERE team and took a position with Survival Inc's military sales team. He has some great ideas and I am sure we will see great things from him in the future. For more information go to the [Survival Incorporated's web site](#).



◀ Go Back

▲ Back to Top

© 2003 Simply Survival, ANEW, Inc. All Rights Reserved.

Simply Survival.

P.O. Box 449 / 1551 Loop Road
Stevenson, WA 98648
Phone: 509.427.4022 | Fax: 509.427.4023
[Click here to contact us via e-mail](#)



"The more you know,
the less you need."

Welcome to the Aboriginal Living Skills School, LLC

Arizona has been our home since 1987. With more than 18 years of southwestern experience, ALSS is northern Arizona's oldest and best known wilderness survival and primitive living skills school. While large enough to accommodate virtually all of your training needs, we are a small school and consciously choose to remain so as this allows us to maintain the highest level of quality possible. At ALSS, our focus remains on getting better, not bigger.

Due to Arizona's incredible terrain variation, we teach courses as wide-ranging as desert survival and winter camping, ensuring flexibility to meet your needs. Our field courses are held in the field, not just outside, allowing you to explore and harvest natural materials directly from a wilderness environment for optimal realism and enjoyment. Time tested programs are continually updated with new and exciting skills while limited enrollment ensures you personalized instruction, maximum adventure and fun!

At ALSS, we remain dedicated to sharing with you some of the most honest, well rounded self-reliance and preparedness training available. In short, feel free to look over our [training advantages](#), and peruse my [instructor profile](#) and [media achievements](#). If you have questions regarding the ALSS experience, please don't hesitate to contact me.

Primitively Yours,

Cooylunsin

Founder, Director, and Lead Instructor, ALSS, LLC



Content and Images ©1999-2004 Aboriginal Living Skills School, LLC. All rights reserved. [Web design by JoeStarDesign.com](#)

Home
FAQ's
Course
Calendar
Instructor
Profile
In the News
Contact Us
& Register
Abo Store
Gallery
Amazing
Arizona
ACES
98.6°:
The Book
Site Map

Mountain Man Survival

"just 'cause we're all created equal, doesn't mean we have to stay that way"

Come on in!

There have been **58705** survivors pass through these parts.

Primitive Ways

[RESOURCES](#) | [WORKSHOPS](#) | [FIRE](#) | [TOOLS](#) | [MUSIC](#) | [SKILLS](#) | [PLANTS](#) | [EVENTS](#) | [URBAN](#) | [GALLERY](#)

[The PrimitiveWays™ Book](#)

[The PrimitiveWays™ CD](#)

What's New

[Register for the 20th Annual Rattlesnake Rendezvous
held at Sunol-Ohlone Regional Wilderness
May 28 - 30, 2004](#)

[Evidence of Ancient Campfires](#)

[Bare-Handed Basket](#)

[Black Dye](#)

[Visit the library on Franklin Street in the city of Mountain
View, California and the library on Forest Avenue in the city
of Palo Alto, California. PrimitiveWays has an exhibit of
primitive technology tools
and hunting implements in the lobby display case.](#)

[Thumb Loop Hand Drill Fire Kit](#)

[Become a Member of the Society of Primitive Technology](#)

Resources



[E-mail Questions Answered \(new additions weekly\)](#)

[The PrimitiveWays™ CD](#)

[The PrimitiveWays™ Book](#)

[Recommended Books & Magazines](#)

[Movies of Interest \(Entertainment, Educational, and How-To videos\)](#)

[Stores that Offer Resources for Primitive Technology Projects](#)

[TRADING POST - items for sale](#)

[A \\$5 Friction Fire Starter Kit](#)

[Thumb Loop Hand Drill Fire Kit](#)

Workshops & Classes



[Old Ways Workshops - 2004](#)

[KAHIKO Workshops of Native Skills](#)

[MAPOM Spring Classes - 2004](#)

[20th Annual Rattlesnake Rendezvous, Sunol-Ohlone Regional Wilderness, May 21 - 23, 2004](#)

[17th Annual Rabbitstick Primitive Skills Conference: September 12-18, 2004](#)

[What to Teach Kids and Why](#)

[Sharing Old Ways With The Young](#)

Fire Making & Primitive Cooking



[Evidence of Ancient Campfires](#)

[Some Uses of Fire](#)

[Starting Fire](#)

[With a Lens Made From Ice!](#)

[The Egyptian Bow Drill](#)

[Fire-By-Friction: Materials of the San Francisco Bay Region](#)

[Fire](#)

[The Two-Stick Hearthboard](#)

[Miracle of Fire-by-Friction](#)

[Making Fire with a Bow Drill](#)

[Making Fire with a Hand Drill](#)

[Fire-by-Friction with Damp Materials](#)

[Spindle Extension for a Fire Bow Drill](#)

[Fire-by-Friction Methods of the Australian Aborigines](#)

[Smallest Bow Drill](#)

[Fire-by-Friction Set](#)

[Primitive Cooking](#)

[Adobe Horno](#)

[Bamboo Rice Cooker](#)

[The Secrets of the Sinew](#)

[Cordage Backed Bow](#)

[Making an Asiatic Composite Bow](#)

[Making a Bow From a Sapling](#)

[A Foolproof Method for Bow Tilling](#)

[Fletching By Hand](#)

Primitive Tools & Projectiles



[Arrow Straightening](#)

[Making an Atlatl from a Branch](#)

[Jiffy Arrow & Atlatl Dart Fletch
Using Duct Tape](#)

[Atlatl Dart Tuning](#)

[Atlatl Flexibility Analysis](#)

[Simple Atlatl Spear Thrower
Construction](#)

[Atlatl in Ancient Rock Art](#)

[Bamboo Clay Thrower](#)

[How to Make a Wooden Canoe
Paddle](#)

[Spears, Weirs and Traps](#)

[The Hoko Knife - A quick, simple
stone tool](#)

[The Stone Saw](#)

[The Scapular Saw](#)

[Antler Handle Knife](#)

[Scallop Baking Shells](#)

Musical Instruments & Magic



[Bone Flutes](#)

[Primitive Quail Call](#)

[Primitive Hand Made Reed Flute](#)

[Sycamore Membranophone](#)

[Puniu - Hawaiian Knee Drum](#)

[Deer Hoof Rattle](#)

[Musical Instruments of Central
California](#)

[Random Thoughts on
Tradition vs. Technology](#)

[Primitive Crystal Light!](#)

**Early
Technology
&
Traditional
Skills**



[Weaving a Lauhala Mat](#)

[Processing Shark Skin into Rawhide](#)

[Brain Tanned Buffalo Hides](#)

[Tanning a Fox Hide](#)

[Pelt Bag](#)

[How to Make a Rabbit Skin Blanket](#)

[The Ties that Bind and Bindings that Tie](#)

[What Knot to Use in a Primitive Situation](#)

[Pomo Netting](#)

[Cordage Fiber Shredder Made From Bone](#)

[Making Cordage By Hand](#)

[Introduction To Tule Ethnobotany](#)

[Pomo Tule Bittern](#)

[Klamath Twined Tule Visor](#)

[Paiute Tule Duck Decoy](#)

[Ajumawi Fish Traps](#)

[Inuit Thimble](#)

[Willow Rake](#)

[The Three-Stick Roycroft Pack Frame](#)

[Making a Leather Knife Sheath](#)

[Steam Bending Wood](#)

[Log Ladder](#)

[Four Hour Kayak](#)

[How to Paint a Mammoth](#)

[Black Dye](#)

[Wilderness Grooming](#)

Useful Plants & Shelters



[Thirty Years in the Jungle!](#)

[Was Agriculture a Good Idea, or an Act of Desperation?](#)

[Calendar of Harvesting and Gathering](#)

[Coppicing](#)

[Bare-Handed Basket](#)

[Useful Plants of California \(1\)](#)

[Useful Plants of California \(2\)](#)

[Useful Plants of California \(3\)](#)

[Nature's General Store: The Yuccas and Agaves](#)

[The Ti Plant Called Ki](#)

[Olona](#)

[Hemp Dogbane](#)

[Hawaiian Plants \(a trip to the Big Island\)](#)

[Bull Whip Kelp](#)

[Fishing with Poisons](#)

[Fishing with Hawaiian Plants](#)

[Cattail Pollen Pancakes](#)

[Quiz: Can You Name These Plants?](#)

[Thatched Ohlone Style House](#)

[How to Build an Igloo](#)

[Scout Pit](#)

[The Primitive Sauna](#)

**Events
&
Primitive Trips**



- [I Belong To This Country \(an Australian adventure\)](#)
- [Native California Fall Gathering at San Luis Reservoir State Recreation Area](#)
- [Rattlesnake Rendezvous](#)
- [Australian Aborigine Flint Knapping](#)
- [Primitive Field Day at Stanford University](#)
- [Coyote Hills Knap-In and The Gathering of Ohlone People](#)
- [Winter Count](#)

**Hand-Made
Tools
&
Urban
Resources**



- [How to Make Your Own Steel Knives](#)
- [Folding Saw](#)
- [Johnstone Tools](#)
- [Portable Shaving Horse](#)
- [Urban Resources](#)
- [Alternative Supplies for Urban Dwellers](#)
- [Wilderness & Urban Tips](#)
- [Fire by Chemical Reaction](#)

**Gallery
&
Links**



- [Photo Gallery I](#)
- [Photo Gallery II](#)
- [Photo Gallery III](#)
- [The Info Super Highway Refugee](#)
- [Interesting Links](#)



**PrimitiveWays began in 1998 and is produced by
[Dick Baugh, Bob Gillis, Norm Kidder, Chuck Kritzon, Ken Peek, and Dino Labiste.](#)**

The [excerpts by Steve Watts](#) (President of the [Society of Primitive Technology](#)) summarizes our philosophy on practicing and teaching primitive technology.

E-mail your comments to "Dino Labiste" at dlabiste@yahoo.com, "Bob Gillis" at shelter@best.com,
"Richard A. Baugh" at oldfella37@msn.com, "Norm Kidder" at atlatl1@aol.com,
"Chuck Kritzon" at chuckk@petroglyphics.com, or "Ken Peek" at kspeek123@earthlink.net

© **PrimitiveWays** 1998 - 2004

All rights reserved.

No photo files on this website may be copied or reproduced without express written consent from the photographer.

No part of this website may be copied or reproduced without express written consent from PrimitiveWays.

Hot Links to the Wonderful World of Boomerangs

Welcome to **Boomerang World** - Flight-Toy's **Boomerang Home Page** with links to everything you need to know about the fascinating world of boomerangs. This site is continually updated as visitors provide new link information. The links to the left will take you to web pages for specific geographical regions. If you have any links to add (or find any broken links), please email [Ted Bailey](mailto:Ted.Bailey@flight-toys.com).

Hot Links to Boom Pages in:

[Australia](#)

[Asia/Africa](#)

[Canada](#)

[Europe](#)

[South America](#)

[USA](#)

[un-boomerangs](#)

Back to:

[Flight Toys](#)

Important Boomerang Links

[Boomerang Catalog](#) | [Boomerang Auction](#)

[Boomerang Software](#) | [Boom Links for Kids](#)

[Br. Brian Thomas Memorial](#) | [World Cup 2004](#)

[Miscellaneous Boom Info](#) | [Boomerang Calendar](#)

[Key Boomerang Throwing Contacts](#)

Back to: [Flight Toys](#) | [email Ted Bailey](mailto:Ted.Bailey@flight-toys.com)

www.PaleoDiet.com - The Paleolithic Diet Page

What the Hunter/Gatherers Ate

Also see the www.PaleoFood.com Recipe Collection and the www.Foraging.com Page

Index to Sections Below

- [Sites by Individuals](#)
- [Educational Institutions](#)
- [Media Reports](#)
- [Associations/Organizations](#)
- [Foraging and Ethnobotany](#) <-- now on its own page.
- [Commercial Sites](#)
- [Books](#)
- [Food Vendors](#)
- [Dehydrators](#)
- [Food Science](#)
- [Mailing Lists/Archives/Forums](#)

Sites by Individuals

- [Introduction to the Paleolithic Diet](#) is Ben Balzer's page. He is a family physician in Australia. Probably the clearest introduction on the web.
- Second Opinions is a site by Barry Groves, PhD. It includes many articles exposing dietary and medical misinformation. A selection of them: [The Naïve Vegetarian](#) is a long article covering various diets with a focus on pointing out the fallacies of vegetarianism. [The Cholesterol Myth](#) points out there is no evidence that eating cholesterol is bad. [Does Animal Fat Really Cause Cancer?](#) points out that an examination of a couple of studies that came out in July 2003 does not support the claims that media is making for them. [Polyunsaturated Oils and Cancer](#) argues that polyunsaturated oils increase cancer risk. [William Banting: The Father of the Low-Carbohydrate Diet](#) is a history of the first low carb diet, which was also paleo.
- [Paleolithic Nutrition: Your Future Is In Your Dietary Past](#) is an article Jack Challem wrote for Nutrition Science News: April 1997.
- [An Interview with Ward Nicholson](#) now has three parts on the web. Good overview of man's diet over the past 65 million years. Long but highly recommended reading. First published in Chet Day's "Health & Beyond" newsletter. Now part of a very comprehensive [Beyond](#)

[Vegetarianism](#) site. Every argument that your vegetarian friends use to avoid meat for health reasons is debunked here.

- Tamir Katz's [Paleolithic Diet Information](#) page has been put up by a medical student at SUNY Stony Brook. He has a knack of clearly and directly explaining things. Excellent for friends and relatives of paleo eaters who are wondering why you eat weirdly.
- [Neanderthin \(Paleo\) eating](#) is Vad's page where he tries to sum up, super concentrated, what this whole thing is about. Includes menus, weight loss, and more.
- In [On the Benefits of Ancient Diets](#) Staffan Lindeberg discusses how the Western diet causes health problems. Also an overview of his Kitava study. Staffan now has a home page [Utbildningarom prevention](#), though initially only in Swedish.
- [Living Longer, yes! But living well?](#) by Dr. Anthony G. Payne is a general article that also gets into a paleo diet.
- A diet high in phytic acid, which can be found in whole grains (it's in the bran) and beans like soy, is very detrimental for mineral absorption. Phytic acid strongly binds to minerals like calcium, iron, zinc and magnesium to form insoluble salts, phytates, which precipitate from the body. Staffan Lindeberg has written a [summary on phytic acid](#).
- Two common foods clearly are Neolithic and avoiding them is key to a paleo diet. Here are link pages for avoiding them: [Gluten-Free Page](#) and [No-Milk Page](#).
- There are some disorders that can be controlled somewhat by using a paleo diet. Here are link pages on three of them: [Autism](#) and [Multiple Sclerosis](#) and [Rheumatoid Arthritis](#).
- JoAnn Betten of the PaleoFood mailing list and I have collected many recipes at [www.PaleoFood.com](#). All have no grains, no gluten, no dairy, no beans/legumes, no refined sugar, or other Neolithic foods.
- Ashton Embry has an essay [Paleolithic Nutrition and Multiple Sclerosis](#) and another [Paleolithic Nutrition](#). He's the leading proponent on the Net for using dietary intervention to control MS.
- [The Evolution of Human Nutrition](#) by Barry Bogin is interesting reading which covers themes like homo erectus and up to date findings, and the relation to nutrition.
- In William Calvin's [The Ascent of Mind, Chapter 8](#) he discusses why he thinks that the Acheulian hand-axe (the oldest of the fancy stone tools of Homo erectus) was really a "killer frisbee." He argues that natural selection for throwing accuracy, which requires brain machinery, is the evolutionary scenario for bootstrapping higher intellectual functions. There are many more articles about evolution and human development throughout William's [extensive site](#).
- [Pemmican: Recipes, Stories and Stores](#) is a link page with more on this than you've seen before.
- Lynne Olver at the Morris County Library has assembled [The food timeline](#), which gives you the history of Neolithic foods. Includes paleo foods, like animal domestication and when some foods were first noted in the literature.
- [Eating](#) is an essay by Todd Moody.

- [The Meat, Leaves and Berries Page](#) is a "paleo" like diet put up by Dan John. But dairy products are allowed. Couldn't tell much, as many pages came up blank with ActiveX turned off.
- [Dental Microwear Web Site](#) is on the study of the microscopic scratches and pits that form on a tooth's surface as the result of its use. See the page on references. Some are evidences of past diet.
- Mary G. Enig, Ph.D., an expert of international renown in the field of lipid chemistry, has a [Trans Fat InfoWeb Page](#). A simple introduction to trans fatty acids. [Trans Fatty Acid Fact Sheet](#) is a short page listing the negative highlights of this food.
- [Factors that Inhibit Calcium Absorption](#) is an article pointing out the non-paleo things we do, mostly food related, that are negative for calcium absorption.
- [The Cholesterol Myths](#) by Uffe Ravnskov, M.D., Ph.D. argues that too much animal fat being dangerous is a myth. This is a collection of essays, complete with the critical references.
- [The Cholesterol Myth](#) is an article by Thomas J. Moore from his book, Heart Failure. Argues that diet has hardly any effect on your cholesterol level; the drugs that can lower it often have serious or fatal side effects; and there is no evidence at all that lowering your cholesterol level will lengthen your life.
- Dr. Joseph Mercola has an extensive web site on alternatives to traditional medicine. A hodge podge of different things. On his [Low Grain Guide To Health](#) he has a few that are relevant to paleo eating. At bottom take link to his Sugar Index Page. Also see [The Health Benefits of Grassfed Animal Products](#). Also see [Low Grain and Carbohydrate Diets Treat Hypoglycemia, Heart Disease, Diabetes Cancer and Nearly ALL Chronic Illness](#). Also see: [Caveman Cuisine](#) by Sally Fallon and Mary G. Enig, PhD.
- There is ample evidence that [grain consumption is behind many cancers](#). Here is a quick analysis of the connection.
- Jack Challem has written [Alpha-Lipoic acid: Quite Possibly the "Universal" Antioxidant](#) and meat is the best source.
- [paleofood.de](#) is a site all in German, but [PaleoFood.Info](#) is their English version. Here is Loren Cordain's [Food Pyramid](#).
- [To Crack a Coconut](#) tells how this is done in Thailand, without fancy tools, then gets into pressing milk, and some recipes.
- [Cooking Clan of the Cave Bear Style!](#) is a student experiment in boiling water in a skin pot over a fire (or not...)
- Aris Stathakis has a page [How To Make Real South African Biltong](#) - a traditional South African dried meat.
- Brett Saks, B.S., D.C. has a page [The Adverse Effects of Wheat and Other Grains](#). Based on his clinical experiences.
- Chet Day sent a copy of the article by Robert Crayhon ([Interview with Loren Cordain](#)) to

the Rea Centre in London, a place claiming to be proponents of a paleo diet. You can check out their counterpoint at [Hunter Gatherer Paradigm Examined in New Light](#). It argues that our ancestors were not big meat eaters. Argues that since men are the scientists that hunting has been exaggerated out of proportion, and that gathering was the primary source of food. Chet Day also asked some questions and created [The Rea Center Interview: Paleo Nutrition, Veganism, and More](#). Incredibly wordy with little content.

- Philip Thrift has a page on [Principles of Paleofitness](#). He follows NeanderThin and works out daily before eating.
- [Blindness, Mad Cow Disease and Canola Oil](#) by John Thomas points out the negatives of canola oil.
- The [Venison Processing FAQ](#) covers everything from choosing your target to recipes.
- [The Paleolithic Diet](#) is Bob Hodgen's story of his experiences on NeanderThin. Includes short explanation.
- Krispin Sullivan has written [The Lectin Report](#). A good place to start to learn about these toxic proteins in Neolithic foods.
- [Aquatic Ape Theory](#) is a site covering all links on the subject. (The theory argues that humans evolved along the water's edge, but such evidence is now covered by the oceans.)
- Buried in the middle of [The Revised Metabolic Oncolytic Regimen for Effecting Lysis in Solid Tumors](#) one can find their diet recommendations for tumor control. It has a paleo diet orientation. Protein is 35%, preferably Omega 3 rich. Carbohydrates (also 35%) are only vegetables and fruit, no beans, bread, potatoes, or any grain. Then dietary and supplemental forms of fat should provide 20-30% of (daily) calories.
- [WWW.PALEODIET.NU](#) is a site in Swedish put up by Niclas Larsson. He has plans to grow the site.
- Aletheia Price has [Edible Insects](#). Very comprehensive. Read the "About the Author."
- [Weird & Different Recipes](#) is a page by Bert Christensen that includes several insect recipes and other foods that a Paleolithic dieter may have eaten.
- Zachary Huang has put up his [Bug-Eating Page](#). Mostly pictures of people eating giant silkworms and mealworms. Also see his other links.
- [Vad är Paleodiet?](#) is a site in Swedish put up by Hans Kylberg.

[\[Ctrl-Home for Top, or Click Here\]](#)

Educational Institutions

- [The Paleo Diet](#) is Loren Cordain's site. It promotes his book and also includes, for free download, PDF files of all of his scientific articles on Paleo Diet.
- [Diet and Heart Disease. It is not what you think](#) is a online course by Stephen Byrnes covering the Lipid Hypothesis.
- [Cooking up quite a story: Ape, human theory causes evolutionary indigestion](#) is an article by

- William J. Cromie discussing the controversy over how long humans have been cooking.
- Buried in a tutorial at The Institute For Ice Age Studies we find a section on Strategies for Survival. Hunting and gathering start at [Scheduling and Mobility](#).
 - [Plant-animal subsistence ratios and macronutrient energy estimations in worldwide hunter-gatherer diets](#).
 - [Origins and Evolution of Human Diet](#) is an academic web site devoted to discussion of evolution and the human diet. Especially don't miss the articles on the conferences link! And in them especially see the [Boyd Eaton one!](#)
 - [Hunters and Gatherers Anthropology](#) is a course taught by Raymond Hames at U. of Nebraska. Includes lecture notes on the book [The Foraging Spectrum](#) which outlines the important research issues, theory, and problems in hunter-gatherer research. His site has many other sub-pages that shouldn't be missed.
 - [How to Carve an Elephant](#) is a chapter in Making Silent Stones Speak: Human Evolution and the Dawn of Technology by Kathy D. Schick and Nicholas Toth (1993). A cute writeup on some archaeologists that showed that a dead elephant can be carved up using the simple tools that were available 1.5 - 1.9 million years ago.
 - [Prehistoric Diet and Nutrition](#) is a class at Indiana U. taught by Jeanne Sept, Professor of Anthropology.
 - [Plant-animal subsistence ratios and macronutrient energy estimations in worldwide hunter-gatherer diets](#), by Cordain et. al. is an abstract of an analysis showing that whenever and wherever it was ecologically possible, hunter-gatherers consumed high amounts (45-65% of energy) of animal food.
 - [The Changing Nature of Inuit Nutrition and Dietary Patterns](#) by James H. Boschma III goes into detail on the dietary patterns of the Inuit.
 - Cabrillo College's Anthropology Department has [Monte Verde A Pre Clovis Site](#), which among other things, discusses the foods these early Native Americans ate.
 - [From the Neolithic Revolution to Gluten Intolerance: Benefits and Problems Associated with the Cultivation of Wheat](#), by Luigi Greco, Department of Pediatrics, U. of Naples. A history of gluten intolerance and why it is so common.
 - [Investigation of the Role of Wild Plant Foods in Pre-Agrarian Europe](#) is a project currently being undertaken by Sarah Mason at the University College London.
 - [Plains Archaic people](#) discusses the hunter-gatherers of the American plains. These PaleoIndians big-game hunters exploited a narrow-spectrum, focal resource base (one, maybe two animal species depending on location - e.g., reindeer in north; limited range of small game; few if any plants). Long and technical.
 - [Underwater storage techniques preserved meat for early hunters](#) demonstrates how PaleoIndians living in the Great Lakes region at the end of the last Ice Age preserved meat from large animal kills by storing it underwater.
 - [Flints and Stones: Real Life in Prehistory](#) is an exhibition at the Museum of Antiquities on the world of the late stone age hunter gatherers in Britain. Only three pages are food related:

- [The hunter gatherer way of life](#) is heavy on the tools used in Britain. [Tasks and activities around the home fire](#) has some on food processing. [Could you survive today as a hunter gatherer?](#) has pictures of collectable foods and you select whether it is edible or not. In three parts: fungi, foliage, and nuts & berries. More than half of the options are poisonous.
- [Health Issues and Trans Fat](#) by Mary G. Enig discusses how it was claimed in 1958 that these were culprits in heart disease, but the edible oil industry quickly squelched this information.
 - [Do dietary lectins cause disease?](#) is an editorial in the British Medical Journal which suggests that lectins, which are high in cereals, potatoes, and beans, may be behind some autoimmune diseases.
 - [You Are What You Eat: New Theories About Rheumatoid Arthritis](#) is a newsreport about an article in the British Journal of Nutrition. The authors argue that their theory implicating diet needs more research.
 - [The Southern Greek Palaeolithic, Mesolithic, and Neolithic Sequence at Franchthi](#) is a cave where the deposits revealed what the occupants ate over the years.
 - [Stone Age Habitats](#) hasn't much to do with food, but there is mention of cooking hearths, and a couple nice graphs. But for some reason the time lines are flipped.
 - Fattening cattle with corn changes the lipid balance and is clearly not the natural diet for a grass eating cow. In [Simple change in cattle diets could cut E. coli infection](#) researchers have found that when cattle were fed hay or grass for just five days before slaughter, much less E. Coli cells were present in the animal's feces and virtually all surviving E. coli bacteria were not acid-resistant and were killed by human stomach acid.
 - A [Hunter-Gatherer Bibliography](#) compiled by students of James W. Helmer Department of Archaeology, U. of Calgary. 112K.
 - J. Ned Woodall, Department of Anthropology, Wake Forest U., teaches a course on Problems with the Past: Controversial Topics in the Cultural and Physical Evolution of Humans. Here is the [reading list](#).
 - ['First farmers' with no taste for grain](#) is an article by Mike Richards on the use of meat in ancient British Isles diets. The suggestion is that the Brits were depending primarily on meat for their nutrition up to around 2000 B.C.
 - ['Man the Hunter' returns at Boxgrove](#). Mark Roberts, the Director of the Boxgrove Project, provides evidence that the hominids of the Lower Palaeolithic period did hunt their meat.
 - [In sorrow shalt thou eat all thy days](#) Peter Rowley-Conwy, Archaeology at the University of Durham, argues that many hunter-gatherers never wanted to farm.
 - [No carefree life for Mesolithic people](#). Hunter-gatherers worked much harder for their living than has previously been thought, writes Rob Young.
 - Neanderthal bone chemistry provides food for thought. Using bone-chemistry analyses, a team determined the Neandertals must have feasted on meat. [Neanderthal diet at Vindija and Neanderthal predation: The evidence from stable isotopes](#) is the full text of the article.
 - Kristin D. Sobolik is Assistant Professor of Anthropology and Quaternary Studies at U. of

Maine. She has a [home page](#) listing her publications, many of which are on prehistoric diets.

- [Blueberries May Restore Some Memory, Coordination and Balance Lost with Age](#) is a study from Tufts U. which found that blueberries make rats feel young again.
- [Human Skeletons and Society in Prehistoric Italy](#) basically shows how various ills increased in the Neolithic age. The best parts are the graphs showing the disorders they found and how they increased as the food become more away from a Paleolithic diet. This is the link to [infectious disease and childhood stress](#).
- [Loren Cordain, Ph.D.](#) has his interests, awards, publications, etc. listed on a web page.
- An abstract: [Reducing the serum cholesterol level with a diet high in animal fat.](#) by Newbold HL.
- Hunter/gatherers often eat grubs. Entomologists at the [University of Iowa](#) have created some recipes based on insects, and insects can be bought via internet.
- [The Food Insects Newsletter](#) site includes selected on-line articles from back issues. Probably more paleo than most people can handle.
- [Bugfood!](#) is by the U. of Kentucky Department of Entomology. Discusses insects as food and insect snacks from around the world.
- [Nutritional Value of Various Insects per 100 grams](#) is part of the Iowa State Entomology site. Also see recipes and where to buy.

[\[Ctrl-Home for Top, or Click Here\]](#)

Media Reports

- [New road reveals Stone Age site](#) which may provide evidence of fire in the British Isles back between 250,000 and 300,000 years ago.
- [High-cholesterol diet 'doesn't increase stroke risk'](#) reports on a study of 43,000 middle-aged men. While it finds no correlation with stokes and fatty foods, they did not look for a correlation with anything else.
- [Meat eating is an old human habit](#) reports on an analysis of our ancestor's teeth that shows we became meat eaters 2.5 million years ago.
- Vilhjalmur Stefansson spent many years as an Eskimo among Eskimos. After a year experiment eating only meat at Bellevue Hospital, he wrote about his experiment and his years as an Eskimo in [Adventures in Diet](#), a three part series Harper's Monthly Magazine, November 1935 - January 1936.
- In [Chips means zits](#) Loren Cordain blames today's refined foods, such as bread, rice and cakes, for the pimples suffered by 95% of westernized teenagers.
- [Neanderthals' strong-arm tactics revealed](#) discusses whether they threw spears or just used them to stab animals.
- [Food for Thought, Dietary change was a driving force in human evolution](#) is an article in Scientific American that discusses our evolution in the context of diet.

- [In prehistoric cave, scientists use computers as their guide](#) lists off the diet of some middle Paleolithic era cave dwellers in Northern Israel.
- [Animal Protein Consumption Associated With Bone Density in Elderly Women](#). This isn't really new. Herta Spencer back in the 80's showed that meat helped if an adequate amount of calcium was consumed. Studies showing that protein was bad used isolated, fractionated amino acids from milk or eggs.
- In [Bread blamed for short sight](#) Jennie Brand Miller links the dramatic increase in myopia in developed countries on childhood over-consumption of bread.
- [Meat Eating More Healthy in Prehistoric Times](#) discusses the healthier fats in wild meat. Loren Cordain's team compared the muscle, brain, bone marrow and fat of wild animals with those of cattle.
- [The Caveman Diet](#) by Jeanie Davis is an MSN article touting the benefits of grass fed bison.
- [Cave men diets offer insights to today's health problems, study shows](#). But, you have to eat wild meat, which has a healthier ratio of omega-6 to omega-3 fatty acids.
- [High 'Good' Cholesterol Level Lowers Stroke Risk](#) is a news report highlighting that high HDL is the only indicator of lower stroke risk. However, it fails to mention that a low-carb diet is the only diet that increases HDL.
- [Neanderthals Were As Smart As Us](#) reports on new research that reveals that Neanderthals were not dumb, but had the technical and intellectual skills to put them on an equal basis with modern humans.
- [Seafood Gave Modern Humans Edge](#) reports that by studying the chemicals that remained in the bones of the earliest modern humans, scientists discovered that their diet, included fish and fowl as well as large mammals. The Neanderthals, on the other hand, only ate large mammals, which became extinct. Also see [Fishy clue to rise of humans](#).
- [Agriculture Is Bad for You](#) is a Time Europe article pointing out that some dieticians recommend we change our eating habits to resemble those of our ancestors. A pro-Paleo article!
- [Coconut oil promises to be anti-viral agent](#) reports on trials that have confirmed that coconut oil has an anti-viral effect that reduces the viral level in HIV-AIDS patients to undetectable levels.
- [The Soft Science of Dietary Fat](#) is a summary of an article in Science Magazine reporting that mainstream nutritional science has demonized dietary fat, yet 50 years and hundreds of millions of dollars of research have failed to prove that eating a low-fat diet will help you live longer. In fact, there are good reasons to believe high-carbohydrate diets may be even worse than high-fat diets. Here is the [original article](#).
- [Fatty Fish Protects Hearts of All Ages](#) reports that those who consumed fatty fish even just once a week lowered their risk of a fatal heart attack by 44% compared to the risk among those who did not opt for the fish.
- [Homocysteine A Possible Risk Factor For Alzheimer's](#) discusses an association between Alzheimer's disease and moderately-elevated blood levels of the amino acid, homocysteine.

Homocysteine levels can be reduced by consumption of foods with folic acid and vitamin B12, i.e. greens and meat.

- [Diabetics Improve Health With Very High-Fat, Low Carb Diet](#) discusses a successful study.
- [Early Humans Had Woodworking Technology](#) reports on finding evidence that humans produced wood tools, possibly spears, 1.5 million years ago. This is a million years earlier than previously believed.
- [Early Humans Ate Termites](#) reports that ancient hominids had a taste for termites.
- Harvard Magazine on [Paleolithic Fast Food](#). By excavating a cave they found that animals that move slower were eaten in the past and in later years ones that move faster were eaten.
- [The discovery of fire](#) speculates that man controlled fire 1.6 million years ago. Circumstantial evidence also suggests that they were cooking their food.
- [Insulin-Like Compound Predicts Stroke Risk](#) states that insulin resistance (which is usually caused by excessive carb intake, meaning that caused by normal intake of grains and sugar) is a predictor (i.e. indicates increase risk) of strokes.
- [Go back to stone-age diet, says health professor](#) is an interview with Loren Cordain.
- [New Human Ancestor?](#) Two and a half million years ago a humanlike creature in what is now Ethiopia raised a stone and smashed it down on an antelope bone to get at the marrow and fat inside. This is the earliest known evidence of a stone tool used to butcher an animal.
- [New Species Of Human Ancestor](#). A more detailed version than the ABC News one. They also ate catfish and horse. Note the bit about "high fat meat"!
- [Fossil find may be 'missing link'](#). A third page on 2.5 million year old fossil find in Ethiopia.
- [Olive oil 'reduces cancer risk'](#) claims that using olive oil in cooking may prevent the development of bowel cancer.
- Scientific American has an interesting article about the ill effects of sugar and aging at: [AGE Breakers - Rupturing the body's sugar-protein bonds might turn back the clock](#). Typically, the drug companies are trying to develop a drug to fight off the symptoms rather than treating the cause of the problems with a proper diet.
- [A taste for meat](#) argues that our ancestors three million years ago ate a lot of small mammals that could be caught without tools. Published in [Science Magazine](#) (which requires a subscription).
- [The Caveman Diet](#) is the CBS story on 48 hours where they featured Ray Audette and the paleo diet. Focuses on weight loss.
- [Modern Stone Age food](#) is an article based on an interview with Boyd Eaton that appeared in the USA Weekend insert magazine.
- In [What the Hominid Ate](#) by analyzing carbon atoms in tooth enamel researchers challenge the widely held belief that these 3 million year ago homnoids ate little more than fruits and leaves.
- The Electronic Telegraph had a 12-Aug-97 article ["Barbecues are a thing of the past"](#). Some archaeologists from Liverpool University working in the Suffolk forest found what they

believe may be a hearth that is 400,000 years old. [Free registration required]

- [Revealing Anciet Family Ties](#) is a chart of our human lineage. It is included as it has arrows at the 2.5 million year mark showing when stone tools and meat eating were introduced. See also: [article introduction](#) and [main text](#).
- [Great Debate Builds the Rationale for Eating Meat](#) is the story of how Dan Murphy debated the PETA and the arguments he used. (You will need to scroll down a bit).
- [Eating Like a Caveman](#) is a page written by Kathleen Doheny. She gives an overview of the paleo diet, then tells of her experience of trying it for a day. Includes this quote by Loren Cordain "If it's a fad, it's the oldest fad going."

[\[Ctrl-Home for Top, or Click Here\]](#)

Associations/Organizations

- [The International Network of Cholesterol Skeptics](#) has a [Discussion about the cavemen's diet](#). Has comments from many researchers, some familiar from elsewhere on this page. No comments from Lorain Cordain, but much discussion and disagreement with him.
- [The Weston A. Price Foundation](#) was set up by Sally Fallon and Mary Enig. Like the Price-Pottenger Nutritional Foundation, with which they were previously affiliated, it is not completely paleo in its recommendations. But lots of good articles nonetheless. See [The Oiling of America](#). Also see [Guts and Greast: The Diet of Native Americans](#). And what they think of Loreen Cordain's [The Paleo Diet](#). And many other articles.
- A small subset of the people eating only raw foods are eating animal foods (RAF). And some of them have put up a resource page for [Raw Paleolithic Diets](#).
- [Protein-Rich Diets May Reduce Heart Disease Risk](#) is a report on a prospective cohort study showing higher protein intake is associated with reduced risk of heart disease among women. Though this report is filled with politically correct commentary which was not part of the study as published.
- [Food](#) is part of the Vegan Straight-Edge site. The page is almost a resource page for paleodiet, with the sole exception of the comments about meat and protein requirements. It's quite interesting. Other pages at the site include: [The origins of agriculture - a biological perspective and a new hypothesis](#) in which Greg Wadley & Angus Martin argue that the shift to cultivation and animal domestication was due to the "comfort" derived from the opioid peptides from gluten. And John Coleman's [Opioids In Common Food Products-Addictive Peptides In Meat, Dairy and Grains](#). (There isn't any evidence presented that this is an issue with meat, but it is a vegan site!)
- [Paleolithic diet](#) is a definition found in the Gale Encyclopedia of Alternative Medicine.
- Nutrition Australia has a Q&A page on: [I have read somewhere recently about a 'Paleolithic diet'. What exactly is the 'Paleolithic diet'?](#) Written as an introduction.
- A hunting rights group has put up [Eating Meat is Natural](#), written by Jim Powlesland. It appears to be a summary from "The Paleolithic Prescription: A Program of Diet & Exercise

and a Design for Living".

- [Diet and the evolution of the earliest human ancestors](#) is a study of jaw size and shape, tooth size, shape, and wear patterns, which give clues as to what the earliest human ancestors ate two to four million years ago.
- [Fatty Fish Cuts Risk Of Death From Heart Attack In Elderly](#) is another study showing the benefits of omega-3 fatty acids consumption.
- [Concerns Regarding Soybeans](#) by Mary Enig and Sally Fallon discusses the negatives with soy consumption. Abstracted from Health Freedom News, September 1995.
- [Soy Online Service](#) is a New Zealand site dedicated to "uncovering the truth about soy".
- [Tragedy and Hype](#) is a very comprehensive article on soy that appeared in Nexus Magazine. Shows how the soy industry manipulated things to turn their toxic food into a health food.
- [Should we be Scared of Soy?](#) covers the various health negatives of soy consumption.
- [Ray Peat's Newsletter](#) has a web site with some sample articles. There are two articles of interest to Paleodieters: "The Benefits of Coconut Oil" and "Toxicity of Unsaturated Oils". When you click on them then select open. A Ray Peat coconut oil article also appears Dr. Mercola's site: [The Benefits of Coconut Oil](#).
- [Coconut: In Support of Good Health in the 21st Century](#) by Mary Enig is an address she gave to a Cocotech meeting. Long and gets into coconut oil's competition. Many references at the end.
- [Review and Atlas of Paleovegetation](#). Preliminary land ecosystem maps of the world since the Last Glacial Maximum (18,000 14C years ago).
- American Scientist had an article on [Chimpanzee Hunting Behavior and Human Evolution](#) by Craig B. Stanford in the May-June 1995 issue. It discusses British primatologist Jane Goodall's observations.
- [Paleolithic Diet: How our bodies want to be treated](#). is a page from The Healing Crow, an organization dedicated to bringing the aspects of mind, body, and spirit into our health.
- The [Price-Pottenger Nutrition Foundation](#) promotes some Paleolithic nutrition concepts, though they recommend dairy, a non-paleo food. Many good articles worth reading there.
- [Why I Am Not a Vegetarian](#) by Dr. William T. Jarvis makes comments about the "ideological" commitment to a diet that are at least as interesting as the comments about diet itself.
- [Trans Fat Spells Double Trouble for Arteries](#) points out that the popular trans fat is unhealthy and not disclosed on food labels.
- [Desert Locust Recipes](#) from the Food and Agriculture Organization.
- [Croque-insectes](#) is all in French. The site is on insects, and cooking them is part of the site.

[\[Ctrl-Home for Top, or Click Here\]](#)

[Foraging and Ethnobotany](#) <-- now on its own page.

Commercial Sites

- [Was Agriculture a Good Idea, or an Act of Desperation?](#) by Norm Kidder is an interesting essay on evidence that hunter-gatherers sometimes became so good at getting food that they settled down to form permanent communities. From the [Primitive Ways](#) site.
- [The Caveman's Banquet](#) is Atkins' take on the paleo diet.
- [A Diet Solution Based on Evolution](#) points out that most of the calories consumed today are from foods that did not exist in the past, but then the article ends up with the politically correct twist that saturated fats are bad. Mostly is a book report on Loren Cordain's The Paleo Diet.
- [The Paleolithic Diet and Its Modern Implications](#) is an interview with Loren Cordain, PhD done by Robert Crayhon, MS. The same article also appears here: [The Paleolithic Diet and Its Modern Implications](#).
- [The Myths of Vegetarianism](#) by Stephen Byrnes goes through many of the arguments that vegetarians use and explains why they are myths. A must read for all vegetarians.
- [The Lectin Report](#) explains the background on lectins and their connection to health problems.
- [The Homocysteine Revolution](#) is an interview with Dr. Kilmer McCully. High homocysteine levels have been connected with heart disease. Folic acid (highest in leafy green vegetables) and B12 (abundant in animal proteins) help keep homocysteine levels under control.
- In an interview with Mary G. Enig, Ph.D. She expresses clearly her well qualified opinion that saturated fats are NOT the problem they are reputed to be. Over two pages: Health Risks from Processed Foods and Trans Fats [Part 1](#) + [Parts 2 + 3](#).
- [Insulin and It's Metabolic Effects](#) by Ron Rosedale MD deals with insulin as the "master switch" for a large number of disease processes. Argues that low insulin is key for long lifespan. Overly long.
- Elson M. Haas, M.D. has written a nice summary of [Types of Diets](#). Has sections on the Paleolithic and 14 other diets. Put up by Healthy Net.
- Dr Stoll's [Sugar and Immunity](#) is an article on the Leukocytic Index which shows the devastating effect of refined carbohydrates on immunity.
- [The Skinny on Fat](#) is an overview of the different types of fat and their uses in the body by Dr. Michael G. Kurilla, M.D.
- Jonathan Bowden, M.A. has a two part non-technical introduction to [The Paleolithic Diet](#).
- [Why Americans Are So Fat](#) by William Faloon blames a deficiency of conjugated linoleic acid (CLA) for why we have become fat. CLA is found in beef and milk fat, both of which are decreasing in our diets. In addition CLA is much lower in grain fed cows than in grass fed ones.

- [Just Game Recipes](#) has just what it says. Not all are paleo, but lots of good ideas for cooking game.
- [The Australian Native Food Industry](#) gets into Australia's unique edible plants and animals that could form the basis for a substantial and sustainable industry.
- [Eskimo Ice-cream](#) discusses food in the Inuit culture and includes some recipes.

[\[Ctrl-Home for Top, or Click Here\]](#)

Books

Note that prices at amazon.com are no longer the cheapest. Books can be purchase elsewhere for less. The place I use is [Books-a-Million](#), which is cheap when using their discount card. Now the best advice is to shop around and not to automatically buy from amazon.com. One suggestion for price comparison is BookFinder4U. Except it doesn't reflect free shipping deals. May even be helpful in finding out-of-print books.

- [The Paleo Diet: Lose Weight and Get Healthy by Eating the Food You Were Designed to Eat](#) is Loren Cordain's book. His [publisher's page](#).
- [NeanderThin: Eat Like a Caveman to Achieve a Lean, Strong, Healthy Body](#) by Ray Audette is based on the ideas of paleolithic nutrition. The diet contains natural, unprocessed carbohydrates and can be followed as a low-carb, moderate or high carb diet, depending upon whether and how much fruit is used. The expanded hard cover edition can be found at [Amazon.com](#). Also see Amazon.com for many [reviews on the out-of-print edition](#). A [paperback edition](#) is now out.
- [Life Without Bread: How a Low-Carbohydrate Diet Can Save Your Life](#) by Christian B. Allan, Wolfgang Lutz. It is based on Dr. Lutz's work with thousands of patients in Austria. It deals with the health issues connected to high carb consumption. It is basically an English version and update of Dr. Lutz's 1967 book with the same title: *Leben ohne Brot*. He recommends eating only 72 grams of carbohydrates, and an unlimited amount of fat. And provides evidence as to why this is the healthiest diet. Read the review at Amazon.com by Todd Moody.
- Protein Power by Eades and Eades was a best seller for over a year. Now they have published [The Protein Power Lifeplan: A New Comprehensive Blueprint for Optimal Health](#). It uses many paleo arguments for their diet recommendations. All easy to understand. And also a [Paperback Edition](#).
- [Meat-Eating and Human Evolution \(Human Evolution Series\)](#) is a \$70 book that address the questions surrounding when, how, and why early humans began to eat meat. See and read the sample pages.
- [Evolutionary Aspects of Nutrition and Health - Diet, Exercise, Genetics and Chronic Disease](#) is a compilation of articles showing how humanity's genetic makeup has been directly influenced by nutritional selective pressures and how our present day diet may be discordant with our stone age genome. The book is rather expensive, but the description on

the page is worth reading. One section is now entirely online! See [Cereal Grains: Humanity's Double-Edged Sword](#) by Loren Cordain.

- The book [The Cholesterol Myths](#) by Uffe Ravnskov, MD, PhD, is a much expanded version of [his web site](#). See [reviews at amazon.com](#).
- [Lights Out: Sleep, Sugar, and Survival](#) recommends a very paleo-like diet, and they also make a good argument for electric lighting as a major contributor to modern health problems. It's written in a very magazinish, overblown style, but the reasoning is overall sound.
- [Starch Madness: Paleolithic Nutrition for Today](#) by Richard L. Heinrich. Has a foreword by Barry Sears of Zone fame. For Publishers Weekly and author's review see [Amazon.com](#).
- [Diet Prevents Polio](#) by Dr Sandler is a web site on a 50 year old book where he argues that low blood sugar, due to a high carb diet, makes one susceptible to polio, and other viruses and disease. He did research showing that a meat based diet, very low carb, keeps blood sugar stable.
- [Survival of the Fittest](#) is a "Darwinian Diet and Exercise Program" by Del Thiessen providing nutritional and activity strategies. Notes our "Stone-Age" relatives were free of the most common diseases of civilization. No reviews yet at [Amazon.com](#).
- [Nutrition and Evolution](#) by Michael Crawford and David Marsh explains how diet may have shaped evolution. Heavy reading. See reviews at Amazon.com. Now unfortunately out-of-print
- [The Carnitine Miracle](#) by Robert Crayhon, M.S. The nutrient carnitine is abundant in red meat. According to Crayhon carnitine helps balance blood lipids and blood sugar levels, maximizes energy levels, increases endurance, eliminates discomfort in ketosis, promotes burning of fat and building of muscle and increases overall well-being. See reviews at [Amazon.com](#).
- Dr. Weston Price's book [Nutrition & Physical Degeneration](#). puts to rest a lot of myths about diet, dental, physical, and emotional health, and presents the strongest case for a super-nutritious Native (or Paleo) Diet. His book outlines the conditions/causes for exceptional health. A classic that was first published in 1938.
- Diana Schwarzbein is another M.D. that has come to realize that low carb is what works. See reviews at [The Schwarzbein Principle](#). The book is based on her work with insulin-resistant patients with Type II diabetes. She concludes that low-fat diets cause heart attacks, eating fat makes you lose body fat, and it's important to eat high-cholesterol foods every day.
- From September to December, 1997, Robert McFerran posted draft chapters of his book, [Arthritis - Searching for the Truth - Searching for the Cure](#), to the Ask Dr Stoll Bulletin Board. Includes his view of human history and its relationship to dietary needs.
- [Nourishing Traditions: The Cookbook that Challenges Politically Correct Nutrition and the Diet Dictocrat](#) by Mary G. Enig, Ph.D. and Sally Fallon. The premise is the culinary traditions of our ancestors, and the food choices and preparation techniques of healthy nonindustrialized peoples, should serve as the model for contemporary eating habits.

However, they push whole grains and dairy, which aren't Paleolithic.

- Arthur De Vany Ph.D. is writing a book called [Evolutionary Fitness](#) on "What Evolution Teaches Us About How to Live and Stay Healthy".
- [The Stone Age Diet](#) was written by Walter L. Voegtlin back in 1975. It is out-of-print. However we have put up his [Functional and Structural Comparison of Man's Digestive Tract with that of a Dog and Sheep](#).
- [The Cambridge World History of Food](#) encapsulates much of what is known of food and nutrition throughout the span of human life on earth. Selected chapters are online.
- Excerpts from [Dismantling a Myth: The Role of Fat and Carbohydrates in our Diet](#) by Wolfgang Lutz MD. Covers various digestive disorders. See newer English edition above.
- Peter D'Adamo's serotype diet book [Eat Right 4 Your Type](#) is in sympathy with the paleo diet approach, at least if you are Type O.
- Online books on the Hunza people: [The Wheel of Health](#) by G.T. Wrench, M.D. [High Road to Hunza](#) by Barbara Mons. [The Healthy Hunzas](#) by J.I. Rodale.
- [Ishmael](#) is the website of Daniel Quinn, who has written several popular books. He believes that humans are just one of the species on earth and shouldn't keep increasing their agricultural food supply, which just leads to increased population at the expense of other species.
- Ian Tattersall has written [Becoming Human: Evolution and Human Uniqueness](#). In [Chapter One](#) at the beginning there is a discussion of the diet about 40 kyr ago.
- Barry Sears, Ph.D., has a couple books on his Zone Diet. Somewhat paleo in its orientation. [Zone Home](#) is one of the sites on the diet.
- Charles Hunt has written [Charles Hunt's Diet Evolution](#). It is not truly a paleo diet, but more of a low-carb diet. Its subtitle is "Eat Fat and Get Fit". The author is PR oriented and studied up on the web and then wrote the book. Now out-of-print.
- [We Want to Live](#) is a book by Aajonus Vonderplanitz. His basic philosophy is that (a) food is to be eaten in a live, raw condition; and (b) a diet rich in raw fats and raw meats from natural sources is essential to health. [From the Planets](#) is a book review by Ralph W. Moss, and at [Amazon.com](#) there are reader reviews. The [Live-Food Mailing List](#) discusses the concepts of this book.
- [Man Eating Bugs: The Art and Science of Eating Insects](#) by Peter Menzel, Faith D'Aluisio gets laudatory reviews at amazon.com.

[\[Ctrl-Home for Top, or Click Here\]](#)

Food Vendors

- [3-Corner Field Farm](#), on the border of NY and Vermont, sells grass-fed lamb.
- [Alaskan Harvest](#) sells only fresh ocean caught fish, as well as range fed reindeer and muskox.

- [American Grass Fed Beef](#) sells beef meat, jerky, sticks, and bacon from Missouri. (Their bratwurst and summer sausage are not paleo.)
- [Arctic Wild Harvest Company](#) in Canada has several unique foods harvested from their arctic wilderness.
- [Arizona Nut House](#) has a variety of [Nutcrackers](#) for sale.
- [BisonCentral.com](#) has lots of info on bison, plus a [long list of places selling bison](#).
- [Callie's Organics](#) is a home and office delivery business with a variety of organic and specialty produce, and other organic foods. Warehouse is in the Bronx.
- [Conservation Beef](#) is a group of ranchers selling grass-fed meat from Montana.
- [Cranberry Lane](#) has coconut oil, palm oil, and the hard to find red palm oil. Scroll down.
- [Crowfield Farm](#) sells bison meat. No mail order. Delivery from Rochester east to Lyons.
- [D'Artagnan](#) has organic game and poultry, and wild mushrooms. Expensive.
- [Diamond Organics](#) ships certified organic greens, fruits, mushrooms and sprouts throughout the US.
- [eatwild.com](#) has a page on Why Grassfed is Best! Contains a comprehensive list of suppliers of grassfed meat in all 50 states plus Canada. Also, the "New Research" section is a good database of citations on the benefits of grassfarming. And a book is for sale.
- [Fallow Hollow Deer Farm](#) sells online naturally raised, grass fed meat, poultry and eggs.
- [Falster Farm](#) in San Antonio, TX raises miniature Hereford cows, and sells pasture raised poultry and eggs. Poultry are raised to order.
- [Farm To Table](#) connects you to New York State farmers. Put in your location and it tells you where farmer's markets are.
- [Fox Fire Farms](#) in Colorado sells natural lamb, a true free range product raised on pasture.
- [Frank's Organics](#) delivers to parts of Australia. Included are fresh fruit, vegetables, eggs, meat, and dried fruit and nuts.
- [Frieda's](#) sells specialty produce and markets over 500 items including exotic fruit, specialty vegetables, dried fruits and nuts, mushrooms, squash, and a wide variety of Asian and Latin foods.
- [Game Sales International](#) is a direct importer of wild game meats, game birds, and specialty foods.
- [Garden Spots Distributors](#), in PA, has some organic dried fruit. Nuts don't appear to be organic. Apparently they carry organic produce, poultry and beef, but none of these appear at the web site.
- [GourmetStore.com](#) specializes in gourmet items, especially unusual and hard-to-locate dried items. See a variety of chile powders, and roasted chestnut and hazelnut flours.
- [Grassland Beef](#) sells grass fed beef. Raised and shipped from Missouri.
- [GreatBeef.com](#) is a network of independent family farmers and ranchers. Use the site to locate producers in your area.

- The [Gunthorp Farm](#) raises pigs that have been pastured. They are in Indiana.
- [Hay Creek Stock Farm](#) sells beef, pork, and lamb. Located in Minnesota.
- [Heartland Farms](#) in Pakenham, Ontario sells grass-fed beef and other grass-fed farm products. Local sales only.
- [Hills Foods Ltd](#) sells organic meats, game meats, and specialty poultry; including guaranteed wild (no grains) animal such as wild Arctic Caribou, alligator and muskox. They also have some non-meat wild associated specialty items.
- Homestead Products has a page on [Grain Mills](#). While they don't get into nuts, the Country Living Mill is a burr grinder and suitable for them.
- [Hunt's Black Walnut Cracker](#) is for those with a walnut tree in their back yard. This is a serious device.
- [Jaffe Brothers](#) in California features an extensive line of organically grown and untreated dried fruits, nuts, dates, seeds, and other select products.
- [Jamaican Gold](#) is a premium hand made coconut oil. See story of how it is made.
- [K.C's Game Meat Market](#) in Coldwater, Ontario raises elk, buffalo and deer on grass and a small amount of grain.
- [Lasater Grasslands Beef®](#) sells truly free range beef.
- [Living and Raw Foods Resources](#) list many resources for organically grown food.
- [Living Tree Community](#) sells Organic Raw Almond Butter, organic nuts, and organic dried fruit. Also has recipes section.
- [Lucy's Kitchen Shop](#) sells almond flour.
- [Maine Coast Sea Vegetables Inc.](#) offer four organically certified varieties: alaria, dulse, kelp, and laver.
- [MacFarlane Pheasant Farm](#) sells pheasant and a whole line of game meats.
- [McRoberts Game Farm](#) offers a variety of exotic meats, such as llamas, elk, yak and yak-crosses, white buffalo, Pere David Deer, miniature donkeys, and bactrian camels.
- [McRoberts Gourmet Foods](#) has Yak Jerky by mail order, in addition to other yak products.
- [Meadow Raised Meats](#) is an association of farmers in NY State that ship beef, chicken, pork, veal, lamb, goat, and venison.
- [Mt. Banahaw Tropical Herbs](#) in the Philippines offers unrefined Virgin Coconut Oil.
- [Mount Royal USA](#) bills themselves as "The Venison and Game Meat Connection." All farms feature farm-raised game using controlled diets that are free of steroids, growth hormones and antibiotics.
- [Mountain America Jerky](#) sells fresh made-to-order gourmet game meat jerky. No preservatives - No MSG - No growth promoters or steroids.
- [The Natural Food Hub](#) is a directory of many food vendors. They have a hunter/gatherer attitude towards food. See information on natural foods. Also a nice collection of edible wild plant and animal links. A site to spend time at.

- [Nature's First Law Online Superstore](#) has organic sun dried fruit. See sun-ripened, raw, organic olives and mangoes.
- [New West Foods](#) has buffalo, ostrich, and wild game. Formerly Denver Buffalo Company. Whether bison is grass or grain fed is not known.
- [North Hollow Farm](#) in Vermont sells naturally grown beef and pork. Some corn is fed to them.
- [Northstar Bison](#) in Wisconsin sells totally grassfed "buffalo." Can order on the web for next Monday shipping.
- Nuts4U sells [coconut flour](#), and other nut flours.
- [Omega Nutrition](#) sells coconut butter and some nut oils.
- Organic Kitchen, the organic foods resource for the web, maintains a long list of [organic food vendors](#).
- [Organics Direct](#) in London UK has an extensive organic delivery service offering fruit and vegetables.
- [Outlands Natural New Zealand Meat](#) Products. Beef comes from cattle raised from birth to bite, outside on ranches with evergreen pastures. Can be bought in Whole Foods stores.
- [Overseas Game Meat Export](#) is an outfit in Australia that supplies Australian game meat from the Outback to health food stores.
- [Peaceful Pastures](#) sells by mail all the common farm meats. Site does not say that the diets are not supplemented by some grain. E-mail asking this question was not answered.
- [Pinyon Pinenuts](#) are collected in the wild by George & Penny Frazier. Site also has some pinenut information.
- [Polarica](#), with a retail store in San Francisco, sells exotic meats and other gourmet foods.
- [Promofood International](#) sells rendered goose fat and some other oils.
- Coconut oil and palm oil are good for frying and are considered Paleolithic. Palm oil is best for deep fat frying. [Rainbow Meadow](#) sells them on the web.
- [Really Raw Honey](#) is totally unprocessed so it still contains pollen, propolis, honeycomb and live enzymes.
- [Rehoboth Ranch](#) in Texas sells grass fed beef and lamb over the web.
- [Rougie Rendered Goose Fat](#) is tasty and recommended for cooking, as olive oil breaks down at a relatively low temperature.
- [Sandhills Red Angus](#) raises grass fed beef in Nebraska. While they sell cuts, they focus on selling whole, half, quarter, and eighths of a beef.
- [Seattle's Finest Exotic Meats](#) has all natural farm raised exotic meats from around the world.
- [Smoky Hill Bison Co.](#) in Kansas sells many different cuts and boxes of bison meat. Grass fed.
- [Southern Game Meat](#) sells a brand of kangaroo meat internationally.

- [Special Foods!](#) has lots of unusual flours. Some are paleo! Check out: malanga, yam, lotus, water chestnut, and artichoke.
- [Starr Organic](#) in Florida sells mail order citrus, mangoes, avocados, bananas, limes, and lemons. Prices at site may not be current.
- [SunOrganic Farm](#) has dried fruit, nuts, nut butters, and other foods.
- [Texas Bison Company](#) sells grassfed bison meat.
- [Texas GrassFed Beef Company](#) is a marketing alliance for cattlemen who raise beef on grass. They sell beef by the cut in addition to bulk purchases. They also have lamb, goat, pork and poultry. All products come from critters eating grass or legumes and some browse. NO GRAIN!
- [The Little Canadian Meat Company](#) sells beef raised without growth hormone implants, digestive stimulants or antibiotics. Animals are grassfed and forage on certified organic pastures. Available on the Ontario area.
- [Three Fork Creek Ostrich Ranch](#) sells meat over the web.
- [Urban Organic](#) delivers organic produce to the NY Metropolitan area.
- The [Valley Livestock Marketing Cooperative](#) supplies grass fed beef, pork, lamb, veal and chickens from Hudson Valley farmers. They will ship by mail, or you can pick it up.
- [VERMONTBEEF.COM](#) sells pure Vermont pasture finished beef.
- Paleolithic eaters avoid grains, but they do eat nuts and seeds. These can be ground into flour for baking. Research finds that there are three types of grinders, but only one suitable for oily foods, the burr grinder. Walton Feed has a good description of the types at [Which Grinder is Best For You?](#)
- [Waterfall Hollow Farm](#) sells pasture-finished beef raised on certified-organic pasture. Now also selling pasture-raised chicken.
- [White Egret Farm](#) is a family farm in Texas raising drug, and pesticide free goats, beef, pork, turkeys, chicken, and guinea fowl. Ships direct to consumers.
- [Whole Foods Market](#) carries pasture fed meats, and many other organic foods. Web ordering and stores around the US under different names.
- [Y.S. Organic Bee Farms](#) has totally pure, unprocessed, unfiltered, raw bee products.

[\[Ctrl-Home for Top, or Click Here\]](#)

Dehydrators

- [The Dry Store](#) has the American Harvest [GardenMaster Dehydrator](#). This is one of the two leading choice for serious dehydrating. Can run with 30 trays.
- The [Excalibur Dehydrator Website](#) includes a pitch for dehydrating foods and showcases their dehydrators with square trays that slide in like a drawer, and not stacked like the round ones. This is the other leading choice.

- [Excalibur Dehydrator](#) has quite a bit of information on dehydrating, including its history, along with a sales pitch to buy their high-end dehydrators.
- Living Foods sells the Excalibur line. See [View all Dehydrators](#).
- The [L'EQUIP Model 528 Food Dehydrator](#) is a rectangular model that can have up to 20 trays. Has computer-controlled dehydrator sensor.
- Has [Dehydrators](#) made from the finest birch plywood. Plus they have a book for sale.
- [The Harvest Saver](#) is a compact, small volume drying system. They also have [A Basic Look at Dehydration](#) which covers the technical aspects of dehydration from a commercial point-of-view.

[\[Ctrl-Home for Top, or Click Here\]](#)

Food Science

- Wild Side of the Menu is a three part site on wild game: [Care and Cookery](#) and [Field to Freezer](#) and [Preservation of Game Meats](#).
- The National Food Safety Database lost its funding and it seems that only pieces now remain. The [Food and Nutrition Publications](#) page has a couple of links to Fruit Freezing and Home Drying in the General section. The wild game info is gone.
- [Drying and Curing Food](#) points to articles from the Michigan State University Extension, the Florida Cooperative Extension Service, and other sources.
- [USDA Nutrient Database for Standard Reference](#) can be searched for all common foods.
- The [California Rare Fruit Growers](#) has information on hundreds of different fruits.

[\[Ctrl-Home for Top, or Click Here\]](#)

Mailing Lists/Archives/Forums

- The PaleoDIET mailing list is a RESEARCH oriented list. To get a subscription questionnaire send a message to listserv@maelstrom.stjohns.edu with SUB PALEODIET yourfirstname yourlastname in the body. Actual subscriptions are processed by the list owner. Searchable [archives of the mailing list](#) are available.
- The PaleoFOOD mailing list is a SUPPORT list for people trying to follow a Paleolithic diet in today's age. The FAQ for the list is [NeanderThin](#). See first link in the Book section. To subscribe send SUB PALEOFOOD yourfirstname yourlastname in a message body to listserv@maelstrom.stjohns.edu. Searchable [archives of the mailing list](#) are available. Also see [Other Archives](#).
- The PaleoRECIPE mailing list is a RECIPE list is a companion list to the PaleoFOOD list. To subscribe send SUB PALEORECIPE yourfirstname yourlastname in a message body to listserv@maelstrom.stjohns.edu. Searchable [archives of the mailing list](#) are available.
- [CaveManFood](#) is a Yahoo group on how to eat like our CaveMan ancestors. Light activity.

- There is now a newsgroup called alt.support.diet.paleolithic that is independent of the mailing lists. It is not very active.
- A mailing list now exists on Evolutionary Fitness. To subscribe send SUB EVOLUTIONARY-FITNESS yourfirstname yourlastname in a message body to listserv@maelstrom.stjohns.edu. Searchable [archives of the mailing list](#).
- [PADIET-L](#) is an e-mail based discussion forum for topics relating to the origins and evolution of human diet. Little activity. See [list archives](#).
- [AV-Skeptics - Aajonus Vonderplanitz Skeptics](#) provides a democratic forum for people to deflate the exaggerated promises, fraudulent claims, junk science, invented evidence, and humorous exploits of raw meat gadfly Aajonus Vonderplanitz.
- [Live-Food Mailing List](#) for persons interested in learning about and experimenting with the use of raw animal foods, and specifically, in the work Aajonus Vonderplanitz. It is recommended that members of the list be familiar with Aajonus Vonderplanitz and his book, "We Want to Live."
- [EatBugs](#) is a Yahoo group on insect appreciation and eating them for lunch! Very light activity.

[\[Ctrl-Home for Top, or Click Here\]](#)

Also see: [GFlinks](#) and [GFmail](#) and [GFrecipes](#) and [PaleoFood](#) and [Foraging](#) and [NoMilk](#)

Last updated: 07-Dec-03, 21:24
EST

Hits: 1160878 (count started
09-Jan-97)

Send additions or comments to
donwiss at panix.com [[Home](#)]

Copyright 1997-2003 Don Wiss.
All rights reserved.

panix.com
Public Access Networks Corporation



The Society of Primitive Technology

Updated January 1st, 2004

Society of Primitive
Technology
PO Box 905
Rexburg, ID 83440
208-359-2400
dwescot@aol.com

[Subscribe & Order Back Issues On-Line!](#)

[--2004 Winter Count & Rabbitstick Information--](#)

The Society of Primitive Technology is a non-profit organization dedicated to the research, practice, and teaching of primitive technology.

What's inside the **[Current Issue](#)** of the Bulletin?

Browse the Contents of our Back Issues

[Issues #1-10](#) | [Issues #11-current](#)

Check out these On-Line Articles

- [The Fire Plow](#) by Bart & Robin Blankenship
- [Conquering the Darkness](#) by Benjamin Pressley
- [Card Weaving](#) by Bart & Robin Blankenship
- [The Art of Nothing](#) by Thomas J. Elpel
- [Metaphors for Living](#) by Thomas J. Elpel
- [Artifacts & Ethics](#) by Thomas J. Elpel
- [Atlatl Weights](#) by "Atlatl Bob" Perkins
- [Stealth Technology 1992 B.C.](#) by "Atlatl Bob" Perkins
- [Nature as Wallpaper](#) by Thomas J. Elpel

Now Available!

[Primitive Technology: A Book of Earth Skills](#)

-&-

[Primitive Technology II: Ancestral Skills](#)

-Featuring the best of the Bulletin of Primitive Technology!-

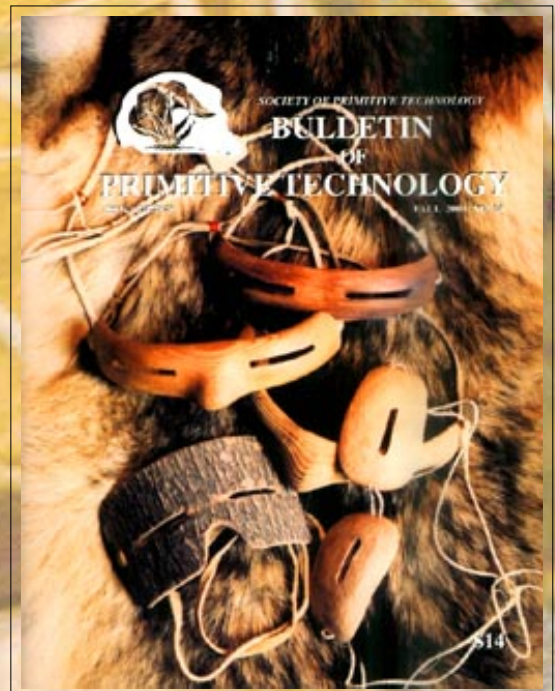

Other Items of Interest

An Interview with [Larry Dean Olsen and Tom Brown Jr.](#)

Check out the

[On-Line Calendar of Schools](#)

and be sure to visit the

[Directory of Primitive Living & Nature Awareness Schools](#)

The SPT website is maintained courtesy of Thomas J. Elpel. Please visit our [Webworld Portal](#)

Granny's
COUNTRY STORE
SILVER STAR, MT

Tom's Books & Videos
Primitive Wilderness Survival
Nature, Wildlife & Tracking
Plant Identification & Ecology
Home-Building Books
Green Goods for the Home
Books & Gifts for Kids



HOPS Press



Hollowtop Outdoor Primitive School

**3 Rivers
Park**



**Wildflowers
& Weeds**

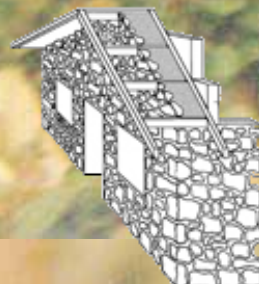

**Sustainable
Living Skills**

Thomas J. Elpel's Web World Portal
Granny's Country Store

HOPS Press, LLC | Hollowtop Outdoor Primitive School, LLC
Primitive Living Skills | Sustainable Living | Wildflowers & Weeds
Society of Primitive Technology | 3Rivers Park
What's New? | Search This Site!

Granny's Country Store Departments
Tom's Books & Videos

Primitive Wilderness Survival | Nature, Wildlife & Tracking
Plant Identification & Ecology
Home-Building Books | Green Goods for the Home
Books & Gifts for Kids



Resources for Indigenous Cultures around the World

[Site Index](#)

[Resource Center](#)

[Books & Music](#)

[Communities](#)

[Hosted Sites](#)

[Search the Site](#)

[About NativeWeb](#)

[DONATE NOW!](#)
[Tax-deductible!](#)

[Get your FREE EMAIL](#)
[@NativeWeb.Net!](#)

[Login](#) | [Signup](#)



[New Products, check them out!](#)

[Featured Hosted Site](#)

In The News

[Read more news](#)
[articles](#)

People and Places

[More People and](#)
[Places](#)



[Marc Becker Report: *World Social Forum* in Mumbai, India, January 2004](#)



[Secretary-General](#)

[Hails Contributions Of Indigenous Peoples To Human Civilization In Remarks In Machu Picchu, Peru](#)

Announcements!

[Read more](#)
[Announcements!](#)

[New Resource](#)

[International Indigenous Elders' Summit 2004](#)

Community members from Six Nations have worked with Elders and grassroots organizations to develop an initiative to bring the community together and to heal historical trauma continually being experienced by our people. The project has evolved over the past four years into a vision for an International Elders' Summit.

[Books & Music](#)

[Blanket Weaving in the Southwest](#)

by Joe Ben Wheat, Ann Lane Hedlund (Editor)
An essential book on southwestern textiles, perhaps a definitive study of blankets from the 19th century to date
Hardcover: 500 pages ;
Dimensions (in inches): 1.68 x 11.40 x 8.76
University of Arizona Press; (October 2003)

[Upcoming Events](#)

[Fighting Back:
American Indian
Reactions to Coerced
Sterilization](#)

Mary Jaeggli, a graduate student at the University of Wyoming, is working on research for her graduate thesis, which involves studying the reactions of American Indian communities to the coerced sterilizations that allegedly occurred during the late 1960s through the mid 1970s.

[Some 1,500 people from around the world, most of them indigenous, will gather at the United Nations in New York from 10 to 21 May for the third session of the UN Permanent Forum on Indigenous issues. Secretary-General Kofi Annan is expected to open the session, which will focus on the special needs of indigenous women.](#)

[The New York City American Indian Community House proudly announces Indian Summer 2004. The performing Arts festival will take place April 30 through May 22 and will feature music and theatre. All performances will take place on Fridays and Saturdays at 8 pm in The Circle, 404 Lafayette street, 8th floor.](#)

[The U.S. Institute for Environmental Conflict Resolution is pleased to announce the opening of the initial recruitment process for inclusion in the Native Dispute Resolution Network. We invite American Indian, Alaska Native, Native Hawaiian and other dispute resolution practitioners to consider joining and participating in the Network. The deadline for submission of materials is June 18, 2004.](#)

[Join the Unity Ride and Run 2004 Sioux Valley, Manitoba to Six Nations of the Grand River. The Unity Ride will finish by opening the International Indigenous Elders Summit - 2004. August 27 - September 1, 2004.](#)

[Indigenous writers, scholars and students are invited to submit manuscripts for consideration in an expanded edition of](#)

**05/28/04
28th Annual Odawa
Pow Wow, CON**

[the book "Landscapes of the Heart" -- one that will cross the boundaries of ecology, culture, environment, health, the social sciences and the humanities.](#)

Resources

[more...](#)

5341 Listings Available!

- [Anthropology & Archeology](#)
- [Art, Artisans & Galleries](#)
- [Book, Movie & Arts Reviews](#)
- [Chat, Discussion Forums, E-Lists](#)
- [Children](#)
- [Crafts & Indigenous Technology](#)
- [Education](#)
- [Elders](#)
- [Environment](#)
- [Events, News Items & Powwows](#)
- [Food](#)
- [Genealogy \(Tracing Roots\)](#)
- [Health](#)
- [History](#)
- [Human Rights Organizations](#)
- [Internet & Computers](#)
- [Languages & Linguistics](#)
- [Law & Legal](#)
- [Materials Hosted on NativeWeb](#)
- [Museums & Online Exhibits](#)
- [Nations Web Sites & Information](#)
- [Native Businesses & Products](#)
- [Native Economy & Employment](#)
- [News & Media](#)
- [Newspapers - native & indigenous](#)
- [Obituaries - In Memorium](#)
- [Organizations](#)
- [Performance \(Music, Dance, etc\)](#)
- [Personal Pages](#)
- [Photography; Indigenous Images](#)
- [Reference Materials](#)
- [Religion & Spirituality](#)
- [Sports & Athletics](#)
- [Travel &](#)

[Issues](#)

- [Libraries & Collections](#)
- [Literature](#)

[Tourism](#)

- [TV & Radio](#)
- [US Tribal Websites](#)
- [Women](#)

Books & Music

[more...](#)

974 Listings Available!

- [Audio Cassettes](#)
- [Books](#)
- [Music](#)
- [Video Cassettes](#)

Non-profit Status

The U.S. Internal Revenue Service has issued a determination that NativeWeb, Inc., is a non-profit educational organization under the 501(c)(3) federal tax laws. This means that all donations to NativeWeb are tax-deductible as charitable contributions. NativeWeb is an all-volunteer effort and depends on donations from users.



Selected by NEH as one of their original 21 top Humanities sites on the Internet



Institute for Scientific Information premium collection of evaluated

scholarly Web sites.



Selected by Social Science Information Gateway of the UK Resource Discovery Network as a trusted source of information for students, academics, researchers and practitioners in the social sciences, business and law.



© [NativeWeb](#) 1994-2004 || [Disclaimer Statement](#) || [Copyright Statement](#) || [Contact Us](#) || [Visitors](#) ||
[Donate Now](#)

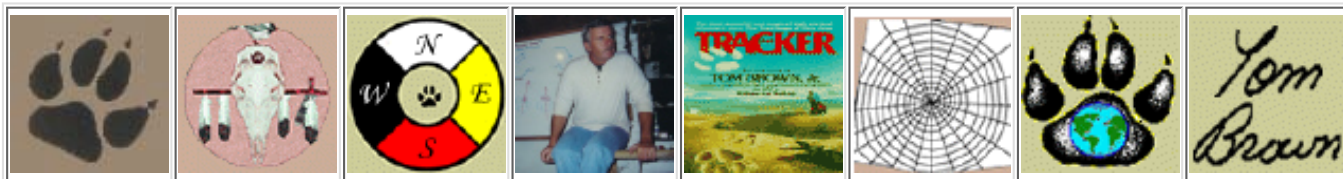

Celebrating Our 25th Year Anniversary 1978 - 2003

Use the menu above to navigate our site.
For the latest news, click on the Tracker School's Medicine Shield logo below

Tom Brown's **TRACKER SCHOOL**



Tracking, Nature and Wilderness Survival

© 2003 The Tracker, Inc. - The Tracker School - Joe Lau - Webmaster

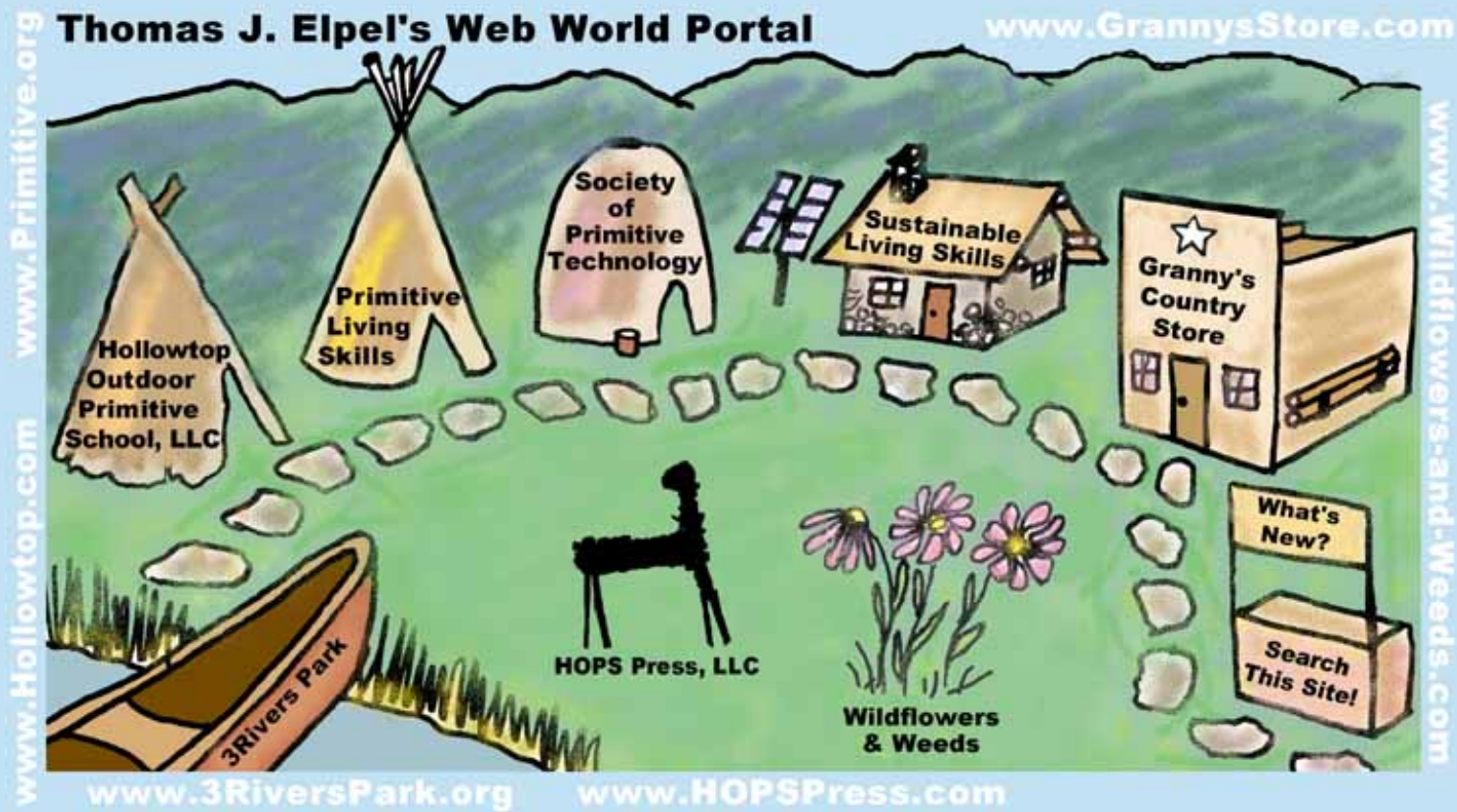

Thomas J. Elpel's Web World Portal

[Granny's Country Store](#)

[HOPS Press, LLC](#) | [Hollowtop Outdoor Primitive School, LLC](#)

[Primitive Living Skills](#) | [Sustainable Living](#) | [Wildflowers & Weeds](#)

[Society of Primitive Technology](#) | [3Rivers Park](#)

[What's New?](#) | [Search This Site!](#)

Granny's Country Store Departments

[Tom's Books & Videos](#)

[Primitive Wilderness Survival](#) | [Nature, Wildlife & Tracking](#)

[Plant Identification & Ecology](#)

[Home-Building Books](#) | [Green Goods for the Home](#)

[Books & Gifts for Kids](#)

WINDSONG PRIMITIVES

BENJAMIN PRESSLEY

Primitive, Survival & Wilderness Living Skills

**Informative Website -- Workshops -- Resources -- Books -- Primitive Hunting
Weaponry -- Primitive Items -- Museum Replication --**

Living History -- Team Building



WHAT'S  ON THIS WEBSITE? CLICK HERE!!

[New Story, Thoughts, Poems, Stories...More!](#)

Last Updated December 6, 2003

Have you checked out the [Primitive Technology Calendar](#)? Workshops from all over the world from many great teachers! . **ANYONE WITH EVENTS AND CLASSES PLEASE LET ME KNOW.** This has been a great tradition started by Ted Bailey, let's keep it alive!

SPECIAL NOTICE!

We're putting together an E-mail list to keep you informed on specials, workshops and special news. People on this list will be the first to know when this website is updated and exclusive exciting news and resources. Free of charge. [Just e-mail us](#) and let us know you want to be on our E-LIST.

[COMPLETE INDEX TO THIS WEBSITE](#)

"Why practice the skills of ancient man? Each time we breathe in the smoke of a fire created by rubbing one stick against another, we breathe in the air of the dawn of all time. Each time we crack two stones together, we rejoin the brotherhood of man and a past that unites us all. Learning is ever on the increase, yet all we learn swirls together as it joins into and affects time forever. What we do with that which we have learned can bless or curse future generations. Everything our hands do imprints upon time forever. There are those in the past who knew this...perhaps, it is time we took the hand of time gone by to learn what we have forgotten."

---Benjamin Pressley

Welcome to the Windsong Primitives website! If you're interested in primitive, survival or wilderness living skills this is the place to be! Check here frequently for articles on skills, stories from ancient cultures, links to other great resources and much more. Also, for what has been updated recently, visit our [What's New at WINDSONG PRIMITIVES web page](#). There is information below on who I am, some of the magazines I write for and how to get in touch with me to inquire about classes I teach, resources I have available and more. A link to my catalog of books is below. Click [here](#) to acquire information on how to acquire my complete, illustrated catalog of books, primitive hunting weaponry and primitive items. You can also learn how to receive our text-only version of our catalog via e-mail. If you have a suggestion or comment about this website or a question about any subject relating to primitive, survival or wilderness living skills feel free to [E-Mail](#) me. Have fun visiting and I hope I can be of service to you or your group.

----Benjamin Pressley

[---WHAT'S ON THIS WEBSITE---](#)

[What's New On This Web-Site](#)

[WINDSONG PRIMITIVES WORKSHOP SCHEDULE](#)

[Articles On Primitive, Survival and Wilderness Living Skills](#)

[Check here frequently for new articles!](#)

[Now Featuring:](#)

[Primitive Hunting Weaponry: Survival Weapons of Today](#)

[By Benjamin Pressley](#)

[Part 1: Blowguns](#)

[Blowguns were used by Native Americans and many primitive cultures and still are effective for hunting today!](#)

[Part 2: Throwing Sticks or Rabbit Sticks](#)

[Throwing sticks and boomerangs were used in every culture for hunting. This article tells you about the throwing stick and its many uses.](#)

[Primitive Lighting Methods](#)

[Primitive and survival methods for making stone oil lamps, torches and more!](#)

[About Benjamin Pressley and WINDSONG PRIMITIVES](#)

[Books By Benjamin Pressley](#)

[Skill Presentations, Classes and Programs Available](#)

[The Ultimate Team Building Experience](#)

[What People Are Saying About WINDSONG PRIMITIVES' Classes, Programs, Products and Books](#)

[How To Contact Us](#)

[Great Links](#)

[Original Stories, Thoughts and Poems By Benjamin Pressley](#)

ABOUT BENJAMIN PRESSLEY AND WINDSONG PRIMITIVES:

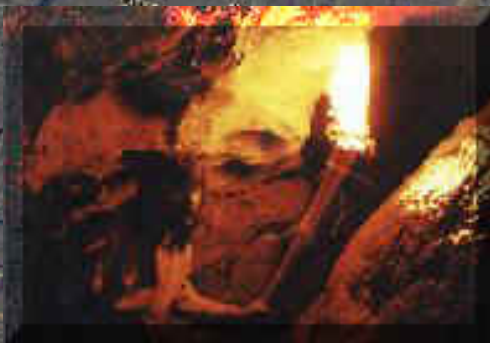

Benjamin Pressley practices and teaches the skills of the past; primitive, survival and wilderness living skills practiced for generations by Native Americans and aboriginal peoples all over the world.

"If you go back into anyone's past far enough, no matter where your ancestry lies, your ancestors practiced these skills. So, in a sense, it is the past that unites us all.

"These skills are of interest and use to many people for many different reasons. Some are interested in how ancient peoples lived from day to day. Outdoors enthusiasts are interested because these skills are also skills that would apply if thrust into a survival situation with loss of modern gear. All find that learning and practicing these skills give them an appreciation and enhances their enjoyment for what nature and the outdoors has to offer." (Benjamin Pressley)

Benjamin Pressley has taught all ages in classes he now teaches through his school, WINDSONG PRIMITIVES. Formerly he taught many classes through the organization he and a friend (Robert Likas) founded, called TRIBE. TRIBE was a great success with a staff of people like Kim (his wife), Robert Likas and Mike & Susan Jaiy Geno (Now of [Ancient Whispers](#)). TRIBE was a successful network, school and a resource that brought together people practicing primitive skills all over the

U.S., with membership in Guam, Canada and New Guinea. **TRIBE** published a quarterly newsletter that contained articles, news, events, resources and information for anyone interested in the skills of the past. Benjamin Pressley was the Editor and Director. **TRIBE** has since had to disband. He has taught and continues to teach at schools, civic organizations, Scouts, Y-Indian Guides, Royal Rangers, YMCA, museums and historical sites. He has written and self published 13 books on various primitive, survival and wilderness living skills. He is also a writer for magazines, such as: *Backwoodsman*, [Wilderness Way](#) and *American Survival Guide*. Benjamin has been Staff Editor for *Backwoodsman* magazine and the Southeastern U.S. Field Editor for *Wilderness Way* magazine. He has played roles in instructional video curriculum and educational television movies depicting life in our country between 1750-1790.



[Back To What's On This Website](#) // [Back To Top](#)

WHAT WINDSONG PRIMITIVES HAS TO OFFER:

Benjamin Pressley is able to bring years of experience to your school, club, civic organization or group. He is also available for personal instruction. Benjamin is able to offer demonstrations, lectures, hands-on instructional classes and workshops of any length, whatever you have in mind. He is able to offer instruction and presentation of primitive, wilderness living, survival, early American (Historic, i.e. After Columbus), Native American (Historic and Prehistoric) and aboriginal skills and crafts. Below you will find a list of some of the many things he is able to offer. He will be glad to work with you to plan a program to suit your special needs. WINDSONG PRIMITIVES can connect you with just about any program of instruction or presentation you have in mind. At this website you will also find endorsements, a biography and information about Benjamin Pressley and WINDSONG PRIMITIVES. Other references are available on request. Feel free to give us a call with any questions you may have. Complete Media Package available on request that includes, endorsements, references, fee schedule, as well as programs and classes available. Feel free to discuss any special needs you may have in the area of skills presentation or financially.

CATALOG INFORMATION: Order WINDSONG PRIMITIVES' complete catalog of books, primitive hunting weaponry and primitive items! *To get your WINDSONG PRIMITIVES' catalog, send \$3.00 (Refunded as a credit on first order). International please add \$4.00, Canada please add \$2.00. U.S. funds only. See [Contact Information](#) for address to mail to.*

Also available: WINDSONG PRIMITIVES' VIRTUAL CATALOG. A complete, text-only version of WINDSONG PRIMITIVES' catalog mentioned above. This catalog is free of charge. Just type: WINDSONG PRIMITIVES' VIRTUAL CATALOG in the subject of your e-mail and it will be e-mailed to you in a reply as an attachment (239K). Also feel free to drop us a note in the message section of your e-mail, if you wish. To request your virtual catalog now, just click here to [e-mail us](#).

Aborigine: The earliest inhabitants of a continent or region.



[Back To What's On This Website](#) /// [Back To Top](#)

CONTACT INFORMATION:

If you have a question regarding primitive, survival or wilderness living skills or wish to contact Benjamin Pressley to order books or to do a class, program or presentation, you may write him at *WINDSONG PRIMITIVES* at: 1403 Killian Rd., Stanley, NC 28164, USA. Make all checks, etc. payable to *Benjamin Pressley*.

--or--



[E-Mail Benjamin Pressley](#)

[Back To What's On This Website](#) /// [Back To Top](#)



Are You Tired Of People Making A Monkey Out Of You? Check Out These Web Sites:

[Scientific Papers on Many Subjects Regarding Early Earth and Early Humankind](#)////[Origins of Humankind](#)////[Evolution?](#)////[Archaeology](#)////[Creation, Young Earth? Scientific?](#)

SINCE OCTOBER 10, 1997...

[Back To What's On This Website](#) /// [Back To Top](#)

This Web Site Created By Benjamin Pressley. For Your Web Site Design Needs Just Click Below

CYBE BWD BK'S

What would you like to see?

[Homepage](#)

Lollipops!:

[See the Lollies](#)

[Find a Lollie dealer](#)

[What makes a Lollie?](#)

[Registered Lollies](#)

[Worldwide](#)

[Dealer Inquiries](#)

[Welcome!](#)

Educational:

[Drop Spin Instructions](#)

[Dyeing](#)

[School Demos](#)

[Ask Stefie](#)

Homespun Spindles:

[What started all this?](#)

[What's New?](#)

Web Stuff:

[E-mail us!](#)

[Favorite Links](#)

[Visit the Cyber Fiber Mall](#)

[See our Awards](#)



Lollipops are highly decorated, hand-painted, top-whorl handspindles and matching threading/sley hooks. All Lollipops are handmade with hardwood. Lollipops come in several luscious "flavors".

(If you are confused at this point, and don't know what handspindles or drop spindles are, [click here](#) to learn more about them.)



NEW!

Looking for a retired Lollie? I'm in the process of updating [the list](#).



Welcome to Homespun Spindles' web site. We take spinning seriously! Come on in, browse around and make yourself at home. Along with our spinning tools, we aim to provide our readers with a good spinning resource on the web. We've made a start of it by including some educational material here, along with links to other web sites on fiberous topics. If you have any suggestions for things you'd like to see on this site, please [drop us an e-mail](#) and we'll be happy to do all that we can. If you have a favorite spinning site that you would like us to link, we'd love to - just [let us know!](#) If you have a request for a spindle design, [tell us!](#) We love to hear from you! We hope you like our Lollipops and the instructional materials that we've gathered together.

Thank you!



We'd love to hear from you!

Please Note - Several people have signed the guest book and asked questions - if I haven't gotten back to you it's because there were problems with e-mail addresses. Please send me an e-mail using the e-mail button below - I'm happy to answer your questions!



[Please sign our guest book.](#)



[View our guest book](#)

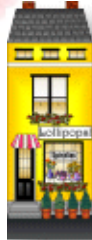

[Visit the Cyber Fiber Mall](#)

- a collection of fiber-related web sites.

In this site:

Lollipops:

[\[See the Lollies\]](#) | [\[Lollie Dealers\]](#) | [\[What makes a Lollie?\]](#) |
[\[Registered Lollies\]](#) | [\[Dealer Inquiries Welcome!\]](#)

Educational:

[\[Drop Spin Instructions\]](#) | [\[Dyeing\]](#) | [\[School Demos\]](#) | [\[Ask Stefie\]](#)

Homespun Spindles:

[\[What started all this?\]](#) | [\[What's New?\]](#)

Other:

[\[E-mail us!\]](#) | [\[Favorite Links\]](#) | [\[Awards\]](#)



55,683 Visitors

since July 4, 1997



Herbal Medicine Internet Resources

© [Holistic Medicine Resource Center](#)

(Updated: November 21, 2001)

Go to [Herbal Medicine Discussion Groups](#). Go to [Herbal Medicine Herb Databases](#)
Back to [Link Index](#). Back to [Home Page](#). Go to [Browse All Links](#).

[Herbal Medicine Books from Amazon.Com](#)

Scroll Down To:

[Extensive Info](#) / [Organizations](#) / [Practitioner Databases](#) / [Web Forums](#) / [General Web Pages](#) / [Education](#) /
[Publications](#) / [Discussion Groups](#)

Herbal Medicine WWW Links

Extensive Information & Meta-Directories

- [Chinese Herbal Information for Consumers, Students, & Practitioners at Acupuncture.Com](#)
- [Chinese Herbal Sciences & Health Education Directory \(Lots of useful articles & checklists\)](#)
- [Culinary Herb FAQ](#)
- [East West Acupuncture & Herbology \(Articles, Links, Forums, Courses\) \(Michael Tierra's Web Page\)](#)
- [Health World Online Herbal Medicine Center](#)
- [Herb News \(from the Herb Research Foundation\)](#)
- [Herbal Hall \(Rebuilding to its former excellence ... or at least it was rebuilding!\)](#)
- [Herbal Bookworm \(Excellent Herbal Bookworm Reviews, What Is Herbal Medicine, etc.\)](#)
- [HerbNet Meta-Directory \(Herb Vendors, Resources, Newsletter, Encyclopedia\)](#)
- [Herbwalk Herbal Community](#)
- [Howie Brounstein's Herbal Treats \(Articles & Links\)](#)
- [Henriette's Herbal Homepage \(Articles, Classic Herb Works, Medicinal & Culinary Herb FAQs & Links\)](#)
- [MedHerb.Com \(Links and Resources on Herbal Medicine\)](#)
- [Medicinal Herb FAQ \(good info and resources\)](#)

- ["Modern Herbal" by M. Grieve Searchable Text](#)
- [Southwest School of Botanical Medicine \(Materia Medica, Manuals, FAQs, Images\)](#)
- [Susun Weed's Home Page - Articles, Workshops, Apprenticeships, etc.](#)
- [Traditional Chinese & Western Herbal Medicine Links to Formula & Interactions Databases](#)

- [Herbal Medicine Database Links @ HolisticMed.Com](#)

- **Herbal Safety Issues Web Pages** (Special Section)
 - [Debunking the Debunkers \(Short, but good article.\)](#)
 - [Herbal Medicine and Hysterical Phytophobia](#)
 - [Institute of Traditional Medicine Herb Safety Articles \(Detailed articles\)](#)
 - [Safety of Herbs/Vitamins/Minerals \(Dietary Supplements\) -- Good Article!](#)
 - [Web Links to Additional Sites Related to Herb Safety](#)

National/International Organizations

- [U.S.: American Botanical Council](#)
- [U.S.: American Herbal Pharmacopoeia](#)
- [U.S.: American Herbal Products Association](#)
- [U.S.: American Herbalist's Guild](#)
- [U.S.: American Society of Pharmacognosy](#)
- [U.S.: Association of Native American Health Professionals and Traditional Healers](#)
- [U.S.: Herb Research Foundation](#)
- [U.S.: Herb Society of America](#)
- [U.S.: Institute for Traditional Medicine](#)
- [U.S.: United Plant Savers \(Protecting Medicinal Plants in the U.S. & Canada\)](#)
- [Worldwide: Herb Network](#)
- [Worldwide: International Association for the Study of Traditional Asian Medicine](#)
- [Worldwide: International Register of Consultant Herbalists and Homeopaths](#)
- [Worldwide: Veterinary Botanical Medical Association](#)
- [Australian Herb Society](#)
- [Australian National Herbalists Association](#)
- [Austrian Society for Phytotherapy](#)
- [Canada: Ontario Herbalists Association](#)

- [Canadian Herb Society](#)
- [European Herbal Practitioners Association](#)
- [European Scientific Cooperative on Phytotherapy](#)
- [German Society for Phytotherapy](#)
- [Netherlands Association for Phytotherapy](#)
- [Swiss Medical Society for Phytotherapy](#)
- [United Kingdom Association of Traditional Chinese Medicine](#)
- [United Kingdom College of Practitioners of Phytotherapy](#)
- [United Kingdom: Herb Society of the United Kingdom](#)
- [United Kingdom National Institute of Medical Herbalists](#)
- [United Kingdom Register of Chinese Herbal Medicine](#)

Practitioner Databases

- [U.S.: American Herbalists Guild Referral Search](#)
- [U.S.: Herbalist Graduate Referral Page on HolisticMed.com](#)
- [U.S.: Institute for Traditional Medicine: Chinese Medicine Practitioners \(3+ years experience\)](#)
- [Worldwide: Ayurvedic Medicine Practitioner Resources @ HolisticMed.Com](#)
- [Worldwide: Chinese Herbal Academy Herbal Medicine Practitioner Directory](#)
- [Worldwide: Health World - Find a Herbalist - Scroll Down & Click on "Herbalist" \(U.S., Canada, U.K., Australia\)](#)
- [Worldwide: Oriental / Chinese / Tibetan Medicine Practitioner Resources @ HolisticMed.Com](#)
- [Worldwide: Veterinary Botanical Medical Association Directory of Practitioners \(Mostly U.S.\)](#)
- [Australian National Herbalists Association Members List](#)
- [Canada -- Ontario Herbalists Association Professional Members](#)
- [Irish Herbalist Directory](#)
- [Irish Herbal Practitioners Association Listing \(Scroll down\)](#)
- [Swiss Medical Society for Phytotherapy Practitioners](#)
- [United Kingdom National Institute of Medical Herbalists \(Click on Find your nearest Herbalist button\)](#)
- [United Kingdom College of Practitioners of Phytotherapists Member List](#)

Web-Based Discussion Forums

- [American Herbalists Guild Forum](#)
- [Medical Herbs Forum](#)
- [PlanetHerbs Forum](#)
- [Botanical.Com Message Board](#)

General Interest Pages

- [Algy's Herb Page: Links, Greenhouse, Kitchen](#)
- [Christopher Hobbs -- The Virtual Herbal](#)
- [Japanese Herbal Medicine \(Kampo\) Web Page \(FAQ, Theory, Cases\)](#)
- [Kombucha FAQ](#)
- [Kombucha Center \(Articles\)](#)
- [Kombucha Journal \(Gunther W. Frank\) \(Articles, Links, Available in 28 Languages, etc.\)](#)
- [Kombucha Links & Internet Resources Site](#)
- [Michael Moore's Preferred Herb Buyers Resource List](#)
- [Padma AG -- Tibetan Medicine Herbal Preparations](#)

Education & Training

- [U.S.: American Herbalist Guild Educational Guidelines](#)
- [U.S.: Howie Brounstein's Classes & Apprenticeships](#)
- [U.S. & Canada: Natural Healers: Comprehensive Educational Resources for Natural Healing Arts.](#)
- [U.S.: Rocky Mountain Herbal Institute \(Lots of useful articles & checklists\)](#)
- [U.S.: Southwest School of Botanical Medicine - Michael Moore](#)
- [U.S.: Susun Weed's Home Page - Articles, Workshops, Apprenticeships, etc.](#)
- [U.S.: Veterinary Botanical Medicine Association Training Schools](#)
- [Worldwide: Ayurvedic Medicine Educational Resources @ HolisticMed.Com](#)
- [Worldwide: HerbNet Directory of Schools \(U.S. and International\)](#)
- [Worldwide: Oriental / Chinese / Tibetan Medicine Educational Resources @ HolisticMed.Com](#)
- [Australia & New Zealand School with Accredited Herbal Medicine Courses](#)
- [Canada: Ontario Herbalists Association List of Canadian Schools that Teach Herbalism Courses](#)

- [European Herbal Practitioners Association Training Standards \(includes Chinese, Ayurvedic, Western\)](#)
- [United Kingdom National Institute of Medical Herbalists School \(click on Training Courses\)](#)
- [United Kingdom: Register of Chinese Herbal Medicine Affiliated Schools](#)

Publications

- [Amruth: The Magazine on Medicinal Plants \(India - Ayurvedic Medicine, Plant Conservation\)](#)
- [Australian Journal of Medical Herbalism](#)
- [British Journal of Phytotherapy](#)
- [Canadian Journal of Herbalism](#)
- [European Journal of Herbal Medicine](#)
- [Fytotherapie \(Journal of the Netherlands Association for Phytotherapy\)](#)
- [Herb, Spice, and Medicinal Plant Digest](#)
- [Herb Network Newsletter](#)
- [Herb Quarterly](#)
- [HerbalClip \(Reviews of research, regulation, marketing\)](#)
- [Herbal Collective](#)
- [HerbalGram Magazine](#)
- [Herb Companion](#)
- [HerbNet Magazine online](#)
- [Herbs: Journal of the Herb Society of the United Kingdom](#)
- [Herbs at Home Magazine \(official magazine of the Canadian Herb Society\)](#)
- [Herbs for Health](#)
- [Journal of Natural Products \(from the American Society of Pharmacognosy\)](#)
- [Journal of the American Herbalists Guild](#)
- [Medical Herbalism: A Clinical Newsletter for the Herbal Practitioner](#)
- [Robyn's Recommended Reading: Quartly Review of Literature Relating to Herbalism and Phytotherapy](#)
- [Zeitschrift fur Phytotherapie \(Journal of the German Society for Phytotherapy\)](#)

Back to top of [Herbalism Page](#). Back to [WWW Link Index](#). Back to [Home Page](#).

Herbal Medicine Discussion Groups

(Browse through all groups and join the groups that suit you!)

● **aboutherbs**

Description

An interactive mailing list, talk about herbs, cooking with herbs,herbal crafts, medicinal uses of herbs, recent studies on herbs,gardening tips, feel free to share and ask questions. Exchange information on how to keep the planet clean and green, this is a friendly peaceful list. We also discuss spiritual issues and connecting with nature issues also.

Subscription Instructions

To subscribe, go to the About Herbs discussion group web page (<http://groups.yahoo.com/group/aboutherbs>) and click on "Join This Group."

Additional Information

● **Bach Flower Remedies**

Description

Bach Flower Remedies (aka Bach Flower Essences) are 38 flower and plant based remedies that treat negative emotions.

Subscription Instructions

To subscribe, go to the Bach Flower Remedies discussion group web page (<http://groups.yahoo.com/group/talkbach>) and click on "Join This Group."

Additional Information

● **CherokeeHealth**

Description

The focus of this place is to help the whole person through prayer, suggested herbal remedies, and preventative care.

Subscription Instructions

To subscribe, go to the Cherokee Health discussion group web page (<http://groups.yahoo.com/group/CherokeeHealth>) and click on "Join This Group."

Additional Information

● **ChineseHerbalAcademy**

Description

A discussion group for licensed professionals and matriculated students in the field of Chinese herbal medicine, as well as postgraduates from related disciplines, such as pharmacology or Chinese philosophy.

Subscription Instructions

To subscribe, go to the Chinese Herbal Academy discussion group web page (<http://groups.yahoo.com/group/chineseherbacademy/>) and click on "Join This Group."

Additional Information

● **Culinary Herbalist**

Description

This is the list for the gardening and use of culinary herbs

Subscription Instructions

To subscribe, send email to HERB-L-request@orednet.org with the following in the body of the message:

subscribe

Additional Information

None

● **HERB**

Description

A mailing list for the general public and practitioners to discuss all aspects of Medicinal Herbalism. Active list. Unmoderated.

Subscription Instructions

To subscribe, fill out the subscription form at the following web page address:

Additional Information

None.

● **Herbal Remedies**

Description

This List is for those who are interested in HEALING using "Nutrition", "Herbal Remedies", & "All Natural" methods including Laughter. It is a forum whereby people with any kind of physical problem can get their questions answered, and thereby take full responsibility for their own health using Naturopathic methods.

Subscription Instructions

To subscribe, go to the Herbal Remedies discussion group web page (http://groups.yahoo.com/group/Herbal_Remedies) and click on "Join This Group."

Additional Information

● **Herb Students**

Description

A list will attempt to assist students of traditional Chinese herbal medicine in the studying and understanding of this very large topic.

Subscription Instructions

To subscribe, go to the Acupuncture Guild discussion group web page (<http://www.pairlist.net/mailman/listinfo/herb-students>) and fill out the subscription form.

Additional Information

● **herbal-discussion**

Description

This list is for the discussion and or just information of natural remedies, recipes using herbs for health and just for pleasure.

Subscription Instructions

To subscribe, go to the herbal-discussion discussion group web page (<http://groups.yahoo.com/group/a-herbal-discussion>) and click on "Join This Group."

Additional Information

● **herbal-healing**

Description

This list is for discussion of any form of herbal healing. How you use herbs and the healing properties of the herbs.

Subscription Instructions

To subscribe, go to the herbal-healing discussion group web page (<http://groups.yahoo.com/group/1herbal-healing>) and click on "Join This Group."

Additional Information

● **herb-witches**

Description

This list is intended to be a forum to discuss herbs and their magickal and medicinal qualities and uses. Especially how they relate and intertwine. Discussion of any other properties of herbs is also welcome.

Subscription Instructions

To subscribe, go to the herb-witches discussion group web page (<http://groups.yahoo.com/group/herb-witches>) and click on "Join This Group."

Additional Information

● **herb_kitchen**

Description

A list for all lovers of herbs. We exchange recipes for cooking with herbs, and all kinds of things you can do with herbs, including house, bath, beauty, health, decoration, oils, vinegars, potporri, soaps, gifts, and tips on buying, preserving and growing herbs.

Subscription Instructions

To subscribe, go to the Herb Kitchen discussion group web page (http://groups.yahoo.com/group/herb_kitchen) and click on "Join This Group."

Additional Information

● **Homemade Medicinal Herbs**

Description

Sharing information/ideas, etc. about herbs, natural health, well being, and anything you feel is related to making our world a better place.

Subscription Instructions

To subscribe, go to the Homemade Medicinal Herbs discussion group web page (http://groups.yahoo.com/group/Homemade_Medicinal_Herbs) and click on "Join This Group."

Additional Information

● **Kombucha Mailing List**

Description

A mailing list for the general public to discuss the Kombucha medicinal "mushroom"

Subscription Instructions

To subscribe, send email to kombucha-subscribe@topica.com with the following in the BODY of the message:

subscribe

Additional Information

[Kombucha Mailing List Web Page.](#)

● **Medicinal Herbs**

Description

This list is for the discussion of medicinal herbs.

Subscription Instructions

To subscribe, go to the Philippine Herbs discussion group web page (<http://groups.yahoo.com/group/medicinal-herbs/>) and click on "Join This Group."

Additional Information

● philippineherbs

Description

The purpose of this group is to discuss everything related to Philippine herbs. Many indigenous herbs here in the Philippines are now becoming mainstream in herbal health, such as papaya, banaba, lagundi, etc. Many herbs are also popular ingredients in natural soaps and other personal care products.

Subscription Instructions

To subscribe, go to the Philippine Herbs discussion group web page (<http://groups.yahoo.com/group/philippineherbs>) and click on "Join This Group."

Additional Information

● Phytopharmacognosy

Description

A mailing list restricted to healthcare practitioner, academics, and industrialists with expertise in medicinal plants.

Subscription Instructions

To subscribe, send email to mailbase@mailbase.ac.uk with the following in the body of the message:

Join Phytopharmacognosy [your_name]

where "[your_name]" is your first and last name.

Additional Information

Archives and further information can be found on the [Phytopharmacognosy Web Page](#).

● UK Herbalist

Description

Discussion group is only for professional practitioners of Herbal Medicine in Europe.

Subscription Instructions

To subscribe, send your resume to: gcwhite@ntlworld.com.

Additional Information

● **Wise Woman Herbal**

Description

Wise Woman Ways are those used by grandmothers and farmers wives, by Native American women and desert midwives. They are the natural ways... the feminine ways of healing. The list owner is a fourth generation Wise Woman who also specializes in herbal pregnancy care.

Subscription Instructions

To subscribe, go to the Wise Woman Herbal discussion group web page (<http://groups.yahoo.com/group/WiseWomanHerbal>) and click on "Join This Group."

Additional Information

Back to top of [Herbalism Page](#). Back to [Discussion Groups Index](#). Back to [Home Page](#).

[Start a Group](#) - [My Groups](#)

ForageAhead · Forage Ahead

[[Join This Group!](#)]

► [Home](#)

([Already receiving group email?](#))

Members Only

- [Messages](#)
- [Files](#)
- [Photos](#)
- [Links](#)
- [Database](#)
- [Polls](#)
- [Members](#)
- [Calendar](#)
- [Promote](#)

Description

Category: [Plants](#)

Forage Ahead e-mail group will discuss wild edible plants, animals, mushrooms; including identification, recipes, folklore, wilderness living, wilderness survival etc..

Topics will include wild edible berries, nuts, roots, greens, flowers, mushrooms, insects, marine invertebrates, and any other animals not usually hunted or marketed. Information about books programs and classes concerning wild edibles, including field guides, will be appreciated. Ideas on sperading the word or marketing this information are helpfull.

Most Recent Messages

	Jan	Feb	Mar	Apr	May	Jun	Jul	Aug	Sep	Oct	Nov	Dec
2004	344	215	155	274	123							
2003						1		149	289	402	604	520

Group Email Addresses

Post message: ForageAhead@yahoogroups.com
 Subscribe: ForageAhead-subscribe@yahoogroups.com
 Unsubscribe: ForageAhead-unsubscribe@yahoogroups.com
 List owner: ForageAhead-owner@yahoogroups.com

Yahoo! Sponsored Links

[Seedland.com - Forage Seed Specialists](#): Information and sales of all types of forage seeds for planting in the US.

www.seedland.com

[Forage on eBay](#): Find forage items at low prices. With over 5 million items for sale every day, you'll find all kinds of unique things on ebay - the world's online marketplace.

www.ebay.com

Group Info

Members: **368**
 Founded: **May 21, 2001**
 Language: **English**

Group Settings

- Listed in directory
- Restricted membership
- Posts from new members require approval
- All members may post
- Archives for members only
- Email attachments are not permitted



That's Kaiser Permanente for
Individuals and Families.



[click here to learn more](#)

The ads above are not put there by me, but by the service I use to make my web pages. Please page down a bit to see similar items I have to offer...thanks!!



A Journey to Health & My Auctions and Family!

Welcome to my home, health & auction pages! You will find helpful health information, articles, discussion board, my auctions and personal family pages. After a long winter, trees and green are a welcome sight, even if it is only on my home page until Spring leads to the full bloom of summer!

CONTACT INFORMATION:

Claudia L. Meydrech, CN
Certified Nutritionist
Phone: 973-906-2948

[Click Here to Send an Email](#)

AOL Instant Messenger, MSN Messenger or Window's Messenger
Same Username for all above: ClaudiaLM
Yahoo! Messenger - journey2health (See if I'm online below)



[CLICK HERE TO VISIT MY PERSONAL NSP SITE](#)

PLEASE SIGN MY GUESTBOOK:



[View My Guestbook](#)
[Sign My Guestbook](#)

PICK UP YOUR GREETING CARD or SEND A CARD HERE:

[View a Card ... Send a Card](#)

[*CLICK HERE FOR MY NUTRITION & HERBS MESSAGE BOARD*](#)

[GALLBLADDER FLUSH or LIVER CLEANSE \(High traffic page!\)](#)

[DETOXIFICATION ~ CLEANSING FROM THE INSIDE](#)

[FASTING](#)

[ARE YOUR HERB OR VITAMIN SUPPLEMENTS SAFE?](#)



[CLICK HERE to sign up for my occasional "HERBULLETIN" Newsletter.](#)

[Settings also allow for discussion, so feel free post your health related questions, or reply to those sent by others.](#)



I have been using herbs medicinally for about 17 years now. My favorite and almost-only source for herbal products is Natures Sunshine Products. You can become a Member (No strings attached...Promise!!) with a purchase of \$40 at wholesale cost price, and then all future orders will be at wholesale cost. Should this interest you, [just click here](#) to visit my personal Nature's Sunshine's web site and explore a bit with no obligation to purchase. You will find key products broken down into categories, or you may just click on the following to go directly to products for [SEASONAL ALLERGIES \(Respiratory System\)](#), WEIGHT MANAGEMENT products like [FAT GRABBERS](#) or [CARBO GRABBERS](#), BOWEL HEALTH products like [BOWEL DETOX](#), CIRCULATORY & HEART HEALTH SUPPLEMENTS, COLD SEASON PRODUCTS, DAILY ENERGY AND VITALITY SUPPLEMENTS, MEN'S HEALTH, WOMEN'S HEALTH, and much more so [click here](#) for a visit!

Questions? Use the form at the bottom of this web page to send me an email, or [click here](#).

[FREE HEALTH ANALYSIS](#)

NUTRITION & HERB LINKS:

[OUR FAMILY'S JOURNEY TO HEALTH](#)

[USING HERBS ~ Questions & Answers](#)

[WEEDS n' SEEDS SWAP ~ Herb Gardener's Exchange](#)

[DISCLAIMER & FTC HEALTH CLAIM GUIDELINES](#)

SUGGESTED READING - Click on the book to go to description, and use "back" feature on your browser to return here:

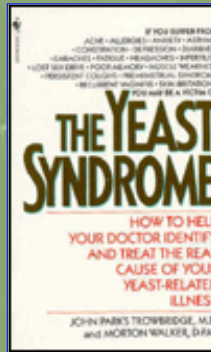

Other Barnes & Noble Selections:

[B&N Best Sellers](#)

[B&N Bargain Books](#)

[B&N Music Store](#)

[B&N DVD/Video Store](#)

MY AUCTION "STUFF"

Still haven't joined the eBay Community? You're really missing a treat! Click on one of the links below and see what it's all about!



~*~*~



[PLEASE VISIT MY EBAY AUCTIONS](#)

~~* NEWS AND WEATHER *~*~*

Click on ticker if you see headline that interests you,
then use back feature on browser to return here:

West Milford, NJ
81 °F
Clear
at 5:53 PM 
[Click for Forecast](#)

Today at Heartlight...

[A LITTLE BIT ABOUT MY FAMILY](#)



2003 picture of the family,
sorry we're a bit blurred :-)

***** FAMILY PICTURES!! *****

[Our Son, the Artist \(Mark\)](#)

[Our Daughter, Heather](#)

[Our Yorkie Puppy/Dog Pictures](#) (#1 most visited page!)

Come back and see the rest of the family soon!

OTHER MISCELLANEOUS LINKS:

Use back feature on your browser to return to this page

[MANY LINKS - Herbs, Nutrition, Support, Environmental, Gardening](#)

[Reciprocal Links - Visit my Friends' Sites](#)

Articles? Question? Comments? Let me hear from you!

Name:

E-mail Address:

Articles, Questions or Comments:

Sometimes out of context, the verse
in the box below doesn't make a lot of sense.
Click on the NIV link in lower right for what I
hope will be a clearer explanation!

Today's Verse

Website Last Updated 4/26/04

Thanks for visiting!

PRAYER

Site created and maintained by
[Claudia L. Meydrech, CN](#)
[Certified Nutritionist](#)
© 1998-2003

Visitors
0101900
Christian Counter



**Family
Friendly
Web Sites**

Search

[Healthy Herbs](#)



From [Juli Kight](#),
Your Guide to [Healthy Herbs](#).

Summers Top Ten

These are my picks for ten herbs you should have available for summer activities and travel.

[Friday May 07, 2004](#) #

Spring Tonic Herbs

Spring is the perfect time to renew your system with tonic herbs!

[Tonic Herbs](#) - What do they do?

[Chickweed](#) - This abundant and pesky little weed can be added to your salads and used topically for many skin conditions.

[Healthy Salads](#) - Add healing greens to your plain lettuce salads for added benefits.

[Spring Cleansing](#) - Gently renew your body with these gentle system cleansers.

[Psyllium And Cleansing Herbs](#)

[Wednesday April 28, 2004](#) #

Recipes

Here are two new recipes for you to add to your recipe boxes.

[Flax / Peanut Butter Cookies](#)

[Super Sea Glow For Skin](#)

Related:

[Indulging Sugar Scrub](#)

[Salt Glow Scrub](#)

[Monday April 19, 2004](#) #

Healing Spaces With Herbs

Start creating your healing spaces for the gardening season with:

[Herbal Container Gardens](#)

[Butterfly And Hummingbird Herbs](#)

[The Fragrant Garden](#)

[Thursday April 08, 2004](#) #

EPHEDRA BANNED TODAY

As of April 6, 2004, ephedra and supplements containing ephedrine alkaloids are banned and prohibited for sale in the United States. For more information see [FDA Issues](#)

Most Popular Articles

[Spring Cleansing Herbal Encyclopedia A to Z](#)
[Herb](#)



[Home](#)

[Essentials](#)

[A - Z Encyclopedia](#)[Submit A Feature Article](#)[Aromatherapy](#)[Free Herb](#)

[Graphics](#)[Submit a Recipe!](#)

[Browse Categories](#)

[Basics For Beginners](#)[Find A Condition Or Symptom](#)[Herb Profiles /](#)

[Monographs](#)[Consumer Safety / Toxicolog](#)[Aromatherapy](#)[Preparations And](#)
[Recipes](#)[Herbal Schools](#)[Homeopathy](#)[Home And Garden](#)[Flower](#)

[Essences](#)[Research](#)[Family And Pets](#)[Wild Herbs](#)[Traditional Ethnic](#)[Popular Herbs](#)

[Buyer's Guide](#)

[Before You Buy](#)[Top Picks](#)[Top 3 Essential Oil Brands](#)[Topical Pain Relief Products](#)[Product Reviews](#)

[Articles](#)

[Forums](#)

[Help](#)

Stay Current

Subscribe to the **About** Healthy Herbs newsletter.

[Regulation Prohibiting Sale of Dietary Supplements Containing Ephedrine Alkaloids and Reiterates Its Advice That Consumers Stop Using These Products.](#) [Encyclopedia A to Z](#)[Horny Goat Weed - Epimedium sagittatum](#)[Itchy Skin - Dermatitis](#)

At this time it does not ban Chinese herbal remedies or tea which are regulated as food. **What's Hot Now**
[Herbal Encyclopedia A to Z](#)[Spring Cleansing](#)
Tuesday April 06, 2004 #

Hayfever

As spring rolls in and temperatures rise, so do the pollen counts! This guide will help you select herbs and offer suggestions to help reduce the symptoms of this [seasonal attack](#).
Friday April 02, 2004 #

Selecting Herbs For Itchy Skin

The best way to relieve itchy skin it by taking a multi-faceted approach involving long and short term remedies. [This guide](#) helps you select the herbs you need by category.
Wednesday March 31, 2004 #

Alteratives And Adaptogens

I used to get these two terms and their uses mixed up. They are herbs with common end goals and can be used together for obtaining good health.
[Alterative](#)
[Adaptogen](#)
Monday March 29, 2004 #

Phytochemicals Against Cancer

Phytochemicals which are readily available and easy to consume are showing to be preventatives against some cancers.
[Lycopene](#) - Updated with a new source found.
[Polysaccharides](#)
Sunday March 21, 2004 #

Maitake Mushroom

[Maitake](#) may be a mushroom for you if you are worried about cancer, cholesterol, blood pressure and diabetes.
Saturday March 20, 2004 #

[Display Latest Headlines](#) 

 | [Read](#)

[Archives](#)

[Topic Index](#) |



[email to a friend](#)

decrease font
size



font size



[back to top](#)

[Our Story](#) | [Be a Guide](#) | [Advertising Info](#) | [Investor Relations](#) | [Work at About](#) | [Help](#)

©2004 About, Inc. All rights reserved. A PRIMEDIA Company.

[User Agreement](#) | [Privacy Policy](#) | [Kids' Privacy Policy](#)



Mears' Candida Fighters

Anne Mears
2536 W. Birch St.
San Bernardino, CA 92410

MCFighter@aol.com

Candida is a common yeast that can grow out of control under certain conditions. It can cause digestive problems, arthritis, and other degenerative disorders. It can be controlled with diet and food supplements. Test, classes, books and supplements available.

[What is Candida Albicans](#)

[How would I know if I have it](#)

[How it affects digestion](#)

[Treating Heartburn Naturally](#)

[A food program to start control](#)

[Immune System Information](#)

[Immune supplements](#)

[Phytonutrients](#)

[Supplements help control](#)

[Price list](#)

[My Story](#)

[Contact us](#)

[Links](#)

Best viewed with Netscape



This page has been visited



since 5/25/99

Copyright © 1999 [Anne Mears](#)

**Founded
January, 1998**

**Charles R. Garcia,
Director**



California School of Traditional Hispanic Herbalism

[Our Purpose](#)

[Instructors and Important People](#)

[Schedule and Course Descriptions](#)

[Short-term Intensive Classes](#) **NEW!**

[Class Settings](#)

[On-Line Classes](#)

[Frequently Asked Questions \(FAQ\)](#)

Please read this FAQ if you are a college student or instructor looking for information, a researcher, or a potential herbal student.

[Information on Wildcrafting Herbs](#)

[How to Contact Us](#)

[Additional Interesting Links](#)

Our Purpose

The California School of Traditional Hispanic Herbalism officially opened its doors in January of 1998, to teach and preserve the healing traditions of the Hispanic curanderos and curanderas (folk healers) of California. Many of these classes had been informally taught for two years prior to the creation of the school.

Although primarily offering classes in herbalism, the school also stresses an understanding of curanderismo, the healing techniques and philosophies of Native-Hispanic California. The cross-cultural influences of European and Asian herbs, as well as the use of native plants made California curanderismo a unique and potent healing medium. These practices also include the use of intuitive diagnosis skills, psychoactive plants, ritual and magic.

Instructors and Important People

Charles (Chuck) Garcia

The director and primary instructor of the school, is a third generation curandero, having learned much of his skills from his mother, Martha Garcia (who passed in 2001 at 84 years) who learned them from her father, Desidro

Navarro. Charles has treated and healed family, friends, and colleagues for almost two decades before going public with his herbal practice. He continues to treat physical, emotional, and spiritual illnesses in the Hispanic and Anglo communities of Northern California.

He has lectured on Hispanic Herbalism for the University of California Berkeley Joint Medical Program, the UC Berkeley Urban Botany Program, California State University at San Marcos, the Oakland office of the American Red Cross, the San Francisco Community Healthcare Consortium, On Lok Healthcare Services of San Francisco, the San Francisco office of AmeriCorp, the Sonoma County Herb Festival, and most recently at the 2003 meeting of the Wilderness Medical Society at the University of California, San Francisco and UC Davis. Chuck wrote a weekly column for a newspaper in South Texas, and has contributed a chapter on herbal first aid to the textbook Wilderness Emergency Care, by Steve Donelan. He was also a consultant for **America's Most Wanted** on the topic of Hispanic witchcraft.

Chuck attended classes at the **Pacific School of Herbalism** where he still maintains a close association with the director, Adam Seller. He recommends Adam's classes for those who desire to learn a strong western based medium of herbal healing.

On his off time, Chuck enjoys writing poetry and camping in the Sierra while searching for medicinal plants.

Linda Garcia

Linda is Charles' wife of 25 years. A technical publications director, writer and editor, and Red Cross Instructor, she is also the Computer Maven of the school while their daughter, Jennifer, has attended the University of Alaska, Fairbanks. Linda created a power point slide presentation for Charles, and often accompanies him on his lectures. For several years both she and her daughter have attempted to make Charles computer literate.

Jennifer Garcia

A 2003 graduate of the University of Alaska Fairbanks, in theatre arts, Jennifer has kept her dorm mates and drama crew physically and mentally healthy with numerous herbs and tinctures sent by her father to the Great White North. She has also developed syrups and tinctures on her own using local Alaskan plants. A somewhat mysterious figure in a long flowing wool cape, Jennifer has a sharp eye for diagnosis. She is currently editing a documentary on her father's wildcrafting adventures while working in local community theatre.

Clara S.

Clara is a published author and aficionado of Mexican and Texas Hispanic cultures. She is also Charles' official apprentice. Clara is currently learning curanderismo and developing her own clientele.

Sumitra R.

A transplant from the Pacific Northwest, Sumitra currently owns and runs a shop with her partner, providing shamanic herbs, artifacts, tools, reference materials, and supplies to shamanic practitioners of all faiths. She is Charles' newest apprentice.

Ruth McConnel

An old family friend and long time student, Ruth is the official dye mistress of the school. A long time participant of Renaissance Faire, Ruth has a background in the use of natural dyes as used during the Elizabethan era, as well as the use of California Native plant dyes. She is a former volunteer for the US Park Service at Point Reyes National Seashore.

Schedule

In-House Classes for Summer 2004

Traditional Hispanic Herbalism **Thursday evenings, June 17th**

7:30 to 9:30

An easy five week informational course focusing on popular folklore cures, teas, infusions, decoctions, poultices, wines, vinegars, concepts of illness, the hierarchy of Hispanic lay healers, and more. Students should be prepared to taste teas, tinctures, wines, vinegars, and some healing foods. If possible, a weekend herb walk will be planned. This class is a pre-requisite for the Hispanic Materia Medica class but can be taken concurrently. It is not a pre-requisite for the Advanced Traditional Hispanic Herbalism and Magic, but is recommended.

\$170.

The Hispanic Materia Medica **To be offered in the Fall**

A five to six week course, depending on the number of herbs covered. As requested by many former students, the Hispanic Materia Medica is an extensive list of Native, European and some Asian plants as used by Hispanic folkhealers. Their uses in specific ailments, health maintenance and spiritual healing will be discussed. Traditional Hispanic Herbalism and Magic or Advanced Traditional Hispanic Herbalism and Magic is a prerequisite for this course. Students with a background in herbalism make take this course with the permission of the instructor.

\$170.

Advanced Traditional Hispanic Herbalism and Ritual **Monday evenings, June 21st**

An eight week course with a more hands-on approach. Students cover many of the same herbs discussed in Traditional Hispanic Herbalism, but will make their own tinctures, salves, liniments, poultices, and plasters. Emphasis is placed on combinations of herbs used for specific ailments such as pneumonia, asthma, COPD, gynecological issues, mental distress, HIV, addiction, and tumors. This class will also cover cross-cultural herbal influences, basic magical protections, cleansings, and spells.

\$225.

Beginning Case Studies **Monday evenings, May 10th**

7:30 to 9:30

An intensive five week course open to students who have taken or are taking Traditional Hispanic Herbalism, Advanced Traditional Hispanic Herbalism and Ritual, or Materia Medica, or with the approval of the instructor. Three to four actual cases will be introduced to students, covering physical, emotional, spiritual, and chronic ailments. Students will develop treatments for each case, consult with each other, and discuss support treatments. Case studies may include HIV, cancer, diabetes, emotional trauma, physical injury, gender issues, and geriatric concerns. Four student minimum is required for this course.

\$175

Payment Policy

At least two-thirds of the course fee is expected at the first class meeting. This is unfortunate, but too many students have failed to meet their financial obligations. Complete payment is expected before the final class date. **Please make all checks payable to Charles R. Garcia.**

Note: A \$20 per class discount is available to any graduate of the Red Cross Wilderness First Responder class or any student of the Tracker School.

INTENSIVES

These are focused treatments of particular aspects in Hispanic healing. They will be offered throughout the year depending on weather and student interest. Private Intensives can be scheduled by groups and organizations.

Herb Walk and Lecture

A pleasant walk in Samuel P. Taylor State Park in Marin County. Local herbs and edible plants will be identified and discussed. Historical native uses will be covered. Bring lunch and water bottle. Note that poor weather may result in the postponement of any outdoor class. \$10 per person.

TBA

Curanderismo: Hispanic Mysticism, Magic and Ritual

A popular topic in the advanced course, this intensive will explore in depth the use of ritual, psychoactive plants, protection against spells, dreamwalking, witchcraft, Catholic and Native cultural influences, and the dangers inherent in this aspect of curanderismo. Not for the faint of heart or those skeptical of the existence of evil. Four person minimum.

TBA

\$25.00



HIV and Cancer Support

An intensive solely devoted to HIV and cancer support techniques. Topics include herbal support, diet, sexual issues, and depression. Also the use of ritual to improve the emotional and mental state of clients. Four person minimum. This class is dedicated to the memory of Ann Larricq, student, friend, and healer.

Sunday morning, July 11th, 10:30a.m. to 1:30 ?

\$30.00



Traditional California Healing Plants and Medicine Making

A day of history and fun covering the use of many California healing and edible plants from various regions of the state as used by Hispanics, natives, Anglos, and Chinese healers. Some remedies will be made by students. Five person minimum.

TBA

\$45.00

Supportive Bronchial Care Intensive

Chronic Obstructive Pulmonary Disease, SARS, asthma, bronchitis, pneumonia, AIDS related TB: All these conditions are increasing. Traditional herbal uses can help support the effectiveness of regular medical care and ease various bronchial discomfort. The use of herbs, steams, food, and lifestyle will be discussed.

Saturday May 29th 10:30 a.m. to 2:00 p.m. \$30 Four person minimum.

Intensive on Herbs and Survival

This course, originally created for earthquake and disaster training, will cover medicinal herbs available from sidewalks, lawns, parks, and other urban settings. May cover some edible plants. Some first aid techniques will be demonstrated. Will be held at Samuel P. Taylor State Park in Marin County, where students will identify healing plants and use them in emergency scenarios. Bring a lunch. This class is recommended for students or associates of the Tracker School, Red Cross Wilderness Emergency Response, or the Wilderness Medical Society. Note that poor weather may result in the postponement of any outdoor class.

Saturday July 10th 10:30 am to 2:30 (?) p.m. \$50 Five person minimum.

Intuitive Diagnosis and Tracking I

A one day class held outdoors at a nearby regional park. A picnic lunch should be brought. This class covers deductive and intuitive abilities used by native healers. Techniques in tracking as used by Tom Brown jr. of the Tracker School, will be used to increase observational skills. Mental exercises in visualization, empathy and imagination will be taught. Psychoactive plants and dream walking will be but not emphasized.. Approval of the instructor is necessary for this class. Note that poor weather may result in the postponement of any outdoor class. Bring lunch. Three person minimum.

Sunday July 18th 10:30 to ?

\$75

Class Settings

We understand that evening classes are difficult for working adults, so we have taken steps to relieve the stress by teaching small classes **at my home in Richmond** in an informal, but informative, manner. Light refreshments are usually served.

Outdoor classes are taught at nearby Wildcat Canyon Park or in nearby Marin County at Samuel P. Taylor State Park.

On-Line Classes

Due to numerous requests for a correspondence course, The California School of Traditional Hispanic Herbalism has offered on-line classes since April, 1998. Lectures are sent to students weekly via e-mail. Questions and comments are expected within four days for inclusion in the following lecture. Failure to respond to two classes in a row will result in the student being dropped from the course. There are no refunds if a student is dropped. Classes are offered continually through the year.

Currently offered classes are:

Traditional Hispanic Herbalism and Magic

Seven classes. History of California Hispanic herbalism. The hierarchy of lay healers. Poultices, teas, decoctions, wines, vinegars, folklore, ritual, magic, poisons as used in healing, cultural concepts of illness, treatment of serious ailments. Photo attachments of some herbs may be sent with the lecture.

\$75

Hispanic Materia Medica

Five classes. A comprehensive list of native and European herbs, and their use in specific ailments. Some photos may be attached to lessons.

\$75

Hispanic Ritual and Magic

Three classes. In depth lectures covering history, ritual, witchcraft, the use of psychoactive plants and the dangers to client and healer. Not for the faint of heart or those inclined to serious skepticism of the supernatural.

\$60.00

Payment Policy for On-line Classes

Full payment is expected before the first lecture is sent. This is unfortunate, but many on-line students have not met their financial obligations. Complete payment is expected before the end of the course. **Please make all checks payable to Charles R. Garcia.**

Future Courses

Late Summer/Fall 2004

Intensive On Herbal Sweats, Steam Therapies, and Poultices

Of growing interest to many students, this class will address the use of sweating; its practicality and dangers in dealing with a number of health issues. It will also cover the neglected use of herbal steams and poultices.

Anticipated cost: \$45. Four student minimum.

Street Herbalism

A course only for those who will attempt to treat the homeless. Anticipated to take three weeks. Topics to be covered...safety, bladder infections, skin conditions, bronchial conditions, drug and alcohol issues, sidewalk herbs, mental illness, police interaction, self defense. Approval of the instructor is required for this course.

Intensive on Long-Term Survival Herbalism

Survivalism and survivalists are terms often misinterpreted by the public in general. Many social and religious communities of the 1800's would have been branded survivalists in this day and age. This course focuses on the growth of herbs, use, storage, and application of herbal remedies by those who are attempting a simpler and low profile life-style for whatever the reason. Anticipated cost. \$35. Five student minimum.

Outdoor Survival for the Outdoor Challenged (and Herb Lecture) I

Is the idea of sleeping outdoors terrifying to you? Can't get a propane stove to work, let alone cook on it? Is your idea of camping staying at the local Motel 6? This is the class for you. Taught by Linda Garcia (with a complimentary herb lecture by Chuck), this is a full day and overnight class at a local state park. For a variety of reasons, a surprisingly large number of urban men and women cannot enjoy 24 hours in the outdoors . Deal with your doubts and fears! Linda has trained and led numerous city-bred children, and no few adults, to enjoy the beauty of nature through easy hikes, star gazing, and warm night fires. Weekends and 3 day holidays only. Anticipated cost: \$50 per person, plus camping fee for the park.

TBA Summer 2004

Supportive Bronchial Care Intensive

Chronic Obstructive Pulmonary Disease, SARS, asthma, bronchitis, pneumonia, AIDS related TB: All these conditions are increasing. Traditional herbal uses can help support the effectiveness of regular medical care and ease

various bronchial discomfort. The use of herbs, steams, food, and lifestyle will be discussed. **TBA Summer.**
Anticipated cost: \$30 Four person minimum.

Special Classes

Special classes and lectures on various topics of Hispanic herbalism can be arranged for groups of five persons or more. Please contact the school directly for details. A special class was recently arranged by the El Toro Creek Garden Club of San Luis Obispo County on the history and use of native and introduced herbs to California. In 2002 a lecture was given to the Native American Students Association of UC Berkeley on the history of California curanderismo.

A Word on Certification

Many herbal schools give certificates of completion or certification documents. In California this means literally nothing, as the state does not recognize herbalism unless practiced in conjunction with Traditional Chinese Medicine. Students who complete several courses at this school receive a small leather medicine pouch in recognition of their efforts. Several former students have continued their education at other institutions, some are practicing healers, two are doctors, most use what they have learned to help family and friends.

Contacting Us

E-Mail: csth@mindspring.com

Phone: (510) 233-5837 Monday through Friday, 10 a.m. - 5:00 p.m. Pacific Time

Regular Mail: **California School of Traditional Hispanic Herbalism**

**2801 Lincoln Avenue
Richmond, CA 94804**

Frequently Asked Questions (FAQ)

Over the years the same questions have arisen concerning classes, information on Curanderismo, and research information. To save time, the most common questions and my answers are listed below.

1. Can you send me a catalog of classes, costs, and class dates?

No, I cannot. All the information concerning both current classes and online classes is on this website. This includes scheduled topics, dates, costs, and payment policy. Please print these pages for your convenience and future reference. The California School of Traditional Hispanic Herbalism keeps costs low by NOT printing brochures and catalogs.

2. Why are classes so expensive?

They are not. They are some of the most reasonably priced classes in the United States.

3. Can you put me in touch with other curanderos and curanderas in my area?

I am sorry, but curanderos and curanderas do not usually network. I suggest you start with a local Hispanic herb store, often called a yerberito or botanica for local references.

4. I am doing a research paper on curanderismo. Can you tell me what you know or where I can find information on the topic?

I can tell you what I know if you are willing to take the time and be trained or sign up for my classes as I have not yet written the definitive book on the topic. For an overview of the subject, I suggest you read:

- Infusions of Healing by Joie Davidow
- Mexican-American Folklore by John O. West
- Witchcraft Along the Rio Grande by Marc Simmons
- Curanderismo: Mexican-American Folkhealing, 2nd edition, by Robert T. Trotter (though I disagree with the methodology he uses in his studies)
- Homegrown Healing: Traditional Home Remedies from Mexico, by Annette Sandoval

You can also peruse the extensive database at Baylor University School of Nursing for excellent information concerning Hispanic folk medicine.

<http://www.rice.edu/projects/HispanicHealth/Courses/mod7/mod7.html>

5. Are you available for lectures?

Yes, I am, though I am no longer willing to drive several hundred miles on my own nickel to do it. Pay for plane fare to and from, a hotel if it's outside of California, and a cup of coffee, and I would be more than happy to lecture your class or organization.

6. Will you do health consultations over the phone or on-line?

No. It's unethical to diagnose a patient without actually seeing him or her and getting complete background information--physical, emotional, and spiritual.

Additional Interesting Links

Pacific School of Herbal Medicine

<http://www.pshm.org/>

Michael Moore, School of Southwest Botanical Medicine

<http://chili.rt66.com/hrbmoore/HOMEPAGE>

Alternative Nature Online Herbal

<http://www.altnature.com/>

Tom Brown Jr., The Tracker School

<http://www.trackerschool.com/>

Earthwalk Northwest Inc.

<http://www.earthwalknorthwest.com/>

Wild Edible Plants and Ethnobotany

<http://www.edibleplants.com/>

Training in Wilderness Emergency Care

<http://www.mindspring.com/~donelan/>

Baylor University Hispanic Folk Medicine Link

<http://www.rice.edu/projects/HispanicHealth/Courses/mod7/mod7.html>

Mid-Atlantic Primitive Skills Group

<http://www.mapsgroup.org>



[Research Articles](#)

[Elijah Award](#)

THE ***MOORE FOUNDATION*** **And Academy** **Leaders in Homeschooling**



Hand in hand with homeschooling parents providing individualized curriculum, educational materials, and unit studies for Homeschool along with aid in learning disabilities, and gifted education.

"We invite everyone to search our site for an exciting adventure in learning. Our bookstore contains valuable Christian resources with character building values to help families in nurturing their children in the admonition of the Lord."

While taking into consideration the readiness and interests of the child, our educational counselors work closely with each parent to prepare a personalized curriculum for their student. Our goal is to nurture the seeds of uniqueness within each child. Moore Academy students mature in wisdom and personal growth through a program unlike any other. We are proud to present to the world, students who can think for themselves and be leaders for God.

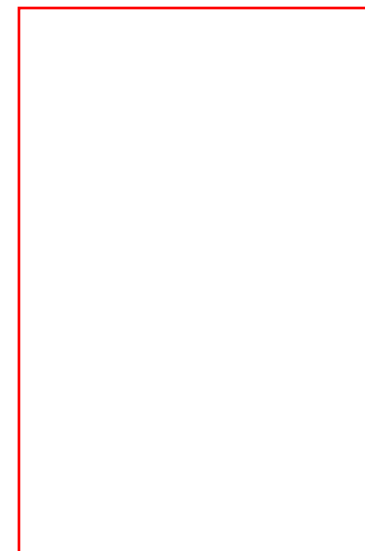

[Home](#) | [About](#) | [Formula](#) | [Academy](#) | [Catalog](#) | [Report](#) | [Seminars](#) | [Contact](#)

[MooreFoundation.com](#)

© 2003, all rights reserved. [Privacy Statement](#).

Web hosting by: [Hosford Web Service](#)

HOME STUDY INTERNATIONAL

[About HSI](#)

[Courses and Programs](#)

[Enrollment Information](#)

[Contact Us](#)



Home Study International is an accredited, Christian distance education provider. HSI offers both individual courses and complete programs to students for preschool through college.



[See the HSI video](#)



[Announcements](#)

1 (800) 782 - 4769

12501 Old Columbia Pike Silver Spring, MD 20904

[About HSI](#)

[Courses and Programs](#)

[Enrollment Info](#)

[Contact Us](#)



[Home Page](#)

[Welcome](#)

[About Us](#)

[Fan Mail](#)

[Contact Us](#)

[ONLINE SHOPPING](#)

[Free Printed Catalog](#)

[Orders Information Order Form](#)

[SYCAMORE ACADEMY](#)

[Sycamore Academy Family Website](#)

[Activity Page](#)

[Links](#)

[News](#)

[Our Location](#)

[Copyright © 2002](#)

MAKING HOMESCHOOLING EASY SINCE 1981!



Sycamore Academy is Accredited by Northwest Association of Schools and Colleges and Universities.

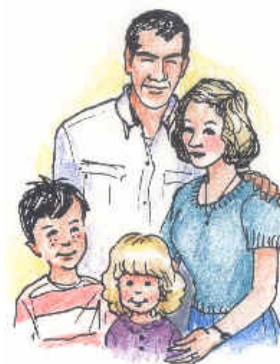

Sycamore Academy Families Page

[Sycamore Academy and Online School](#)

We have a wonderful, accredited, complete homeschool program for children in grades K-12. If you don't want to be the teacher, enroll your student in our accredited online school for grades 3-12. Both programs are accredited by NASCU.

[Sycamore Tree Catalog](#)

The Sycamore Tree offers over 2000 items to supplement the home school curriculum. This was the first catalog designed for homeschoolers. We have everything for your educational needs for K-12.

[Win a \\$25 Sycamore Tree Gift Certificate](#)

[May Specials](#)

Information: 714-668-1343

Orders: 800-779-6750

Fax: 714-668-1344

Email: info@sycamoretree.com

Mail: 2179 Meyer Place

Costa Mesa, CA 92627

Warehouse: 17150 Newhope Suite 701

Fountain Valley, CA 92708



THE HOME EDUCATION NETWORK

"Life is God's gift to you!"

"The way you live it, is your gift to God!"

[\(CLICK HERE\) TO LISTEN TO "HOMESCHOOLING-USA" RADIO PROGRAMMING](#)

"Homeschooling
Is Cool!"

[HOME](#)

[MISSION
STATEMENT](#)

[ARTICLES](#)

[PHOTO ALBUM](#)

[MEET THE STAFF](#)

[VICKI'S TOP TEN](#)

[FREE
RESOURCES](#)

[HOMESCHOOL
LINKS](#)

[TAPES & BOOKS](#)

[CONTACT US](#)

[RADIO
ARCHIVES](#)

[AFFILIATE STATIONS](#)

[AFFILIATE
INFORMATION](#)

[CHEERLEADER
CLUB](#)



Terry and Vicki believe:

"Every family homeschools! Some may choose to delegate a portion of their education out to the public school, private school or just keep it all in house!"

"Sometimes, new opportunities are just outside the perimeter of our comfort zone!"

only GOD can turn

**a MESS . . . into a MESSage,
a TEST . . . into a TESTimony,
a TRIal . . . into a TRIumph,
a VICTim . . . into a VICTor!**

we are Dedicated to all of the parents, grandparents and families who homeschool their children, giving of their time, talents, wisdom and money to insure successful future generations living for Christ Jesus our Lord!



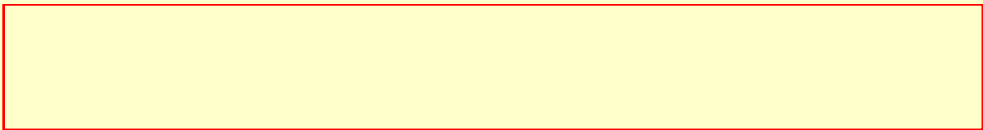

Home Education Network, Inc.

PO Box 147

Hereford, AZ 85615

E-Mail: terry@homeschoolingusa.com



Welcome to Hiking Las Vegas

Did you know southern Nevada is the best kept outdoor secret in the country? The information on this Web site can have you and your family sitting at waterfalls, admiring 3,000 year old trees, or standing at peaks few have ever visited.

Get the [self-guided hike directions](#)

[Recommend this site to a friend](#)

[Testimonials](#)

[Search](#)

[Site Map](#)

[Email](#)

Copyright © [Branch Whitney]. All rights reserved.
Revised: May 07, 2004 .

[Members Enter Here](#)

Receive our Newsletter
Enter your name and email
address:

Name:

Email:

[Subscribe](#) [Unsubscribe](#)

Warning! Hiking and mountaineering are dangerous and can result in serious injury or worse. By exploring this web site you acknowledge that the information presented might be out of date or incorrect. You agree not to hold the author responsible for any damages, injuries, or death arising from any information on this Web site. Please research any mountain before attempting to climb it. Do not substitute the information on this web site for experience, training, and recognizing your limitations!

Privacy Policy

Hiking Las Vegas respects your privacy. I do not collect email addresses, except when they are included with orders. I do not rent, sell or trade email addresses with anyone. I do not use cookies to keep track of your surfing when on this site. I will not send unsolicited email to you. I treat you how you want to be treated.



Saskatchewan Canada has one of the world's great wilderness canoe areas. Half of the province is covered by forest and one-eighth is water. The Precambrian shield in northern Saskatchewan provides the setting for an adventurer's paradise.

The information presented on these pages will help you appreciate this land and enable you to come in person to enjoy it. Just remember that for thousands of years people have used these portage trails, these campsites and these waterways, and we hope that future generations may also be able to enjoy them.

Subscribe to the Waterways Egroup

and discuss canoeing, trips you plan to take, trips you took, etc.

Powered by
groups.yahoo.com

Or you can leave a message in our online [bulletin board](#).

[Notes from Missinipe](#) has been updated 3 June, 1997

We invite you to browse through our [Gift Shop](#), view the [Paddlers' Gallery](#) and read trip diaries, or visit our [links to other Internet sites](#) to find related information.

your own pictures and stories. See the [Table of Contents](#) for a list of all the pages on this site.

To help you plan a Saskatchewan canoe trip:

- [Routes & Trips](#)
- [Quick Trip Search Page](#)
- [Advanced Trip Search Page](#)
- [Saskatchewan Documented Canoe Routes](#)
- [Maps](#)
- [Rapids Classification](#)
- [Voyageur Certificates](#)
- [Local Information](#)
- [Transportation to the North](#)
- [Water levels](#)
- [Events](#)
- [Canoe Clubs](#)
- [Climate/weather](#)
- [Fire history & present conditions](#)
- [Wilderness Living](#)
- [Environmental Ethics](#)
- [Trip planning & preparation](#)
- [Basic Wilderness First Aid](#)
- [What to do when it rains and rains . . .](#)
- [Bears and Other Critters](#)
- [Resources: books, first aid courses, wilderness programs](#)
- [Outfitters](#)
- [Churchill River Canoe Outfitters/Horizons Unlimited](#)
- [CanoeSki Discovery Company](#)
- [Barrier Valley Lodge](#)
- [Lafleur Outdoor Adventures](#)
- [Rabbit Creek Outfitters](#)
- [Theriau Lake Lodge](#)

To learn more about our waterways:

- [Archaeology](#)
- [Human History in Far Northern Saskatchewan](#)
- [Saskatchewan Archaeological Society](#)
- [Stories](#)
- [Aboriginal Rock Paintings](#)
- [Bibliographies](#)
- [Geology](#)
- [Geological History](#)
- [Geological Domains](#)
- [Churchill River Study](#)
- [Geological Definitions](#)
- [Gold in the Rocks](#)
- [Reading list](#)
- [Native Lifestyle and Crafts](#)
- [Lifestyle](#)
- [Traditional Crafts](#)
- [General History](#)
- [History of Saskatchewan Waterways](#)
- [Saskatchewan River History](#)

Observed at La Ronge, Canada 16:00

Mostly Cloudy, 39° F / 4° C

Wind West at 10 mph / 16 km/h

Pressure 30.08 in / 1018 hPa

[WeatherUnderground.com](#) [Click for Forecast](#)



Page creation by Rebecca
Kennel Consulting

These pages are stored on
the
[Northern Lights Internet
Solutions](#) server

Yahoo!Canada
[Pick of the Week](#)
August 28, 2000



Backwoods Home Magazine

practical ideas for self-reliant living



Want a more self-sufficient lifestyle for you and your family? Backwoods Home Magazine can help you achieve it. Every issue is packed with solid, practical, hands-on information on a wide range of self-reliance topics.

Tell-A-Friend about this site
Win a BHM Anthology



Remembering
Sept. 11, 2001

Enter A Keyword

Search
BHM

Subscribe

Features

[Home Page](#)
[Current Issue](#)
[Article Index](#)
[Previous Issues](#)
[Newsletter](#)
[Letters](#)
[Humor](#)
[Free Stuff](#)
[Feedback](#)
[Recipes](#)
[Tell-A-Friend](#)
[Home Energy In](#)

Quick Links

[Massad Ayoub](#)
[Ask Jackie Clay](#)
[Dave Duffy](#)
[John Silveira](#)
[Claire Wolfe](#)

Forum / Chat

[Forum/Chat Info](#)
[Enter Forum](#)
[Member Chat](#)
[Lost Password](#)

General Store

[Ordering Info](#)
[Subscriptions](#)
[Anthologies](#)
[Books](#)
[Back Issues](#)
[Help Yourself](#)
[All Specials](#)
[Classified Ad](#)
[Trading Post Ad](#)

Advertising

[Swap Meet](#)
[Print Classifieds](#)
[Trading Post](#)
[Web Site Ads](#)
[Magazine Ads](#)

Read online from the current issue:

[The poor man's ceramic knife sharpener](#)

By Rick Brannan

There are few things more frustrating and dangerous than working with a dull knife. In my quest for a sharp knife, I have purchased many different styles of knife sharpeners. From whetstones to oilstones, fixed-angle sharpeners to diamond dust-impregnated steels, I have used them all and have spent hundreds of dollars in the process. Which is why knife sharpening has become big business. Some sharpeners cost more than the knives.

But of all the sharpeners I have used over the years, I have had the best results with the ceramic sharpeners.

[The tenuous hold of honesty in modern America](#)

By John Silveira

I went to high school in Derry, New Hampshire. Pinkerton Academy. Its most famous alumnus is the late Alan B. Shepard, one of the original seven American astronauts, first to ride in the Mercury space capsule, and the only one of those seven to walk on the moon. I was a senior at Pinkerton the day Shepard took his suborbital flight. The press was there, too, looking for a story. I don't think they knew what they'd find.

[Read more articles from the Current Issue or read features in Adobe PDF format](#)



Get 3 FREE gifts,
including a 384 page anthology,
with any regular subscription
[Click Here](#)

More Features

- [Links](#)
- [Country Moments](#)
- [Radio Show](#)
- [Meet The Staff](#)
- [Contact Us/](#)
- [Address Change](#)
- [Write For BHM](#)
- [Privacy Policy](#)

News/Politics

- [Dave Duffy](#)
- [John Silveira](#)
- [Columnists](#)

Link to BHM

Available Now In
The General Store

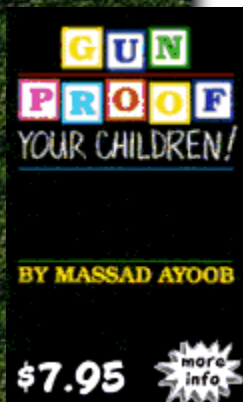

Win a FREE CD!

Our Latest [Tell-A-Friend](#) Winner:

Kristen Owen of Lyons, Colorado

We've had 88 winners so far. You could be the next to win a CD anthology. [Here's How!](#)

Feedback

BHM welcomes your letters. We are especially interested in your non-political letters that talk about how you live your self-reliant life.



Updated April 26

[Click Here To Read Or Write Letters](#)

Get Powered Up!

Certified energy manager Jeff Yago answers your questions on our new

Home Energy Information

page. You'll also find quick links to online articles and more.

[Click here](#)

Stop back often.
You'll find something new on our home page every few days.

Hardyville, USA

[Heading for Hardyville Gulch](#)

by Claire Wolfe

So I'm driving out of town when I see the strangest thing. There's Nat's old Dodge pickup parked at the side of the road. He's roped his battered shooting bench in the bed. And there sits Nat himself with his spotting scope nearby, his deer rifle at the ready, and a six-pack of Moose Drool beer. He's peering over the rifle down the long, empty stretch of road that leads to Hardyville.

Naturally, I have to stop and find out what the heck is going on.

Previous Column - [Miss Fitz' Guide to Guns](#), Part IV: Learning to save your life

Duffy's View

[Gold Beach basketball celebrates American life](#) by Dave Duffy

Amid all the terrorist threats and bombings in Europe and the Mideast, and amid America's reprisals against terrorists around the world, here in the little town of Gold Beach, Oregon, we're getting set to have our Rotary Basketball League end-of-season party at our local pizza shop. Honored guests are the seven boys, ages 10 to 12, who made up Backwoods Home Magazine's entry into the Rotary League.

The Affordable Whole Sheebang!

Includes 2 new Books
& our 4-year Anthology CD

You'll get
11 Print Anthologies
12 CD Anthologies
PLUS

A FREE 2-Year subscription to

Lifetime Subscription Special

Save \$355.85

Backwoods Home Magazine

Only 3 payments of \$69

Save \$196.35!

[Click here for details](#)

Order a Lifetime subscription to BHM and we'll send you The Whole Sheebang, advertised to the left, absolutely FREE!

Plus you'll get all our future anthologies sent to you FREE

Only \$500

[Click here for details](#)

BHM Web Site Exclusive

[Brood X](#) by Rev. J.D. Hooker

Though I was still in my early thirties at the time, I clearly remember fishing during the last big 17-year hatch. At that time I'd simply gather up a large quantity of already dead locusts from where they'd fallen around the tree trunks and, after threading a locust on to a relatively large #1-size hook attached to a tapered leader, I'd flip-cast the bug into a shaded area right up near the bank. If I didn't get a strike within the first few seconds, I'd give my rod a little twitch causing the bug to move only a couple of inches. This nearly always triggered an actual attack by a frenziedly feeding fish.

BHM Web Site Exclusive

[Getting Logs](#) by Dorothy Ainsworth

Attention: Would-be loggers. There have been changes in policy at the United States Forest Service and the Bureau of Land Management. I have just found out that the procedure to obtain logs through the USFS or BLM has changed drastically because of the NEPA (National Environmental Protection Agency). You can no longer go into a ranger station like I did and simply get a permit to cut your own logs in a given area. Now you have to go through a "process".

BHM Web Site Exclusive

Ayoob on Firearms

[Firearms handling refresher Part III: Rifles](#) by Massad Ayoob

Always remember that training is a good investment in anything serious. Your local fish and wildlife department, or your local gun shop, can probably steer you to certified instructors. So can the National Rifle Association, at their toll-free number 1-877-NRA-2000. Jeff Cooper's Gunsite has an excellent course they call "General Rifle," and Clint Smith's Thunder Ranch still offers the course that made "Urban Rifle" a byword in training. Another good source is the Firearms Academy of Seattle where the pictures that accompany this article were taken. I particularly recommend the rifle classes FAS offers taught by Georges Rahbani. The graduates rave about the program.

Previously: [Part I: Handguns](#), [Part II: Shotguns](#)

Recipe of the Week from [Backwoods Home Cooking](#)



[Succulent venison stew](#)



From Our [Seventh Year Anthology](#)

Here are some cucumber pickles to make at home By Olivia Miller

Preserving produce by "pickling" is one of the oldest and most delightful ways to save your summer harvest for your winter table. The word "pickle" applies to any food preserved in brine and/ or vinegar, with or without bacterial fermentation, and with or without the addition of spices and sugar.

[Read this article](#)

From Our [Eleventh Year Anthology CD](#)

Build this sturdy large-capacity food dehydrator By Charles Sanders

Drying of food as a means of preservation has been around for a long time. Populations in suitably dry climates all around the globe have dried meat, fish, fruit, and vegetables in times of plenty as a way to provide for the leaner months of the year. My grandmother used to tell us of when she was a child, helping to spread apple slices on the top of a tin-shed roof for drying. An aunt once described stringing fresh young bean pods on a long heavy thread and hanging them to dry, coming up with what they called leather-britches beans. Obviously, these were simple and imperfect food drying systems, but they do show ways in which food can be dried at home.

[Read this article](#)

Super Special Anthology Sales

Get a FREE 1 year subscription to
Backwoods Home Magazine

when you buy our Eight Anthology
Special or our CD Anthology Special

[Click Here for more info](#)

FREE Toolbar for Internet Explorer



Great features. Customizable. Get yours now!
[Click for details.](#)

Featured Writer

[Determined woman builds distinctive vertical log studio](#)

By Dorothy Ainsworth

For a novice, there's no thrill like the tactile kinetic experience of driving a 16-penny nail home in three blows, then burying its head with two extra whacks for no reason. There was evidence of beginner's overkill everywhere. Electrical cord repairs looked like snakes that had swallowed gophers. A job wasn't finished until all the nails were gone. There were no gimmicks or shortcuts in the learning process. I sweated and strained and scarred. But the satisfaction of sawing a clean square cut with a hand saw rivaled sewing a fine seam or baking a perfect loaf of bread, and eventually the results became just as predictable.



More by Dorothy Ainsworth:

[Never underestimate a woman](#)

[Dorothy Ainsworth update: Out of the ashes](#)

[Dorothy Ainsworth makes her valiant comeback](#)

[Build a log crib](#)

[This coop is for the birds](#)

[Start a post-construction cleaning business](#)

[Make a quilt out of Levis](#)

[A river rock shower](#)

Dorothy Ainsworth responds to critics

[The "Curious Guy" and the "Offended Woman"](#)



Newly Revised! Now 296 pages!!

BHM's

Emergency Preparedness and Survival Guide

Choose the 296 page book,
the expanded CD-ROM, or both!



[Click Here for more information.](#)

Back Issue Special

12 15 selected issues for only \$29.95.
Save \$45.05!

[Click here for details](#)

In The BHM Book Store

[Fences for Pasture & Garden](#)

[Brewing the World's Great Beers](#)

[Making Rag Rugs](#)

[How To Live Without Electricity And Like It](#)

[GunProof Your Children](#)

[Storey's Guide to Raising Chickens](#)

[Herbal Tea Gardens](#)

[365 ways to RELAX mind, body & soul](#)

[The Self Reliant Homestead](#)

[Sex and Sins in the Cemetery](#)

From Past Issues

[Used bookstores can be successful in the hinterlands](#)

By Jennifer Stein Barker

[A Native American feast](#)

By Jackie Clay

[Tools and hardware for the backwoods home](#)

By James Ballou

[Finding the best dog for the country life](#)

By Anita Evangelista

[Five building tricks for super strong framing](#)

By Don Fallick

[Southern cooking that doesn't just whistle Dixie](#)

By Richard Blunt

[Everybody talks about lightning — and yes, there are things you can do about it](#)

By Albert H. Carlson

[America's earliest First Ladies were fascinating](#)

By John Silveira

Place your FREE Ad to buy, sell or trade stuff in the

Click
Here

BHM Swap Meet

Click
Here

Backwoods Home Magazine strives for accuracy in its articles and honesty in its advertisements, but the publisher and editors assume no responsibility for injuries or loss incurred by anyone utilizing the information in the articles, responding to the ads or following any of the links posted on this website.

[Please click here to read our privacy policy.](#)

Top of Page

www.backwoodshome.com designed and maintained by [Oliver Del Signore](#)
© Copyright 1998 - 2004 Backwoods Home Magazine

May 10, 2004



The #1 Paddlesports Resource ©

[:Subscribe](#)

[:Give a Gift](#)

[:Message Boards](#)

[:Contact Us](#)

[:C&K Merchandise](#)

[:Calendar](#)

[:Photos](#)

[:Paddling Schools](#)

[:Adventure Paddling Directory](#)

[:Free Product Info](#)

Canoe & Kayak FREE TRIAL ISSUE
SUBSCRIBE NOW ▶ [click here](#)

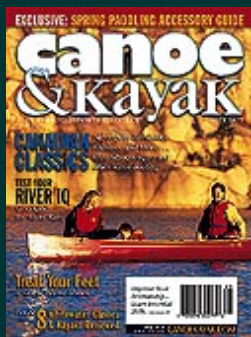

© BERNE BROUDY

From our new issue Destination Guide, [Saguenay, QC](#)

[Photo by Berne Broudy](#)

[Inflatable Kayaks](#)

first need
 water purifier
generalecology.com

[HOME](#)

[AUDIO VIDEO](#)

[FEATURES](#)

[GET STARTED](#)

[PADDLING](#)

[HOW TO DO IT](#)

[NEWS](#)

[PADDLE LINKS](#)

[WHAT TO TAKE](#)

[WHERE TO GO](#)

[SEARCH](#)

[OUTDOOR OFFERS](#)

[KAYAK GEAR](#)

[KAYAK](#)

[OUTFITTERS](#)

[SEA KAYAK](#)

[NECKY KAYAKS](#)

[PERCEPTION](#)

[KAYAKS](#)

NEW ON THE WEB SITE



[Destination Guide](#)

Editor Ross Prather talks about the premier issue of *Canoe & Kayak's* Destination Guide.



[Interview With Jay Kincaid](#)

Freestyle kayak champion Jay Kincaid talks about kayaking in the biggest little city in the world.

[VIDEOS: These clips could save your life!](#)

We've got some great capsiz recovery techniques that all sea kayakers should know.

C&K NEWS FROM ALL OVER

[Current Designs Moving to Minnesota](#)

May 3 Wenonah Canoe has announced plans move construction of its Current Designs brand of kayaks from Victoria, B.C., to Winona, MN, where it will build a new 40,000-square-foot factory.

The Element from Honda.
Get inside.

ELEMENT

4WD EX model show with accessory roof rack.

Subscribe to our newsletter



ADVENTURE PADDLING DIRECTORY

PADDLING SCHOOLS

FREE PRODUCT INFO



ACTION SPORTS GROUP

- [Surfer Magazine](#)
- [Surfing Magazine](#)
- [SG Magazine](#)
- [Snowboarder Magazine](#)
- [Skateboarder Magazine](#)
- [Powdermag.com](#)
- [Bike Magazine](#)
- [Climbing Magazine](#)
- [Canoe & Kayak Magazine](#)
- [Gravity Games](#)



[Late-Bloomer Boomer](#)

A fifty-something paddler tries his hand at whitewater.

[U.S. Qualifies 8 for Olympics](#)

May 3 The K-4 team of Kathy Colin, Carrie Johnson, Lauren Spaulding, and Marie Mijalis, along with the K-2 team of Rami Zur and Jeff Smoke and the C-2 team of Jordan Malloch and Nate Johnson each qualified for the 2004 Summer Games in Athens with their performances in the Pan American Championships, providing the US with eight positions in the Athens Games this summer. More Olympics news below!



CURRENT ISSUES

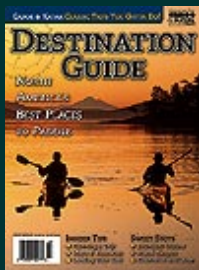

[Destination Guide](#)

04

Classic North American canoe and kayak trips you have to do!

[Smoke Clinches Trip to Olympics](#)

[Mijalis, Kayak Team Qualify](#)

[Exploring the Oceans in a Kayak](#)

May 3 Writer Jon Bowermaster met adventures while kayaking along the Tuamotu Archipelago, a chain of 78 islands north of Tahiti.



[Allagash Wilderness Waterway, ME](#)

Traveling in 19th-century style, current-day canoeists experience the

north-woods lore of Maine on one of its most storied rivers.



[C&K Wins Two Awards](#)

Canoe & Kayak Magazine won two prestigious Maggie Awards, which

recognize excellence in magazine publishing west of the Mississippi River.



[I Dream of Fiji](#)

This island nation is a paddler's paradise, but the warmth of its people is what lingers.

[Slalom Kayak Team for Olympics is Set](#)

April 26 It did not happen the way they had exactly hoped, but Joe Jacobi and Matt Taylor will both return to Athens for their second Olympic Games in whitewater canoe/kayak slalom.

FEEDBACK

[Vote in the Canoe & Kayak Readers Choice Awards](#)

Vote now for your favorites in the paddlesports world. Favorite kayak, favorite canoe, favorite place to paddle - it's all up to you!

[Canoe Museum Reopens](#)

April 26> Next weekend, Canadians will be able to thrill again to the sight of Pierre Trudeau's famous buckskin jacket as the Canadian Canoe Museum reopens its doors to the public after financial difficulties forced its closure last October.

[Poll Results](#)

Final Results from the Latest Poll

How did you learn to paddle? Total

Votes: 374

From my parents: 9%

From friends: 11%

From a paddling school: 5%

At summer camp: 8%

From a club: 5%

At school: 2%

Paid private instruction: 1%

On my own: 55%

[C&K Links of the Week](#)

NASA Earth Observatory, photos from space:

earthobservatory.nasa.gov

Terra Server, maps and photos:

teraserver.Microsoft.com

The Kayak Building Web Ring:

www.guillemot-kayaks.com

[Come-Back Kayaker](#)

April 23 Carrie Johnson has left woes in her wake, earning a trip to Athens.



[Reno Celebrates Whitewater](#)

Kayak races, free clinics, live music and a movie premier are all part of the fun at

the grand opening of a new whitewater park in Reno, Nevada.

[April 21-Kayaker Sneaks to Win at Trials](#)

Rami Zur came up on the outside to win a spot on the flatwater sprint kayak team. Read more Olympic tales below.

CALENDAR

April 30-May2 Cape Hatteras Splash. Paddle like crazy. Eat like royalty. Party like we don't have jobs. www.caphatterassplash.org.

GEAR



[Get Your Feet Wet](#)

The right water shoes will drain and dry quickly, grip on wet and slippery surfaces, and keep your feet

safe from bumps and bruises along the way.

[More Great Gear](#)

Check out more paddling gear reviews from *Canoe & Kayak Magazine* here.

WHERE TO PADDLE



[Moisie River](#)

Big-volume, black with tannins, full of boisterous rapids and falls, Quebec's Moisie River is an ideal

coming-of-age run.

[More Destinations](#)

Find more destination stories from *Canoe & Kayak Magazine* here.

Canoe & Kayak also publishes four special paddling annuals: Kayak Touring, Whitewater Paddling, Canoe Journal, and Beginner's Guide, as well as Paddlesports Business, a bimonthly trade publication for industry members.



[The Complete Guide To Kayak Touring](#)



[The Complete Guide To Whitewater Paddling](#)



[The Beginner's Guide To Canoeing and Kayaking](#)



[Canoe Journal](#)

[Subscribe](#) | [Give A Gift](#) | [Subscriber Services](#)
[Privacy Statement](#) | [Home](#) | [Contact Info](#)

Welcome welcome



More Searches:

- [academy outdoors sports](#)
 - » academy outdoors sports store
 - » academy houston outdoors sports
- [great outdoors](#)
 - » great outdoors grill
 - » great outdoors gas grill
- [alaska outdoors](#)
 - »
 - »
- [realtree outdoors](#)
 - » bill jordans realtree outdoors
 - » bill jordan realtree outdoors
- [api outdoors](#)
 - » api inc outdoors
 - » api outdoors stands tree
- [sex outdoors](#)
 - » outdoors sex teen
 - » gay sex outdoors
- [espn outdoors](#)
 - » espn game hunting outdoors
 - »
- [flw outdoors](#)
 - »
 - »
- [western outdoors news](#)
 - »
 - »
- [nude outdoors](#)
 - » nude woman outdoors
 - » nude man outdoors
- [great outdoors grill](#)
 - » great outdoors gas grill
 - » company great grill

Search.

Search Results for:

outdoors Directory... More Searches.

- [outdoors turner](#)
[man outdoors turner,](#)
- [drury outdoors](#)
- [buckeye outdoors](#)
- [gay outdoors](#)
[gay man naked outdoors thumbnail,](#) [gay man outdoors,](#) [gay sex outdoors ...](#)
- [academy outdoors sports](#)
- [johnson outdoors](#)
[johnson outdoors inc,](#)
- [academy outdoors](#)
[academy outdoors sports store,](#) [academy outdoors,](#) [academy sport outdoors ...](#)
- [sierra outdoors](#)
- [great outdoors gas grill](#)
[aluminum gas great grill outdoors,](#)
- [cabelas outdoors](#)

	<p>outdoors</p> <ul style="list-style-type: none">● naked outdoors<ul style="list-style-type: none">» naked man outdoors» naked woman outdoors ● michigan outdoors<ul style="list-style-type: none">» magazine michigan outdoors» ● coleman outdoors<ul style="list-style-type: none">»» ● avery outdoors<ul style="list-style-type: none">»»
--	--

www.outdoor-online.com

Related Searches:

- [eastman outdoors](#)
 - »
 - »

- [great outdoors store](#)
 - » great home outdoors store
 - »

- [peeing outdoors](#)
 - » woman peeing outdoors
 - » man outdoors peeing

- [whitewater outdoors](#)
 - » whitewater outdoors clothing
 - »

- [greatland outdoors](#)
 - » greatland outdoors tent
 - »

- [outdoors unlimited](#)
 - » duck festival great outdoors unlimited
 - » net outdoors unlimited

- [cat house outdoors](#)
 - »
 - »

- [mark outdoors](#)
 - »
 - »

- [outdoors adventure](#)
 - » adventure bound outdoors
 - »

- [outdoors popular](#)
 - » outdoors popular store
 - »

outdoors

- [ashley outdoors](#)

- »

- »

- [outdoors georgia](#)

- »

- »

- [outdoors ramsey](#)

- »

- »

- [pissing outdoors](#)

- » man pissing outdoors

- »

- [iowa outdoors](#)

- »

- »



outdoors



It looks like you're using an outdated browser.

The Away Network is trying to stay current. We want to pursue new interactive features and offer great products to make your browsing more exciting and useful. For this reason, The Away Network no longer builds its web pages for Netscape versions lower than the 6.0 series, or for Internet Explorer browsers lower than the 4.0 series.

Over 97% of our users have already adopted newer browser versions. If you'd like to improve your experience on our Network sites—and on many other sites on the Web—we suggest you upgrade for free.

Download or find out more about :

- Netscape 7.0 : [Netscape's browser download page.](#)
- Internet Explorer 6 : [Microsoft Internet Explorer 6.0 homepage.](#)
- Mozilla 1.3.1 : [Mozilla's homepage.](#)



42nd BRIGHTON (Saltdean)







Scout Group, East Sussex, UK

Get Knotted!



Animated Knots for Scouts

You are visitor No: **19039** to look at our knots.

(Add 530,000 for counter resets)

Knot	Size (Kb)	Thumbnail
 Bowline	17k	
 Clove Hitch	5k	
 Figure of Eight knot, Flemish knot, Savoy knot	6k	

<ul style="list-style-type: none"> Fisherman's knot, Angler's knot, English knot, Englishman's bend, Halibut knot, True Lover's bend, Waterman's knot 	9k	
<ul style="list-style-type: none"> Lark's Head, Cow Hitch, Lanyard Hitch 	4k	
<ul style="list-style-type: none"> Reef knot, Square knot 	10k	
<ul style="list-style-type: none"> Rolling Hitch, Magner's Hitch, Magnus Hitch 	6k	
<ul style="list-style-type: none"> Round turn and two half hitches 	12k	
<ul style="list-style-type: none"> Sheepshank 	14k	
<ul style="list-style-type: none"> Sheet bend, Flag bend, Common bend 	7k	
<ul style="list-style-type: none"> Sheet bend - Double 	11k	
<ul style="list-style-type: none"> Sheet bend - Left Handed 	7k	
<ul style="list-style-type: none"> Thief knot 	8k	
<ul style="list-style-type: none"> Thumb knot, Overhand knot 	5k	
<ul style="list-style-type: none"> Timber Hitch 	9k	

 Provide a link	9k	
--	----	--

Please Note

Do not copy these animated knots pages and text and publish them on the Internet or elsewhere. If you want to put animated knots on your website then please draw your own.

Some readers of these pages have had problems viewing the knot animations because their browsers do not support the required standards.

If you find that you cannot see the animated knot when you select one of the above, then you will need to upgrade your browser.

To make this as easy as possible, you can use the links below to upgrade to the latest versions of Microsoft Internet Explorer or Netscape.



[Download Internet Explorer](#)
[Download Netscape Navigator](#)

-
-  [Knot Welcome page](#)
 -  [Troop Home Page](#)
-



Copyright (C) Dick Ruck 1997



[Start page](#)

Knots:

[Reefknot](#)

[Fisherman's Knot](#)

[Water Knot](#)

[Sheetbend](#)

[Lark's head](#)

[Round Turn](#)

[Timber Hitch](#)

[Fisherman's loop](#)

[Bowline](#)

[Prussick](#)

[Clove Hitch](#)

[Sheepshank](#)

[Jug Sling Hitch](#)

[Whipping](#)

[Round hitch](#)

[Slippery round hitch](#)

[Pile Hitch](#)

[Two Half Hitches](#)

[Buntline Hitch](#)

[Monkey's fist](#)

[Diamond knot](#)

[Simple Simon Over](#)

[Double Simon](#)

[Simple Simon Under](#)

[Vice Versa](#)

[Sign Guestbook](#)

[Read Guestbook](#)



The Knotting Dictionary of Kännnet

"At the bright side of life"

Warning!

None of these knots is considered 'safe' for climbing! The main purpose of this page is **scouting**, not climbing. Maybe in the future, I will add some other knots!

Credits:

Webmaster:

[Jan Korpegård](#) jan@korpegard.nu

Idea:

Samuel Korpegård

Illustrations:

Andreas Joakimson, [Jan Korpegård](#)

Thanks to:

[James Smith](#) for help with the translation.

You are visitor nr **159298** since 990301.

©1994-2002 Korpegard.nu



Gerald L. Findley, all rights reserved

ROPE WORKS ©1999

Lashing

Lashings are used to join poles or spars when building pioneering structures. These structures can be functional, such as tables, bridges, and towers or decorative such as gateways. The only limit as to the type of structure is the imagination of the builder.

Correctly tied lashings in pioneering structures are essential for safety. When young people see an interesting structure they charge up and over with no thought as to the soundness of the structure. This places the responsibility for a safe structure directly on the builder.

The following topics about lashing are covered in :

ROPE WORKS

- Square Lashing
- Diagonal Lashing
- Tripod Lashing With Racking Turns
- Tripod Lashing With Plain Turns
- Shear Lashing With Racking Turns
- Shear Lashing With Plain Turns
- Shear Lashing Quick
- Round Lashing
- Round Lashing West Country
- Floor Lashing



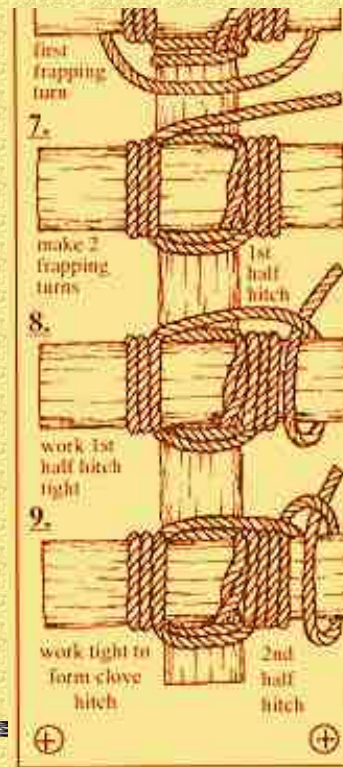
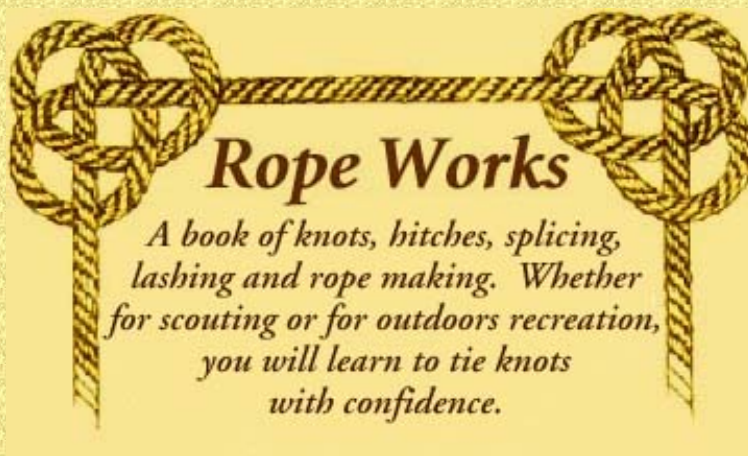

Order a copy of RopeWorks now !



[Home](#)
[E-Mail](#)



Introduction
Knots & Hitches
Splicing
Lashing
Making Rope
Links
Knotboard of the Month
Archive
Ordering

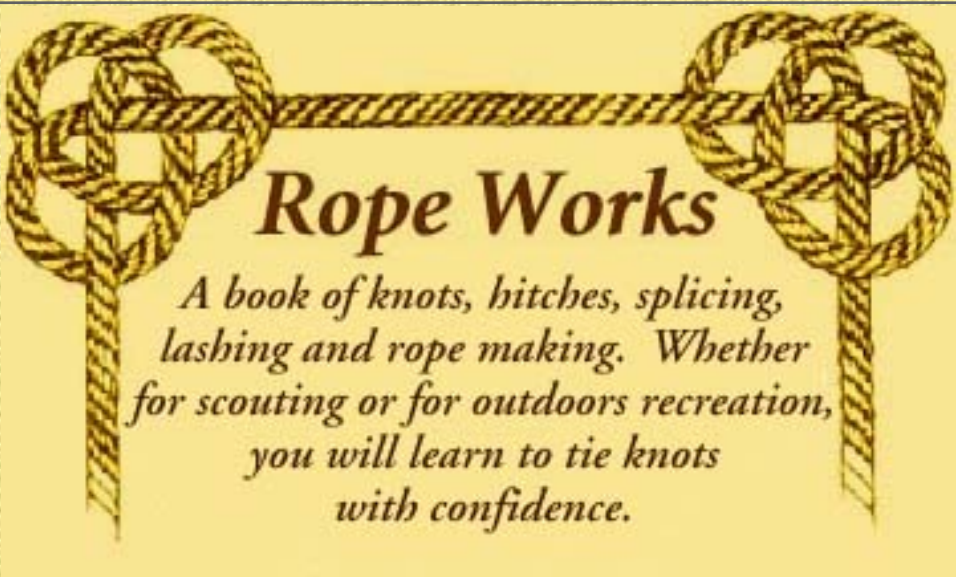

Rope Works
A book of knots, hitches, splicing, lashing and rope making. Whether for scouting or for outdoors recreation, you will learn to tie knots with confidence.

This site was updated JUNE 23, 2002 :

Rope Works can now be ordered by credit card Through PayPal



FastCounter by LinkExchange

FastCounter by LinkExchange

<http://www.fastcounter.com>

 **GUESTBOOK** 
[E-Mail](#)

Not Found

The requested URL was not found on this server.

Apache Server at webshirt.com

Search

» [Keywords](#)

Moon Phase

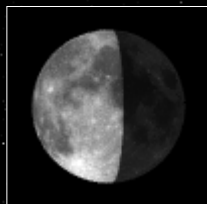

Provided by [U.S. Naval Observatory](#)

» [Be A Stargazer](#)
 » [Moon Calculator](#)
 » [Send a Postcard](#)

Stargazing Tip of the Day

Look for the planet Mercury as dawn breaks the next few mornings. It looks like a fairly bright star, but it's quite low in the east, so it's tough to find. Skywatchers at southern latitudes have the best chance of spotting it.

» [This week's tips](#) | [Last week's tips](#)

Today's Radio Program
[Morning Mercury](#)

» [Listen to yesterday's program](#) | [Program Schedule](#)

Today's Question
[Frequently Asked Questions](#)

StarDate magazine



Destination:
[Saturn](#)

» [Subscribe](#)
 | [Back](#)
 | [Issues](#)
 | [News](#)
 | [Archive](#)

From the Gift Shop

Horsehead Nebula (IC 434)



Lying just below the belt of Orion, the Horsehead

Nebula, as shown by this McDonald Observatory image, is actually two nebulae, one lying in front of the other. 8x10 inches, color. (Tom Montemayor)

» [More Information](#)

New & Updated

» [Two Comets Climb into Night Sky](#)

Image of the Week



Icy Visitor

» [Image of the Week Archive](#)

McDonald Observatory



» [Upcoming Events](#)
 » [Visitors' Center](#)
 » [News Room](#)

Special Features





Información en español: 
[Site Map](#) | [Privacy](#)



The
Asahi
Beer
Natural
Science
Classroom



Welcome to the Geospace Environment Data Display System

GEDDS Data:

[Allsky images](#)

([go to the real-time allsky display](#))

[Meridian Scanning Photometer](#)

[College Digital Ionosonde](#)

[Magnetometer Plots](#)

[Inuvik FPS](#)

[High Latitude Monitoring Station \(HLMS\)](#)

[Solar Activity](#)

[TEC measurements from 150 and 400 MHz satellite beacons](#)

[Data Plots](#)

[Data Access](#)

[The Aurora Color Television Project](#)

[Asahi Presents: The Aurora](#)

Other Sites:

[Poker Flat Research Range](#)

[The Geophysical Institute The University of Alaska Fairbanks](#)

The GEDDS is a near-real time data acquisition, distribution and display system used in space weather now- and forecasting, and for launching high-latitude scientific sounding rockets. The rockets are launched from [Poker Flat Research Range](#) about 30 miles north of Fairbanks, AK. The range is owned and operated by the [University of Alaska Fairbanks](#), and is managed by the faculty and staff of the [Geophysical Institute](#).



This website is intended to provide access to some of the GEDDS data. Select a link at the left to pick the information you want to investigate, or pick from one of our featured data sets:

- [College Magnetometer](#)
- [GEDDS Summary](#)
- [Alaska Chain Magnetometers](#)
- [East-West Chain Magnetometers](#)
- [Northernmost Alaska Chain Magnetometers](#)

[Click here for a complete list of GEDDS Notices](#)

This page last updated Tuesday, November 25, 2003 at 06:29 PM by [Ed Hoch](#).

WWW Tide and Current Predictor



Tidal Height and Current Site Selection

Select a region here, then from that page, select a site for which to generate predictions. You will get basic predictions and a form for customized predictions. Predictions take a few moments to calculate, please be patient. Please [see the FAQ](#) (Frequently Asked Questions list) if you cannot find the site you want.

NOTE: Any site name ending in "Current" will generate predictions of current speeds; all other sites generate tidal height predictions. There are many more locations for tidal height predictions than for current speed predictions.

[U.S. Upper East Coast \(Maine through Virginia\)](#)

[U.S. Lower East Coast \(North Carolina through Florida Keys\)](#)

[U.S. Gulf Coast sites \(East to West\)](#)

[U.S. West Coast sites \(North to South\)](#)

[Northern sites \(except Japan\) outside contiguous U.S. \(East to West\)](#)

[Southern sites outside contiguous U.S. \(East to West\)](#)

[Japan and nearby sites \(North to South\)](#)

[Alphabetic list of *all* tidal height sites](#) (large 600KB page)

[Alphabetic list of *all* current speed sites](#)

Useful Links

[Pictures and info about the server running this site.](#)

[FAQ \(frequently asked questions\) for this site.](#)

[Information on preselecting sites and options.](#)

[Usage statistics of this site.](#)

[Near-term official U.S. tide predictions](#), [Explanation of tides](#) and [Tide glossary](#) at NOAA/NOS.

[Realtime oceanographic observations at NDBC.](#)

Puzzled by something? Please check the [Frequently Asked Questions](#) list.

Send queries about the **WWW interface** to Dean Pentcheff at dean2@biol.sc.edu.

Send queries about the **XTide program** to [David Flater](#) at software@flaterco.com.

WWW Tide/Current Predictor: <http://tbone.biol.sc.edu/tide>
Dean Pentcheff, <dean2@biol.sc.edu>

[Biological Sciences](#), [University of South Carolina](#), Columbia SC 29208 USA

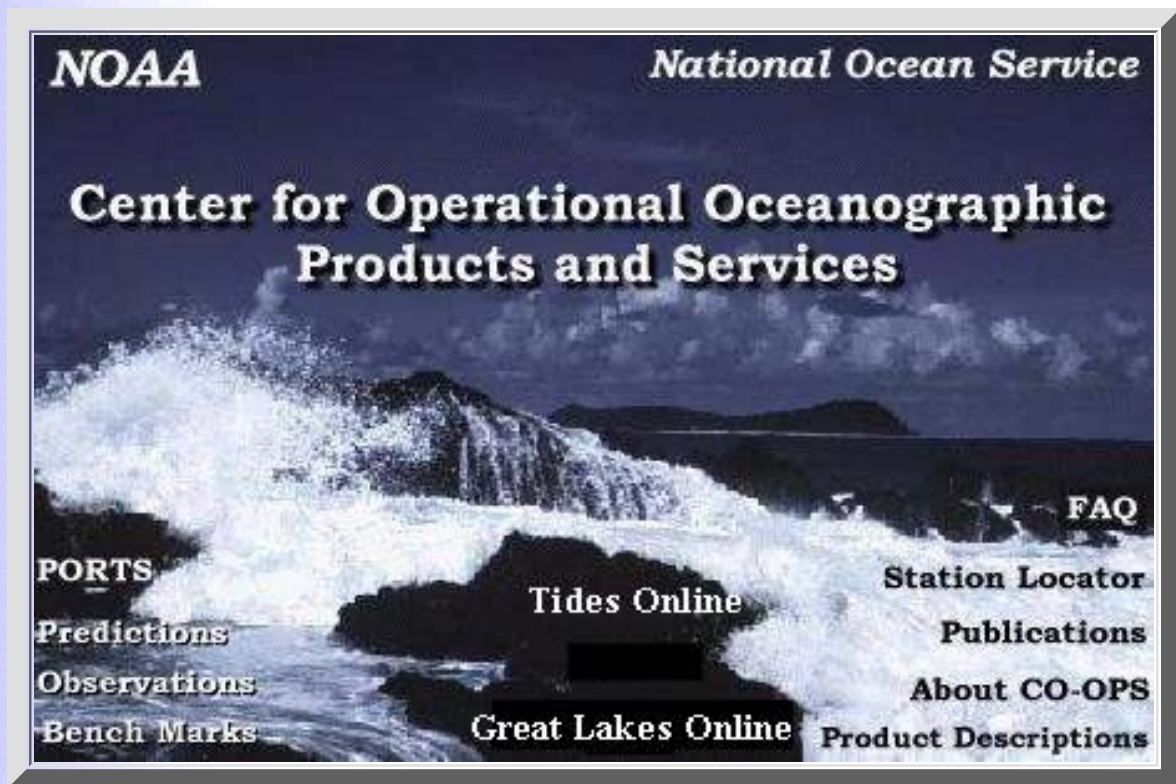

[\[NOAA\]](#) [\[NOS\]](#) [\[PORTS\]](#) [\[Predictions\]](#) [\[Water Level Observations\]](#) [\[Benchmarks\]](#) [\[Tides Online\]](#) [\[Great Lakes Online\]](#)
[\[Frequently Asked Questions\]](#) [\[Station Locator\]](#) [\[Publications\]](#) [\[About CO-OPS\]](#) [\[Products\]](#)

New Features:

[Sea Level Trends](#)

[St. Charles Parish Water Level Monitoring System](#)

[Air Gap](#)- NOAA and the Maryland Port Administration are pleased to introduce two new sensors located on the [Chesapeake City](#) and [Reedy Point](#) bridges to measure air gap. Air gap is the distance between the bottom of the bridge and the water surface.

Important Notice:

CO-OPS has updated to a new National Tidal Datum Epoch (1983-2001). For more information click [HERE](#)

The Center for Operational Oceanographic Products and Services (CO-OPS) collects, analyzes and distributes historical and real-time observations and predictions of water levels, coastal currents and other meteorological and oceanographic data. This is part of an integrated National Ocean Service program

supporting [safe maritime navigation](#), more [productive water-borne commerce](#), and the needs of the [National Weather Service](#), coastal zone management, engineering and surveying communities. The Center manages the [National Water Level Observation Program](#) and the national network of [Physical Oceanographic Real-Time Systems](#) in major U.S. harbors. It conducts its programs through university, industry, Federal and State partnerships as appropriate. CO-OPS resides within [NOAA's National Ocean Service](#).

Other Featured CO-OPS Web Sites



<p>Important Notices Epoch Update info, database status, selected Notices to Mariners</p> <p>** Privacy Policy **</p>	<p>What's New</p>	<p>Product Descriptions data, services and information offered on and off line</p>
<p>CO-OPS address, phone numbers, location map, mission, personnel and organizational setting</p>	<p>Frequently Asked Questions</p>	<p>About water levels, tides & currents, their measurement, analysis and prediction</p>

[NOAA](#)

[NOS](#)

[PORTS](#)

[Predictions](#)

[Observations](#)

[Bench Marks](#)

[Station Locator](#)

[Publications](#)

[About CO-OPS](#)

[Product Info.](#)



Development of these pages continues. We welcome your comments and suggestions for new

features at: [Webmaster](#)



Hawaiian Volcano Observatory

Volcanic Hazards

When Lava Enters the Sea

Kilauea

Mauna Loa

Earthquakes

Other
Volcanoes

Volcanic
Hazards

▀ [Types](#)
▀ [Lava
Zones](#)

About HVO



"Two mighty agencies in collision. Two antagonist and gigantic forces in contact, and producing effects on a scale inconceivably grand!"

"The atmosphere in all directions was filled with ashes, spray, gases... while the burning lava, as it fell into the water, was shivered into millions of minute particles, and, being thrown back into the air, fell in showers of sand on all the surrounding country. The coast was extended into the sea... and a pretty sand-beach and a new cape was formed."

T. Coan, minister in Hawai'i, 1841

Explosions and collapsing land endanger people

Such vivid descriptions and scenes of lava entering the sea along Kilauea's shoreline draw millions of people to Hawai'i who are hoping to witness for themselves growth of new land and experience the remarkable interaction of lava and water. Beautiful and stunning, the explosive interaction can be dangerous to visitors who venture too close to a lava entry point. Also, the new land created by lava entering the sea is unstable. Large areas regularly collapse into the sea, usually triggering a series of stronger explosions and sending a wave of scalding seawater onshore. Such explosions have hurled hot rocks and lava fragments more than 100 m (330 ft) inland!

Unfortunately, the entry of lava into the ocean is difficult to observe from a distance because it's often obscured by an energetic and acidic steam plume or by an abrupt cliff above the entry point. This often invites visitors to jeopardize their safety by walking right up to and over the point where lava enters the ocean. Activity that may appear stable and non-threatening can actually change without warning, leaving no time for escape.



Photograph by T.N Mattox on September 23, 1993.

Lava entering the ocean is often hidden beneath a steam plume, which may draw unwary visitors too close to the entry point for safety.

Why are lava entries so dangerous?

New land created by lava entering the sea looks like a stable platform that extends a few tens to hundreds of meters into the ocean. We refer to this new land as a lava delta. But what can't be seen is the loose pile of unconsolidated lava fragments underneath that supports the new land. This pile of material can easily slide away when the growing delta advances over a steep submarine slope. Areas the size of several football fields can collapse into the ocean with little or no warning.

People standing on a growing lava delta during a collapse event can be swept into the sea, splashed with scalding water, and hit by flying rock debris. Visitors to an active lava delta at Kilauea Volcano are advised not to venture onto the new land. Entry points can only be viewed safely from behind the former sea cliff and shoreline.

Hazardous activity near active lava deltas

- [Collapse of new land into the sea](#)
- [Explosions at lava entry points](#)
- [Waves send scalding water onto new land](#)

Reference

Mattox, T.N, and Mangan, M.T., 1997, Littoral hydrovolcanic explosions: a case study of lava-seawater interaction at Kilauea Volcano: *Journal of Volcanology and Geothermal Research*, v. 75, p. 1-17.

[Home](#)

[Volcano Watch](#)

[Products](#)

[Photo Gallery](#)

[Press Releases](#)

[How Hawaiian Volcanoes Work](#)

The URL of this page is <http://wwwhvo.wr.usgs.gov/hazards/oceanentry/>

Contact: hvowebmaster@usgs.gov

Updated: 18 June 2001 (pnf)



The MacTutor History of Mathematics archive

[Biographies Index](#)

[History Topics Index](#)

[Famous curves index](#)

[Mathematicians of the day](#)

[Search the archive](#)

[Help](#)

[Contact us](#)

Recently added features

[Changes to the archive to MARCH 2004](#)

(including some new Hungarian and Latvian mathematicians)

[A new archive of Chinese mathematics](#)

[School of Mathematics
and Statistics](#)

[University of St Andrews
Scotland](#)



If the above menus do not work, go to the [Non-JavaScript index](#)

**Awards won by the
MacTutor History
of Mathematics archive:**

See our [Trophy Room](#) for more details.

JOC/EFR April 2004

Created by [John J O'Connor](#) and [Edmund F Robertson](#)

The URL of this page is:

<http://www-history.mcs.st-and.ac.uk/history/index.html>

Yes, it's true... Reeko's done it again.... His latest experimentation has left the lab in ruins... This time the government radiation team has indicated that the damage is far too great to repair and suggested a move to another location (in fact, they suggested a remote location such as Siberia...).

Reeko and the crew set out on a mission to find a lab that was bigger, better, and faster than before. And now we proudly present to you our new home, featuring more experiments, more interactive games, and less sugar than the previous version. Step right this way and discover for yourself how fun (and wacky) science can be...

[Visit our new home here - http://www.spartechsoftware.com/reeko](http://www.spartechsoftware.com/reeko)

Reeko's Mad Scientist Lab

Welcome

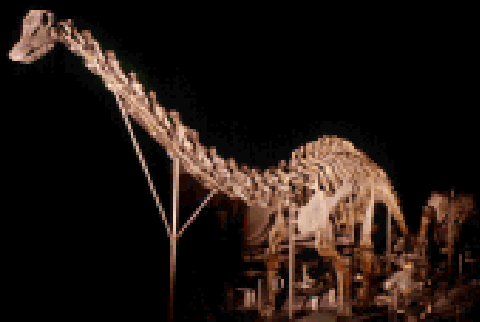

Is this Reeko? Reeko? You feeling OK buddy?

Welcome to **Reeko's Mad Scientist Lab**. Your source of free science experiments for parents, teachers, and children of all ages. Kick off your shoes. Pull up a chair. Make yourself comfortable. Oh yeah, did we mention that protective goggles *are* required...

Got a question or comment about our science lab? [Email Reeko](#) and let him know what's on your mind!



Welcome!

Welcome to Reeko's Mad Scientist Lab! Your source of science and chemistry experiments for parents, teachers, kids, and children of all ages.

As you'll soon find out - nothing is ordinary around here. Be curious, explore (place your cursor over objects and click everywhere), and above all - HAVE FUN!

In the Lab

[IN THE LAB HOME...](#)

[About Reeko](#)

[FAQ](#)

[Safety Policy](#)

[Site Awards](#)

Resources

[RESOURCES HOME...](#)

[Book Reviews](#)

[Science Links](#)

[Lab News](#)

[Crazy Q&A](#)



Principles of Floatation (easy)

Ever wonder why a really heavy boat floats while a small rock sinks like a... uhhh, rock? Have you noticed that while in the pool, if you stretch out flat you will float but if you curl up in a ball you will sink? Grab your lab coats and head for the kitchen sink - [our first science experiment](#) demonstrates those puzzling floatation principles.



Slip sliding away... (advanced)

How would you like to have your very own hovercraft. You know - the futuristic vehicle that travels on air hovering inches above the ground. We'll grab your coats and head for the door. In this lab exercise we're fixing to [create a real, working hovercraft](#) ... OK, so it's only big enough for a mouse but then again, you don't have a *driver's license* so what'd you expect?

Capillary Action in Action (intermediate)

[Glossary](#)

[Talk Back](#)

[TALK BACK HOME...](#)

[Feedback](#)

[Web Site Survey](#)

[Mad Scientist Comments](#)

[Fun Stuff](#)

[FUN&GAMES HOME...](#)

[Pot of Gold Contest](#)

[Mystery Puzzle](#)

[Riddle of the Month](#)

[Secret Lab Notes](#)

[Pop Quiz](#)

[Experiments](#)

[EXPERIMENTS...](#)

[Floatation](#)

[Hover Craft](#)

[Capillary Action](#)

[Air Pressure](#)

[Making Gas](#)

[Chemical Reaction](#)

[Light Refraction](#)

[Light Spectrum](#)

[Gravity](#)

[Inertia/Momentum](#)

[More Experiments...](#)

[Site Tips](#)

 Site is optimized for [Microsoft's Internet Explorer 4.0 and later](#) and contains extensive use of Dynamic HTML (Netscape optimization under development)

 Hold your cursor *over the images* for little tidbits on Reeko

 Look for [hidden science tips](#) throughout the site (try *clicking on the images*)

 IE 4.0 and above users - Click on the red text- they're science definitions!

 Keep hands and feet inside the vehicle at all times

Got a question or comment about one of the experiments? Have you found a really cool experiment that you'd like to share with the rest of the world? Or, do you just want

What if I were to tell you that I could make water flow uphill? Now wait, don't leave yet - this is serious. This lab experiment will show you that [what goes up doesn't always have to come back down](#).



[Chemical reaction in action](#) (easy)

A chemical reaction is a process where one type of substance is chemically converted to another substance. That fizzling toilet bowl cleaner is a chemical reaction. The fire in your fireplace is another type of chemical reaction. The *smoke* that comes out of Dad's ears when you break one of his favorite golf clubs is a result of a chemical reaction. OK, so maybe Reeko's stretching it a little with that explanation. [This experiment](#) demonstrates a chemical reaction that's fairly common all around us (and we don't have to go anywhere near Dad's golf clubs).

[Look Ma' - no hands](#) (intermediate)

Remember the old soda-in-the-straw trick. You know, the one where you put a straw into a glass of soda and then cover the end of the straw with your finger. When you remove the straw from the glass the water stays inside until you remove your finger. [In this little scientist experiment](#) we apply this same principal to learn about something called *pressure*.



[Look out! It's gonna blow!](#) (advanced)

Here's a popular experiment that's been around for years and has left many kitchens in ruin (just kidding of course). In the volcano experiment we [build a real working volcano](#) that actually mimics the properties of the real thing.

[Things aren't always as they appear](#) (easy)

Dazzle your friends. Impress your buddies. Confuse your Dad. Here we [create an optical illusion](#) with a very basic scientific explanation.

to yak? Drop us a line!
reeko@spartechsoftware.com



More Info

Looking for more experiments? Check your local library (in the kid's or science sections) for great science books. Need some suggestions? Try these.

 [The Kid's Science Book](#)
(Robert Hirschfeld & Nancy White)

 [My First Science Book](#)
(Angela Wilkes)

 [The Science Book](#) (Sara Stein)

 [Science for Every Kid](#)
(Janice VanCleave)

What? There's not a library next door and don't feel like walking 10 miles through the sleet and snow (barefoot of course). Check out [Reeko's Book Reviews](#) and order online directly from Amazon.

And don't forget to tell them that Reeko sent ya'.

Try some of these other really cool science sites and don't forget to tell them that Reeko sent ya'! (note: to avoid being turned away, you may not want to mention Reeko's name until you're *finished* exploring these sites).

 [Franklin Institute Science Museum](#)

 [The Mineral Gallery](#)

 [WorldTime Interactive Atlas](#)

 [Space Shuttle](#)

And if these still don't quench that insatiable curiosity then check out [Reeko's Extensive Science Link List](#).



Look out below! (intermediate)

Let's say I'm standing on top of a tall building hanging over the edge carefully balancing a bowling ball in one hand and a tennis ball in the other. You're on the ground under me looking up (and probably covering your head). Hmmm, something is not quite right here and [some scientific experimentation](#) is definitely called for...

Now that you're good and warmed up with plenty of momentum... (advanced)

Now we get to learn about a little principle called momentum (the speed or force of something that is moving). Sometimes interesting things happen when a totally motionless object gets in the way of a moving one. To demonstrate - the next time dad finds out you've been in his toolbox again and he's coming at you with that crazed look on his face. Rather than running, flinching, or ducking in terror try freezing like a statue and see how it freaks him out. Or better yet, [try this experiment](#) and see for yourself.

Pop Quiz !!!

Did you work your way through all of the experiments? Did you find all of the hidden tips and science facts? Take our [Pop Quiz](#) and find out how 'science savvy' you are. And we promise, no matter how you score - we won't send Mom or Dad a report card.

What? You're still here?

That wasn't enough cranial stimulation for one session? You need more experiments?!?! OK... You asked for it - [through this door](#) you can enter the top secret, select little scientists only section of Reeko's Mad Scientist Lab (Section F).

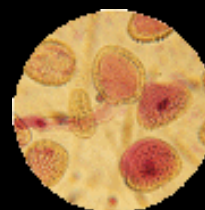

Do Cats have belly buttons? NEW!

Hey Reeko! I tried the experiment and it *didn't* work! Now what am I supposed to do ?!?!? Follow these [Five tried-and-true rules](#) for guaranteeing a experiment will produce the results you are looking for.

Don't forget to [Email Reeko](#) with your questions, comments, and/or suggestions. And check out [what others have said about us](#) (edited of course).

What is quicksand anyway? How come I can see through glass? Do LifeSavers really spark when you chew them? Chimp, the lab monkey, is back and available to answer all those [weird science questions](#) that have been driving us crazy...

Did you find a hidden Pot of Gold?

Reeko has been receiving rave reviews on the new [Pot of Gold contest](#) so he tore himself away from his latest genetic experimentation and sprinkled more pots of gold around the lab! Join us on our search for the hidden Pots of Gold and get your name added to the [Pot of Gold Hall of Fame](#) page!

Mystery Puzzle of the Month!

The results of Reeko's latest science escapades left him with a little free time on his hands. So while the government radiation teams worked on the lab cleanup, Reeko settled down to work on his newest online game for the kids. The result - the [Mystery Puzzle of the Month game](#). Get ready to roam this site gathering the clues needed to solve this month's puzzle...



[Home](#) | [In the Lab](#) | [Resources](#) | [Talk Back](#) | [Fun Stuff](#) | [Experiments](#) | [Glossary](#)

Web page design by [SparTech Software](#), copyright 1997-2004

Reeko's Science Word for the Day is - [LED Light](#)

176 144 little scientists have stumbled across this page...

Last Update: Monday, March 15, 2004 09:47:23 AM

 **SIGN UP NOW**
ONLY \$26.95 A MONTH WHEN ORDERED ONLINE.

Secret Message Below (Decoder) (Instructions)

JUT'Z LUXMKZ ZU QKKV GT KEK UAZ LUX ZNK LURRUCOTM OZKSY - VUZY
UL MURJ, VAFFRK VOKIKY (ZNKE RUUQ ROQK YCOYY GXSE QTQBKY), GTJ
UL IUAXYK YKIXKZ SKYYGMKY...

Conflicts Between Darwinian Theory and Natural History

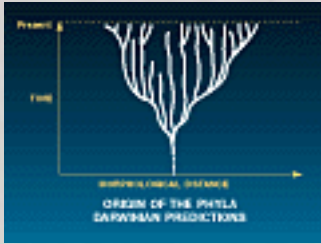

FIG O: Origin of the Phyla: Darwinian predictions

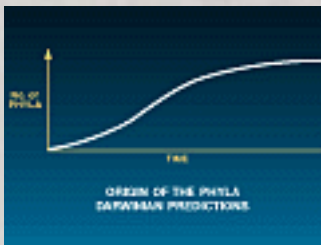

FIG P: Origin of the Phyla: Darwinian predictions

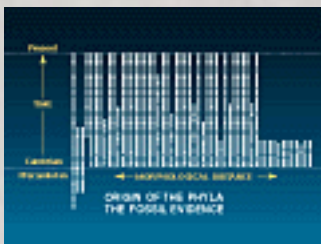

FIG Q: The origin of the phyla: the fossil evidence

The sudden appearance of between 50 and 100 disparate body plans with extremely low species diversity supports the conclusion that neither gradual Darwinian evolution nor lower taxon-level punctuations can account for the origin of the higher taxa and the major body plans.

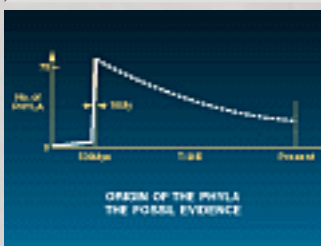

FIG R: The origin of the phyla: the fossil evidence

The sudden appearance of between 50 and 100 disparate body plans with extremely low species diversity supports the conclusion that neither gradual Darwinian evolution nor lower taxon-level

punctuations can account for the origin of the higher taxa and the major body plans.



FIG 2A: Pervasive patterns of natural history and the origin of the phyla. Comparison of Darwinian predictions (including punctuated equilibrium)with the fossil data.

See also FIGURES O and Q above.

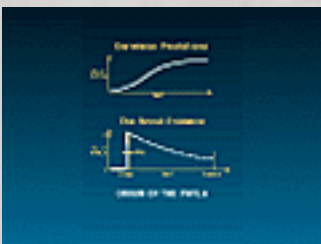

FIG 2B: Pervasive patterns of natural history and the origin of the phyla. Comparison of Darwinian predictions (including punctuated equilibrium)with the fossil data.

See also FIGURES P and R above.

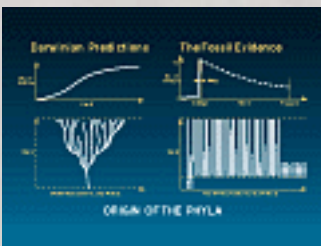

FIG 4: Pervasive patterns of natural history and the origin of the phyla. Composite comparison of Darwinian predictions (including punctuated equilibrium)with the fossil data.

[Return to Home Page](#)

MOLECULAR MACHINES:

Experimental Support for the Design Inference

Michael J. Behe

A Series of Eyes

How do we see? In the 19th century the anatomy of the eye was known in great detail and the sophisticated mechanisms it employs to deliver an accurate picture of the outside world astounded everyone who was familiar with them. Scientists of the 19th century correctly observed that if a person were so unfortunate as to be missing one of the eye's many integrated features, such as the lens, or iris, or ocular muscles, the inevitable result would be a severe loss of vision or outright blindness. Thus it was concluded that the eye could only function if it were nearly intact.

As Charles Darwin was considering possible objections to his theory of evolution by natural selection in *The Origin of Species* he discussed the problem of the eye in a section of the book appropriately entitled "Organs of Extreme Perfection and Complication." He realized that if in one generation an organ of the complexity of the eye suddenly appeared, the event would be tantamount to a miracle. Somehow, for Darwinian evolution to be believable, the difficulty that the public had in envisioning the gradual formation of complex organs had to be removed.

Darwin succeeded brilliantly, not by actually describing a real pathway that evolution might have used in constructing the eye, but rather by pointing to a variety of animals that were known to have eyes of various constructions, ranging from a simple light sensitive spot to the complex vertebrate camera eye, and suggesting that the evolution of the human eye might have involved similar organs as intermediates.

But the question remains, how do we see? Although Darwin was able to persuade much of the world that a modern eye could be produced gradually from a much simpler structure, he did not even attempt to explain how the simple light sensitive spot that was his starting point actually worked. When discussing the eye Darwin dismissed the question of its ultimate mechanism (1):

How a nerve comes to be sensitive to light hardly concerns us more than how life itself originated.

He had an excellent reason for declining to answer the question: 19th century science had

not progressed to the point where the matter could even be approached. The question of how the eye works--that is, what happens when a photon of light first impinges on the retina--simply could not be answered at that time. As a matter of fact, no question about the underlying mechanism of life could be answered at that time. How do animal muscles cause movement? How does photosynthesis work? How is energy extracted from food? How does the body fight infection? Nobody knew.

Calvinism

Now, it appears to be a characteristic of the human mind that when it is unconstrained by knowledge of the mechanisms of a process, then it seems easy to imagine simple steps leading from non-function to function. A happy example of this is seen in the popular comic strip Calvin and Hobbes. Little boy Calvin is always having adventures in the company of his tiger Hobbes by jumping in a box and traveling back in time, or grabbing a toy ray gun and "transmogrifying" himself into various animal shapes, or again using a box as a duplicator and making copies of himself to deal with worldly powers such as his mom and his teachers. A small child such as Calvin finds it easy to imagine that a box just might be able to fly like an airplane (or something), because Calvin does not know how airplanes work.

A good example from the biological world of complex changes appearing to be simple is the belief in spontaneous generation. One of the chief proponents of the theory of spontaneous generation during the middle of the 19th century was Ernst Haeckel, a great admirer of Darwin and an eager popularizer of Darwin's theory. From the limited view of cells that 19th century microscopes provided, Haeckel believed that a cell was a "simple little lump of albuminous combination of carbon," (2) not much different from a piece of microscopic Jello. Thus it seemed to Haeckel that such simple life could easily be produced from inanimate material. In 1859, the year of the publication of *The Origin of Species*, an exploratory vessel, H.M.S. Cyclops, dredged up some curious looking mud from the sea bottom. Eventually Haeckel came to observe the mud and thought that it closely resembled some cells he had seen under a microscope. Excitedly he brought this to the attention of Thomas Henry Huxley, Darwin's great friend and defender. Huxley, too, became convinced that it was *Urschleim* (that is, protoplasm), the progenitor of life itself, and Huxley named the mud *Bathybius Haeckelii* after the eminent proponent of abiogenesis.

The mud failed to grow. In later years, with the development of new biochemical techniques and improved microscopes, the complexity of the cell was revealed. The "simple lumps" were shown to contain thousands of different types of organic molecules, proteins, and nucleic acids, many discrete subcellular structures, specialized compartments for specialized processes, and an extremely complicated architecture. Looking back from the perspective of our time, the episode of *Bathybius Haeckelii* seems silly or downright embarrassing, but it shouldn't. Haeckel and Huxley were behaving naturally, like Calvin: since they were unaware of the complexity of cells, they found it easy to believe that cells could originate from simple mud.

Throughout history there have been many other examples, similar to that of Haeckel, Huxley and the cell, where a key piece of a particular scientific puzzle was beyond the understanding of the age. In science there is even a whimsical term for a machine or structure or

process that does something, but the actual mechanism by which it accomplishes its task is unknown: it is called a 'black box.' In Darwin's time all of biology was a black box: not only the cell, or the eye, or digestion, or immunity, but every biological structure and function because, ultimately, no one could explain how biological processes occurred.

Ernst Mayr, the prominent biologist, historian, and guiding force behind the neo-Darwinian synthesis, has pointed out that (3):

Any scientific revolution has to accept all sorts of black boxes, for if one had to wait until all black boxes are opened, one would never have any conceptual advances.

That is true. But in earlier days when black boxes were finally opened science, and sometimes the whole world, appeared to change. Biology has progressed tremendously due to the model that Darwin put forth. But the black boxes Darwin accepted are now being opened, and our view of the world is again being shaken.

Proteins

In order to understand the molecular basis of life it is necessary to understand how things called "proteins" work. Although most people think of protein" as something you eat, one of the major food groups, when they reside in the body of an uneaten animal or plant proteins serve a different purpose. Proteins are the machinery of living tissue that builds the structures and carries out the chemical reactions necessary for life. For example, the first of many steps necessary for the conversion of sugar to biologically-usable forms of energy is carried out by a protein called hexokinase. Skin is made in large measure of a protein called collagen. When light impinges on your retina it interacts first with a protein called rhodopsin. As can be seen even by this limited number of examples proteins carry out amazingly diverse functions. However, in general a given protein can perform only one or a few functions: rhodopsin cannot form skin and collagen cannot interact usefully with light. Therefore a typical cell contains thousands and thousands of different types of proteins to perform the many tasks necessary for life, much like a carpenter's workshop might contain many different kinds of tools for various carpentry work.

What do these versatile tools look like? The basic structure of proteins is quite simple: they are formed by hooking together in a chain discrete subunits called amino acids. Although the protein chain can consist of anywhere from about 50 to about 1,000 amino acid links, each position can only contain one of twenty different amino acids. In this way they are much like words: words can come in various lengths but they are made up from a discrete set of 26 letters. Now, a protein in a cell does not float around like a floppy chain; rather, it folds up into a very precise structure which can be quite different for different types of proteins. When all is said and done two different amino sequences--two different proteins--can be folded to structures as specific as and different from each other as a three-eighths inch wrench and a jigsaw. And like the household tools, if the shape of the proteins is significantly warped then they fail to do their jobs.

The Eyesight of Man

In general, biological processes on the molecular level are performed by networks of proteins, each member of which carries out a particular task in a chain.

Let us return to the question, how do we see? Although to Darwin the primary event of vision was a black box, through the efforts of many biochemists an answer to the question of sight is at hand. (4) When light strikes the retina a photon is absorbed by an organic molecule called 11-*cis*-retinal, causing it to rearrange within picoseconds to *trans*-retinal. The change in shape of retinal forces a corresponding change in shape of the protein, rhodopsin, to which it is tightly bound. As a consequence of the protein's metamorphosis, the behavior of the protein changes in a very specific way. The altered protein can now interact with another protein called transducin. Before associating with rhodopsin, transducin is tightly bound to a small organic molecule called GDP, but when it binds to rhodopsin the GDP dissociates itself from transducin and a molecule called GTP, which is closely related to, but critically different from, GDP, binds to transducin.

The exchange of GTP for GDP in the transducinrhodopsin complex alters its behavior. GTP-transducinrhodopsin binds to a protein called phosphodiesterase, located in the inner membrane of the cell. When bound by rhodopsin and its entourage, the phosphodiesterase acquires the ability to chemically cleave a molecule called cGMP. Initially there are a lot of cGMP molecules in the cell, but the action of the phosphodiesterase lowers the concentration of cGMP. Activating the phosphodiesterase can be likened to pulling the plug in a bathtub, lowering the level of water.

A second membrane protein which binds cGMP, called an ion channel, can be thought of as a special gateway regulating the number of sodium ions in the cell. The ion channel normally allows sodium ions to flow into the cell, while a separate protein actively pumps them out again. The dual action of the ion channel and pump proteins keeps the level of sodium ions in the cell within a narrow range. When the concentration of cGMP is reduced from its normal value through cleavage by the phosphodiesterase, many channels close, resulting in a reduced cellular concentration of positively charged sodium ions. This causes an imbalance of charges across the cell membrane which, finally, causes a current to be transmitted down the optic nerve to the brain: the result, when interpreted by the brain, is vision.

If the biochemistry of vision were limited to the reactions listed above, the cell would quickly deplete its supply of 11-*cis*-retinal and cGMP while also becoming depleted of sodium ions. Thus a system is required to limit the signal that is generated and restore the cell to its original state; there are several mechanisms which do this. Normally, in the dark, the ion channel, in addition to sodium ions, also allows calcium ions to enter the cell; calcium is pumped back out by a different protein in order to maintain a constant intracellular calcium concentration. However, when cGMP levels fall, shutting down the ion channel and decreasing the sodium ion concentration, calcium ion concentration is also decreased. The phosphodiesterase enzyme, which destroys cGMP, is greatly slowed down at lower calcium concentration. Additionally, a protein called guanylate cyclase begins to resynthesize cGMP when calcium levels start to fall.

Meanwhile, while all of this is going on, metarhodopsin II is chemically modified by an enzyme called rhodopsin kinase, which places a phosphate group on its substrate. The modified rhodopsin is then bound by a protein dubbed arrestin, which prevents the rhodopsin from further activating transducin. Thus the cell contains mechanisms to limit the amplified signal started by a single photon.

Trans-retinal eventually falls off of the rhodopsin molecule and must be reconverted to 11-*cis*-retinal and again bound by opsin to regenerate rhodopsin for another visual cycle. To accomplish this *trans*-retinal is first chemically modified by an enzyme to transretinol, a form containing two more hydrogen atoms. A second enzyme then isomerizes the molecule to 11-*cis*-retinol. Finally, a third enzyme removes the previously added hydrogen atoms to form 11-*cis*-retinal, and the cycle is complete.

To Explain Life

Although many details of the biochemistry of vision have not been cited here, the overview just given is meant to demonstrate that, ultimately, *this is* what it means to 'explain' vision. This is the level of explanation that Biological science eventually must aim for. In order to say that some function is understood, every relevant step in the process must be elucidated. The relevant steps in biological processes occur ultimately at the molecular level, so a satisfactory explanation of a biological phenomenon such as sight, or digestion, or immunity, must include a molecular explanation. It is no longer sufficient, now that the black box of vision has been opened, for an 'evolutionary explanation' of that power to invoke only the anatomical structures of whole eyes, as Darwin did in the 19th century and as most popularizers of evolution continue to do today. Anatomy is, quite simply, irrelevant. So is the fossil record. It does not matter whether or not the fossil record is consistent with evolutionary theory, any more than it mattered in physics that Newton's theory was consistent with everyday experience. The fossil record has nothing to tell us about, say, whether or how the interactions of 11-*cis*-retinal with rhodopsin, transducin, and phosphodiesterase could have developed step-by-step. Neither do the patterns of biogeography matter, or of population genetics, or the explanations that evolutionary theory has given for rudimentary organs or species abundance.

"How a nerve comes to be sensitive to light hardly concerns us more than how life itself originated," said Darwin in the 19th century. But both phenomena have attracted the interest of modern biochemistry. The story of the slow paralysis of research on life's origin is quite interesting, but space precludes its retelling here. Suffice it to say that at present the field of origin-of-life studies has dissolved into a cacophony of conflicting models, each unconvincing, seriously incomplete, and incompatible with competing models. In private even most evolutionary biologists will admit that science has no explanation for the beginning of life. (5)

The purpose of this paper is to show that the same problems which beset origin-of-life research also bedevil efforts to show how virtually any complex biochemical system came about. Biochemistry has revealed a molecular world which stoutly resists explanation by the same theory that has long been applied at the level of the whole organism. Neither of Darwin's black boxes--the

origin of life or the origin of vision or other complex biochemical systems--has been accounted for by his theory.

Irreducible Complexity

In *The Origin of Species* Darwin stated (6):

If it could be demonstrated that any complex organ existed which could not possibly have been formed by numerous, successive, slight modifications, my theory would absolutely break down.

A system which meets Darwin's criterion is one which exhibits *irreducible complexity*. By irreducible complexity I mean a single system which is composed of several interacting parts that contribute to the basic function, and where the removal of any one of the parts causes the system to effectively cease functioning. An irreducibly complex system cannot be produced gradually by slight, successive modifications of a precursor system, since any precursor to an irreducibly complex system is by definition nonfunctional. Since natural selection requires a function to select, an irreducibly complex biological system, if there is such a thing, would have to arise as an integrated unit for natural selection to have anything to act on. It is almost universally conceded that such a sudden event would be irreconcilable with the gradualism Darwin envisioned. At this point, however, 'irreducibly complex' is just a term, whose power resides mostly in its definition. We must now ask if any real thing is in fact irreducibly complex, and, if so, then are any irreducibly complex things also biological systems.

Consider the humble mousetrap (Figure 1). The mousetraps that my family uses in our home to deal with unwelcome rodents consist of a number of parts. There are: (1) a flat wooden platform to act as a base; (2) a metal hammer, which does the actual job of crushing the little mouse; (3) a wire spring with extended ends to press against the platform and the hammer when the trap is charged; (4) a sensitive catch which releases when slight pressure is applied; and (5) a metal bar which holds the hammer back when the trap is charged and connects to the catch. There are also assorted staples and screws to hold the system together.

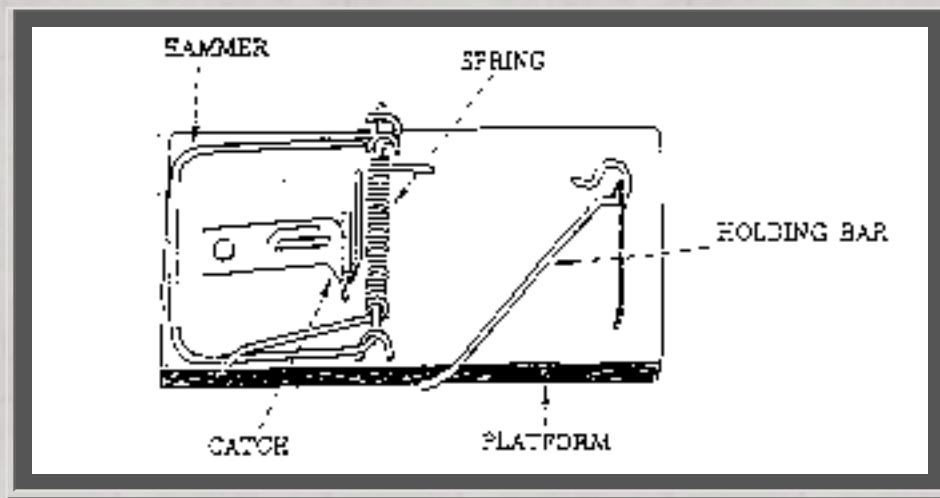

Figure 1. A household mousetrap. The working parts of the trap are labeled. If any of the parts are missing the trap does not function.

If any one of the components of the mousetrap (the base, hammer, spring, catch, or holding bar) is removed, then the trap does not function. In other words, the simple little mousetrap has no ability to trap a mouse until several separate parts are all assembled.

Because the mousetrap is necessarily composed of several parts, it is irreducibly complex. Thus, irreducibly complex systems exist.

Molecular Machines

Now, are any biochemical systems irreducibly complex? Yes, it turns out that many are.

Earlier we discussed proteins. In many biological structures proteins are simply components of larger molecular machines. Like the picture tube, wires, metal bolts and screws that comprise a television set, many proteins are part of structures that only function when virtually all of the components have been assembled. A good example of this is a cilium. (7) Cilia are hairlike organelles on the surfaces of many animal and lower plant cells that serve to move fluid over the cell's surface or to "row" single cells through a fluid. In humans, for example, epithelial cells lining the respiratory tract each have about 200 cilia that beat in synchrony to sweep mucus towards the throat for elimination. A cilium consists of a membrane-coated bundle of fibers called an axoneme. An axoneme contains a ring of 9 double microtubules surrounding two central single microtubules. Each outer doublet consists of a ring of 13 filaments (subfiber A) fused to an assembly of 10 filaments (subfiber B). The filaments of the microtubules are composed of two proteins called alpha and beta tubulin. The 11 microtubules forming an axoneme are held together by three types of connectors: subfibers A are joined to the central microtubules by radial spokes; adjacent outer doublets are joined by linkers that consist of a highly elastic protein called nexin; and the central microtubules are joined by a connecting bridge. Finally, every subfiber A bears two arms, an inner arm and an outer arm, both containing the protein dynein.

But how does a cilium work? Experiments have indicated that ciliary motion results from the chemically-powered "walking" of the dynein arms on one microtubule up the neighboring subfiber B of a second microtubule so that the two microtubules slide past each other (Figure 2). However, the protein cross-links between microtubules in an intact cilium prevent neighboring microtubules from sliding past each other by more than a short distance. These cross-links, therefore, convert the dynein-induced sliding motion to a bending motion of the entire axoneme.

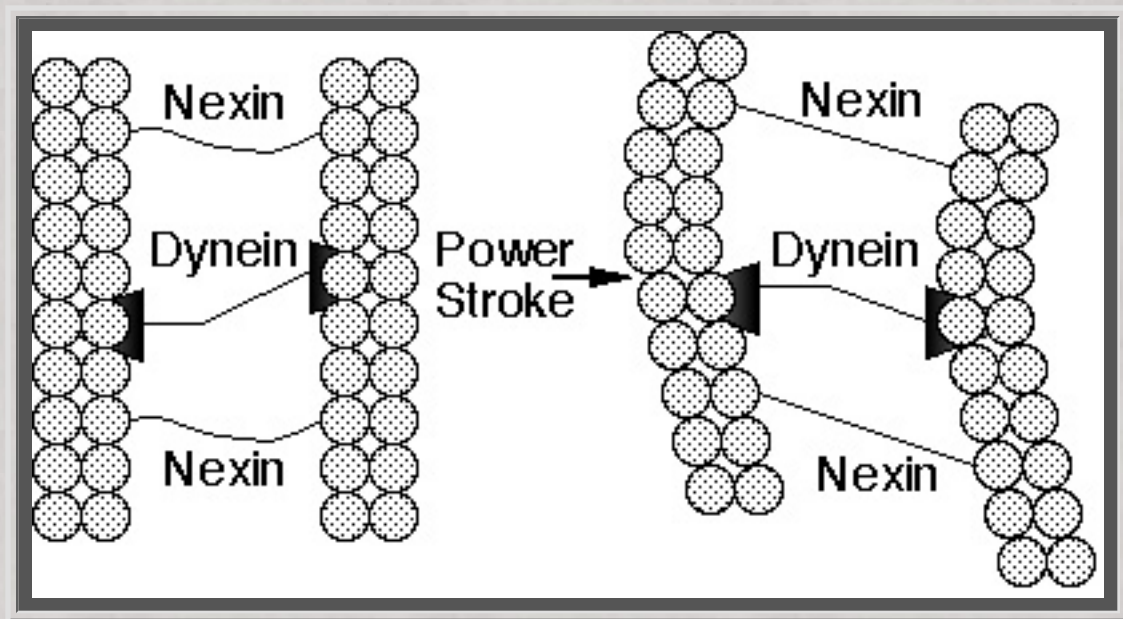

Figure 2. Schematic drawing of part of a cilium. The power stroke of the motor protein, dynein, attached to one microtubule, against subfiber B of a neighboring microtubule causes the fibers to slide past each other. The flexible linker protein, nexin, converts the sliding motion to a bending motion.

Now, let us sit back, review the workings of the cilium, and consider what it implies. Cilia are composed of at least a half dozen proteins: alpha-tubulin, beta-tubulin, dynein, nexin, spoke protein, and a central bridge protein. These combine to perform one task, ciliary motion, and all of these proteins must be present for the cilium to function. If the tubulins are absent, then there are no filaments to slide; if the dynein is missing, then the cilium remains rigid and motionless; if nexin or the other connecting proteins are missing, then the axoneme falls apart when the filaments slide.

What we see in the cilium, then, is not just profound complexity, but also irreducible complexity on the molecular scale. Recall that by "irreducible complexity" we mean an apparatus that requires several distinct components for the whole to work. My mousetrap **must** have a base, hammer, spring, catch, and holding bar, all working together, in order to function. Similarly, the cilium, as it is constituted, **must** have the sliding filaments, connecting proteins, and motor proteins for function to occur. In the absence of any one of those components, the apparatus is

useless.

The components of cilia are single molecules. This means that there are no more black boxes to invoke; the complexity of the cilium is final, fundamental. And just as scientists, when they began to learn the complexities of the cell, realized how silly it was to think that life arose spontaneously in a single step or a few steps from ocean mud, so too we now realize that the complex cilium can not be reached in a single step or a few steps. But since the complexity of the cilium is irreducible, then it can not have functional precursors. Since the irreducibly complex cilium can not have functional precursors it can not be produced by natural selection, which requires a continuum of function to work. Natural selection is powerless when there is no function to select. We can go further and say that, if the cilium can not be produced by natural selection, then the cilium was designed.

The Study of "Molecular Evolution"

Other examples of irreducible complexity abound, including aspects of protein transport, blood clotting, closed circular DNA, electron transport, the bacterial flagellum, telomeres, photosynthesis, transcription regulation, and much more. Examples of irreducible complexity can be found on virtually every page of a biochemistry textbook. But if these things cannot be explained by Darwinian evolution, how has the scientific community regarded these phenomena of the past forty years? A good place to look for an answer to that question is in the *Journal of Molecular Evolution*. *JME* is a journal that was begun specifically to deal with the topic of how evolution occurs on the molecular level. It has high scientific standards, and is edited by prominent figures in the field. In a recent issue of *JME* there were published eleven articles; of these, all eleven were concerned simply with the analysis of protein or DNA sequences. None of the papers discussed detailed models for intermediates in the development of complex biomolecular structures. In the past ten years *JME* has published 886 papers. Of these, 95 discussed the chemical synthesis of molecules thought to be necessary for the origin of life, 44 proposed mathematical models to improve sequence analysis, 20 concerned the evolutionary implications of current structures, and 719 were analyses of protein or polynucleotide sequences. There were zero papers discussing detailed models for intermediates in the development of complex biomolecular structures. This is not a peculiarity of *JME*. No papers are to be found that discuss detailed models for intermediates in the development of complex biomolecular structures in the *Proceedings of the National Academy of Science*, *Nature*, *Science*, the *Journal of Molecular Biology* or, to my knowledge, any journal whatsoever.

Sequence comparisons overwhelmingly dominate the literature of molecular evolution. But sequence comparisons simply can't account for the development of complex biochemical systems any more than Darwin's comparison of simple and complex eyes told him how vision worked. Thus in this area science is mute. This means that when we infer that complex biochemical systems were designed, we are contradicting no experimental result, we are in conflict with no theoretical study. No experiments needs to be questioned, but the interpretation of all experiments must now be reexamined, just as the results of experiments that were consistent with a Newtonian view of the universe had to be reinterpreted when the waveparticle duality of matter was discerned.

Conclusion

It is often said that science must avoid any conclusions which smack of the supernatural. But this seems to me to be both bad logic and bad science. Science is not a game in which arbitrary rules are used to decide what explanations are to be permitted. Rather, it is an effort to make true statements about physical reality. It was only about sixty years ago that the expansion of the universe was first observed. This fact immediately suggested a singular event--that at some time in the distant past the universe began expanding from an extremely small size. To many people this inference was loaded with overtones of a supernatural event--the creation, the beginning of the universe. The prominent physicist A.S. Eddington probably spoke for many physicists in voicing his disgust with such a notion (8):

Philosophically, the notion of an abrupt beginning to the present order of Nature is repugnant to me, as I think it must be to most; and even those who would welcome a proof of the intervention of a Creator will probably consider that a single winding-up at some remote epoch is not really the kind of relation between God and his world that brings satisfaction to the mind.

Nonetheless, the Big Bang hypothesis was embraced by physics and over the years has proven to be a very fruitful paradigm. The point here is that physics followed the data where it seemed to lead, even though some thought the model gave aid and comfort to religion. In the present day, as biochemistry multiplies examples of fantastically complex molecular systems, systems which discourage even an attempt to explain how they may have arisen, we should take a lesson from physics. The conclusion of design flows naturally from the data; we should not shrink from it; we should embrace it and build on it.

In concluding, it is important to realize that we are not inferring design from what we do not know, but from what we do know. We are not inferring design to account for a black box, but to account for an open box. A man from a primitive culture who sees an automobile might guess that it was powered by the wind or by an antelope hidden under the car, but when he opens up the hood and sees the engine he immediately realizes that it was designed. In the same way biochemistry has opened up the cell to examine what makes it run and we see that it, too, was designed.

It was a shock to people of the nineteenth century when they discovered, from observations science had made, that many features of the biological world could be ascribed to the elegant principle of natural selection. It is a shock to us in the twentieth century to discover, from observations science has made, that the fundamental mechanisms of life cannot be ascribed to natural selection, and therefore were designed. But we must deal with our shock as best we can and go on. The theory of undirected evolution is already dead, but the work of science continues.

This paper was originally presented in the Summer of 1994 at the meeting of the C.S. Lewis Society, Cambridge University.

REFERENCES:

- (1) Darwin, Charles (1872) *Origin of Species* 6th ed (1988), p.151, New York University Press, New York.
- (2) Farley, John (1979) *The Spontaneous Generation Controversy from Descartes to Oparin*, 2nd ed, p.73, The Johns Hopkins University Press, Baltimore.
- (3) Mayr, Ernst (1991) *One Long Argument*, p. 146, Harvard University Press, Cambridge.
- (4) Devlin, Thomas M. (1992) *Textbook of Biochemistry*, pp.938954, WileyLiss, New York.
- (5) University of Washington rhetorician John Angus Campbell has observed that "huge edifices of ideas such as positivism never really die. Thinking people gradually abandon them and even ridicule them among themselves, but keep the persuasively useful parts to scare away the uninformed." "The Comic Frame and the Rhetoric of Science: Epistemology and Ethics in Darwin's Origin," *Rhetoric Society Quarterly* 24, pp.2750 (1994). This certainly applies to the way the scientific community handles questions on the origin of life.
- (6) Darwin, p.154.
- (7) Voet, D. & Voet, J.G. (1990) *Biochemistry*, pp.11321139, John Wiley & Sons, New York.
- (8) Cited in Jaki, Stanley L. (1980) *Cosmos and Creator*, pp.56, Gateway Editions, Chicago.

Mike Behe received a Bachelor of Science degree in Chemistry from Drexel University in 1974 and the Ph.D. in Biochemistry from the University of Pennsylvania in 1978.

After doing postdoctoral work at the National institutes of Health he became assistant professor of Chemistry at the City University of New York/Queens College.

In 1985 he moved to Lehigh University in Bethlehem, PA, where he is currently Associate Professor in the Department of Biological Sciences.

Mike is married to the former Celeste LaTassa. They are members of St. Theresa Parish in Hellertown, PA, where they are raising their six children: Grace, age 10; Benedict, 9; Clare, 7; Leo, 5; Rose, 3; and Vincent, 1.

Look for Dr. Behe's new book published by the Free Press, *Darwin's Black Box: The Biochemical Challenge to Evolution*.

Chaparral and Fire

The California chaparral is a plant community composed of small shrubs and bushes that are adapted to fire. You can see the chaparral in the coastal mountains around San Diego, Los Angeles, Santa Barbara, San Luis Obispo, San Jose and other locations in the Coast Ranges, and also in the foothills of the Sierra Nevada and Klamath Mountains. The chaparral consists of tall bushes and small trees with dark green leaves. Most of the plants are less than ten feet high. When we say that plants are adapted to fire, we mean that the plants actually need fire as part of their lives, and that the plant species could die out if fire didn't occur. Sounds a little strange, doesn't it? Why would plants have anything to do with fire?

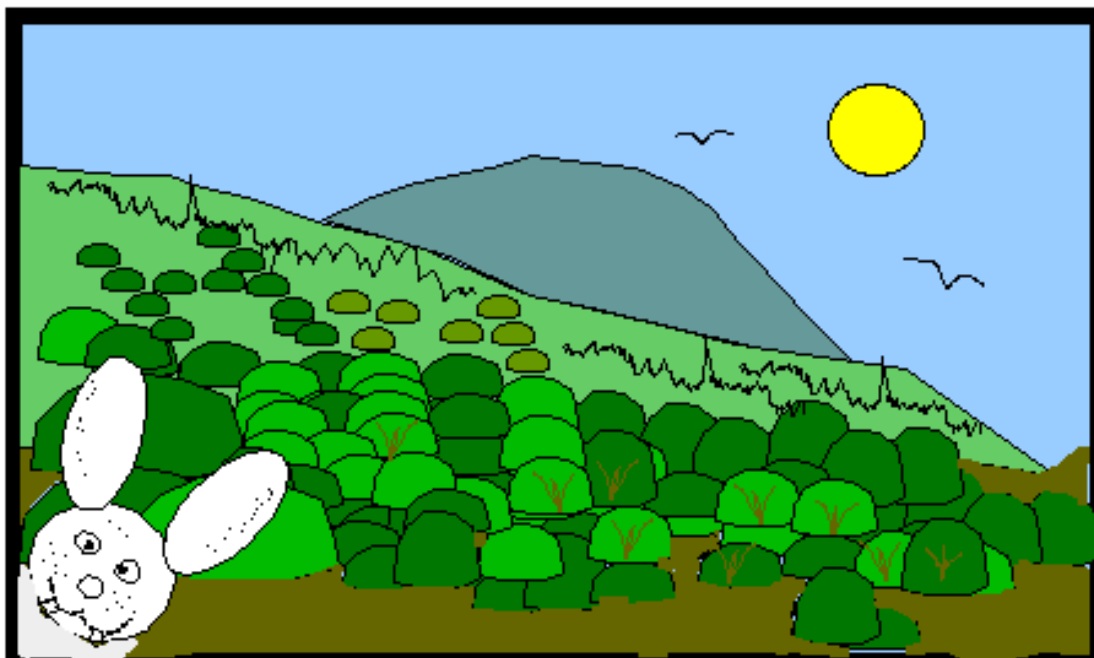

A couple of sprigs of chaparral plants are shown below. These are of **Manzanita** (or 'little apple' in Spanish because of the appearance of the fruit, which is not a true apple), **California Lilac** (Ceanothus) which has beautiful blue, white, or lilac blossoms in the early Spring, **Chamise** which has tiny white masses of flowers on the ends of its branches of tiny green leaves, and **Toyon** (or Christmas Holly, named because of the red berries that grow on the small tree around Christmas time---it is the Holly in Hollywood).

Welcome

[About CNPS](#)
[Membership](#)
[Native Plants?](#)
[Fun Activities](#)
[Great Ideas](#)

Action Alerts

Discussions

CNPS Inventory On-line

CNPS Manual of California Vegetation On-line

Programs, Etc.

[Conservation](#)
[Legislation](#)
[Newhall](#)
[NCCP-HCPs](#)
[UC Merced](#)
[Education](#)
[Plant Science](#)
[Local Flora](#)
[Rare Plants](#)
[Vegetation](#)
[Photography](#)
[Publications](#)
[Fremontia](#)
[Bulletin](#)
[Policy Archive](#)
[State Meetings](#)

Native Plant Conservation Campaign

Events

Local Chapters

[Plant Sales](#)
[Newsletters](#)

[Kid's Stuff](#)

[Photo Gallery](#)

[Bookstore](#)

[Jobs](#)

[Links...](#)

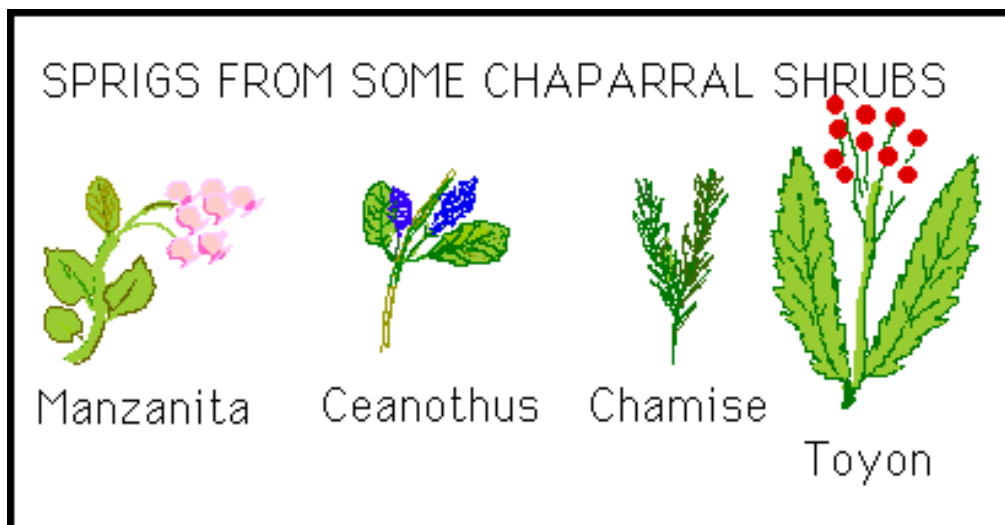

These plants usually have really stiff, tough little leaves...they are usually quite shiny and look like they have a waxy covering. The leaves actually do have a waxy covering, which seals in the water inside the leaf during the hot summer months. The wax causes the leaves to burn really hot in a fire, like little candles.

Such waxy-leaf plants are called sclerophyls, and have sclerophyllous properties. Try saying sclerophyllous three times and then wipe the spit off the screen!



Chaparral is found where the summers are long and hot, and where it might not rain for half a year or more. The hillsides are covered by stiff bushes that grow very close together, and you can't really walk through them without getting scratched up. As the bushes get older and older, more and more dead wood and leaves accumulate, until the chaparral can contain as much dead wood as living wood. So now we have little waxy leaves and a dried out woodpile to think about when we start talking about fires.

Fire can start in the chaparral because of lightning, or because of careless smokers. The vegetation will usually be dense enough to allow a really big fire after it is about 10 years old, and often very old chaparral (40 years old or older) will have so much dead wood that flames will be taller than houses and can reach right across streets.

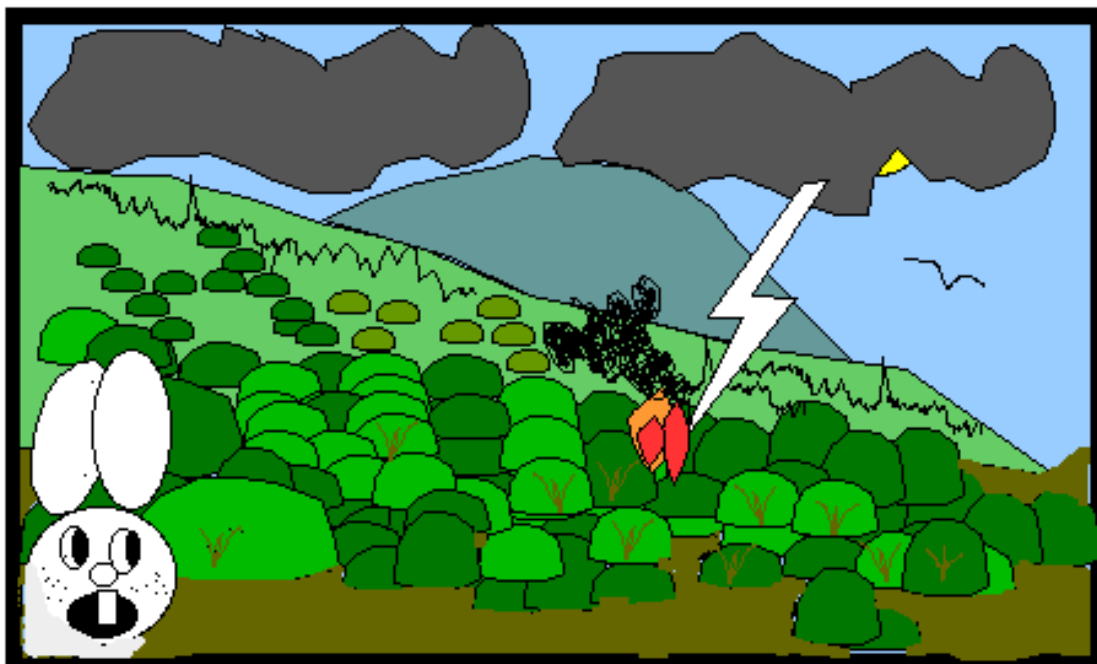

Once fires start they can move across the hillsides very quickly. There is lots of heat given off. One fire in 1994 produced the heat of five atom bombs in a single hour. You sure didn't want to get in the way of that wildfire!

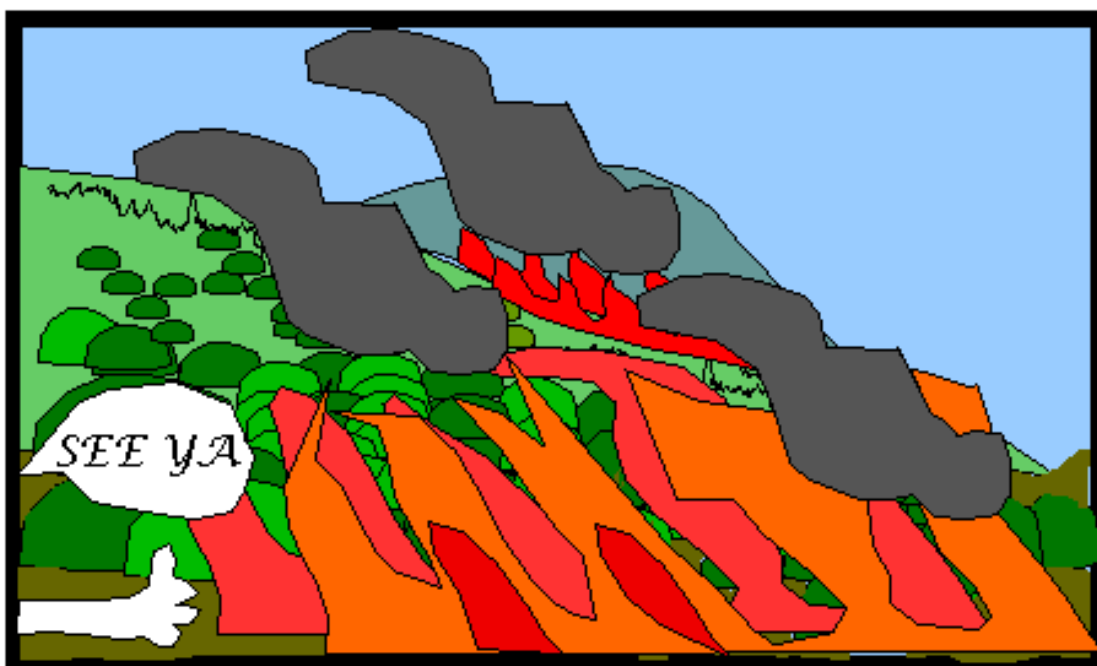

The waxy leaves and the dead wood cause a hot fire, and when it is over there is not very much left to see. Just a few burned stumps and sticks, piles of ash, and nothing apparently left alive. It is pretty depressing to look at.



So why was this good for the plants? How can dying in a fire help a plant? The answer lies in the seeds of some of the plants, and in the special nature of the blackened stumps of some of the others.

Now just imagine what it would be like to be a little seedling trying to grow under all of the big plants if they were still there. Down on the ground it would be too shaded for light to reach the new little leaves, and the big plants would gobble up all of the water. The little seedling would probably die, and there would be no room for it anyway.

After the fire there is space to grow, and there is water to drink and beautiful sunlight for energy. You might guess that all of the seeds would have burned up in the fire, but you would be wrong. In fact, the seeds may have been in the soil for years, just waiting for the fire. These seeds have a special outer coat that doesn't allow water to come in and cause the seed to sprout.

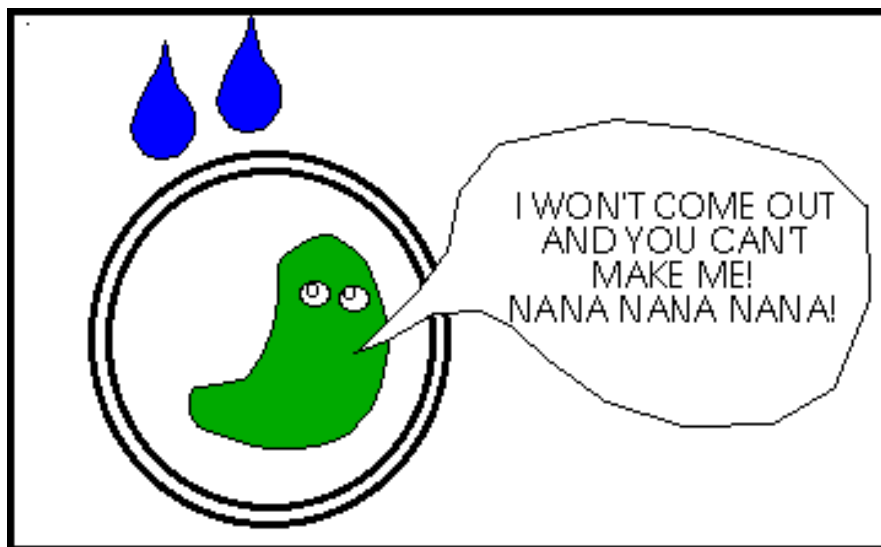

The fire causes the outer coat to break up. The cause is either the heat from the fire, or chemicals from the smoke... maybe both.

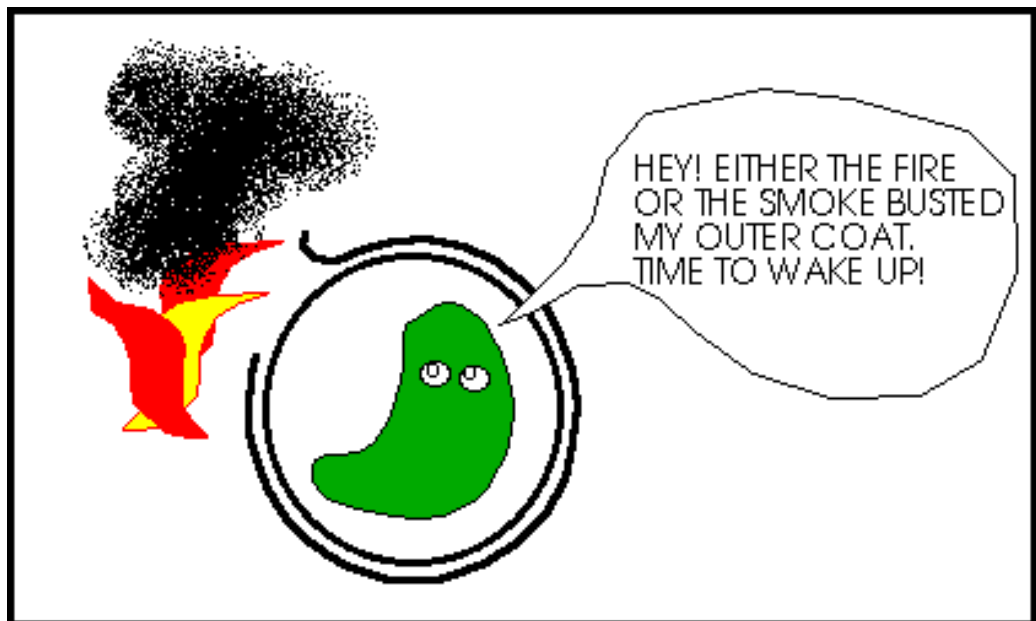

The rain can then get into the seed, and up it sprouts into a world of wonderful light. It is kind of like the parent plant knowing it is getting old and woody, and deciding to get out of the way to make room for the kids.

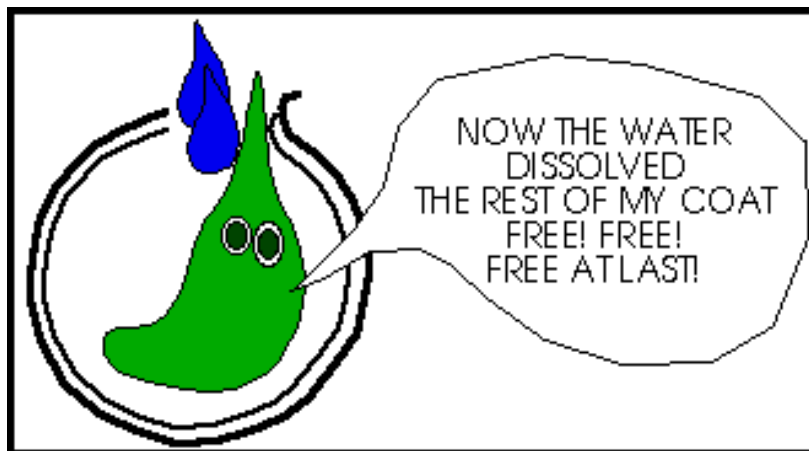

The waxy covering on the parent's leaves often has another purpose, and that is to burn with great heat. This might seem a little weird, but it is to make that the less fire-protected seeds of other plants are killed, as they might have taken away water and sunlight from the plant's own seedlings.

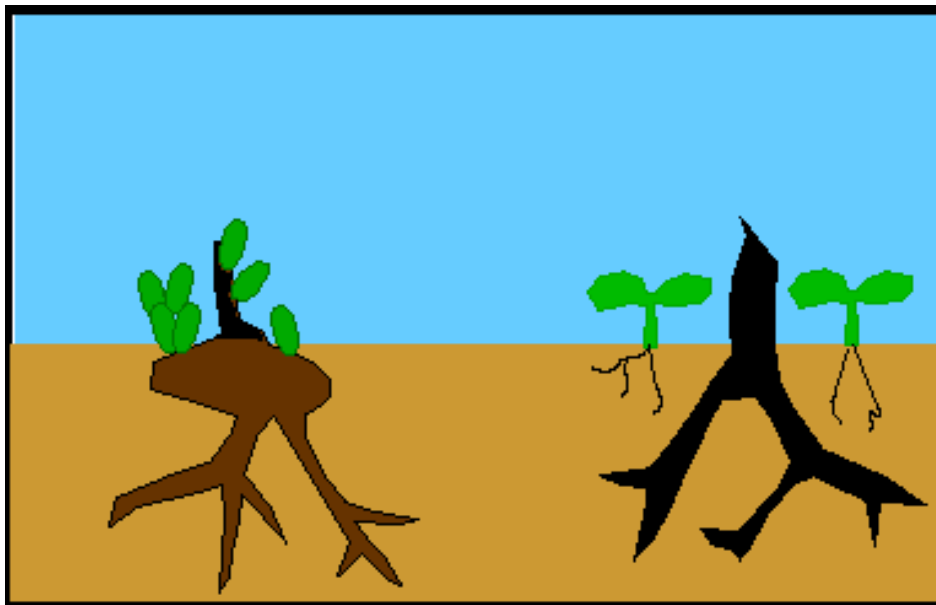

Some species of chaparral can sprout from their stumps. These bushes keep a lot of energy in their roots, and after the top of the plant burns off, they simply sprout new leaves and branches. In this way, some plants may survive many fires, and could be hundreds of years old. Below we see a so-called "stump-sprouter" on the left, and a "seeder" on the right.

And so the plant species continue, and soon the hillside looks like it did before. The new sprouts and seedlings are really tasty for wildlife, and so life quickly returns. And the plants grow, get old, there is a fire, the plants grow, get old, there is another fire.....and on....and on....



Dedicated to the preservation of California native flora

California Native Plant Society
2707 K Street, Suite 1 • Sacramento, CA 95816-5113
(916) 447-2677 • fax (916) 447-2727 • cnps@cnps.org

Copyright © 1999-2004 California Native Plant Society. All rights reserved.



Pioneer

Emergency Preparedness Products

Pioneer, California

Toll-Free: 1-800-330-4234

Product Categories:

Pump & Solar Powered
Emergency Flashlights

Solar Crank Radios

Stun Guns, Pepper Spray
Surveillance Cameras

High-Filtration Face Masks

Portable Water
Filter

Preparedness Books



Survival
Top
Sites

Powered by !

SURVIVAL & PREPAREDNESS WEB RING



This site is owned by

Want to join the ?



Search

All content of this website is Copyright © 1998 - 2004, Paradise Distributing, Pioneer, CA 95666.
All rights reserved.

57310

The Bottle Inn

Marshwood, Nr Bridport

You are not logged in

[Login](#)

[Register for Membership](#)

[List of Members](#)

Language: English

[Homepage](#)

[Nettle Eating](#)

[whatson](#)

[Welcome](#)

[About](#)

[News](#)

[Food & Drink](#)

[Gallery](#)

[Whats On?](#)

[Bottle Inn Staff](#)

[Our Location](#)

[Links](#)

[Guestbook](#)

[Contact Us](#)

[Search](#)

[Site Map](#)

Welcome to the Bottle Inn Website



[Stop Press](#)

[Contact](#)

Tel : (01297) 678254

Fax : (01297) 678739

Email

thebottleinn@msn.com

Site-Help

webmaster@thebottleinn.co.uk

A 16th Century Public House situated in an idyllic location in Dorset.

We serve excellent food & drink, including menus for Vegetarians & Vegans.

The Bottle Inn is home to the World Nettle Eating Challenge.

Powered by
ezContents

Version 1.4.2



Welcome to Vqt.org

 Try searching these categories:
Finance

[Investing](#)
[Credit Cards](#)
[Mortgage](#)
[Insurance](#)
[Loans](#)

Education

[College Degree](#)
[Financial Aid](#)
[High School](#)
[LSAT](#)
[Online Courses](#)

Entertainment

[Music](#)
[Television](#)
[Sports](#)
[Video Games](#)
[Arts](#)

Real Estate

[Apartments](#)
[Home Buying](#)
[Moving](#)
[Renting](#)
[Home Improvement](#)

Health

[Diet](#)
[Health Insurance](#)
[Weight Loss](#)
[Men's Health](#)
[Women's Health](#)

Lifestyle

[Cooking](#)
[Home Decorating](#)
[Gardening](#)
[Crafts](#)
[Collectibles](#)

Computers

[Computer Hardware](#)
[Software](#)
[Internet](#)
[Programming](#)
[Web Design](#)

Shopping

[Cars](#)
[Gifts](#)
[Books](#)
[Toys](#)
[Electronics](#)

Travel

[Airline Tickets](#)
[Hotels](#)
[Vacations](#)
[Cruises](#)
[Car Rentals](#)

 Search Suggestions:

" [Structured Settlements](#)
 " [Consumer Credit Counseling](#)
 " [Online Courses](#)
 " [Distance Learning](#)
 " [Mortgage Refinance](#)
 " [Credit Card Debt](#)
 " [University Of Phoenix](#)
 " [Mortgage Companies](#)
 " [Credit Card Debt Consolidation](#)
 " [Loans](#)
 " [Home Equity](#)
 " [Home Equity Loans](#)
 " [Home Loans](#)
 " [Credit Report](#)
 " [Debt Consolidation Loans](#)
 " [Credit Problems](#)
 " [Mortgage Rates](#)
 " [Credit Reports](#)
 " [Bad Credit Repair](#)
 " [Bankruptcy](#)
 " [Debt Consolidation](#)
 " [Online Degree Programs](#)
 " [Mortgage Lenders](#)
 " [Consolidation Loans](#)
 " [Mortgage Brokers](#)
 " [Bad Credit](#)
 " [Bill Consolidation](#)
 " [Debt Free](#)
 " [Debt Consolidation Services](#)
 " [Cash Flow](#)
 " [Mortgage Loans](#)
 " [Higher Education](#)
 " [Personal Injury](#)
 " [Repairing Your Credit](#)
 " [Online Universities](#)
 " [Free Debt Consolidation](#)

 Still can't find what you're looking for? Try searching the internet.
©2004 Trafficz. A service provided by [Trafficz.com](#)*Trafficz does not own this domain. [Click Here](#) to email the current owner of this domain name.

**Bad
Bug
Book**

U.S. Food & Drug Administration
Center for Food Safety & Applied Nutrition
Foodborne Pathogenic Microorganisms
and Natural Toxins Handbook

Giardia lamblia

CDC/MMWR

NIH/PubMed

Agricola

1. Name of the Organism:
Giardia lamblia

Giardia lamblia (intestinalis) is a single celled animal, i.e., a protozoa, that moves with the aid of five flagella. In Europe, it is sometimes referred to as *Lamblia intestinalis*.

2. Nature of Acute Disease:

[Giardiasis](#) is the most frequent cause of non-bacterial diarrhea in North America.

3. Nature of Disease:

[CDC Case Definition](#)

[What is a "Case Definition"?](#)

[Overview of Public Health Surveillance](#)

Organisms that appear identical to those that cause human illness have been isolated from domestic animals (dogs and cats) and wild animals (beavers and bears). A related but morphologically distinct organism infects rodents, although rodents may be infected with human isolates in the laboratory. Human giardiasis may involve diarrhea within 1 week of ingestion of the cyst, which is the environmental survival form and infective stage of the organism.

Normally illness lasts for 1 to 2 weeks, but there are cases of chronic infections lasting months to years. Chronic cases, both those with defined immune deficiencies and those without, are difficult to treat.

The disease mechanism is unknown, with some investigators reporting that the organism produces a toxin while others are unable to confirm its existence. The organism has been demonstrated inside host cells in the duodenum, but most investigators think this is such an infrequent occurrence that it is not responsible for disease symptoms. Mechanical obstruction of the absorptive surface of the intestine has been proposed as a possible pathogenic mechanism, as has a synergistic relationship with some of the intestinal flora.

Giardia can be excysted, cultured and encysted in vitro; new

isolates have bacterial, fungal, and viral symbionts. Classically the disease was diagnosed by demonstration of the organism in stained fecal smears.

Several strains of *G. lamblia* have been isolated and described through analysis of their proteins and DNA; type of strain, however, is not consistently associated with disease severity. Different individuals show various degrees of symptoms when infected with the same strain, and the symptoms of an individual may vary during the course of the disease.

Infectious Dose - Ingestion of one or more cysts may cause disease, as contrasted to most bacterial illnesses where hundreds to thousands of organisms must be consumed to produce illness.

4. Diagnosis of Human Illness:

Giardia lamblia is frequently diagnosed by visualizing the organism, either the trophozoite (active reproducing form) or the cyst (the resting stage that is resistant to adverse environmental conditions) in stained preparations or unstained wet mounts with the aid of a microscope. A commercial fluorescent antibody kit is available to stain the organism. Organisms may be concentrated by sedimentation or flotation; however, these procedures reduce the number of recognizable organisms in the sample. An [enzyme linked immunosorbant assay](#) (ELISA) that detects excretory secretory products of the organism is also available. So far, the increased sensitivity of indirect serological detection has not been consistently demonstrated.

5. Associated Foods:

Giardiasis is most frequently associated with the consumption of contaminated water. Five outbreaks have been traced to food contamination by infected or infested food handlers, and the possibility of infections from contaminated vegetables that are eaten raw cannot be excluded. Cool moist conditions favor the survival of the organism.

6. Relative Frequency of Disease:

Giardiasis is more prevalent in children than in adults, possibly because many individuals seem to have a lasting immunity after infection. This organism is implicated in 25% of the cases of gastrointestinal disease and may be present asymptotically. The overall incidence of infection in the United States is estimated at 2% of the population. This disease afflicts many homosexual men, both HIV-positive and HIV-negative individuals. This is presumed to be due to sexual transmission. The disease is also common in child day care centers, especially those in which diapering is done.

7. Course of Disease and Complications:

About 40% of those who are diagnosed with giardiasis demonstrate disaccharide intolerance during detectable infection and up to 6 months after the infection can no longer be detected. Lactose (i.e., milk sugar) intolerance is most frequently observed. Some individuals (less than 4%) remain symptomatic more than 2 weeks; chronic infections lead to a malabsorption syndrome and severe weight loss. Chronic cases of giardiasis in immunodeficient and normal individuals are frequently refractile to drug treatment. Flagyl is normally quite effective in terminating infections. In some immune deficient individuals, giardiasis may contribute to a shortening of the life span.

8. Target Populations:

Giardiasis occurs throughout the population, although the prevalence is higher in children than adults. Chronic symptomatic giardiasis is more common in adults than children.

9. Food Analysis:

Food is analyzed by thorough surface cleaning of the suspected food and sedimentation of the organisms from the cleaning water. Feeding to specific pathogen-free animals has been used to detect the organism in large outbreaks associated with municipal water systems. The precise sensitivity of these methods has not been determined, so that negative results are questionable. Seven days may be required to detect an experimental infection.

10. Selected Outbreaks:

Literature references can be found at the links below.

Major outbreaks are associated with contaminated water systems that do not use sand filtration or have a defect in the filtration system.

[MMWR 38\(23\):1989](#)

In April 1988, the Albuquerque Environmental Health Department and the New Mexico Health and Environment Department investigated reports of giardiasis among members of a church youth group in Albuquerque. The first two members to be affected had onset of diarrhea on March 3 and 4, respectively; stool specimens from both were positive for *Giardia lamblia* cysts. These two persons had only church youth group activities in common.

[MMWR 32\(50\):1983](#)

On August 8, 1983, the Utah Department of Health was notified by the Tooele County Health Department (TCHD) of an outbreak of diarrheal illness in Tooele, Utah, possibly associated with a contaminated public water supply that resulted from flooding during Utah's spring thaw.

[Morbidity and Mortality Weekly Reports](#)

For more information on recent outbreaks see the CDC.

11. Education and Background Resources:

Literature references can be found at the links below.

Loci index for genome [Giardia lamblia](#)

Available from the GenBank [Taxonomy database](#), which contains the names of all organisms that are represented in the genetic databases with at least one nucleotide or protein sequence.

CDC *Giardiasis* [FAQ'S](#)

Frequently Asked Questions about *Giardiasis*.

FSIS Parasites and Foodborne Illness [Resource page](#)

Giardia duodenalis, cause of giardiasis (GEE-are-DYE-uh-sis), is a one-celled, microscopic parasite that can live in the intestines of animals and people. It is found in every region throughout the world and has become recognized as one of the most common causes of waterborne (and occasionally foodborne) illness.

12. Molecular Structural Data:

None currently available.

13. FDA Regulations or Activity:[Bacteriological Analytical Manual.](#)

Current recovery methods are published in this FDA methodology reference. The FDA continues to actively develop and improve methods of recovering parasitic protozoa and helminth eggs from foods.

CDC/MMWR

The CDC/MMWR link will provide a list of Morbidity and Mortality Weekly Reports at CDC relating to this organism or toxin. The date shown is the date the item was posted on the Web, not the date of the MMWR. The summary statement shown are the initial words of the overall document. The specific article of interest may be just one article or item within the overall report.

NIH/PubMed

The NIH/PubMed button at the top of the page will provide a list of research abstracts contained in the National Library of Medicine's MEDLINE database for this organism or toxin.

AGRICOLA

The AGRICOLA button will provide a list of research abstracts contained in the National Agricultural Library database for this organism or toxin.

mow@cfsan.fda.gov

January 1992 with periodic updates

[Bad Bug Book](#)

[Foods Home](#) | [FDA Home](#) | [Search/Subject Index](#) | [Disclaimers & Privacy Policy](#) | [Accessibility/Help](#)

Hypertext last updated by las/ear/dav 2003-JAN-07



A Hypothermia Treatment Technology Web Site.

EQUIPMENT LINKS



[RES-Q-AIR](#)



[IV WARMER](#)



[ELECTRONIC STETHOSCOPE](#)



[MC 2000 DRUG CASE](#)

"Rescuers have an important role in the first aid medical treatment of victims"

World Congress on Drowning

Hypothermia treatment starts in the field by rewarming (stabilizing) victims with equipment supplying warm humidified air or oxygen and warm IV-fluids to minimize core-temperature afterdrop.

The growing popularity of outdoor recreation, has resulted in greater demand for an effective on-site method of treating hypothermia.

Other than for mild cases, the most effective and safest treatment for all levels of hypothermia is the addition of heat to the body core, rather than via the periphery.

Research on hypothermia conducted at the University of Victoria (Victoria, B.C., Canada) developed the survival behaviors such as the [HELP - and the - HUDDLE](#) - survival positions, now promoted world wide, the cold water [immersion survival - time table](#) and the Uvic Thermo-float jacket.

Two team members (Robert Douwens and Dr. John Hayward) also developed and patented the hypothermia treatment technology [RES-Q-AIR system](#).

What is the major injury rescue specialists face?

"Without a doubt hypothermia," says Bob Ayres, Canadian Coast Guard Rescue Specialist Coordinator, . . . "Due to the cold waters on our coast we have adapted specialized equipment, including inhalation rewarming units known as

the [RES-Q-AIR](#) to stabilize and begin warming in the field."



RECHARGEABLE BATTERY



POWER SUPPLY & CHARGER



HYPOTHERMIA BAG

HYPOTHERMIA PROTOCOLS

[Alaskan Protocols](#)

[JAMA](#)

HYPOTHERMIA TREATMENT

[Treating Hypothermia](#)

[Scenario's](#)

[Field Chart](#)

[Hospital Chart](#)

[Airway Rewarming](#)

[Airway Treatment](#)

TESTIMONIALS

[Testimonial 1](#)

[Mayday](#)

[Shorelines](#)

OTHER PAGES

[Links Page](#)

[Home Page](#)

[E MAIL](#)



- see article: 1) [Life saving action by the Canadian Coast Guard](#)
 2) [Testimonials of field experiences](#)

Some comments we received.

"Congratulations! Based on the high quality and excellent presentation of your site, our medical reviewers have awarded you a 5 - Star Health A to Z Rating!" Your site has been featured for having exceeded our rigorous standards for inclusion". Raj Lakhanpal, MD, FRCS, FACEP

"You have been awarded the Emergency Concepts Award of Excellence. Keep up the good work".

"An abundant amount of information concerning hypothermia. Good resource for the community. It is obvious that a lot of time and effort was spend in putting this information together".



We subscribe to the [HONcode principles](#) of the [Health On the Net Foundation](#)



The material in this site is provided for educational and informational purposes only, and is not intended to be a substitute for a health care provider's consultation. Please consult a physician or appropriate health care provider about the applicability of any opinions or recommendations with respect to symptoms or medical conditions.

[back to top](#)

**RES-Q PRODUCTS INC. RR 6 - 1350 Martock Road, Sooke, B.C., V0S 1N0
Canada**

For prices and ordering information please [Phone 250-642-7057](tel:250-642-7057) - [Fax 250-642-7074](tel:250-642-7074)

Outside of North America dial 01 first. Or [E MAIL us](#)

All texts, images, layout and codes are © 1997 Res-Q Products Inc. Last updated: February 01, 2004



May 2004

IMAX®
DVD



Grand
Canyon

Animal of the Month
[The Bat](#)

Plant of the Month
[Desert Globemallow](#)

People & Cultures
[Spanish Franciscan
Missionary](#)

Desert Lil's
Delicacies



A complete index of Desert Lil's Desert Recipes, culinary tips and desert food resources. A guide for cooking when

Desert Directory



- | | | |
|--|---|--|
| Colorado River info. | Book and Gift Store | Hotel Reservations |
| What is a Desert ? | Things to Do | Minerals & Geology |
| Animal & Wildlife | Rocks & Prospecting | Hiking & Climbing |
| Plants & Wildflowers | Maps | On & Off-Road |
| People & Cultures | Parks in the Desert | QuickTime VR |
| Index DesertUSA | Wildflower Reports | Desert Message Board |

Need More Desert Information ? Try Searching Our Site.

Educational items: Learn about the desert animals, plants and survival in the deserts. [More information](#)

Feature Articles



[Prickly Pear Sweets & Treats](#) - Prickly Pear Cactus have been a staple food of Native Americans for many centuries. Their large, colorful blossoms appear in yellow, pink, red or purple and grow from the tip of cactus nodules, which later ripen into delicious red fruit. Many varieties of prickly pear cactus grow wild throughout the deserts of the Southwest, but many are not native. [More...](#)

Free DesertUSA
Newsletter!
[More Information](#)

Enter E-Mail address

[Subscribe](#)
[Unsubscribe](#)

Services

Hotel - Motel
Reservations

Airlines

Cars

Golf

Book Online Today

camping. [More...](#)

[Desert Events Calendar](#)

Links to what's happening this month in the deserts.

Where to Go?

What to Do?

What To See?



Click Here

For Park Guides



The Great Basin Desert, Bristlecone Pines, appear between 9,500 and 11,000 feet.

[The Great Basin Desert](#), the largest U. S. desert, covers an arid expanse of about 190,000 square miles and is bordered by the Sierra Nevada Range on the west and the Rocky Mountains on the east, the Columbia Plateau to the north and the Mojave and Sonoran deserts to the south.. [More...](#)

[The Salinas Pueblos](#): My wife Martha and I had just put up our tent beneath a canopy of ponderosa pines in the Manzano Mountain State Park, located on the eastern flanks of the Manzano Range in central New Mexico. We had come, with our strawberry blond cocker spaniel Pokey, to spend a couple of summer days exploring the pueblos of the Salinas Basin. We had just unloaded groceries and an ice chest from our old Ford Bronco. Darkness had begun to fall. A park ranger stopped by. --- "Be sure to stash all your food in your vehicle tonight," he said. "We have a rogue bear in the park." [More...](#)

[Beat Arizona's Summer Heat](#) - About 100 miles northeast of Phoenix, off Arizona State Highway 87, the Mogollon Rim's forest of ponderosa pine, pinyon, juniper and scrub oak offers some welcome relief from the summer heat of the Sonoran Desert. Here, in the heart of Arizona's rim country, 5000 to 6000 feet in elevation, you will discover three communities with considerable charm, the Tonto Natural Bridge State Park with its imposing natural limestone bridge, and the Tonto National Forest's Fossil Creek

Free Stuff

[E-Cards](#)

[Puzzle](#)

[Fascinating Facts](#)

[Desktop Pictures](#)

[Music](#)

Listen to music while surfing DesertUSA.

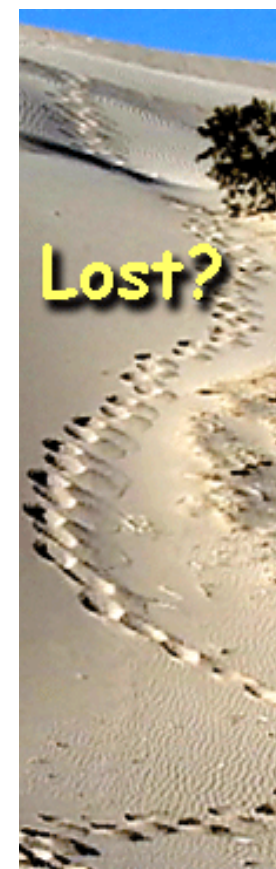

and
Packages

10000 	Phoenix, AZ
10000 	Laughlin, NV
10000 	Las Vegas, NV
10000 	Palm Springs, CA
10000 	Zion NP, UT
10000 	Lake Powell, AZ
10000 	Joshua Tree, CA

Springs Trail with its century-old hydroelectric power plant system. [More...](#)

[Yuma Territorial Prison](#) is a living museum of the Old West. More than 3,000 desperadoes, convicted of crimes ranging from polygamy to murder, were imprisoned in rock and adobe cells here during the prison's 33-year existence between 1876 and 1909. The cells, main gate and guard tower are still standing, providing visitors with a glimpse of convict life in the Southwest a century ago. [More...](#)

[Site Guide](#) - What is it? Learn how to get the most out of DesertUSA. The site guide give you a quick run down on how to use our navigation bar which appears in the left panel of all the DesertUSA pages. It also give you an overview of the tools selections. [More...](#)

Desert Events

Anza Borrego Desert State Park - [Activities Schedule](#) May 2004

Borrego Springs, CA Cinco de Mayo May 1 & 2, 2004

Rattlesnakes are back check out our article on [Desert Rattlesnakes](#)

Colorado River - before you go to the river and it's lakes check our [Colorado River Updates](#).

[Desert Safety Tips](#)

Prickly Pear Cactus Products
Candy, Jelly and Syrup from Prickly Pear Cactus Juice

Have You Tried Shopping Online ?
Visit DesertUSA's Store 

[Flowers](#) [Flower Arrangements](#) & [Flower Delivery](#) Sponsored By: [Send Flowers](#)



[Aquis Towels](#)

[Los Angeles Flowers](#), [Chicago Flowers](#), [San Diego Flowers](#), [Las Vegas Flowers](#),
[Houston Flowers](#), [New York Flowers](#), [Washington DC Flowers](#), [Orlando Flowers](#),
[Boston Flowers](#), [Portland Flowers](#), [Philadelphia Flowers](#), [Baltimore Flowers](#),
[Dallas Flowers](#), [San Jose Flowers](#), [Detroit Flowers](#), [Newark Flowers](#), [Phoenix
Flowers](#), [Minneapolis Flowers](#), [Oakland Flowers](#), [Toronto Flowers](#), [Pittsburgh
Flowers](#), [Denver Flowers](#), [Atlanta Flowers](#), [California Flowers](#), [Birthday Flowers](#),
[Funeral Flowers](#), [Red Roses](#), [Florist](#), [Arizona Flowers](#), [Flower](#), [Florists](#)

[What's New](#) | [Places To Go](#) | [Things To Do](#) | [Desert Life](#) | [Desert Talk](#) | [Trading Post](#) | [Site Guide](#) | [Maps](#) | [Search](#) |
[Index](#) | [About DUSA](#) | [Feedback](#) | [Privacy](#)

[Aquis Towels](#)

DESERT USA

Copyright © 1996-2004 DesertUSA.Com
and Digital West Media Inc.



[HOME](#)

Mailing List •
ocb_list@ocbtracker.com

Contact Us:
 • Fax:
 (413) 473-2907
 • Email:
ltr@ocbtracker.com

• If you want your event on the calendar, either use the fax number above, or mail a copy to:

OCB Trading Post
 657 E Arrow Hwy #M
 Glendora, CA 91740

ART INSTRUCTION
 SCHOOLS

Are you
 feeling
 creative?



Message Alert _ □ ×

Congratulations! Your banner ID **#184B6832** has won our hourly contest. **Click here** to claim your prize OK

2004 Events

Last updated Friday, May 07, 2004 Next update on or before May 14th, 2004

May 7th - 9th, 2004

10th Annual Northern and Southern Winds Pow Wow

OCB Will Be There

East Los Angeles College
 1301 Avenida Cesar Chavez
 Monterey Park, CA 91754

Hours: Fri 7pm-10pm; Sat 11am-10pm;
 Sun 11am-6pm

Info: (323) 377-3523 Vendors: (323) 428-1666

Please note - dates, times, etc are outside of my control. A powwow can be cancelled for nearly any reason, including weather. Information numbers are included and should be used for more information. E-mailing me about vender applications, complaints, directions, etc will likely be ignored. I do not run these events, I only list them. I will be at the events that have OCB Will Be There listed on them, and possibly other events as well. Feel free to stop by and thank me if you'd like.

- Gary

May 8th - 9th, 2004

11th Annual Mariposa Pow Wow
 Mariposa Fairgrounds

Hwy 49 So.

Mariposa, CA

M.C.- Art Martinez; Arena Director- J.R Manuel; Head Man- Aaron Wright; Head Woman- Marlene Johnson; Head Boy- Dustin Lemaster; Head Girl- Naomi Ortega; Head Tiny Tot Boy- Christopher Jones Jr.; Head Tiny Tot Girl- Libra Alvarez

www.visitmariposa.net/powwow/

Info: 209-742-2244

If you'd like to advertise on this page, feel free to contact me. We have a very high click through rate, especially for American Indian related businesses and supporters. On average, one out of every ten visits to the page results in a click through.

May 8th, 2004

Scorpion Contest Pow Wow
 Farmington High School Gymnasium
 2200 Sunset AVE.

Farmington New Mexico

Gourd Sessions 11:00am & 6:00pm Grand Entries 12:00pm & 7:00pm Head Staff TBA

shy_sal2004@yahoo.com

Info: (505)324-0352 ext 1449



Events should be submitted no less than six weeks before they begin, and submissions should include a vender application as well.

Submissions sent in may or may not be posted on this calendar depending upon my time, my mood, the odd quirks in the server and for just about any other reason under the sun.

If you wish to yell at me for not having an event listed, a problem with an event listing, etc., the fee is \$75 per hour, three hours minimum, payable in advance.

May 14th - 16th, 2004

Redbird's Children of Many Colors Native American Intertribal Powwow

OCB Will Be There

Castaic Lake Recreation Area

At the Lagoon

32132 Castaic Lake Drive

Castaic, CA

(eight miles north of Magic Mountain on Interstate 5 in Los Angeles County)

Gourd Dancing, All dancers welcome, all drums welcome. Children's activities.

Arts, Crafts and Food! Educational exhibits.

Email: redbirds_vision@hotmail.com

Website: www.rebirdsvision.com

Info: (805) 217-0364

You are visitor

to this site

CONGRATULATIONS! YOU'VE WON!

[Click Here](#)

May 14th - 16th, 2004

24th Annual American Indian Arts Market and Powwow

DeAnza College

S-Quad

21250 Stevens Creek Blvd.

Cupertino, CA 95014

Open Gourd Dancing, Drum "day money" paid daily.

Website: www.deanzapowwow.org

Email: parkergerri@fhda.edu

Info: (408) 486-TELL (8355)(ext 871 for general info, 872 for vendor info, 874 for entertainment info.)

May 15th, 2004

Cal Poly Pomona 6th Annual Healing the Earth Powwow

Cal Poly Rose Garden

3801W. Temple Avenue

Pomona, CA

Traditional Powwow. Gourd dancing at 11am. All gourd dancers welcome. Grand

Entry at 12:00. Vendors contact Alex Hunter at (909) 869-6877.

lacornmaiden@yahoo.com

Info: Call Audrey (909) 482-0985

May 15th - 16th, 2004

American Indian Cultural Days

Balboa Park

Park Blvd & President's Way

San Diego, CA

Info: (619) 281-5964

May 21st - 23rd, 2004

1st Annual Circle of All Nations Pow Wow

OCB Will Be There

The OutPost

34141 116th St

Pear Blossom, CA

Just south of Hwy 138 between Victorville and Palmdale

Hours: Friday 4pm-9pm; Sat 10am-9pm; Sun 10am-7pm
Info: Bobbi Sanchez (661) 994-3540; OutPost (661) 944-1200

May 22nd - 23rd, 2004

23rd Annual Medicine Ways Powwow
UC Riverside
Riverside, CA
\$5 parking, all day - \$1 per hour
All Drums and Dancers Welcome
Info: (909) 787-4143

May 29th - 30th, 2004

Chumash Interpretive Center Powwow
OCB Will Be There
Chumash Interpretive Center
3290 Lang Ranch Parkway
Thousand Oaks, CA 91362
Hours: Sat 10am - 8pm; Sun 10am - 6pm
Info: (805) 492-8076

May 29 - 30th, 2004

14th Annual Intertribal Powwow
Saddleback College
Avery Parkway
Mission Viejo, CA
Info: (909) 488-4284

June 4th - 6th, 2004

Standing Bear Pow Wow 2004
OCB Will Be There
West High School
Bakersfield, CA
Ming Ave Exit off I-99, west to Valhalla, right to High School campus on left.
Admission \$5.00
For information: Gene Albitre (661) 589-8414 or (661) 589-3181

June 12th - 13th, 2004

9th San Luis Rey Intertribal Powwow
OCB Will Be There
San Luis Rey Mission Grounds
4050 Mission Ave
Oceanside, CA
All dancers & Drums welcome, contest dancing, peon games at dusk
Info: (760) 724-8505

June 11th - 13th, 2004

4th Annual Pow Wow Honoring Acorn Makers
West of Table Mountain Rancheria Casino
North-east of Fresno, CA
Chicken Dance Special \$1,000, Men's Traditional Special \$1,000. Princess, dance, drum contests. Hand games, Indian crafts and great food!
Free admission; open to the public!
Info: (559) 822-2890

There will be no Tehachapi powwow this year, according to info number

July 2nd - 4th, 2004

Ninth Annual Pechanga Powwow

Pechanga Resort & Casino

45000 Pechanga Parkway

Temecula, CA

Info: 909)303-2523

Vendors: 323-344-9113

Free to the public, everyone welcome free parking, rv camping available. Contest dancing, drum contest, all drums welcome fireworks on Saturday, head staff TBA.

July 16 - 18, 2004

9th Big Bear All Nations Powwow

Los Vaqueros Rodeo Arena

Off Hwy 38 and Zaca Rd

Big Bear City, CA

Music, dancing, arts and crafts, food

Info: Faye Roman (909) 790-1390

July 24th - 25th, 2004

9th Annual Vallejo Intertribal Powwow

Waterfront

Mare Island Way

Vallejo, CA

Open gourd dance, all traditional drums welcome, special invitation to women drum groups

Info: (707) 554-6114

Vendors: (707) 552-2562

July 24th - 25th, 2004

Lake Casitas Powwow

OCB Will Be There

Lake Casitas

Ojai, CA

Hours: Sat 10am-7pm; Sun 10-5pm

Admission \$10, under 13 \$5. Weekend pass \$15, parking \$3 -- Free admission to contest dancers, social dancers and family are asked to help support the powwow and the dancers by paying for admission.

Info: (805) 496-6036

Lake Casitas (805) 649-2233

September 3rd - 5th, 2004

19th Annual Numaga Indian Days

Reno-Sparks Indian Colony

Hungry Valley Community

Eagle Canyon Dr & Fancy Dance Dr

Sparks, NV

Points system contest, dry camping, golf tournament, princess contest Host Drum:

Midnite Express; MC Denny Stanley; Arena Director Jerry Bear

General Info: (775) 425-0775

Vendors: Dan Thayer at above

September 24th - 26th, 2004

14th Annual Thunder & Lightning Powwow

Casino Morongo

Near Beaumont, CA

Contest dancing, ground dance

Info: (800) 252-4499

Sept. 24th - 26th, 2004

IIAC Annual Pow-Wow

Bishop, California

Bishop Paiute Reservation

Bishop, California

This is a contest pow-wow. The pow-wow also celebrates California Indian Days.

Open to the Public, bring own shade and chairs and plenty of water. No alcohol and drug use allowed. Open admission.

Info: Call rena at (760) 872-2213

Sept. 25th - 26th, 2004

11th Annual Hart Powwow

OCB Will Be There

Wm.S.Hart Park

24151 N. San Fernando Rd.

Newhall, CA

Sat. 10:am to 7:pm

Sun. 10:am to 6:pm

Free admission!

http://www.hart-friends.org/event_pages/powwow.html

Info: 661/255-9295

Past Events for 2004:

Dec 31 to Jan 1, 2004

Red Road pow-wow

Fresno, Ca.

Info: 559-452-0620

January 2-3,2004

After the New Year Contest Pow Wow

Shonto Preparatory School

hwy 98/160

Shonto, Az

M/C-Dennis Bowen-Tuba City AZ;A/D-Lee Williams, Tempe AZ; Host Northern

Drum-Eagle Creek Singers, Dennehotso AZ; HeadMan/Lady-pick per session;

Grand Entry-Fri(Jan 2) 7 pm, Sat(Jan 3) 1 & 7 pm; Special Contest-Men's Grass

Dance Special and Drum Contest; Flag Ceremony and Veterans Give-Away

Info: 928/672-2652

February 14th - 15th, 2004

8th Annual Wildhorse Powwow

North Torrance High School

3620 W 182nd St

Torrance, CA

Directions: Off 405 freeway, exit Crenshaw Blvd. Make left at 182nd str, make left

at Yukon Hours: Sat: 11am - 10:30pm; Sun: 11am - 6pm Info: Jorge (562)

631-6327

February 14th, 2004

CIHA Monthly Powwow

Marshal Middle School

Doors open 6:30pm

Gym

Wardlow Road & Woodruff

Long Beach, CA

Happy Valentine's Day! There will be a special Potato Dance for couples with the winners receiving dinner for two at Claimjumper.

Info: www.ciha.net

March 6th - 7th, 2004

2004 California Hethushka

Marshall Middle School

Wardlow and Woodruff

Long Beach, CA

Guest Singer: Henry Collins

Info: www.ciha.net

March 13th - 14th, 2004

CSULB 34th Annual Pow Wow

Upper Quad, CSU Long Beach

1250 Bellflower Blvd.

Long Beach, CA

Pow Wow Hours: 11am-10pm Saturday, 3/13 11am-7pm, Sunday, 3/14

Head Southern Singer, Glenn Ahhaitty, (kiowa/comanche) Contest Dancing and

Hand Drum Contest. Dancers registration closes 2pm, Saturday. Gourd Dancing:

11 am Sat. & Sun. Grand Entry: 1pm & 7pm Sat.; 1pm Sun. This year's featured

artists include Silversmith Michael Rodgers (Bishop Paiute), Contemporary

Silversmith, Larry Pacheco (Laguna Pueblo), Dineh Silversmith Leroy Begay,

Contemporary Etched Pottery by Harrison Tom (Dineh), and Silversmiths Frank

and Darlene Chee (Dineh). Parking is free, and the campus is handicapped

accessible. It is strongly recommended that spectators bring folding chairs. Not

responsible for theft, loss, accident, injury or personal expenses. Absolutely no

alcohol, drugs allowed or overnight camping. With respect to our elders, no pets

allowed.

[CSULB Campus Maps](#)

[CSULB American Indian Alumni Chapter](#)

Info: (562) 985-4963

March 19th - April 4th, 2004

Play: Please Do Not Touch The Indians

A Native Voices at the Autry World Premiere

Fridays and Saturdays at 8pm; Saturday and Sunday Matinees 2pm; Special

Preview Thursday March 18th.

Tickets: General \$15, members \$12. For reservations call TicketWeb (866)

468-3399 or visit www.ticketweb.com. Visit www.autry-museum.org for more

information.

March 20th, 2004

12th Annual First Americans in the Arts Awards

Reception & Silent Auction 5:30-7:30pm

Dinner 8:00pm

Awards Presentation 9:00pm

After party begins after show and ends around 4:00am.

Millennium Baltimore Hotel

506 S Grand Ave

Los Angeles, CA 90071

Show & banquet tickets start at \$125. Come out and see your favorite American Indian actor or actress and cheer them on!

After party runs \$40 per person, attendance at the show not required. (The after-show tickets are discounted to \$20 for those who have tickets for the banquet/awards presentation.)

The First American in the Arts is the awards ceremony for American Indians in television, film, music. Tickets: Donna Sanchez (323) 478-1784. For more information, contact Anne Begay (310) 270-5388. Hotel reservations: (800) 245-8673

April 10th - 11th, 2004

6th Annual El Camino College Inter-tribal Powwow

OCB Will Be There

El Camino College

Track Field

16007 Crenshaw Blvd

Torrance, CA 90506

(Crenshaw Blvd and Redondo Beach Blvd

Hours: Sat 10am - 6pm; Sun 10am - 6pm

Admission Free, Parking \$2.00 (Free with ECC Parking Pass)

Host Drums: White Cloud (Northern), Hale & Co (Southern)

Contest - Tiny tots, youth, teen, adult & Golden Age

MC: Mike Reifel; Head Man Dancer: Joe Allen

Info: (310) 710-5194

April 16th, 2004

18th Annual Spring Pageant

Auditorium

Sherman Indian High School

9010 Magnolia Ave

Riverside, CA

Hours: 6pm - 9pm

Info: (909)276-6009 x 364

April 17th - 18th, 2004

Humboldt State University Powwow

West Gym

Humboldt State University

1 Harpst Street

Arcata, CA 95521

Info: (707) 826-4994

April 17th, 2004

19th Annual Intertribal Powwow

Ira Hayes Stadium

Sherman Indian High School

9010 Magnolia Ave

Riverside, CA

Hours: 11am - 11pm

Info: (909)276-6009 x 364

April 17th, 2004

San Diego State University Contest Powwow

Montezuma Hall in Aztec Center

San Diego State University
5500 Campanile Drive
San Diego, CA 92182
Hours: 11am - 11pm
MC: John Dawson; Headman: Richard Parker Van Dyke; Headwoman Alanna Sandoval
Host Drums: Green River (Northern); Glen Ahhaitty (Southern)
Free parking in structure 6; free admission
Info: (619) 592-6991

April 18th, 2004

Modesto College Powwow
East Campus Quad
Modesto Junior College
Modesto, CA
MC: Tom Philips; Head Man: CHarles Koshiway; Head Woman Lisa Holder
Host Drums: All Nation Singers (Northern); Roubedeaux Singers (Southern)
Free admission
InfoL (209) 575-6255

April 24th - 25th, 2004

Chumash Day Powwow and Inter-Tribal Gathering

OCB Will Be There

Malibu Bluffs Park
24250 Pacific Coast Highway
Malibu Canyon Road and Pacific Coast Highway
Malibu, CA 90265
Free admission, free parking
Native foods, Native American Arts & Crafts, Music, Story Telling, Children's Activities. MC: Mike Reifel (Apache), Arena Director: Vic Chavez (Dine), Headman Dancer: Randy Folkes (Chumash-Paiute), Headwoman Dancer: Kateri Walker (Chippewa), Head Young Man: Jose Little Owl (Mohawk), Head Young Woman: Corrina Inez Raas (Chumash-Apache), Head Goard Dancer: Saginaw Grant (Sac-Fox), Northern Host Drum: West Coast Singers, Southern Host Drum: Hale & Co.
Vendor Info Francine Greene: (310) 457-3006
General Info: (310) 456-2489 x 225

April 24th, 2004

12th Annual Ohlone "Big Time" Gathering and Pow-Wow
Martin Luther King Jr. Park
White & Lexington Ave
Pomona, CA
Starts at 10am; new location this year - with grass!
Info: (909) 591-3117

April 24th, 2004

Indian Education Conference Powwow
Westin Hotel LAX
Los Angeles, CA
Hours: 6pm - 11pm
Info: Phil Hale (714) 962-6673; Vendor info: (530) 275-1513

May 1st - 2nd, 2004

12th Annual Mother Earth Gathering Traditional Inter-tribal Pow Wow

OCB Will Be There

Hesperia Lake Park
7500 Arrowhead Lake Road
Hesperia, CA
Info: (760) 244-5488

May 1st - May 2nd, 2004

19th Annual UCLA Pow Wow
UCLA North Athletic Field
Los Angeles, California
<http://www.studentgroups.ucla.edu/americanindian/>
Info: (310) 206-7513

Past events for 2003:

May 9th - 11th, 2003

Stanford Powwow
Stanford University
Stanford, CA
Info: (650)725-6947

May 10th - 11th, 2003

9th Annual Northern and Southern Winds Powwow
Athletic field
East Los Angeles College
1301 Avenida Cesar Chavez (cross street Atlantic Blvd)
Monterey Park, CA

Sponsored by Iron Circle Nation and M.E.X.A. - All drums welcome! MC: Roy Track, Lakota; Hours: 11 am - 10pm Saturday, 11 am - 6pm Sunday. Grand entry 12:30pm both days. Featuring intertribal dancing, indigenous music, food, arts & crafts. Face painting, and Mother's Day Give-Aways! Bring your own chairs and shading, no camping permitted.

Info: (323) 241-0747 Vendor Info: (323) 265-8753 Email: Meno Martinez - elacpowwow@hotmail.com

May 9th - 10th, 2003

23rd Annual Augusta Powwow
Augusta, Georgia
Info: Bill Medeiros (706)771-1221
Email: krazywilly@knology.net

May 16-18, 2003

23rd Annual De Anza College Pow Wow
De Anza College
directions (408) 864-8355 ext.868
Cupertino, California

GRAND ENTRIES: Fri. 7 pm, Sat. 12 noon & 7pm, Sun. 12 noon POW WOW
HOURS: Fri. 7 pm to 11 pm, Sat. noon to 11 pm, Sun. noon to 5 pm ARTS &
FOOD HOURS: Fri. 5 pm to 10 pm, Sat. 10 am to 10 pm, Sun. 10am to 5 pm For
more information call (408)864-TELL (8355) then the following extensions
Getting to De Anza-ext. 868 What's a Pow Wow?-ext. 870 General
Information-ext. 871 Pow Wow Vendor Info-ext. 872 Pow Wow
Entertainment-ext. 874 Pow Wow Film Festival-ext. 875

May 16th - 18th, 2003

23rd Annual Powwow & Gathering
Tuscarora Nation of North Carolina
Maxton, NC

Admission \$2.00, camping space available, limited seating available, vendor space available. All drums and dancers welcome! MC: Keith Colston, Host Drum: Falling Water, Guest Drum: Kau-Ta-Noh Jrs.
Info: Chief Leon Locklear (910) 844-3352

May 17th - 18th, 2003

23rd De Anza College Powwow
De Anza College
South Quad
21250 Stevens Creek Blvd.
Cupertino, CA 95014
Contest powwow, food booths, craft booths
Info: (408) 864-5448
Email: DAIndigenous@yahoo.com
Website: <http://www.deanzapowwow.org>

May 16th, 2003

Medicine Ways Conference
UC Riverside
Riverside, CA
Info: (909) 787-4143

May 17th - 18th, 2003

Medicine Ways Powwow
Soccer Field
Riverside, CA
Hours: 11am - 10pm Sat, 11am - 6pm Sun. Craft booths, food booths
Info: Joel Beutel (909) 787-4143
email: ucmasa@hotmail.com
web: www.nasp.ucr.edu

May 17th - 18th, 2003

15th Annual American Indian Culture Days
Balboa Park - Park Blvd and President's Way
San Diego, CA
Kumeyaay Bird Singers, Abel Silvas, Bill Neal, Aztec Dancers, Tracy Lee Nelson, all drums welcome at the powwow. Hours 10am - 6pm, both days.
Info: (619) 281-5964

May 21th, 2003

American Indian Chamber of Commerce Monthly Meeting
(every third Wednesday)
11138 Valley Mall
Suite 200
El Monte, CA
Upstairs at the Bank of America building Meetings starts 6:30 potluck social, 7:30 call to order.
Info: (626) 442-3701 or (714) 898-6364

May 23rd - 26th, 2003

CIHA Spring Witayapi

Armed Forces Joint Training Center
Los Alimitos, CA
Info: Dianna (626) 339-4353

May 24th - 27th, 2003

18th Annual Casa de Fruita Red Road Powwow

May 24th - 27th, 2003

Grand Entry is Noon

Gates open at 9:00 Am until 12:00 AM

Contact: 831-425-4404

Website: www.indiancouncil.net

E-mail: santacruzic@yahoo.com

May 24th - 25th, 2003

Chumash Intertribal Powwow

Oakbrook Park Chumash Interpretive Center

3290 Lang Ranch Parkway

Thousand Oaks, CA

Saturday 10am to 10pm

Sunday 10am to 6pm

deerclan@gte.net

Info: Bob Vann (805)492-8076

May 31 - June 1, 2003

3rd Annual Honoring the Lost Nation Intertribal

Eastlake (approx 20 miles east of Cleveland)

Erie Rd & Lakeshore Blvd

Eastlake, OH

Adm: \$4 Adults. \$1 discount w/donation of canned goods or blanket. No chg for Elders or children. Drums & vendors by invitation only. Participant feed for drums, dancers, vendors and volunteers. This is a NON-PROFIT event. ALL proceeds benefit Native people!

Info: Call Bear Plummer @ 440-951-1028

June 6th - 8th, 2003

Standing Bear Powwow

Bakersfield City College

Bakersfield, CA

Host Southern Drum: Hummingbird Singers, Head Man: Henry Allen, Head Woman: Arlene Allen, MC: Saginaw Grant. Host Motel: Best Western Crystal Palace Inn (800) 424-4900 - Mention Standing Bear Powwow Admission: 4.00

Info: Gene Albitre (661) 589-8414

email: nahpc@bak.rr.com

June 7th - 8th, 2003

22nd Annual Yuba-Sutter Powwow

Marysville, CA

Info: (530)749-6196

June 7th - 8th, 2003 -- DATE CHANGE

7th Annual Multi-Cultural Youth Powwow

Pioneer Park downtown

Reedley, CA 93654

Saturday 10:00 a.m. to 9:00 p.m. Sunday 10:00 a.m. to 6:00 p.m. CONTESTS: Watermelon Eating, Cake-walk, Over \$500 in Raffle Prizes and Talent show

OPEN TO THE PUBLIC A SPECIAL INVITATION TO ALL GOURD DANCERS ALL DRUMMERS, DANCERS, & TIPIS ARE WELCOME NO DRUGS OR ALCOHOL ALLOWED ORGANIZED BY FOURWINDS LODGE FOR MORE INFORMATION CALL ONEHAWK at 559 485-5036 or 559 338-0509 fourwinds1@sbcglobal.net or onehawk@psnw.com To get to Reedley's Pioneer Park: Take highway 99 to the Manning exit just south of Fresno, then go east on Manning Ave, until you pass the Kings River bridge. At first stoplight Manning will then become "I" Street, keep going on "I" Street to 8th Street and turn left to the park. <http://fourwindslodge.tripod.com>
Info: 559 485-5036

June 13-15, 2003

3rd Annual Pow Wow
Table Mountain Pow Wow Grounds
Friant, California
Honor the Basketweavers
Northern Drum: The Boyz
Southern Drum: Bad Medicine
Drum Contest, 1st place \$2,000; 2nd place \$1,500; 3rd place \$500
Contest pow wow, food, crafts!
Info: Crystal 559-822-2890

June 13-14,2003

American Indian Cultural Association of North Carolina 25th
Van Hoy Family Campground
Union Grove, North Carolina
Traditional Powwow - Southern Protocol This is a family oriented event
For more information contact Ed de Torres- (828)464-5579, email: exdt@webtv.net
Traders contact- Karen Hoyt- (704)786-5705 email- kdh1993@yahoo.com

June 14th - 15th, 2003

7th Annual Inter-Tribal Powwow
San Luis Rey Mission Grounds
4050 Mission Ave.
Oceanside, CA
All dancers and drums welcome! Food booths, arts and crafts booths, contest dancing, opportunity drawings. Peon games at dusk!
Sponsored by the San Luis Rey Mission Indian Foundation.
Info: Carmen Mojado (760) 724-8505
email: charlotte@slrmissionindians.org

June 14th - 15th, 2003 -- DATE CORRECTION

20th Annual Indian Fair
Balboa Park
San Diego Museum of Man
1350 El Prado
San Diego, CA
Info: (619) 239-2001

June 18th, 2003

American Indian Chamber of Commerce Monthly Meeting
(every third Wednesday)

11138 Valley Mall
Suite 200
El Monte, CA
Upstairs at the Bank of America building
Meetings starts 6:30 potluck social, 7:30 call to order.
Info: (626) 442-3701 or (714) 898-6364

June 20, 21, 22, 2003

Noongam Traditional Powwow
Dow's Lake
off Carling Ave and Preston
Ottawa, ON
Grand Entries: Friday 6 p.m. Saturday 12 p.m. and 6 p.m. Sunday 12 p.m.
Giveaway 5 p.m. Feast 6 p.m. All drum groups, dancers and native vendors are
welcome. no admission fees donations welcome at the gate, everyone is welcome,
bring your lawn chairs. for more information phone (613)786-1552,
e-mail: noongampowwow@yahoo.com, website
address: www.noongam.50megs.com <http://www.noongam.50megs.com> and
email: noongampowwow@yahoo.com
Info: (613)786-1522

June 21 & 22nd, 2003

8th Annual Two Sisters Pow Wow
Regatta Field
Rte.113 Pawtucket Blvd
Lowell, Mass
Host Drum: Walking Bear Singers Hours: 10-5pm both days
ARea142385@aol.com
Info: AnnMarie 978-459-7214

June 28th - 29th, 2003

19th Annual Tehachapi - Indian Hills Powwow
Indian Hills Campground
Tehachapi, CA
Arts and crafts, food. All drums and dancers are welcome.
Info: (661) 822-1118

June 27th - 29th, 2003

2003 California Basketweavers Gathering
Yurok Tribal Lands
off Hwy 101
Klamath, CA
Info (530) 478-5660
email: ciba@ciba.org
web: www.ciba.org

June 28th - 29th, 2003

4th Annual Big Time
Lake Sonoma
Warm Springs, CA
Info: (707) 837-8596 or (707) 838-1774

July 4th - 6th, 2003

Pechanga Casino Powwow
Pechanga Casino - Activity Field
Temecula, CA
Info: (888) PECHANGA
Contest powwow, arts and crafts booths, native foods.

July 4th - 6th, 2003

Three Rivers Powwow
13505 S Union
Manteca, CA
Info: (209) 858-2421

July 11-13, 2003

19th Annual Taos Pueblo Pow Wow
Taos Pueblo, New Mexico
Taos, New Mexico
A contemporary contest pow wow held on the grassy fields a few miles from historic Taos Pueblo. Arts and crafts vendors and a wide variety of food vendors to be sampled! djlujan@laplaza.org
Info: Taos Pueblo Tourism 505-758-1028

July 12 - 13, 2003

Kateri Circle Powwow
14th Annual Powwow and Mass in honor of the Feast Day of Blessed Kateri Tekakwitha
St. Joseph High School
2825 North Woodruff Ave
Lakewood, CA
Info: (323) 724-7688; Vendors: (323) 587-2096

July 16th, 2003

American Indian Chamber of Commerce Monthly Meeting
(every third Wednesday)
11138 Valley Mall
Suite 200
El Monte, CA
Upstairs at the Bank of America building
Meetings starts 6:30 potluck social, 7:30 call to order.
Info: (626) 442-3701 or (714) 898-6364

July 17, 18, 19, 2003

Nevada Indian Days Powwow
Churchill County Fairgrounds
Scheckler Road & Hwy 95 South
Fallon, NV
Competition Dancing, Men's Fancy Spotlight Special, Princess Contest, Gourd Dancing, Native Arts & Crafts, Vendor applications please call or email.
Info: Francine Tohannie 775-427-2014 or 775-423-2949

July 18 - 20, 2003

8th Annual All Nations Powwow
Los Vaqueros Rodeo Arena
Hwy 38 off Zaca Rd.
Big Bear City, CA
Friday 6pm - 10pm, Saturday 10am - 11pm, Sunday 10am - 6pm. Admission: Age

10 and over, \$5; under 10, free; seniors, \$3.

Info: Contact Faye Roman @ 909-584-7115 or 909-790-1390

July 19th - 20th,2003

12th Annual Lake Casitas Pow Wow

Lake Casitas

Lake Casitas Recreation Area

Ojai, CA

Contest pow wow, all drums welcome, camping, fishing, boating, M.C.Tom

Phillips. Head Staff TBA

www.goldcoastfestivals.com

Admission \$10 adults, \$5 children

Info: Dick (805) 496-6036

July 25th-27th,2003

Bitterroot Valley All Nations 10th Anniversary Powwow

BMX track/ driving range

4 miles south of Victor , MT. or 4 miles N. of Hamilton, MT. right along the Lewis and Clark trail (hwy.93)

Victor, Montana

Traditional and competition dancing, first 10 drums paid. All dancers and drummers are welcome, We offer dry camping for dancers, drummers and vendors. Food vendors and native American arts and crafts market. Please call for a vendor application if you are interested in vending at our event

www.allnationsmt.homestead.com

Info: Beckie : (406) 363-5383

July 25 - 27, 2003

1st Annual Competition

La Ronge, Saskatchewan

Info: Call Rose (306) 425-2157, Doris (306) 425-3284 or Anne (306) 425-3645

July 26 - 27th, 2003

8th Annual Inter-Tribal Pow Wow

Vallejo Water Front

Mare Island Way

Vallejo, Ca

All drums and Dancers Welcome. Deadline for Vendor Apps, is July 1st, 2003.

Call 707-552-2562 for application.

rattlingleaf3juno.com

Info: 707-552-2562

[Click here for general area map of Hawaiian Gardens powwow.](#)

August 2 - 3, 2003

Hawaiian Gardens Friendship Pow Wow

Fedde Middle School (Baseball Field)

21815 Pioneer Boulevard, Hawaiian Gardens, CA 90716

When : Saturday, August 2, from 10:00 a.m. to 10:00 p.m. & Sunday, August 3, 12:00 noon to 6 p.m.

Info: Cheryl McKnight 562 981-9157

August 2, 2003

San Jose's 3rd Annual PowWow

Roosevelt Park
901 E. Santa Clara St
San Jose, Ca
KEEPING THE tRADITIONS

all drums and dancers welcome for vendors contact: Marion Linton (408)
258-6226 e-mail: cOncha47@aol.com volunteers needed for pre-event fundraiser
towards PowWow THIS IS A DRUG, TOBACCO, AND ALCOHOL FREE
EVENT!!

MC: Orvie Longhorn
AD: Gene Newman
Head man: Dale Sawyer
Head Woman: joyce Tovar
Northern drum: Mockingbird
Southern Drum: Drum & Feather
marcos_alabrava@hotmail.com
Info: Marcos (408) 244-7328

Aug. 2nd - 3rd, 2003

ALL NATIONS BIG TIME
Petaluma Adobe State Historic Park
3325 Adobe Road
Petaluma, Calif. 94954

Event starts at 10 A.M to 5 P.M both days. Fees are 16 and under Free, 17 yrs and
older \$5.00. Many arts and crafts along with a hands on children's table.
Storytelling and flute music. Local Pomo Indian dancers, Sierra Maidu dancers and
the Willow Creek dancers. Food and drinks to buy. Call Petaluma Adobe for dance
schedules and all other info.
Info: 707-762-4871

August 7 - 9, 2003

siksika fair
siksika nation/THA FLATS
siksika alberta
siksika alberta canada

2003 siksika nation is more then welcome to invite you to our blackfoot nations
fair also known as the siksika nation powwow. There is going to be people from all
over the world and also VERY BIG prizes for the competitions as up too 500 to
600 for the for the dancers and 700 to 5000 for the drum groups or possibly
more. and there is also going to be rodio/handgames/specials/and rides so why dont
you come check this one out and lets all have a great time.
Info: (1403)870-9802

August 9th - 10th, 2003 ** NOTE DATE CHANGE **

8th Annual Big Time
Shingle Springs Rancheria
Hwy 50 east of Sacramento
Shingle Springs, CA
Free and open the public. Native dancers, vendors
Info: (530) 391-2540

August 16th - 17th, 2003

Thunder Motain Lenape Nation 5th Annual Native Ameican Festival
Saltsburg, PA
Join us for a Cultural Heritage Experience Proceeds Benefit Thunder Mountain
Programs & Land Purchase Grand Entry Noon both days-Dancing until 5 p.m.

Shop for Unique Gifts & Collectibles: Native Arts & Crafts Hear, See, Experience:
Traditional Drumming, Dancing & Singing Treat Your Tastebuds: Native Foods
Have Fun: Children's Activities & Dances, Public Participation Dances,
Storytelling Learn- Native American Heritage: Hands-on Living History Area with
Wigwams, Tipi, Reproduction Artifacts, Garden
thundermountain@questpublish.com www.questpublish.com/thundermountain
Info: Call Pat (724)-459-5276

August 20th, 2003

American Indian Chamber of Commerce Monthly Meeting
(every third Wednesday)
11138 Valley Mall
Suite 200
El Monte, CA
Upstairs at the Bank of America building
Meetings starts 6:30 potluck social, 7:30 call to order.
Info: (626) 442-3701 or (714) 898-6364

August 22nd - 24th, 2003

34th Annual Southern California Indian Center Powwow
Orange County Fairgrounds
Fair Drive
Costa Mesa, CA
Info: (714) 962-6673
email: scicgg@indiancenter.net
web: <http://www.indiancenter.net>

Aug 23 - 24, 2003

Honoring our Children Powwow
Ann Leavenworth Elementary School
4420 E Thomas
Fresno, CA
Cedar & Belmont, 1 block south of Hwy 180
Info: (559) 270-0649; vendors: (209) 477-5383

August 29th - 31st, 2003

Barona Powwow
Barona Ball Field, past Barona Casino
Lakeside, CA
Contest dancing, food booths, craft booths, camping
Info: (619) 561-5560

August 29 - 31, 2003

22nd Annual Stockton Labor Day PowWow
New Location: Edison High School, Soccer Field
1425 South Center Street
Stockton, California
"Honoring Our Native Traditions"

All drums & dancers welcome, contest dancing camping available free & open to
the public raffles & 50/50 drawings open gourd security provided THIS IS A
DRUG AND ALCOHOL FREE EVENT!! NOT RESPONSIBLE FOR LOST
ITEMS, PEOPLE, OR TRANSPORTATION COSTS
host northern drum: Painted Rock singerz
host southern drum: Hummingbird singers
master of ceremonies: tba

arena director: J R Manuel
head man dancer: Gary Middlerider Jr
head woman dancer: Rhiamreah Yazzie
head teen boy dancer: Frank Teller Jr
head teen girl dancer: Jeannette TwoBears Jimenez
specialty dancers: Grindstone dancers
e-mail: twolegsx2@yahoo.com
Info: Julie Jimenez (209) 477-5383

September 5th - 7th, 2003

Sycuan Pow Wow
Sycuan Reservation
Alpine, CA
Contest dancing, food booths, craft booths, camping
Info: (619) 445-7776

Sept 6th -7th 2003

7th annual Traditional family Pow-wow
Lake Silverwood, Black Oak area
Highway 138
Hesperia, Ca
Saturday 12:00pm -9:00pm. Grand entry 12:00 noon. Dinner break 5:30, grand
entry 6:30pm Sunday 12:00pm-7:00pm. Grand entry 12:00 noon..This a family
event and we strongly encourage our young dancers. All drums, dancers and public
welcome!! Head staff TBA. Specials TBA
Info: (909) 887-6006

Sept. 6th - 7th, 2003

4th Annual Whispering 4 Winds Inter-Tribal People's Gathering
14243 Lynn Rd
Apple Valley, Calif.
Saturday 6th: 10am to 7pm Sunday 7th: 10am to 6pm
All drums and Dancers are welcome Public Welcome with fun for the entire
family. Gate Donation: \$1.00 per person children 10 and under free with a
non-perishable food item for our community pantry.
moonspirit94 @msn.com or mtnrose072002@yahoo.com
Info: Dee 760)247-9696 or Rosemary 760) 961-2181

Sept 13 - 14, 2003

Santa Ynez Powwow
Live Oak Campground
North of Santa Barbara, just south of Lake Cachuma
Santa Ynez, CA
Info: (805) 688-7997

September 13th - 14th, 2003

9th Annual Precious Sunset Pow-wow
Recreation Point
Bass Lake
Bass Lake, CA
Arts and crafts, food, hand drum contest, princess contest, team dancing contest.
Camping available. MC: Wallace Coffey; Arena Director: Art Martinez.
Info: (559) 855-2705; fax: (559) 855-2695

September 17th, 2003

American Indian Chamber of Commerce Monthly Meeting
(every third Wednesday)
11138 Valley Mall
Suite 200
El Monte, CA
Upstairs at the Bank of America building
Meetings starts 6:30 potluck social, 7:30 call to order.
Info: (626) 442-3701 or (714) 898-6364

Sept 19 - 21, 2003

7th Annual Soboba Powwow
Soboba Casino
San Jacinto, CA

Contest Dancing, All Categories (some will be combined), Raffle grand prize: \$5,000, Spectator raffle \$1,000 per day. Drum contest: \$6,000 1st - \$3,000 4th -- Separate categories for northern and southern. \$200 to first 10 drums to register, \$1,000 split for non-placing drums. Free swimming, free camping, open to the public. Welcome all drums, gourd dancers, bird singers, peon teams.
Info: (909) 654-2765

September 19-21, 2003

4th annual competition pow wow
Moosomin Arena
Box 98, Cochin, Sask.
Cochin, Sask, CANADA

located 20 miles north of North Battleford Sask. Over \$35,000.00 prize payouts.
Info: Lena or Bernadine at 1-306-386-2223

Sept 20 - 21, 2003

15th "Everything is Sacred Pow Wow Gathering"

Borchard Park

190 No. Reino Rd.

Thousand Oaks, CA

MC, Brian Brightcloud, Headman Anthony Sanchez, Host Drum-Stronghold Singers-Cree Nation, Lead Singer-Val Shadowhawk, Honored Guest-Mr. Joe Morris, Sr. Navaho Code Talker, Arena Director, Dean Webster, Chicken Dance Contest-Winner takes all!

Free Admission & Parking. More to be announced.

<http://everythingissacred.com>

Info: Call Richard (805) 493-2863

September 27-28

10th annual american indian pow wow & craft fair

William S. Hart County Park

24151 N. San Fernando Rd.

New Hall California

Princes contest ages 15-21

Honoring our Elders

M.C: Michael Aviles-S.Piaute/Shoshone

Arena Director: Victor Chavez-Dine

Head man: Randy Flokes (Tataviam Fernandeno/Paiute/shoshone)

Head woman:Nalin Zazueta-Flores (Yaqui/Tarahumara-Azteca)

Head young man:Jose Little Owl (Mohawk)

Head young Lady: Cathy Hummingbird Jemenez (Shoshone/Gabrieleno/Apache)

Head Gourd: Alex Villalva (Pima)

Northern Host Drum: Four Corners
Southern Host Drum: Rainy Mountain
Info: Mary Schultz (661) - 255 - 9255

September 26, 27 and 28

Bishop Paiute Tribe Annual Handgame Tournament
Tribal Gym
390 North Barlow lane
Bishop CA

All Handgame Players are welcome to come and compete for the guaranteed cash and bragging rights for your tribe, last years reigning champs were the Fish Lake Shoshones, This year will host yet another True Double Elimination, \$175 entry fee per team, 2 to 5 players per team, www.paiute.com
Info: (760) 872-1823

Sept 26 - 29, 2003

Thunder and Lightning Powwow
Casino Morongo
(off 10 fwy)
Cabazon, CA
Info: (800) 252-4499

Sept 27, 2003

NAHC Powwow
Sponsored by The Native American Health Center
Head Royce School
Oakland, CA
11am - 8pm
Contest Dancing
Info: Cathy (510) 535-4460 x 495, Lisa (510) 535-4462. Vendors call Brandon (510) 535-4492 x 157

Sept 27, 2003

American Indian Day Gathering and Picnic
Whittier Narrows Regional Park
South El Monte
Community picnic celebrating American Indian Day in Los Angeles. Family fun, games, music, food, and traditional events provided by UAII Circles of Care.
For more info: americanindianday.com or www.laindianhealth.com
Info: 213-481-2194

September, 26, 27, & 28, 2003

Tule River Band of Yokuts Present Porterville Pow-wow 2003
Porterville Fairgrounds
300 East Olive
Porterville, CA 93257
Over \$20,000 In Prize Money, Dance Competition in all catagories, Cultural Demonstrations, Gourd Dancing, Craft & Food Booths, and Drum Competition.
Vendor and Food Booths still avilable, contact Alison Hunter @ 559-788-6220 ext. 242
Admission \$3.00-Adults, 12 and under free.
Grand Entry starting Friday @ 6pm
Sat. @ 1pm & 7pn
Sun. @ 9am
limited camping on site

Sponsored By: Tule River Tribal Council, Eagle Mountain Casino, Owens Valley Career Development Center, City of Porterville, Porterville Unified School District, Porterville Chamber of Commerce
Info: Tule River Tribe, 559-781-4271

September 26, 2003

23rd Annual Health Fair

Round Valley Indian Health Center,
Hwy 162 & Biggar Lane
Covelo, California

7:30 AM Free Registration Walk/Run

8:00 AM Walk/Run (Free t-shirts to participants) Health Fair officially opens

10:00AM to 3:00 PM Free Admission Special Guest Speaker: Sonny Landham

from the Movie "Predator" Traditional Dancers, Musical guests, Chicken/Steak

BBQ \$2 adult \$1 child, vegetarian options available. Senior Bingo, Games and

demonstrations, informational health, safety and prevention booths. Free Samples

This year we are celebrating 35 years of health services to our community, and

honoring our elders. This is an Alcohol Drug free event. Come and enjoy the day

with us. E-mail: janscribner@hotmail.com Info: Call Jan Scribner @ 707 983-6404

Ext 120

Oct 4 - 5, 2003

4th Annual Intertribal Powwow of The Eagle, Honoring Our Elders

Lancaster Park

Lancaster, CA

Info: Richard Cano (661) 435-0423

Oct 10 - 12, 2003

San Manuel Powwow

Cal State University San Bernardino

San Bernardino, CA

Info: (909) 864-8933; Vendors: (909) 880-3938

October 10th - 12th, 2003

5th Annual Northern Lights Casino Thanksgiving Powwow

Prince Albert Communiplex

Prince Albert, Saskatchewan

Info: (306) 764-4777

Email: nlchampionship2k3@hotmail.com

Website: <http://www.siga.sk.ca/NorthernLights/AboutUS.aspx>

Oct. 11-12, 2003

1st Annual Native American Intertribal Fellowship Powwow

William Carey International University

1539 E. Howard

Pasadena, CA

Info: Bryan BrightCloud 818/870-0000

Oct 17 - 19, 2003

Indio Powwow

Cabazon Powwow Grounds

Fantasy Springs Casino

Indio, CA

Info: (800) 827-2946 x 3017

Oct 18 - 19, 2003

10th Annual Gathering of Nations Powwow
Sponsored by Four Winds Inter-Tribal Council of Indian Wells Valley
Freedom Park
100 West California Street
Ridgecrest, CA
Competition dancing, \$3500 total pot, Dancers must be registered by 11am
Saturday
Info: Max Yarbrough (760) 446-4749 or Chris Hunter (760) 375-3402

October 18th, 2003

Third Annual Native California Peoples FALL GATHERING
San Luis Creek Recreation Area
Highway 152, 27 miles east of Gilroy and 15 miles west of Los Banos
Los Banos, California
10 a.m. - 9 p.m. Only fee=\$4 State Park Day Use Fee per Car. See on-going
demonstrations of how to make: baskets, fire, shell necklaces, soaproot brushes,
how to cook acorn porridge in a basket with hot rocks, and more. Featuring
California Indian Dancers, traditional Storytellers, traditional games, and a tule
boat race.
Eat Indian tacos or hamburgers and check out the Indian arts and crafts.
www.mutsunlanguage.com www.parks.ca.gov/events
Info: Jennifer (209) 826-1196 ext, 534

Oct 25, 2003

Haramokngna Hike-a-thon
Haramokngna Indian Cultural Center
Angeles Crest Highway and Mt. Wilson Rd in the Angeles National Forest
La Canada, CA
9AM to 1PM FREE to the public.
Join us to hike the mountain and raise funds for the Haramokngna history exhibit,
demonstration Gathering camp, and Ethnobotanic garden. Prizes, games, fun, and
more.
katcalls@aol.com
Info: Call Kat at 310 455-1588

October 25, 2003

1st American Indian Pow Wow
Faulkner Park
3 mi. North of Lindale
Lindale, Texas
Update Date has changed. from 10/11/03 to 10/25/03. Electricity is available
around Pavilion only so Food Vendors will be limited. Spaces with electricity
\$45.00 without electric \$40.00. Those needing power bring heavy duty extension
cords. Wooded area with small lake, camping allowed. Our people will provide
security. Contact Louise Bailey m.l.bailey@prodigy.net or Pat Barbour
cheroke2@earthlink.net
Info: 903 882 8380

Oct 25-26, 2003

The Fresno Powwow has been cancelled

Fresno State Pow-wow
O'neil park on campus
5241 N Maple Ave

Fresno, Ca.
www.fourwindslodge.com
Info: 559-485-5036

October 24th-25th, 2003

This event has changed to a California Indian Big Time, Friday and Saturday only

Festival of the American Indian Powwow
Placerville, California
(530) 647-0423

The Santa Fe Springs Powwow at Herritage Park is not being held this year.

November 8th - 9th, 2003

2nd Annual Veterans Gathering
Presented by NAVA - Native American Veteran Association
Legg Lake
Whittier Narrows Regional Park
(exit Santa Anita off 60 Fwy)
South El Monte, CA
Info: Mary Iron Elk (562) 984-5711 or Ron Blackwood (562) 925-7145

November 8 & 9, 2003

9th Annual Many Birds Pow Wow
Wickerd Farm
26852 Scott Road
Menifee Valley, CA 92584
"Bringing the People Back Together"
MC- Randy Pico, Luiseno
ND-Dancing Cloud SD- Strictly Southern; AD- James Red Bear, Oglala Lakota'
Whipman- Ral Christman, Kumeyaay; HMD- Frank Eagle Plume, Yaqui; HWD-
Jennifer Skyfeather, Aztlan; HYMD- Tyler; HYWD- Tekla Diaz, Luiseno; HG-
Jerry Wilkerson, Cherokee/Choctaw; SA- Clay Two Bears, Oglala Lakota
ALL DRUMS, DANCERS & LODGES WELCOME; Traditional Style - No
Contest Dancing; Tipi Village, Arts & Crafts; NO ADMISSION FEE, Parking is
\$4 w/ raffle ticket, bring your own chairs and shade!
Info: Julie Wickerd - 909-672-3020

November 7th - 9th, 2003

2003 INTERTRIBAL MARKETPLACE

Traditional and Contemporary
American Indian Art Show

Friday, November 7 (Members Only) 6:00 to 9:00 p.m.

Saturday, November 8 (General Public) 10:00 a.m. to 6:00 p.m.

Sunday, November 9 (General Public) 10:00 a.m. to 5:00 p.m.

Southwest Museum Grounds

Los Angeles, CA

AMERICAN INDIAN ARTISTS MENTOR PROGRAM: Making Storytellers
with Barbara Moranda, Laguna Pueblo

Join us in a fun-filled weekend created to celebrate National American Indian
Heritage Month. The 2003 Intertribal Marketplace offers our guests one of the
most unique events in Southern California. Over 100 nationally recognized
American Indian and Canadian First Nation's artists will sell and display their

work. Spend time with Featured Artist, Jimmy "Ca Win" Calabaza. Enjoy live music, dance, storytelling, gourmet food, and artist demonstrations while the children create their own works of art in the Children's Craft Village. Parking is available along Marmion Way or take the new Gold Line and exit at the Southwest Museum stop.

Admission: \$8.00 for adults; \$6.00 for seniors and students; children 6 and under are free. Show your Gold Line stub and receive \$1.00 off your paid admission.

Info: 323-221-2164

Nov. 8, 2003

2nd Annual CIEA CVChapter/UC Merced Education Benefit PowWow
Yosemite Lake

Yosemite Lake Park, Lake Road

Merced, CA

The Central Valley Chapter of CIEA and UC Merced present the CIEA
CENTRAL VALLEY CHAPTER/UC MERCED SECOND ANNUAL
EDUCATION BENEFIT POWWOW

"Youth: Achievement through Native American Indian Education"

A Native American Indian festival, gathering, and celebration

10 AM to 10 PM

FREE ADMISSION PUBLIC INVITED

HEAD STAFF:Northern Host Drum- Jest 4 Fun,Southern Host Drum-
Hummingbird Singers, MC- Val Shadowhawk, Whip Man/Arena Director- David
Wilson, Jr.,

Head Woman Dancer- Eileen Boughton,Head Man Dancer: Razzle Dazzle, Head
Girl Dancer: Jeannette "Two Bears" Jimenez, Head Boy Dancer: John "Li'l Bear"
De Anda, Jr.

Open Gourd All Drums Welcome

FREE PARKING

Authentic Native American Indian Arts, Crafts, and Jewelry,Raffle Prizes, 50/50,
Specialty Dances and Performances, Authentic Native American Indian Cuisine
Traditional Meal

Youth Activities Village

THIS IS DEFINITELY A DRUG-FREE AND ALCOHOL-FREE EVENT

Directions: Highway 99to Merced, X-it Highway 59 North, to Belleview (R.),
Lake Road (L.) to PowWow.

cieacvchapter@hotmail.com

Info: Mike at 209.726.9620

November 14, 2003

Native Voices at the Autry Theatre Festival: Standing Up Stories by Julie
Pearson-Little Thunder (Creek)

Los Angeles, California.

Directed by Marie Clements (Metis) 8:00 p.m. This family play explores how
Indian women extend their families by taking other women to be their adopted
relatives. The usually informal process of intertribal adoption is a lifelong
commitment to be there for the adopted relative, sharing the duties as well the
privileges of a family member. The stories include a young professional woman's
relationship with her adoptive Yuchi grandmother, a Cheyenne woman who
rescues her adopted niece from an abusive relationship, and a Cherokee language
class, the night after 9/11. Wells Fargo Theatre Autry Museum of Western
Heritage 4700 Western Heritage Way Los Angeles, CA 90027 (323) 667-2000
These staged readings are free in the Autry Museum's Wells Fargo Theatre.
Reservations are strongly recommended. To RSVP, please call 323.667.2000 ext.

354. Native Voices at the Autry is devoted to developing new works for the stage by Native Americans and is made possible in part by grants from Wells Fargo, the City of Los Angeles Cultural Affairs Department, the Los Angeles County Arts Commission, the National Endowment for the Arts, JPMorganChase, and the Sidney Stern Memorial Trust.

Info: www.autry-museum.org, (323) 667-2000

November 15th, 2003

A Gathering of California's Natives

Cal Poly Pomona Campus

3801 W Temple Ave

Pomona CA

57 South from 10, exit Temple

Noon—11pm

Free Admission

Noon—5pm, specialty and tribal dancing, storytelling

5-11pm California Bird Singes and Dancers

Feed for all participates

Parking is \$4, admission is free

Info (909) 869-6877

November 15th—16th, 2003

1st Annual Veteran's Powwow

11201 Benton St

Loma Linda, CA

All veterans encouraged to attend, special honoring of women veterans.

Sat: 10am—10pm, Sun 10am—6pm

Info: Anna (909) 825-7084 x 2173 (after 4pm), Denise (909) 825-7084 x 2095 (before 4pm)

Vendors call Mary (562) 972-1140 after 9pm.

November 22nd - 23rd, 2003

High Desert Intertribal Gathering

OCB Trading Post will be there! Get a copy of the Tracker powwow list while supplies last. Kennedy Middle School

1000 Armory Rd

Barstow, CA

Spiritual Advisor: Robert Jacobo Sr, MC: Mike Martinez, Arena Director: Larry

Garcia, Head Man: Robert Jacobo Jr., Headwoman: Arlene Allen, Head Gourd

Dancer: Tom Gamboa. Northern Host: White Cloud Singers, Southern Host: Hale and Co.

Gourd Dance 11am, Grand entry 1pm

Info: Dave (760) 985-5649 or Larry and Kay (760) 256-2983

November 28th - 30th, 2003

O'odam Thanksgiving Powwow

Casa Grande, AZ

MC : Roy Track; Northern Drum: Short Bull, Southern Drum: Dark Horse w/ Sony Deere

Sat: 10am Open Gourd, noon Grand Entry, 9pm Retire colors — Sun: 10am Open Gourd, noon Grand Entry, 9pm Retire Colors

Info: (520) 418-3007 or (520) 836-4723 — Venders (520) 418-3007

November 29-30, 2003

Whaka Hey Native American Craft Show

5633 Ethel Way
Sacramento, CA
HOURS 10am-5pm SAT 10am-4pm SUN
HELD IN DOORS** RAIN OR SHINE** FREE HOURLY DOOR PRIZES,
FREE PENDLETON RAFFLE. ITEMS FOR SALE INCLUDE CLAY DOLLS,
BEADWORK, HAND PAINTED CHRISTMAS ORNAMENTS, BEADS,
SHELL JEWELRY AND MUCH MUCH MORE. seaflowerHIGH@aol.com
Info: CALL LILLIAN 916-422-0469

December 6th - 7th, 2003

Fedde Middle School
Baseball Field
21409 S Elaine Ave
Hawaiian Gardens, CA
Sat 10am-10pm, Sun 10am-6pm
605 Fwy to Hawaiian Gardens exit (Lincoln/Carson Exit), East to Pioneer Blvd;
turn left (north) for one block then right on 215th. Right behind Hawaiian Gardens
casino.
Info: (562) 420-2641 x215
Vendors: Cheryl (562) 981-9157

December 6th, 2003

Second Annual NACC Powwow
Santa Rosa, California.
Info: (707) 544-3244.

December 6th, 2003

Fifth Annual Holiday Powwow
Oakland, California.
Info: (510) 208-1870.

December 12 - 14, 2003

29 Palms Band of Mission Indians December Powwow
Trump 29 Casino
Indio, CA
Info: (760) 775-3239

December 20th-21st, 2003

Shane Zotigh Memorial Powwow and Christmas Celebration
Dear Friends,

We regret to inform you that due to unforeseen circumstances, the Shane D. Zotigh
Memorial Powwow and Christmas Celebration, sponsored by Prayer House
Outreach, has been postponed to a later date. Vendors' fees will be returned and all
funds raised and toys procured will be held in trust and will remain allocated for
the powwow only. We sincerely apologize for any inconvenience caused and will
announce updated powwow information as soon as possible.

Yours Truly,
Asani Charles
PHO Board Member
www.geocities.com/phopowwow/christmas

December 20th, 2003

23rd Annual Community Christmas Powwow
Eagle Rock Recreation Center

1100 Eagle Vista Dr.
Eagle Rock, Ca
2pm-11pm; Gourd Dance at 2pm, Grand Entry at 6pm
Info: (626) 448-5661 or (626) 482-3549

December 20th—21st, 2003
Pre-Christmas Arts & Crafts Sale
Casa Grande, AZ
Info: (520) 418-3007 or (520) 836-4723 — Venders (520) 418-3007

[Top of Page](#)

All information copyright 2000-2003 by OCB Tracker and by others as appropriate. All rights reserved. Re-transmission, re-printing or re-publication of the pages, designs, styles and information prohibited. These pages may not be framed by another site without permission in writing and payment of appropriate licensing fees.



Site design, creation, and long nights by Kingu

CONTENTS

[Archaeology](#)

[Cowboys](#)

[Critters](#)

[Emigration](#)

[Events](#)

[Expansion](#)

[Films](#)

["Indians"](#)

[Mining](#)

[Outlaws](#)

[Pioneers](#)

[Places](#)

[Research](#)

[Trading Post](#)

[Transportation](#)

THE AMERICAN WEST

A CELEBRATION OF THE HUMAN SPIRIT...

*We are all Pioneers . . .
. . . Pathfinders on the Trails of Old and New Frontiers . . .*

A Presentation of the History and Development of the American West!

Western Gift Ideas



Within these pages you will find the History and Development of the American West, from the Frontier and Pioneer days of the Wild West, to today's Modern West.

Featuring: Westward Expansion, Western Trails, America's Freedom Documents, Cowboys, Indians, Native Americans, Pioneers, Trappers, Scouts, Gunslingers (*the whole dang blang shootin' match is heah, bucko!*), Outlaws, Gunbattles, Ghost Towns,



Gold & Silver Mining, Saloons, Dodge City, Tombstone, O.K. Corral, Virginia City, Doc Holliday, Kit Carson, Wyatt Earp, Wild Bill Hickok, Davy Crocket, Daniel Boone, Billy the Kid, Jesse James, Buffalo Bill, Sitting Bull, Roy Rogers, Western Theme Parks, Museums and Exhibitions, the Prairie, Buffalo, Horses, Rodeos, Stage Coaches, Frontier Railroads, River Steam Boats, and anything of interest or of significance west of the Mississippi River. We carry a lot of links to other major high quality western-type web sites.



Search AmericanWest for a topic.

A special segment of this site is devoted to the [Modern West](#) with emphasis on the Information Society, including . . .

THE NEXT FRONTIER - The Wonders of the Universe!



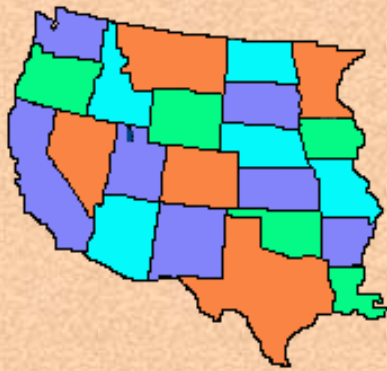

...Definition of The West:
....These are the 22 Western States
.... that form the American West
....(west of the Mississippi River).



AmericanWest AWARDS.

Our Banner Exchange page.

Stories by AW's Visitors.

Reviews and Comments from visitors to the site.

Upcoming Events

● American Westward Expansion

Includes maps of the Lewis & Clark Expedition, the Santa Fe Trail, the Oregon Trail, the Mormon Pioneer Trail, the Pony Express Route, the Overland Trail and Key Dates of Expansion. A story on frontier transportation explains the important role of the transcontinental railroad and the railroad companies.

● Native American Tribes and Nations Native Americans' "CENTER OF THE UNIVERSE", your one-stop source for in-depth and extensive information on Native Americans, covering the past, the present and the future. There are also stories on famous Indian Chiefs and many 19th century pictures. Many Home Pages for Native American Nations, Organizations, Institutions and Individuals. Many information sources are from the Government and there are possibilities to contact Representatives directly via email.

● European Emigration

As an example of European mass emigration to America propelling the expansion westward during the 19th century, the Swedish case is rather typical. Explained are the reasons for leaving the *old country* and what the Swedes could expect to find in the *new country*. There is also a story of Bengt Lindeblad's (the originator of this site) own emigration experiences about 100 years later. Many pictures and many links to other information sources.

● Gunslingers and Outlaws

From Doc Holliday, Wild Bill Hickok, and Jesse James to Butch Cassidy and the Sundance Kid. Some famous Gunbattles.

...THE WHOLE DANG BLANG SHOOTIN' MATCH IS HEAH, BUCKO!

● Pioneer Towns, Forts and Other Places

The Alamo. Pioneer towns such as Tombstone, Virginia City and Carson City, and Dodge City are featured as well as ghost towns Like Bodie, CA and Jerome AZ. Plenty on the Black Hills and Deadwood, South Dakota, too.

● [Western Pioneers, Frontiersmen, Mountain Men and Fur Traders](#)

Buffalo Bill, Davy Crockett, Daniel Boone, James Bowie, Kit Carson and other well-known Westerners.

● [Women of the West Museum](#)

● [Women of the West](#) and life on the Plains.

● [Susan LaFlesche Picotte](#) and life on the Plains.

A new section (suggestions are encouraged!): Science in the 19th century

● [The Progress of Medicine in the 1800's](#)

● [Nikola Tesla](#)

● [Thomas Edison in Menlo Park](#)

● [Medicine in the Civil War](#)

● [Scientific Medicine](#)

● [Florence Nightingale](#)

● [Smithsonian - Power Machinery](#)

● [American Archaeology](#)

● [Cowboys](#)

Here you can round-up all the information you'll ever need about Cowboys.

● [CowboyPoetry.com](#) Here at CowboyPoetry.com we have the internet's largest collection of Cowboy Poetry. Among other honors, we've been recognized as a "hot site" by USA Today, a "preferred site" by Read the West, and featured as the "Best of the West" site at The Wyoming Companion. Our site gets updated with new poetry twice monthly, and each update is accompanied by an email newsletter to our many visitors.

● [Cowboy Poetry](#)

● [Western Music](#)

Images From The Old West

● [Searchable database](#) of images, U. of Nebraska Press

● [WESTERN FILMS](#)

● Rattlesnake Jack's [Old West Clip Art Parlour](#) and Emporium.

● [Selected Images](#) From the National Archives.

● [The National Park Service](#)

Our collected heritage, including archeology, historic places, structures, landscapes and museums. An excellent way to get involved in our heritage !!

● [Wells Fargo Museum](#)

Wells Fargo Bank has a web-site with much material on the Old West. Let's start at their Museum.

● [Buffalo - and other animals](#)

Buffalos once roamed from Canada to Mexico and all over the American plains in very large numbers. Buffalos were also the center of life for the plains tribes of Native Americans, providing them with food, shelter, clothing and spiritual inspiration.

● [Research Areas](#)

A tremendous amount of historical information about the American West.

● [Contribution from Schools to the American West](#)

Schools and students studying the History and Development of the American West are welcome to contribute stories and graphics to this section through their web-site (we will link up to it free of charge, in return we hope you will establish a link to our site providing that the same high standard is applied to the contributed material). See our first contributions. We are also adding links that could be useful to teachers and students.

● [America's Freedom Documents](#)

The migration westward was driven by the pursuit of happiness, liberty, freedom and justice. Here is a fantastic link to the very documents that "We the People" had agreed upon to help facilitate our goals.

● [The American Revolution](#)

This site contains a complete American history, from the colonial period until modern times, including westward expansion.

● [Academy of Achievement](#)

Brings you face to face with the extraordinary individuals who have shaped the twentieth century. It is an amazing collection, not of mere artifacts, but of people and ideas that fill you with inspiration, encouragement, and the will to achieve.



● [The Modern West](#)

- Libraries
- New Exciting Aquariums
- The World's Largest Mall
Over 800 stores and services, as large as 48 city blocks and a hotel in the mall.
- **THE NEXT FRONTIER...**
The Wonders of the Universe



The banner features a blue background with a white speech bubble. On the left is the LinkExchange logo (a blue square with 'LE' in white). In the center is a cartoon illustration of a man in a suit and tie, pointing towards the text. The text inside the speech bubble reads "PROMOTE YOUR SITE FOR FREE". To the right of the speech bubble is the LinkExchange logo with a trademark symbol. Below the logo is a small button that says "Click Here". At the bottom of the banner, it says "Member of the Internet Link Exchange".

Please view the [Personal Homepage](#) of the late [Bengt Lindeblad](#)
a Swedish immigrant ([his story](#)) and the CREATOR of AmericanWest.com!



The American West Home Page is continuously being updated. If you need to get in touch with our office to contribute facts, stories and images or you are interested in advertising on the American West server, you can E-mail us at the following link:



Webmaster@AmericanWest.com

PLEASE NOTE: Due to the amount of e-mail that we receive, we are unable to respond to individual requests for information pertaining to information not included on our web site.

OUR LINK POLICY is: if your web site presents a western theme and is a non-profit organization then the linkage is free of charge and it should be reciprocal. All other web site categories wanting a link will be considered as paid advertising.

PLEASE REPORT any broken links that you might find to Webmaster (including the URL the link appeared on). We maintain so many links that it is difficult to monitor them all on a regular basis. Thank you.

Merchants and manufacturers may want to [contact us](#) as an outlet for their western theme products.
Check out the AmericanWest [Trading Post](#).



Fc 4480989 LE FastCounter

Copyright © 2003 AmericanWest.Com--All Rights Reserved

THE JEFF DAVIS SHOW

Austin, Texas



Hello -- my name is Jeff Davis, I have been involved in the freedom movement since 1990. We at The Jeff Davis Show have made a commitment to restore America back to a land of real freedom - not the illusion of freedom spoon fed by the power Elite. It is a big job, never in history have so many resources been pitted against a people yearning to be free. Many do not realize the fact- they are not free. This is our battleground. We are battling a system of mind control, which can only be defeated by the truth. This is our mission at The Jeff Davis Show. We refuse to stop, in fact over the next year we will be bringing incredible truth information to the people, that cannot be disputed.

We also believe that freedom can be restored. Remember Rome and Babylon both fell. We ask that you give up on your Establishment rag paper and send the savings to us. Just \$10.00 a month, goes a long way when you are spreading truth. Purchase our television show video's- they are good and non- copyrighted. If you have a business or know someone who does, you can advertise with us ! The folks who help our efforts- we will work hard for them. My personal Guarantee !! Our enemies spend vast resources - attempting to keep people dumbed-down and diverted. However, when the truth about the establishment lies are revealed, it doesn't take much for eyes to be opened. I know this first hand- ten years ago, I was your average brainwashed sheep.

I do this not for fame or fortune -- only for freedom, if not for me, then for our children and grandchildren. Thank you for your prayers and support.

God Bless us all !!

You can send donations to:

" The Jeff Davis Show"

PO Box 200357

Austin, Texas 78720

Thank you for visiting and your interest in our efforts

POWERFUL INFORMATION !!

"The Jeff Davis Show" has for many years provided high quality and very informative Television programs

Below are some of the best!!!

1. "The Destruction of America"

The world famous 90-minute presentation by host Jeff Davis. A powerful explanation of the various mechanisms employed by the globalists, including diversions, distractions, the Hegelian dialectic, and psychological warfare. This documentary puts all the pieces of the puzzle together. Who the rulers are, what are their goals, origins and a list of various control factions. Comments from viewers have included "a

Masterpiece of information." A MUST SEE for all people of the world !!

\$20.00

Also available on audio cassette -- \$ 7.00

2. "Justice for the Davidians"

A 2-hour interview with Waco survivors Katherine Matteson, Clive and Edna Doyle. A powerful indictment of the de facto government's Multi Jurisdictional Task Forces. Includes exclusive footage, compiled from independent sources.

\$20.00

3. "Richard McLaren and Richard Keyes interview"

Possibly the last live interviews with these Republic of Texas members from their respective jails. Very interesting: much different information than the establishment media released. A truthful presentation by forgotten P.O.W's.

\$20.00

Special Offer: Any two videos for \$35.00 or all three for \$50.00 Please allow 2-3 weeks for delivery.

In addition to these videos, we will be making cassette tapes and other information available by request.

NEW!! Books by Author Texe Marrs, founder of Living Truth Ministries

1. "Circle of Intrigue"

Cloaked in mystery and shrouded in secrecy, ten ruthless men comprise the "Inner Circle" of the Illuminati conspiracy. This book reveals the shocking truth about their plans for global conquest.

\$15.00

2. "Project Lucid"

The nightmarish reality of the 666 Universal Human Control System.

Using massively powerful computer databases linked to surveillance mechanisms, the "Mark of the Beast" system which the slave masters intend to become a reality looms in the distance unless stopped. A powerful wake-up call for the information age.

\$15.00

3. "Big Sister is Watching You"

What do you really know about Hillary Clinton and The White House Feminists who now propagate the U.S. Government? The

real truth is revealed in this shocking book.

\$12.00

*New !! Book --- Common Sense --An Introduction to the
New World Order*

Written by former Austin, Texas city Council member George
Humphrey

\$ 5.00

**Please make check or money order
payable to:**

"The Jeff Davis Show"

P.O.Box 200357 Austin, Texas 78720

**When contacting us, please request a free copy of our monthly
newsletter.**

[Back to Main Page](#)



- [MAIN INDEX](#)
- [ACTIVITIES](#)
- [ARTICLES](#)
- [BOOKS](#)
- [CAVING](#)
- [CLIMBING](#)
- [CYCLING](#)
- [LINKS](#)

Fc 149768

visits to this page since 2nd June '98

Published by



Web Design

Send in your suggestions and enquiries to tom@woms.com



Dedicated to the world of outdoor sports and activities, travel and adventure.

[Information about W-O-W and how you can advertise on these pages!](#)

££ \$\$ ££ \$\$

Join our mailing list to receive details of exclusive competitions run by w-o-w.com. Only subscribers to this list can enter, and there will be a new competition every few weeks. You will also receive updates on new features and special offers.

Enter your email address below then click the join button:

NEW Virtual Tours!

Go climbing from your desktop!



[Lucido cool light - LED torches & head torches and](#)



[View Our Guestbook](#)

Please take a moment to [Sign Our Guestbook](#) You can leave information for other visitors to view.



Visit [NW Bouldering](#) for all the latest info, pictures and topos for bouldering in the North West

Web sites produced and/or promoted by www.w-o-w.com

- [Mountain Film Festival UK](#)
- [British Mountain Guides](#)
- [High Exposure - mountain film services](#)
- [Carradice Bike Bags/Cycle Gear](#)
- [Martin Moran - Mountain Activities](#)
- [Pyrenees Bike Tours](#)
- [Highland Hostels \(Scotland\)](#)
- [Summitreks, Cumbria - UK activities](#)
- [Chinaholidays.com](#) - Specialist tours
- [Mountain Experience](#) - Guiding and adventure
- [Snowgoose mountain centre](#) Scotland
- [UK Survival School](#) UK and World Wide survival courses
- [bhlc.org.uk](#) British Hill walking Leaders Certificate
- [Phoenix Walking and Climbing](#) - Lakes and Scotland
- [www.bhutantrkking.co.uk](#) - treks and tours in Bhutan

- [Andean Trails](#) - Adventure tours throughout the Andes
- [Santa Cruz Expeditions](#) - Mountaineering & trekking in Peru
- [Contour Walking Holidays](#) - UK
- [Goldenhill Travel](#) Nepal and Tibet
- [Matrix Management Training](#)
- [Anglodutch cycling tours in Holland](#)
- [Adventure Days Outdoor Activities - UK](#)
- [Mountain Equipment Outdoor Gear](#)
- [Ronhill outdoor clothing](#)
- [Birch Brae Chalets](#) - Glencoe accommodation
- [Compass West Rock Climbing Courses](#)
- [Cuillin Guides](#) - Mountaineering in Skye and Alps
- [A Good Guide](#) - Personal guiding in the Lake District
- [Mountain Training Consultancy](#) - Provider of Mountaineering courses
- [Alpine Club](#) - Top UK mountaineering club

INSTANT
TRAVEL INSURANCE
➔

INSURE &
➔



MOUNTAIN WAREHOUSE

[The UK's Best Value](#)

[Outdoor Stores](#)

Dedicated to the world of **outdoor sports** and **activities**,
travel and **adventure**.

SAN GORGONIO WILDERNESS ASSOCIATION

[home](#) [site map](#) [about us](#) [history](#) [faq](#) [how to help](#)

last update 09 MAY 2004 [Bookmark this page now!](#)

The SGWA

- ▶ [Who Are We?](#)
- ▶ [Our History](#)
- ▶ [Awards & Accolades](#)
- ▶ [How You Can Help](#)
- ▶ [Volunteer Program](#)
- ▶ [Sponsor the SGWA](#)

Site Resources

- ▶ [What's New Here](#)
- ▶ [SGWA Newsletter](#)
- ▶ [How Are We Doing?](#)
- ▶ [Links to Resources](#)
- ▶ [Site Search](#)
- ▶ [FAQ](#)
- ▶ [Forest Service Phones](#)
- ▶ [SGWA Volunteers Login](#)
updated 28 APR 2004

Cool

- ▶ [Backcountry Store](#)
- ▶ [Backcountry BB](#)
- ▶ [Photo Gallery](#)
- ▶ [Photo Panoramas](#)

The Wilderness

- ▶ [General Info](#)
- ▶ [Wilderness History](#)
- ▶ [Trails of the Wilderness](#)
- ▶ [Current Trail Conditions](#)
- ▶ [Current Weather Forecast](#)
- ▶ [Bears in the Wilderness](#)
- ▶ [Trash in the Wilderness](#)
- ▶ [Flora & Fauna](#)
- ▶ [Trip Planner](#)
- ▶ [Wilderness Journal](#)
- ▶ [Summit Register](#)
- ▶ [Wilderness Permit Appl.](#)
- ▶ [The Adventure Pass](#)
- ▶ [GPS Coordinates](#)
- ▶ [Wilderness Regulations](#)
- ▶ [Minimum Impact Ethics](#)
- ▶ [Developed Campgrounds](#)

Contact

Due to fire damage and dangers, use of motorized vehicles is restricted on some roads in the San Bernardino NF. Please [click here](#) for details and call a local Ranger Station if you have questions. The road restriction map can be viewed [HERE](#).

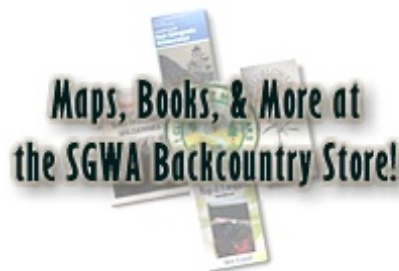
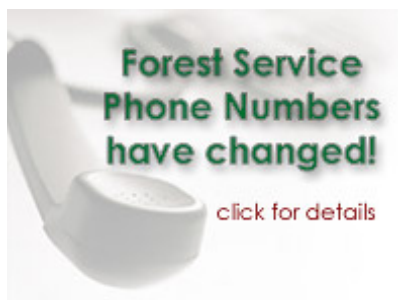

The SGWA is sponsored
in part by
www.AlpineRetreat.com



[Security, Disclaimers, and Nondiscrimination](#)

SGWA
34701 Mill Creek Rd.
Mentone, CA 92359
SGWA (909) 382-2906
For the Forest Service: (909)
382-2882
[email SGWA](#)

Hosting Donated by



Search REI.com

[Log in](#)

[Shopping Cart](#)

[Your Account](#)



You are not logged in.

[REI.com](#) | [REI-OUTLET.com](#) | [REI Adventures](#) | [Stores & Events](#) | [Gift Registry](#)

[Home](#) | [Shop All Categories](#) | [Ordering Questions](#) | [Shipping Info](#) | [Contact Us](#) | [Help](#)

- Gear Shops
- [Camping/Hiking](#)
- [Climbing](#)
- [Cycling](#)
- [Paddling](#)
- [Snow Sports](#)
- [Cross Training](#)
- [Travel](#)
- [Time, Tools & Optics](#)
- [Women's Gear](#) New!
- [REI Gear](#)
- [Books/Maps](#)
- [Car Racks](#)

Head Out With Award-Winning Gear!

Get the goods that have the outdoor biz buzzing. Shop the gear that received high praise from the editors at Backpacker and Outside magazines.

[Shop award-winning gear now!](#)

- Clothing & Footwear
- [Men's Clothing](#)
- [Women's Clothing](#)
- [Kids' Shop](#)
- [Footwear](#)

- Gift Services
- [Gift Registry](#)
- [Gift Shop](#)
- [Gift Certificates/Cards](#)
- [Gift Boxes](#)

- Bargains
- [On Sale](#)
- [REI-OUTLET.com](#)

- Shopping Tools & Help
- [Shop by Brand](#)
- [All Categories](#)
- [Size Finder](#)
- [Shopping Help](#)
- [Expert Advice](#)

REI Stores & Sites

More Hot Picks for Spring

<p>Save at Least 30% on REI Specials</p> <p>Grab the deals on our favorite in-season gear!</p>	<p>REI Momentum</p> <p>Winner of Outside Magazine's 2004 Gear of the Year Award.</p> <p>More REI cross-training clothing.</p>	<p>Arc'Teryx Bora Backpacks</p> <p>Head for the hills with a high-tech pack.</p> <p>See more backpacks.</p>	<p>Teva Sandals</p> <p>Summer vacation for your feet!</p> <p>Shop all sandals.</p>
--	---	---	--

News and Deals

- Enter to Win BUZZ OFF™ Clothing!**
" Sign up for Gearmail®, our e-newsletter, and you'll be entered to win an insect-repellent outfit from Ex Officio. A \$163 value!
- New! REI Gift Registry**
" Our totally redesigned gift registry is up and running. [Create your registry now](#) and see a quick intro highlighting key features.
- National Trails Day Is June 5th!**
" It's a great time to give back to the trails you love. [Learn more](#) and see a list of REI-supported projects.

Want Free Shipping?

Choose REI store pickup! Take advantage of this service at checkout, and we'll ship orders to your local REI store for free. [Learn more.](#)

[Retail Stores & Events](#)

[REI Adventures](#)

[REI-OUTLET.com](#)

[Corporate Sales](#)

Services &

Membership

Membership

[E-mail Newsletters](#)

[Free Catalog](#)

[Affiliates](#)

[Apply for an](#)

[REI Visa®](#)

Company Info

[About REI](#)

[REI Gives](#)

[Jobs](#)

● **Win Your Ultimate Adventure!**

" Choose the adventure trip of your dreams and invite three others to share it! [Enter the REI Visa/REI Adventures "Ultimate Adventure" Sweepstakes.](#)

● **How to Shop REI.com**

" [Learn the ropes in 30 seconds.](#)

Best Sellers

1. [Garmin GPS Units](#)
2. [REI Tents](#)
3. [Keen Sandals](#)
4. [Chaco Sandals](#)
5. [REI Convertible Pants](#)
6. [prAna Capri Pants](#)
7. [CamelBak Cycling Hydration Packs](#)
8. [REI Kilo Plus 0 Sleeping Bag](#)
9. [REI Tech Tees](#)
10. [Oakley Sunglasses](#)

[REI.com Home](#) | [Shopping Cart](#) | | [Apply for an REI Visa®](#)

[Help](#) | [Contact Us](#) | [Live Help](#) | [E-mail](#) | [Phone/Fax/Mail](#) | [Jobs](#)

[REI-OUTLET.com](#) | [REI Adventures](#) | [Corporate Sales](#) | [Find an REI Store](#)

[© 1996-2004 REI](#) | [Privacy Policy](#) | [100% Satisfaction Guarantee](#)

[Home](#)
[When to Use](#)
[Emergency](#)
[Order](#)
[FAQ](#)
[Products](#)
[E-Mail](#)
[Testimonials](#)

RESTOP® (REST-STOP)

You know the feeling. You've got to go, but there are no restroom facilities around. You don't want to use the great outdoors and face possible embarrassment, and the last thing you want is to be forced to use an unclean or unsafe facility. What option do you have?



RESTOP gives you two options when you are on the go and without restroom facilities.

RESTOP 1 is designed for liquid waste while **RESTOP 2** handles both liquids and solids. Both contain our exclusive blend of polymers and enzymes to instantly gel liquid and break down solid waste. RESTOP's patented design prevents leakage and fully contains waste, even if the bag is dropped! What's more, both products can be disposed of in any trash receptacle—no special dumping requirements, harsh chemicals, or hassle like other portable toilets!

Why use RESTOP?

- RESTOP is completely **portable**. A four pack of RESTOP 1 can be easily carried in a purse, backpack, or glove compartment, ready when you need it. And it's lightweight!
- RESTOP is completely **spill proof**. Liquid waste is turned into a odorless gel instantly on contact. And RESTOP's patented one-way valve prevents leakage, even if the bag is turned upside down!
- RESTOP is **sanitary**. Since RESTOP is designed for a single use, there's no chance of disease or smell like a public restroom.
- RESTOP is **disposable**. Unlike bottles or other containers, all RESTOP products can be disposed of legally in any normal trash container. And RESTOP's unique enzyme formula breaks down waste into

environmentally-friendly components.

What kinds of people use RESTOP products?



[Aviators](#)



[Boaters](#)



[Anglers](#)



[Campers](#)



[Hunters](#)



[In the Car](#)



[Family Activities](#)



[Potty Training](#)



[Truckers](#)

Anyone who can't get to a restroom can use RESTOP products! Pilots, boaters, campers, hikers, hunters and families all love RESTOP because it can go anywhere, stored until you need it. Keep a supply in the car to avoid the problem of finding a restroom when you need it. Perfect for those who care about the environment and who don't want to pollute with human waste. Click on the icon to find out how people use RESTOP.



Contact us today, and never be far from a RESTOP!

Toll Free 888-924-6665

Fax 760-741-6622

E-mail info@whennaturecalls.com



VegWeb

LAMAS BEAUTY Peter Lamas Personal Beauty Solutions! [click here!](#)
Skin Care and Make Up together in one product!
No animal testing or ingredients • 100% VEGAN
 Use coupon code "vegweb" to get a 15% discount at checkout

[Advertise on VegWeb](#)

- [Home](#)
- [Recipes](#)
- [Cookbooks](#)
- [Coupons](#)
- [VegLinks](#)
- [VegWeb Personals](#)

[Login](#) | [Register](#)

[» My Recipe Box](#) [» My Grocery List](#) [» My Meal Planner](#)



-  [In the Spotlight](#)
Featured Coupon
[Estrella Soap: Buy 2 bars, receive 1 free](#)
-  [Try These Recipes](#)
Recipe of the Day
[Great Northern Burritos](#)
[» Tried & True Recipes](#)

New Recipe Comments

[Green Eggs & Ham](#)
 05/09/04 19:54 StrainjOne writes:
 The seasoning packet refers to the Nasoya mix, or whichever mix...

[Nacho Cheeze Sauce](#)
 05/09/04 22:26 Caemissa writes:
 I think nutr. yeast is an acquired taste... I HATED it when I f...

[Cheap and Easy Ramen Soup](#)
 05/10/04 09:19 jill writes:
 I love using ramen noodles (without the seasoning package!) Th...

[Tempeh Aux Champignons En Crou^Te](#)
 05/10/04 12:43 friendlyt writes:
 mmmm, this sounds fab, but I am not getting my head around the ...

Sponsored Links

[Air Purifier Trial](#)
[Try a filterless air purification unit](#)



Vegan Marshmallows!



Vegan Shoes



Vegan Donuts

[VeganEssentials.com](#)

[VegLinks](#)

➡ Recently Added:

- [budaveg](#)
- [HealthyGoodiesGifts.com™](#)
- [TinyCookie.com : The art of Heather Roraback](#)

[Add Your Veg Link](#)



[VegWeb Map](#)

[Recipes](#)

- [» Recipes](#)
- [» New Recipes](#)
- [» Submit Recipe](#)
- [» Q & A](#)

[Coupons](#)

- [» Coupons](#)
- [» New Coupons](#)

[Cookbooks](#)

- [» Cookbooks](#)

[VegLinks](#)

- [» VegLinks](#)

- » [Hot Links](#)
- » [Add Your Veg Link](#)

- [VegWeb Personals](#)
- » [Search Personals](#)
- » [Browse Profiles](#)
- » [Login | Register](#)

[Newsletters](#)

- » [Monthly](#)
- » [Articles](#)
- » [FAQs](#)
- » [Veggie Poetry](#)
- » [VegWeb Surveys](#)

[Hummus-Iranian Style](#)

05/10/04 13:48 junathena writes:
Decided to try this when I felt like a snack after reading all ...

[French Toast \(sans Bananas\)](#)

05/10/04 14:13 kparsons writes:
This was outstanding!! I made it for a Mother's Day brunch at ...

[The Chocoholics 'Ice Dream'](#)

05/10/04 16:18 animalluva writes:
OH MY GOD!!! You weren't kidding when you call this a dream! It...



Vita-Mix Super 5000
or Vita-Mix 5000

Juice whole foods,
cook soup, make
frozen treats and
more.



**Free ground shipping with code:
ITVWA03**

7 Year Warranty: Vita-Mix Corporation
guarantees that your Vita-Mix will perform
like new for a full seven years from the date
of purchase--or they will repair it for FREE.

Vita-Mix: [Order online](#) or call Vita-Mix
Corporation at 1-800-848-2649



**Vita-Mix 5000
& Super 5000**

Free Ground
Shipping
with code
"ITVWA03"

CLICK HERE!

[Vita-Mix Coupon](#)

[VegWeb Personals](#)
[Meet Vegan & Vegetarian Singles & Pen Pals](#)

New Photo Profiles:

[iamgreen](#)

[Send Message](#) [View Profile](#) 18 views



vegan

44 yrs
seeking just friends
Ontario, Canada
Joined on 10 May 2004

Vegetarian since 1976. Trying again to be
vegan and looks like I'm making it this time
(9 months so far) thanks to area stores fi...

[kealoha](#)

[Send Message](#) [View Profile](#) 253 views



ovo-lacto vegetarian

18 yrs
seeking just friends
California, USA
Joined on 09 May 2004

I've been a vegetarian since birth (only one
in my family) and am trying to go vegan. I
like to dance, shop, and all that good stu...

[Tupperware
Shop Tupperware
online and save!](#)

[Healthy Soy Diet
Plan
by eDiets](#)

[Vita-Mix Super
5000
Coupon code for
free ground
shipping.](#)

[Advertise](#)

[SonyaSonya](#)

 [Send Message](#)  [View Profile](#) 49 views



ovo-lacto vegetarian

19 yrs
woman seeking man
Pennsylvania, USA
Joined on 09 May 2004

Sonya-Sonya

I love to cook so I was just looking around checking out for some recipes. I have been ovo-lacto since I was 9 and would never go...

[seaversusky](#)

 [Send Message](#)  [View Profile](#) 203 views



vegan

26 yrs
seeking just friends
Alaska, USA
Joined on 09 May 2004

I'm flying!!!

Where are we going and why am I in this handbasket? I like my best friend Melody; Charles Bukowski; Tom Waits; Chicago; eastern...



VegWeb.com, Inc. ~ [Contact Us](#) ~ [Advertiser Login](#)
[Advertise on VegWeb](#) ~ [VegWeb Banner Exchange](#)
Please review our [Legal Notice](#) and [Privacy Policy](#).

Copyright © 2003 VegWeb.com, Inc.

[Home](#) | [Recipes](#) | [Coupons](#) | [Surveys](#) | [VegLinks](#) | [Newsletters](#) | [VegWeb Personals](#)

The Survival Foods And Gardening Section

SAVING MONEY WITH A THERMOS BOTTLE

By Kurt Saxon

Many subscribers write that they will eventually buy all my books but they can't afford them at this time. Many are students on limited allowances. Some are on Social Security or pensions. Others are on Welfare, as I was after an injury, when I got \$86.00 per month in 1969. I paid \$50.00 for rent and had only \$36.00 left for food and incidentals. Even so, I ate better than before. Prices were indeed lower then but, surprisingly, the costs of the more basic foods have hardly changed.

For instance, 60 pounds of hard red winter wheat, the highest in protein, minerals and vitamins, averages \$8.00 (240 breakfasts at 4 cents each). Brown rice, also higher in nutrition than white, costs \$14.00 for 25 pounds. Also 200 servings since rice swells twice as large as wheat. These are bought in bulk at any feed and seed store.

Wheat and rice are the staple foods of billions and, if prepared my way, will fill you up, give you boundless energy; and cost nothing, if you consider that the saving in gas or electricity will offset their purchase prices.

I do not mean that wheat and rice, plain, is what I am asking you to live on. When is the last time you have eaten a potato plain? I am simply suggesting you process all your food in inexpensive, energy-saving ways and eat better than you ever have for less than \$10.00 per week. Then you can not only afford all my books but many other things you have wanted but had to do without because most of your food budget goes to pay others to do what you should learn to do for yourself.

The thermos and the dehydrator are first steps in eating better for so much less. As a Survivalist, you will have to understand food

preparation or you might as well eat, drink and be merry in the short time you have left.

A great factor which makes this practical and easy to understand is that since it is by a man, it is basic, gut-level and moron-simple. You won't even need to open a cookbook.

First the thermos. There are three kinds but only one is practical. Forget the cheap, plastic ones lined with Styrofoam. These might cook oatmeal and white rice but do not have the heat holding power you need. Silvered glass thermoses are fine, but a bump will break them. Also, since you are going to do actual cooking and will use a fork to remove the contents, they will not hold up.

The only practical cooking thermos is the Aladdin Stanley. It is lined with stainless steel, is well insulated and will keep steaming hot for up to 24 hours and holds a quart. It is also unbreakable, with a lifetime warranty. It costs \$22.00 at Wal-Mart or can be ordered through any sporting goods store. It would save you its price in a few days. If you have a family, get two or three.

Most foods cook at 180 degrees or more. We are used to boiling, which is 212 degrees, and foods do cook faster, the higher the temperature. But if time is not important, cooking at a lower temperature is even better as most vitamins are not broken down. Thus, if you cook at a minimum heat, you save nutrition.

A great factor in thermos cooking is the saving in the cost of energy. Whereas it would take about two hours to cook whole-grain wheat or nearly an hour to cook brown rice. Thermos cookery takes only five minutes to cook anything. So it is indeed possible to save as much in energy as you spend on the food. You can imagine the convenience of thermos cookery in camping, which would save on wood, weight of food carried, and no food odors to alert bears or enemies.

Thermos cookery is also an advantage to anyone living where he is not allowed to cook. There are no cooking odors to tip off the landlord.

First, you need the thermos. Then you need a heat source. If you are in a

non-cooking room, buy a cheap, one burner hot plate from your local Wal-Mart, Target, Sears etc. You will need a one quart saucepan. You will also need a special funnel to quickly pour the pan's contents into the thermos, plus a spoon or fork to help the last of the food into the funnel.

To make the funnel, cut off the bottom four inches from a gallon plastic milk container. If you do not buy milk or cannot find an empty container, go to your nearest laundromat. You will find in the trash receptacle, an empty gallon bleach bottle. Use that the same as the milk container but wash it until there is no more bleach odor.

The first step in thermos cookery is to fill the thermos with water up to the point reached by the stopper. Empty the water into the saucepan and make a scratch or other indelible mark at the water's surface inside the saucepan. This will allow you to put just enough water in the saucepan, as too much will leave food out and too little will give you less cooking water.

Just to test how the cooker works, start with four ounces of wheat. You do not need to buy 60 pounds. You can buy two pounds from your health food store for about \$.80 This would give you eight meals at 10 cents each.

In the evening, put four ounces in your saucepan, plus a half-teaspoon of salt to prevent flatness, even if you intend to sweeten it. Fill to the mark with water. (If you have hot water, let the tap run until it is hottest. Tests have shown that less energy is used in using hot tap water than in boiling from cold.) Bring the contents to a rolling boil, stirring all the while. This will take from three to five minutes.

Then quickly, but carefully, swirl and pour the contents into the funnel and help any lagging matter from the pan to the funnel and into the thermos. Cap firmly but not tightly, shake and lay the thermos on its side, to keep the contents even.

Next morning open the thermos and pour its contents into the saucepan. With four ounces of dry wheat, you will now have at least 3/4 pound of cooked wheat and about a pint of vitamin and mineral enriched water. It has a pleasant taste. Drink it.

You can now put milk and sweetener on it or margarine, salt and pepper, etc. If you can eat the whole $\frac{3}{4}$ of a pound, you will be surprised at how energetic you feel for the next several hours. An added bonus is its high fiber content.

Having tried the four ounce portion, you might next use eight ounces. This will absorb most of the water. It is unlikely that you could eat a pound and a half of cooked whole grain wheat. You can either divide it and eat the other half for supper or if you are a family man, make it the family breakfast food to replace the expensive brand.

If you have children, get them into the act by fantasizing they are Rangers on a jungle patrol.

For lunch, prepare a few ounces of hamburger or other meat chopped finely, plus chopped potatoes and other vegetables the night before. After breakfast, put these and the right amount of water in the saucepan and prepare as usual. At lunchtime you will have a quart of really delicious stew. Since nothing leaves the thermos in cooking, as contrasted to the flavor leaving stew cooking on the stove, you can understand the better tasting, higher vitamin content of thermos stew.

Lunch and possibly supper should not cost you more than 25 cents if you study the article on the dehydrator. Jerky and dried vegetable stew is good and costs little.

The brown rice dishes could also be either a main course or desert. Brown rice has a much greater swelling factor than wheat so four ounces of rice will pretty much fill the thermos. You can put vegetables and meat in it to cook or try a favorite of mine. It is four ounces of brown rice, 9 cents; one ounce of powdered milk, 10 cents in a large box; two ounces of raisins, 22 cents; one teaspoon of salt; some cinnamon and four saccharine tablets. Cook overnight. This is 46 cents for 1 $\frac{1}{2}$ pounds of desert.

With some experimenting, you can become an expert in thermos cookery. If you are single and live alone, you could, conceivably, eat nothing except what you cooked in a thermos. But if you are married,

and especially if you have children, don't push it. Even with the economy of this system, it's not worth alienating your family. If your wife doesn't like it, challenge her to make the food tastier and think up some thermos recipes. You might also tell her the advantages of thermos cookery.

For one thing, she would spend much less time in the kitchen. What with the expected brownouts, she could do all the cooking in five, ten, fifteen minutes, depending on how many thermos bottles she used. Another important factor is that, especially during the heat waves, the home would not suffer the added heat from the kitchen. This would also cut down on the air conditioning costs.

A tip you may not have known is that the pilot light in a gas stove not only raises the temperature in the kitchen but also accounts for a fourth of all the gas burned in the stove. Matches are much cheaper. Turn the pilot light off.

Be sure to get SURVIVOR Vol. 1 for a full course on inexpensive but tasty and nourishing food, plus sprouting for green vegetables, soy milk, tofu, etc.

[[Back](#)] [[Home](#)] [[Up](#)] [[Next](#)]

Website Contents © 2004 Atlan Formularies, P.O. Box 95, Alpena, AR 72611-0095
Phone - 870-437-2999, Fax - 870-437-2973, Email - cary@survivalplus.com

Index of /renfrow

Name	Last modified	Size	Description
 Parent Directory	23-Mar-2004 10:38	-	

Apache/1.3.27 Server at www.alcasoft.com Port 80



LOMA LINDA UNIVERSITY ADVENTIST HEALTH SCIENCES CENTER

LOMA LINDA UNIVERSITY • MEDICAL CENTER • HEALTH CARE • BEHAVIORAL MEDICINE

[Students](#) | [Prospective students](#) | [Alumni](#) | [Faculty & staff](#) | [Patients](#) | [Visitors](#) | [Libraries](#) | [Giving](#) | [Maps](#) | [Jobs](#) | [Intranet](#) | [My LLU&MC](#)

Loma Linda University

[Allied Health](#)

[Dentistry](#)

[Graduate](#)

[Medicine](#)

[Nursing](#)

[Pharmacy](#)

[Public Health](#)

[Religion](#)

[Science & Tech](#)

[Apply](#)

LLU Medical Center

[Behavioral Medicine](#)

[Cancer treatment](#)

[Children's Hospital](#)

[Community Medical](#)

[Subspecialties](#)

[Find a doctor](#)

LLU Health Care

Our mission

Support Loma Linda

Search & index

Welcome, we are pleased to share with you our special mission to further the healing and teaching ministry of Jesus Christ. | [More from the president](#) |

[News & events](#)



"Venom ER" series airs on Animal Planet Channel - Loma Linda University Medical Center staff will see 10 hours of air time over the next two months on Animal Planet "Venom ER" series. [\[More\]](#)



United States senator commends LLUMC - LLUAHSC president and chief executive officer B. Lyn Behrens, MBBS, recently received a letter of commendation from US senator Barbara Boxer. [\[More\]](#)



Endovascular coiling offers choice for aneurysm patients - This method treats the aneurysm from inside the blood vessel. This technique is a minimally invasive procedure that uses a microcatheter and very thin platinum coils. [\[More\]](#)

[Download screensavers](#)

[Email this page](#)

[Step-by-step: a quick guide to the online world at Loma Linda University \(PDF\)](#)

[LLUAHSC](#) | [University](#) | [Medical Center](#) | [Search & index](#) | [Contact](#) | [Employment](#)

Welcome to Loma Linda University Adventist Health Sciences Center

Revised Wednesday, April 21, 2004 10:09 AM

Send comments and questions to webmaster@univ.llu.edu

URL: <http://www.llu.edu>

[Privacy information](#)



[Advanced Search](#) | [Site Map](#)

- [Home](#)
- [About Us](#)
- [News](#)
- [Honors](#)
- [Classwork](#)
- [Outreach](#)
- [Fundraising](#)
- [Games](#)
- [Staff](#)
- [Resources](#)
- [Clipart](#)
- [Contact Us](#)
- [Links](#)

Learn More . . .



Welcome to the official NAD Pathfinder Website, your official online Pathfinder Information Resource!

News Flash!

2004 NAD Youth Ministries Convention Information

[More Information ...](#)



Maybe you've stumbled across this site and would like to know [about Pathfinders](#). Maybe you're a Pathfinder of Pathfinder staff member interested in the upcoming [North American Division Faith on Fire International Camporee](#). The promotional resources ([Promotional DVD](#) | [Promotional Video](#) | [Brochures](#) | [Logo Kit](#)) are now available from [Adventsource!](#)

If you're a **Pathfinder** interested in learning more about Pathfinders through the technological use of the web, and at the same time impress your counselor with how much you know, check out our online [Quizzes & Games](#) or [Honor](#) sections.

Counselors can find up-to-date [AY Honor Information](#), as well as classwork requirements and tips for teaching [Classwork](#).

Or, you might need [outreach](#) ideas that aren't the "same-old-thing-we-did-for-the-last-five-years."

You'll also find [News](#) from around the North American Division (remember that news happens where YOU are. Let us know what is happening!)

For the clipart enthusiast, there's a growing collection of Pathfinder-specific clipart & [images](#).



*50th Anniversary
Commemorative Coin*

[Discover More. . .](#)

[Order Now!](#)

For [Pathfinder staff](#), there's a growing collection of honor resources to help you teach. There will soon be fundraising ideas that really work, networking through online forums to other talented pathfinder staff, Continuing education for Master Guide, Pathfinder Leadership Award, and Pathfinder Instructor Award, as well as online tests and games to help you teach pathfinders.

Do you have ideas of what you would like to see here? [Contact us!](#)

100,501 Visitors
Since May 1, 2000



[Home](#) | [About Pathfinders](#) | [Honors](#) | [Classwork](#) | [Outreach](#) | [Quizzes & Games](#) |
[Staff](#) | [Resources](#) | [Images](#) | [Contact Us](#)

Sponsored by [North American Division Pathfinders](#) ~ North American Division of SDA ~ ©2000-2002
Website designed & maintained by [Mark O'Fill](#)

ERROR: Incorrect Address

Please visit our site at <http://www.scouting.org>

<http://www.bsa.scouting.org/>



Find A Host @ The Web Hosting Resource Index		resourceindex
Basic Hosting Solutions		Advanced Hosting Solutions
Unix Hosting	Windows Hosting	Dedicated Servers
Managed Hosting	Virtual Private Servers	Colocated Hosting
Budget Hosting	E-Commerce Hosting	

Welcome to Matt's Script Archive. Offering free CGI scripts to the web community since 1995!

What's New @ MSA?

May 20, 2002

- Site re-design @ MSA
- Added [nms programs](#)

April 21, 2002

- [FormMail 1.92](#) now out
- SECURITY UPDATE!



Other sites by Matt:

[FormMail.com](#)

- hosted form processor

[CGI Resource Index](#)

- 3,000+ Perl Scripts!

[PHP Resource Index](#)

- 2,000+ PHP Scripts!

[Web Hosting Index](#)

- web hosting solutions

[chumpsoft, inc.](#)

- online survey software

Matt's Free Perl CGI Scripts

[FormMail](#)

Downloaded over 2 million times since 1997, this script sends the results of any HTML form via e-mail to the specified users. Works for multiple forms & users.

[readme](#), [faq](#), [download](#), [nms](#), ...
Free - v1.92 - April 21, 2002

[phpQuestionnaire](#)

A comprehensive web-based survey builder that gives you complete control over the look and feel of multi-page surveys with detailed reporting.

[readme](#), [demo](#), ...
\$199 - v2.1 - PHP 4 or Perl 5 & MySQL
sponsored cgi program ▲

[Simple Search](#)

Allows you to integrate a basic keyword and boolean search program into your site so that users can search specified text and HTML documents.

[readme](#), [faq](#), [demo](#), [download](#), [nms](#), ...
Free - v1.0 - December 16, 1995

[Guestbook](#)

Allow users to sign in and leave their name, contact and comments! Includes ability to redirect users after signing, log entries and e-mail upon new entries.

[readme](#), [faq](#), [demo](#), [download](#), [nms](#), ...
Free - v2.3.1 - October 29, 1995

[WWWBoard](#)

A threaded discussion forum that allows users to post new messages, followup to existing ones and more. Includes a basic admin to maintain the board.

[readme](#), [faq](#), [demo](#), [download](#), ...
Free - v2.0A2.1 - January 7, 2000

[Article Manager](#)

Coding all day?? Publish content fast. Easy interface lets non-technical users publish content using a WYSIWYG editor. Risk free, 90-day money back guarantee

[read more...](#)
\$299 ~~\$269~~ - v1.38 - February 11, 2004
sponsored cgi program ▲

Useful Web Resources:

[Research Hotels and Vacations](#)

Free unbiased reviews, articles and great deals ...

[HostingMetro.com](#)

Cheap Cpanel web hosting as low as \$3.99/month!

Web Host Providers:

[Best Web Hosting deal on the web for \\$7.50/mo](#)

Tired of looking around for Web Hosting! Get StartLogic s most powerful ...

[iPowerWeb.com Quality & Reliability are Important!](#)

99.9% Uptime -24-7-365 LIVE Toll FREE Support. \$7.95/mo for 800 Megs, ...

[iPowerWeb makes Reselling Simple](#)

Join Thousands of entrepreneurs, webmasters

[Counter](#)

Uses a C program to generate images on the fly. You can set border size, transparency, use an invisible count, and more. Limited to counting one page.

[readme](#), [faq](#), [download](#), ...

Free - v1.1.1 - January 11, 1996

[Random Text](#)

A program that randomly chooses a section from a plain text file that contains a series of phrases, quotes, lines of text, html tags, etc.

[readme](#), [faq](#), [demo](#), [download](#), [nms](#), ...

Free - v1.0 - July 13, 1996

[Free for all Links](#)

Allow your users to add their own link to specified categories. Running total of number of links and time last link was added are also displayed.

[readme](#), [faq](#), [demo](#), [download](#), [nms](#), ...

Free - v2.2 - July 16, 1996

[HTTP Cookie Library](#)

Allows you to easily use cookies by simply calling on routines from within your scripts to set, retrieve, compress, and modify persistent cookies.

[readme](#), [faq](#), [demo](#), [download](#), [nms](#), ...

Free - v2.1 - December 26, 1996

[Random Image Displayer](#)

Allows you to configure a list of images that can then be randomly displayed on your web site as inlined images or even as your page's background image.

[readme](#), [faq](#), [demo](#), [download](#), [nms](#), ...

Free - v1.2 - July 17, 1996

[TextCounter](#)

Display a text count of visitors to your web pages. Includes: zero padding, file locking, linking the count, displaying begin date and counting multiple pages.

[readme](#), [faq](#), [demo](#), [download](#), [nms](#), ...

Free - v1.2 - May 10, 1996

[TextClock](#)

TextClock can show your visitors several variations on the current time and/or date. Choose what details to include and link the date to any site.

[readme](#), [faq](#), [demo](#), [download](#), [nms](#), ...

Free - v1.0.2 - July 15, 1996

[Random Link Generator](#)

Random Link Generator allows you to establish a link that, when clicked on, takes the user to a random url pulled from a list of URLs that you specify.

[readme](#), [faq](#), [demo](#), [download](#), [nms](#), ...

Free - v1.0 - July 30, 1996

[Countdown](#)

Implement a simple countdown to a specific date in your web pages. Set the countdown accurate to the second, minute, hour, day, month or year.

[readme](#), [faq](#), [demo](#), [download](#), [nms](#), ...

Free - v1.2.1 - October 08, 1995

[SSI Random Image Displayer](#)

Similar to the basic Random Image Displayer, this version allows you to associate a specific link and alt text that will appear with each image.

[readme](#), [faq](#), [demo](#), [download](#), [nms](#), ...

Free - v1.2 - September 30, 1996

and web site developers who are ...

[Extras](#)

Add-ons and modifications for the scripts at Matt's Script Archive.

Looking for more? [The CGI Resource Index](#) has over 3,000 CGI programs.

[Snippets of Code](#)

Small pieces of code which don't merit their own page, but are useful.

Matt's Free C++ CGI Programs

[TextCounter C++](#)

Display a text count of visitors to your web pages. Includes: zero padding, file locking, linking the count, displaying begin date and counting multiple pages.

[readme](#), [faq](#), [demo](#), [download](#), ...

Free - v1.3.1 - June 24, 1998

[TextClock C++](#)

TextClock can show your visitors several variations on the current time and/or date. Choose what details to include and link the date to any site.

[readme](#), [faq](#), [demo](#), [download](#), ...

Free - v1.0.3 - March 29, 1997

Other People's Free Perl CGI Scripts

[Credit Card Verifier](#)

Check syntax of credit card numbers to gain a first line of defense against randomly entered numbers. By: Spider

[readme](#), [faq](#), [download](#), ...

Free - v1.02 - July 1, 1996

[Book 'em Dano](#)

A very simple logging script that will tell you where your users come from and what browser they used. By: Spider

[readme](#), [download](#), ...

Free - v1.01 - July 10, 1996

[nms Project](#)

This project was started by the London Perl Mongers with the goal of creating drop-in replacements for the scripts found at Matt's Script Archive. These replacements have been released under the GPL and Artistic License, allowing us to offer them to you.

Getting Help

[Frequently Asked Questions](#)

Answers to the most commonly asked questions about MSA and our scripts.

[Readme Files](#)

This is the documentation supplied with the scripts found at MSA. A must read!

[Help Center](#)

Wonderful resources when installing, using and modifying our scripts.

[Working Demonstrations](#)

See what MSA scripts look like in action. Demos available for most scripts.

Current Sponsors, Great Products

[Premier Web Hosting](#)

[Web Hosting Metro](#)

[PowWeb Hosting](#)

[Additional Sponsors](#)

[TripAdvisor Hotels & Vacations](#)

[Premier Web Software](#)

[chumpsoft, inc.](#)

[InteractiveTools.Com](#)

Special thanks to Dave Jackson at [World Wide Mart](#) for providing server space to MSA.

[[Linking to MSA](#) | [Advertising Opportunities](#)]

[Matt Wright](#) - mattw@scriptarchive.com

© 1995 - 2002 Matt's Script Archive, Inc.

Internet *Pizazz*TM Promotion Team



From San Diego to Seattle, this professional team of marketers, programmers, designers, and artists create business successes online. Internet Pizazz uses the Internet as a powerful tool for market research and promotion. They understand what your business needs. When you are ready to start a promotion campaign, Internet Pizazz will use their extensive knowledge to make the computers of the world serve your business!

Websites are like any other address or phone number, they *must be promoted* if you want customer response.

The group that gives *Pizazz*TM to Internet presentations are eclectic and diverse. Independent contractors are free to choose which projects they will devote themselves to. They like what they do; they believe in the products and services of their clients. Combining experience and creativity with honest enthusiasm is one key to tremendous success. We'd like to have the opportunity to consider the needs of your company. Please email or call us.

Overview of our associates

- [Ads On-line](#)

- [Archetype](#)
 - [HMC](#)
 - [Infotainment Computers](#)
 - [Pacific Coast Software](#)
 - [Prevision Associates](#)
 - [Individuals by first name](#)
-

Ads On-line

Ads On-line is an electronic publication in the San Diego area. The business is an information computer bulletin board serving the 619 and 760 area codes of southern California.

Archetype

Empowers your printed word!
Evaluation, editing, design, typesetting, laserprinting.

HMC

HMC consultants have been in the San Diego/Orange County areas of California since the early 1980s. The personnel have been involved in the computer industry since the early 1960s. HMC has extensive background in hardware design, software design and implementation, and overall system integration. Some industries which have benefitted from the expertise of HMC are clinical/pathology laboratories, retail point-of-sale, manufacturing and distribution companies, and small business organizations.

The primary strength of HMC is complete service to the client, including recommendations, installation, training, programming, and support services.

Infotainment Computers

Infotainment Computers specializes in *Information and Entertainment* computer systems. The owner is an engineer with years of high-tech design experience. Their philosophy of selling is based upon doing what is best for the customer. The service is so good that some word-of-mouth referrals are still coming in *years* after the original customer made a purchase.



Pacific Coast Software

Pacific Coast software is a major web provider. We urge you to [see their site for yourself](#). The cutting edge technology running on their servers defines the state-of-the-art for Internet commerce systems.

Prevision Associates

Prevision Associates has decades of graphic design experience. Corporate design and gallery art have been used and shown world wide since the 1960s.

Individuals by first name

Julio- Market researcher and programmer.

Robert- Future projects research.

Roger- Marketing consultant.

Here's Roger's resume'

BSEE degree in electronic engineering.

16 years in the business of specifying and developing computer systems.

Senior marketing specialist.

Professional affiliations:

- **Chairman of American National Standards Institute (ANSI) X3A1-Optical Character Recognition and Bar Code Print Quality.**
- **Member of American Production and Inventory Control Society (APICS)-San Diego chapter.**

Engineering experience:

System/project engineering on industrial process control systems, mini-computer systems. A senior project quality assurance engineer working with highly specialized industrial computer systems and shared processor data entry computer systems.

Developed marketing and sales training aids.

Made numerous national presentations and seminars for VAR/Distributors.

Worked with end-users and VAR/Distributors.

Extensive experience in barcode and automatic identification systems area.

Developed systems for industrial, retail, government and hospital environments.

Developed programs for beta site testing.

Copyright ©1995 - 1999 Internet Pizazz(TM) All Rights Reserved.

A Production of

PIAZZ.COM (TM)

USA 760-942-0518

management@pizazz.5com

(Junkmail protected address
take out the 5 to email us.)

Get a free E-Mail Address
that has 'PIAZZ!'

Click the other
button please!

Internet [Pizazz](#) presents

A Taste of Nature; Edible Plants of the Southwest and How to Prepare Them.

© 1994 Kahanah Farnsworth

- Contents of these web pages:
- [Introduction to the book](#) This page.
- [Plant illustration, \(image\)](#). This page.
- [Ordering information](#). This page.
- [FREE recipe will be sent to you by email, find out how to get it!](#) Another page.
- [Return to The Official Edible Plants Home Page](#) Home page.

Introduction-

"This handbook is designed to be user friendly. All of the edible plants were selected for their availability, easy recognition, and usefulness. They are common throughout the Southwest and similar plant communities elsewhere. Endangered edible plants and edible plants which might be mistaken for poisonous plants are not included. Recognizing the different plants and knowing their uses adds a new dimension to our enjoyment of nature. It increases our appreciation of the great diversity of plants and the uniqueness of each one. The beauty and usefulness of plants helps to enrich our lives.

When you go foraging, please remember that we are gatherers and not destroyers. It is usually necessary to harvest only a small part of a plant in order to use it. Most plants will continue to grow and produce if they are left in the ground and only some of the leaves or a portion of the stems are removed. If there are only one or two plants growing in a location, please pass them by and give them a chance to propagate. It is also important to know if your edible plant is growing in a healthy environment where there are no chemical sprays, polluted water, or car fumes.

All of the recipes in this book have been eaten and enjoyed by people of all ages. If you have a favorite recipe, but can't locate a specific plant, it is often possible to substitute a comparable plant in its place."



This is what Orach looks like, if you click on the image you will move to the FREE Orach Quiche á la Greek! recipe page. Please be prepared to give your email address. To find out how to properly identify Orach and find it in the wild, you would do best to buy the book and study it. In fact, the book makes a great addition to your daypack while hiking or camping! With the knowlege in this book you may never have to pay for salad again. You don't have to ever be bored by Iceberg lettuce again, these plants will put variety in your diet and enhance your gourmet cooking abilities.

How to order this information-packed book:

\$10.00 (US dollars) for the book.

\$2.00 (US dollars) for shipping and handling.

\$0.70 (US dollars) sales tax ONLY FOR CALIFORNIA SHIPMENTS.

"A Taste of Nature" Book

Shipping Dept.

14135 Ezra Lane

Poway, CA 92064

Mention the Internet and get a signed first edition!

(Offer may end after all of the first edition are sold.)

Please allow up to 4 weeks for shipping, personal checks may have to clear first. For faster order handling, send Postal Money Orders and [send email to tepbp@pizazz8.com](mailto:send_email_to_tepbp@pizazz8.com) with your postal address to help the shipping department get it ready. (And be sure to remove the numeral 8 from the end of the address before sending email. This is a defense against bulk email, also known as junkmail or SPAM.)

Learn how to identify Orach, a wild edible plant.

Useful information which tells how to find and identify this plant is provided freely. Orach is a wild plant which is good in salads, sandwiches, and quiche. You can get [information which will help you identify this edible plant](#) and tell you where it grows. If you would like a FREE recipe for Orach Quiche á la Greek emailed to you, follow the link. Even if you don't want the recipe, you can learn to identify Orach and find it in the wild.

[Return to The Official Edible Plants Home Page](#)

Disclaimer:

The production and promotion of these web pages is entirely the responsibility of Internet Pizazz who holds the copyright. Any actions taken online are entirely the responsibility of Internet Pizazz and no acts online are the responsibility of the author of the book, the hardcopy publisher or of any affiliates related to either of them in any way. Please direct praises or comments of any kind to

tepbp@pizazz8.com Thank you! (And be sure to remove the numeral 8 from the end of the address before sending email. This is a defense against bulk email, also known as junkmail or SPAM.)

This document and related documents and images are property of Internet Pizazz © 1996 - 2001.

Internet [Pizazz](#) presents

Orach Quiche á la Greek!

- Contents of this web page:
 - [Features of the plant.](#)
 - [Facts about the plant.](#)
 - [Foods the plant is used for.](#)
 - [Have the FREE recipe sent to you by email.](#)
-

Orach (*Atriplex patula*)



Features: Orach grows near water or in moist locations, and is one of our favorite wild plants. It can appear almost vine-like with its slender, fragile 1' - 2.5' long stems. Sometimes it grows upright, other times it almost sprawls along the ground. Its dark green leaves are halbert-shaped and grow opposite each other along stems and branches. Orach leaves resemble spinach both in appearance and flavor. Smaller pairs of leaves spring up on short stems at the juncture of the larger leaves and the stem. Its green flowers are small and inconspicuous.

Facts: Orach is rich in iron, and extremely nutritious. Because it is a member of the Saltbush family, it is also slightly salty, and was a welcome addition to the diet of many Native Americans.

Foods:

Raw: Orach is delicious eaten raw as a snack or in sandwiches and salads, but when it grows near water of unknown purity it should be well-washed before eating.

Cooked: Orach can be steamed, boiled, stir-fried, or added to omelets. It cooks quickly and should not be over-cooked because it greatly reduces in volume. Always taste your dish first before adding salt.

How to order this information-packed book:

\$10.00 (US dollars) for the book.

\$2.00 (US dollars) for shipping and handling.

\$0.70 (US dollars) sales tax ONLY FOR CALIFORNIA SHIPMENTS.

"A Taste of Nature" Book

Shipping Dept.

14135 Ezra Lane

Poway, CA 92064

Mention the Internet and get a signed first edition!

(Offer may end after all of the first edition are sold.)

Please allow up to 4 weeks for shipping, personal checks may have to clear first. For faster order handling, send Postal Money Orders and [send email to tepbp@pizazz8.com](mailto:send_email_to_tepbp@pizazz8.com) with your postal address to help the shipping department get it ready. Thank you! (And be sure to remove the 8 from the end of the address before sending email. This is a defense against bulk email, also known as junkmail or SPAM.)

Here's how to get the FREE recipe for Orach Quiche á la Greek whether or not you buy the book!

Send email to this address and *use Orach Quiche for the subject line*. No body message is necessary for the automated reply. The recipe and a copy of this .htm page will be sent back to your email address for your eating enjoyment! Send email to tepbp@pizazz.com* (And be sure to remove the 8 from the end of the address before sending email. This is a defense against bulk email, also known as junkmail or SPAM.)

[Return to The Official Edible Plants Home Page](#)

The information on these pages is provided as a free service in the hopes that you will purchase the fine book "A Taste of Nature" by Kahanah Farnsworth.



Disclaimer:

The production and promotion of these web pages is entirely the responsibility of Internet Pizazz who holds the copyright. Any actions taken online are entirely the responsibility of Internet Pizazz and no acts online are the responsibility of the author of the book, the hardcopy publisher or of any affiliates related to either of them in any way. Please direct praises or comments of any kind to tepbp@pizazz8.com Thank you! (And be sure to remove the 8 from the end of the address before sending email. This is a defense against bulk email, also known as junkmail or SPAM.)

This document and related documents and images are property of Internet Pizazz © 1996-2001



PAWPAW RECIPES

There aren't a lot of recipes for the pawpaw out there- at least that I've found. Euell Gibbon's book [Stalking the Wild Asparagus](#)  has some pawpaw recipes, and is still the best source for native plant info, lore and recipes. Another excellent cookbook that contains pawpaw recipes is Mark F. Sohn's [Mountain Country Cooking](#).  If you've found or developed a kitchen tested recipe, we'd sure appreciate hearing about it. You will certainly get credit for your contribution on our page or in a planned pawpaw cookbook. Here are some recipes. Enjoy!

Pawpaw Recipes

- [Pawpaw Ice Cream Pie](#)
- [Pawpaw Chiffon Pie](#)
- [Pawpaw Bread](#)
- [Pawpaw Cookies](#)
- [Pawpaw Smoothie](#)
- [Breakfast Drink](#)
- [Pawpaw Cake I](#)

- [Pawpaw Cake II](#)

Pawpaw Ice Cream Pie

- 2 cups strained pawpaw pulp
- 1 cup brown sugar
- 1 quart vanilla ice cream - softened
- 1 nine-inch graham cracker crust

Stir the brown sugar into the pulp until it is completely dissolved. Now fold this mixture into the softened ice cream. Pour this concoction into the graham cracker crust and place in freezer. Remove from freezer about 30 minutes before serving.

[Top of the page](#)

Pawpaw Chiffon Pie (borrowed from Euell Gibbons' Stalking the Wild Asparagus Quoted from pg 162 of the book: In a saucepan, mix together 1/2 cup of brown sugar, 1 envelope unflavored gelatin and 1/2 teaspoon of salt. Stir into this 2/3 cup of milk and 3 slightly beaten egg yolks. Cook and stir the mixture until it comes to a boil. Remove from the fire and stir in 1 full cup of strained pawpaw pulp. Chill until it mounds slightly when spooned. This will take 20 to 30 minutes in the refrigerator. Shortly before the mixture is sufficiently set, beat the 3 egg whites until they form soft peaks, then gradually add 1/4 cup of sugar, beating until stiff peaks form. Fold the partly set pawpaw mixture thoroughly into the egg whites. Pour into a 9-inch graham cracker crust...and chill until firm.

[Top of the page](#)

Pawpaw Bread

- 2 Cups sifted all-purpose flour

- 1 teaspoon soda
- 1/2 teaspoon salt
- 1/2 cup butter
- 1 cup sugar
- 2 eggs
- 1 cup pawpaw pulp
- 1/3 cup milk
- 1 teaspoon lemon juice
- 1/2 cup chopped nuts (1/3 at least, should be black walnuts)

Preheat oven to 350 degrees. Sift flour with soda and salt. Cream butter. Gradually add sugar, creaming well after each addition. Stir eggs and pawpaw pulp; blend thoroughly. Combine milk and lemon juice and add dry ingredients to pawpaw pulp alternately with liquids beginning and ending with dry ingredients. Stir in nuts.

[Top of the page](#)

Pawpaw Cookies

- 1 1/2 cups mashed pawpaw pulp
- 2 cups flour
- 1 teaspoon soda
- 1 teaspoon salt
- 1/2 cup butter
- 1 cup sugar
- 2 eggs

- 1 teaspoon grated lemon rind
- 1 cup chopped black walnuts

Preheat oven to 350 degrees. Press ripe pawpaws through food mill to obtain pulp. Sift together flour, soda, and salt. Cream butter and sugar; beat in eggs. Add lemon rind, flour mixture and pawpaw pulp. Fold in black walnuts. Drop on greased cookie sheet and bake for 15 minutes.

[Top of the page](#)

Pawpaw Smoothie (from Luisa Robles, graduate student at the University of Maryland and pawpaw fan:

- 1/2 cup pawpaw pulp
- 1 cup yogurt
- 2 teaspoons cinnamon
- 1 pinch nutmeg
- 5 drops lemon juice

Blend everything together until smooth

[Top of the page](#)

Pawpaw Breakfast Drink, also from Luisa. She adapted this from a drink she knew in Mexico by substituting pawpaw pulp for bananas: Prepare one can of frozen OJ in regular way. In a blender, mix about 1/2 cup orange juice with 2 cups pawpaw pulp. Blend briefly. Add the rest of the orange juice and mix well. "It makes a great breakfast when you are in a hurry, or a great snack between meals!"

Pawpaw Cake

- 2 1/4 cups cake flour (sift before measuring)
- 1/2 tsp baking powder

- **3/4 tsp baking soda**
- **1/2 tsp salt**
- **1/2 cup butter**
- **1 1/2 cups sugar**
- **2 eggs**
- **1 cup mashed pawpaw**
- **1 tsp vanilla**
- **1/4 cup yogurt or buttermilk**

Sift together flour, baking powder, baking soda and salt. Cream butter and sugar. Beat eggs into creamed butter-sugar mixture one at a time. Add vanilla and buttermilk or yogurt to pawpaw. Add the flour mixture to the butter mixture in 3 parts, alternating with the banana mixture. Stir the batter after each addition until smooth. Bake in greased pans in preheated 350 degree oven about 1/2 hour. When cool, sprinkle with powdered sugar.

[Top of the page](#)

Pawpaw Cake II from the Sept 27, 1995 *Frankfort State Journal*

- **1/4 C shortening**
- **1 C sugar**
- **1 1/4 C sifted all purpose flour**
- **1 tsp baking powder**
- **1 C mashed pawpaw pulp**
- **1 beaten egg**
- **1 tsp baking soda**

- **1 tsp vanilla**

Cream 1/4 cup shortening with 1 cup sugar. Add 1 well beaten egg and 1 cup mashed pawpaw. Sift together flour, baking powder and baking soda. Stir into the creamed mixture. Add vanilla and pour into an 8 inch square pan or two round layer cake pans. Bake at 375 degrees for 50 minutes. When cool, frost with cream cheese thinned with milk or any simple white frosting. Decorate with pawpaw slices.

[Top of the page](#)

[Return to Home Page](#)

Persimmon Cookbook

This is a sampling of some of the persimmon recipes we've run across, and we're providing them here by popular demand. Over the last several months, the response to our homepage about Pawpaws, Persimmons, Elderberries, etc has been somewhat overwhelming. While we emphasized Pawpaws and recipes thereof, there has been strong interest in Persimmon recipes. Still, the best single source for native plant info, lore and recipes is Euell Gibbon's

[Stalking the Wild Asparagus](#).  If you don't own it you should. Another excellent cookbook containing persimmon recipes is Mark F. Sohn's

[Mountain Country Cooking](#).  Finally, there are a couple of persimmon recipe books that are only available from small independent publishers.

They are "Persimmon Recipes" by Dymple Green, available for \$4 from Dymple's Delight, Rt 4, Box 53, Mitchell, IN 47446 and, "Old Fashioned Persimmon Recipes", available for around \$4 from [Bear Wallow Books](#), 7172 North Keystone Ave., Suite A, Indianapolis, IN 46240. So anyway, here goes. Hope you find something here you really like.

Persimmon Recipes

[Patrick Persimmon Pudding](#)

[Marguerite Hager's Persimmon Pudding](#)

[Persimmon Cake](#)

[Persimmon Pie](#)

[Persimmon Cookies](#)

[Persimmon Whip](#)

[Persimmon Cream Pie](#)

[Heavenly Persimmon Ice Cream Pie](#)

[Brown County Persimmon Fudge](#)

[Persimmon Jam](#)

The following four recipes work best with the Asian type persimmon:

[Persimmon Marmalade](#)

[Jellied Persimmon Salad](#)

[Persimmon-Almond Loaf with Orange Glaze](#)

[Persimmon Bread](#)

Fitzpatrick Persimmon Pudding

- 2 cups persimmon pulp
- 1 1/2 cups sugar
- 2 eggs, beaten
- 1 cup buttermilk
- 1 tsp baking soda
- 1 cup evaporated milk (canned)
- 2 cups flour
- 2 tsp baking powder
- 1/2 tsp cinnamon
- Pinch salt
- 1 tsp vanilla
- 1/4 cup cooking oil

Combine pulp, sugar and eggs. Stir baking soda into buttermilk. Add both milks to batter, then add the dry ingredients. Last add the vanilla and oil. Transfer batter to an oiled 9-by-13-inch baking dish or pan and bake in a preheated 325-degree oven one hour. This pudding will rise high and, when cool, fall some. It breaks away from the pan.

[Top of the page](#)

Persimmon Cake

- 2 cups persimmon pulp
- 1/2 teaspoon baking soda
- 1 cup milk
- 1/2 teaspoon salt

- 2 cups flour
- 1 tsp cinnamon
- 2 eggs
- 1/2 cup melted butter

Steam the persimmons just enough to loosen the seeds, but not enough to dissolve the skins. Run them through a food mill to take out seeds and skins. Measure 2 cups. Put pulp in the large bowl of mixer and mix the soda with it. Sift or stir together remaining dry ingredients. Add dry ingredients, milk, eggs and butter to the persimmon pulp and beat five minutes at medium speed. Turn batter into two greased and floured 8-inch layer cake pans and bake in a pre-heated 350-degree oven 60 to 70 minutes or until cake tests done. The cake will be a little chewy in the center, but absolutely delicious; turn out of pans and cool layers thoroughly before frosting.

Persimmon-Caramel Frosting

- 1 cup butter or margarine
- 2 cups brown sugar
- 1/2 cup persimmon pulp
- 1/2 tsp cinnamon
- 1/2 tsp nutmeg
- About 5 cups sifted confectioners' sugar
- 1 cup chopped nuts garnish (optional)

Melt butter in saucepan, Add brown sugar, and bring to boil. Add pulp and spices;boil again, stirring constantly. Remove from heat, and add enough confectioners' sugar to make desired consistency for spreading. Beat several minutes, and frost cake. If desired, press chopped nuts into sides of icing while still soft.

[Top of the page](#)

Persimmon Pie

- 1 egg
- 1 cup milk
- 1/2 cup sugar
- 1/8 tsp salt
- 1 Tbs cornstarch
- Cinnamon to taste
- 2 cups persimmon pulp
- 1 unbaked 9-inch pie shell

Combine egg, milk, sugar, salt, cornstarch, cinnamon and pulp. Pour mixture into pie shell and bake in a preheated 450-degree oven 10 minutes. Reduce heat to 350 degrees and bake 50 to 60

minutes longer. Serve with whipped cream.

[Top of the page](#)

Persimmon Cookies

- 1 cup persimmon pulp
- 1 cup nuts
- 1 cup raisins
- 1 cup sugar
- 1/2 cup shortening
- 1 tsp soda, dissolved in pulp
- 2 1/4 cup flour
- 1/2 tsp cinnamon
- 1/2 tsp ground cloves
- 1/2 tsp nutmeg
- 1 egg

Cream shortening and sugar. Add egg, soda and persimmon pulp. Add dry ingredients, nuts and raisins. Drop with teaspoon on greased cookie sheet. Bake for 10 minutes in 350-375 oven. Makes approx. 90 cookies.

[Top of the page](#)

Persimmon Whip

- 1/2 cup persimmon pulp
- 2 env unflavored gelatin
- 1 1/2 Tbs honey
- 2 tsp Lemon Juice
- 1 1/2 cup persimmon pulp
- 1/2 tsp salt
- 2 eggs whites, beaten stiff

Put 1/2 cup persimmon pulp into the top of a double boiler. Sprinkle gelatin over it and let it soak for 5 minutes. Heat over boiling water; stir until gelatin is dissolved. Remove from heat. Add honey, lemon juice, remaining persimmon pulp and salt. Pour into a bowl and cool. Refrigerate until almost set. Fold in stiffly beaten egg whites. Pour into serving dish and refrigerate several hours until it is set. Yields 6 servings.

[Top of the page](#)

Persimmon Cream Pie

Beat 2 eggs with 1/2 tsp cinnamon, 1/2 cup sugar and 1/4 tsp salt. Add 2 cups milk or cream, 1 cup persimmon pulp, 2 tablespoons melted butter and 1 teaspoon lemon juice. Pour into unbaked pie shell. Bake in very hot oven (450) 10 minutes, reduce temperature to 350 and bake 30 minutes longer. Let cool before slicing.

This recipe is from the Northwoods Nursery catalog (27635 S Oglesby Rd, Canby OR 97013).

[Top of the page](#)

Heavenly Persimmon Ice Cream Pie

- 1 pint vanilla ice cream, softened
- 2 cups persimmon pulp
- 1 1/2 cups sugar
- 1/2 tsp salt
- 1 tsp cinnamon
- 1/2 tsp ginger
- 1 tsp vanilla
- 1 1/2 cups Cool Whip
- 1/2 cup slivered almonds
- Spread ice cream in graham cracker pie shell and chill in freezer. Combine pulp with the 1 1/2 cups sugar, salt, spices and vanilla. Fold in 1 cup Cool Whip. Pour mixture over ice cream in pie shell. Cover with foil and freeze 4 hours. Remove from freezer and garnish with remaining 1/2 cup of Cool Whip and almonds..

[Top of the page](#)

Brown County Persimmon Fudge

- 1 cup persimmon pulp
- 6 cups sugar
- 2 1/2 cups milk
- 1/2 cup light corn syrup
- 1/2 cup butter (or margarine)

Combine pulp, sugar, milk and syrup in large sauce pan. Cook slowly 1 1/2 to 2 hrs until mixture reaches soft ball stage or (230 degrees F) Cool to lukewarm. Stir often. Add butter. Beat well. When mixture begins to thicken, stir in 1 cup chopped nuts. Spread in buttered 8 1/2 x 13 inch pan.

[Top of the page](#)

Persimmon Jam (From the Ortho Canning Book - 1982 and sent to us by M. Schoewe)

- 4# (about 10 very large) persimmons (these are obviously Oriental Persimmons)
- 4 c sugar

Cut persimmons in half & scrape out the pulp. Put pulp through a food mill to puree. Measure out 4 c. pulp. Put pulp & sugar into a pot & stir well until thick - about 30 minutes. Keep below boiling point or the jam will become bitter

Ladle jam into jars & seal with melted paraffin or process. The jam will thicken after it cooks.

[Top of the page](#)

Persimmon Marmalade

- 1 quart peeled persimmons
- 1 c water
- Juice of 1 lemon
- Sugar

Combine persimmons and water. Boil to a thick pulp, add juice of lemon and cup of sugar to each quart of pulp. Boil 10 minutes longer. Pour into sterilized jars and seal.

[Top of the page](#)

Marguerite Hager's Persimmon Pudding

This new recipe was sent in by R. Dennis Hager from Maryland. It looks great.

- 2 cups persimmon pulp
- 2 cups milk
- 1 tsp vanilla
- 1 1/2 cups sugar
- 2 1/2 cups self-rising flour
- 2 eggs
- 1 cup melted butter

Blend ingredients well, adding butter last. Pour in greased 9 x 12 pan and bake at 350 F for 1 hour.

Dennis says, "This pudding is very rich. It keeps well and the flavor continues to develop. It is best when 2-3 days old. The crust has a great flavor. The next time I make it, I'm going to try

smaller pans, so there will be more crust!"

[Top of the page](#)

Jellied Persimmon Salad

- 1 small package orange gelatin
- 1 cup hot water
- 2 cups persimmon pulp
- 1 Tbs lemon juice
- 1/2 cup finely chopped celery

Dissolve gelatin in hot water. Add persimmon pulp and lemon juice. Cool, then fold in celery. Pour into oiled ring mold or individual molds and chill

[Top of the page](#)

Persimmon-Almond Loaf with Orange Glaze This recipe and the next one for Persimmon Loaf were sent to us by Andi in California (Thanks Andi) "Fragrant and fruity, this persimmon loaf is my variation on an old-fashioned date tea bread. With its sweet and nutty flavors, it is a favorite of both children and adults for brunch or for lunch with chicken salad. Orange Glaze makes a perfect topping for this quick bread.."

- 2 cups unbleached all-purpose flour
- 1 1/2 tsp baking soda
- 1 tsp baking powder
- 1 tsp ground cinnamon
- 1/2 tsp salt
- 1/4 tsp freshly ground nutmeg
- 2 large ripe persimmons (about 1 pound)
- 8 Tbs (1 stick) unsalted butter, at room temperature
- 1/2 C sugar
- 1 large egg
- 1/4 C sour cream
- 2 tsp almond extract
- 1 C dried apricots or peaches, chopped
- 1/2 C toasted sliced almonds

First, adjust an oven rack to the middle shelf and preheat the oven to 350 degrees. Lightly butter an 8 1/2 x 4 1/2 x 2 1/2 inch loaf pan. Second, sift together the flour, baking soda, baking powder, cinnamon, salt, and nutmeg into a mixing bowl. Set aside. Next, peel the

persimmon and scoop the flesh into a medium-size mixing bowl. Mash with a fork. Set aside. Now, using an electric mixer, beat the butter and sugar at medium high speed until light and fluffy. Add the egg and beat until thoroughly combined. Add the persimmon pulp, sour cream, and almond extract. Blend at low speed to combine the ingredients. The mixture will look curdled. Add the sifted flour mixture, 1/2 cup at a time, and beat at low speed until the batter is smooth, stopping occasionally to scrape down the sides of the work bowl with a spatula. Fold in the chopped apricots and toasted almonds. The batter will be very dense and sticky. Scrape the batter into the prepared loaf pan. Bake until a toothpick inserted in the center of the loaf comes out clean, about one hour. Cool the bread in the pan on a rack for about 20 minutes before unmolding. Unmold and spread with Orange Glaze.

Orange Glace

- 2 tsp cornstarch
- 1/2 C fresh orange juice
- 1/2 C thawed frozen orange juice concentrate
- 1 1/2 Tbs unsalted butter
- 2 Tbs confectioners' sugar
- 1/2 tsp almond extract

[Top of the page](#)

Persimmon Bread

- 1 C persimmon pulp
- 1/2 C chopped persimmon
- 1/2 C butter
- 1 C sugar
- 2 beaten eggs
- 1 3/4 C flour
- 1 tsp baking soda
- 1 tsp baking powder
- 1/2 tsp salt
- 1/2 C nuts

Mix together butter, sugar and eggs. Sift together dry ingredients except baking soda, which you add to persimmon pulp. Add persimmon pulp. Fold in dry ingredients. Add chopped persimmon and nuts. Pour into buttered 8 x 11 inch pan and bake 45 minutes at 325 degrees, or until toothpick inserted in middle of loaf comes out clean. Andi says this is very good.

[Top of the page](#)

Elderberry Recipes

Though Jeannie and I don't claim to be experts on the elderberry and its uses, we have enjoyed the fruit for many years. Over the past several weeks there have been many email requests for recipes as people have discovered the ripening berries. Well this list is far from exhaustive, but it's a start. Hope you find something you can use.

- [Elderberry Jelly](#)
- [Elderberry Jam](#)
- [Elderberry Pie](#)
- [Gleckler's Elderberry Pie](#)
- [Elderberry Wine](#)
- [Julie's Wine #1](#)
- [Julie's Wine #2](#)
- [Elderberry Ice Cream](#)
- [Elderberry Ice Cream Easy Method](#)

Sure-Jell Elderberry Jelly

6 quarts or 3 lbs elderberries

2 lemons

Remove stems and crush. Place in saucepan. Bring to boil slowly until juice starts to flow. Reduce heat; cover and simmer 15 minutes. Place 3 layers of damp cheesecloth or jelly bag in large bowl. Pour prepared fruit into cheesecloth. Tie cheesecloth closed, hang and let drip into bowl until dripping stops. Press gently. Measure juice. If necessary, add up to 1/2 cup water for exact measure. Ingredients are now:

3 C juice

1/4 C fresh lemon juice

4 1/2 C sugar

Stir Sure-Jell into juice and add lemon juice. Bring mixture to full rolling boil. Add sugar quickly. Return to full boil and boil exactly one minute, stirring constantly. Immediately fill jars and seal.

[Top of the page](#)

Elderberry Jam from the *Ball Blue Book*

2 quarts crushed elderberries

6 C sugar

1/4 C vinegar

Combine berries, sugar and vinegar. Bring slowly to boiling, stirring occasionally until sugar dissolves. Cook rapidly until thick. As mixture thickens, stir frequently to prevent sticking. Pour, boiling hot, into sterilized jars. Adjust caps. Yield: about 3 pints.

[Top of the page](#)

Elderberry Pie

1 recipe Plain Pastry or frozen pie crust

2 1/2 C stemmed elderberries

1/2 C sugar

1/8 t salt

2 T flour

3 T lemon juice

Line a piepan with pastry. Fill with elderberries. Mix sugar, salt and flour; sprinkle over berries. Add lemon juice. Cover with top crust. Bake in very hot oven (450 degrees) 10 minutes, reduce temperature to moderate (350 degrees) and bake 30 minutes longer. This recipe is from the 1950 *Culinary Arts Institute Encyclopedic Cookbook*.

[Top of the page](#)

Gleckler's Elderberry Pie

This recipe was sent in by Marianne Gleckler of Metamora, Ohio. It's her husband's grandmother's recipe, and "it's very good."

3 C elderberries

3/4 C white sugar

1/4 C brown sugar

1 T vinegar

1/4 t salt

4 T corn starch or tapioca pudding mix (I use pudding mix)

Pat with butter

Makes a 9 inch 2 crust pie

[Top of the page](#)

Elderberry Wine

This wine is very much like a cream sherry. These are the ingredients for 1 gal wine.

3 1/2 lbs. elderberries

3 lbs. sugar

7 pints water

Sherry or all-purpose wine yeast

Nutrient

Crush the fruit in a plastic pail and add one quart of boiled water that has cooled. Mix well.

Crush one Campden tablet and dissolve the powder in about 1/2 C warm water and mix with fruit pulp. Leave the mixture in a cool place for 24 hours, stirring twice during that time. Strain through fine muslin or other similar material and squeeze gently but not too hard. Discard fruit pulp.

Boil 1 lb of sugar in 2 quarts water for 1 minute and allow to cool. Mix this with the juice and return the lot to the plastic pail. Add yeast and ferment for 10 days.

Pour off the top wine into a gallon jar, leaving as much of the deposit behind as possible. Boil another 1 lb of sugar in 1 C water for 1 minute and when cool add to rest. Plug the neck of the jar with cotton or install a fermentation lock and ferment in a warm place for 14 days.

After this, boil the last 1 lb of sugar in the remaining cup of water for one minute; cool, add to rest. Refit lock or cotton and leave in warm place until all fermentation has ceased.

Rack into sterilized wine bottles and cork. Try to wait at least six months to drink.

[Top of the page](#)

Elderberry Ice Cream from John Kennett (100657.2473@compuserv.com)

"First pick your elderberries. The easiest way is to snip off whole bunches, and then strip the individual berries off using the prongs of a fork at your leisure. I picked about half a carrier bag of bunches, which came out to a big saucepan of berries.

Put the berries into a saucepan with a little water, a sprinkling of sugar and the juice of half a lemon. Go steady on the sugar, you can always add more later if you need to.

With a lid on the saucepan, gently simmer for about 45 minutes, or until the berries have gone very soft. Leave to cool, and then push the berries through a sieve, discarding the pips that remain. This will leave a rich elderberry syrup. Taste it, and add more sugar if required. As a guide I had about a pint of syrup at the end.

Whip half a pint of double cream until it stands in peaks, and in a separate bowl whisk two eggwhites until they are stiff enough to tip the bowl upside down. This can be quite a feat with a hand whisk!

Fold the cream, eggwhites and elderberry syrup together gently, until the whole mixture is a uniform lurid purple. Pour into a suitable freezer container - I used a pyrex glass bowl. Then stick it into your freezer."

**Elderberry Ice Cream from Natalie with a quick method for freezing.
(nat88keys@yahoo.com)**

1 small bath towel

1 gallon-sized zipper seal bag

2 sandwich-sized zipper seal bags

1 1/2 cups rock salt

25-30 ice cubes

Desired amount of milk, half and half, or cream

Desired amount of sugar

Elderberry syrup (from recipe above)

"Mix milk, half and half, or cream with desired amount of sugar and syrup. (I find that the best ice cream comes from half and half topped with a LITTLE BIT of whole milk. Skim milk turns out runny with small

ice chunks, and both light and heavy whipping cream don't freeze well, and become more of a 'mush') A tall cup or medium bowl and a spoon works well.

Once well-blended, pour into sandwich-sized bag, and seal. Place this bag inside the other sandwich-sized bag, and seal.

Place ice cubes and rock salt into gallon-sized bag. The ice cubes should occupy about 1/3 of the bag. Place sandwich bags inside bag containing rock salt and ice, and seal. Wrap in towel and shake vigorously for 4-5 minutes. (You may want to take turns with a friend. My arms sometimes get tired from all the shakin'.)

When ice cream has thickened, remove sandwich bags, and scoop (or pour) into bowls. Double bagging the ice cream keeps rock salt from falling into the bag and getting the ice cream salty. Yuck!" Natalie goes on to say you can try other flavors with this method. Thanks Natalie.

[Top of the page](#)

[Return to Home Page](#)

Shop in **Health & Personal Care** **amazon.com** VIEW CART | WISH LIST | YOUR ACCOUNT | HELP Your Gold Box

(Beta-What is this?) WELCOME YOUR STORE **BOOKS** APPAREL & ACCESSORIES ELECTRONICS TOYS & GAMES DVD CAMERA & PHOTO SEE MORE STORES

Search | Browse Subjects | Bestsellers | Magazines | Corporate Accounts | e-books & docs | Bargain Books | Used Books

Shop our spring selection in **Apparel** [Shop now](#)

Search Inside the Book™

SEARCH

WEB SEARCH

Powered by Google

Welcome to Books!
Click here to explore more.

Top Sellers in Books:

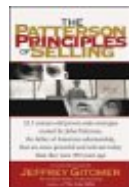

- [The Patterson Principles of Selling](#) by Jeffrey Gitomer (Author)
- [Eats, Shoots & Leaves](#) by Lynne Truss
- [The South Beach Diet](#) by Arthur Agatston (Author)

BOOK INFORMATION

[buying info](#)
[editorial reviews](#)
[customer reviews](#)

RATE THIS BOOK

Uncommon Fruits Worthy of Attention: A Gardener's Guide
by [Lee Reich](#), [Vicki Herzfeld Alein](#)

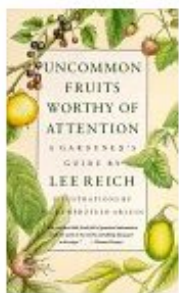

Availability:
Usually ships within 1-2 business days

8 used & new from \$13.82

Edition: Paperback

[see larger photo](#)

Other Editions:	List Price:	Our Price:	Other Offers:
Hardcover	\$18.90		2 used & new from \$14.00

[See more product details](#)

Product Details

- Paperback:** ; Dimensions (in inches): 0.75 x 8.75 x 5.50
- Publisher:** Perseus Publishing; Reprint edition (April 1992)
- ISBN:** 0201608200
- Other Editions:** [Hardcover](#) | [All Editions](#)
- Average Customer Review:** ★★★★★ Based on 1 review. [Write a review.](#)
- Amazon.com Sales Rank:** 453,887 (Publishers and authors: [improve your sales](#))

What's Your Advice?

Is there an item you'd recommend instead of or in addition to this one? Let the world know! Enter the item's ASIN ([what's an ASIN?](#)) in the box below, select advice type, then click Submit.

I recommend: _____ in addition to this book
_____ instead of this book

Editorial Reviews

READY TO BUY?

8 used & new from \$13.82

[See all buying options](#)

Have one to sell? [Sell yours here](#)

Don't have one?
We'll set one up for you.

I dislike it

I love it!

1 2 3 4 5

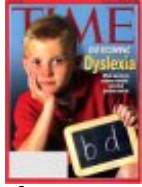
[Edit your ratings](#)**Favorite Magazines!**Explore our new
[Magazine Subscriptions](#)
store.**From Publishers Weekly**

Reich's is indeed a "worthy" addition to the gardening reference shelf, packed with information not readily found elsewhere. The author, a contributor to Horticulture and The New York Times, writes gracefully and knowledgeably about more than 20 fruit species easily grown in North America's temperate climate. Gardeners tired of the same old apples and pears will relish the prospect of growing such exotic fruits as the maypop, a cold-hardy passionfruit, the enticingly fragrant clove currant and the diminutive but intensely flavorful alpine strawberry. Part of what makes these fruits worthy of attention is that they are surprisingly easy to grow; they require far less spraying and pruning than their more commonly cultivated cousins, and--best of all for Northern gardeners--they demand some degree of winter cold. Reich provides detailed information, leavened with anecdotes and quotes from sources ancient and modern, on each fruit's cultivation, propagation, harvest and use, plus a list of cultivars. Appendixes cover botanical nomenclature, how to plant, propagate and care for the fruits and, last but not least, where to purchase them. Illustrations not seen by PW.

Copyright 1991 Reed Business Information, Inc. --*This text refers to an out of print or unavailable edition of this title.*

From Library Journal

This delightful book describes 19 fruits including maypops, pawpaws, medlars, jujubes, and Asian pears. Fruits were selected for being at home in a temperate climate, tasting good to eat out of hand, requiring minimal upkeep, and possessing ornamental beauty. For each, the compact, authoritative, and interesting text offers history, description, propagation, harvest, uses, and cultivars. A precise vocabulary--"frugiverous, frass, bletting"--sparkles in a clearly written text that is never overly... [▶ read more](#) --*This text refers to an out of print or unavailable edition of this title.*

[▶ See all editorial reviews...](#)**All Customer Reviews**

Average Customer Review: ★★★★★

[Write an online review](#) and share your thoughts with other customers.

8 of 8 people found the following review helpful:

★★★★★ A taste teaser! I want to get these plants!,
September 11, 2000Reviewer: OTMAR E VARELA P from New Orleans, Louisiana
USA

This book is, first of all, a wonderful read. It is full of historical notes, very interesting to this nonbotanist, and is fully researched. Advances have been made since it was written, and perhaps some of the suppliers given in the back are no longer with us; but a good web search will remedy that. It describes the flavors, scents, and appearance of the fruits in succulent detail. Since I have read it, I have been buying and trying to get friends to buy the various fruits listed. It is torture not being able to go out and buy jujubes, gumis, hardy kiwi, pawpaws, and all the rest of the children of Pomona that are here delineated. A wonderful book, full of charming oddities and wit.

Was this review helpful to you?

Customers who bought titles by Lee Reich also bought titles by these authors:

- [Stella B. Otto](#)
- [Tracy Disabato-Aust](#)
- [Ruth Stout](#)
- [Lewis Hill](#)
- [Patricia Lanza](#)

▶ [Explore similar authors](#)

Listmania!

- [If I would live in an island in the middle of the sea](#): A list by [eve-mary](#), my dream

Look for similar books by subject:

Browse for [books](#) in:

- [Subjects](#) > [Home & Garden](#) > [Gardening & Horticulture](#) > [Fruit](#)
- [Subjects](#) > [Home & Garden](#) > [Gardening & Horticulture](#) > [General](#)

Search for books by subject:

[Fruit](#)
[Fruit-culture](#)
[Gardening / Horticulture](#)
[Technology](#)
[Agriculture - General](#)
[Gardening](#)

i.e., each book must be in subject 1 AND subject 2 AND ...

Feedback

- **I have read this book, and I want to [review](#) it.**
- [E-mail a friend about this book.](#)
- [Write a So You'd Like to... guide.](#)
- Is there a specific product you'd like us to sell? [Tell us](#) about it.



Suggestion Box

Your comments can help make our site better for everyone. If you've found something incorrect, broken, or frustrating on this page, let us know so that we can improve it. Please note that we are unable to respond directly to suggestions made via this form.

If you need help with an order, please [contact Customer Service](#).

Please mark as many of the following boxes that apply:

Product information is missing important details.

Product information is incorrect. Propose corrections using our [Online Catalog Update Form](#).

The page contains typographical errors.

The page takes too long to load.

The page has a software bug in it.

Content violates [Amazon.com's policy on offensive language](#).

Product offered violates [Amazon.com's policy](#) on items that can be listed for sale.

Comments or Examples:

Examples: Missing information such as dimensions and model number, typos, inaccuracies, etc.

<p>Where's My Stuff?</p> <ul style="list-style-type: none"> Track your recent orders. View or change your orders in Your Account. 	<p>Shipping & Returns</p> <ul style="list-style-type: none"> See our shipping rates & policies. Return an item (here's our Returns Policy). 	<p>Need Help?</p> <ul style="list-style-type: none"> Forgot your password? Click here. Redeem or buy a gift certificate. Visit our Help department.
<p>Search for</p>		

A \$20 Special Offer from KitchenAid



Receive \$20 cash back after mail-in rebate when you purchase select KitchenAid [stand mixers](#) offered by Amazon.com.

Farberware Deal

\$15 Offer

Save \$15 on a future purchase when you spend \$50 on [Farberware](#) cookware. [Here's how](#).

Up to 50% Off Reconditioned Housewares

Save up to **50%**

Save big on select [reconditioned housewares](#) offered by Amazon.com, including products from Dyson, Bissell, and Singer.

Turn your past books purchases into \$\$\$
[Learn more](#) about selling at Amazon.com today!

[Top of Page](#)

[Books Search](#) | [Browse Subjects](#) | [Bestsellers](#) | [Magazines](#) | [Corporate Accounts](#)
[e-Books & Docs](#) | [Bargain Books](#) | [Used Books](#)

[Amazon.com Home](#) | [Directory of All Stores](#)

Our International Sites: [Canada](#) | [United Kingdom](#) | [Germany](#) | [Japan](#) | [France](#)

[Contact Us](#) | [Help](#) | [Shopping Cart](#) | [Your Account](#) | [Sell Items](#) | [1-Click Settings](#)

[Investor Relations](#) | [Press Releases](#) | [Join Our Staff](#)

Bottom of the Page™ Deals for May 10

Amazon.com = low prices. Save up to 50% on these great deals, updated every day at noon (central time).

	Our Price	You Save
Wusthof Silverpoint 8310 10-Piece Block Set The perfect starter knife set for your new kitchen.	\$69.99	\$195.01 (74%)
Ultrasonex SB300U Rechargeable Toothbrush with 3 Replacement Brush Heads Removes more plaque than even the most manic manual brushing could.	\$16.99	\$33.00 (66%)
Viking 1 GB CompactFlash Card (CF1GB) A fantastic price on a topnotch CompactFlash card.	\$180.54	\$99.45 (36%)
Calphalon Commercial Hard-Anodized 12-Inch Everyday Pan with Lid Does everything from simmering stovetop succotash to browning beef brisket.	\$24.99	\$143.01 (85%)
CarbWise Delicious Crispy Bars, Chocolate S'mores Crunch (12 Bars) Tired of those rubbery-tasting protein bars? These are for you.	\$17.99	\$2.00 (10%)
Prilosec OTC Acid Reducer, Delayed-Release Tablets (28 Tablets) Show that double-cheeseburger who's boss.	\$16.99	\$0.96 (5%)
Dryel Refill Cloths, Original Fresh Scent - 6 ea A convenient way to care for wools, silks, and other special-care fabrics.	\$6.99	
Olay Regenerist Daily Regenerating Serum, Fragrance Free, 1.7 Fluid Ounces Regenerates your appearance without drastic measures as chemical peels.	\$9.99	\$3.96 (28%)
Neutrogena Visibly Firm Night Cream, Active Copper Formula - 1.7 oz Moisturizing cream for smoother, younger-looking skin.	\$13.99	\$3.56 (20%)

 **FREE Super Saver Shipping on orders over \$25.** [See details.](#)

Amazon.com now offers bargains on brand-name essentials, all priced so low they've sunk to the bottom of the page! We take up to 50% off standard retail prices and deliver right to your door--no club fees, no hassle, no parking lot. These offers are only good until they're gone. Check back every day at noon (central time) for all-new Bottom of the Page™ Deals.

[Conditions of Use](#) | [Privacy Notice](#) © 1996-2004, Amazon.com, Inc. or its affiliates



amazon.com



VIEW CART

WISH LIST

YOUR ACCOUNT

HELP



Your Gold Box

WELCOME

YOUR STORE

BOOKS

APPAREL & ACCESSORIES

ELECTRONICS

TOYS & GAMES

DVD

CAMERA & PHOTO

SEE MORE STORES

Search

Browse Subjects

Bestsellers

Magazines

Corporate Accounts

e-books & docs

Bargain Books

Used Books

Search:

Browse:



Cool summer footwear for all.



You clicked on this item...

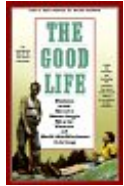

The Good Life

by [Scott Nearing](#) (Author), [Helen Nearing](#) (Author)

Average Customer Review: ★★★★★

Usually ships in 24 hours

List Price: \$15.00

Price: **\$10.50**

You Save: \$4.50 (30%)

[43 used & new](#) from \$8.90



Eligible for **FREE Super Saver Shipping** on orders over \$25. [See details.](#)

Or [buy used](#): **\$8.90**

From the Publisher

"Helen and Scott Nearing are the great-grandparents of the back-to-the-land movement, having abandoned the city in 1932 for a rural life based on self-reliance, good health, and a minimum of cash...Fascinating, timely, and wholly useful, a mix of the Nearings' challenging philosophy and expert..."

[Read more](#)

You may also be interested in these items...

[More results](#)

Show items from:

▶ All Products

[Books](#) (20)

[DVD](#) (10)

[Music](#) (5)

[Toys & Games](#) (1)



Loving and Leaving the Good Life

by Helen Nearing

[More like this](#)



The Making of a Radical

by Scott Nearing

[More like this](#)



Living the Good Life

by Helen Nearing, et al

[More like this](#)

Show items that are:



 **Simple Food for the Good Life**
by Helen Nearing, Barbara Damrosch

[More like this](#)



 **Wise Words for the Good Life (Good Life Series)**
by Helen Nearing (Introduction), Anne Sheble

[More like this](#)



 **Five Acres and Independence**
by Maurice G. Kains (Author)

[More like this](#)



 **Scott Nearing**
by John A. Saltmarsh

[More like this](#)



 **The Maple Sugar Book**
by Helen Nearing, et al

[More like this](#)

 **CONTINUING GOOD LIFE**
by Helen Nearing (Author)

[More like this](#)

You may also be interested in these authors...

[More results](#) 

- [Eliot Coleman](#)
- [Maurice Grenville Kains](#)
- [John A. Saltmarsh](#)
- [Linda Breen Pierce](#)
- [Carla Emery](#)

A \$20 Special Offer from KitchenAid



Receive \$20 cash back after mail-in rebate when you purchase select KitchenAid [stand mixers](#) offered by Amazon.com.

Farberware Deal

\$15 Offer

Save \$15 on a future purchase when you spend \$50 on [Farberware](#) cookware. [Here's how.](#)

Up to 50% Off Reconditioned Housewares

Save up to **50%**

Save big on select [reconditioned housewares](#) offered by Amazon.com, including products from Dyson, Bissell, and Singer.

Where's My Stuff?

- Track your [recent orders](#).
- View or change your orders in [Your Account](#).

Shipping & Returns

- See our [shipping rates & policies](#).
- [Return](#) an item (here's our [Returns Policy](#)).

Need Help?

- Forgot your password? [Click here](#).
- [Redeem](#) or [buy](#) a gift certificate.
- [Visit our Help department](#).

Search **for**

Your Recent History
[Learn More](#)

Recently Viewed Products

 [Uncommon Fruits Worthy of Attention](#) by Lee Reich, Vicki Herzfeld Alein

▶ [Visit the Page You Made](#)

Turn your past books purchases into \$\$\$
[Learn more](#) about selling at Amazon.com today!

[Top of Page](#)

[Books Search](#) | [Browse Subjects](#) | [Bestsellers](#) | [Magazines](#) | [Corporate Accounts](#)
[e-Books & Docs](#) | [Bargain Books](#) | [Used Books](#)

[Amazon.com Home](#) | [Directory of All Stores](#)

Our International Sites: [Canada](#) | [United Kingdom](#) | [Germany](#) | [Japan](#) | [France](#)

[Contact Us](#) | [Help](#) | [Shopping Cart](#) | [Your Account](#) | [Sell Items](#) | [1-Click Settings](#)

[Investor Relations](#) | [Press Releases](#) | [Join Our Staff](#)

Bottom of the Page™ Deals for May 10

Amazon.com = low prices. Save up to **50%** on these great deals, updated every day at noon (central time).

	Our Price	You Save
Wusthof Silverpoint 8310 10-Piece Block Set The perfect starter knife set for your new kitchen.	\$69.99	\$195.01 (74%)
Ultrasonex SB300U Rechargeable Toothbrush with 3 Replacement Brush Heads Removes more plaque than even the most manic manual brushing could.	\$16.99	\$33.00 (66%)
Viking 1 GB CompactFlash Card (CF1GB) A fantastic price on a topnotch CompactFlash card.	\$180.54	\$99.45 (36%)
Calphalon Commercial Hard-Anodized 12-Inch Everyday Pan with Lid Does everything from simmering stovetop succotash to browning beef brisket.	\$24.99	\$143.01 (85%)
CarbWise Delicious Crispy Bars, Chocolate S'mores Crunch (12 Bars) Tired of those rubbery-tasting protein bars? These are for you.	\$17.99	\$2.00 (10%)
Prilosec OTC Acid Reducer, Delayed-Release Tablets (28 Tablets) Show that double-cheeseburger who's boss.	\$16.99	\$0.96 (5%)
Dryel Refill Cloths, Original Fresh Scent - 6 ea A convenient way to care for wools, silks, and other special-care fabrics.	\$6.99	
Olay Regenerist Daily Regenerating Serum, Fragrance Free, 1.7 Fluid Ounces Regenerates your appearance without drastic measures as chemical peels.	\$9.99	\$3.96 (28%)
Neutrogena Visibly Firm Night Cream, Active Copper Formula - 1.7 oz Moisturizing cream for smoother, younger-looking skin.	\$13.99	\$3.56 (20%)

 **FREE Super Saver Shipping on orders over \$25.** [See details.](#)

Amazon.com now offers bargains on brand-name essentials, all priced so low they've sunk to the bottom of the page! We take up to 50% off standard retail prices and deliver right to your door--no club fees, no hassle, no parking lot. These offers are only good until they're gone. Check back every day at noon (central time) for all-new Bottom of the Page™ Deals.

[Conditions of Use](#) | [Privacy Notice](#) © 1996-2004, Amazon.com, Inc. or its affiliates



Pawpaw Information Web Site

Frankfort, Kentucky

Pawpaw Links

[Personnel](#)

[Pawpaw Workshop](#)

NEW

[Pawpaw Video](#) **NEW**

[Pawpaw Research at Kentucky State University](#)

[Reports and Publications](#)

[PowerPoint Presentations](#)

[Pawpaw FAQ](#)

[Planting Guide](#)

[Cultivars](#) **NEW**

[Nurseries](#)

[Description of Fruit and Nutritional Information](#)

[Recipes](#)

[Photo Gallery](#)

[Audio & Video](#)



[Conferences & Events](#)



Pawpaw Program

[Kentucky State University](#) has the only full-time pawpaw [*Asimina triloba* (L.) Dunal] research program in the world as part of the [KSU Land Grant Program](#).

Pawpaw research efforts are directed at improving seed and clonal propagation methods, developing orchard management recommendations, conducting regional variety trials, understanding fruit ripening processes, developing fruit storage techniques, and germplasm collection and characterization of genetic diversity. KSU also is the home of the [PawPaw Foundation](#), a nonprofit organization dedicated to the research and development of pawpaw as a new fruit crop.

[2nd International
Pawpaw Conference
Proceedings](#)

[Grower budgets](#) 

[Organic Production
and SARE](#)

[The PawPaw
Foundation](#)

[Pawpaw
Bibliography](#)

[Health: Pawpaws
and Parkinsons?](#)

[Links to other
Pawpaw web sites](#)

[Links to other
horticultural and
botanical sites](#)

[Grape Research at
KSU](#)



The USDA National Clonal Repository for *Asimina* spp.

Since 1994, Kentucky State University has served as the USDA National Clonal Germplasm Repository (NCGR), or gene bank, for *Asimina* spp. (pawpaw), as a satellite site of the [NCGR repository](#) at Corvallis, OR. There are over 1,700 accessions (trees) from 17 states that are planted on 8 acres at the KSU farm. We are attempting to evaluate the genetic diversity contained in wild pawpaw populations across its native range so that unique material can be added to the [KYSU repository](#) collection; this potentially rich source of useful genetic traits will be used in breeding efforts.



Top photo of flower and cluster taken on April 24, 2004 by Kirk Pomper. Lower photo of single cluster pawpaw by Scott Bauer.

Questions about pawpaws? Contact Dr. Kirk Pomper at:
kpomper@dcr.net or telephone # 502-597-5942

[|Top|](#) [|KSU Home Page|](#) [|KSU Land Grant Page|](#) [|CV of Kirk W. Pomper|](#)

Visitors since November 13, 2003:

11838

Updated May 05, 2004

Webmaster: Stella Mountain

I wrote this article for [my local Audubon](#) newsletter a couple of few years ago.

Jump down to [lots of Pawpaw links](#).

Pawpaws: A Paw for You and a Paw for Me



The Autumn birding hike of October 10th was not very productive in terms of birds. However, during the course of the hike, several of the participants got their first introduction to the Pawpaw, *Asimina triloba*. The name of this plant is sometimes spelled Papaw - and in that form is often confused with another fruit that sometimes goes by that name, the Papaya, *Carica papaya*. (The latter is in a totally different family than our Pawpaw, and can only grow in tropical areas.)

Our Pawpaw, which grows as far north as New York and southern Ontario, out west as far as Nebraska and Texas, and south to Florida, is known by several other names including the American Custard Apple, the West Virginia Banana, and the Indiana Banana. There are about seven other members of the genus *Asimina*, all growing in the southeastern U.S.

The Pawpaw made some headlines in 1992 when it was reported that a Purdue University researcher had isolated a powerful anti-cancer drug, as well as a safe natural pesticide from the Pawpaw tree. The substances are said to be primarily found in the twigs and small branches. The researcher, [Jerry McLaughlin](#), revealed that it was because of some childhood experiences with eating the fruit that he had a feeling that there was something biologically active in the plant.

In the book, Sturtevant's Edible Plants of the World, one finds the Pawpaw fruit called "...a natural custard, too luscious for the relish of most people. The fruit is nutritious and a great resource to the savages." Millspaugh, in American Medicinal Plants, describes the fruit as "soft, sweet and insipid, having a taste somewhat between that of the May-apple and the banana, tending to the former." The Peterson Field Guide mentions that the seeds, along with being an emetic, have narcotic properties.

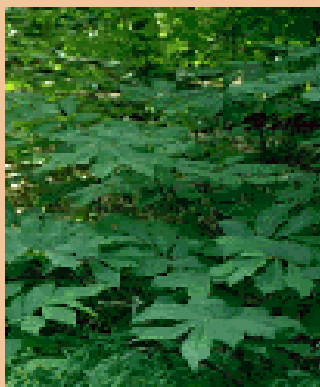

As late as the early 1900's, fishermen in the Ohio valley were using strips of the inner bark for stringing fish. They likely learned this use from the Indians, who used these bark strips to make fabric and nets. It is also thought that the Indians may have been responsible for extending the range of the Pawpaw far beyond its natural growing area.

Closer to home, a West Virginian and DC resident, [Neal Peterson](#), has been conducting a Pawpaw research study for the past eight years at the [Western Maryland Research and Education Center](#) near Keedysville. He has 600 trees planted on the Center's property and has been evaluating the fruit from the individual trees with an aim to choose the ten "best" trees in his orchard in order to begin producing the most tasty Pawpaws

possible. Peterson hopes to bring Pawpaws to the mass market.

Note: October, 1997: I found a listing for Paw Paws on the [NCSU Poisonous Plants of North Carolina Page](#). Apparently some individuals cannot eat them without severe stomach and intestinal pain.

Note: Pawpaw Flower picture by [Will Cook](#)

Note: Another green fruit that can be found in some places along the canal - this one in late fall - is the [Osage Orange](#). These fruits are about the size of baseballs and look like brains.... Some aver that they keep spiders away. There are a lot of these trees in the Antietam Campground area of the C and O Canal. (Mile 70 or so)



Pawpaw Links

[Distribution Map for the Pawpaw](#)	[Good Paw Paw Page from CRFG](#)	[Barry Glick Article](#)
[Paw Paw Links from U.C. Davis](#)	[Kentucky State University Pawpaw Research Project](#)	
[Alta Vista Search for Asimina triloba](#)	[The Paw Paw Tunnel Page](#)	

- [April 16, 2001 NPR Story](#) - Return of the Pawpaw -- Fred Kight reports from Athens, Ohio, on the comeback of the pawpaw, a green-and-yellow fruit native to North America, but with a tropical flavor. Some say it could be a replacement crop for farmers no longer growing tobacco. (3:42)
- [Must the Rare and Historic Paw Paw Tree be Destroyed?](#)
- [Purdue University's New Crop Server Pawpaw Page](#)
- [Midwest Fruit Explorers Pawpaw Page](#) includes nice picture of the fruit
- [Brooklyn Botanical Garden](#) Nice close-up of flower
- [Forest Service](#)
- [Mrs. Grieve's Herbal Entry for Pawpaw](#)
- [King's American Dispensatory Entry for Pawpaw](#)
- [Plants For A Future - Database Search Results](#)
- [Zebra Swallowtail Butterfly](#) - Its only larval host is Paw Paw - with pictures.
- [Pawpaw shows promise in fighting drug-resistant tumors](#)
- [Pawpaw Page](#) from Ohio Public Library Information Network "What Tree is It? Page
- [Article from Athens paper about Chris Chmiel](#)
- [Jeannie and Berry's Pawpaw Page](#)
- [Neil Peterson's Pawpaws Page](#)
- [A passion for pawpaws](#) - article with recipes in Sept. 18, 2003 Pittsburgh Post-Gazette
- [Ohio Pawpaw Festival](#) (September) and the [Ohio Pawpaw Growers Association](#)
- [Pawpaw article from Wikipedia](#)

- [Pawpaw Information page](#) - includes the Pawpaw song
- [Pawpaw Info on the Georgia Wildlife Federation Page](#)
- [Will Cook's Pawpaw Page](#)
- [Study Finds Pawpaw a Tasty Fat Substitute in Baked Goods](#)

| [Return to Canal](#) | [Return to Yankauer](#) | [Go to the Paw Paw Tunnel](#) |



Thank you for stopping by, and thanks to previous visitors for their support. Because of you, I have been able to go BANNER AD-FREE! **Stay tuned for more updates and improvements! Also, I am now once again taking orders for gourds!**

Big updates are ongoing! In Progress: easy on-site ordering, better organized gallery, more pictures, and more info. Feel free to [Email Me](#) anytime. And please check back soon to see more new stuff!



[CLICK HERE](#) to go straight to the first design gallery!
Keep reading to learn a little bit about my gourd art.



NEW! Free E-Postcards of Gourds! Choose from one of several original art gourds from this site and send it to a friend or loved one as a free e-postcard with your own personal message! There are Halloween, winter, and holiday cards available now, and more to come soon! (Also, in response to a few requests, this flag postage stamp design is available as a pin or magnet. See bottom of this page.)

About my gourd art

Gourds grow on vines and harden over winter to a hard, wood-like texture. They have been used by cultures all over the world for many purposes, including water-carriers and rattles. They are also a popular medium for many kinds of artists, including American Indian, American folk, and modern.

My art gourds range in size from tiny to huge. They are grown on my parents' farm in rural central Kentucky, and I clean them, burn my designs into them with a woodburner, paint them, mostly with watercolors so the natural textures can show through, and coat them with an acrylic varnish to protect the art.



My mother began our family gourd art tradition, and got me started doing mostly Cherokee and rural designs. I began selling them at craft fairs, and started my website in 1996, to share my gourds and information with visitors and sell some unique pieces in the process.

My Cherokee gourds often incorporate traditional designs, symbols, or motifs. Most also have some writing on them in the Tsalagi language (using Sequoyia's Syllabary), whether it is simply "Tsalagi" or a longer message. Several tell traditional stories and myths in pictures and words, like "[Grandmother Spider and the Sun](#)". Many are more personal, mixing traditional designs or motifs with other kinds of images. One example of this is "[People of Today](#)", which illustrates a quote by Chief Wilma Mankiller.

I do many other kinds of designs as well, including nature, rural scenes, green man, seasonal, butterfly, ducks and loons, horses, cats, cardinals, and other animals, celestial (sun and/or moon), grape and vine, chili peppers,



harvest/autumn leaves, wind zephyrs, flowers, and American Indian designs other than Cherokee. I can also handle a lot of different requests. I've even done custom pieces from pictures of people's houses, pets, even family members, so feel free to [email me](#).

I also make lots of items out of gourds, including baskets, birdhouses, ornaments, wall hangings, pins, magnets, and hair barrettes. If you wish to make an order, simply choose the motif you want and the kind of gourd item. You can give me more specific requests in the comments section of the order form, whether you choose to pay with a credit card using my secure PayPal feature, or pay by check or money order using the print and mail form.

Please take a look around and enjoy your visit. I will always try to be adding more gourds and pictures. If you would like to see some examples of my work, head on to the [Design Gallery](#) page. And [let me know](#) if I can help you with something.



Many people have asked me about crafting gourds themselves. Please see the gourd info page for some general information. Here are two books that you may also find helpful:

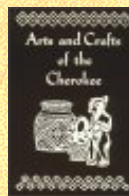

Also check out my parents' site on pawpaws, persimmons, elderberries, and other native plants

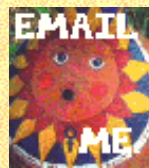

The flag stamp design is available as a pin for \$15 and a magnet for \$10 [Print-and-Mail order](#), or [Add Pin to Cart](#) or [Add Magnet to Cart](#) to pay using a credit card.

[View Cart](#)



[Go on to my gourd art page!](#)

[Following a WebRing? See the links, rings, and awards page!](#)

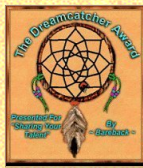

These pages and the gourd artwork that appears on them © 1996-2002 Abby Lane.

www.integrationacres.com



Welcome to Integration Acres, where you can find a wide variety of Pawpaw products as well as other delicious, natural goods. What's a Pawpaw, you say? Read the Pawpaw story and find out!

Products

buy cool pawpaw stuff here!

pawpaw products

Fresh Pawpaw Fruit
Pawpaw Pleasures
Pawpaw Spice Jam

Pawpaw Summer Sauce
Pawpaw Autumn Harvest

spicebush products

Appalachian Allspice
Spicewood
Recipes

Get more information and learn more about this delicious berry

Pawpaw Festival

new!

T-Shirts
Glass-Blown
Ornaments

Learn more about the first annual Pawpaw festival and purchase related products.

About Integration Acres

About Integration
Acres

Find out how we got started and read the story about the Pawpaw's history

Thanks for stopping by Integration Acres. We've just unveiled our new site, and hope you'll enjoy browsing around. We will be adding new features as they are developed. Feel free to shop around in the Products section, where you'll find all sorts of pawpaw and spicebush products. If you would like any additional information, please feel free to email me, [Chris Chmiel](mailto:Chris.Chmiel@integrationacres.com). Hope to hear from you soon.



Search:

Browse:

fun & flirty spring dresses [Shop Now](#)

NORDSTROM

You clicked on this item...



[Stalking the Wild Asparagus](#)
by [Euell Gibbons](#), [John McPhee](#)
Average Customer Review: ★★★★★
Usually ships in 24 hours

List Price: \$17.50
Price: **\$12.25**
You Save: \$5.25 (30%)

[48 used & new](#) from \$2.90

Eligible for **FREE Super Saver Shipping** on orders over \$25. [See details.](#)

The New York Times, June 28, 1962

The author is a first-rate cook, or what would be called in the South a "born" cook. He creates and improvises with authority and imagination and the results are enormously inventive.

Or [buy used](#): **\$2.90**

You may also be interested in these items...

[More results](#)

Show items from:

- ▶ **All Products**
- [Books](#) (20)
- [Music](#) (1)

Show items that are:

- | | | |
|---|--|--|
| <p> Stalking the Healthful Herbs
by Euell Gibbons, Raymond W. Rose (Illustrator)
More like this</p> | <p> Stalking the Blue-Eyed Scallop
by Euell Gibbons, Catherine Hammond
More like this</p> | <p> A Field Guide to Edible Wild Plants
by Lee Allen Peterson (Author), Roger Tory Peterson (Illustrator)
More like this</p> |
| <p> Identifying and Harvesting Edible and Medicinal Plants
by Steve Brill
More like this</p> | <p> The Encyclopedia of Edible Plants of North America
by James Duke (Author)
More like this</p> | <p> Stalking the Good Life
by Euell. Gibbons
More like this</p> |



 **The Neighborhood Forager**
by Robert K. Henderson

[More like this](#)



 **Field Guide to Edible Wild Plants**
by Bradford Angier

[More like this](#)



 **The Wild Food Gourmet**
by Anne Gardon (Editor)

[More like this](#)

You may also be interested in these authors...

[More results](#) 

- [Bradford Angier](#)
- [Steve Brill](#)
- [Lee Allen Peterson](#)
- [Robert K. Henderson](#)
- [James A. Duke](#)

A \$20 Special Offer from KitchenAid



Receive \$20 cash back after mail-in rebate when you purchase select KitchenAid stand mixers offered by Amazon.com.

Farberware Deal

\$15 Offer

Save \$15 on a future purchase when you spend \$50 on [Farberware](#) cookware. [Here's how.](#)

Up to 50% Off Reconditioned Housewares

Save up to **50%**

Save big on select [reconditioned housewares](#) offered by Amazon.com, including products from Dyson, Bissell, and Singer.

Where's My Stuff?

- Track your [recent orders](#).
- View or change your orders in [Your Account](#).

Shipping & Returns

- See our [shipping rates & policies](#).
- [Return](#) an item (here's our [Returns Policy](#)).

Need Help?

- Forgot your password? [Click here](#).
- [Redeem](#) or [buy](#) a gift certificate.
- [Visit our Help department](#).



Search

for

Your Recent History



[Learn More](#)

Recently Viewed Products

-  [The Good Life](#) by Scott Nearing (Author), Helen Nearing (Author)
-  [Uncommon Fruits Worthy of Attention](#) by Lee Reich, Vicki Herzfeld Alein

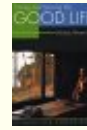
Customers who bought items in your Recent History also bought:



-  [Loving and Leaving the Good Life](#) by Helen Nearing
-  [The Making of a Radical](#) by Scott Nearing

▶ [Visit the Page You Made](#)

Turn your past books purchases into \$\$\$
[Learn more](#) about selling at Amazon.com today!

[Top of Page](#)

[Books Search](#) | [Browse Subjects](#) | [Bestsellers](#) | [Magazines](#) | [Corporate Accounts](#)
[e-Books & Docs](#) | [Bargain Books](#) | [Used Books](#)

[Amazon.com Home](#) | [Directory of All Stores](#)

Our International Sites: [Canada](#) | [United Kingdom](#) | [Germany](#) | [Japan](#) | [France](#)

[Contact Us](#) | [Help](#) | [Shopping Cart](#) | [Your Account](#) | [Sell Items](#) | [1-Click Settings](#)

[Investor Relations](#) | [Press Releases](#) | [Join Our Staff](#)

Bottom of the Page™ Deals for May 10

Amazon.com = low prices. Save up to 50% on these great deals, updated every day at noon (central time).

	Our Price	You Save
Wusthof Silverpoint 8310 10-Piece Block Set The perfect starter knife set for your new kitchen.	\$69.99	\$195.01 (74%)
Ultrasonex SB300U Rechargeable Toothbrush with 3 Replacement Brush Heads Removes more plaque than even the most manic manual brushing could.	\$16.99	\$33.00 (66%)
Viking 1 GB CompactFlash Card (CF1GB) A fantastic price on a topnotch CompactFlash card.	\$180.54	\$99.45 (36%)
Calphalon Commercial Hard-Anodized 12-Inch Everyday Pan with Lid Does everything from simmering stovetop succotash to browning beef brisket.	\$24.99	\$143.01 (85%)
CarbWise Delicious Crispy Bars, Chocolate S'mores Crunch (12 Bars) Tired of those rubbery-tasting protein bars? These are for you.	\$17.99	\$2.00 (10%)
Prilosec OTC Acid Reducer, Delayed-Release Tablets (28 Tablets) Show that double-cheeseburger who's boss.	\$16.99	\$0.96 (5%)
Dryel Refill Cloths, Original Fresh Scent - 6 ea A convenient way to care for wools, silks, and other special-care fabrics.	\$6.99	

[Olay Regenerist Daily Regenerating Serum, Fragrance Free, 1.7 Fluid Ounces](#)

Regenerates your appearance without drastic measures as chemical peels.

\$9.99

\$3.96
(28%)

[Neutrogena Visibly Firm Night Cream, Active Copper Formula - 1.7 oz](#)

Moisturizing cream for smoother, younger-looking skin.

\$13.99

\$3.56
(20%)



FREE Super Saver Shipping on orders over \$25. [See details.](#)

Amazon.com now offers bargains on brand-name essentials, all priced so low they've sunk to the bottom of the page! We take up to 50% off standard retail prices and deliver right to your door--no club fees, no hassle, no parking lot. These offers are only good until they're gone. Check back every day at noon (central time) for all-new Bottom of the Page™ Deals.

[Conditions of Use](#) | [Privacy Notice](#) © 1996-2004, Amazon.com, Inc. or its affiliates



amazon.com



VIEW CART

WISH LIST

YOUR ACCOUNT

HELP



Your Gold Box

WELCOME

YOUR STORE

BOOKS

APPAREL & ACCESSORIES

ELECTRONICS

TOYS & GAMES

DVD

CAMERA & PHOTO



SEE MORE STORES

Search

Browse Subjects

Bestsellers

Magazines

Corporate Accounts

e-books & docs

Bargain Books

Used Books

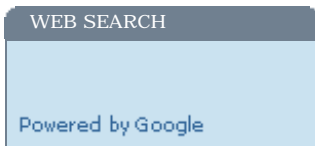

Welcome to Books! Click here to explore more.

Top Sellers in Books:

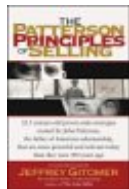

1. [The Patterson Principles of Selling](#) by Jeffrey Gitomer (Author)
2. [Eats, Shoots & Leaves](#) by Lynne Truss
3. [The South Beach Diet](#) by Arthur Agatston (Author)

BOOK INFORMATION

- [buying info](#)
- [editorial reviews](#)
- [customer reviews](#)

RECENTLY VIEWED

Mountain Country Cooking: A Gathering of the Best Recipes from the Smokies to the Blue Ridge
by [Mark F. Sohn](#), [John Egerton](#)
(Introduction)

READY TO BUY?

3 used & new from \$21.56

[See all buying options](#)

Have one to sell? [Sell yours here](#)

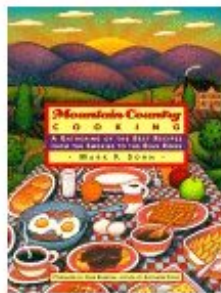

[see larger photo](#)

Availability:
Usually ships within 1-2 business days

Don't have one? We'll set one up for you.

3 used & new from \$21.56

Edition: Hardcover

[See more product details](#)

Product Details

- **Hardcover:** 364 pages ; Dimensions (in inches): 1.25 x 9.25 x 7.75
- **Publisher:** St. Martin's Press; (December 1996)
- **ASIN:** 0312146825
- **Average Customer Review:** ★★★★★ Based on 5 reviews. [Write a review.](#)
- **Amazon.com Sales Rank:** 291,904 (Publishers and authors: [improve your sales](#))

What's Your Advice?

Is there an item you'd recommend instead of or in addition to this one? Let the world know! Enter the item's ASIN ([what's an ASIN?](#)) in the box below, select advice type, then click Submit.

I recommend: _____ in addition to this book
instead of this book

Editorial Reviews

From Library Journal

Sohn's unusual book offers a guided tour to the food of Appalachia, from Maryland to Georgia. It is not, as he points out, Southern cooking but a separate though related cuisine from the "deep valleys, small farms, and rugged people" of this mountain chain. Corn and

 [Stalking the Wild Asparagus](#) by Euell Gibbons, John McPhee

 [The Good Life](#) by Scott Nearing (Author), Helen Nearing (Author)

 [Uncommon Fruits Worthy of Attention: A Gardener's Guide](#) by Lee Reich, Vicki Herzfeld Alein

▶ [See more in the Page You Made](#)

Featured Item:



[The Maple Sugar Book](#) by Helen Nearing, et al

potatoes, nuts and beans, pork, tomatoes, and apples are all staples, with sorghum used for sweetening. Recipes include Corn Sticks and Slick Dumplings, Bacon-Potato Soup, and Sorghum Pie. But this is not just a cookbook, for there are stories and anecdotes, lengthy discussions of recipe origins, history and lore, and more. A book that will be as much fun to browse through as to cook from, this is recommended for most collections.

Copyright 1997 Reed Business Information, Inc.

From *Booklist*

Although it contains recipes for old-fashioned fried chicken, cream gravy, apple turnovers, and cornbread, this is not your usual country cookbook. It is a sampling of the culinary heritage of nine Appalachian states that celebrates the homegrown fruits of mountain soil and the labors of mountain cooks of the 1930s, 1940s, and 1950s. Sohn's love for Appalachian cookery comes across clearly in the chatty text, which includes plenty of intriguing general background and cooking tips. Each of the... ▶ [read more](#)

▶ [See all editorial reviews...](#)

All Customer Reviews

Average Customer Review: ★★★★★

[Write an online review](#) and share your thoughts with other customers.

★★★★☆ Mediocre presentations..., May 10, 2004

Reviewer: hillbillyman from Big Stone Gap, VA

Who care about healthy alternative? I defeats the purpose of the nature of these dishes.

The author uses the word "we" way too much- it is clear that he is not of the hills like us-- I am sorry but living in the area doesn't automatically entitle you to adopt our way of life as your own, and profit from it.

We have done well over the years by keeping to ourselves... That is what makes our region unique.

Was this review helpful to you?

1 of 1 people found the following review helpful:

★★★★☆ This book is a rip-off, February 4, 2004

Reviewer: Billy Turnbull from Pikeville, KY USA

This book that highlights many recipes of the mountains is basically a contrived presentation that steals most of the recipes from the traditional people of the Appalachian mountains by someone who is a native of Oregon. Very bland recipes and very bland presentations. Avoid at all costs.

Was this review helpful to you?

0 of 1 people found the following review helpful:

★★★★☆ would be better spiral-bound-, September 30,

RATE THIS BOOK

I dislike it I love it!
 1 2 3 4 5

[Edit your ratings](#)

Favorite Magazines!



Explore our new [Magazine Subscriptions](#) store.

2000

Reviewer: [tomorrows_heirlooms \(see more about me\)](#) from Fallbrook, CA USA

I love cook books. I am a reader and veritable connoisseur of cookbooks. But, to be honest, if one is to really cook out of a cookbook, would author(s) henceforth please chose to have their works spiral-bound; maybe even with coated pages? This removes their book off the 'coffee table' (HardBack editions??) and brings it into the kitchen, where a cookbook belongs. Thank you for listening. Now I have to get back to my PawPaw Pie.

Was this review helpful to you?

3 of 4 people found the following review helpful:

★★★★★ GRANDMOTHER'S SECRETS REVEALED!, January 7, 2000

Reviewer: A reader from Beech Bluff, TN United States

I purchased this book from in a Memphis bookstore last year and was thrilled with it. It has all the traditional recipes - some of which I had long since forgotten - from my childhood in the Tennessee hills. All the recipes which I have tried so far have resulted in dishes that were like a taste of the past. I highly recommend this book to any displaced Southern mountaineer longing for a taste of home. You won't regret it!

Was this review helpful to you?

▶ [See all 5 customer reviews...](#)

Look for similar books by subject:

Browse for [books](#) in:

- [Subjects](#) > [Cooking, Food & Wine](#) > [General](#)
- [Subjects](#) > [Cooking, Food & Wine](#) > [Regional & International](#) > [U.S. Regional](#) > [General](#)
- [Kitchen & Housewares](#) > [Categories](#) > [Cookbooks](#) > [General](#)
- [Kitchen & Housewares](#) > [Categories](#) > [Cookbooks](#) > [Regional & International](#) > [U.S. Regional](#) > [General](#)

Search for books by subject:

[Cookery, American](#)
[Cookery](#)
[Appalachian Region, Southern](#)
[Cooking](#)
[Southern States](#)
[Cooking / Wine](#)
[Regional & Ethnic - American - Southern States](#)
[Regional & Ethnic - American - General](#)

i.e., each book must be in subject 1 AND subject 2 AND ...

Feedback

- **I have read this book, and I want to [review](#) it.**
- [E-mail a friend about this book.](#)
- [Write a So You'd Like to... guide.](#)
- Is there a specific product you'd like us to sell?
[Tell us](#) about it.



Suggestion Box

Your comments can help make our site better for everyone. If you've found something incorrect, broken, or frustrating on this page, let us know so that we can improve it. Please note that we are unable to respond directly to suggestions made via this form.

If you need help with an order, please [contact Customer Service.](#)

Please mark as many of the following boxes that apply:

Product information is missing important details.

Product information is incorrect. Propose corrections using our [Online Catalog Update Form.](#)

The page contains typographical errors.

The page takes too long to load.

The page has a software bug in it.

Content violates [Amazon.com's policy on offensive language.](#)

Product offered violates [Amazon.com's policy](#) on items that can be listed for sale.

Comments or Examples:

Examples: Missing information such as dimensions and model number, typos, inaccuracies, etc.

Where's My Stuff? <ul style="list-style-type: none">• Track your recent orders.• View or change your orders in Your Account.	Shipping & Returns <ul style="list-style-type: none">• See our shipping rates & policies.• Return an item (here's our Returns Policy).	Need Help? <ul style="list-style-type: none">• Forgot your password? Click here.• Redeem or buy a gift certificate.• Visit our Help department.
Search for		

Your Recent History

[Learn More](#)

Recently Viewed Products

-  [Stalking the Wild Asparagus](#) by Euell Gibbons, John McPhee
-  [The Good Life](#) by Scott Nearing (Author), Helen Nearing (Author)
-  [Uncommon Fruits Worthy of Attention](#) by Lee Reich, Vicki Herzfeld Alein

Customers who bought items in your Recent History also bought:

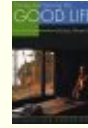

 [Loving and Leaving the Good Life](#) by Helen Nearing



 [Stalking the Healthful Herbs](#) by Euell Gibbons, Raymond W. Rose (Illustrator)

▶ [Visit the Page You Made](#)

Turn your past books purchases into \$\$\$
[Learn more](#) about selling at Amazon.com today!

[Top of Page](#)

[Books Search](#) | [Browse Subjects](#) | [Bestsellers](#) | [Magazines](#) | [Corporate Accounts](#)
[e-Books & Docs](#) | [Bargain Books](#) | [Used Books](#)

[Amazon.com Home](#) | [Directory of All Stores](#)

Our International Sites: [Canada](#) | [United Kingdom](#) | [Germany](#) | [Japan](#) | [France](#)

[Contact Us](#) | [Help](#) | [Shopping Cart](#) | [Your Account](#) | [Sell Items](#) | [1-Click Settings](#)

[Investor Relations](#) | [Press Releases](#) | [Join Our Staff](#)

Bottom of the Page™ Deals for May 10

Amazon.com = low prices. Save up to **50%** on these great deals, updated every day at noon (central time).

	Our Price	You Save
Wusthof Silverpoint 8310 10-Piece Block Set The perfect starter knife set for your new kitchen.	\$69.99	\$195.01 (74%)
Ultrasonex SB300U Rechargeable Toothbrush with 3 Replacement Brush Heads Removes more plaque than even the most manic manual brushing could.	\$16.99	\$33.00 (66%)
Viking 1 GB CompactFlash Card (CF1GB) A fantastic price on a topnotch CompactFlash card.	\$180.54	\$99.45 (36%)
Calphalon Commercial Hard-Anodized 12-Inch Everyday Pan with Lid Does everything from simmering stovetop succotash to browning beef brisket.	\$24.99	\$143.01 (85%)
CarbWise Delicious Crispy Bars, Chocolate S'mores Crunch (12 Bars) Tired of those rubbery-tasting protein bars? These are for you.	\$17.99	\$2.00 (10%)
Prilosec OTC Acid Reducer, Delayed-Release Tablets (28 Tablets) Show that double-cheeseburger who's boss.	\$16.99	\$0.96 (5%)

[Dryel Refill Cloths, Original Fresh Scent - 6 ea](#)

A convenient way to care for wools, silks, and other special-care fabrics.

\$6.99

[Olay Regenerist Daily Regenerating Serum, Fragrance Free, 1.7 Fluid Ounces](#)

Regenerates your appearance without drastic measures as chemical peels.

\$9.99

\$3.96
(28%)

[Neutrogena Visibly Firm Night Cream, Active Copper Formula - 1.7 oz](#)

Moisturizing cream for smoother, younger-looking skin.

\$13.99

\$3.56
(20%)



FREE Super Saver Shipping on orders over \$25. [See details.](#)

Amazon.com now offers bargains on brand-name essentials, all priced so low they've sunk to the bottom of the page! We take up to 50% off standard retail prices and deliver right to your door--no club fees, no hassle, no parking lot. These offers are only good until they're gone. Check back every day at noon (central time) for all-new Bottom of the Page™ Deals.

[Conditions of Use](#) | [Privacy Notice](#) © 1996-2004, Amazon.com, Inc. or its affiliates



Cornell University

Poisonous Plants Informational Database



Search on the following fields:

Scientific Name:

Common Name:

Primary Poisons:

**Species Most Often
Affected:**

This database of photos was started by Animal Science faculty and staff at Cornell University as a public service. Some of the information has been put together by students in the Animal Science 625 course. Please let us know if you find any errors or misidentifications and we will get them corrected as soon as possible.

The images are copyrighted. They can be used in teaching, downloaded, and copied, provided it is in an educational setting and proper attribution is provided. Alteration of images in any form is restricted.

IMPORTANT: This database of poisonous plants is correct to the best of our knowledge. However, just because a plant is NOT listed does not mean that it is NOT poisonous to a certain species. A good rule of thumb: if you have any doubt about a plant, assume it is poisonous!

Return to: [Poisonous Plants Main Page](#)

Home page: [Animal Science at Cornell University](#)

For problems or comments on this web page, contact the Animal Science [Webmaster](#)

[View Common name list](#)

Cornell University Poisonous Plants Informational Database



Alphabetical listing of botanical names by genus and species

This series of web pages was created by professors, staff, graduate and undergraduate students at Cornell University. Some of the research was done for the AS625 class projects. All comments and suggestions are welcome.

These web pages are only meant to be informative. Neither Cornell University nor the author(s) of this site endorse or recommend the use of these plants. There are many poisonous plants and substances which are not represented here. Please do not assume that a specific plant is ok just because it is not listed. These pages are copyrighted. Unauthorized duplication is prohibited.

[List of Scientific and Common Name Equivalents](#)

Return to: [Poisonous Plants Homepage](#)

Home page: [Animal Science at Cornell University](#)

For problems or comments on this web page, contact the Animal Science [Webmaster](#)

27 1585

- [Abrus precatorius](#)
- [Aconitum spp.](#)
- [Actaea spp.](#)
- [Aesculus spp.](#)
- [Agrostemma githago](#)
- [Aleurites fordii](#)
- [Allium spp.](#)
- [Amanita spp.](#)
- [A. muscaria](#)
- [A. pantherina](#)
- [A. verna](#)
- [Amaranthus spp.](#)
- [Amsinckia intermedia](#)
- [Apocynum spp.](#)
- [Argemone mexicana](#)
- [Arisaema spp.](#)
- [Asclepias spp.](#)
- [Astragalus and Oxytropis spp.](#)
- [Atropa belladonna](#)
- [Brassica spp.](#)
- [Caltha palustris](#)
- [Cannabis sativa](#)
- [Centaurea solstitialis](#)
- [Chelidonium majus](#)
- [Chenopodium album](#)
- [Cicuta spp.](#)
- [Claviceps spp.](#)
- [Conium maculatum](#)
- [Coronilla varia](#)
- [Convallaria majalis](#)
- [Daphne spp.](#)
- [Datura spp.](#)
- [Delphinium spp.](#)
- [Dicentra spp.](#)
- [Digitalis purpurea](#)
- [Equisetum arvense and other spp.](#)
- [Eupatorium rugosum](#)
- [Euphorbia spp.](#)
- [Fagopyrum esculentum](#)
- [Festuca arundinacea](#)
- [Gelsemium sempervirens](#)
- [Glechoma spp.](#)
- [Halogeton glomeratus](#)
- [Helleborus niger](#)
- [Hyoscyamus niger](#)
- [Hypericum perforatum](#)
- [Iris spp.](#)
- [Laburnum anagyroides](#)
- [Lantana camara](#)

Cornell Poisonous Plants

- [Lathyrus spp.](#)
- [Leucothoe axillaris and](#)
- [Leucothoe davisiae](#)
- [Linum usitatissimum](#)
- [Lobelia spp.](#)
- [Lotus corniculatus](#)
- [Lupinus spp.](#)
- [Medicago sativa](#)
- [Melilotus alba and](#)
- [Melilotus officinalis](#)
- [Menispermum canadense](#)
- [Nerium oleander](#)
- [Nicotiana spp.](#)
- [Onoclea sensibilis](#)
- [Ornithogalum umbellatum](#)
- [Papaver spp.](#)
- [Phytolacca americana](#)
- [Pieris japonica and other](#)
- [spp.](#)
- [Pinus ponderosa](#)
- [Podophyllum peltatum](#)
- [Prunus spp.](#)
- [Pteridium aquilinum](#)
- [Quercus spp.](#)
- [Ranunculus spp.](#)
- [Rheum rhaponticum](#)
- [Ricinus communis](#)
- [Robinia pseudoacacia](#)
- [Rumex spp.](#)
- [Sambucus canadensis](#)
- [Sanquinaria canadensis](#)
- [Saponaria spp.](#)
- [Senecio spp.](#)
- [Solanum spp.](#)
- [Sorghum spp.](#)
- [Symplocarpus foetidus](#)
- [Taxus cuspidata](#)
- [Tetradymia spp.](#)
- [Toxicodendron diversiloba](#)
- [Toxicodendron radicans](#)
- [Toxicodendron vernix](#)
- [Trifolium spp.](#)
- [Triglochin maritima](#)
- [Urtica spp.](#)
- [Vicia spp.](#)
- [Veratrum californicum](#)
- [Wisteria spp.](#)
- [Xanthium strumarium](#)
- [Zigadenus spp.](#)

[View Common Name List](#)

[View Botanical name list](#)

Cornell University

Poisonous Plants Informational Database



Alphabetical listing of common plant names

This series of web pages was created by professors, staff, graduate and undergraduate students at Cornell University. Some of the research was done for the AS625 class projects. All comments and suggestions are welcome.

These web pages are only meant to be informative. Neither Cornell University nor the author(s) of this site endorse or recommend the use of these plants. There are many poisonous plants and substances which are not represented here. Please do not assume that a specific plant is ok just because it is not listed. These pages are copyrighted. Unauthorized duplication is prohibited.

[List of Scientific and Common Name Equivalents](#)

Return to: [Poisonous Plants Homepage](#)

Home page: [Animal Science at Cornell University](#)

For problems or comments on this web page, contact the Animal Science [Webmaster](#)

27 1585

- [Aconite](#)
- [Alfalfa or Lucerne](#)
- [Alsike Clover](#)
- [Angel's Trumpet](#)
- [Arrowgrass](#)
- [Baneberry](#)
- [Belladonna](#)
- [Birdsfoot Trefoil](#)
- [Black Locust](#)
- [Bleeding Heart](#)
- [Bloodroot](#)
- [Bouncing Bet](#)
- [Bracken Fern](#)
- [Buckeye](#)
- [Buckwheat](#)
- [Buffalo Bur](#)
- [Buttercups or Crowfoot](#)
- [Castor Bean](#)
- [Celandine](#)
- [Christmas Rose](#)
- [Cocklebur](#)
- [Corn Cockle](#)
- [Corn Lily, False Hellbore](#)
- [Cow Cockle](#)
- [Creeping Charlie](#)
- [Crown Vetch](#)
- [Cherries, Black Cherry, Bitter Cherry, Choke Cherry, and Pin Cherry](#)
- [Daphne](#)
- [Death Angel Mushrooms](#)
- [Death Camas](#)
- [Death Cap Mushrooms](#)
- [Destroying Angels](#)
- [Delphiniums](#)
- [Devil's Trumpet](#)
- [Dock](#)
- [Dogbane](#)
- [Doll's-eyes](#)
- [Downy Thornapple](#)
- [Drooping Leucothoe](#)
- [Dutchman's Breeches](#)
- [Elderberry](#)
- [Ergot](#)
- [Fly Agaric](#)
- [Fiddleneck](#)
- [Flax](#)
- [Foxglove](#)
- [Golden Chain or Laburnum](#)
- [Great Lobelia, Cardinal Flower, and Indian Tobacco](#)
- [Ground Ivy, Creeping Charlie, and Gill-over-the-Ground](#)
- [Groundsels](#)
- [Halogeton](#)
- [Henbane](#)
- [Horsebrush](#)
- [Horse Chestnut](#)
- [Horse Nettle](#)
- [Horsetail](#)
- [Irises](#)

Cornell Poisonous Plants

- [Jack-in-the-Pulpit](#)
- [Japanese Pieris](#)
- [Jessamine](#)
- [Jimsonweed](#)
- [Johnson Grass](#)
- [Klamath Weed](#)
- [Lamb's Quarters](#)
- [Lantana, Red Sage, Yellow Sage, or West Indian Lantana](#)
- [Larkspurs](#)
- [Lily-of-the-Valley](#)
- [Locoweed](#)
- [Lupine](#)
- [Marijuana](#)
- [Marsh Marigold or Cowslip](#)
- [Mayapple and Mandrake](#)
- [Mexican Poppy](#)
- [Milkweed](#)
- [Milo](#)
- [Monkey Agaric Mushrooms](#)
- [Monkshood](#)
- [Moonseed](#)
- [Mountain Fetterbush](#)
- [Nightshade, Black Nightshade or Deadly Nightshade](#)
- [Oak Trees](#)
- [Oleander](#)
- [Onions and Chives](#)
- [Panther](#)
- [Panther Cap Mushrooms](#)
- [Pigweed](#)
- [Poison Hemlock](#)
- [Poison ivy](#)
- [Poison oak](#)
- [Poison Sumac](#)
- [Potato](#)
- [Poinsettia](#)
- [Pokeweed](#)
- [Ponderosa Pine](#)
- [Poppies including Opium Poppy](#)
- [Prickly Poppy](#)

- [Ragworts](#)
- [Red Clover](#)
- [Rhubarb](#)
- [Rosary Pea](#)
- [Saint Johns Wort](#)
- [Senecio](#)

- [Sensitive Fern](#)

- [Sierra Laurel](#)
- [Skunk Cabbage](#)
- [Squirrel Corn](#)
- [Snow-on-the-Mountain](#)
- [Sorghum](#)
- [Spurges](#)
- [Star-of-Bethlehem](#)
- [Stinging Nettle](#)
- [Sudan Grass](#)
- [Sweet clover](#)
- [Sweet Pea, Tangier Pea, Everlasting Pea, Caley Pea and Singletary Pea](#)
- [Tobacco and Tree Tobacco](#)

Cornell Poisonous Plants

- [Tung Oil Tree](#)
- [Vetch, Hairy Vetch, Narrow-leaved](#)
- [Vetch, Purple Vetch and Broad Beans](#)
- [Water Hemlock or Cowbane](#)
- [White Clover](#)
- [White Snakeroot](#)
- [Wisteria](#)
- [Wolfsbane](#)
- [Yellow Star Thistle](#)
- [Yew](#)

[View Botanical name list](#)



Cornell University

Poisonous Plants Informational Database



Toxic Agents in Plants

ALKALOIDS

- [Indole Alkaloids](#) ([Beta-carbolines](#) etc.)
- Indolizidine
- [Piperidine](#)
- [Polycyclic Diterpene](#)
- [Pyridine](#)
- [Pyrrolizidine](#)
- Quinolizidine
- [Steroids](#)
- Tropane
- Tryptamine

ALCOHOLS AND KETONES

- Alcohols
 - Diacetone alcohol
 - Diethylene glycol
 - Ethanol
 - Ethylene glycol
 - Methanol
 - Propylene glycol
- Ketones
 - Cicutoxin
 - Tremetone
 - Tretatol

CARBOHYDRATES

- Oligosaccharides
- Beta-glucans
- Pectins
- Raffinose
- Simple Sugars

- Favism
- Fructose
- Galactose
- Lactose
- Sucrose
- Xylose

CHELATING POISONS

- [Nitrates](#)
- Nitrites
- [Oxalates](#)
- Phytates

GLYCOSIDES

- [Calcinogenic Glycosides](#)
- [Carboxyatractylosides](#)
- [Cardiac Glycosides](#)
- [Coumarins](#)
- Furocormarins
- [Glucosinolates \(Goitrogenic Glycosides\)](#)
- [Isoflavones and Coumestans](#)
- Nitroglycosides (Nitropropanol Glycosides)
- [Ranunculins](#)
- [Saponins](#)
- [Vicine/Covicine](#)

LIPIDS

- Fatty Acids
 - Cyclopropenoid fatty acids
 - Erucic acid
 - Fluoroacetate
- Glycolipids

METALS

- Heavy Metals
 - Copper
 - Mercury
 - [Selenium](#)
 - Arsenic

- [Lead](#)
- [Iron](#)

MYCOTOXINS

- [Aflatoxins](#)
- Citrinin
- Fungal Tremorgens
- Lupinosis
- Ochratoxins
- Patulin
- Rubratoxins
- Sporidesmin
- Stachybotryotoxins
- [Trichothecenes](#)
- [Zearalenone](#)

PHENOLIC TOXICANTS

- Cinnamic Acid
- Fagopyricin
- Gossypol
- Hypericin
- Pterocin
- Resorcinol
- Urushiol
- [Tannins](#)

PROTEINS AND AMINO ACIDS

- Allergens
 - Amylase Inhibitors
 - Enzymes
 - Lipoxidases
 - [Thiaminases](#)
 - Tocopheroxidase
- [Lectins](#)
 - Abris
 - Concanavalin
 - [Ricin](#)
 - Robin
- Plant Cytoplasmic Proteins

- [Polypeptides](#)
- Amino Acids
 - Nutrient
 - Leucine
 - Methionine
 - [SMCO](#)
 - [Tryptophan](#)
 - Non-nutrient
 - Arginine analogs
 - Canavanine
 - Indospecine
 - L amino D proline
 - dihydroxyphenylalanine
 - Lathyragens
 - [Mimosine](#)

RESINS

[SESQUITERPENE LACTONES](#)

VITAMINS

- Vitamin A
- Vitamin D metabolites

MISCELLANEOUS

- Ipomemaron - mycotoxin?
- Alsike Poisoning - mycotoxin?
- Red Maple Poisoning (similar to Brassica induced anemia)
- Plant Carcinogens
- N-Propyl Disulfide (similar to Brassica induced anemia)

Questions regarding content of this page, contact [Dr. Dan Brown](#)

Return to: [Cornell Poisonous Plants Home Page](#)

Return to: [Alphabetical List of Poisonous Plants](#)

Home page: [Animal Science at Cornell University](#)

For problems or comments on this web page, contact the Animal Science [Webmaster](#)



Cornell University

Poisonous Plants Informational Database



Plants of special concern to these species:

- [Humans](#)
- Livestock
 - [Ruminants](#)
 - [Cattle](#)
 - [Goats](#)
 - [Sheep](#)
 - Non-ruminants
 - [Horses](#)
 - [Poultry](#)
 - [Swine](#)
- Pets
 - [Cats](#)
 - [Dogs](#)
 - [Iguanas](#)
 - [Rabbit](#)

[Unique adaptations by some animals to toxins in their environments](#)

Return to: [Poisonous Plants Home Page](#)

Home page: [Animal Science at Cornell University](#)

For problems or comments on this web page, contact the Animal Science [Webmaster](#)

Medicinal Plants for Livestock

Beneficial OR Toxic?

This series of web pages will attempt to answer some basic questions about the safety and efficacy of some medicinal plants. More plants will be added as information is available. Please read the introduction before reading about the plants.

Website Contents

- [Introduction](#)
- [Plants](#)
 - **NEW** [Melinis minutiflora](#) (Molasses grass)
 - **NEW** [Petiveria alliacea](#)
 - **NEW** [Portulaca oleracea](#) (Purslane)
 - [Compounds](#) in some plants
 - [Other Resources](#) and the references for this web site

Introduction to Medicinal Plants for Livestock

The idea of using medicinal plants to treat livestock is not new. Many of the active ingredients in chemically manufactured drugs were originally derived from plant compounds (e.g., the pyrethroids). Also, in many developing countries, medicinal plants are still being used on a regular basis. (The use of plants and traditional methods for treating animals is called [ethnoveterinary medicine](#).) There is a renewed interest, especially in developed countries, in using plants to treat livestock, pets, and humans. Why?

- Many people believe that plants are less toxic and safer than manufactured drugs.
- Many people believe that plants are more natural than manufactured drugs.
- Medicinal plants can be made at home and are less expensive than manufactured drugs.
- In developing countries, medicinal plants often are more accessible than manufactured drugs.

The big questions are: Are medicinal plants effective for livestock? Are they really safe? Of the hundreds of plants used in ethnopharmacology, very few have been researched for their efficacy and toxicity. In the U.S., medicinal plants for humans are registered with the [Food and Drug Administration](#). Medicinal plants for livestock currently are not sold on a wide scale in the U.S.

Based on the [U.S. Department of Agriculture](#) regulations, medicinal plants for livestock must meet the same stringent requirements as other animal drugs if they are to be registered and approved for use in food producing animals.

Just because medicinal plants for livestock have not been registered, does not mean they are not accessible. How can you know or decide if a medicinal plant is safe or toxic for your livestock? Click on the [plants list](#) to learn about what is known and not known about a few plants used in ethnoveterinary medicine.

When reading about the plants please remember that:

- There is incomplete toxicity information on most of these plants;
- There is incomplete efficacy information on most of these plants; and
- The toxic dose and potentially effective dose could be very close.

[Return to Table of Contents](#)

This series of web pages was created by a graduate student at Cornell University. All comments and suggestions are welcome. If you would like to add to this medicinal plant database, please [e-mail](#) Webmaster.

WARNING: These web pages are only meant to be informative. Neither Cornell University nor the author of this site endorse or recommend the use of these plants.

Return to: [Medicinal Plants Homepage](#)
[Poisonous Plants Homepage](#)

Home page: [Animal Science at Cornell University](#)

For problems or comments on this web page, contact the Animal Science [Webmaster](#)



Cornell University

Poisonous Plants Informational Database



Frequently Asked Questions

Simple keyword search

- [1 - Can I use a picture off of your website?](#)
- [2 - Need more information about Umbellularia californica?](#)
- [3 - Are oak trees poisonous to goats?](#)
- [4 - Are African Violets poisonous to dogs?](#)
- [5 - Is Agave americana a poisonous plant or am I allergic to it?](#)
- [6 - Is alfalfa hay causing the welts on my horse?](#)
- [7 - Is Aloe Vera toxic to rabbits?](#)
- [8 - Is Amaryllis poisonous to humans and housepets?](#)
- [9 - Are immature apricots as poisonous as mature apricots?](#)
- [10 - What is the most poisonous substance in Argemone mexicana?](#)
- [11 - Need more information on these plants...](#)
- [12 - How do avocados affect horses?](#)
- [13 - Can the azelea cause previously normal canine sperm to become abnormal in morphology?](#)
- [14 - Are these substances toxic?](#)
- [15 - How do I get rid of knot weed or bamboo?](#)
- [16 - Is bamboo toxic to dogs?](#)
- [17 - Which poisonous plants are in the Bay area of California?](#)
- [18 - Are these berries poisonous?](#)
- [19 - What could have caused my rash?](#)
- [20 - Can black eyed susans hurt horses?](#)
- [21 - Does black locust wood affect horses?](#)
- [22 - Can a black walnut stump poison a garden?](#)
- [23 - My sister took too high a dose of bloodroot. What will that do to her?](#)
- [24 - Is Bougainvillea poisonous to horses?](#)
- [25 - What kind of plants would cause the symptoms of anti-freeze poisoning?](#)
- [26 - Is bougainvillea poisonous to rabbits?](#)
- [27 - Is bougainvillea poisonous to dogs?](#)
- [28 - Can I have some information on Brayera anthelmintica?](#)
- [29 - Why is brocolli poisonous?](#)
- [30 - Has a scientific analysis ever been made of Buckeyes?](#)

- [31 - Would these common houseplants be poisonous to my pet rabbit?](#)
- [32 - I have a huge bush that causes rashes. How do I get rid of it?](#)
- [33 - Have you ever heard cattle dying from eating buttercup?](#)
- [34 - Are buttercups dangerous to horses?](#)
- [35 - Are buttercups dangerous to horses?](#)
- [36 - How can we figure out which of these plants are native to California?](#)
- [37 - DO you have information on California laurel?](#)
- [38 - Do you have any information on a plant called](#)
- [39 - Do you know who canavanine was named after?](#)
- [40 - Are Cape Murtle and Pampas Grass poisonous to horses?](#)
- [41 - Is too much carotene bad for you?](#)
- [42 - Should I be concerned about the castor bean plant in my yard?](#)
- [43 - What is wrong with my cat?](#)
- [44 - Does this cat food have toxic elements in it?](#)
- [45 - Please explain the difference between asteraceae and compositae.](#)
- [46 - Is mother-in-law tongue poisonous to cats?](#)
- [47 - How does Spathiphyllum affect cats?](#)
- [48 - Are my evergreens poisonous?](#)
- [49 - My dog ate something and had a bad trip...](#)
- [51 - Has any of your research on nematicidal effects been published?](#)
- [52 - Are any of these plants poisonous to horses?](#)
- [53 - Are cherry trees poisonous to ponies?](#)
- [54 - I need information on some plants...](#)
- [55 - Could chimphilla pills have caused muscle and nerve pains?](#)
- [56 - Could you give me some information on Colchicum Autumnale \(Meadow Saffron\)?](#)
- [57 - Could you help me identify this vine?](#)
- [58 - Do you have any information on creeping indigo?](#)
- [59 - I need information on creeping indigo...](#)
- [60 - Could you help me find a website on the critical effects and target organs for non-carcinogens?](#)
- [61 - Is Crown Vetch safe to feed to horses?](#)
- [62 - Do cycads pose a risk to livestock?](#)
- [63 - I have some questions pertaining to cynogenic glycosides...](#)
- [64 - Are Leyland Cypress trees toxic to horses?](#)
- [65 - Can your dairy intake cause a deposition of calcium?](#)
- [67 - Is Death Parasol the same as Death Cap?](#)
- [68 - Is Golden Dew Drop poisonous?](#)
- [69 - Are acorns toxic to dogs?](#)

[70 - Are Pieris Japonica plants poisonous to dogs?](#)

[71 - Could you help me find some information on plants poisonous to dogs?](#)

[72 - Are there any poisonous plants that could create these symptoms in my dog?](#)

[73 - What is in the domperidone?](#)

[74 - What could cause these horses to drool?](#)

[75 - Is dumbcane toxic to humans?](#)

[76 - Why are these elk dying?](#)

[77 - Are elderberries poisonous to humans?](#)

[78 - Are elephant ears poisonous?](#)

[79 - Is Mountain Laurel poisonous to elk?](#)

[80 - Do you know where I can get up to date information on the natural form of ellagic acid?](#)

[81 - Could you explain the toxicity of erucic acid to humans?](#)

[82 - Are you aware of any species of eucalyptus that may be toxic to domestic/wildlife?](#)

[83 - I would like some advice regarding FA analysis of feeds...](#)

[85 - Can fescue grow in Florida?](#)

[86 - Is there an additive that I can put in feed for treating and preventing the effects of fescue?](#)

[87 - Are these plants toxic?](#)

[88 - Could you tell me an additive I can give to my animals to treat fescue poisoning?](#)

[89 - Can the cold weather kill off Fiddleneck?](#)

[90 - I need some information on Fiddleneck...](#)

[91 - Could Laurentia longiflora be responsible for my fish dying?](#)

[92 - Could tannins toxify salmoni fisheries?](#)

[93 - Can flax seeds be poisonous to horses?](#)

[94 - Are there any poisonous weeds in Florida?](#)

[95 - Do you have any information on Poison wood?](#)

[96 - Can you give me some advice?](#)

[97 - What do you know about formic acid and fallow?](#)

[98 - Is alfalfa toxic once frost hits?](#)

[99 - Is the Fuschia plant poisonous to dogs?](#)

[100 - Is garlic poisonous to dogs?](#)

[101 - Should we give selenium to our buck\(goat\)?](#)

[102 - Can you help me identify the symptoms associated with toxic Echium species?](#)

[103 - Do you know where I can find a 4-H goat group for my daughter?](#)

[104 - How susceptible are goats to laurel poisoning?](#)

[105 - Can you use Rumensin to control ketosis?](#)

[106 - Do you know of any plants that kill gophers?](#)

[107 - Do you have any information on gossypol?](#)

- [108 - Are Ficus tree leaves poisonous to baby guinea pigs?](#)
- [109 - Do you have any information about heart worm disease?](#)
- [110 - What are the physical differences between water hemlock and](#)
- [111 - Are Hibiscus poisonous to horses?](#)
- [112 - Are there any poisonous plants that can cause death in dogs, horses or humans without symptoms?](#)
- [113 - Do you have any information on hoary allyssum?](#)
- [114 - Are hog pellets poisonous to horses?](#)
- [115 - Can you help me figure out what kind of plant I have here?](#)
- [116 - What should I do about my Holly bushes?](#)
- [117 - Could you give me some information on Hollyhock?](#)
- [118 - Is my tree poisonous?](#)
- [119 - Are Burford holly berries poisonous?](#)
- [120 - Is honeysuckle poisonous?](#)
- [121 - Are acorns poisonous to horses?](#)
- [122 - Can horse nettle poison the meat of beef cattle?](#)
- [123 - What could cause these horses to drool?](#)
- [124 - Are Chephalara plants and Philodendra plants poisonous?](#)
- [125 - Why are companies who sell house plants not required to place a warning on the containers?](#)
- [127 - Could hydrangea make my dog puke?](#)
- [128 - What plants are safe for my iguanas?](#)
- [129 - Can you help me find information on these plants?](#)
- [130 - Can you tell one poison rash from the other?](#)
- [131 - Are Jade plants poisonous to children?](#)
- [132 - Are these plants poisonous?](#)
- [133 - Is St Johns Wart poisonous to humans?](#)
- [134 - Can give me some advice?](#)
- [135 - Could you give me a list of landscape plants that are toxic to horses?](#)
- [136 - Could you tell me if these landscaping plants are poisonous horses?](#)
- [137 - How dangerous are lantana berries?](#)
- [138 - Do you have any information on Laudanum?](#)
- [139 - Do you have any information on Laurentia longiflora?](#)
- [140 - A few questions regarding your webpage...](#)
- [141 - What can I do for my horse?](#)
- [142 - Do you know anything about lolium temulentum?](#)
- [143 - Could mandrake fruit make my wife get pregnant?](#)
- [145 - Can marigold leaves be poisonous to a canary?](#)
- [146 - How does experimental data compare with poisoning cases?](#)

- [147 - Do you have a picture of Meadow Saffron?](#)
- [148 - Is this normal?](#)
- [149 - Do you have plans for a goat milk stand?](#)
- [150 - Are mimosa trees toxic to horses?](#)
- [151 - Are the seeds of Mimosa Pudica poisonous?](#)
- [152 - How long does it take for a goat to recover from mistletoe poisoning?](#)
- [153 - Is mistletoe toxic to cattle?](#)
- [154 - Is Mountain Laurel toxic to horses?](#)
- [155 - Can you give me some information about human exposure to Monkshood?](#)
- [156 - Do you have any information on Monstera deliciosa?](#)
- [157 - Could you tell me the scientific name of this plant?](#)
- [158 - Is the plant in my backyard poisonous?](#)
- [159 - What is the most poisonous part of these plants?](#)
- [160 - What is the most poisonous plant in the world to humans?](#)
- [161 - Is this mushroom poisonous?](#)
- [162 - What kind of a poisonous bean could you put in a soup?](#)
- [163 - Do you have any information on Sting Nettle?](#)
- [164 - Could Niacin be used in some drug-related way?](#)
- [165 - What could be the problem here?](#)
- [166 - Are there any plants that cause death in dogs, horses or humans without symptoms?](#)
- [167 - Can you help me find some non-toxic plants for a horse arena?](#)
- [168 - What could have caused these blisters?](#)
- [169 - Could pine needles poison my goat?](#)
- [170 - Should I move my horse away from the oak trees?](#)
- [171 - Could you give me more information on oleander?](#)
- [172 - Are Oleander plants harmful to horses?](#)
- [173 - What type of poison is present in oleander?](#)
- [174 - Can you give me some information about Oleander?](#)
- [175 - Is Oxalis regnellii poisonous?](#)
- [176 - Do you have any information on a plant called Hogswart?](#)
- [177 - What is in avocado that kills parrots?](#)
- [178 - Could you give me some information about Peace lilies?](#)
- [179 - Could you tell me if Peace Lily is poisonous?](#)
- [180 - Could you give me some information on the toxicity of the peace lily?](#)
- [181 - Is this peace plant toxic?](#)
- [182 - Have you ever heard of poison sumac being used as a filler in peet moss?](#)
- [183 - Need macro and microscopic identification of Atropa belladonna.](#)

- [185 - What kind of reaction should I look for in a baby who chewed a philodendreon leaf?](#)
- [186 - Would you please enlighten me as to the existence of such an alkaloid phytoerythrin?](#)
- [187 - Are pine trees harmful to horses?](#)
- [188 - Do you know of a pink form of Delphinium tricornne?](#)
- [189 - Is Plumeria rubra poisonous to cats?](#)
- [190 - Do you think that my dog is going to get worse?](#)
- [191 - Is the Poinsettia poisonous?](#)
- [192 - Where can I get photos of poisonous plants for field identification?](#)
- [193 - Do you know where I can find poison ivy extract?](#)
- [194 - Are crassula \(jade plants\) poisonous to humans?](#)
- [195 - Are the same plants that are poisonous to humans, poisonous to animals?](#)
- [196 - Is poison ivy only poisonous to humans and primates?](#)
- [197 - How does one kill the poison oak plant?](#)
- [198 - Do you have any information on Poison Parsnip?](#)
- [199 - I need some information on poisonous plants...](#)
- [200 - Do you know of any oral medication to prevent Poison Ivy?](#)
- [201 - Could you give me some information about the toxicity of these plants?](#)
- [202 - Are these plants really poisonous?](#)
- [203 - Is there any way to prevent your horse from eating poisonous plants?](#)
- [204 - Are poke berries harmful to humans?](#)
- [205 - Are pokeberries poisonous when injested by a child in small amount?](#)
- [206 - Could you give me some information on California Pokeweed?](#)
- [207 - Are Pokeweed berries poisonous?](#)
- [208 - Are ligustrum hedges poisonous?](#)
- [209 - Is the Royal Robe Potato Bush poisonous?](#)
- [210 - Could you give me some information about the toxicity of Solanum crispum?](#)
- [211 - Is Scindapsus aureus hazardous to the public?](#)
- [212 - Could you answer a few questions about the Precatory pea?](#)
- [213 - Could 800 IU of vitamin D harm a fetus?](#)
- [214 - Could your intake of dairy cause psuedogout?](#)
- [215 - What could cause this condition?](#)
- [216 - What do you think about my reaction to pyrachantha?](#)
- [217 - Do you have any information on the pyrus, prunus and malus genus of trees?](#)
- [218 - Can you answer a few questions about rabbits?](#)
- [219 - What do you know about parasite transmission from rabbit feces?](#)
- [220 - Where can I find information on rabbit history?](#)
- [221 - Does Cornell have a price list for the resources available to 4-H rabbit project leaders?](#)

- [222 - Does Ragwort exist in the US or Canada?](#)
- [223 - Could You give me some information on toxicity of Alsike and Red Maple?](#)
- [224 - Can Red Tip plants cause cancer?](#)
- [225 - How does a person reverse the damage done by Vitamin A toxicity?](#)
- [226 - Is it possible for ricin to be absorbed through the skin and cause death?](#)
- [227 - How does is Ricin different than a bacterium?](#)
- [228 - I am looking for information regarding ricin...](#)
- [229 - Could Ricin be used by terrorists?](#)
- [230 - I need some information about Ricin...](#)
- [231 - Could you tell me some more about the Castor Bean plant?](#)
- [232 - Could you answer some questions about powdered Ricin for me?](#)
- [233 - How should I reference some information I took off of your website?](#)
- [234 - I need some information about the Rosary Pea for a book...](#)
- [235 - Are roses harmful to dogs?](#)
- [236 - Do you know of a list that compares the plant toxicity in horses and ruminants?](#)
- [237 - Are you familiar with the toxins in a Russian Olive Tree?](#)
- [238 - Are Sambucus canadensis and Sambucus nigra similar?](#)
- [239 - What are the most poisonous plants on earth?](#)
- [240 - Do you have any information on the toxicity of vitamins?](#)
- [241 - Could Selenium poisoning cause these symptoms in my horse?](#)
- [242 - Can you get Selenium poisoning from drinking too much milk?](#)
- [243 - Does this situation seem reasonable?](#)
- [244 - Is the Shamrock plant harmful to cats?](#)
- [245 - Can you give me some information about sheep sorrel?](#)
- [246 - Can you send me a list of plants toxic to sheep?](#)
- [247 - What could be wrong with my goats?](#)
- [248 - Could eating one small bad mushroom poison me?](#)
- [249 - Do you have any information on SMCO?](#)
- [250 - Could vitamins cause a loss of taste and smell?](#)
- [251 - How is Ricin different than Elapid snake venom?](#)
- [252 - Dou you know why my dog is acting this way?](#)
- [253 - Could you help me out with some information about Hemlock?](#)
- [254 - Dou you know if solanine can cause joint inflammation?](#)
- [255 - Do you have any experience working with Euphorbia sominalensis sap?](#)
- [257 - Is the a way to manage sorghum sudan grass to eliminate its poisonous effects?](#)
- [258 - Does docweed cure poison ivy?](#)
- [259 - Are these plants, indigenous to S.D., poisonous to humans as well as livestock?](#)

[260 - Could you give me some more information about Spartium Junceum?](#)

[261 - Can you tell me if spathiphyllum are poison to children and pets?](#)

[262 - Is Spathiphyllum poisonous?](#)

[263 - How to treat Steely Wool Syndrome in sheep?](#)

[264 - Could you give me some information on these succulents?](#)

[265 - Could you send me some information about swainsonine?](#)

[266 - I have a question regarding sweet grass...](#)

[267 - Are sycamore leaves poisonous to horses?](#)

[268 - Are snowberries toxic through the skin?](#)

[270 - Could you answer some questions for my book?](#)

[271 - Could I have some more information on Tartago tea?](#)

[272 - Do you have any information about California Pokeweed?](#)

[273 - What do you think about using tobacco or garlic to get rid of worms in goats?](#)

[274 - Which part of the tomato plant contains the Tomatine?](#)

[275 - Is Tomatine considered to be one of the solanum-type glycoalkaloids?](#)

[276 - Are tomato plants poisonous?](#)

[277 - Is it dangerous to take this many vitamins?](#)

[278 - Could you please tell me if the following plants are hazardous?](#)

[279 - Are lirioppe, bottlebrush and ficus benjamina considered toxic to animals?](#)

[280 - Can I plant these trees near my horses?](#)

[281 - What is poisonous about tung oil?](#)

[282 - Could you provide me with some information about Tung Oil?](#)

[284 - Why is U. Dioica classified as a toxic plant?](#)

[285 - How to make sure your horse is getting enough Vitamin E and Selenium?](#)

[286 - Can crown vetch be harmful to horses?](#)

[287 - Are the berries from a viburnum dentatum Chicago lustre poisonous?](#)

[289 - Could you give me some information about toxicity?](#)

[290 - Should I be concerned with taking this much vitamin D?](#)

[291 - What are the symptoms of vitamin D toxicity?](#)

[292 - Can vitamin E be toxic?](#)

[293 - Can vitamin B be toxic?](#)

[294 - Have you ever heard of vitamin D being related to deafness?](#)

[295 - Do you know of any plants that can cause the vocal chords to be paralyzed?](#)

[296 - Could you give me some information concerning vomitoxin?](#)

[297 - Do you have any information about warfarin toxicity, necropsy findings, and specimen collection?](#)

[298 - Are the tannins in my well water dangerous?](#)

[299 - Are these wildflowers toxic?](#)

[300 - Are willow branches poisonous to rats?](#)

[301 - What woods make good wood fiber for horse footing?](#)

[302 - Is there some type of wood that would cause a skin rash?](#)

[303 - My daughter made tea from some unknown yellow bell shaped flowers...](#)

[305 - Could a tea named Yerba de meite cause a positive drug test?](#)

[306 - Are any of the following plants poisonous to children, horses or dogs?](#)

[307 - What plant has the common name of Zebra Plant, and could it have caused Leukemia?](#)

[309 - Please elaborate on degrees of poisonous plants.](#)

[310 - Is Tonka bean flavoring poisonous?](#)

[311 - Is there any danger in cutting and burning Nerium Oleander?](#)

WARNING: These web pages are only meant to be informative. Neither Cornell University nor the author of this site endorse or recommend the use of these plants.

Return to: [Poisonous Plants Homepage](#)

Home page: [Animal Science at Cornell University](#)

For problems or comments on this web page, contact the Animal Science [Webmaster](#)



Indiana Plants Poisonous to Livestock and Pets

Cooperative Extension Service, Purdue University

West Lafayette, IN 47907

Rebecca J. Goetz, writer, extension assistant

Thomas N. Jordan, extension weed scientist

John W. McCain, extension weed scientist

Nancy Y. Su, assistant

Sources and Additional Readings

Botanical texts: Kingsbury, Eshleman, Meuncher, Arena, and Radcliff

Veterinary texts: The Merck Veterinary Manual, poisonous plant booklets for IL, KY and NY, Current Veterinary Therapy for Small Animals, Large Animals and Equine

Veterinary Journals: Veterinary Medicine, Veterinary Record, J. of the American Veterinary Medical Association, J. of Range Management, Modern Veterinary Practice, Compendium for the Practicing Veterinarian, J. of the American Animal Hospital Association, and others

Disclaimer! This material is for informational purposes only, not as a guide to home treatment. Contact a veterinarian or poison control center in any case of suspected poisoning! This is a work in development. We would appreciate any feedback or suggestions you might have. Please contact the [School of Veterinary Medicine Webmaster](#).

How would you like to search the database?

- [By alphabetical plant listing](#)
- [By toxicity rating](#)
- [By species affected](#)
- [By botanical type](#)

- [Picture Index](#)

PLANTS TOXIC TO ANIMALS

About this database:

This database was created in order to assist the University of Illinois veterinary students in identifying common plants that are toxic to animals. This database brings together information available in library books, plants grown in the [Poisonous Plant Garden](#), mounted specimens of plants, and the reference notes for a toxicology course (VB320) which is taught during the fall semester each year.

Although the VB320 notes address toxic plants found in all regions of the U.S., only the species most commonly found in the midwestern states are covered in this database. Common house plants are also included as opportunities arise. All of the [books employed](#) were found in the University of Illinois Library system. In particular, the booklet, Illinois plants poisonous to livestock by L.R. Tehon, C. C. Morrill, and Robert Graham provided the basis for the database structure as well as additional text information for food animals. This database will be revised or updated as time and resources permit. Photographs, unless noted otherwise, are originals taken in the Poisonous Plant Garden for this project.

The plant lists represent the entries which we hope to complete sometime in the future. Plant entries can be selected from either the [common name list](#) or the [scientific name list](#) of plants. A description of the [database structure](#) and the entries is also available.

The initial funding for this project was received from the University of Illinois Educational Technology Board and the University of Illinois Library Research and Publications Committee. Additional funding was received from Dr. Florence Dunbar.

Many thanks are due to Dr. Val Beasley for the use of his reference notes, to Zhenguo Zhang and Mary Shultz, Graduate Assistants for the project, and to Bryan McGoldrick, veterinary student and 1995-96 Curator of the Poisonous Plant Garden.

Comments and suggestions are appreciated. Please address them to [Mitsuko Williams](#), University of Illinois, Veterinary Medicine Library.



[Toxicology Homepage](#)

[Veterinary Medicine Library](#)

[UIUC Library Gateway Homepage](#)

Comments to: [M. Williams](#)

Updated on: 9-24-1999



Phytochemical and Ethnobotanical Databases

High-Low Chemical query

This query displays either a **HI-LOW** or just a list of plants containing a particular chemical.

Enter the chemical name in the box below (e.g. tyrosine) or select the Chemical link to choose from the list of chemicals in the database.

[Chemical:](#) (required)

View only the top 40 plants with quantitative data.

Check to include plants *without* quantitative data.

[WARNING](#)

Send comments or suggestions:

Jim Duke
Green Pharmacy Garden
8210 Murphy Road
Fulton, MD 20759

or

Mary Jo Bogenschutz: bogie@hawaii.rr.com

Written - September 1994
Last updated - 10 March 1998

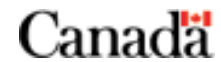

Français	Contact us	Help	Search	Canada site
Coming events	About CBIF	Links	Reports and publications	Home

Canadian Biodiversity Information Facility



Canadian Poisonous Plants Information System

[Introduction](#)

[Interactive](#)

[All poisonous plants by Botanical name](#)

[All poisonous plants by Common name](#)

[Important WWW Poisonous Plants sites](#)

by [Derek B. Munro](#)
Biological Informatics Specialist



- [Introduction](#)
- [Interactive search](#)
- [All poisonous plants by Botanical name](#)
- [All poisonous plants by Common name](#)
- [Important WWW Poisonous Plants sites](#)
- [Disclaimer](#)
- [Copyright](#)
- [XML output \(for application developers\)](#)

[Français](#) | [Contact Us](#) | [Help](#) | [Search](#) | [Canada site](#)
[Coming Events](#) | [About CBIF](#) | [Links](#) | [Reports and Publications](#) | [Home](#)

Date modified: 2003-02-06

[Important Notices](#)



[FDA Home Page](#) | [CFSAN Home](#) | [Search/Subject Index](#) | [Q & A](#) | [Help](#)

CFSAN/Office of Plant and Dairy Foods
September 2003

FDA Poisonous Plant Database

DISCLAIMER

The information in this database is intended only for scientific exchange. It has not been approved by the United States Food and Drug Administration for publication nor does it have any official status. The information is continually increasing and being modified; it is neither error-free nor comprehensive. Information herein is in the public domain. Any copyrighted or privately owned material inadvertently included will be removed as soon as possible.

For information or concerns about the toxicity of plants, contact the local Poison Control Center in your area. A directory of these is available from [The American Association of Poison Control Centers](#).
(<http://www.aapcc.org/>)

For a poisoning emergency, call 1-800-222-1222. If the victim has collapsed or is not breathing, call 911.

Search the FDA Poisonous Plant Database

Enter a term or exact phrase (e.g. a plant name). All records containing that text will be displayed. Use of common terms such as 'poison' or 'plant' will generate a large number of "hits"

Enter search term:

(search is not case-sensitive)

This database contains references to the scientific literature describing studies of the toxic properties and effects of plants and plant parts. Records are displayed in List Format as the following example indicates:

-
46. **AUTHOR(S):** Yeong, M. L.; Wakefield, S. J.; Ford, H. C.
TITLE: "Hepatocyte membrane injury and bleb formation following low dose **comfrey** toxicity in rats."

CITATION: 1993 Intnatl J Exp Pathol, 74 (2), 211-217

FDA #: F24387 || **GRIN:** 36020

FAMILY: *Boraginaceae* || **LATIN NAME:** ---

COMMON NAME: **comfrey** || **STANDARD NAME:** Symphytum officinale L.

Notes:

- This searchable database replaces the static pages of bibliographic information and the vascular plant list previously available.
 - Fields are Author(s), Title, Citation, FDA Document #, GRIN Reference, Family, Latin Name, Common Name, Standard Name.
 - The database contains approximately 49,600 records.
 - Common search terms such as 'poison' or 'plant' can generate a large number of "hits".
 - If the number of records found by the search is more than 600, you will be asked to provide a more restrictive search term.
 - --- indicates there is no entry in the database.
 - An entry form for a new search is included at the bottom of each output page.
-

[CFSAN Home](#) | [CFSAN Search/Subject Index](#) | [CFSAN Disclaimers & Privacy Policy](#) | [CFSAN Accessibility/Help](#)

[FDA Home Page](#) | [Search FDA Site](#) | [FDA A-Z Index](#) | [Contact FDA](#)

FDA/Center for Food Safety & Applied Nutrition

Hypertext updated by [frf](#) February 25, 2004

- Teaching**
- [Course List](#)
- [Course Pages](#)
- [Graduate Programs](#)
- [Undergrad Programs](#)
- [Computer Assisted](#)
- [Distance Education](#)
- Research**
- [Program Areas](#)
- [Facilities](#)
- Extension**
- [Adult Extension](#)
- [4-H Programs](#)
- [Dairy Program](#)
- [Beef Program](#)
- [Sheep Program](#)
- [Poultry Program](#)
- [Meat Goats](#)
- [Poisonous Plants](#)
- [Medicinal Plants](#)
- People**
- [Faculty](#)
- [Associates](#)
- [Staff](#)
- [Grad Students](#)
- [Grad Alumni](#)
- Databases**
- [Publications](#)
- [Hort. Images](#)
- [Ag. Images](#)
- Genetics**
- [Animal Breeding](#)
- [Dairy Genetics](#)
- [Learn basic genetics](#)
- Activities**
- [Livestock Show](#)
- [Prevet Society](#)
- CALS Website**

Animal Science Department



[Home](#)
[Search Site](#)
[Related Links](#)
[Cornell Information](#)

**Animal Science is the study of
 the biology and management
 of domestic animals.**



**Video
 Slideshows
 What's New
 Dept. History**



**Policy on Stray and Feral Cats at
 the Teaching & Research Center**



The mission of the Department of Animal Science is to discover and disseminate new knowledge about the biology and management of domestic animals; apply this knowledge to benefit society through the efficient, humane, and environmentally responsible use of animals for food, companionship, and recreation; and educate students for careers in animal biology and management. [More about the department...](#)

For general questions about animals, please use your favorite web search engine, or you might try visiting the [Cornell Vet School](#)

For Animal Science Department information, contact Alan Bell, Chair and Professor awb6@cornell.edu at Morrison Hall, Cornell University, Ithaca, NY 14853



"This web site has been selected as one of the Net's finest informative and is included in [StudyWeb\(TM\)](#)'s listing of educational links."

NOTE: The material on this web server was developed & works best with Netscape 3.01 and up, including support for frames and javascript. Monitor resolution of at least 800x600 is recommended. (1024x768 is even better.)

For problems or comments on this web page, contact the Animal Science [Webmaster](#)

[View Common name list](#)

- [*Abrus precatorius*](#)
- [*Aconitum* spp.](#)
- [*Actaea* spp.](#)
- [*Aesculus* spp.](#)
- [*Agrostemma githago*](#)
- [*Aleurites fordii*](#)
- [*Allium* spp.](#)
- [*Amanita* spp.](#)
- [*A. muscaria*](#)
- [*A. pantherina*](#)
- [*A. verna*](#)
- [*Amaranthus* spp.](#)
- [*Amsinckia intermedia*](#)
- [*Apocynum* spp.](#)
- [*Argemone mexicana*](#)
- [*Arisaema* spp.](#)
- [*Asclepias* spp.](#)
- [*Astragalus* and *Oxytropis* spp.](#)
- [*Atropa belladonna*](#)
- [*Brassica* spp.](#)
- [*Caltha palustris*](#)
- [*Cannabis sativa*](#)
- [*Centaurea solstitialis*](#)
- [*Chelidonium majus*](#)
- [*Chenopodium album*](#)
- [*Cicuta* spp.](#)
- [*Claviceps* spp.](#)
- [*Conium maculatum*](#)
- [*Coronilla varia*](#)
- [*Convallaria majalis*](#)
- [*Daphne* spp.](#)
- [*Datura* spp.](#)
- [*Delphinium* spp.](#)
- [*Dicentra* spp.](#)
- [*Digitalis purpurea*](#)
- [*Equisetum arvense* and other spp.](#)
- [*Eupatorium rugosum*](#)
- [*Euphorbia* spp.](#)
- [*Fagopyrum esculentum*](#)

- [*Festuca arundinacea*](#)
- [*Gelsemium sempervirens*](#)
- [*Glechoma* spp.](#)
- [*Halogeton glomeratus*](#)
- [*Helleborus niger*](#)
- [*Hyoscyamus niger*](#)
- [*Hypericum perforatum*](#)
- [*Iris* spp.](#)
- [*Laburnum anagyroides*](#)
- [*Lantana camara*](#)
- [*Lathyrus* spp.](#)
- [*Leucothoe axillaris* and *Leucothoe davisiae*](#)
- [*Linum usitatissimum*](#)
- [*Lobelia* spp.](#)
- [*Lotus corniculatus*](#)
- [*Lupinus* spp.](#)
- [*Medicago sativa*](#)
- [*Melilotus alba* and *Melilotus officinalis*](#)
- [*Menispermum canadense*](#)
- [*Nerium oleander*](#)
- [*Nicotiana* spp.](#)
- [*Onoclea sensibilis*](#)
- [*Ornithogalum umbellatum*](#)
- [*Papaver* spp.](#)
- [*Phytolacca americana*](#)
- [*Pieris japonica* and other spp.](#)
- [*Pinus ponderosa*](#)
- [*Podophyllum peltatum*](#)
- [*Prunus* spp.](#)
- [*Pteridium aquilinum*](#)
- [*Quercus* spp.](#)
- [*Ranunculus* spp.](#)
- [*Rheum rhaponticum*](#)
- [*Ricinus communis*](#)
- [*Robinia pseudoacacia*](#)
- [*Rumex* spp.](#)
- [*Sambucus canadensis*](#)
- [*Sanquinaria canadensis*](#)
- [*Saponaria* spp.](#)
- [*Senecio* spp.](#)

- [*Solanum* spp.](#)
- [*Sorghum* spp.](#)
- [*Symplocarpus foetidus*](#)
- [*Taxus cuspidata*](#)
- [*Tetradymia* spp.](#)
- [*Toxicodendron diversiloba*](#)
- [*Toxicodendron radicans*](#)
- [*Toxicodendron vernix*](#)
- [*Trifolium* spp.](#)
- [*Triglochin maritima*](#)
- [*Urtica* spp.](#)
- [*Vicia* spp.](#)
- [*Veratrum californicum*](#)
- [*Wisteria* spp.](#)
- [*Xanthium strumarium*](#)
- [*Zigadenus* spp.](#)

[**View Common Name List**](#)

Scientific Name: *Aconitum spp.*

Common Name: Monkshood, Aconite, or Wolfsbane



Species Most Often Affected: humans, cattle, goats
Poisonous Parts: leaves, roots, all
Primary Poisons:aconitine

Questions pertaining to *Aconitum spp.*:

[Can you give me some information about human exposure to Monkshood?](#)

This image is copyrighted. It may be used in teaching, printed, downloaded, or copied, provided it is in an educational setting and proper attribution is provided. Alteration of this image in any form is restricted.

Scientific Name: *Medicago sativa*

Common Name: Alfalfa or Lucerne



Species Most Often Affected: cattle, chickens, humans, sheep
Poisonous Parts: all
Primary Poisons: canavanine, saponins

This image is copyrighted. It may be used in teaching, printed, downloaded, or copied, provided it is in an educational setting and proper attribution is provided. Alteration of this image in any form is restricted.

Scientific Name: *Trifolium spp.*

Common Name: Alsike Clover, Red Clover, White Clover



Species Most Often Affected: horse, cattle

Poisonous Parts: all, leaves

Primary Poisons: nitrate

[Scroll down for more images.](#)





Questions pertaining to *Trifolium spp.*:

[What could cause these horses to drool?](#)

[What could cause these horses to drool?](#)

[Do you know of a list that compares the plant toxicity in horses and ruminants?](#)

[Are sycamore leaves poisonous to horses?](#)

[Compare and contrast plants toxic to horses and ruminants.](#)

[How do you identify an Alsike clover?](#)

This image is copyrighted. It may be used in teaching, printed, downloaded, or copied, provided it is in an educational setting and proper attribution is provided. Alteration of this image in any form is restricted.

Scientific Name: *Datura spp.*

Common Name: Jimsonweed, Downy Thornapple, Devil's Trumpet, Angel's Trumpet



Species Most Often Affected: cattle, humans, horses, goats

Poisonous Parts: flowers, leaves, seeds

Primary Poisons: atropine, scopolamine, and hyoscyamine

[Scroll down for more images.](#)





- DTWA000I: Net.Data detected an internal error [IBM][CLI Driver][DB2/6000] SQL0007N
The character "%" following "SE('%Devil's Trumpet" is not valid. SQLSTATE=42601.

Scientific Name: *Triglochin maritima*

Common Name: Arrowgrass



Species Most Often Affected: cattle, sheep

Poisonous Parts: all, leaves, flowers

Primary Poisons: taxiphillin, triglochinin

This image is copyrighted. It may be used in teaching, printed, downloaded, or copied, provided it is in an educational setting and proper attribution is provided. Alteration of this image in any form is restricted.

Scientific Name: *Actaea spp.*

Common Name: Baneberry, Dolls Eyes, White Cohosh, Snakeberry



Species Most

Often Affected:

Poisonous Parts: roots, sap, berries

Primary Poisons: protoanemonin

[Scroll down for more images.](#)





This image is copyrighted. It may be used in teaching, printed, downloaded, or copied, provided it is in an educational setting and proper attribution is provided. Alteration of this image in any form is restricted.

Scientific Name: *Atropa belladonna*

Common Name: Belladonna or Deadly Nightshade



Species Most Often Affected: humans, goats

Poisonous Parts: all

Primary Poisons: atropine and scopolamine

[Scroll down for more images.](#)



Questions pertaining to *Atropa belladonna*:

[Need macro and microscopic identification of *Atropa belladonna*.](#)

This image is copyrighted. It may be used in teaching, printed, downloaded, or copied, provided it is in an educational setting and proper attribution is provided. Alteration of this image in any form is restricted.

Scientific Name: *Lotus corniculatus*

Common Name: Birdsfoot Trefoil



Species Most Often Affected: cattle, sheep

Poisonous Parts:

Primary Poisons: CN tannini

This image is copyrighted. It may be used in teaching, printed, downloaded, or copied, provided it is in an educational setting and proper attribution is provided. Alteration of this image in any form is restricted.

Scientific Name: *Robinia pseudoacacia*

Common Name: Black Locust



Species Most Often Affected: horses, cattle, humans, poultry, sheep, goats
Poisonous Parts: bark, leaves, seeds
Primary Poisons: robin, phasin

[Scroll down for more images.](#)





Questions pertaining to *Robinia pseudoacacia*:

[Does black locust wood affect horses?](#)

This image is copyrighted. It may be used in teaching, printed, downloaded, or copied, provided it is in an educational setting and proper attribution is provided. Alteration of this image in any form is restricted.

Scientific Name: *Dicentra spp.*

Common Name: Bleeding Heart, Squirrel Corn, Dutchman's Breeches



Species Most Often Affected: cats, cattle, humans

Poisonous Parts: all

Primary Poisons: isoquinolone alkaloids

[Scroll down for more images.](#)





- DTWA000I: Net.Data detected an internal error [IBM][CLI Driver][DB2/6000] SQL0007N
The character "%" following "%Dutchman's Breeches" is not valid. SQLSTATE=42601.

Scientific Name: *Sanquinaria canadensis*

Common Name: Bloodroot



Species Most Often Affected: goats

Poisonous Parts:

Primary Poisons:

[Scroll down for more images.](#)



Questions pertaining to *Sanquinaria canadensis*:

[My sister took too high a dose of bloodroot. What will that do to her?](#)

This image is copyrighted. It may be used in teaching, printed, downloaded, or copied, provided it is in an educational setting and proper attribution is provided. Alteration of this image in any form is restricted.

Scientific Name: *Saponaria spp.*

Common Name: Bouncing Bet and Cow Cockle



Species Most

Often Affected:

Poisonous Parts: seeds

Primary Poisons:saponins

[Scroll down for more images.](#)



This image is copyrighted. It may be used in teaching, printed, downloaded, or copied, provided it is in an educational setting and proper attribution is provided. Alteration of this image in any form is restricted.

Scientific Name: *Pteridium aquilinum*

Common Name: Bracken Fern



Species Most

Often Affected: horse, cattle, sheep, humans, swine

Poisonous Parts: all

Primary Poisons: prunasin, ptaquiloside, thiaminase

This image is copyrighted. It may be used in teaching, printed, downloaded, or copied, provided it is in an educational setting and proper attribution is provided. Alteration of this image in any form is restricted.

Scientific Name: *Aesculus spp.*

Common Name: Horse Chestnut, Buckeye



Species Most Often Affected: humans, cattle, goats

Poisonous Parts: fruit

Primary Poisons: Unknown, possibly saporins, narcotic alkaloids, or glycosides.

[Scroll down for more images.](#)





Questions pertaining to *Aesculus spp.*:

[Has a scientific analysis ever been made of Buckeyes?](#)

This image is copyrighted. It may be used in teaching, printed, downloaded, or copied, provided it is in an educational setting and proper attribution is provided. Alteration of this image in any form is restricted.

Scientific Name: *Fagopyrum esculentum*

Common Name: Buckwheat



Species Most Often Affected: horses, goats

Poisonous Parts:

Primary Poisons:

Link to web page(s): plants/buckwheat.html

Scroll down for more images.



This image is copyrighted. It may be used in teaching, printed, downloaded, or copied, provided it is in an educational setting and proper attribution is provided. Alteration of this image in any form is restricted.

Scientific Name: *Solanum spp.*

Common Name: Common Nightshade, Black Nightshade, Horse Nettle, Buffalo Bur, Potato



Species Most Often Affected: cattle, humans, rodents, sheep, horses, goats
Poisonous Parts: leaves, immature fruit
Primary Poisons: soladulcidine, solanine

[Scroll down for more images.](#)





Questions pertaining to *Solanum spp.*:
[Can horse nettle poison the meat of beef cattle?](#)
[Does this situation seem reasonable?](#)

This image is copyrighted. It may be used in teaching, printed, downloaded, or copied, provided it is in an educational setting and proper attribution is provided. Alteration of this image in any form is restricted.

Scientific Name: *Ranunculus spp.*

Common Name: Buttercups or Crowfoot



Species Most Often Affected: cattle, goats, horses

Poisonous Parts: all

Primary Poisons: protoanemonin

[Scroll down for more images.](#)



This image is copyrighted. It may be used in teaching, printed, downloaded, or copied, provided it is in an educational setting and proper attribution is provided. Alteration of this image in any form is restricted.

Scientific Name: *Ricinus communis*

Common Name: Castor Bean



Species Most Often Affected: all

Poisonous Parts: seeds

Primary Poisons: ricin, albumin

Link to web page(s): </plants/castorbean.html>

Scroll down for more images.



Questions pertaining to *Ricinus communis*:

[Should I be concerned about the castor bean plant in my yard?](#)

[Do you know of any plants that kill gophers?](#)

[What is the most poisonous plant in the world to humans?](#)

[Is it possible for ricin to be absorbed through the skin and cause death?](#)

[Could Ricin be used by terrorists?](#)

[I need some information about Ricin...](#)

[Could you tell me some more about the Castor Bean plant?](#)

[Could you answer some questions about powdered Ricin for me?](#)

[How should I reference some information I took off of your website?](#)

[What are the most poisonous plants on earth?](#)

[How is Ricin different than Elapid snake venom?](#)

This image is copyrighted. It may be used in teaching, printed, downloaded, or copied, provided it is in an educational setting and proper attribution is provided. Alteration of this image in any form is restricted.

Scientific Name: *Chelidonium majus*

Common Name: Celandine



Species Most Often Affected: cattle, humans

Poisonous Parts: roots

Primary Poisons: isoquinoline alkoids

[Scroll down for more images.](#)



This image is copyrighted. It may be used in teaching, printed, downloaded, or copied, provided it is in an educational setting and proper attribution is provided. Alteration of this image in any form is restricted.

Scientific Name: *Helleborus niger*

Common Name: Christmas Rose



Species Most Often Affected: humans

Poisonous Parts: all

Primary Poisons: protoanemonin

[Scroll down for more images.](#)





This image is copyrighted. It may be used in teaching, printed, downloaded, or copied, provided it is in an educational setting and proper attribution is provided. Alteration of this image in any form is restricted.

Scientific Name: *Xanthium strumarium*

Common Name: Cocklebur



Species Most Often Affected: cattle, humans, rodents, swine

Poisonous Parts: seedlings, seeds

Primary Poisons: carboxyatractyloside

[Scroll down for more images.](#)



This image is copyrighted. It may be used in teaching, printed, downloaded, or copied, provided it is in an educational setting and proper attribution is provided. Alteration of this image in any form is restricted.

Scientific Name: *Agrostemma githago*

Common Name: Corn Cockle



Species Most Often Affected: poultry, cattle, humans, goats
Poisonous Parts: seeds
Primary Poisons: githagin

[Scroll down for more images.](#)



This image is copyrighted. It may be used in teaching, printed, downloaded, or copied, provided it is in an educational setting and proper attribution is provided. Alteration of this image in any form is restricted.

Scientific Name: *Veratrum californicum*

Common Name: Corn Lily, False Hellbore



Species Most

Often Affected: sheep

Poisonous Parts: all

Primary Poisons: cyclopamine

Link to web page(s): [plants/veratrum.html](http://plants.veratrum.html)

[Scroll down for more images.](#)





Questions pertaining to *Veratrum californicum*:

[Could *Laurentia longiflora* be responsible for my fish dying?](#)

[Do you have any information on *Laurentia longiflora*?](#)

[Could you tell me if Peace Lily is poisonous?](#)

[Could you give me some information on the toxicity of the peace lily?](#)

[Is this peace plant toxic?](#)

[Do you know why my dog is acting this way?](#)

This image is copyrighted. It may be used in teaching, printed, downloaded, or copied, provided it is in an educational setting and proper attribution is provided. Alteration of this image in any form is restricted.

Scientific Name: *Glechoma spp.*

Common Name: Ground Ivy, Creeping Charlie, and Gill over the Ground



Species Most Often Affected: horses, goats
Poisonous Parts: leaves, stems
Primary Poisons: unknown

Questions pertaining to *Glechoma spp.*:

[What could have caused my rash?](#)

[Can you tell one poison rash from the other?](#)

[What could have caused these blisters?](#)

[Have you ever heard of poison sumac being used as a filler in peat moss?](#)

[Do you know where I can find poison ivy extract?](#)

[Is poison ivy only poisonous to humans and primates?](#)

[Do you know of any oral medication to prevent Poison Ivy?](#)

[Does docweed cure poison ivy?](#)

[What would happen if you were exposed to a poisonous plant?](#)

This image is copyrighted. It may be used in teaching, printed, downloaded, or copied, provided it is in an educational setting and proper attribution is provided. Alteration of this image in any form is restricted.

Scientific Name: *Coronilla varia*

Common Name: Crown Vetch



Species Most Often Affected: horse

Poisonous Parts:

Primary Poisons:

Questions pertaining to *Coronilla varia*:

[Is Crown Vetch safe to feed to horses?](#)

[Can crown vetch be harmful to horses?](#)

This image is copyrighted. It may be used in teaching, printed, downloaded, or copied, provided it is in an educational setting and proper attribution is provided. Alteration of this image in any form is restricted.

Scientific Name: *Prunus spp.*

Common Name: Wild Cherries, Black Cherry, Bitter Cherry, Choke Cherry, Pin Cherry



Species Most Often Affected: horses, cattle, moose, sheep, swine, goats

Poisonous Parts: seeds, leaves

Primary Poisons: amygdalin, prunasin

[Scroll down for more images.](#)





This image is copyrighted. It may be used in teaching, printed, downloaded, or copied, provided it is in an educational setting and proper attribution is provided. Alteration of this image in any form is restricted.

Scientific Name: *Daphne spp.*

Common Name: Daphne



Species Most Often Affected: cats, dogs, humans

Poisonous Parts: berries, all

Primary Poisons: mezereinic acid anhydride

[Scroll down for more images.](#)



This image is copyrighted. It may be used in teaching, printed, downloaded, or copied, provided it is in an educational setting and proper attribution is provided. Alteration of this image in any form is restricted.

Scientific Name: *Amanita spp.*

Common Name: Monkey Agaric, Panther Cap, Death Cap, and Death Angel Mushrooms



Species Most

Often Affected: all

Poisonous Parts: cap?

Primary Poisons: toxalbumin

Questions pertaining to *Amanita spp.*:

[Is Death Parasol the same as Death Cap?](#)

This image is copyrighted. It may be used in teaching, printed, downloaded, or copied, provided it is in an educational setting and proper attribution is provided. Alteration of this image in any form is restricted.

Scientific Name: *Zigadenus spp.*

Common Name: Death Camas



Species Most Often Affected: all

Poisonous Parts: all, bulbs, leaves, flowers, pollen

Primary Poisons: zygacine

[Scroll down for more images.](#)





Questions pertaining to *Zigadenus spp.*:
[Does this situation seem reasonable?](#)

This image is copyrighted. It may be used in teaching, printed, downloaded, or copied, provided it is in an educational setting and proper attribution is provided. Alteration of this image in any form is restricted.

Scientific Name: *A. verna*

Common Name: Destroying Angels



Species Most Often Affected: all

Poisonous Parts: cap?

Primary Poisons: ibotenic acid and muscimol

[Scroll down for more images.](#)



This image is copyrighted. It may be used in teaching, printed, downloaded, or copied, provided it is in an educational setting and proper attribution is provided. Alteration of this image in any form is restricted.

Scientific Name: *Delphinium spp.*

Common Name: Delphiniums and Larkspurs



Species Most Often Affected: cattle, humans, goats

Poisonous Parts: all

Primary Poisons: alkaloids delphinine, ajacine, and others

[Scroll down for more images.](#)





This image is copyrighted. It may be used in teaching, printed, downloaded, or copied, provided it is in an educational setting and proper attribution is provided. Alteration of this image in any form is restricted.

Scientific Name: *Rumex spp.*

Common Name: Dock



Species Most Often Affected: cattle, sheep

Poisonous Parts: leaves

Primary Poisons: soluble oxalates

[Scroll down for more images.](#)



Questions pertaining to *Rumex spp.*:

[Need macro and microscopic identification of *Atropa belladonna*.](#)

This image is copyrighted. It may be used in teaching, printed, downloaded, or copied, provided it is in an educational setting and proper attribution is provided. Alteration of this image in any form is restricted.

Scientific Name: *Apocynum spp.*

Common Name: Dogbane



Species Most Often Affected: horses, cattle, humans, sheep, cats, dogs, goats

Poisonous Parts: rhizome

Primary Poisons: apocynamarin

[Scroll down for more images.](#)





Questions pertaining to *Apocynum* spp.:

[What type of poison is present in oleander?](#)

[Is *Plumeria rubra* poisonous to cats?](#)

This image is copyrighted. It may be used in teaching, printed, downloaded, or copied, provided it is in an educational setting and proper attribution is provided. Alteration of this image in any form is restricted.

Scientific Name: *Leucothoe axillaris* and *Leucothoe davisiae*

Common Name: Drooping Leucothoe and Sierra Laurel



Species Most Often Affected: goats, sheep
Poisonous Parts: leaves, nectar
Primary Poisons: andromedotoxin

This image is copyrighted. It may be used in teaching, printed, downloaded, or copied, provided it is in an educational setting and proper attribution is provided. Alteration of this image in any form is restricted.

Scientific Name: *Sambucus canadensis*

Common Name: Elderberry



Species Most Often Affected: cattle, humans, goats

Poisonous Parts: leaves, twigs, roots, unripe fruits

Primary Poisons: sambunigrin

[Scroll down for more images.](#)





Questions pertaining to *Sambucus canadensis*:

[Are elderberries poisonous to humans?](#)

[Are *Sambucus canadensis* and *Sambucus nigra* similar?](#)

This image is copyrighted. It may be used in teaching, printed, downloaded, or copied, provided it is in an educational setting and proper attribution is provided. Alteration of this image in any form is restricted.

Scientific Name: *Claviceps spp.*

Common Name: Ergot



Species Most Often Affected: all

Poisonous Parts: fungus

Primary Poisons: indole alkaloid

This image is copyrighted. It may be used in teaching, printed, downloaded, or copied, provided it is in an educational setting and proper attribution is provided. Alteration of this image in any form is restricted.

Scientific Name: *A. muscaria*

Common Name: Fly Agaric



Species Most Often Affected: all

Poisonous Parts: cap?

Primary Poisons: ibotenic acid and muscimol

[Scroll down for more images.](#)



This image is copyrighted. It may be used in teaching, printed, downloaded, or copied, provided it is in an educational setting and proper attribution is provided. Alteration of this image in any form is restricted.

Scientific Name: *Amsinckia intermedia*

Common Name: Fiddleneck



Species Most Often Affected: horses, swine, cattle

Poisonous Parts: seeds

Primary Poisons: intermedine, lycopsamine

[Scroll down for more images.](#)



Questions pertaining to *Amsinckia intermedia*:

[Which poisonous plants are in the Bay area of California?](#)

[Can the cold weather kill off Fiddleneck?](#)

[I need some information on Fiddleneck...](#)

This image is copyrighted. It may be used in teaching, printed, downloaded, or copied, provided it is in an educational setting and proper attribution is provided. Alteration of this image in any form is restricted.

Scientific Name: *Linum usitatissimum*

Common Name: Flax



Species Most Often Affected: cattle, sheep

Poisonous Parts: all

Primary Poisons: cyanogenic glycoside

[Scroll down for more images.](#)



Questions pertaining to *Linum usitatissimum*:

[Can flax seeds be poisonous to horses?](#)

[Could you give me some information about the toxicity of these plants?](#)

[Are these plants really poisonous?](#)

[Are these wildflowers toxic?](#)

This image is copyrighted. It may be used in teaching, printed, downloaded, or copied, provided it is in an educational setting and proper attribution is provided. Alteration of this image in any form is restricted.

Scientific Name: *Digitalis purpurea*

Common Name: Foxglove



Species Most Often Affected: cats, cattle, dogs, goats, horses, humans
Poisonous Parts: flowers, leaves, seeds
Primary Poisons: cardiac or steroid glycosides
Link to web page(s): plants/digitalis.html

[Scroll down for more images.](#)



Questions pertaining to *Digitalis purpurea*:

[Could *Laurentia longiflora* be responsible for my fish dying?](#)

[Do you have any information on *Laurentia longiflora*?](#)

[What type of poison is present in oleander?](#)

[Is *Plumeria rubra* poisonous to cats?](#)

[Could you answer some questions for my book?](#)

This image is copyrighted. It may be used in teaching, printed, downloaded, or copied, provided it is in an educational setting and proper attribution is provided. Alteration of this image in any form is restricted.

Scientific Name: *Laburnum anagyroides*

Common Name: Golden Chain or Laburnum



Species Most Often Affected: cattle, dogs, horses, humans, swine
Poisonous Parts: pods, seeds, all
Primary Poisons: cytisine

[Scroll down for more images.](#)



This image is copyrighted. It may be used in teaching, printed, downloaded, or copied, provided it is in an educational setting and proper attribution is provided. Alteration of this image in any form is restricted.

Scientific Name: *Lobelia spp.*

Common Name: Great Lobelia, Cardinal Flower, and Indian Tobacco



Species Most Often Affected: humans, goats

Poisonous Parts: all

Primary Poisons: lobelamine, lobeline

[Scroll down for more images.](#)





This image is copyrighted. It may be used in teaching, printed, downloaded, or copied, provided it is in an educational setting and proper attribution is provided. Alteration of this image in any form is restricted.

Scientific Name: *Senecio spp.*

Common Name: Senecio, Groundsels, and Ragworts



Species Most Often Affected: horse, cattle, goats, sheep, human
Poisonous Parts: leaves
Primary Poisons: jacobine, seneciphylline

[Scroll down for more images.](#)



Questions pertaining to *Senecio spp.*:

[Which poisonous plants are in the Bay area of California?](#)

[Does Ragwort exist in the US or Canada?](#)

This image is copyrighted. It may be used in teaching, printed, downloaded, or copied, provided it is in an educational setting and proper attribution is provided. Alteration of this image in any form is restricted.

Scientific Name: *Halogeton glomeratus*

Common Name: Halogeton



Species Most Often Affected: sheep, cattle

Poisonous Parts: leaves, stems

Primary Poisons: soluble oxalates

[Scroll down for more images.](#)



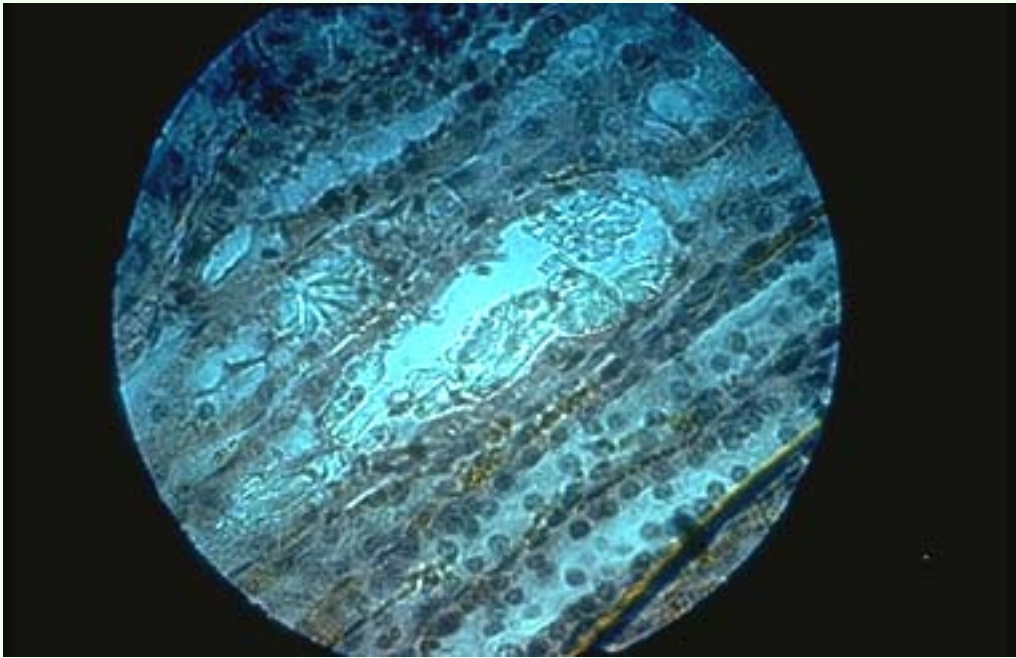

This image is copyrighted. It may be used in teaching, printed, downloaded, or copied, provided it is in an educational setting and proper attribution is provided. Alteration of this image in any form is restricted.

Scientific Name: *Tetradymia spp.*

Common Name: Horsebrush



Species Most Often Affected: sheep, cattle

Poisonous Parts: leaves

Primary Poisons:

[Scroll down for more images.](#)



This image is copyrighted. It may be used in teaching, printed, downloaded, or copied, provided it is in an educational setting and proper attribution is provided. Alteration of this image in any form is restricted.

Scientific Name: *Equisetum arvense* and other spp.

Common Name: Horsetail



Species Most Often Affected: horse
Poisonous Parts:
Primary Poisons:

[Scroll down for more images.](#)





Questions pertaining to *Equisetum arvense* and other spp.:
[How can I get rid of this horsetail \(equisetum arvense\)?](#)

This image is copyrighted. It may be used in teaching, printed, downloaded, or copied, provided it is in an educational setting and proper attribution is provided. Alteration of this image in any form is restricted.

Scientific Name: *Iris spp.*

Common Name: Irises



Species Most Often Affected: cattle, humans, swine

Poisonous Parts: rhizomes and rootstocks

Primary Poisons: irisin, iridin, or irisine

This image is copyrighted. It may be used in teaching, printed, downloaded, or copied, provided it is in an educational setting and proper attribution is provided. Alteration of this image in any form is restricted.

List of Scientific and Common Name Equivalents

- 1 *Abrus precatorius* - Rosary Pea
- 2 *Aconitum spp.* - Monkshood, Aconite, or Wolfsbane
- 3 *Actaea spp.* - Baneberry, Dolls Eyes, White Cohosh, Snakeberry
- 4 *Aesculus spp.* - Horse Chestnut, Buckeye
- 5 *Agrostemma githago* - Corn Cockle
- 6 *Aleurites fordii* - Tung Oil Tree
- 7 *Allium spp.* - Commercial Onions, Wild Onions, Swamp Onions, and Chives
- 8 *Amanita spp.* - Monkey Agaric, Panther Cap, Death Cap, and Death Angel Mushrooms
- 9 *A. muscaria* - Fly Agaric
- 10 *A. pantherina* - Panther
- 11 *A. verna* - Destroying Angels
- 12 *Amaranthus spp.* - Pigweed
- 13 *Amsinckia intermedia* - Fiddleneck
- 14 *Apocynum spp.* - Dogbane
- 15 *Argemone mexicana* - Prickly Poppy or Mexican Poppy
- 16 *Arisaema spp.* - Jack in the Pulpit
- 17 *Asclepias spp.* - Milkweed
- 18 *Astragalus and Oxytropis spp.* - Locoweed
- 19 *Atropa belladonna* - Belladonna or Deadly Nightshade
- 20 *Brassica spp.* - Rape, Cabbage, Turnips, Broccoli, Mustard
- 21 *Caltha palustris* - Marsh Marigold or Cowslip
- 22 *Cannabis sativa* - Marijuana
- 23 *Centaurea solstitialis* - Yellow Star Thistle
- 24 *Chelidonium majus* - Celandine
- 25 *Chenopodium album* - Lamb's Quarters
- 26 *Cicuta spp.* - Water Hemlock or Cowbane
- 27 *Claviceps spp.* - Ergot
- 28 *Conium maculatum* - Poison Hemlock
- 29 *Coronilla varia* - Crown Vetch
- 30 *Convallaria majalis* - Lily of the Valley
- 31 *Daphne spp.* - Daphne
- 32 *Datura spp.* - Jimsonweed, Downy Thornapple, Devil's Trumpet, Angel's Trumpet
- 33 *Delphinium spp.* - Delphiniums and Larkspurs
- 34 *Dicentra spp.* - Bleeding Heart, Squirrel Corn, Dutchman's Breeches
- 35 *Digitalis purpurea* - Foxglove
- 36 *Equisetum arvense and other spp.* - Horsetail
- 37 *Eupatorium rugosum* - White Snakeroot

- 38 *Euphorbia spp.* - Poinsettia, Spurges, Snow on the Mountain
- 39 *Fagopyrum esculentum* - Buckwheat
- 40 *Festuca arundinacea* - Tall Fescue
- 41 *Gelsemium sempervirens* - Jessamine
- 42 *Glechoma spp.* - Ground Ivy, Creeping Charlie, and Gill over the Ground
- 43 *Halogeton glomeratus* - Halogeton
- 44 *Helleborus niger* - Christmas Rose
- 45 *Hyoscyamus niger* - Henbane
- 46 *Hypericum perforatum* - St. Johns Wort, Klamath Weed
- 47 *Iris spp.* - Irises
- 48 *Laburnum anagyroides* - Golden Chain or Laburnum
- 49 *Lantana camara* - Lantana, Red Sage, Yellow Sage, or West Indian Lantana
- 50 *Lathyrus spp.* - Sweet Pea, Tangier Pea, Everlasting Pea, Caley Pea and Singletary Pea
- 51 *Leucothoe axillaris and Leucothoe davisiae* - Drooping Leucothoe and Sierra Laurel
- 52 *Linum usitatissimum* - Flax
- 53 *Lobelia spp.* - Great Lobelia, Cardinal Flower, and Indian Tobacco
- 54 *Lotus corniculatus* - Birdsfoot Trefoil
- 55 *Lupinus spp.* - Lupine
- 56 *Medicago sativa* - Alfalfa or Lucerne
- 57 *Metilotus alba and Melilotus officinalis* - White and Yellow Sweetclover
- 58 *Menispermum canadense* - Moonseed
- 59 *Nerium oleander* - Oleander
- 60 *Nicotiana spp.* - Tobacco and Tree Tobacco
- 61 *Onoclea sensibilis* - Sensitive Fern
- 62 *Ornithogalum umbellatum* - Star of Bethlehem
- 63 *Papaver spp.* - Various Poppies including Opium Poppy
- 64 *Phytolacca americana* - Pokeweed
- 65 *Pieris japonica and other spp.* - Japanese Pieris, Mountain Fetterbrush
- 66 *Pinus ponderosa* - Ponderosa Pine
- 67 *Podophyllum peltatum* - Mayapple and Mandrake
- 68 *Prunus spp.* - Wild Cherries, Black Cherry, Bitter Cherry, Choke Cherry, Pin Cherry
- 69 *Pteridium aquilinum* - Bracken Fern
- 70 *Quercus spp.* - Oak Trees
- 71 *Ranunculus spp.* - Buttercups or Crowfoot
- 72 *Rheum rhaponticum* - Rhubarb
- 73 *Ricinus communis* - Castor Bean
- 74 *Robinia pseudoacacia* - Black Locust
- 75 *Rumex spp.* - Dock

- 76 *Sambucus canadensis* - Elderberry
- 77 *Sanquinaria canadensis* - Bloodroot
- 78 *Saponaria spp.* - Bouncing Bet and Cow Cockle
- 79 *Senecio spp.* - Senecio, Groundsels, and Ragworts
- 80 *Solanum spp.* - Common Nightshade, Black Nightshade, Horse Nettle, Buffalo Bur, Potato
- 81 *Sorghum spp.* - Sorghum or Milo, Sudan Grass, and Johnson Grass
- 82 *Symplocarpus foetidus* - Eastern Skunk Cabbage
- 83 *Taxus cuspidata* - Yew
- 84 *Tetradymia spp.* - Horsebrush
- 85 *Toxicodendron diversiloba* - Poison oak
- 86 *Toxicodendron radicans* - Poison ivy
- 87 *Toxicodendron vernix* - Poison Sumac
- 88 *Trifolium spp.* - Alsike Clover, Red Clover, White Clover
- 89 *Triglochin maritima* - Arrowgrass
- 90 *Urtica spp.* - Stinging Nettle
- 91 *Vicia spp.* - Common Vetch, Hairy Vetch, Narrow leaved Vetch, Purple Vetch and Broad Beans
- 92 *Veratrum californicum* - Corn Lily, False Hellbore
- 93 *Wisteria spp.* - Wisteria
- 94 *Xanthium strumarium* - Cocklebur
- 95 *Zigadenus spp.* - Death Camas
- 96 *Acer rubrum* - Red maple, Swamp maple, Soft maple
- 97 *Acer saccharum* - Sugar maple, Rock maple, Hard maple
- 98 *Acer saccharinum* - Silver maple, Soft maple, White maple

Scientific Name: *Arisaema spp.*

Common Name: Jack in the Pulpit



Species Most Often Affected: humans
Poisonous Parts: all
Primary Poisons: oxalate

Questions pertaining to *Arisaema spp.*:

[Could you help me find some information on plants poisonous to dogs?](#)

This image is copyrighted. It may be used in teaching, printed, downloaded, or copied, provided it is in an educational setting and proper attribution is provided. Alteration of this image in any form is restricted.

Scientific Name: *Pieris japonica* and other spp.

Common Name: Japanese Pieris, Mountain Fetterbrush



Species Most

Often Affected:

Poisonous Parts: leaves, nectar

Primary Poisons: andromedotoxin

[Scroll down for more images.](#)



Questions pertaining to *Pieris japonica* and other spp.:

[Are Pieris Japonica plants poisonous to dogs?](#)

This image is copyrighted. It may be used in teaching, printed, downloaded, or copied, provided it is in an educational setting and proper attribution is provided. Alteration of this image in any form is restricted.

Scientific Name: *Gelsemium sempervirens*

Common Name: Jessamine



Species Most Often Affected: horses, goats
Poisonous Parts: all
Primary Poisons: gelsemine

This image is copyrighted. It may be used in teaching, printed, downloaded, or copied, provided it is in an educational setting and proper attribution is provided. Alteration of this image in any form is restricted.

Scientific Name: *Sorghum spp.*

Common Name: Sorghum or Milo, Sudan Grass, and Johnson Grass



Species Most Often Affected: horses, cattle, goats
Poisonous Parts: leaves, stems
Primary Poisons: dhurrin, nitrate

[Scroll down for more images.](#)



Questions pertaining to *Sorghum spp.*:

[Is there a way to manage sorghum sudan grass to eliminate its poisonous effects?](#)

This image is copyrighted. It may be used in teaching, printed, downloaded, or copied, provided it is in an educational setting and proper attribution is provided. Alteration of this image in any form is restricted.

Scientific Name: *Hypericum perforatum*

Common Name: St. Johns Wort, Klamath Weed



Species Most Often Affected: horses, sheep, goats

Poisonous Parts: all

Primary Poisons: hypericum

[Scroll down for more images.](#)





Questions pertaining to *Hypericum perforatum*:
[Are these plants really poisonous?](#)

This image is copyrighted. It may be used in teaching, printed, downloaded, or copied, provided it is in an educational setting and proper attribution is provided. Alteration of this image in any form is restricted.

Scientific Name: *Chenopodium album*

Common Name: Lamb's Quarters



Species Most Often Affected: cattle, horses, humans, sheep, swine

Poisonous Parts: all

Primary Poisons: nitrates

[Scroll down for more images.](#)



- DTWA000I: Net.Data detected an internal error [IBM][CLI Driver][DB2/6000] SQL0007N
The character "%" following "SE('%Lamb's Quarters" is not valid. SQLSTATE=42601.

Scientific Name: *Lantana camara*

Common Name: Lantana, Red Sage, Yellow Sage, or West Indian Lantana



Species Most Often Affected: cattle, dogs, goats, cats, humans, sheep
Poisonous Parts: unripe, green berries
Primary Poisons: triterpenes

Questions pertaining to *Lantana camara*:

[Need more information on these plants...](#)

[Could you tell me if these landscaping plants are poisonous horses?](#)

[How dangerous are lantana berries?](#)

This image is copyrighted. It may be used in teaching, printed, downloaded, or copied, provided it is in an educational setting and proper attribution is provided. Alteration of this image in any form is restricted.

Scientific Name: *Convallaria majalis*

Common Name: Lily of the Valley



Species Most Often Affected: cats, dogs, humans, goats

Poisonous Parts: all

Primary Poisons: cardiac glycosides and saponins

[Scroll down for more images.](#)



Questions pertaining to *Convallaria majalis*:

[Could *Laurentia longiflora* be responsible for my fish dying?](#)

[Do you have any information on *Laurentia longiflora*?](#)

This image is copyrighted. It may be used in teaching, printed, downloaded, or copied, provided it is in an educational setting and proper attribution is provided. Alteration of this image in any form is restricted.

Scientific Name: *Astragalus* and *Oxytropis* spp.

Common Name: Locoweed



Species Most Often Affected: horse, sheep, cattle

Poisonous Parts: flowers, leaves, stems

Primary Poisons: selenium, nitro compounds, swainsonine

[Scroll down for more images.](#)





Questions pertaining to *Astragalus* and *Oxytropis* spp.:
[Could you send me some information about swainsonine?](#)

This image is copyrighted. It may be used in teaching, printed, downloaded, or copied, provided it is in an educational setting and proper attribution is provided. Alteration of this image in any form is restricted.

Scientific Name: *Lupinus spp.*

Common Name: Lupine

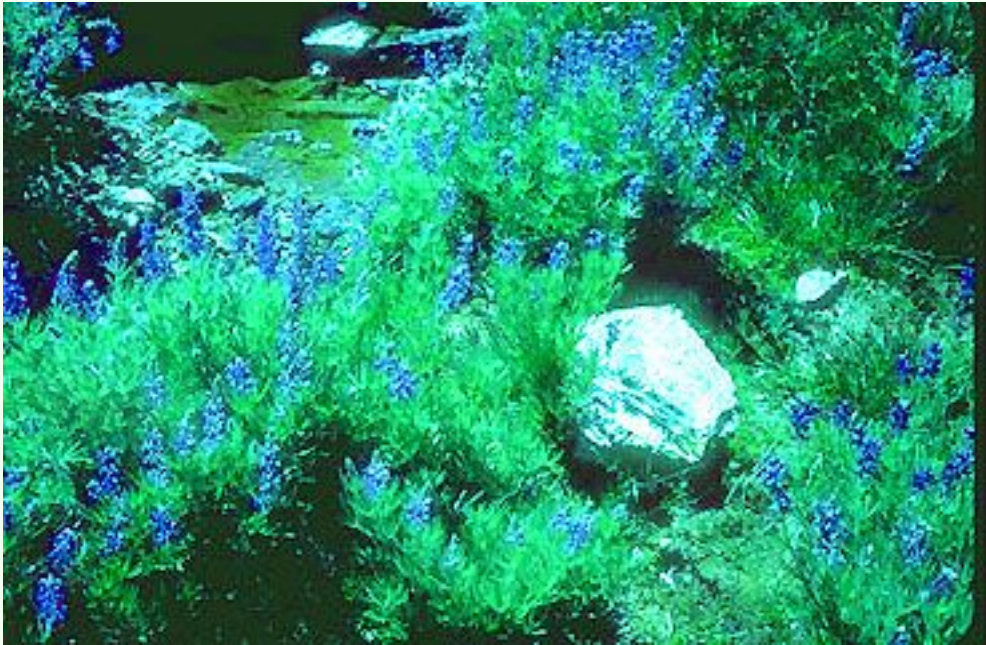

Species Most

cattle, goats

Often Affected:

Poisonous Parts: seeds

Primary Poisons: lupinine, anagrine, sparteine, and hydroxylupanine

Link to web page(s): plants/lupine.html

Scroll down for more images.





This image is copyrighted. It may be used in teaching, printed, downloaded, or copied, provided it is in an educational setting and proper attribution is provided. Alteration of this image in any form is restricted.

Scientific Name: *Cannabis sativa*

Common Name: Marijuana



Species Most Often Affected: dogs, ferrets, cats, goats
Poisonous Parts: all, flower stalks
Primary Poisons: resins, THC

Questions pertaining to *Cannabis sativa*:

[Could a tea named Yerba de meite cause a positive drug test?](#)

This image is copyrighted. It may be used in teaching, printed, downloaded, or copied, provided it is in an educational setting and proper attribution is provided. Alteration of this image in any form is restricted.

Scientific Name: *Caltha palustris*

Common Name: Marsh Marigold or Cowslip



Species Most

Often Affected:

Poisonous Parts: leaves

Primary Poisons: protoanemonin

[Scroll down for more images.](#)





This image is copyrighted. It may be used in teaching, printed, downloaded, or copied, provided it is in an educational setting and proper attribution is provided. Alteration of this image in any form is restricted.

Scientific Name: *Podophyllum peltatum*

Common Name: Mayapple and Mandrake



Species Most Often Affected: cattle, humans, swine

Poisonous Parts: all

Primary Poisons: alpha- and beta- peltatin, podophylloresin

[Scroll down for more images.](#)



This image is copyrighted. It may be used in teaching, printed, downloaded, or copied, provided it is in an educational setting and proper attribution is provided. Alteration of this image in any form is restricted.

Scientific Name: *Argemone mexicana*

Common Name: Prickly Poppy or Mexican Poppy



Species Most

Often Affected: goats

Poisonous Parts: all

Primary Poisons: sanguinarine

[Scroll down for more images.](#)





Questions pertaining to *Argemone mexicana*:

[What is the most poisonous substance in *Argemone mexicana*?](#)

This image is copyrighted. It may be used in teaching, printed, downloaded, or copied, provided it is in an educational setting and proper attribution is provided. Alteration of this image in any form is restricted.

Scientific Name: *Asclepias spp.*

Common Name: Milkweed



Species Most Often Affected: sheep, cattle, goats

Poisonous Parts: leaves, fruits, stems

Primary Poisons: desglucosyrioside, syriocide

[Scroll down for more images.](#)





Questions pertaining to *Asclepias spp.*:

[Are these plants, indigenous to S.D., poisonous to humans as well as livestock?](#)

This image is copyrighted. It may be used in teaching, printed, downloaded, or copied, provided it is in an educational setting and proper attribution is provided. Alteration of this image in any form is restricted.

Scientific Name: *Menispermum canadense*

Common Name: Moonseed



Species Most Often Affected: humans, goats
Poisonous Parts: all
Primary Poisons: dauricine

[Scroll down for more images.](#)



This image is copyrighted. It may be used in teaching, printed, downloaded, or copied, provided it is in an educational setting and proper attribution is provided. Alteration of this image in any form is restricted.

Scientific Name: *Quercus spp.*

Common Name: Oak Trees



Species Most Often Affected: horse, cattle

Poisonous Parts: acorns, young leaves

Primary Poisons: gallotannins, quercitrin, and quercetin

[Scroll down for more images.](#)





This image is copyrighted. It may be used in teaching, printed, downloaded, or copied, provided it is in an educational setting and proper attribution is provided. Alteration of this image in any form is restricted.

Scientific Name: *Nerium oleander*

Common Name: Oleander



Species Most Often Affected: horses, cattle, sheep, dogs, humans, goats

Poisonous Parts: all, leaves, stems

Primary Poisons: nerioside, oleandroside, saponins, cardiac glycosides

[Scroll down for more images.](#)



Questions pertaining to *Nerium oleander*:

[Which poisonous plants are in the Bay area of California?](#)

[Could you help me find some information on plants poisonous to dogs?](#)

[Could *Laurentia longiflora* be responsible for my fish dying?](#)

[Do you know of any plants that kill gophers?](#)

[Is my tree poisonous?](#)

[Could you give me a list of landscape plants that are toxic to horses?](#)

[Could you tell me if these landscaping plants are poisonous horses?](#)

[Do you have any information on *Laurentia longiflora*?](#)

[Could you give me more information on oleander?](#)

[Are Oleander plants harmful to horses?](#)

[What type of poison is present in oleander?](#)

[Can you give me some information about Oleander?](#)

[Is *Plumeria rubra* poisonous to cats?](#)

[Could you answer some questions for my book?](#)

[Is there any danger in cutting and burning *Nerium Oleander*?](#)

[Is this Oleander tree safe for my dog?](#)

This image is copyrighted. It may be used in teaching, printed, downloaded, or copied, provided it is in an educational setting and proper attribution is provided. Alteration of this image in any form is restricted.

Scientific Name: *Allium spp.*

Common Name: Commercial Onions, Wild Onions, Swamp Onions, and Chives



Species Most Often Affected: cattle, horses, children

Poisonous Parts: bulbs, leaves

Primary Poisons:SMCO

[Scroll down for more images.](#)





This image is copyrighted. It may be used in teaching, printed, downloaded, or copied, provided it is in an educational setting and proper attribution is provided. Alteration of this image in any form is restricted.

Scientific Name: *A. pantherina*

Common Name: Panther



Species Most

Often Affected: all

Poisonous Parts: cap?

Primary Poisons: ibotenic acid and muscimol

This image is copyrighted. It may be used in teaching, printed, downloaded, or copied, provided it is in an educational setting and proper attribution is provided. Alteration of this image in any form is restricted.

Scientific Name: *Amaranthus spp.*

Common Name: Pigweed



Species Most Often Affected: cattle, swine
Poisonous Parts: leaves
Primary Poisons: nitrate

[Scroll down for more images.](#)



This image is copyrighted. It may be used in teaching, printed, downloaded, or copied, provided it is in an educational setting and proper attribution is provided. Alteration of this image in any form is restricted.

Scientific Name: *Conium maculatum*

Common Name: Poison Hemlock



Species Most all

Often Affected:

Poisonous Parts: all

Primary Poisons: coniine

Link to web page(s): plants/conium.html

Scroll down for more images.





Questions pertaining to *Conium maculatum*:

[Do you have any information on Poison Parsnip?](#)

[Could you help me out with some information about Hemlock?](#)

This image is copyrighted. It may be used in teaching, printed, downloaded, or copied, provided it is in an educational setting and proper attribution is provided. Alteration of this image in any form is restricted.

Scientific Name: *Toxicodendron radicans*

Common Name: Poison ivy



Species Most Often Affected: humans
Poisonous Parts:
Primary Poisons:

Questions pertaining to *Toxicodendron radicans*:

[What could have caused my rash?](#)

[Can you tell one poison rash from the other?](#)

[What could have caused these blisters?](#)

[Have you ever heard of poison sumac being used as a filler in peat moss?](#)

[Do you know where I can find poison ivy extract?](#)

[Is poison ivy only poisonous to humans and primates?](#)

[Do you know of any oral medication to prevent Poison Ivy?](#)

[Does docweed cure poison ivy?](#)

[What would happen if you were exposed to a poisonous plant?](#)

This image is copyrighted. It may be used in teaching, printed, downloaded, or copied, provided it is in an educational setting and proper attribution is provided. Alteration of this image in any form is restricted.

Scientific Name: *Toxicodendron diversiloba*

Common Name: Poison oak



Species Most Often Affected: humans

Poisonous Parts:

Primary Poisons:

Link to web page(s): </plants/poioak.html>

[Scroll down for more images.](#)



Questions pertaining to *Toxicodendron diversiloba*:

[Can you tell one poison rash from the other?](#)

[What could have caused these blisters?](#)

[Do you know where I can find poison ivy extract?](#)

[How does one kill the poison oak plant?](#)

[What could cause this condition?](#)

[What would happen if you were exposed to a poisonous plant?](#)

This image is copyrighted. It may be used in teaching, printed, downloaded, or copied, provided it is in an educational setting and proper attribution is provided. Alteration of this image in any form is restricted.

Scientific Name: *Toxicodendron vernix*

Common Name: Poison Sumac



Species Most Often Affected: humans
Poisonous Parts:
Primary Poisons:

Questions pertaining to *Toxicodendron vernix*:

[Can you tell one poison rash from the other?](#)

[What could have caused these blisters?](#)

[Have you ever heard of poison sumac being used as a filler in peat moss?](#)

This image is copyrighted. It may be used in teaching, printed, downloaded, or copied, provided it is in an educational setting and proper attribution is provided. Alteration of this image in any form is restricted.

Scientific Name: *Euphorbia spp.*

Common Name: Poinsettia, Spurges, Snow on the Mountain



Species Most Often Affected: cattle, horses, humans, sheep
Poisonous Parts: leaves, stems and sap
Primary Poisons: phorbol esters

[Scroll down for more images.](#)





Questions pertaining to *Euphorbia* spp.:

[Is the Poinsettia poisonous?](#)

[Are poinsettias poisonous to dogs?](#)

This image is copyrighted. It may be used in teaching, printed, downloaded, or copied, provided it is in an educational setting and proper attribution is provided. Alteration of this image in any form is restricted.

Scientific Name: *Phytolacca americana*

Common Name: Pokeweed



Species Most Often Affected: cattle, sheep, humans, turkeys, swine, horses
Poisonous Parts: all
Primary Poisons: phytolaccatoxin, phytolaccigenin

Questions pertaining to *Phytolacca americana*:

[Are pokeberries poisonous when ingested by a child in small amount?](#)

[Could you give me some information on California Pokeweed?](#)

[Are Pokeweed berries poisonous?](#)

[Do you have any information about California Pokeweed?](#)

This image is copyrighted. It may be used in teaching, printed, downloaded, or copied, provided it is in an educational setting and proper attribution is provided. Alteration of this image in any form is restricted.

Scientific Name: *Pinus ponderosa*

Common Name: Ponderosa Pine



Species Most Often Affected: cattle

Poisonous Parts: needles, young shoots

Primary Poisons: unknown

[Scroll down for more images.](#)



Questions pertaining to *Pinus ponderosa*:

[Could pine needles poison my goat?](#)

[Are pine trees harmful to horses?](#)

This image is copyrighted. It may be used in teaching, printed, downloaded, or copied, provided it is in an educational setting and proper attribution is provided. Alteration of this image in any form is restricted.

Scientific Name: *Papaver spp.*

Common Name: Various Poppies including Opium Poppy



Species Most Often Affected: cattle, humans

Poisonous Parts: all

Primary Poisons: codeine, morphine, protopine

[Scroll down for more images.](#)



This image is copyrighted. It may be used in teaching, printed, downloaded, or copied, provided it is in an educational setting and proper attribution is provided. Alteration of this image in any form is restricted.

Scientific Name: *Rheum rhaponticum*

Common Name: Rhubarb



Species Most Often Affected: goats, humans, swine, horses

Poisonous Parts: leaves

Primary Poisons: anthraquinones, oxalate

[Scroll down for more images.](#)





Questions pertaining to *Rheum rhaponticum*:

[Could you give me some information about the toxicity of these plants?](#)

[Are these plants really poisonous?](#)

This image is copyrighted. It may be used in teaching, printed, downloaded, or copied, provided it is in an educational setting and proper attribution is provided. Alteration of this image in any form is restricted.

Scientific Name: *Abrus precatorius*

Common Name: Rosary Pea



Species Most Often Affected: all

Poisonous Parts: seeds

Primary Poisons: abrin

[Scroll down for more images.](#)



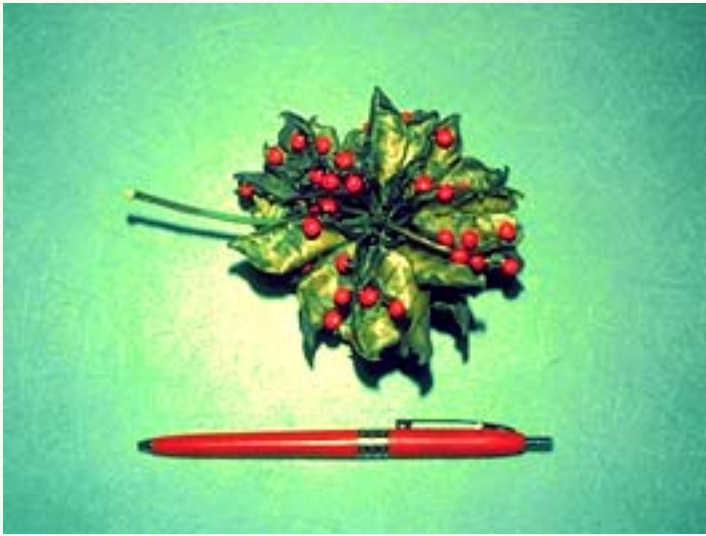

Questions pertaining to *Abrus precatorius*:

[What is the most poisonous plant in the world to humans?](#)

[What kind of a poisonous bean could you put in a soup?](#)

[I need some information about the Rosary Pea for a book...](#)

[What are the most poisonous plants on earth?](#)

This image is copyrighted. It may be used in teaching, printed, downloaded, or copied, provided it is in an educational setting and proper attribution is provided. Alteration of this image in any form is restricted.

Scientific Name: *Onoclea sensibilis*

Common Name: Sensitive Fern



Species Most Often Affected: horse

Poisonous Parts: leaves

Primary Poisons: unknown

[Scroll down for more images.](#)



This image is copyrighted. It may be used in teaching, printed, downloaded, or copied, provided it is in an educational setting and proper attribution is provided. Alteration of this image in any form is restricted.

Scientific Name: *Symplocarpus foetidus*

Common Name: Eastern Skunk Cabbage



Species Most Often Affected: human

Poisonous Parts: all

Primary Poisons: oxalate

This image is copyrighted. It may be used in teaching, printed, downloaded, or copied, provided it is in an educational setting and proper attribution is provided. Alteration of this image in any form is restricted.

Scientific Name: *Ornithogalum umbellatum*

Common Name: Star of Bethlehem



Species Most Often Affected: humans

Poisonous Parts: bulbs, flowers, all

Primary Poisons: convallatoxin, convallaside

[Scroll down for more images.](#)



Questions pertaining to *Ornithogalum umbellatum*:

[Could *Laurentia longiflora* be responsible for my fish dying?](#)

This image is copyrighted. It may be used in teaching, printed, downloaded, or copied, provided it is in an educational setting and proper attribution is provided. Alteration of this image in any form is restricted.

Scientific Name: *Urtica spp.*

Common Name: Stinging Nettle



Species Most Often Affected: dogs, humans

Poisonous Parts: hairs

Primary Poisons: acetylcholine, histamine, 5-hydroxytryptamine

Questions pertaining to *Urtica spp.*:

[What could have caused these blisters?](#)

[What would happen if you were exposed to a poisonous plant?](#)

This image is copyrighted. It may be used in teaching, printed, downloaded, or copied, provided it is in an educational setting and proper attribution is provided. Alteration of this image in any form is restricted.

Scientific Name: *Metilotus alba* and *Melilotus officinalis*

Common Name: White and Yellow Sweetclover



Species Most Often Affected: horses, cattle, sheep

Poisonous Parts: stem

Primary Poisons: dicoumarol

[Scroll down for more images.](#)



This image is copyrighted. It may be used in teaching, printed, downloaded, or copied, provided it is in an educational setting and proper attribution is provided. Alteration of this image in any form is restricted.

Scientific Name: *Lathyrus spp.*

Common Name: Sweet Pea, Tangier Pea, Everlasting Pea, Caley Pea and Singletary Pea



Species Most Often Affected: horses, rodents, turkeys, sheep, humans

Poisonous Parts: seeds

Primary Poisons: DABA, ODAP, amine, phenol, glycoside

Questions pertaining to *Lathyrus spp.*:

[Are any of these plants poisonous to horses?](#)

[Is the plant in my backyard poisonous?](#)

[What is the most poisonous plant in the world to humans?](#)

[What kind of a poisonous bean could you put in a soup?](#)

[Could you give me some information about Peace lilies?](#)

[Could you tell me if Peace Lily is poisonous?](#)

[Could you give me some information on the toxicity of the peace lily?](#)

[Is this peace plant toxic?](#)

[Could you answer a few questions about the Precatory pea?](#)

[I need some information about the Rosary Pea for a book...](#)

[What are the most poisonous plants on earth?](#)

[Does this situation seem reasonable?](#)

[Are these wildflowers toxic?](#)

[Why are alfalfa and Tall fescue on the list of poisonous plants?](#)

[Do poisonous plants look the same?](#)

This image is copyrighted. It may be used in teaching, printed, downloaded, or copied, provided it is in an educational setting and proper attribution is provided. Alteration of this image in any form is restricted.

Scientific Name: *Nicotiana spp.*

Common Name: Tobacco and Tree Tobacco



Species Most Often Affected: humans, swine

Poisonous Parts: leaves

Primary Poisons: nicotine, pyridine

Link to web page(s): plants/tobacco.html

Scroll down for more images.



This image is copyrighted. It may be used in teaching, printed, downloaded, or copied, provided it is in an educational setting and proper attribution is provided. Alteration of this image in any form is restricted.

Scientific Name: *Aleurites fordii*

Common Name: Tung Oil Tree



Species Most

Often Affected:

Poisonous Parts: all, seeds

Primary Poisons: pharbol ester

[Scroll down for more images.](#)



This image is copyrighted. It may be used in teaching, printed, downloaded, or copied, provided it is in an educational setting and proper attribution is provided. Alteration of this image in any form is restricted.

Scientific Name: *Vicia spp.*

Common Name: Common Vetch, Hairy Vetch, Narrow leaved Vetch, Purple Vetch and Broad Beans



Species Most Often Affected: chickens, horses, humans

Poisonous Parts: seeds

Primary Poisons: beta-cyano-L-alanine

Questions pertaining to *Vicia spp.*:

[Is Crown Vetch safe to feed to horses?](#)

[Can crown vetch be harmful to horses?](#)

This image is copyrighted. It may be used in teaching, printed, downloaded, or copied, provided it is in an educational setting and proper attribution is provided. Alteration of this image in any form is restricted.

Scientific Name: *Cicuta spp.*

Common Name: Water Hemlock or Cowbane

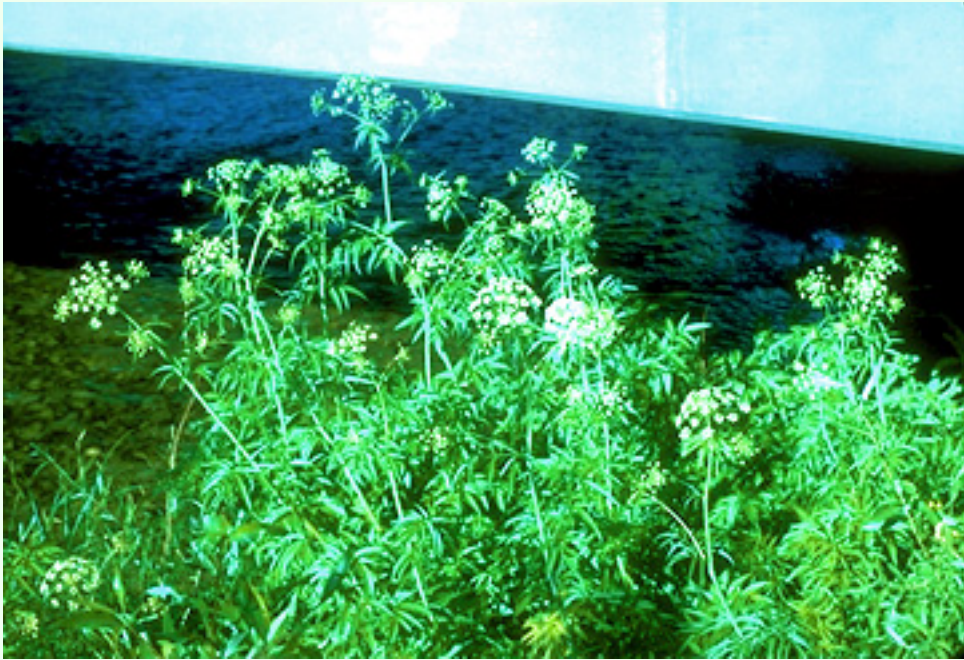

Species Most Often Affected: all

Poisonous Parts: roots, all

Primary Poisons: cicutoxin

[Scroll down for more images.](#)





This image is copyrighted. It may be used in teaching, printed, downloaded, or copied, provided it is in an educational setting and proper attribution is provided. Alteration of this image in any form is restricted.

Scientific Name: *Eupatorium rugosum*

Common Name: White Snakeroot



Species Most Often Affected: cattle, dogs, goats, horses, humans, rabbits, sheep

Poisonous Parts: all

Primary Poisons: tremetone

[Scroll down for more images.](#)



This image is copyrighted. It may be used in teaching, printed, downloaded, or copied, provided it is in an educational setting and proper attribution is provided. Alteration of this image in any form is restricted.

Scientific Name: *Wisteria spp.*

Common Name: Wisteria



Species Most Often Affected: humans

Poisonous Parts: all, flowers, seeds, leaves

Primary Poisons: wistarine

[Scroll down for more images.](#)





This image is copyrighted. It may be used in teaching, printed, downloaded, or copied, provided it is in an educational setting and proper attribution is provided. Alteration of this image in any form is restricted.

Scientific Name: *Centaurea solstitialis*

Common Name: Yellow Star Thistle



Species Most Often Affected: horse

Poisonous Parts:

Primary Poisons:

[Scroll down for more images.](#)



Questions pertaining to *Centaurea solstitialis*:

[Could you give me a list of landscape plants that are toxic to horses?](#)

[Is there any way to prevent your horse from eating poisonous plants?](#)

[Do you know of a list that compares the plant toxicity in horses and ruminants?](#)

[Compare and contrast plants toxic to horses and ruminants.](#)

This image is copyrighted. It may be used in teaching, printed, downloaded, or copied, provided it is in an educational setting and proper attribution is provided. Alteration of this image in any form is restricted.

Scientific Name: *Taxus cuspidata*

Common Name: Yew



Species Most Often Affected: all

Poisonous Parts: leaves, seeds, twigs

Primary Poisons: taxine

Link to web page(s): </plants/yew.html>

Scroll down for more images.





Questions pertaining to *Taxus cuspidata*:

[Could you tell me if these landscaping plants are poisonous horses?](#)

[Are pine trees harmful to horses?](#)

[Is there any way to prevent your horse from eating poisonous plants?](#)

This image is copyrighted. It may be used in teaching, printed, downloaded, or copied, provided it is in an educational setting and proper attribution is provided. Alteration of this image in any form is restricted.

ALKALOIDS

Alkaloids are compounds containing nitrogen in a heterocyclic ring that are common to about 15 to 20% of all vascular plants. They are synthesized by plants from amino acids.

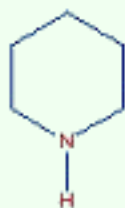

Piperidine Nucleus

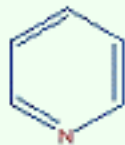

Pyridine Nucleus

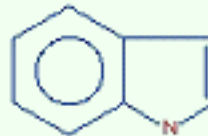

Indole Nucleus

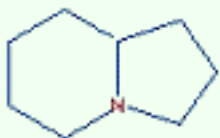

Indolizidine Nucleus

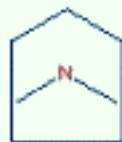

Tropane Nucleus

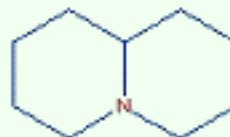

Quinolizidine Nucleus

Nuclei of several different types of alkaloids

The amino acids are decarboxylated to amines and then react with amine oxides to form aldehydes. Mannich-type condensation of the aldehyde and amine groups creates their characteristic heterocyclic ring.

Alkaloids are subclassified on the basis of the chemical type of their nitrogen containing ring. Alkaloids are formed as metabolic by-products. However, their characteristic bitter taste and accompanying toxicity generally help to repel insects and herbivores.

Complicated ecological interrelationships have developed between several insects and alkaloids. For example, the consumption of specific pyrrolizidine alkaloids is necessary for some danoid butterflies to synthesize their pheromones.

INDOLE ALKALOIDS

Indole alkaloids are derived from the amino acid tryptophan as can easily be discerned by comparing their nitrogen containing nucleus to the chemical structure of tryptophan.

Comparison of

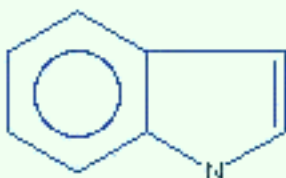

Nucleus of an Indole Alkaloid

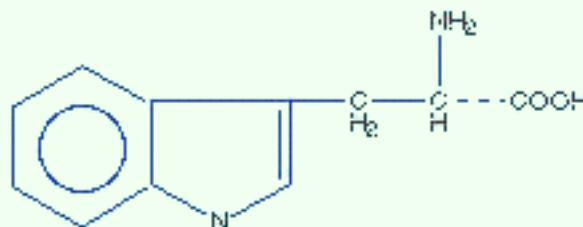

Tryptophan

Important classes of indole alkaloids include:

- the ergot alkaloids (ergotamine, ergocristine, etc.),
- [the fescue alkaloids](#) (ergovaline, ergosine, ergonine, lysergic acid amide),
- 3-methylindole (produced by rumen fermentation of tryptophan), and
- [the beta-carbolines](#).

This series of web pages was created by an undergraduate student at Cornell University for the AS625 class. All comments and suggestions are welcome.

WARNING: These web pages are only meant to be informative. Neither Cornell University nor the author of this site endorse or recommend the use of these plants.

Return to: [\[Poisonous Plants Homepage\]](#) [\[List of Toxicants\]](#)

Home page: [Animal Science at Cornell University](#)

For problems or comments on this web page, contact the Animal Science [Webmaster](#)



MIND BENDING BETA-CARBOLINES



This is intended to provide information on a class of indole alkaloids called [beta-carbolines](#) which are compounds that comprise the tricyclic pyrido (3,4) indol ring system with alkyl C1 constituents.

This group of indole alkaloids are of widespread distribution being found in [23 angiosperm plant families](#), 3 fungi genera, and in a variety of animal tissues[\[1\]](#). In addition, [beta-carbolines](#) can be found in tobacco smoke [\[2\]](#), marijuana smoke [\[3\]](#), and in charred food stuffs [\[4\]](#).

The [beta-carbolines](#) do not represent a significant poisoning hazard to livestock due to their very low concentrations. None-the-less, these toxicants are interesting from a chemical perspective in terms of structure-activity relationships. Some of their more interesting aspects are as follows:

- [ETHNOBOTANY: AYAHUASCA](#)
- [NEUROPHARMACOLOGY: BETA-CARBOLINES, SEROTONIN AND BRAIN CHEMISTRY](#)
- [BETA-CARBOLINE CONTAINING PLANTS](#)
- [REFERENCES](#)



This series of web pages was created by an undergraduate student at Cornell University for the AS625 class. All comments and suggestions are welcome.

WARNING: These web pages are only meant to be informative. Neither Cornell University nor the author of this site endorse or recommend the use of these plants.

Return to: [Poisonous Plants Homepage](#)
Home page: [Animal Science at Cornell University](#)

For problems or comments on this web page, contact the Animal Science [Webmaster](#)

PIPERIDINE ALKALOIDS

Index

- [Introduction](#)
 - [Poison Hemlock](#)
 - [Distribution](#)
 - [Description](#)
 - [How to distinguish from other plants](#)
 - [Symptoms of poisoning](#)
 - [Swine](#)
 - [Cattle](#)
 - [Horses](#)
 - [Sheep](#)
 - [Prevention of poisoning](#)
 - [References](#)
-

Introduction

Piperidine alkaloids are identified by their saturated heterocyclic ring, i.e., [piperidine nucleus](#). The best known piperidine alkaloid poisons are those of poison hemlock, *Conium maculatum*. Socrates is reputed to have been killed with a poison hemlock extract. There are at least [5 naturally occurring conium alkaloids](#).

Symptoms of Poisoning

Conium alkaloids

acutely affect the nervous system. Livestock progress from:

- nervousness -->
- trembling -->
- incoordination -->
- dilated pupils -->
- weak heartbeat -->

- cold extremities -->
 - coma -->
 - to death by respiratory failure.
 - **Conium Alkaloids are teratogenic agents.**
-

Livestock most affected

- [Swine](#) (1g of *C. maculatum* seed/kg lw given orally) - Lethal
- [Cattle](#) (3.3 mg coniine/kg lw given orally) - Severe toxic signs
- [Horses](#) (15.5 mg coniine/kg lw given orally) - Severe toxic signs
- [Sheep](#) (44 mg coniine/kg lw given orally) - Moderate toxic signs

Swine

Fresh plant is enthusiastically consumed by pigs in feed trials. Third eyelid expands over entire eye about 15 minutes after poisoning causing temporary blindness. Weakness, trembling, and lethargy are observed. Both seeds and foliage are teratogenic in swine causing cleft palates in piglets exposed at 30 to 45 days gestation, and arthrorypsis, scoliosis, hydrocephalus, and severe contraction of fetlock joints in piglets exposed at 43 to 61 days gestation.

Cattle

Cattle are about ten times more vulnerable than sheep apparently because of differences in liver metabolism. An injectable dose of 16 mg coniine/kg live weight is lethal in cows. Field trials have induced crooked calf disease in the offspring of cows fed poison hemlock or dosed with conium alkaloids, implicating poison hemlock as a likely cause of deformed calves on ranges with no lupine herbage present.

Horses

Although horses are readily poisoned by poison hemlock, field trials thus far have not been able to induce teratogenic responses in pregnant mares poisoned with conium alkaloids, indicating that the horse fetus may be resistant to these toxins.

Sheep

Signs of poisoning in sheep are restlessness, followed by tremors and ataxia. The lethal dose for sheep is @ 240 mg coniine/kg live weight. Their resistance to poisoning when compared to cattle is attributed to species differences in liver metabolism. Research

indicates that poison hemlock is not teratogenic in sheep.

Prevention of livestock poisoning

Swine paddocks should be monitored for poison hemlock because swine will readily eat it. Poison hemlock is not highly palatable to cattle, horses, and sheep and rarely will they eat a toxic amount of it if more palatable vegetation is available on the range. Because conium alkaloids are teratogenic to cattle, care should be taken that cows in the first 3 mo of pregnancy not be grazed on sparse pastures with an appreciable population of poison hemlock. The seeds contain the highest concentration of toxicants. Therefore, feed grain can potentially be contaminated with poison hemlock. Although, herbicides and routine cultivation severely reduce the amount of poison hemlock in grain fields, seed contamination is still a potential danger in unsprayed or newly established grain fields.

[\[Index\]](#) [\[Introduction\]](#) [\[Poison Hemlock\]](#)[\[Distribution\]](#) [\[Description\]](#)[\[How to distinguish from other plants\]](#) [\[Symptoms of poisoning\]](#) [\[Swine\]](#) [\[Cattle\]](#)[\[Horses\]](#)[\[Sheep\]](#)[\[Prevention of poisoning\]](#) [\[References\]](#) [\[return to list of toxicants\]](#)

This series of web pages was created by an undergraduate student at Cornell University for the AS625 class. All comments and suggestions are welcome.

WARNING: These web pages are only meant to be informative. Neither Cornell University nor the author of this site endorse or recommend the use of these plants.

Return to: [\[List of Toxic Agents\]](#) [\[Poisonous Plants Homepage\]](#)

Home page: [Animal Science at Cornell University](#)

For problems or comments on this web page, contact the Animal Science [Webmaster](#)

POLYCYCLIC DITERPENE ALKALOIDS

Index

- [Introduction](#)
- [Larkspurs \(*Delphinium* spp.\)](#)
 - [Description](#)
 - [Distribution](#)
 - [Where poisons are found in the plants](#)
- [Monkshood \(*Aconium* spp.\)](#)
 - [Description and distribution](#)
 - [Where poisons are found in the plants](#)
- [Symptoms of poisoning](#)
- [Prevention of poisoning](#)

[\[Return to list of toxicants\]](#)

Introduction

Polycyclic diterpene alkaloids have a complicated diterpene [nucleus](#). They are found in plants in the *Delphinium* spp. (Larkspurs) and in the *Aconitium* spp. (monkshood). Larkspurs kill more cattle in the United States yearly than all other poisonous plants combined.

Larkspurs (*Delphinium* spp.)

Description and distribution

Larkspurs are the primary source of plant poisoning of cattle on the western ranges of the United States. Larkspurs are grouped by their height. Low larkspurs, for example, *D.andersonii* and (em) *D. menziesii* , have a growing habit of <3 ft and are generally found at lower elevations. They are one of the first plants to emerge in the spring, even when there is still snow cover, and hence, appear inviting to cattle hungry for green vegetation. Early spring is when poisonings due to low larkspurs are most likely to occur. Tall larkspurs ((em)*D. barbeyi*, *D. occidentale*, *D. glaucum*, *D. Trollifolium*, etc.) are 3 to 6 ft tall and grow at high elevations in deep soils with plentiful moisture. They can be found

in alpine meadows or under dense tree cover in aspen and pine forests and are very palatable to cattle. Calves tend to congregate under tree cover while the mature herd is out grazing. Because of their small size, calves are particularly susceptible to poisoning from the larkspur patches found in the woods.

Where poisons are found in plant

Larkspurs alkaloids are concentrated in the growing tips and new leaf growth of the plant. Therefore, larkspurs tend to be most poisonous in early spring, gradually drop in toxicity throughout the growing season, and severely decrease in toxicity following flowering. (Become essentially benign?)

Symptoms of poisoning

The alkaloids in Larkspurs, for example, methyllycaconitine, appear to act as powerful neuromuscular blocking agents. Symptoms of poisoning are rarely observed out on the range because animals progress to death so rapidly. The first sign of trouble may be a bloated corpse. In field trials, symptoms include restlessness, nausea, abdominal pain, muscle weakness and involuntary twitching, stiff gait, straddled stance with hind legs braced apart --> collapse --> death by respiratory paralysis. Cattle are about 4 times as susceptible to Larkspur poisoning as sheep and are killed by as little as 17g of green foliage per kg liveweight.

Prevention of poisoning

Sheep and goats have been used to try to cut down on the larkspur population of rangelands. Sheep have not been that successful because they tend to graze larkspur later in the spring than cattle and generally do not feed on the growing points. Death due to larkspur poisoning has been reported in sheep. Goats have been used to more success (? , check). Spot spraying larkspur with herbicides and then reseeding to grasses also helps reduce larkspur populations.

[\[Index\]](#)[\[Introduction\]](#) [\[Larkspurs \(*Delphinium* spp.\)\]](#) [\[Monkshood \(*Aconitium* spp.\)\]](#)
[\[Symptoms of poisoning\]](#)[\[Prevention of poisoning\]](#)

This series of web pages was created by an undergraduate student at Cornell University for the AS625 class. All comments and suggestions are welcome.

WARNING: These web pages are only meant to be informative. Neither Cornell University nor the author of this site endorse or recommend the use of these plants.

Return to: [Poisonous Plants Homepage](#)

Home page: [Animal Science at Cornell University](#)

For problems or comments on this web page, contact the Animal Science [Webmaster](#)

PYRIDINE ALKALOIDS

Index

- [Introduction](#)
 - [Tobacco Family \(*Nicotianasp.*\)](#)
 - [Distribution](#)
 - [Description](#)
 - [Symptoms of poisoning](#)
-

Introduction

Pyridine alkaloids are similar to piperidine alkaloids except that their heterocyclic ringed, nitrogen containing nucleus is unsaturated. Two toxic alkaloids will be discussed here. The pyridine alkaloid, [nicotine](#), and the piperidine-pyridine alkaloid, [anabasine](#). Both of these are found in plants in the *Nicotiana* spp. which includes cultivated, wild, and tree tobacco.

Symptoms of Poisoning

Nicotine

- acutely affects the nervous system by blocking autonomic ganglia and neuromuscular junctions. Livestock progress from:

- excitement -->
- shaking and twitching -->
- rapid breathing -->
- staggering -->
- weakness and prostration -->
- coma -->
- descending paralysis of the central nervous system -->
- to death by respiratory failure.

Anabasine

- Research indicates that anabasine is a teratogenic agent but nicotine is not.

Poisoning due to consumption of tobacco leaves and stalks has been documented in cattle, horses, sheep, and swine as well as dogs and even humans (after consuming the leaves as boiled greens). Nicotine was a popular old time wormer and insecticide that occasionally poisoned livestock as well as its intended target. Swine will readily eat the soft pith of tobacco stalks and extreme care must be taken to keep them from gleaming tobacco fields or discarded stalks. Deformed offspring due to ingestion of the anabasine alkaloid in tobacco have been documented in cattle, sheep, and swine. These deformities are clinically the same as those caused by maternal consumption of lupine or poison hemlock (carpal flexure, cleft palates, arthrogryposis of the forelimbs and curvature of the spine). Wild and cultivated tobaccos contain some anabasine. However, @ 99% of the total alkaloid content of tree tobacco is anabasine.

[\[Index\]](#) [\[Introduction\]](#) [\[Tobacco\]](#) [\[Distribution and description\]](#)[\[Symptoms of poisoning\]](#)

This series of web pages was created by an undergraduate student at Cornell University for the AS625 class. All comments and suggestions are welcome.

WARNING: These web pages are only meant to be informative. Neither Cornell University nor the author of this site endorse or recommend the use of these plants.

Return to: [Poisonous Plants Homepage](#)

Home page: [Animal Science at Cornell University](#)

For problems or comments on this web page, contact the Animal Science [Webmaster](#)

Pyrrolizidine Alkaloids

Most alkaloids are amino acid derivatives, and have no certain role in plant metabolism except for serving to repel insects and herbivore predators due to their bitter taste. Pyrrolizidine alkaloids are very common in plants used in livestock feeds and in rangeland weeds such as tansy ragwort, *Senecio jacobea*, and *Heliotropium spp.* and *Crotolaria spp.* Pyrrolizidine alkaloids contain nitrogen in a heterocyclic ring forming a definite structure called the pyrrolizidine nucleus. It appears that the pyrrolizidine alkaloids themselves are not toxic, rather, some of their metabolites, primarily their "pyrrolic" derivatives are highly toxic. Toxic alcohols can also be produced as secondary metabolites. The common PAs, Heliotrine and lasiocarpine, are partially reduced to the non-toxic 1-methylene and 7-hydroxy-1 methyl derivatives in the rumen. However, these can be activated by oxidases in the animal's liver to pyrrolic derivatives and thus have pathological effects in the heart, liver, kidney and respiratory system. The basis for alkaloid regulation and its effects in the ruminal ecosystem are not yet fully understood, but is a well-known fact that its degradation is directly proportional to its concentration in the rumen. Heliotrine degrading bacteria have been isolated and identified in the rumen. Although these bacteria appear to get very little useful energy from the cleavage of heliotrine, this characteristic may well improve their ability to successfully compete in the rumen of an animal exposed to this type of alkaloid.

This series of web pages was created by Manuel Hernandez, an undergraduate student at Cornell University for the AS625 class. All comments and suggestions are welcome.

WARNING: These web pages are only meant to be informative. Neither Cornell University nor the author of this site endorse or recommend the use of these plants.

Return to: [Poisonous Plants Homepage](#)

Home page: [Animal Science at Cornell University](#)

For problems or comments on this web page, contact the Animal Science [Webmaster](#)

STEROID ALKALOIDS

Steroid alkaloids have a fairly complex nitrogen containing nucleus. Two important classes of steroid alkaloids are

- **the *Solanum* type** - one example is [solanidine](#). This steroid alkaloid is the nucleus (i.e. aglycone) for two important glycoalkaloids, [solanine and chaconine](#), found in potatoes. Other plants in the *Solanum* family including various nightshades, Jerusalem cherries, and tomatoes also contain solanum-type glycoalkaloids. Glycoalkaloids are glycosides of alkaloids.
- **the *Veratrum* type**. There are more than 50 *Veratrum* alkaloids including [veratramine](#), [cyclopamine](#), [cycloposine](#), [jervine](#), and [muldamine](#) occurring in plants of the *Veratrum* spp. The *Zigadenus* spp., death camas, also produces several veratrum-type of steroid alkaloids including [zygacine](#).

Solanum-type Alkaloids

- [Introduction](#)
- [Where poisons are found](#)
- [Symptoms of poisoning](#)

Introduction

Solanum-type alkaloids are found in plants in the form of glycosides of alkaloids. Glycosides are ethers that join a noncarbohydrate moiety, the aglycone, by an ester bond to a carbohydrate moiety. In solanum-type glycoalkaloids, the aglycone is a steroid alkaloid. Solanine and chaconine cause poisoning in potatoes. They have the same aglycone, solanidine, but the structure of their carbohydrate sidechains is different. Tomatine is a glycoalkaloid found in tomatoes. Its aglycone is tomatidine.

Where poisons are found

Production of solanum-type glycoalkaloids is favored by the same conditions that promote the development of chlorophyll. Therefore, the concentration of these glycoalkaloids is highest in potato sprouts and green potato skins, and tomato vines and green tomatoes. Care should be taken to prevent the exposure of potatoes to sunlight. These alkaloids are not destroyed by cooking or drying at high temperatures. New potato varieties can not be introduced unless they contain less than 20 mg glycoalkaloids/100 g.

The glycoalkaloids are more poisonous than the steroid alkaloid aglycones. Humans and all classes of livestock are susceptible to poisoning by solanum-type glycoalkaloids. Luckily,

- glycoalkaloids are poorly absorbed by the gastrointestinal tract of mammals,
- an appreciable amount of solanum-type glycoalkaloids is hydrolyzed in the gut of

mammals to the less toxic aglycones,

- these metabolites are rapidly excreted in the urine and feces of mammals. Because exposure to these poisons is generally by ingestion, it takes a relatively large amount of them to cause death.

Symptoms of poisoning

In potatoes, solanum-type glycoalkaloids cause:

- a bitter taste above 14mg/100g, and
- a burning sensation to mouth and throat above 20mg/100g.

Solanum-type glycoalkaloids are:

- gastrointestinal tract irritants -->
 - inflamed intestinal mucosa, ulceration, hemorrhage, stomach pains, constipation or diarrhea
- cholinesterase inhibitors and thus affect the nervous system-->
 - apathy, drowsiness, salivation, labored breathing, trembling -->
 - ataxia, muscle weakness, convulsions, involuntary urination -->
 - paralysis, loss of consciousness, coma, death due to respiratory paralysis

WARNING: These web pages are only meant to be informative. Neither Cornell University nor the author of this site endorse or recommend the use of these plants.

Return to: [\[List of toxic agents\]](#) [\[Poisonous Plants Homepage\]](#)

Home page: [Animal Science at Cornell University](#)

For problems or comments on this web page, contact the Animal Science [Webmaster](#)

Nitrate

Forage plants and water are common sources of high levels of nitrates. Some of the causes of abnormal accumulation of nitrates in plants are: nitrogen fertilization, drought conditions and some herbicidal treatments. Nitrate accumulation also largely depends on the type of plant. Some of the most common grasses that accumulate nitrate are sudan grass, oats, rape, wheat, barley, and corn. Although in the rumen nitrate is readily reduced to nitrite and then to ammonia, the consumption of plant materials with high levels of nitrate will lead to an acute intoxication. This process is closely related to increased concentrations of nitrite in the rumen which leads to the production of methaemoglobin, a substance that interferes with the ability of blood cells to carry oxygen when concentrations reach 30-40% of total hemoglobin concentrations. Some of the clinical signs of nitrate intoxication are abdominal pain, labored breathing, and cyanotic mucous membranes. Increased dietary nitrate, however, induces a change in the bacterial population that leads to an increased tolerance to high nitrate concentrations in the diet. Nitrate reduction in the rumen competes with other essential metabolic reactions such as methanogenesis, end-product formation, and microbial protein synthesis, and its toxicity reduces growth, causes Vitamin A deficiency, abortion, infertility, and goiter.

This series of web pages was created by an undergraduate student at Cornell University for the AS625 class. All comments and suggestions are welcome.

WARNING: These web pages are only meant to be informative. Neither Cornell University nor the author of this site endorse or recommend the use of these plants.

Return to: [Poisonous Plants Homepage](#)

Home page: [Animal Science at Cornell University](#)

For problems or comments on this web page, contact the Animal Science [Webmaster](#)

Oxalate Degradation

Only a few plants contain sufficient amounts of sodium and potassium oxalate to be considered toxic. Moreover, ruminants that consume these plants develop increasing amounts of tolerance to oxalate. An oxalate degrading anaerobe microorganism has been isolated from pure culture of rumen bacteria. This organism, *Oxalobacter formigenes*, uses oxalate as a sole energy source and produces carbon dioxide and formate as end products. This ability is extremely rare among anaerobic bacteria and therefore this organism occupies an unique niche in the rumen's microflora. The ability of the ruminant to adapt and tolerate high oxalate diets directly depends on the selection of oxalate-degrading microorganisms.

This series of web pages was created by an undergraduate student at Cornell University for the AS625 class. All comments and suggestions are welcome.

WARNING: These web pages are only meant to be informative. Neither Cornell University nor the author of this site endorse or recommend the use of these plants.

Return to: [Poisonous Plants Homepage](#)

Home page: [Animal Science at Cornell University](#)

For problems or comments on this web page, contact the Animal Science [Webmaster](#)

GLYCOSIDES

Glycosides are ethers that consist of a carbohydrate moiety joined by an ester bond to a noncarbohydrate moiety (referred to as the aglycone). The structure and/or properties of their aglycone is used to group and identify them. For example, isoflavones are glycosides with a flavone aglycone, and cardiac glycosides are steroid glycosides that act as powerful stimulators of the heart.

CALCINOGENIC GLYCOSIDES

INDEX

- [Introduction](#)
 - [How poisoning occurs](#)
 - [Symptoms of poisoning](#)
 - [References](#)
-

INTRODUCTION

Certain plants contain glycosides of the active metabolite of vitamin D. The metabolite is called [1,25-dihydroxycholecalciferol](#) or more simply 1,25-OHD3. Consumption of glycosides of 1,25-OHD3 by grazing animals leads to a vitamin D toxicity which causes the deposition of excessive calcium in the soft tissues (calcinosis). Of the three rangeland plants, *Cestrum diurnum*, *Solanum malacoxylon*, and *Trisetum flavescens*, known to contain these glycosides only *Cestrum diurnum* is found in the U.S. primarily in Florida.

HOW POISONING OCCURS

Vitamin D functions to regulate calcium and phosphorus absorption. Its metabolite, 1,25-OHD3, controls the synthesis and functions of calcium-binding proteins in the intestinal mucosa transporting calcium after digestion from the intestines to the blood stream. Animals synthesize their own 1,25-OHD3 through a feedback system in which low (high) serum calcium levels trigger increased (decreased) parathyroid hormone secretion which in turn triggers the production of more (less) 1,25-OHD3 leading to increased (decreased) absorption of calcium into the blood. This feedback system is disrupted by the consumption of external sources of 1,25-OHD3 which are not sensitive to already existing serum calcium levels. This excess 1,25-OHD3 causes elevated serum calcium levels leading to a condition known as calcinosis in which the extra calcium is deposited on the animal's soft tissues.

SYMPTOMS OF POISONING

A kilogram of dried *Cestrum diurnum* leaves yields approximately 3×10^3 IU D3. If *Cestrum diurnum* makes up 15 to 30% of the animal's diet, this may be sufficient to cause calcinosis. Symptoms in animals grazing toxic levels of *Cestrum diurnum* are

- progressive weight loss,

- lameness and stiffness,
- arched backs,
- hypercalcemia,
- hyperphosphatemia, and
- calcification of the tendons, ligaments, lungs, diaphragm, kidney, and cardiovascular system.

[\[Index\]](#) [\[Introduction\]](#)[\[Cestrum diurnum\]](#)[\[How poisoning occurs\]](#)[\[Symptoms of poisoning\]](#)[\[References\]](#)[\[Return to list of toxicants\]](#)

This series of web pages was created by an undergraduate student at Cornell University for the AS625 class. All comments and suggestions are welcome.

WARNING: These web pages are only meant to be informative. Neither Cornell University nor the author of this site endorse or recommend the use of these plants.

Return to: [Poisonous Plants Homepage](#)

Home page: [Animal Science at Cornell University](#)

For problems or comments on this web page, contact the Animal Science [Webmaster](#)

CARBOXYATRACTYLOSIDE

INDEX

- [Introduction](#)
 - [Cocklebur \(*Xanthium* spp.\)](#)
 - [How poisoning occurs](#)
 - [Symptoms of poisoning](#)
 - [References](#)
-

INTRODUCTION

Cockleburs are a herbaceous annual found in the U.S. along the shores of streams and ponds and in low-lying areas of farm fields. In its seedling stage it contains a hyperglycemic glycoside named carboxyatractyloside that can be deadly to livestock.

Cocklebur (*Xanthium* spp.)

Cockleburs tend to grow in areas that are waterlogged much of the year, but dry during the summer. They have a fruit capsule containing two seeds. Only one seed germinates the first year. Germination is delayed in the second seed until the following year. Cocklebur seedlings are high in carboxyatractyloside until the emergence of their first true leaves after which toxicity is lost. Carboxyatractyloside is a plant growth inhibitor. It has been hypothesized that carboxyatractyloside functions in a germinating cocklebur seed to keep the other seed in the fruit capsule dormant the same year.

HOW POISONING OCCURS

[Carboxyatractyloside](#) causes hypoglycemia in animals that consume it probably because it causes uncoupling of oxidative phosphorylation. Experimentally, phenylbutazone (BUTE) has been shown to reduce its toxicity by inducing synthesis of a non-cytochrome P450-dependent detoxification enzyme.

SYMPTOMS OF POISONING

Rooting pigs are very susceptible to poisoning from cocklebur seedlings. Symptoms include

- depression, unwillingness to move, hunched backs-->
- nausea, vomiting-->
- weakness, prostration, dyspnea, opisthotonus-->
- the animal collapses and makes paddling motions-->
- convulsions-->coma-->death.

Prior to death, animal becomes severely hypoglycemic with blood glucose levels dropping to 16mg/100ml. Increased vascular permeability leads to gross lesions of the gall bladder and peritoneal cavity and to liver necrosis.

REFERENCES

[\[Index\]](#) [\[Introduction\]](#)[\[Cocklebur\]](#)[\[How poisoning occurs\]](#)[\[Symptoms of poisoning\]](#)[\[References\]](#)[\[Return to list of toxicants\]](#)

This series of web pages was created by an undergraduate student at Cornell University for the AS625 class. All comments and suggestions are welcome.

WARNING: These web pages are only meant to be informative. Neither Cornell University nor the author of this site endorse or recommend the use of these plants.

Return to: [Poisonous Plants Homepage](#)

Home page: [Animal Science at Cornell University](#)

For problems or comments on this web page, contact the Animal Science [Webmaster](#)

Cardiac Glycosides

- Cardiac glycosides are divided into two main types:
 - * **Bufadienolides** are C24 steroids,

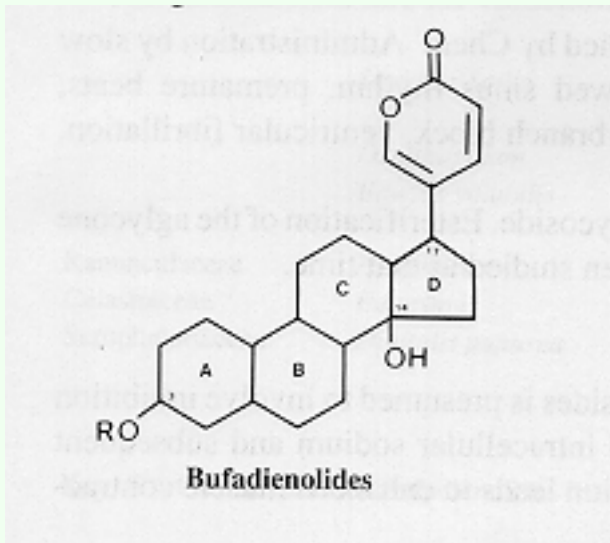

- The primary cardiac glycoside present in [Helleborus](#) is the bufadienole, hellebrin.
- Hellebrigenin, the aglycone of hellebrin is more potent than the glycoside itself.

* **Cardenolides** (most prevalent) are C23 steroids.

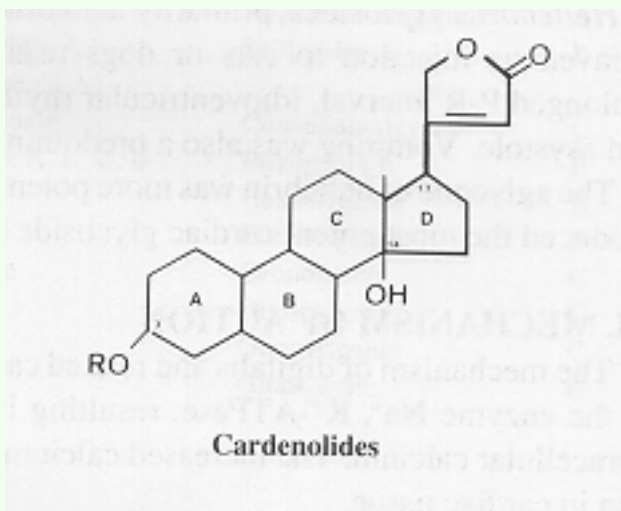

- Cardenolides have a hormonal nature as substances. Their effects are on the heart and kidney.
- Strong, bitter and disagreeable taste.
- Cardiotoxic = affect contractions of the heart muscle.
- Break down in fermentation by enzymatic action.
- Treatment: atropine and activated charcoal, lidocaine for *H. viridis*

- Assumed mechanism of action: inhibition of the Na⁺, K⁺-ATPase resulting in increased intracellular sodium and subsequent intracellular calcium leading to enhanced muscle contraction in cardiac tissue.

Cardenolides are classified according to the chemical composition of their aglycones as **lanataglycosides A, B, C, D and E**. Only [Digitalis lanata](#), the woolly foxglove contains all five forms. The entire foxglove plant is toxic. Symptoms of poisoning include dizziness, vomiting, irregular heart beat, and delirium or hallucinations.

Digitonin is probably the best known derivative of the Digitalis cardenolides. It is a drug derived from *D. purpurea*. It is used in modern medicine to increase the force of the systolic contractions and prolong duration of the diastolic phase in congestive heart failure. Digitalis drugs lower venous pressure in hypersensitive heart ailments, elevate blood pressure in a weak heart act as a diuretic, and reduce edema. However, the therapeutic dose is dangerously close to the lethal dose.

- Some plants containing cardiac glycosides:

[Christmas rose *Helleborus niger*](#), [foxglove *Digitalis purpurea*](#), lily of the valley (*Convallaria majalis*) and white water lily (*Nymphaea alba*).

This series of web pages was created by an undergraduate student at Cornell University for the AS625 class. All comments and suggestions are welcome.

WARNING: These web pages are only meant to be informative. Neither Cornell University nor the author of this site endorse or recommend the use of these plants.

Return to: [Poisonous Plants Homepage](#)

Home page: [Animal Science at Cornell University](#)

For problems or comments on this web page, contact the Animal Science [Webmaster](#)

COUMARIN GLYCOSIDES

Index

- [Introduction](#)
- [Dicoumarol](#)
 - [How poisoning occurs](#)
 - [Plants involved](#)
 - [Symptoms of poisoning](#)
- [Furocoumarins](#)
 - [How poisoning occurs](#)
 - [Plants involved](#)
 - [Symptoms of poisoning](#)

[\[Return to list of toxicants\]](#)

Introduction

This section will discuss toxicants that are derived from coumarin compounds in plants. For example, the glucoside melilotoside found in sweet clover (*Melilotus alba* and *M.officinalis*) is an ether of glucose bonded with an ester bond to coumarin. It yields the toxicant dicoumarol when exposed to specific molds. Furocoumarins are toxic compounds that consist of a coumarin nucleus bonded to a furan ring. Several plants contain the psoralens that are generally the precursors of furocoumarins.

[\[return to list of toxicants\]](#)

DICOUMAROL

Dicoumarol - HOW POISONING OCCURS

Plant enzymes in sweet clover [partition the aglycone coumarin from melilotoside](#). When sweet clover is put up as hay it is easy for it to be contaminated with molds because of its succulent stems. This is particularly likely when conditions are wet at cutting or curing or when foliage is lush. Molds such as *Penicillium nigricans* , *P.jensi* , and the *Aspergillus* metabolize the coumarin into dicoumarol. Dicoumarol

is similar in [structure](#) to vitamin K. When consumed by livestock it inhibits vitamin K production. Vitamin K is necessary in the body to activate prothrombin. When tissue is damaged, thromboplastin is released and converts prothronin to thrombin. Thrombin alters the solubility of fibrinogen in blood and causes it to clot and seal the tissue damage. Dicoumarol prevents [this process](#). [Warfarin](#) is a synthetic toxicant derived from coumarol. It is used in rat, gopher, and ground squirrel poisons and also acts as a vitamin K inhibitor to block the blood clotting process and provoke hemorrhaging. It is toxic to livestock that may accidentally consume it in its pelleted form and to dogs that consume poisoned squirrels, etc.

Dicoumarin - PLANTS INVOLVED

Sweet clover (*Melilotus alba* and *M. officinalis* is grown as a green manure and hay crop in the northern U.S. and in Canada. Its coumarin content gives it a distinctive sweet odor similar to vanilla. Its use as hay was widespread in the 1920s. A series of wet summers led to an epidemic of "bleeding disease" in cattle. Use of the forage is less common now and low- melilotoside varieties are available. Sweet vernal grass (*Anthoxanthum odoratum* is a coumarin-containing forage in England that also causes "bleeding disease". Hay with >10 ppm dicoumarol should be viewed with caution.

SYMPTOMS OF POISONING

Bleeding disease "only in cattle?"

- mild cases - extended blood-clotting time that can lead to hemorrhaging when livestock are castrated or dehorned.
 - severe cases - internal and/or external hemorrhaging cause pale mucous membranes, subcutaneous swellings of pooled blood, weakness, and death.
 - treatment - injections of vitamin K, whole blood transfusion.
-

[\[Index\]](#)[\[Introduction\]](#)[\[Dicoumarols\]](#)[\[Furocoumarins\]](#) [\[Return to list of toxicants\]](#)

Furocoumarins

Furocoumarins - HOW POISONING OCCURS

Furocoumarins are primary photodynamic agents. They absorb long-wave ultra-violet radiation upon exposure of the skin of the affected animal to sunlight and become photoactive. They then cause cell damage by inhibiting DNA synthesis by binding pyrimidine bases and nucleic acids.

PLANTS INVOLVED

Bishop's weed (*Ammi majus*), spring parsley (*Cymopterus watsonii*), and dutchman's breeches (*Thamnosma texana* and *T. montana*) are weeds found in different rangeland regions of the U.S. Livestock consume them as forage or as seed contamination in grain. They contain several psoralens including xanthotoxin and bergapten that break down readily to form furocoumarins. Furocoumarins are also produced by some plants, for example, celery and parsnips, in response to fungal infestation.

SYMPTOMS OF POISONING

- severe blistering and peeling particularly of light-skinned parts of the animal
 - clouding of the cornea and eye lesions -->severe cases - blindness
 - blistering and erythema of the udder of lactating females, e.g. ewes and cows, -->severe cases - starvation of their offspring when dams refuse to nurse
 - "celery dermatitis" - blistering of arms of farm workers handling celery when the celery is diseased with pink rot (*Sclerotinia sclerotiorum*) and produces xanthotoxin and trisoralen.
-

[\[Index\]](#)[\[Introduction\]](#)[\[Dicoumarols\]](#)[\[Furocoumarins\]](#) [\[Return to list of toxicants\]](#)

This series of web pages was created by an undergraduate student at Cornell University for the AS625 class. All comments and suggestions are welcome.

WARNING: These web pages are only meant to be informative. Neither Cornell University nor the author of this site endorse or recommend the use of these plants.

Return to: [Poisonous Plants Homepage](#)

Home page: [Animal Science at Cornell University](#)

For problems or comments on this web page, contact the Animal Science [Webmaster](#)

GLUCOSINOLATES (GOITROGENIC GLYCOSIDES)

Index

- [Introduction](#)
- [How poisoning occurs](#)
- [Plants involved](#)
- [Symptoms of poisoning](#)
- [Prevention of poisoning](#)
- [Benefits of glucosinolates](#)

[\[Return to list of toxicants\]](#)

Introduction

[Glucosinolates](#) are thioethers. They generally consist of a sugar entity, b-D-thioglucose, with an ester bond to an organic aglycone that is an alkyl group yielding isothiocyanate, nitrile, thiocyanate or a similar compound upon hydrolysis. These compounds often contribute a bitter, "hot" taste to condiments (mustard, horseradish) and may exhibit goitrogenic or antithyroid activity. [\[return to list of toxicants\]](#)

How poisoning occurs

Glycosinolates are hydrolyzed by either the enzyme glucosinolase or thioglucosidase into glucose, HSO₄⁻, and one of the following aglycone derivatives: isothiocyanates, thiocyanates, nitriles, or related compounds such as oxazolidine-2-thiones. The enzymes for hydrolysis are produced by plants and by rumen organisms. They react with the glucosinolates when plant tissue is crushed, for example by mastication, or when the plant is consumed into the rumen of a ruminant animal.

- **Isothiocyanates** - are irritating to mucous membranes and not readily consumed in sufficient quantities to be toxic. However, if they are consumed as glucosinolates and then hydrolyzed to isothiocyanates in the gut, they can have powerful antithyroid effects and interfere with the synthesis of necessary thyroid hormones.
- **Oxazolidine-2- thiones** - are closely related to isothiocyanates. One way they are produced is by the conversion of the glucosinolate progoitrin in rapeseed meal to

goitrin which in turn is hydrolyzed to these compounds. Oxazolidine-2-thiones depress growth and increase the incidence of goiters. They inhibit thyroid function by blocking the incorporation of iodine into thyroxine precursors and by suppressing thyroxine secretion from the thyroid.

- **Nitriles** - depress growth, cause liver and kidney lesions, and in severe cases --> liver necrosis, bile duct hyperplasia, and megalocytosis of tubular epithelium in the kidney.
 - **Thiocyanates** - inhibit iodine uptake by the thyroid --> leading to reduced iodination of tyrosine --> resulting in decreased production of the important thyroid hormone thyroxine.
-

Plants involved

Some common plants that contain glucosinolates include

- *Amoracia lapathifolia*, Horseradish
 - *Brassica campestris*, Turnips, yellow-hulled rape
 - *Brassica chinensis*, Pak-choi
 - *Brassica napus*, Rutabaga, brown-hulled rape
 - *Brassica nigra*, Black mustard
 - *Brassica oleracea*, Cabbage, brusselsprouts, brocolli, cauliflower, kale, kohlrabi
 - *Crambe abyssinica*, Crambe
 - *Limnanthes alba*, Meadowfoam
 - *Nasturtium officinalis*, Watercress
 - *Raphanus sativus*, Radish
 - *Thiaspi arvense*, Stinkweed
-

Symptoms of poisoning

Glucosinolates are found in several **oil meals** that have been used traditionally in the northern states, Canada, and Europe as protein supplements for livestock. Some examples include crambe, mustard, and meadowfoam meal, and most importantly, rapeseed meal. Rapeseed meal contains several glucosinolates and produces not only oxazolidine-2-thiones but also isothiocyanates, nitriles and thiocyanates.

Poultry and **swine** and other nonruminants can tolerate 5-10% rapeseed meal in their diets. **Symptoms of poisoning in poultry** may include depressed growth, goiters, perosis, poor egg production, off-flavored eggs, enlarged thyroid in chick embryos, and liver damage. **Symptoms of poisoning in swine** include growth depression, goiters, and

enlarged livers.

Although rumen enzymes break down glucosinolate aglucones to their toxic derivatives, other rumen enzymes are able to metabolize these toxicants into less toxic compounds. Hence, ruminants can generally tolerate diets of 10% rapeseed meal. More than this can cause antithyroid symptoms.

Glucosinolates and their derivatives can be transferred through milk and placenta to the young of female animals.

Prevention of poisoning

Addition of extra iodine to diets can help to counteract the antithyroid effects of thiocyanates but not of oxazolidine-2-thiones.

Canadian plant breeders have developed low-glucosinolate cultivars of rapeseed. These cultivars are referred to as canola rather than rapeseed. Meal from them can be used in high enough quantities to provide all the protein supplementation demanded in livestock diets that require high levels of protein.

Benefits of glucosinolates

Glucosinolates are responsible for the unique taste of many of the condiments that make our foods more interesting to taste.

Research indicates that glucosinolates and their derivatives may have potential in fighting human cancers. Inclusion of *Brassica* vegetables appear to help protect against rectal and colon cancer. These vegetables aid in the detoxification of carcinogens such as aflatoxins and polybromobiphenyl. They enhance the activity of several hepatic enzymes used in detoxification processes. Benzyl isothiocyanate and thiocyanate have been shown in the lab to inhibit tumor development in animals exposed to carcinogens. Indole-3-carbinol, a product of glucosinolates, is a compound with promise in anticancer research.

[\[Index\]](#) [\[Introduction\]](#) [\[How poisoning occurs\]](#) [\[Plants involved\]](#) [\[Symptoms of poisoning\]](#) [\[Prevention of poisoning\]](#) [\[Benefits of glucosinolates\]](#) [\[References\]](#)

Return to: [List of Toxicants](#)

Home page: [Animal Science at Cornell University](#)

For problems or comments on this web page, contact the Animal Science [Webmaster](#)

PHYTOESTROGENS (COUMESTANS AND ISOFLAVONES)

INDEX

- [Introduction](#)
 - [Clovers \(*Trifolium* spp.\)](#)
 - Alfalfa (*Medicago sativa*)
 - [How poisoning occurs](#)
 - [Symptoms of poisoning](#)
-

INTRODUCTION

Phytoestrogens are plant estrogens. When consumed by livestock they exhibit estrogenic activity and may hamper reproductive performance. Clovers such as subterranean clover (*Trifolium subterranean*) and red clover (*Trifolium pratense*) generally contain isoflavones. Alfalfa (*Medicago sativa*) contains coumestans.

Subterranean Clover and Red Clover (*Trifolium subterranean*)

Subterranean Clover

Subterranean clover is a winter annual grown in the northwest regions of the U.S. as a winter and spring pasture crop. It pushes its seeds down into the ground upon maturity and thus reseeds itself. Its seeds can remain dormant for many years making it difficult to eradicate once established in a pasture.

Red Clover

HOW POISONING OCCURS

Certain water soluble glucosides in plants bear a close resemblance to estradiol and are known as plant estrogens ([click here to see the similarities](#)). Clovers synthesize isoflavones such as biochanin A, daidzein, formononetin, and genistein from phenylalanine, while alfalfa synthesizes coumestans from cinnamic acid. Although formononetin has about half, one third, and one quarter the estrogenic activity of biochanin A, daidzein, and genistein, respectively, negative estrogenic effects on sheep

appear to be directly correlated to the formononetin content of the clover forage. This is because [rumen microorganisms degrade genistein and biochanin A to p-ethylphenol and phenolic acids](#), thus destroying their estrogenic effects. However, rumen microorganisms demethylate formononetin to daidzein, and then together with any daidzein directly consumed from the clover, these minor [phytoestrogens are metabolized to equol](#) which is a much more potent form of estrogen. Absorbed equol is rapidly excreted in the urine of cattle, but not in sheep. Thus sheep are much more susceptible to the estrogenic effects of isoflavones. Isoflavones alter the responsiveness of the animal tissue to endogenous estrogen. High serum levels of phytoestrogens may also inhibit the release of gonadotropic hormones from the pituitary gland and fill receptor sites in the cervix and uterus meant for endogenous estrogens.

SYMPTOMS OF POISONING

The cervix of a ewe exposed to high formononetin clover cultivars undergoes morphological changes. The cervical folds fuse together so that the cervical tissue resembles uterine tissue. During breeding season, the cervix and vagina fail to respond to endogenous estrogen stimulation and temporary infertility results because of reduced ability of the sperm to penetrate the oviduct. This is because the cervical mucus does not undergo its normal changes or "priming" to aid sperm longevity in the cervix. After 24 hours, the amount of viable sperm present in the cervix is only about 5% of that found in a healthy cervix. Ovulation generally occurs following standing heat so this reduced longevity of sperm can have serious consequences on conception rates. The condition may become permanent if the ewe remains on these forages for prolonged periods of time.

Cattle that are exposed to alfalfa cultivars with high contents of coumestans may experience cystic ovaries and irregular heat cycles. Dairy heifers may exhibit precocious mammary and genital development.

[\[Index\]](#) [\[Introduction\]](#)[\[Clovers\]](#)[\[How poisoning occurs\]](#)[\[Symptoms of poisoning\]](#)

This series of web pages was created by an undergraduate student at Cornell University for the AS625 class. All comments and suggestions are welcome.

WARNING: These web pages are only meant to be informative. Neither Cornell University nor the author of this site endorse or recommend the use of these plants.

Return to: [\[List of Toxic Agents\]](#) [\[Poisonous Plants Homepage\]](#)

Home page: [Animal Science at Cornell University](#)

For problems or comments on this web page, contact the Animal Science [Webmaster](#)

Ranunculosides or Ranoculins

- Ranunculosides or ranoculins as they are also called are volatile lactones. They are glycosides which upon hydrolysis split up into ranunculine and glucose. Ranunculine is then converted into an unsaturated lactone: protoanemonine

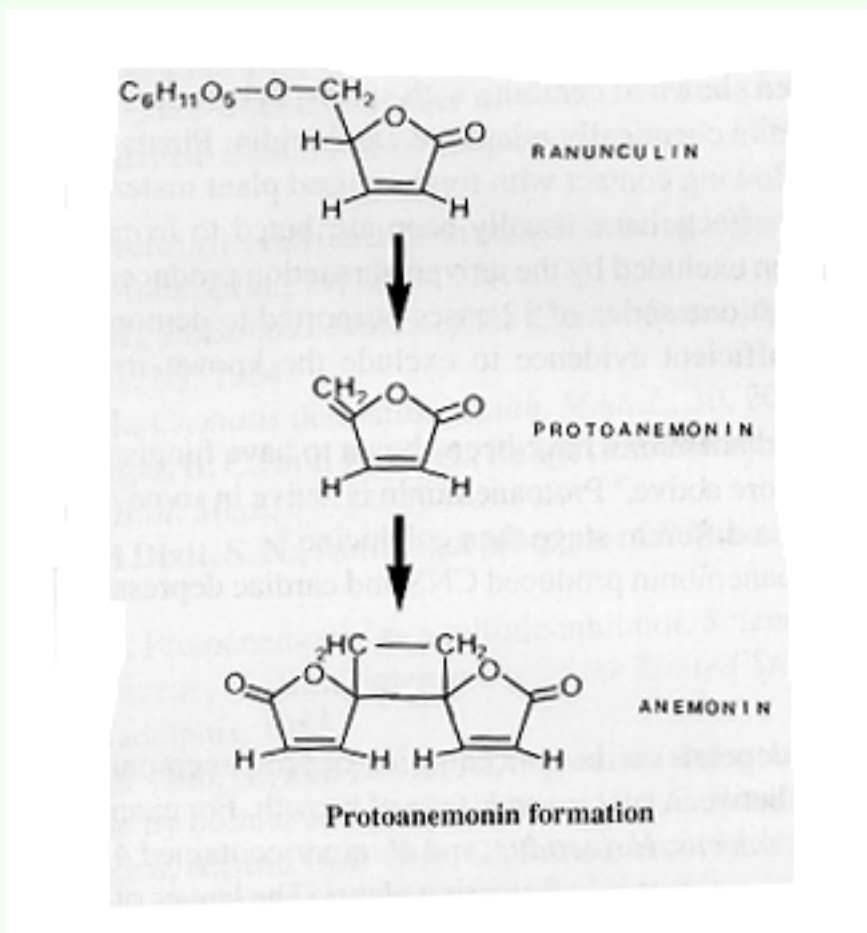

Picture . Protoanemonin formation

- Protoanemonine is a very unstable compound. Upon drying it reacts into anemonine which further converts into anemonic acid by itself. Ranunculine, protoanemonine and anemonine have medicinal properties, anemonic acid does not. Protoanemonine is toxic, its derivatives are not.
- The sap of any plant of the family *Ranunculaceae* has a burning taste and may cause reddening of skin followed by swelling and even blistering. If swallowed in large quantities, stomach irritation may follow and further develop into stomach colic and extreme gastro-enteritis and diarrhea mixed with blood. For treatment large quantities of mucilage is required.
- Ranunculosides are chemically similar to coumarins (both are lactones) but are less stable as they are not phenolic substances.
- Anyone collecting or handling plants of the family *Ranunculaceae* with bare hands should be careful not to holding them for long as the sap irritates the skin and can cause blisters.

- Some plants containing ranunculoides:

Christmas rose (*Helleborus niger*), marsh marigold (*Calatha palustris*), clematis (*Clematis recta*), wood anemone (*Anemone nemorosa*), hepatica (*Hepatica nobilis*), field buttercup (*Ranunculus acris*), globe flower (*Trollius europaeus*), and pasque flower (*Pulsatilla vulgaris*)

This series of web pages was created by an undergraduate student at Cornell University for the AS625 class. All comments and suggestions are welcome.

WARNING: These web pages are only meant to be informative. Neither Cornell University nor the author of this site endorse or recommend the use of these plants.

Return to: [\[List of Toxic Agents\]](#) [\[Poisonous Plants Homepage\]](#)

Home page: [Animal Science at Cornell University](#)

For problems or comments on this web page, contact the Animal Science [Webmaster](#)

SAPONINS

INDEX

- [Introduction](#)
 - [Plants involved](#)
 - [Symptoms of poisoning](#)
 - [Bloat?](#)
 - [Cholesterol absorption?](#)
-

INTRODUCTION

Saponins are glycosides with a distinctive foaming characteristic. They are found in many plants, but get their name from the soapwort plant (*Saponaria*), the root of which was used historically as a soap (Latin *sapo* ---> soap). They consist of a polycyclic aglycone that is either a choline steroid or triterpenoid attached via C3 and an ether bond to a sugar side chain. The aglycone is referred to as the sapogenin and steroid saponins are called saraponins. The ability of a saponin to foam is caused by the combination of the nonpolar sapogenin and the water soluble side chain. Saponins are bitter and reduce the palatability of livestock feeds. However if they have a triterpenoid aglycone they may instead have a licorice taste as glucuronic acid replaces sugar in triterpenoids. Some saponins reduce the feed intake and growth rate of nonruminant animals while others are not very harmful. For example, the saponins found in oats and spinach increase and accelerate the body's ability to absorb calcium and silicon, thus assisting in digestion. Certain pasture weeds contain substantial quantities of dangerous saponins and result in life threatening toxicities for certain animal species.

Plants Involved

Saponins are generally not a problem in tropical forage legumes. However, they are common in several temperate forage legumes. The use of alfalfa, (*Medicago sativa*, in supplemental protein meals for swine and poultry is limited by its saponin content. Although alfalfa contains several saponins (medicagenic acid, soyasapogenol A, soyasapogenol B, lucernic acid), medicagenic acid appears to be the one responsible for its antinutritional effects. Saponin content in alfalfa foliage is low in spring and fall and high in midsummer. Low-saponin cultivars of alfalfa have been developed. The seeds and foliage of chickpeas (*Cicer arietinum*), soybeans (), and common beans () also contain saponins. Several rangeland weeds in the US including corn cockle (*Agrostemma githago*, soapwort (*Saponaria officinalis*), cow cockle (*Saponaria vaccaria*), and

broomweed (*Gutierrezia sarothrae*) cause serious toxicity problems for grazing livestock because of their saponins. Alfombrilla (*Drymaria arenaroides*) is a weed in northern Mexico containing @3% saponins that is responsible for cattle losses in Mexico and has potential for spread to the southwest U.S. Yucca contains sarsaponins and is occasionally grazed by cattle. However, research indicates that sarsaponins might actually be beneficial to rumen digestion. Other plants containing saponins include Christmas Rose (*Helleborus niger*), Horse Chestnut trees (*Aesculus hippocastanum*), Asparagus fern (*Asparagus officinalis*), and Daisies (*Bellis perennis*)

[\[Index\]](#) [\[Introduction\]](#) [\[Plants involved\]](#) [\[Symptoms of poisoning\]](#) [\[Bloat?\]](#) [\[Cholesterol absorption?\]](#)

Symptoms of Poisoning

Alfalfa poisoning in poultry and swine:

- irritated mucous membranes of the mouth and digestive tract -->
- reduced feed intake,
- low dietary protein quality (supplemental methionine will counteract this).
- the above factors lead to--> decreased performance and growth rate.
- increased excretion of cholesterol.

Corn cockle, soapwort, cow cockle, and broomweed poisoning

- listlessness
- anorexia
- weight loss
- rough hair coat
- gastroenteritis and diarrhea
- in the case of broomweed, possibly abortion.

Alfombrilla

- same symptoms as above plants, but progressing rapidly to -->
- arched back -->
- coma -->
- death

As well as irritating the membranes of the respiratory and digestive tract, the aglycones in certain saponins increase the permeability of the membranes of red blood cells. In severe cases, the membranes are destroyed and their hemoglobin escapes into the bloodstream. This hemolytic effect varies considerably between different plant species.

[\[Index\]](#) [\[Introduction\]](#) [\[Plants involved\]](#) [\[Symptoms of poisoning\]](#) [\[Bloat?\]](#) [\[Cholesterol absorption?\]](#) [\[References\]](#) [\[Return to list of toxicants\]](#)

Bloat

Historically, saponins have been blamed for the incidence of bloat in ruminants consuming fresh alfalfa. Bloat occurs in animals grazing temperate legumes that contain saponins but not in livestock grazing tropical legumes or temperate legumes like birdsfoot trefoil that do not contain saponins. However, low-saponin cultivars of alfalfa can cause bloat. Current research blames bloat on cytoplasmic protein fractions that are also present in the plants..

Cholesterol absorption?

Humans generally do not suffer severe poisoning from saponins. Our cholesterol inactivates them so that only our mucus membranes are affected. Because of this, saponins have been used in sneezing powders, emetics, and cough syrups to facilitate expectoration. Most saponins are also diuretic. In humans, this effect disappears within a week following the neutralizing action of cholesterol.

Alfalfa saponins may have potential in human health issues because they reduce serum cholesterol by preventing its reabsorption after it has been excreted in the bile. It is hypothesized that the saponins either bind with bile salts or cause the bile salts to bind to the polysaccharides in dietary fiber. Either way the bile salts are unavailable to bind with cholesterol. Unfortunately, the feeding of alfalfa saponins to hens has not resulted in low cholesterol eggs!

[\[Index\]](#) [\[Introduction\]](#) [\[Plants involved\]](#) [\[Symptoms of poisoning\]](#) [\[Bloat?\]](#) [\[Cholesterol absorption?\]](#) [\[References\]](#) [\[Return to list of toxicants\]](#)

This series of web pages was created by an undergraduate student at Cornell University for the AS625 class. All comments and suggestions are welcome.

WARNING: These web pages are only meant to be informative. Neither Cornell University nor the author of this site endorse or recommend the use of these plants.

Return to: [Poisonous Plants Homepage](#)

Home page: [Animal Science at Cornell University](#)

For problems or comments on this web page, contact the Animal Science [Webmaster](#)

VICINE AND COVICINE

INDEX

- [Introduction](#)
 - [How poisoning occurs](#)
 - [Symptoms of poisoning in humans](#)
 - [Effects on chickens](#)
 - [Effects of fava silage](#)
-

INTRODUCTION

Fava beans, *Vicia faba*, are a common human food in the Mediterranean regions of Europe. Their potential as a protein supplement for livestock is being explored in the U.S. and Canada. However, fava beans contain the glycosides [vicine](#) and covicine. These glycosides hamper the development of fava beans as a worldwide food and feed crop because they cause a disease called favism in people who have an inherited absence of the enzyme glucose-6-phosphate dehydrogenase (G6PD) in their red blood cells.

HOW POISONING OCCURS

More than 100 million people worldwide are genetically deficient in G6PD. People whose red blood cells are deficient in G6PD appear to be more resistant to the detrimental effects of malaria. Thus, this genetic condition is rarely found in populations with little historical exposure to malaria, but instead is concentrated in populations where malaria is prevalent. Susceptible people are exposed to favism either by inhaling the pollen of fava bean flowers or by eating the beans. In people who lack G6PD, [divicine](#), the aglycone of vicine, and [isouramil](#), the aglycone of covicine, cause acute hemolytic either by direct action on the red cell membranes or by producing hydrogen peroxide which in turn breaks down red cell membranes. The enzyme G6PD functions to maintain plentiful supplies of reduced glutathione. Oxidants such as divicine, isouramil, and hydrogen peroxide are normally reduced and rendered inactive by exposure to reduced glutathione. However, vulnerable individuals produce insufficient GSH to block the destruction of red cell membranes by these oxidants. The incidence of this genetic deficiency is as high as 50% in some populations. Prior to the advent of highly effective blood transfusion technology, mortality rates of 6 to 8% were reported in G6PD deficient children exposed to fava beans.

[\[Index\]](#) [\[Introduction\]](#) [\[How poisoning occurs\]](#) [\[Symptoms in humans\]](#) [\[Effects on chickens\]](#)[\[Effects of fava silage\]](#)

SYMPTOMS OF POISONING IN HUMANS

Symptoms appear shortly after inhaling pollen but not until about 5 to 24 hours after eating the beans. They include

- headaches, dizziness, nausea, yawning -->
 - vomiting, abdominal pain, and fever -->
 - at this point, symptoms either spontaneously subside, or -->
 - acute hemolytic anemia occurs.
-

EFFECTS ON CHICKENS

Fava beans have detrimental effects on the the metabolism of chickens because of their content of tannins, protease inhibitors, and lectins as well as vicine and convicine. These factors result in lower growth rate and feed efficiency, and enlarged livers and pancreas in chicks, and in poorer feed efficiency in laying hens. Dietary vicine has been shown to cause reduced fertility and hatchability of eggs, decreased egg and yolk weights, fewer eggs, increased plasma lipid and peroxide levels, and heavier livers with increased lipid peroxide levels and decreased glutathione levels in layers.

[\[Index\]](#) [\[Introduction\]](#) [\[How poisoning occurs\]](#) [\[Symptoms in humans\]](#) [\[Effects on chickens\]](#)[\[Effects of fava silage\]](#)

EFFECTS OF FAVA BEAN SILAGE

In contrast to the disappointing results of fava beans on chickens, fava bean silage has compared favorably with oat, corn, and field pea silage when fed to ruminants.

This series of web pages was created by an undergraduate student at Cornell University for the AS625 class. All comments and suggestions are welcome.

WARNING: These web pages are only meant to be informative. Neither Cornell University nor the author of this site endorse or recommend the use of these plants.

Return to: [Poisonous Plants Homepage](#)
Home page: [Animal Science at Cornell University](#)

For problems or comments on this web page, contact the Animal Science [Webmaster](#)

Selenium and Livestock

Metabolism, Toxicity, and Deficiency



[Background & Metabolism](#) [Distribution/Occurrence](#) [Feed Analyses](#) [Toxicity](#) [Deficiency](#) [Cattle](#) [Sheep](#) [Swine](#) [Horses](#) [Poultry](#)
[Sites](#) [References](#)

(This web page is a collection/summary of the works of several authors, referenced at the bottom of the page.)

BACKGROUND & METABOLISM

Selenium was discovered as an essential nutrient in 1957, though it was not discovered what role it played in the body until 1973. The discovery of Se in glutathione peroxidase was the key to understanding its importance in nutrition and health. Glutathione peroxidase, or GSH-Px, is essential for protecting cellular membranes from being destroyed.

Compounds called free radicals are highly reactive molecules, and if left unchecked will destroy cellular membranes. Vitamin E and GSH-Px are two molecules that help prevent this damage. Vitamin E prevents the dangerous molecules (peroxides) from being formed, but even with adequate vitamin E, some peroxides evade destruction. GSH-Px destroys the peroxides before they have a chance to cause membrane damage. GSH-Px concentration and activity is directly related to the selenium status of the animal. Selenium and vitamin E are both antioxidants because they both protect the membranes from oxidative damage. Due to this shared duty, there is a relationship between the compounds, in which one can substitute for the other in a very small way. For instance, more Se is needed when an animal's vitamin E concentrations are low. The sparing effect is an extension of this idea of substitution. Selenium spares vitamin E by:

1. preserving pancreas integrity for normal fat digestion, thus normal vitamin E absorption
2. reducing the amount of vitamin E needed to maintain lipid membranes via GSH-Px
3. aiding in the retention of vitamin E in the blood

Vitamin E spares Se by:

1. maintaining body Se in an active form and prevents loss from the body
2. preventing destruction of membrane lipids from within the membrane, which inhibits the production of hydroperoxides and decreases the amount of GSH-Px needed

Selenium has also been recently found in another enzyme, 5'-deiodinase. 5'-deiodinase is an enzyme that catalyzes the reaction of the inactive form of thyroxine to the active form. Thyroxine is a very important hormone from the thyroid that helps in regulating body temperature, metabolism, reproduction, circulation, and muscle function. It is known that Se protects the body from heavy metals such as cadmium, mercury, and silver by forming unreactive complexes with them. There are theories that Se may be involved in many other functions in the body, such as-

- a selenoprotein in sperm
- in RNA
- role in prostaglandin synthesis
- role in essential fatty acid metabolism
- required for normal immune response

Elemental selenium (Se (0)) can be reacted upon in several ways: it can be reduced to a Se(-2), called selenide, or it can be oxidized to a (+4) state, selenite, or a (+6) state,

selenate. Selenium is very similar to sulfur in its chemical properties; it is therefore, not surprising that the main form of organic Se in the body is as selenomethionine and selenocystine. Methionine and cystine are sulfur-containing amino acids, the Se can replace the sulfur because of its chemical similarities to sulfur.

There is not a lot of information on the absorption and pathway of Se from the gastrointestinal tract. It is known that it is absorbed mostly from the upper small intestine; there is no absorption from the stomach, rumen, or abomasum. The amount absorbed depends on the chemical form in which it is ingested. There does not seem to be any feedback loop to reduce the amount of Se absorbed; it has been shown, in rats, that 95% of dietary Se was absorbed regardless if fed deficient or toxic amounts. Absorbed Se travels in the plasma on a protein to its destination tissue. Tissue concentrations vary, the kidneys retain a large amount of Se, along with cardiac and skeletal muscle, and the liver. It is deposited more readily when it is in an organic form. Selenium is readily transferable through the placenta, the mammary barrier, and from hen to egg, so the animal's status will affect offspring and milk concentrations. The primary routes of excretion are through the urine and the feces, exhalation of Se only occurs in cases of toxicity. It has been found that the microorganisms in the rumen may convert Se into insoluble compounds, causing the ruminant animal to absorb less than its monogastric counterpart. It has also been suggested that more Se is absorbed when administered with a high-protein diet, the reasons have not been confirmed.

[Go back to top of page](#)

DISTRIBUTION/OCCURRENCE

Distribution of selenium is variable throughout the United States. Most of the Eastern and Northwestern areas of the country have low selenium in the soil and in the plants, while in the Midwest, there are adequate amounts of selenium in the forages. For a more detailed map:[Map of Selenium Status in US](#). There are several plant species that accumulate selenium in toxic amounts, and can cause problems in animals which consume them. The most prevalent of these species is the *Astragalus* genus, which are the locoweeds and milk vetches. For more information on *Astragalus*:

- [Canadian Poisonous Plant Page on *Astragalus bisulcatus*](#)
- [Astragalus Toxicity](#)
- [Astragalus \(pictures and description\)](#)

There are several other species of plants that are characterized as Se accumulators, such as *Zylorhiza*, woody aster and *Oonopsis*, goldenweed. All of these plants are more prevalent in the western United States. Highly seleniferous plants are not readily eaten by most animals due to their bitter taste and strong odor, but will be consumed when other forage is sparse.

[Go back to top of page](#)

FEED ANALYSES

FEED	Se CONTENT (mg/kg)	FEED	Se CONTENT (mg/kg)
Alfalfa	0.32 - 0.37	Barley grain	0.11 - 0.22
Brewer's Grain	0.70	Corn (distiller's grain)	0.48
Corn (gluten meal)	1.11	Corn (grain)	0.08
Cottonseed	10.0	Fish meal	1.4 - 2.4
Flax seed	0.9	Oats (grain)	0.26
Oats (hay)	0.17	Oats (silage)	0.01
Rape seed	1.05	Sorghum silage	0.21
Soybean seed	0.11	Sunflower meal	2.13
Wheat (soft, winter grain)	0.05	Wheat (hard, winter grain)	0.45
Whey (dehydr.)	0.06	Yeast	0.98 - 1.08

This data was taken from the NRC Nutrient Requirements for the different species.

There is only one mineral supplement that contains selenium, and that is selenite.

[Go back to top of page](#)

The toxicity and deficiency sections are general information and contain diseases that affect most species; for species specific diseases, see that species' section.

TOXICITY

Selenium toxicity is a serious threat to livestock in the western United States. There is more data on the toxicity of Se in cattle and sheep, but selenosis affects all livestock. There are two general types of toxicity, acute and chronic.

ACUTE TOXICITY

Acute poisoning is caused by the consumption, usually in a single feeding, of a sufficient quantity of highly seleniferous plants, which produce severe symptoms. Usually, death occurs within a few hours. Cattle and sheep are the most likely species to be affected, but also horses, goats, and swine. Studies have shown that possibly as little as 3 mg/kg body weight is the minimum lethal dose in cattle, for horses it may be 3.3 mg/kg BW, and for swine, 1.2 mg/kg BW caused death in 5 days. Symptoms include: abnormal movement, dark watery diarrhea, elevated temperature, weak and rapid pulse, labored respiration, bloating and abdominal pain, mucous membranes are pale and blue, and pupils are dilated. There is no known treatment to reverse the effects of the poisoning, and oftentimes the animal dies before a diagnosis can be made.

CHRONIC TOXICITY

There are two different types of chronic poisoning dependent on the chemical form of the ingested selenium. "Blind staggers" occurs when animals ingest water-soluble selenium compounds naturally found in accumulator plants. Toxicity from eating plants or grain with protein-bound, insoluble selenium is called "alkali disease."

Blind staggers normally occurs in cattle and sheep feeding on seleniferous plants. Symptoms manifest in three stages:

1. wandering, stumbling over objects, anorexia, visual impairment
2. increase in the severity of the first stage, front legs seem unable to support animal
3. blindness, paralysis of tongue and swallowing mechanism, rapid and labored respiration, salivation, and low temperature

The animal will die within a few hours from the onset of the third stage. The action of the toxicity has been documented to delay between stages. The first and second stages may be unnoticeable, and then weeks later, the animal may show signs of the third stage and die. In sheep, it is more difficult to diagnose because the stages are not as well defined as in cattle. Toxic amounts of Se can also cause birth defects in offspring from dams fed



such levels.

Alkali disease is more chronic than blind staggers, often taking years to manifest itself. It is caused by feeding on plants and grain that have protein-bound, insoluble selenium. This disease can affect all livestock, but it is detected mostly in cattle and horses. General

symptoms include: lack of vitality, anemia, emaciation, stiffness of joints, lameness, rough coat, loss of long hair, and hoof sloughing and deformities. Hoof deformities are a classic sign of selenium and can cause lameness and severe pain for the animal; food and water must be provided to the animal, for it may be hesitant to walk.



PREVENTION

The most effective way of preventing selenosis is to remove the animals from the seleniferous area. Treating the soil with sulfates, thus changing the S:Se ratio, can sometimes depress Se uptake by accumulator plants. Results from studies have shown that feeding a higher protein diet may reduce the toxicity of Se; animals fed the same amount of toxic selenium but fed a higher protein diet lived for a few more days than those animals fed a low protein diet. Dilution of high Se feeds with low Se feeds in a mixed ration will help to prevent toxicity. Recognition of seleniferous plants, proper land management, and grazing control are all necessary to completely prevent selenosis.

[Go back to top of page](#)

DEFICIENCY

Deficiency of Se is much more common in the eastern United States where the soil content of Se is low. There are many different diseases that affect the different species, all of which will be addressed in the species sections. There is one disease that is consistent in all livestock species, and that is Nutritional Muscular Dystrophy, or White Muscle Disease (WMD). Nutritional muscular dystrophy is caused by the deficiency of Se and/or vitamin E and S-containing amino acids. The disease is characterized by degeneration of the skeletal muscles, causing stiff gaits, and other problems.

PREVENTION

The most effective way of preventing Se deficiency is to supplement concentrates fed to animals with commercially available supplements to a level of about 0.1-0.3 mg/kg Se. Sodium selenite is the most common commercial supplement; calcium selenite is also

useful, and is less hazardous than sodium selenite. For animals that also eat forage, it would be possible to supplement low Se diets with high Se plants and grains. There are also Se-supplemented salt licks available, and may be the most viable option to farmers. Fertilizer containing Se has not been shown to significantly increase the Se content of the plants from that soil. In areas of known Se deficiency, it is often practice to give calves and second trimester pregnant cows intramuscular injections of Se and vitamin E to prevent disease.

[Go back to top of page](#)

CATTLE

The nutrient requirement for Se for dairy cattle has been set at 0.3 mg/kg, while the requirement for beef cattle is 0.2 mg/kg. Requirements are higher when legumes are fed, S intake is high, vitamin E intake is low, and when diets contain heavy metals. Diets with high amounts of unsaturated fatty acids will increase the requirement for Se. Effects of Se deficiency in cattle include, white muscle disease, retained placenta, unthriftiness, cystic ovarian disease, and anemia.

[Go back to top of page](#)

SHEEP

The nutrient requirement for Se for sheep is 0.10 - 0.20 mg/kg. Sheep share some of the same diseases that cattle get. There is high incidence of white muscle disease in lambs, and there are two types of WMD that affect lambs. The first is congenital WMD, where lambs are wither stillborn, or die within a few days, after physical exertion. The second type is delayed WMD, and can occur from 1-4 months after birth. These lambs walk with



an unsteady gait and arched back. Ewes also suffer from infertility and embryonic loss when Se deficient. There is also a general unthriftiness, i.e., growth depression, decrease in food consumption, and decrease in wool production.

[Go back to top of page](#)

SWINE

The nutrient requirement for Se for swine is 0.10 - 0.30 mg/kg. Pigs may show a variety of diseases in relation to Se deficiency. Hepatic dietetica is the degeneration of the liver, which can manifest itself acutely in rapidly growing pigs as liver failure, or more sub-acutely as jaundice, edema, and/or cardiomyopathy. Mulberry heart disease occurs in growing pigs that develop severe cardiomyopathy, often coupled with hemorrhages of the cardiac tissue. Similar to the other species, pigs can also develop nutritional muscular dystrophy. Spermatogenesis decreases when Se intake is extremely low. Pigs are also more susceptible to swine dysentery when selenium deficient.

[Go back to top of page](#)

HORSES

The nutrient requirement for horses is 0.10 mg/kg. Nutritional muscular dystrophy is the known disease that affects horses with Se deficiency. Similar to sheep, there are three different patterns of NMD that can occur. The first is acute, with death occurring within 24 hours. The foal's tongue may be paralyzed, making in unable to suckle. The second case is more common and is induced by exercise. Older foals are more susceptible to this form; they show an unsteady gait and general muscle weakness, rapid heart rate with arrhythmia, and labored breathing. After a few days, it is difficult to make them stand and they salivate excessively. Mortality from this condition is only about 30-45%. The third condition affects mostly older animals, and is the result of chronic Se deficiency. Affected animals show anorexia, emaciation, generalized muscle weakness, rapid heart rate, and diarrhea.

[Go back to top of page](#)

POULTRY

The nutrient requirement for poultry varies with the status of the animal. For young chicks, < 6 weeks, the requirement is 0.15 mg/kg; for the others, the requirement is 0.10 mg/kg. Several conditions affect poultry due to Se deficiency. One is exudative diathesis, which is the accumulation of fluid throughout the body, particularly in the abdomen and feet. This is caused by increased permeability of the capillaries and leakage of fluid from the capillaries. Chicks with this condition are also anemic and are protein deficient. It occurs about 2-4 weeks after hatching and is easily diagnosed due to the edema and the blue-green tint to the skin after progressing to the hemorrhagic stage. Poultry are also affected by nutritional muscular dystrophy. They also suffer from pancreatic atrophy, which has been found to be caused solely by Se deficiency. Atrophy of the pancreas results in a reduction in the amounts of lipase, trypsinogen, and chymotrypsin--all

enzymes that aid in digestion of food. Therefore, this leads to extremely reduced growth and feathering. Egg production decreases when hens are Se deficient; there is no evidence that suggests an effect on male reproduction.

[Go back to top of page](#)

Some Interesting and Relevant Sites:

- [Cornell Poisonous Plants Web Page](#)
- [Canadian Poisonous Plants Information System](#)
- [Selenium Forum](#)
- [Selenium Poisoning](#)
- [Nutrients for Cattle](#)
- [Selenium in Soil](#)
- [Selenium and the Horse](#)

[Go back to top of page](#)

REFERENCES

Barbezat, G. O., C. E. Casey, P. G. Reasbeck, M. F. Robinson, and C. D. Thomson. *Selenium* IN:Current Topics in Nutrition, vol. 12. Alan R. Liss, Inc., New York, 1984.

Combs, G. F. and S. B. Combs. The Role of Selenium in Nutrition. Academic Press, New York, 1986.

James, L. F., K. E. Panter, H. F. Mayland, M. R. Miller, and D. C. Baker. *Selenium Poisoning in Livestock: A Review and Progress*. IN:Selenium in Agriculture and the Environment. American Society of Agronomy, Inc., Madison, Wisconsin, 1989.

McDowell, L. R. Minerals in Animal and Human Nutrition. Academic Press, New York, 1992.

National Research Council. The Nutrient Requirements of Sheep. National Academy Press, Washington DC, 1968.

National Research Council. The Nutrient Requirements of Beef Cattle. National Academy Press, Washington DC, 1984.

National Research Council. The Nutrient Requirements of Swine. National Academy Press, Washington DC, 1988.

National Research Council. The Nutrient Requirements of Dairy Cattle. National Academy Press, Washington DC, 1989.

Rechcigl, M. Jr. CRC Handbook Series in Nutrition and Food--Section E: Nutritional Disorders, vol. 1. CRC Press, West Palm Beach, FL, 1978.

Rosenfeld, I. and O. A. Beath. Selenium: Geobotany, Biochemistry, Toxicity, and Nutrition.. Academic Press, New York, 1964.

Underwood, E. J. The Mineral Nutrition of Livestock.. Commonwealth Agricultural Bureaux, England, 1981.

[Go back to top of page](#)

This series of web pages was created by Jennifer Cosgrove, an undergraduate student at Cornell University for the AS625 class. All comments and suggestions are welcome.

WARNING: These web pages are only meant to be informative. Neither Cornell University nor the author of this site endorse or recommend the use of these plants.

Return to:

[Return to Toxic Agents List](#)

[Poisonous Plants Homepage](#)

Home page: [Animal Science at Cornell University](#)

For problems or comments on this web page, contact the Animal Science [Webmaster](#)

Lead Poisoning

This page provides information on lead poisoning in humans as well as domestic animal populations. Sections include [sources](#) of lead in houses and barns, [environmental contamination](#) and some of its' causes, toxic levels in [children](#) and [animals](#), [symptoms](#) of toxicity and [links](#) to related sites of information.

With the relatively recent restrictions on the use of lead based paints, one of the largest sources of lead poisoning has been greatly reduced. These paints are still present in houses, garages, barns, on fences and furniture. The prevalence of lead in the world around us is still a significant health hazard, especially to certain "at risk" portions of human and animal populations. Although adults are susceptible to lead poisoning, children and newborns are most susceptible because of lower tolerance levels and the tendency to introduce foreign objects into the body.

Sources In the Home

- Lead-Based Paint-Present on many surfaces in homes not recently rebuilt or remodeled
- Lead Pipes-More common in older homes
- Lead Solder -On pipes and water heaters
- Enameled or Ceramic Pots and Dishware-Improper glazing can leech lead into foods
- Paper Wrappings-Holiday paper and party decorations (10g/kg)
- Food Packages-Polythene plastic bags, flour bags(20mg/kg),cardboard boxes with dyes (50mg/kg)
- Candy Packaging-Candy bar wrappers(7g/kg), Colored sports trading cards packaged with gum(88mg/kg)

Although lead paint chips are still the most common source of acute lead poisoning, candy wrappers and food packaging are of particular concern because they are in direct contact with immediately consumed items. It is important to keep these items from being consumed, chewed or licked.

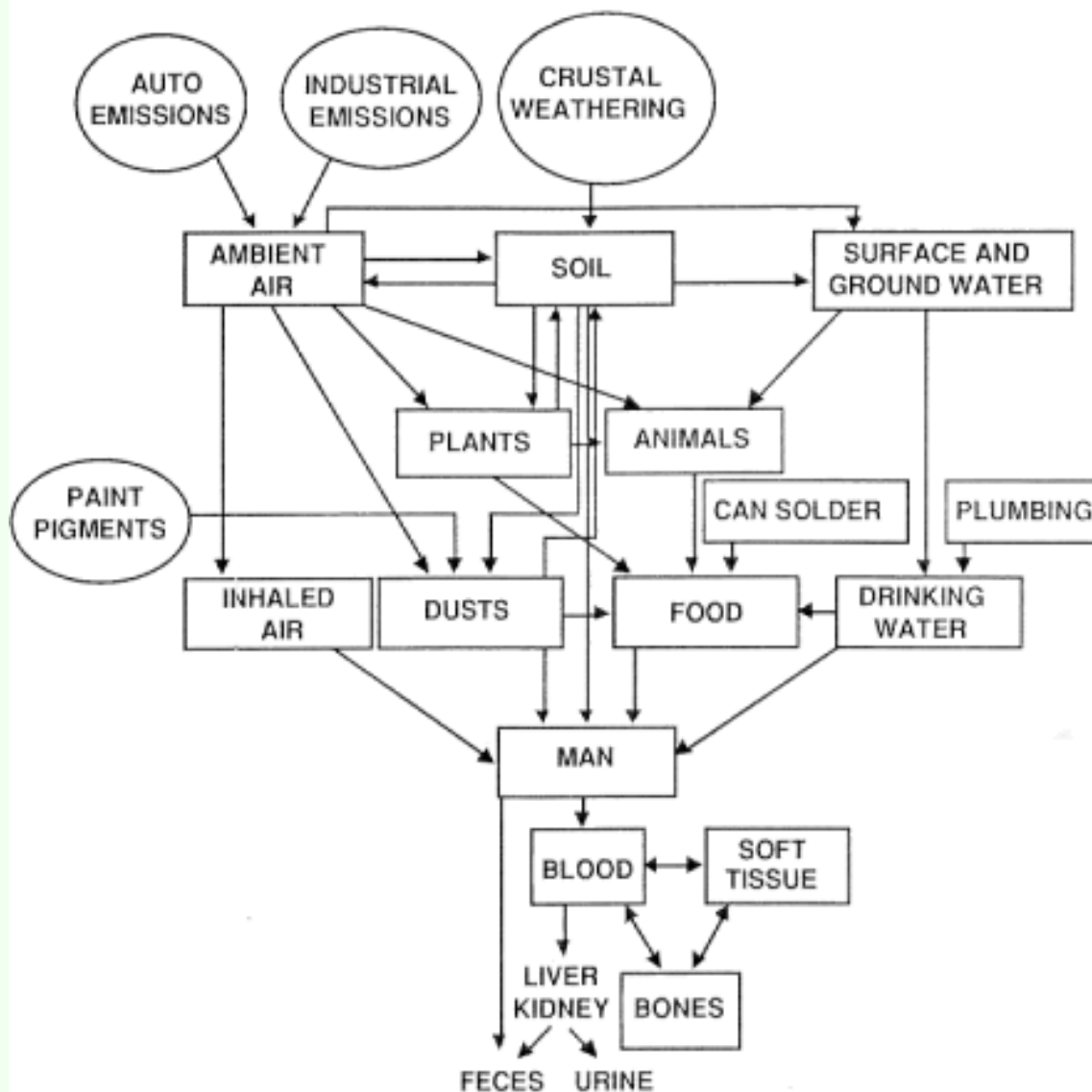

Figure 1 Pathways of lead from the environment to man, and body disposition of lead (EPA, 1986).

Environmental Contamination

- Mining-All types of mining industries, especially strip mining can cause lead and other minerals to leech into ground water, soil and even into the air as dust particles.
- Steel Industry-Any company that produces steel or uses steel in production can contribute to the bioaccumulation of lead in soil, water and air.
- Crop Enhancers-Many crop yields are increased with the use of fertilizers, fungicides and herbicides that contain appreciable amounts of lead (e.g. lead arsenate)
- Automobiles-Lead is added to some gasoline as an anti-knock agent and lead is emitted in motor vehicle exhaust.
- Batteries-Improper disposal of batteries from automobiles, electric vehicles and emergency lighting systems>
- Rogue Metal-Parts of Farm Machinery, Mining Machinery, Food Processing

Equipment or other metal objects that can break and leave pieces or shavings where they may leech into food or the environment.

Toxic Levels In Children

The blood concentrations and classes of poisoning are adapted from CDC literature "Preventing Lead Poisoning in Young Children" published in October 1991.

Class	Blood lead concentration (µg/dl)	Comment
I	= or < 9	A child in Class I is not considered to be lead- poisoned
IIA	10-14	Many children (or a large proportion of children) with blood lead levels in this range should trigger community-wide childhood lead poisoning prevention activities. Children in this range may need to be screened more frequently.
IIB	15-19	A child in Class IIB should receive nutritional and educational interventions and more frequent screening. If the blood lead levels persist in this range, environmental investigation and intervention should be done.
III	20-44	A child in Class III should receive environmental evaluation and remediation and a medical evaluation. Such a child may need pharmacologic treatment of lead poisoning.
IV	45-69	A child in Class IV will need both medical and environmental interventions, including chelation therapy.
V	= or > 70	A child in Class V lead poisoning is a medical emergency . Medical and environmental management must begin immediately

<

Toxic Levels In Animals

- Cattle-Intakes of greater than 6 mg/kg body weight can lead to chronic poisoning and intakes greater than 10 mg/kg BW may cause acute lead poisoning.
- Sheep-Generally occurs only in lambs and symptoms of poisoning appear at intakes

greater than 4.5 mg/kg BW.

- Pigs, Goats and Rabbits-More resistant than sheep or cows. Very minor signs of poisoning occur at intakes of 60 mg/kg BW. This is equal to blood concentrations of 130 micrograms per dl.
- Horses-Respiratory "roaring" occurs at intakes of 6.4 mg/kg BW. Signs of anemia occur at intakes of 7.4 mg/kg.
- Birds-Poultry can withstand dietary intakes of 100 mg/kg feed with no symptoms. Levels of 500 mg/kg induced serious poisoning.
- Dogs and Cats-Nervous symptoms of poisoning appear at intakes of 5 mg/kg BW/day.

Symptoms of Toxicity

- The general symptoms of lead poisoning are universal although more information is available on poisoning in humans. The first symptoms of lead toxicity are very general and nonspecific. These include nausea, sluggishness, vomiting, painful gastrointestinal irritation, diarrhea, loss of appetite, colic, weakness and dehydration. These symptoms are common to many disorders and can often lead to inaccurate diagnosis.
- Some symptoms more specific to human poisoning include discoloration of the lips and skin attributed mild secondary anemia, a lead line on the gums, developmental disorders, sterility and abortion. There have also been some preliminary reports indicating that chronic lead poisoning can also lead to chronic nephritis and premature development of arteriosclerosis.
- More severe cases of poisoning can produce symptoms including convulsions, "wrist drop" or external limb paralysis, coma and ultimately death.

Links

[National Lead Information Center](#)(800)LEAD-FYI Great source of information including pamphlet "Lead Poisoning and Your Children"

[U.S. EPA-Office of Pollution Prevention and Topics](#)

[Dr. Paula](#)Latest consumer information and information about easy-to-use personal lead test kits.

This series of web pages was created by an undergraduate student at Cornell University for the AS625 class. All comments and suggestions are welcome.

WARNING: These web pages are only meant to be informative. Neither Cornell University nor the author of this site endorse or recommend the use of these plants.

Return to: [Poisonous Plants Homepage](#)

Home page: [Animal Science at Cornell University](#)

For problems or comments on this web page, contact the Animal Science [Webmaster](#)

Iron Toxicity, What You Don't Know

The toxicity of iron is governed by absorption. The more you take in the more you are at risk. The iron is absorbed in the ferrous state by cells of the intestinal mucous . Gastric and intestinal secretions can reduce ferric ions (the unusable form of the iron) to the ferrous (absorbable) state. Ferrous iron reacts with hydrogen peroxide (H₂O₂) to form OH, in the reaction: $Fe(II) + H_2O_2 \rightarrow OH \cdot + OH^- + Fe(III)$ Under normal conditions, the free radicals formed are controlled and removed by antioxidants, but if you have an over abundance of iron in your body, the free radicals will not be removed fast enough and there will be a build up.

Factors that influence iron toxicity are:

- Copper Level
- Phosphorus Level
- Vitamin E level

Factors that enhance iron absorption are:

- Valine and Histidine
- Ascorbic Acids, with or without Vitamin E
- Succinate
- Pyruvic Acid
- Citric Acid

Ferritin is a unique iron storage protein containing 24 storage proteins. When excess dietary iron is absorbed, the body produces more ferritin. Ferritin is greatly abundant in the heart and liver, therefore there is a large amount in these organs, and iron rushes to these organs for storage. The body can only produce so much of these proteins, however, so excess iron builds up in these organs and causes tissue destruction. Iron Overload is characterized by increased levels of ferritin (the iron storage protein), haemosiderin (another storage protein), and iron catalyzed lipid peroxidation.

There are many reasons why certain people absorb more iron than others:

1. Not everyone takes in the same amount of iron.
2. When alcohol and food are consumed together, the alcohol facilitate the absorption of iron.
3. Many people develop alcoholic cirrhosis (disease of the liver), and, hence , lose their ability to control iron uptake.
4. Dietary patterns such as drinking orange juice with a meal, increases iron absorption.

Diseases that Can Cause Iron Toxicity

Iron toxicity is not always due to an increase in dietary iron. There are many diseases that can lead to a problem in iron absorption and in turn iron toxicity. With acute iron poisoning, much of the damage to the gastrointestinal tract and liver may be a result of a high localized iron concentration and free radical production, leading to hepatotoxicity via lipid peroxidation and the destruction of the hepatic mitochondria. Therefore, the patient needs rapid removal of iron from the gut to prevent tissue damage.

The iron accumulating disease is **Hemochromatosis**. This is an iron storage disease the results from the inability of the intestine to keep out unneeded iron. Instead, iron accumulates in the liver causing siderosis (the accumulation of storage iron in tissues) and damage to the storage organs. A normal man will usually absorb 1 mg of iron/day, but with this disease, he will absorb 3mg/day. This is a very common problem, 1 out of every 15 people have a form of this disease.

There are two types of this disease:

1. Heredity or Primary Hemochromatosis
2. Acquired or Secondary Hemochromatosis

Hereditary Hemochromatosis is a hereditary disease where the intestines lack the normal ability to keep out the available but unneeded dietary iron. Patients suffering from this disease take in the iron, but have problems excreting it. The excess is therefore placed into storage. It has been shown numerous times, that with an increased uptake from the diet of 1-3 mg of iron, more than required, per day, in a period of 40-50 years, 20-40g of iron will be accumulated in the body. This accumulation especially occurs in the liver and heart, and will eventually lead to necroses and cardiopathy. This condition can be spotted at an early stage by determination of serum ferritin concentration and liver biopsy. This condition can be treated and cured if caught before the tissue damage begins.

Acquired Hemochromatosis is an intestinal abnormality occurring with acquired diseases.

Some of the diseases this may happen with are:

Anemia and Ineffective Erythropoiesis

These diseases may result when a patient receives blood transfusions, but receives them for too long and the iron begins to build up.

Liver Disease

if a patient has a liver disease, he will not be able to control the iron uptake from the liver and the iron will begin to accumulate.

High Intake of Iron

Many times people are diagnosed with anemia, but the confidence rating in this diagnosis is only 95%. Therefore, many people are given supplements that they do not need and the iron in their body increases.

Problems Resulting From Iron Toxicity

There are many problems that may result from iron toxicity, these include: anorexia, oliguria, diarrhea, hypothermia, diphasic shock, metabolic acidosis, and death. In addition to these, the patient may experience vascular congestion of the gastrointestinal tract, liver, kidneys, heart, brain, spleen, adrenals, and thymus.

As a result of iron storage disease, the liver becomes cirrhotic. Hepatoma, the primary cancer of the liver, has become the most common cause of death among patients with hemochromatosis. Also, when siderosis becomes severe in young people, myocardial disease is a common cause of death.

Impotence may occur in young men, and amenorrhea may occur in young women. Both of these sexual related problems are due to iron loading in the anterior pituitary.

Children are at Risk as Well

The lethal dose of iron for a 2 year old child is 3 g, and 1 g leads to severe poisoning. Accidental iron poisoning occurs in children consuming 10-50 iron tablets in the form of ferrous sulfate, over a period of a few hours. The ingested iron enters the stomach where the pH is low. The ferrous sulfate will remain in a soluble form, leading to irritation of the gastric mucosa. When the ferrous sulfate leaves the stomach, the pH is changed again by the pancreatic bicarbonate in the duodenum. This leads to the formation of insoluble iron complexes, causing further mucosal damage.

There was a study conducted from 1983-1990, reported in **Pediatrics**. This study reported that 53 children younger than 6 died as a direct result of unintentional ingestion. Iron supplements caused the death of 16 of these children. Iron supplements, causing 30.2% of fatalities, are the single most frequent cause of pediatric pharmaceutical unintentional fatalities.

The reason for this high percentage involves many factors, including:

- The ready availability of prenatal vitamins and iron supplements in homes with young children.
- The similar appearance of iron supplements to candy.
- The unrestricted over the counter marketing of high strength iron.

These problems could be eliminated by increasing parental education, repackaging and reformulating iron supplements, and making the warning labels more clear.

For more information on your child's risk of iron toxicity, see [Child Safety](#).

Treatment for Iron Toxicity

The following are treatments for iron toxicity:

- **Removal of the patient's blood, one unit at a time.** This is the cheapest, safest,

and most efficient way to reduce siderosis.

- **Dietary restriction.** This not an efficient way to cure the problem, but patients with iron storage disease should avoid heavily iron enriched foods, vitamins supplemented with iron, and therapeutic iron.
- **Chelating agents.** Deferoxamine is the best and least dangerous. It is expensive and administered by painful intramuscular injections. These result in the excretion of 5-15mg of iron. This is very dangerous, however, because the dose and route of administration are limited by the hypotensive effect of the drug. Deferoxamine has an LD50 of 250mg/kg body weight. This drug can only be used for a certain amount of time, not only because of it's toxicity, but also because it results in the removal of other mineral such as copper and zinc.

References

Chapman and Hall. Iron Nutritional and Physiological Significance. The British Nutrition Foundation. 1995.

Emery, T. Iron and Your Health: Facts and Fallacies. CRC Press Inc. 1991.

Iron. Mineral Tolerance of Domestic Animals. 242-255.

Lag, J. Geomedical Problems Related to Aluminum, Iron, and Magnesium. The Norwegian Academy of Science and Letters. 1993.

Lauffer, R. Iron and Human Diseases. CRC Press Inc. 1992.

Litovitz, T. and Manoguerra, A. Comparison of Pediatric Poisoning Hazards: An Analysis of 3.8 Million Exposure Incidents. Pediatrics. 89:1992.

Riederer, P. and Youdim, M. Iron in Central Nervous System Disorders. Springer-Verlag, New York. 1993.

This series of web pages was created by an undergraduate student at Cornell University for the AS625 class. All comments and suggestions are welcome.

WARNING: These web pages are only meant to be informative. Neither Cornell University nor the author of this site endorse or recommend the use of these plants.

Return to: [\[List of Toxic Agents\]](#) [\[Poisonous Plants Homepage\]](#)

Home page: [Animal Science at Cornell University](#)

For problems or comments on this web page, contact the Animal Science [Webmaster](#)

MYCOTOXINS

Index

- **General Characteristics of Mycotoxins**
 - [Definition](#)
 - [Common Members of the Mycotoxin Family](#)
 - [Analysis of Mycotoxins](#)
 - **Troubleshooting of Mycotoxin Problems in Livestock**
 - [Sampling skills](#)
 - [Sources of the Testing Kits](#)
 - [Suggestions to Prevent the Mycotoxins contamination](#)
 - [References](#)
 - [More on Mycotoxins....](#)
-

General Characteristics of Mycotoxins

Definition

"myco" ----> "fungus"

"toxin" ----> "poison" (Cheeke and Shull, 1985)

Mycotoxins are toxic, secondary metabolites of low molecular weight produced by naturally occurring fungi. (Chu, 1992)

Mycotoxins are neither infectious nor contagious, but can occur on a herd-wide basis. (Wren, 1994)

[\[Index\]](#) [\[Definition\]](#) [\[Mycotoxin Family\]](#) [\[Analysis of Mycotoxins\]](#) [\[Sampling\]](#) [\[Testing Kits\]](#) [\[Preventing Mycotoxin Contamination\]](#) [\[References\]](#)

Common Members of the Mycotoxin Family

- Aflatoxins
- Trichothecenes
- Zearalenone

- Fumonisin
 - Ochratoxins
 - Slaframine
-

Analytical Techniques for Mycotoxins

The "**General Referee on Mycotoxins**" gives a good overview of analytical techniques. It is published in the "**Annual Report on Mycotoxins**", which appears annually in the February/March issue of the Journal of the Association of Official Analytical Chemists. (Chu, 1992)

Because of the diversity of chemical structures and physicochemical properties of mycotoxins, approaches for their analysis vary considerably. The analysis is further complicated by the typically uneven distribution of mycotoxins in samples and by sample matrix interference. (Chu, 1992)

Troubleshooting Mycotoxin Problems in Livestock

Sampling Skills

Mycotoxin contamination of foods and feeds is usually heterogeneous. Therefore, precautions must be taken in sampling to obtain a reliable quantitative estimate of the concentration of a mycotoxin in a given lot. (Wood, 1992)

- Samples must be representative of entire lot
- Obtain samples from multiple locations
- Use of a grain or forage sampling probe is recommended
- Obtain samples from a moving grain stream
- Take samples at various unloading sites
- 10 pounds minimum
- mix thoroughly
- subsampling
- send 2 to 5 pounds for analysis
- freezing or air-tighted packing if necessary (especially for high moisture samples)

(Ideas listed were adapted from Dr. Larry Thompson's lecture and from Wren, 1994)

[\[Index\]](#) [\[Definition\]](#) [\[Mycotoxin Family\]](#) [\[Analysis of Mycotoxins\]](#) [\[Sampling\]](#) [\[Testing Kits\]](#)
[\[Preventing Mycotoxin Contamination\]](#) [\[References\]](#)

Sources of Mycotoxins test kits (Spainhour and Posey, 1992)

- CSID
 - Minicolumn
-

Suggestions to Prevent Mycotoxin Contamination of Feed Stuffs

- Control the environmental factors that influence fungal growth: (Diekman and Green, 1992)
 - Moisture content of grain (<14%)
 - Relative humidity (<70%)
 - Temperature (-2.2 Centigrade)
 - Oxygen availability (<0.5%)
- Control the physical condition of the grain: (Adapted from Dr. Thompson's lecture)
 - Minimize grain damage during harvest
 - Screen grain to reduce broken kernels
- Clean storage system regularly (Wren, 1994)
- Use mold inhibitors and anti-caking additives (Diekman and Green, 1992)
- Ammoniation - to reduce aflatoxin concentrations (Diekman and Green, 1992)
- Floating separation - *Fusarium*-infected kernels are lighter than sound kernels (Diekman and Green, 1992)
- Wash, wet or dry milling and heating process (roasting, boiling, baking and frying) (Wood, 1992)
- Addition of 0.5% hydrated sodium calcium aluminosilicate in formulated feed (Diekman and Green, 1992)
- Animal aspects: (Adapted from Dr. Thompson's lecture)
 - Reduce the stress to animals
 - Increase plane of nutrition

(Comment)

Not all molds (or fungi) are toxic. Part of the deleterious impact of mycotoxins on ruminants may be caused by the indirect effect of reduced nutrition from the infected grains or forages. (Adapted from Dr. Thompson's lecture)

[\[Index\]](#) [\[Definition\]](#) [\[Mycotoxin Family\]](#) [\[Analysis of Mycotoxins\]](#) [\[Sampling\]](#) [\[Testing Kits\]](#) [\[Preventing Mycotoxin Contamination\]](#)[\[References\]](#)

References

- Cheeke, P.R. (1995) Endogenous Toxins and Mycotoxins in Forage Grasses and Their Effects on Livestock. J. Anim. Sci. 73:909-918.
- Cheeke, P.R. and Shull, L.R. (1985) Mycotoxins (Chap. 12). In: Natural toxicants in feeds and poisonous plants. AVI. pp393-477.
- Chu, S.F.(1992) Recent Progress on Analytical Techniques for Mycotoxins in Feedstuffs. J. Anim. Sci. 70:3950-3963.
- Diekman, M.A. and Green, M.L. (1992) Mycotoxins and Reproduction in Domestic Livestock. J. Anim. Sci. 70:1615-1627.
- Price, W.D., Lovell, R.A. and McChesney, D.G. (1993) Naturally Occurring Toxins in Feedstuffs: Center for veterinary Medicine Perspective. J. Anim. Sci. 71:2556-2562.
- Richard, J.L., Bennett, G.A., Ross, P.F. and Nelson, P.E. (1993) Analysis of Naturally Occurring Mycotoxins in Feedstuffs and Food. J. Anim. Sci. 71:2563-2574.
- Spainhour, C.B. and Posey, D. (1992) Mycotoxins: A Silent Enemy. Large Animal Veterinarian. Nov./Dec. Page 20-25.
- Thompson, Larry. (1996) Lecture for PLPA 652 ('Mycotoxins')
- Wren, G.. (1994) Blaming Mycotoxins Can Be A Risky Venture. Bovine Veterinarian. Nov. Page 4 -10.
- Wood, G.E.. (1992) Mycotoxins in Foods and Feeds in the United States. J. Anim. Sci. 70:3941-3949.

More References on FDA recommendations [The poisonous plant database](#)

[\[Index\]](#) [\[Definition\]](#) [\[Mycotoxin Family\]](#) [\[Analysis of Mycotoxins\]](#) [\[Sampling\]](#) [\[Testing Kits\]](#)
[\[Preventing Mycotoxin Contamination\]](#) [\[Research\]](#)[\[References\]](#)

This series of web pages was created by Yuan-Kuo Chen, an undergraduate student at Cornell University for the AS625 class. All comments and suggestions are welcome.

WARNING: These web pages are only meant to be informative. Neither Cornell University nor the author of this site endorse or recommend the use of these plants.

Return to: [\[List of Toxic Agents\]](#) [\[Poisonous Plants Homepage\]](#)
 Home page: [Animal Science at Cornell University](#)

For problems or comments on this web page, contact the Animal Science [Webmaster](#)

AFLATOXINS :

Occurrence and Health Risks

Table of Contents :

- [Abstract](#)
 - [Introduction](#)
 - [Occurence](#)
 - [Factors favorizing aflatoxin production](#)
 - [Aflatoxicosis and animal health](#)
 - [Aflatoxins and human health](#)
 - [Recent methods of analysis for aflatoxins in foods and feeds](#)
 - [Monitoring techniques for assessing human exposure to aflatoxins](#)
 - [Control and management of aflatoxins](#)
 - [Economic impact of aflatoxins](#)
 - [References](#)
-

Abstract

Aflatoxins are toxic metabolites produced by certain fungi in/on foods and feeds . They are probably the best known and most intensively researched mycotoxins in the world. Aflatoxins have been associated with various diseases , such as [aflatoxicosis](#) , in livestock , domestic animals and humans throughout the world . The occurrence of aflatoxins is influenced by certain environmental factors ; hence the extent of contamination will vary with geographic location , agricultural and agronomic practices, and the susceptibility of commodities to fungal invasion during preharvest , storage, and/or processing periods . Aflatoxins have received greater attention than any other mycotoxins because of their demonstrated potent [carcinogenic effect](#) in susceptible laboratory animals and their acute toxicological effects in humans . As it is realized that absolute safety is never achieved , many countries have attempted to limit exposure to aflatoxins by imposing [regulatory limits](#) on commodities intended for use as food and feed

.

[Home Page](#)

Introduction

In the 1960 more than 100,000 young turkeys on poultry farms in England died in the course of a few months from an apparently new disease that was termed "**Turkey X disease**". It was soon found that the difficulty was not limited to turkeys. Ducklings and young pheasants were also affected and heavy mortality was experienced.

A careful survey of the early outbreaks showed that they were all associated with feeds, namely Brazilian peanut meal. An intensive investigation of the suspect peanut meal was undertaken and it was quickly found that this peanut meal was highly toxic to poultry and ducklings with symptoms typical of Turkey X disease.

Speculations made during 1960 regarding the nature of the toxin suggested that it might be of fungal origin. In fact, the toxin-producing fungus was identified as [Aspergillus flavus](#) (1961) and the toxin was given the name **Aflatoxin** by virtue of its origin (A.flavis--> Afla).

This discovery has led to a growing awareness of the potential hazards of these substances as contaminants of food and feed causing illness and even death in humans and other mammals. Studies that are summarized in the following sections revealed that aflatoxins are produced primarily by some strains of **A. Flavus** and by most, if not all, strains of **A. parasiticus**, plus related species, **A. nomius** and **A. niger**. Moreover, these studies also revealed that there are four major aflatoxins: [B1](#), [B2](#), [G1](#), [G2](#) plus two additional metabolic products, [M1](#) and M2, that are of significance as direct contaminants of foods and feeds. The aflatoxins M1 and M2 were first isolated from milk of lactating animals fed aflatoxin preparations; hence, the M designation. Whereas the B designation of aflatoxins B1 and B2 resulted from the exhibition of blue fluorescence under UV-light, while the G designation refers to the yellow-green fluorescence of the relevant structures under UV-light. These toxins have closely similar structures and form a unique group of highly oxygenated, naturally occurring heterocyclic compounds. Their molecular formulas as established from elementary analyses and mass spectrometric determinations are:

- B1 : C₁₇ H₁₂ O₆
- B2 : C₁₇ H₁₄ O₆
- G1 : C₁₇ H₁₂ O₇
- G2 : C₁₇ H₁₄ O₇

Aflatoxins B2 and G2 were established as the dihydroxy derivatives of B1 and G1, respectively. Whereas, aflatoxin M1 is 4-hydroxy aflatoxin B1 and aflatoxin M2 is 4-dihydroxy aflatoxin B2.

[\[Top of Page\]](#) [\[Abstract\]](#) [\[Introduction\]](#) [\[Occurrence\]](#) [\[Factors favorizing aflatoxin production\]](#) [\[Aflatoxicosis and animal health\]](#) [\[Aflatoxins and human health\]](#) [\[Methods of](#)

[analysis for aflatoxins](#) [\[Assessing human exposure to aflatoxins\]](#) [\[Control and management of aflatoxins\]](#) [\[Economic impact of aflatoxins\]](#) [\[References\]](#)

[Return to Cornell Toxic Agents List](#)

Occurrence

In Raw Agricultural Products :

Aflatoxins often occur in [crops](#) in the field prior to harvest . Postharvest contamination can occur if crop drying is delayed and during storage of the crop if water is allowed to exceed critical values for the mold growth . Insect or rodent infestations facilitate mold invasion of some stored commodities.

Aflatoxins are detected occasionally in milk, cheese, corn, peanuts, cottonseed, nuts, almonds, figs, spices, and a variety of other foods and feeds . Milk, eggs, and meat products are sometimes contaminated because of the animal consumption of aflatoxin-contaminated feed . However, the commodities with the highest risk of aflatoxin contamination are corn, peanuts, and cottonseed.

In Processed Foods :

[Corn](#) is probably the commodity of greatest worldwide concern , because it is grown in climates that are likely to have perennial contamination with aflatoxins and corn is the staple food of many countries . However, procedures used in the processing of corn help to reduce contamination of the resulting food product . This is because although aflatoxins are stable to moderately stable in most food processes , they are unstable in processes such as those used in making tortillas that employ alkaline conditions or oxidizing steps . Aflatoxin-contaminated corn and cottonseed meal in dairy rations have resulted in aflatoxin M1 contaminated milk and milk products , including non-fat dry milk , cheese , and yogurt .

[\[Top of Page\]](#) [\[Abstract\]](#) [\[Introduction\]](#) [\[Occurrence\]](#) [\[Factors favorizing aflatoxin production\]](#) [\[Aflatoxicosis and animal health\]](#) [\[Aflatoxins and human health\]](#) [\[Methods of analysis for aflatoxins\]](#) [\[Assessing human exposure to aflatoxins\]](#) [\[Control and management of aflatoxins\]](#) [\[Economic impact of aflatoxins\]](#) [\[References\]](#)

[Return to Cornell Toxic Agents List](#)

Factors Favorizing Aflatoxin Production

Fungal growth and aflatoxin contamination are the consequence of interactions among the fungus, the host and the environment . The appropriate combination of these factors determine the infestation and colonization of the substrate , and the type and amount of aflatoxin produced . However , a suitable substrate is required for fungal growth and subsequent toxin production , although the precise factor(s) that initiates toxin formation is not well understood . Water stress , high-temperature stress , and insect damage of the host plant are major determining factors in mold infestation and toxin production . Similarly , specific crop growth stages, poor fertility , high crop densities, and weed competition have been associated with increased mold growth and toxin production. Aflatoxin formation is also affected by associated growth of other molds or microbes . For example, preharvest aflatoxin contamination of peanuts and corn is favored by high temperatures, prolonged drought conditions, and high insect activity; while postharvest production of aflatoxins on corn and peanuts is favored by warm temperatures and high humidity.

[\[Top of Page\]](#) [\[Abstract\]](#) [\[Introduction\]](#) [\[Occurrence\]](#) [\[Factors favorizing aflatoxin production\]](#) [\[Aflatoxicosis and animal health\]](#) [\[Aflatoxins and human health\]](#) [\[Methods of analysis for aflatoxins\]](#) [\[Assessing human exposure to aflatoxins\]](#) [\[Control and management of aflatoxins\]](#) [\[Economic impact of aflatoxins\]](#) [\[References\]](#)

[Return to Cornell Toxic Agents List](#)

Aflatoxicosis and Animal Health

[Aflatoxicosis](#) is primarily a hepatic disease . The susceptibility of individual animals to aflatoxins varies considerably depending on species, age, sex, and nutrition . In fact, aflatoxins cause liver damage, decreased milk and egg production, recurrent infection as a result of immunity suppression (eg. salmonellosis), in addition to embryo toxicity in animals consuming low dietary concentrations. While the young of a species are most susceptible, all ages are affected but in different degrees for different species. Clinical signs of aflatoxicosis in animals include gastrointestinal dysfunction, reduced reproductivity, reduced feed utilization and efficiency , anemia, and jaundice. Nursing animals may be affected as a result of the conversion of aflatoxin B1 to the metabolite aflatoxin M1 excreted in milk of dairy cattle.

The induction of cancer by aflatoxins has been extensively studied. Aflatoxin B1, aflatoxin M1, and aflatoxin G1 have been shown to cause various types of cancer in different animal species. However, only aflatoxin B1 is considered by the **International Agency for Research on Cancer (IARC)** as having produced sufficient evidence of [carcinogenicity](#) in experimental animals to be identified as a carcinogen.

[\[Top of Page\]](#) [\[Abstract\]](#) [\[Introduction\]](#) [\[Occurence\]](#) [\[Factors favorizing aflatoxin production\]](#) [\[Aflatoxicosis and animal health\]](#) [\[Aflatoxins and human health\]](#) [\[Methods of analysis for aflatoxins\]](#) [\[Assessing human exposure to aflatoxins\]](#) [\[Control and management of aflatoxins\]](#) [\[Economic impact of aflatoxins\]](#) [\[References\]](#)

[Return to Cornell Toxic Agents List](#)

Aflatoxins and Human Health

Humans are exposed to aflatoxins by consuming foods contaminated with products of fungal growth . Such exposure is difficult to avoid because fungal growth in foods is not easy to prevent . Even though heavily contaminated food supplies are not permitted in the market place in developed countries, concern still remains for the possible adverse effects resulting from long-term exposure to low levels of aflatoxins in the food supply . Evidence of acute aflatoxicosis in humans has been reported from many parts of the world , namely the Third World Countries, like Taiwan, Ouganda, India, and many others . The syndrome is characterized by vomiting, abdominal pain, pulmonary edema, convulsions, coma, and death with cerebral edema and fatty involvment of the liver , kidneys , and heart.

Conditions increasing the likelihood of acute aflatoxicosis in humans include limited availability of food, environmental conditions that favor fungal development in crops and commodities, and lack of regulatory systems for aflatoxin monitoring and control. Because aflatoxins, especially aflatoxin B1, are potent carcinogens in some animals, there is interest in the effects of long-term exposure to low levels of these important mycotoxins on humans . **In 1988, the IARC placed aflatoxin B1 on the list of human carcinogens.** This is supported by a number of epidemiological studies done in Asia and Africa that have demonstrated a **positive association between dietary aflatoxins and Liver Cell Cancer (LCC)** . Additionally , the expression of aflatoxin-related diseases in humans may be influenced by factors such as age, sex, nutritional status, and/or concurrent exposure to other causative agents such as viral hepatitis (HBV) or parasite infestation.

[\[Top of Page\]](#) [\[Abstract\]](#) [\[Introduction\]](#) [\[Occurence\]](#) [\[Factors favorizing aflatoxin production\]](#) [\[Aflatoxicosis and animal health\]](#) [\[Aflatoxins and human health\]](#) [\[Methods of analysis for aflatoxins\]](#) [\[Assessing human exposure to aflatoxins\]](#) [\[Control and management of aflatoxins\]](#) [\[Economic impact of aflatoxins\]](#) [\[References\]](#)

[Return to Cornell Toxic Agents List](#)

Recent Methods of Analysis for Aflatoxins in Foods and Feeds

Sampling and Sample Preparation :

Sampling and sample preparation remain a considerable source of error in the analytical identification of aflatoxins. Thus, systematic approaches to sampling, sample preparation, and analysis are absolutely necessary to determine aflatoxins at the parts-per-billion level . In this regard, specific plans have been developed and tested rigorously for some commodities such as corn, peanuts, and tree nuts; sampling plans for some other commodities have been modeled after them. A common feature of all sampling plans is that the entire primary sample must be ground and mixed so that the analytical test portion has the same concentration of toxin as the original sample.

Solid-Phase Extraction :

All analytical procedures include three steps: extraction, purification, and determination. The most significant recent improvement in the purification step is the use of solid-phase extraction.

Test extracts are cleaned up before instrumental analysis(thin layer or liquid chromatography) to remove coextracted materials that often interfere with the determination of target analytes.

Thin-Layer Chromatography :

Thin layer chromatography (TLC) , also known as flat bed chromatography or planar chromatography is one of the most widely used separation techniques in aflatoxin analysis. Since 1990, it has been considered the AOAC official method and the method of choice to identify and quantitate aflatoxins at levels as low as 1 ng/g. The TLC method is also used to verify findings by newer, more rapid techniques .

Liquid Chromatography :

Liquid chromatography (LC) is similar to TLC in many respects, including analyte application, stationary phase, and mobile phase. Liquid chromatography and TLC complement each other. For an analyst to use TLC for preliminary work to optimize LC separation conditions is not unusual.

Liquid chromatography methods for the determination of aflatoxins in foods include normal-phase LC (NPLC), reversed-phase LC (RPLC) with pre- or before-column derivatization (BCD), RPLC followed by postcolumn derivatization (PCD), and RPLC with electrochemical detection.

Immunochemical Methods :

Thin layer chromatography and LC methods for determining aflatoxins in food are laborious and time consuming . Often, these techniques require knowledge and experience of chromatographic techniques to solve separation and interference problems. Through advances in biotechnology, highly specific antibody-based tests are now commercially available that can identify and measure aflatoxins in food in less than 10 minutes. These tests are based on the affinities of the monoclonal or polyclonal antibodies for aflatoxins. The three types of immunochemical methods are radioimmunoassay (RIA), enzyme-linked immunosorbent assay (ELISA), and immunoaffinity column assay (ICA).

Confirmation of Identities of the Aflatoxins :

Although analytical methods might consist of different extraction, clean-up, and quantitation steps, the results of the analyses by such methods should be similar when the methods are applied properly. Since the reliability of the quantitative data is not in question, the problem still to be solved is the confirmation of identity of the aflatoxins. The confirmation techniques used involve either chemical derivatization or mass spectrometry (MS).

Safety Issues in Handling Moldy Grains and Aflatoxins :

Safety is a key issue for scientists working in the aflatoxin area. Steps must be taken to minimize exposure to the toxins as well as to the producing microorganisms, **Aspergillus flavus** and **Aspergillus parasiticus**. A safety program should be established that meets the requirements of the Laboratory Standard of the Occupational Safety and Health Administration (1990) and the guidelines of the National Institutes of Health (1981) covering use of chemical carcinogens .

[\[Top of Page\]](#) [\[Abstract\]](#) [\[Introduction\]](#) [\[Occurrence\]](#) [\[Factors favorizing aflatoxin production\]](#) [\[Aflatoxicosis and animal health\]](#) [\[Aflatoxins and human health\]](#) [\[Methods of analysis for aflatoxins\]](#) [\[Assessing human exposure to aflatoxins\]](#) [\[Control and management of aflatoxins\]](#) [\[Economic impact of aflatoxins\]](#) [\[References\]](#)

[Return to Cornell Toxic Agents List](#)

Monitoring Techniques for Assessing Human Exposure to Aflatoxins

In the last few years, new technologies have been developed that more accurately monitor individual exposures to aflatoxins. Particular attention has been paid to the analysis of aflatoxin DNA adducts and albumin adducts as surrogates for genotoxicity in people. Autrup et al.(1983) pioneered the use of synchronous fluorescence spectroscopy for the measurement of aflatoxin DNA adducts in urine. Urine samples collected after exposure to aflatoxins were found to contain 2,3-dihydroxy-2-(N7-guanyl)-3-hydroxyaflatoxin B1, trivially known as **AFB-Gual**. Wild et al.(1986) used highly sensitive immunoassays to quantitate aflatoxins in human body fluids. An enzyme linked immunosorbent assay (ELISA) was used to quantitate aflatoxin B1 over the range of 0.01 ng/ml to 10 ng/ml, and was validated in human urine samples. Using this method, aflatoxin-DNA adduct excretion into urine was found to be positively correlated with dietary intake, and the major aflatoxin B1-DNA adduct excreted in urine was shown to be an appropriate dosimeter for monitoring aflatoxin dietary exposure.

[\[Top of Page\]](#) [\[Abstract\]](#) [\[Introduction\]](#) [\[Occurrence\]](#) [\[Factors favorizing aflatoxin production\]](#) [\[Aflatoxicosis and animal health\]](#) [\[Aflatoxins and human health\]](#) [\[Methods of analysis for aflatoxins\]](#) [\[Assessing human exposure to aflatoxins\]](#) [\[Control and management of aflatoxins\]](#) [\[Economic impact of aflatoxins\]](#) [\[References\]](#)

[Return to Cornell Toxic Agents List](#)

Control and Management of Aflatoxins

A- Regulatory Control :

Aflatoxins are considered unavoidable contaminants of food and feed, even where good manufacturing practices have been followed. The FDA has established specific guidelines on acceptable levels of aflatoxins in human food and animal feed by establishing action levels that allow for the removal of violative lots from commerce. [The action level](#) for human food is 20 ppb total aflatoxins, with the exception of milk which has an action level of 0.5 ppb for aflatoxin M1. The action level for most feeds is also 20 ppb. However, it is very difficult to accurately estimate aflatoxins concentration in a large quantity of material because of the variability associated with testing procedures; hence, the true aflatoxin concentration in a lot cannot be determined with 100% certainty.

B- Detoxification Strategies :

Because aflatoxin contamination is unavoidable, numerous strategies for their detoxification have been proposed. These include physical methods of separation, thermal inactivation, irradiation, solvent extraction, adsorption from solution, microbial inactivation, and fermentation. Chemical methods of detoxification are also practiced as a major strategy for effective detoxification :

- **Structural Degradation Following Chemical Treatment :**

A diverse group of chemicals has been tested for the ability to degrade and inactivate aflatoxins. A number of these chemicals can react to destroy (or degrade) aflatoxins effectively but most are impractical or potentially unsafe because of the formation of toxic residues or the perturbation of nutrient content and the organoleptic properties of the product. Two chemical approaches to the detoxification of aflatoxins that have received considerable attention are ammoniation and reaction with sodium bisulfite.

Many studies provide evidence that chemical treatment via ammoniation may provide an effective method to detoxify aflatoxin-contaminated corn and other commodities. The mechanism for this action appears to involve hydrolysis of the lactone ring and chemical conversion of the parent compound aflatoxin B1 to numerous products that exhibit greatly decreased toxicity.

On the other hand, sodium bisulfite has been shown to react with aflatoxins (B1, G1, and M1) under various conditions of temperature, concentration, and time to form water-soluble products.

- **Modification of Toxicity by Dietary Chemicals :**

The toxicity of mycotoxins may be strongly influenced by dietary chemicals that alter the normal responses of mammalian systems to these substances. A variable array of chemical factors, including nutritional components (e.g. dietary protein and fat, vitamins, and trace elements), food and feed additives (e.g. antibiotics and preservatives), as well as other chemical factors may interact with the effects of aflatoxins in animals.

- **Alteration of Bioavailability by Aflatoxin chemisorbents :**

A new approach to the detoxification of aflatoxins is the addition of inorganic sorbent materials, known as **chemisorbents**, such as hydrated sodium calcium aluminosilicate (HSCAS) to the diet of animals. HSCAS possesses the ability to tightly bind and immobilize aflatoxins in the gastrointestinal tract of animals, resulting in a major reduction in aflatoxin bioavailability.

[\[Top of Page\]](#) [\[Abstract\]](#) [\[Introduction\]](#) [\[Occurrence\]](#) [\[Factors favorizing aflatoxin production\]](#) [\[Aflatoxicosis and animal health\]](#) [\[Aflatoxins and human health\]](#) [\[Methods of analysis for aflatoxins\]](#) [\[Assessing human exposure to aflatoxins\]](#) [\[Control and management of aflatoxins\]](#) [\[Economic impact of aflatoxins\]](#) [\[References\]](#)

[Return to Cornell Toxic Agents List](#)

Economic Impact of Aflatoxins

[The economic impact](#) of aflatoxins derive directly from crop and livestock losses as well as indirectly from the cost of regulatory programs designed to reduce risks to animal and human health. The Food and Agriculture Organization (FAO) estimates that 25% of the world's food crops are affected by mycotoxins, of which the most notorious are aflatoxins. Aflatoxin losses to livestock and poultry producers from aflatoxin-contaminated feeds include death and the more subtle effects of immune system suppression, reduced growth rates, and losses in feed efficiency. Other adverse economic effects of aflatoxins include lower yields for food and fiber crops .

In addition, the ability of aflatoxins to cause cancer and related diseases in humans given their seemingly unavoidable occurrence in foods and feeds make the prevention and detoxification of these mycotoxins one of the most challenging toxicology issues of present time.

[\[Top of Page\]](#) [\[Abstract\]](#) [\[Introduction\]](#) [\[Occurence\]](#) [\[Factors favorizing aflatoxin production\]](#) [\[Aflatoxicosis and animal health\]](#) [\[Aflatoxins and human health\]](#) [\[Methods of analysis for aflatoxins\]](#) [\[Assessing human exposure to aflatoxins\]](#) [\[Control and management of aflatoxins\]](#) [\[Economic impact of aflatoxins\]](#) [\[References\]](#)

[Return to Cornell Toxic Agents List](#)

References

1. Anon.1989.**Mycotoxins , Economic and Health Risks.**Council for Agricultural science and Technology, Report No.116 pp91.
2. Eaton,D.L. and Groopman,J.D.1994.**The Toxicology of Aflatoxins.** Academic Press, New York.pp383-426.
3. Finley,J.W.,Robinson,S.F. and Armstrong ,D.J.1992.**Food Safety Assessment.** American Chemical Society,Washington ,D.C. pp261-275.
4. Goldbatt, L.A.1969.**Aflatoxin.**Academic Press,New York. pp1-40.

5. Heathcote, J.G. and Hibbert, J.R. 1978. **Aflatoxins : Chemical and biological aspect.** Elsevier, New York. pp.173-186.
6. Liener, I.E. 1969. **Toxin constituents of plant foodstuffs.** Academic Press, New York. pp.392-394.
7. Wyllie, T.D. and Morchause, L.G. 1978. **Mycotoxin Fungi, Mycotoxins, Mycotoxicoses-An Encyclopedic Handbook.** Vols. 1, 2, and 3. Marcel Dekker, Inc. New York.

[\[Top of Page\]](#) [\[Abstract\]](#) [\[Introduction\]](#) [\[Occurrence\]](#) [\[Factors favorizing aflatoxin production\]](#) [\[Aflatoxicosis and animal health\]](#) [\[Aflatoxins and human health\]](#) [\[Methods of analysis for aflatoxins\]](#) [\[Assessing human exposure to aflatoxins\]](#) [\[Control and management of aflatoxins\]](#) [\[Economic impact of aflatoxins\]](#) [\[References\]](#)

This series of web pages was created by Nabil Saad, an undergraduate student at Cornell University for the AS625 class. All comments and suggestions are welcome.

WARNING: These web pages are only meant to be informative. Neither Cornell University nor the author of this site endorse or recommend the use of these plants.

Return to: [Poisonous Plants Homepage](#)

Home page: [Animal Science at Cornell University](#)

For problems or comments on this web page, contact the Animal Science [Webmaster](#)

Trichothecenes

Trichothecenes are produced by several common molds including species in the genera *Acremonium* (*Cephalosporium*), *Cylindrocarpon*, *Dendrodochium*, *Myrothecium*, *Trichoderma*, *Trichothecium*, and most numerous in *Fusarium*. Trichothecenes are composed of a tetracyclic sesquiterpene skeleton containing a six-membered oxane ring, a stable epoxide group in positions 12 and 13 and a 9,10 olefinic bond. They have been classified into four groups. *Fusarium* spp. contain several well known trichothecenes including two highly toxic members of group A, diacetoxyscirpenol (DAS) and T-2 toxin, and toxins in group B including deoxynivalenol (DON) and nivalenol. DON is the most common but least toxic of these. Trichothecenes are strong inhibitors of protein synthesis in mammalian cells. However, DON received its common name, vomitoxin, from the vomiting that generally accompanies trichothecene poisoning. (D'Mello, et.al., 1991)

DON resulted in feed refusal in swine. In lambs, consumption of a wheat diet containing DON at 15.6 mg/kg of BW for 28 d did not alter feed consumption, weight gain, or feed efficiency. Oral administration of DON showed that it was rapidly passed essentially unchanged (95%) and excreted primarily in urine. Incubation of DON with ruminal microorganisms in vitro for 48 h resulted in partial conversion to deepoxy DON. These results indicate that the impact of DON on ruminants is lower than initially suspected. DON caused no organ damages to animals. Extremely low amounts of DON (<4ng/ml) were transmitted to milk after a single oral dose of 920 mg to a dairy cow. (Diekman and Green, 1992)

The FDA issued an "advisory" to federal and state officials recommending a level of concern for DON of 2 micrograms of DON/ gm for wheat entering the milling process, 1 microgram/ gm in finished wheat products for human consumption, and 4 microgram/ gm for wheat and wheat milling by-products used in animal feed. (Wood, 1992)

References

- Cheeke, P.R., (1995) Endogenous Toxins and Mycotoxins in Forage Grasses and Their Effects on Livestock. *J. Anim. Sci.* 73:909-918.
- Cheeke, P.R. and Shull, L.R. (1985) Mycotoxins (Chap. 12). In: Natural toxicants in feeds and poisonous plants. *AVI*. pp393-477.
- Chu, S.F., (1992) Recent Progress on Analytical Techniques for Mycotoxins in Feedstuffs. *J. Anim. Sci.* 70:3950-3963.

Diekman, M.A. and Green, M.L., (1992) Mycotoxins and Reproduction in Domestic Livestock. J. Anim. Sci. 70:1615-1627.

Flannigan, Brian, (1991) Mycotoxins (Chap. 10). In: Toxic Substances in Crop Plants. The Royal Society of Chemists.pp226-257.

Price, W.D., Lovell, R.A. and McChesney, D.G., (1993) Naturally Occurring Toxins in Feedstuffs: Center for Veterinary Medicine Perspective. J. Anim. Sci. 71:2556-2562.

Richard, J.L., Bennett, G.A., Ross, P.F. and Nelson, P.E., (1993) Analysis of Naturally Occurring Mycotoxins in Feedstuffs and Food. J. Anim. Sci. 71:2563-2574.

Spainhour, C.B. and Posey, D. (1992) Mycotoxins: A Silent Enemy. Large Animal Veterinarian. Nov./Dec. Page 20-25.

Thompson, Larry. (1996) Lecture for PLPA 652 ('Mycotoxins')

Wood, G.E., (1992) Mycotoxins in Foods and Feeds in the United States. J. Anim. Sci. 70:3941-3949.

Wren, G., (1994) Blaming Mycotoxins Can Be A Risky Venture. Bovine Veterinarian. Nov. Page 4 -10.

More information on FDA recommendations [The poisonous plant database](#)

This series of web pages was created by Yuan-Kuo Chen, an undergraduate student at Cornell University for the AS625 class. All comments and suggestions are welcome.

WARNING: These web pages are only meant to be informative. Neither Cornell University nor the author of this site endorse or recommend the use of these plants.

Return to: [Poisonous Plants Homepage](#)

Home page: [Animal Science at Cornell University](#)

For problems or comments on this web page, contact the Animal Science [Webmaster](#)

Zearalenone

Mycotoxins produced by *Fusarium* spp. are of two general types: 1) the nonestrogenic trichothecenes, including DON, nivalenol, T-2 toxin, and diacetoxyscripenol, and 2) the mycoestrogens, including Zearalenone (ZEN) and zearalenol. Zearalenone and zearalenol are both estrogenic resorcylic acid lactone compounds produced by the fungi *Fusarium* spp. (Diekman and Green, 1992)

Despite their structural dissimilarity to the steroidal estrogens, ZEN and several of its derivatives possess **estrogenic activity**. ZEN undergoes a folding such that hydroxyl or potential hydroxyl groups become appropriately orientated to facilitate binding to tissue receptors that normally bind estrogens. Similar binding affinities for ZEN have been determined for the estrogen receptor in sheep and calf uterus. (Diekman and Green, 1992)

Poultry show little reaction to ZEN ingestion. However, **swine** are strongly affected with symptoms in prepubertal gilts including enlarged mammae, swelling of uterus and vulva, and atrophy of the ovaries. In severe cases, prolapse of the vulva and rectum may occur. Boars exhibit enlarged mammae and atrophied testes. (Flannigan, 1991)

Although **cattle** are not as sensitive to ZEN as swine, a few experiments have been done to determine whether ZEN affects performance of cattle. Infertility, reduced milk production, and hyperestrogenism in cows have been reported in association with ZEN. Hay containing 14 ppm of ZEN caused infertility in cattle. Holstein cows that consumed 25 to 200 ppm of ZEN for 42 consecutive days exhibited swollen and hyperemic external genitalia but had estrous cycles of normal lengths and normal ovulations. Enlarged mammary glands that exhibited secretory activity were reported in prepubertal heifers that consumed moldy corn with ZEN. Dairy cattle fed a ration that contained 385 to 1925 ppb of ZEN for 7 weeks had normal milk production. No ZEN residues were found in milk, urine, serum or tissues. Corn that contained 500 ppb of ZEN had no effect on milk or butterfat production. (Diekman and Green, 1992)

Virgin dairy heifers fed 250mg of purified ZEN for three estrous cycles had an average conception rate of 62%, compared with 87% in control heifers. Nonlactating, nonpregnant dairy cows given 500 mg of ZEN daily for two estrous cycles had normal serum concentration of progesterone, normal mating behavior, and normal genital tracts. (Diekman and Green, 1992)

In vivo studies have revealed that ZEN is rapidly metabolized in animals and humans and eliminated mainly as water-soluble glucuronides. Free and conjugated forms of ZEN have been found in the milk of lactating cows under experimental conditions. That high oral doses of the toxin are required to elicit such a response indicates that consumption of

contaminated feed by dairy cows would not result in a health hazard to humans.(Wood, 1992)

References

Cheeke, P.R., (1995) Endogenous Toxins and Mycotoxins in Forage Grasses and Their Effects on Livestock. *J. Anim. Sci.* 73:909-918.

Cheeke, P.R. and Shull, L.R. (1985) Mycotoxins (Chap. 12). In: Natural toxicants in feeds and poisonous plants. *AVI.* pp393-477.

Chu, S.F., (1992) Recent Progress on Analytical Techniques for Mycotoxins in Feedstuffs. *J. Anim. Sci.* 70:3950-3963.

Diekman, M.A. and Green, M.L., (1992) Mycotoxins and Reproduction in Domestic Livestock. *J. Anim. Sci.* 70:1615-1627.

Flannigan, Brian, (1991) Mycotoxins (Chap. 10). In: Toxic Substances in Crop Plants. The Royal Society of Chemists.pp226-257.

Price, W.D., Lovell, R.A. and McChesney, D.G., (1993) Naturally Occurring Toxins in Feedstuffs: Center for Veterinary Medicine Perspective. *J. Anim. Sci.* 71:2556-2562.

Richard, J.L., Bennett, G.A., Ross, P.F. and Nelson, P.E., (1993) Analysis of Naturally Occurring Mycotoxins in Feedstuffs and Food. *J. Anim. Sci.* 71:2563-2574.

Spainhour, C.B. and Posey, D. (1992) Mycotoxins: A Silent Enemy. *Large Animal Veterinarian.* Nov./Dec. Page 20-25.

Thompson, Larry. (1996) Lecture for PLPA 652 ('Mycotoxins')

Wood, G.E., (1992) Mycotoxins in Foods and Feeds in the United States. *J. Anim. Sci.* 70:3941-3949.

Wren, G., (1994) Blaming Mycotoxins Can Be A Risky Venture. *Bovine Veterinarian.* Nov. Page 4 -10.

More Information on FDA Recommendations [The poisonous plant database](#)

This series of web pages was created by Yuan-Kuo Chen, an undergraduate student at Cornell University for the AS625 class. All comments and suggestions are welcome.

WARNING: These web pages are only meant to be informative. Neither Cornell University nor the author of this site endorse or recommend the use of these plants.

Return to: [Poisonous Plants Homepage](#)

Home page: [Animal Science at Cornell University](#)

For problems or comments on this web page, contact the Animal Science [Webmaster](#)

Phenolic Compounds

In ruminant animals, the release of phenolic monomers during microbial degradation of high fiber diets may inhibit the growth rate of certain bacteria and decrease cellulose digestion.

This series of web pages was created by Manuel Hernandez, an undergraduate student at Cornell University for the AS625 class. All comments and suggestions are welcome.

WARNING: These web pages are only meant to be informative. Neither Cornell University nor the author of this site endorse or recommend the use of these plants.

Return to: [Poisonous Plants Homepage](#)

Home page: [Animal Science at Cornell University](#)

For problems or comments on this web page, contact the Animal Science [Webmaster](#)

Tannins: fascinating but sometimes dangerous molecules



Welcome to the Tannin home page. We offer a variety of information on tannins including, but not limited to, their biosynthesis, chemical structures, toxicology, positive effects, chemical analysis....

Tannins are naturally occurring **plant polyphenols**. Their main characteristic is that they **bind and precipitate proteins**. They can have a large influence on the nutritive value of many foods eaten by humans and feedstuff eaten by animals. Tannins are common in fruits (grapes, persimmon, blueberry...), in tea, in chocolate, in legume forages (trefoil..), in legume trees (*Acacia* spp., *Sesbania* spp., ...), in grasses (sorghum, corn ...).

Tannins contribute to many aspects of our daily lives. They are responsible for the **astrigent taste we experience when we partake of** wine or unripe fruits, and for the enchanting colors seen in flowers and in autumn leaves.

For more information on tannins explore the following topics:

- [Definition](#)
- [Occurrence](#)
- [Biosynthesis](#)
- [Chemical structure](#)
- [Interaction with other macromolecules](#)
- Nutritional effects:
 - [Toxic and antinutritional effects](#)
 - [Positive effects](#)
- [Chemical analysis](#)
- [References](#)



This series of web pages was created by an undergraduate student at Cornell University for the AS625 class. All comments and suggestions are welcome.

WARNING: These web pages are only meant to be informative. Neither Cornell University nor the author of this site endorse or recommend the use of these plants.

Return to: [\[List of Toxic Agents\]](#) [\[Poisonous Plants Homepage\]](#)

Home page: [Animal Science at Cornell University](#)

For problems or comments on this web page, contact the Animal Science [Webmaster](#)

THIAMINASES

Thiaminases are enzymes found in a few plants and the raw flesh and viscera of certain fish and shellfish. When ingested these enzymes split thiamin (Vitamin B1), an important compound in energy metabolism, and render it inactive. The following pages detail how thiaminases work metabolically, where they are found, and the effect their ingestion can have on livestock and humans.

Index

- [On overview of thiamin metabolism](#)
- [Thiaminases - definition and mechanisms of action](#)
- Signs/symptoms of thiamin deficiency in:
 - [Non-ruminants \(including humans\)](#)
 - [Ruminants](#)
- Sources of thiaminase:
 - [Bracken fern \(*Pteridium aquilinum*\)](#)
 - [Horsetails \(*Equisetum arvense*\)](#)
 - [Other sources](#)
 - Nardoo (*Marsilea drummondii*)
 - Fish and shellfish
 - Rock fern (*Cheilanthes sieberi*)
 - Kochia (*Kochia scoparia*)
 - Bacteria
- [Treatment of thiaminase poisoning](#)
- [A story of Australian explorers, or why you should cook your ferns.](#)

Other toxicology pages:

- [Canadian Poisonous Plants Information System.](#)
-

An Overview of Thiamin Metabolism

This is thiamin:

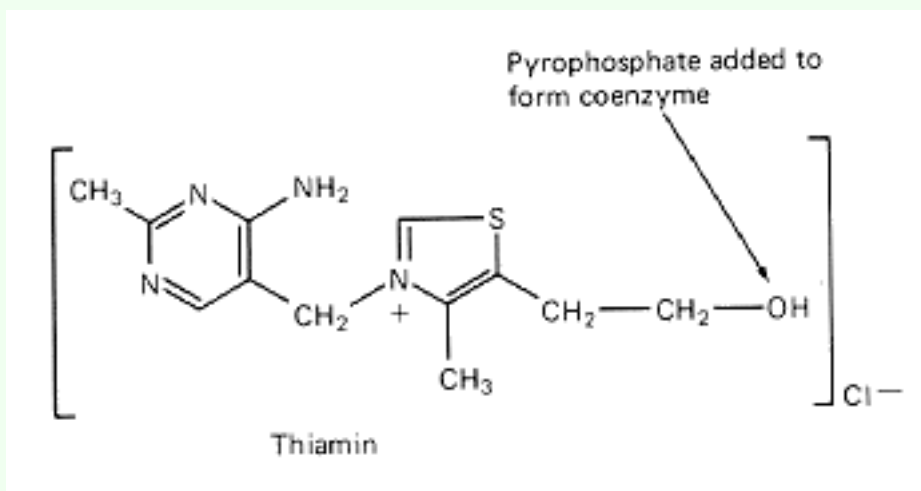

This is what thiamin does:

The active form of thiamin - thiamin pyrophosphate (TPP) works as a coenzyme in the following important reactions:

1. The conversion of pyruvate to acetyl-CoA catalyzed by pyruvate dehydrogenase.
2. The conversion of alpha-ketoglutarate to succinyl-CoA in the TCA cycle catalyzed by alpha-ketoglutarate dehydrogenase.
3. The conversion of branched-chain alpha-keto acids to acyl-CoA's catalyzed by branched-chain alpha-ketoacid dehydrogenase.
4. The transfer of a 2C fragment from alpha-keto sugars to aldose acceptors in the pentose-phosphate shunt catalyzed by transketolase.

It should be obvious from the above that thiamin is an essential component of energy metabolism. Without sufficient thiamin, animals have impaired pyruvate utilization, causing increased plasma pyruvate levels and a shortage of cellular ATP. Thiamin deficient animals also have below normal transketolase activity, and therefore a good test of thiamin status is to test the amount of erythrocyte transketolase activity an animal exhibits. Because thiamin is so essential to energy utilization, general signs of thiamin deficiency include weight loss, impaired feed utilization, and weakness. More deficiency signs are detailed in the pages under Signs/Symptoms of Thiamin Deficiency.

Some thiamin is also used to form thiamin triphosphate which is thought to have a function in brain cell viability, though its exact role is still unclear.

Natural sources of thiamin include yeasts, meats (especially pork liver), and whole cereal grains. Unfortunately, processing of grains greatly reduces their thiamin content. Thiamin is absorbed through the intestinal wall by both passive diffusion and active, carrier-mediated transport depending on the concentration present. Active transport is highest in the jejunum and ileum, therefore lower gut fermentors that are not coprophagous absorb little of the thiamin produced by intestinal microflora. Ruminants generally have their thiamin needs met by the thiamin production of the rumen microflora. Once absorbed, thiamin is transported in the

serum chiefly bound to albumin.

[Back to Index](#)

Thiaminases - Definition and Mechanism of Action

Thiaminases are enzymes that cleave the thiamin molecule and render it biologically inactive. Generally there are two types of thiaminases:

- **Type I** - the most common form, this type is found in fish, shellfish, ferns and some bacteria. It acts by displacing the pyrimidine methylene group with a nitrogenous base or SH-compound to eliminate the thiazole ring.
- **Type II** - found in certain bacteria, this type acts through the hydrolytic cleavage of the methylene-thiazole-N bond to yield pyrimidine and thiamin moieties.

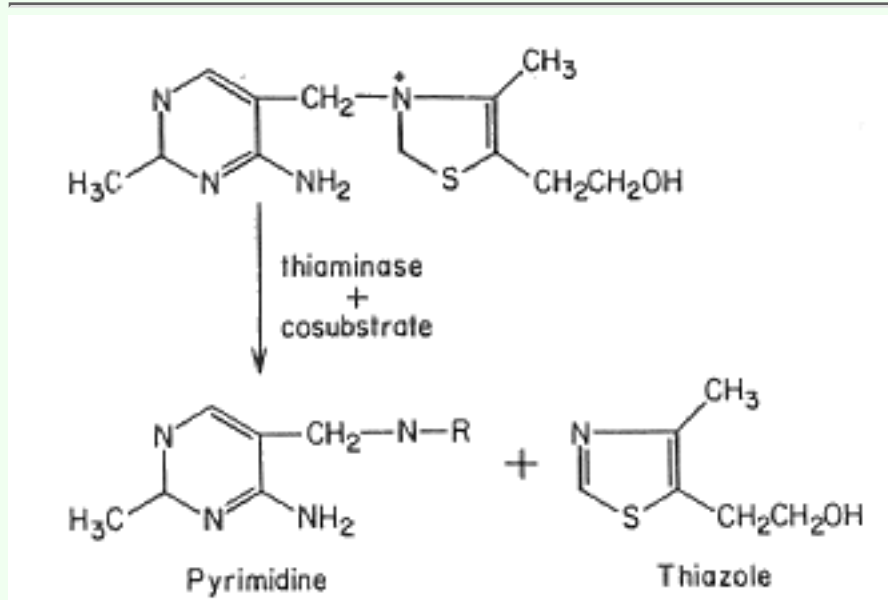

Both types of thiabinase require a cosubstrate - usually an amine or sulfhydryl-containing compound such as proline or cysteine. Once the thiamin molecule is cleaved by a thiabinase the body is incapable of restoring it. Thus, the ingestion of significant amounts of thiabinases can induce thiamin deficiency even though there may be a sufficient amount of thiamin in the diet.

Thiabinases are denatured by heat, therefore subjecting any of the sources of thiabinases to cooking or other heat treatment will render the thiabinases inactive.

[Back to Index](#)

Signs of thiamin deficiency in non-ruminants.

Because they are unable to fully utilize the energy in their diet, thiamin-deficient non-ruminants will exhibit severe anorexia which will, of course, be accompanied by weight loss and weakness. Such animals will also typically show neurological disfunction to a greater or lesser degree including ataxia and convulsions. Some species, especially birds, will exhibit opisthotonus - a retraction of the head sometimes referred to as "star-gazing". Thiamin deficiency will also cause cardiac disfunction in some species. Symptoms of this include cardiac enlargement and a slowed heart rate. Further heart failure can lead to severe cases of edema.

The following photo shows cardiac enlargement in a pig. On the left is the heart of a normal pig, the heart on the right is of a thiamin-deficient pig.

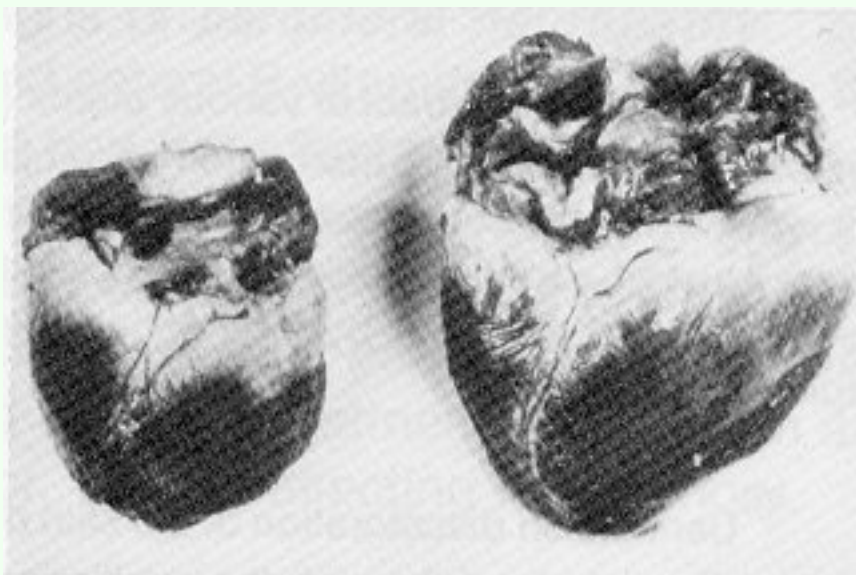

In humans thiamin deficiency leads to a disease termed "beri-beri". Symptoms of beri-beri are basically the same as thiamin deficiency in other non-ruminants - anorexia, cardiac enlargement, and muscular weakness leading to ataxia. However, the disease has been divided into the following two forms:

- **Dry beri-beri** - usually without cardiac involvement, this form of the disease is typified by atrophy of the legs and peripheral neuritis. It occurs mainly in adults.
- **Wet beri-beri** - the primary sign of this form of the disease is cardiac enlargement and edema.

[Back to Index](#)

Signs/Symptoms of thiamin deficiency in ruminants

Thiamin deficiency in ruminants manifests itself as polioencephalomalacia. Signs of polioencephalomalacia include disorientation and wandering, blindness and opisthotonus or retraction of the head. The brain of infected animals becomes inflamed and edematous. Ruminants will also show symptoms as seen in other animals - anorexia, poor feed utilization and weakness.

Normally ruminants are fairly resistant to thiamin deficiency since rumen microbes provide the animal with sufficient amounts of thiamin. However, the ingestion of thiabinases will lead to polioencephalomalacia. Additionally, young growing ruminants, especially cattle and sheep, fed high-grain diets are especially susceptible. Diets high in grains can encourage the growth of certain thiaminase-producing bacteria in the rumen. These bacteria, including *Clostridium sporogenes* and a few species of *Bascillus* can produce enough thiabinases to induce thiamin deficiency.

A sheep with polioencephalomalacia:

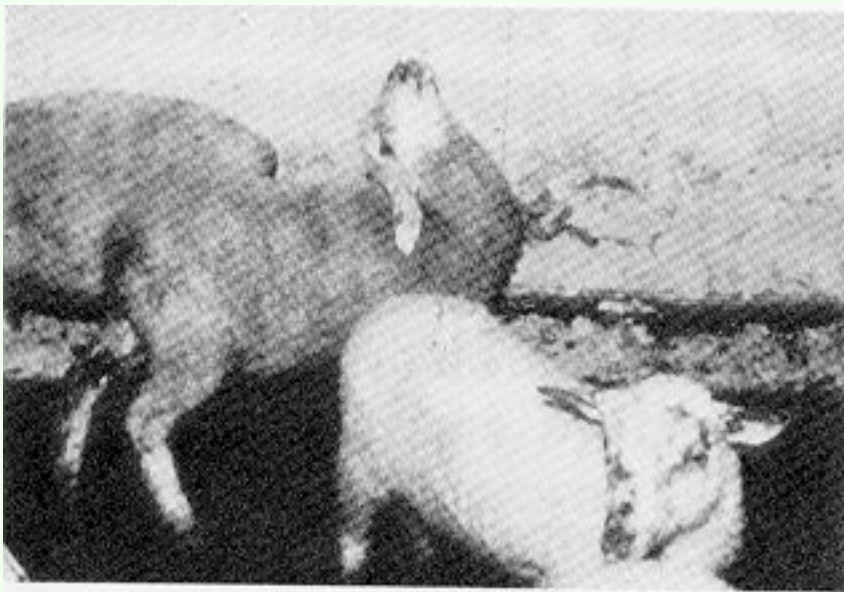

[Back to Index](#)

Bracken Fern (*Pteridium aquilinum*)



Bracken fern is widespread in humid temperate areas including the North American West Coast, Europe, Japan, Australia, and New Zealand. The highest thiaminase activity is in the rhizomes, but all areas of the plant contain some thiaminase and show seasonal variability as follows:

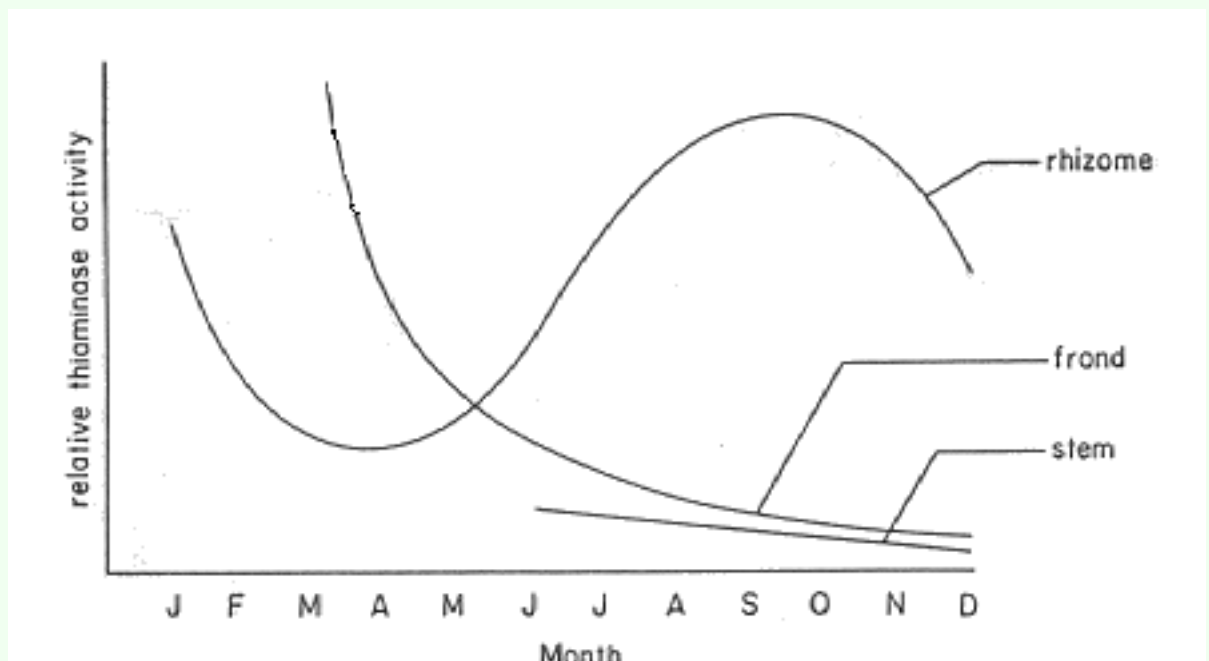

The most common instances of bracken poisoning in livestock occur during one of the following scenarios:

1. In the spring - when bracken fern is one of the first plants to emerge and therefore potentially a major component of the pasture.
2. In animals kept on very lush pastures that may select bracken fern for its fiber content.
3. Bracken fern contamination in hay.
4. In fields where plowing has exposed the rhizomes.
5. Bracken fern used as bedding.

Non-ruminants consuming significant amounts of bracken fern in their diet will

exhibit signs of thiamin deficiency. Horses fed hay with greater than twenty percent bracken fern will begin to be symptomatic within a month.

[Back to Index](#)

Horsetails (*Equisetum arvense*)



Horsetails are widespread in moist areas of the United States and Canada and contain significant thiamin activity. The most common instance of thiaminase poisoning resulting from horsetails is the contamination of hay with horsetails. A horse consuming hay containing twenty percent or more of horsetail plants will show signs of thiamin deficiency in two to five weeks



[Back to Index](#)

Other sources

Nardoo (*Marsilea drummondii*)

Nardoo is an Australian fern that can contain thiaminase activity up to one hundred times that of bracken fern. Nardoo will often grow in areas that have recently flooded, and is responsible for a large number of cases of thiamin deficiency and death in sheep in Australia and New Zealand.

Fish and Shellfish

Thiaminases are present in the viscera of certain raw fishes and shellfishes, especially carp. Humans, even sushi lovers, rarely eat enough raw fish in their diet to constitute a problem. However, thiaminase induced thiamin deficiency has been seen in mink and foxes fed large amounts of raw fish in their diet. Termed Chastek's paralysis, after the fox farmer who first documented the disease, thiamin deficiency in these animals follows the same path as outlined above.

Rock Fern (*Cheilanthes sieberi*)

Another Australian fern, found mainly on the coast, rock fern also has a high level of thiaminase activity.

Kochia (*Kochia scoparia*)

Kochia, also termed summer cypress and fireweed grows mainly in desert regions of the south-western United States. Ruminants grazing on kochia have developed polyencephalomalacia, however it is unclear whether this effect is due to the presence of a thiaminase or a hepatotoxin which interferes with thiamin utilization. Infected animals also exhibit liver necrosis, which suggests a hepatotoxin as the main factor in kochia poisoning. If a thiaminase exists, it is probably not a dominant factor.

Bacteria

As stated in the page on thiamin deficiency in ruminants, it is known that certain species of bacteria are capable of producing thiaminases. *Clostridium sporogenes* and a few species of *Bacillus* are thought to be the main culprits. If these species dominate in the rumen environment, thiamin

deficiency can result. Feeding high grain diets favors the growth of these species, and young ruminants, age two to seven months, are at greatest risk.

[Back to Index](#)

Treatment of Thiainase Poisoning

Animals suffering from thiamin deficiency due to the ingestion of thiainases generally respond very well to treatment if caught early. Intra-muscular of injections of thiamin, and removing the source of the thiainase from the animal's diet, are usually sufficient to bring around full recovery. Doses of 100-500 mg of thiamin for sheep and 200-500 mg for calves, depending on body weight are sufficient.

[Back to Index](#)

The story of Australian explorers, or why you should cook your ferns.

Okay, so legend has it, and so does Moorehead's book *Cooper's Creek* (1963), that a couple of Australian explorers, Robert Burke and William Wills, died in 1861 from thiainase poisoning. They were wandering around the Australian continent, doing what explorers do, and their supply of pork which was their main source of thiamin ran out. So what did these guys start feasting on? Nardoo, of course. Now, if they had watched the Aborigines they would have known that one does not eat nardoo without cooking it first. But, being typical explorers, and thus thinking that they were smarter than the indigenous people that had lived on the continent for thousands of years, Burke and Wills ate their nardoo raw. They began complaining in their journals of increasing weakness and starvation, but "not so much from absolute want of food" because, Wills wrote, "I have a good appetite and relish the nardoo much but it seems to give us no nutriment." What they were suffering from then, was thiamin deficiency. Coupling a low-thiamin diet with a large intake of thiainases from the nardoo, Burke and Wills developed beri-beri. They complained not only of weakness, but of edema too, and sensitivity to cold. They died.

The moral of the story? Cook your ferns before you eat them, and maybe throw a little pork in your diet too.

[Back to Top](#)

This series of web pages was created by an undergraduate student at Cornell University for the AS625 class. All comments and suggestions are welcome.

WARNING: These web pages are only meant to be informative. Neither Cornell University nor the author of this site endorse or recommend the use of these plants.

Return to:

[Return to Toxic Agents List](#)

[Poisonous Plants Homepage](#)

Home page: [Animal Science at Cornell University](#)

For problems or comments on this web page, contact the Animal Science [Webmaster](#)

PLANT LECTINS

- [INTRODUCTION](#)
- [LECTINS IN FOODS](#)
- [FUNCTIONS OF LECTINS](#)
- [LECTINS STRUCTURE](#)
- [LECTINS IN PLANT TISSUES](#)
- TOXICITY OF LECTINS
- [DETOXIFICATION](#)
- [LECTINS AND CANCER](#)

INTRODUCTION



The high toxicity of castor beans was recognized during the last century when the extract was found to agglutinate a suspension of erythrocytes of different animal species. Since then, lectins were studied and extracted from plants, including fungus and lichens, as well as in animals.

Lectins are glycoproteins of 60,000-100,000 MW that are known for their ability to agglutinate (clump) erythrocytes in vitro. There are over 400,000 estimated binding sites for kidney bean agglutinin on the surface of each erythrocytes. Lectins are found in most types of beans, including soybeans. Reduced growth, diarrhea, and interference with nutrient absorption are caused by this class of toxicants. Different lectins have different levels of toxicity, though not all lectins are toxic, though no all are toxins. The bright

scarlet seeds of precatory bean



Abrus precatorius contain the highly toxic glycoprotein, abrin. Less toxic lectins can be fatal if ingested in high amounts. Some of such lectins is concanavalin A from *Concanavalia ensiformis* (jack bean). Others may exhibit no hemagglutinating activity as in the case of ricin from castor bean and yet it is one of the most toxic substances.

The terms phytohemagglutinins, phytagglutinins, and lectins are used interchangeably. Lectins-containing plants have been found in many botanical groups including mono- and dicotyledons, molds and lichens, but most frequently they have been detected in Leguminosae and Euphorbiaceae. They may exist in various tissues of the same plant and have different cellular localizations and molecular properties.

Lectins interaction with certain carbohydrate is very specific. This interaction is as specific as the enzyme-substrate, or antigen-antibody interactions. Lectins may bind with free sugar or with sugar residues of polysaccharides, glycoproteins, or glycolipids which can be free or bound (as in cell membranes). The term lectin refers to the specificity of the reaction (legere = to choose).

One of the major interest in this class of glycoproteins is the therapeutic use against HIV-1. Jacalin, a plant lectin, is found to completely block human immunodeficiency virus type 1 in vitro infection of lymphoid cells. This activity of the jacalin is attributed to its ability to specifically induce the proliferation of CD4+ T lymphocytes in human.

NACHREAR AND CONSIDERATIONS

Measurements of lectin activity in other edible plants

Plant	Lectin name	Reference	Comments
Alfalfa	Concanavalin A	(19)	Measurable only in dried alfalfa leaves
Alfalfa	Concanavalin B	(19)	Measurable only in dried alfalfa leaves
Alfalfa	Phaseolin	(20)	Measurable only in dried alfalfa leaves
Alfalfa	Phaseolin	(21)	Measurable only in dried alfalfa leaves
Alfalfa	Phaseolin	(22)	Measurable only in dried alfalfa leaves
Alfalfa	Phaseolin	(23)	Measurable only in dried alfalfa leaves
Alfalfa	Phaseolin	(24)	Measurable only in dried alfalfa leaves
Alfalfa	Phaseolin	(25)	Measurable only in dried alfalfa leaves
Alfalfa	Phaseolin	(26)	Measurable only in dried alfalfa leaves
Alfalfa	Phaseolin	(27)	Measurable only in dried alfalfa leaves
Alfalfa	Phaseolin	(28)	Measurable only in dried alfalfa leaves
Alfalfa	Phaseolin	(29)	Measurable only in dried alfalfa leaves
Alfalfa	Phaseolin	(30)	Measurable only in dried alfalfa leaves
Alfalfa	Phaseolin	(31)	Measurable only in dried alfalfa leaves
Alfalfa	Phaseolin	(32)	Measurable only in dried alfalfa leaves
Alfalfa	Phaseolin	(33)	Measurable only in dried alfalfa leaves
Alfalfa	Phaseolin	(34)	Measurable only in dried alfalfa leaves
Alfalfa	Phaseolin	(35)	Measurable only in dried alfalfa leaves
Alfalfa	Phaseolin	(36)	Measurable only in dried alfalfa leaves
Alfalfa	Phaseolin	(37)	Measurable only in dried alfalfa leaves
Alfalfa	Phaseolin	(38)	Measurable only in dried alfalfa leaves
Alfalfa	Phaseolin	(39)	Measurable only in dried alfalfa leaves
Alfalfa	Phaseolin	(40)	Measurable only in dried alfalfa leaves
Alfalfa	Phaseolin	(41)	Measurable only in dried alfalfa leaves
Alfalfa	Phaseolin	(42)	Measurable only in dried alfalfa leaves
Alfalfa	Phaseolin	(43)	Measurable only in dried alfalfa leaves
Alfalfa	Phaseolin	(44)	Measurable only in dried alfalfa leaves
Alfalfa	Phaseolin	(45)	Measurable only in dried alfalfa leaves
Alfalfa	Phaseolin	(46)	Measurable only in dried alfalfa leaves
Alfalfa	Phaseolin	(47)	Measurable only in dried alfalfa leaves
Alfalfa	Phaseolin	(48)	Measurable only in dried alfalfa leaves
Alfalfa	Phaseolin	(49)	Measurable only in dried alfalfa leaves
Alfalfa	Phaseolin	(50)	Measurable only in dried alfalfa leaves
Alfalfa	Phaseolin	(51)	Measurable only in dried alfalfa leaves
Alfalfa	Phaseolin	(52)	Measurable only in dried alfalfa leaves
Alfalfa	Phaseolin	(53)	Measurable only in dried alfalfa leaves
Alfalfa	Phaseolin	(54)	Measurable only in dried alfalfa leaves
Alfalfa	Phaseolin	(55)	Measurable only in dried alfalfa leaves
Alfalfa	Phaseolin	(56)	Measurable only in dried alfalfa leaves
Alfalfa	Phaseolin	(57)	Measurable only in dried alfalfa leaves
Alfalfa	Phaseolin	(58)	Measurable only in dried alfalfa leaves
Alfalfa	Phaseolin	(59)	Measurable only in dried alfalfa leaves
Alfalfa	Phaseolin	(60)	Measurable only in dried alfalfa leaves
Alfalfa	Phaseolin	(61)	Measurable only in dried alfalfa leaves
Alfalfa	Phaseolin	(62)	Measurable only in dried alfalfa leaves
Alfalfa	Phaseolin	(63)	Measurable only in dried alfalfa leaves
Alfalfa	Phaseolin	(64)	Measurable only in dried alfalfa leaves
Alfalfa	Phaseolin	(65)	Measurable only in dried alfalfa leaves
Alfalfa	Phaseolin	(66)	Measurable only in dried alfalfa leaves
Alfalfa	Phaseolin	(67)	Measurable only in dried alfalfa leaves
Alfalfa	Phaseolin	(68)	Measurable only in dried alfalfa leaves
Alfalfa	Phaseolin	(69)	Measurable only in dried alfalfa leaves
Alfalfa	Phaseolin	(70)	Measurable only in dried alfalfa leaves
Alfalfa	Phaseolin	(71)	Measurable only in dried alfalfa leaves
Alfalfa	Phaseolin	(72)	Measurable only in dried alfalfa leaves
Alfalfa	Phaseolin	(73)	Measurable only in dried alfalfa leaves
Alfalfa	Phaseolin	(74)	Measurable only in dried alfalfa leaves
Alfalfa	Phaseolin	(75)	Measurable only in dried alfalfa leaves
Alfalfa	Phaseolin	(76)	Measurable only in dried alfalfa leaves
Alfalfa	Phaseolin	(77)	Measurable only in dried alfalfa leaves
Alfalfa	Phaseolin	(78)	Measurable only in dried alfalfa leaves
Alfalfa	Phaseolin	(79)	Measurable only in dried alfalfa leaves
Alfalfa	Phaseolin	(80)	Measurable only in dried alfalfa leaves
Alfalfa	Phaseolin	(81)	Measurable only in dried alfalfa leaves
Alfalfa	Phaseolin	(82)	Measurable only in dried alfalfa leaves
Alfalfa	Phaseolin	(83)	Measurable only in dried alfalfa leaves
Alfalfa	Phaseolin	(84)	Measurable only in dried alfalfa leaves
Alfalfa	Phaseolin	(85)	Measurable only in dried alfalfa leaves
Alfalfa	Phaseolin	(86)	Measurable only in dried alfalfa leaves
Alfalfa	Phaseolin	(87)	Measurable only in dried alfalfa leaves
Alfalfa	Phaseolin	(88)	Measurable only in dried alfalfa leaves
Alfalfa	Phaseolin	(89)	Measurable only in dried alfalfa leaves
Alfalfa	Phaseolin	(90)	Measurable only in dried alfalfa leaves
Alfalfa	Phaseolin	(91)	Measurable only in dried alfalfa leaves
Alfalfa	Phaseolin	(92)	Measurable only in dried alfalfa leaves
Alfalfa	Phaseolin	(93)	Measurable only in dried alfalfa leaves
Alfalfa	Phaseolin	(94)	Measurable only in dried alfalfa leaves
Alfalfa	Phaseolin	(95)	Measurable only in dried alfalfa leaves
Alfalfa	Phaseolin	(96)	Measurable only in dried alfalfa leaves
Alfalfa	Phaseolin	(97)	Measurable only in dried alfalfa leaves
Alfalfa	Phaseolin	(98)	Measurable only in dried alfalfa leaves
Alfalfa	Phaseolin	(99)	Measurable only in dried alfalfa leaves
Alfalfa	Phaseolin	(100)	Measurable only in dried alfalfa leaves

A survey of the fresh and

processed foods found lectins in about 30% of the food stuffs tested, including such common foods as salad, fruits, spices, dry cereals, and roasted nuts. However, dry heat may not completely destroy lectin activity. Hemagglutinating activity is found in the processed wheatgerm, peanuts, and dry cereals. Several lectins are resistant to proteolytic digestion e.g., wheatgerm agglutinin, tomato, lectin, and navy bean lectin.

FUNCTIONS OF LECTINS

Not much is known about the functions of lectins in the organism they are formed. There is evidence that lectins may be involve in the recognition between cells or cells and various carbohydrate- containing molecules. This suggests that they may be involved in the regulating physiological functions. They seem to play an important role in the defence mechanisms of plants against the attack of microorganisms, pests, and insects. Fungal infection or wounding of the plant seems to increase lectins. In legumes, the role of lectins in the recognition of nitrogen-fixing bacteria Rhizobium genus, which have sugar-containing substances, has received a special attention.

Binding Nitrogen-Fixing Bacteria to legume Roots: among the possible functions of plant lectins is their participation in binding nitrogen-fixing bacteria to legume roots. In this reaction bacteria of the genus Rhizobium adhere to the surface of differentiated roots

cells and are then internalized into the root hair to form nitrogen-fixing nodules. The symbiosis is specific in that certain species of *Rhizobium* can only associate with a particular species of legume. Such observations were made from the studies that were done on soybean *Rhizobium japonicum* and the clover *Rhizobium trifolii*. Other functions of lectins in plants may include:

- Enzymes (but unknown substrate)
- Storage of proteins
- Defense mechanism
- Cell wall extension
- Mitogenic stimulation
- Transport of carbohydrates
- Packaging and/or mobilization of storage materials

LECTINS STRUCTURE

One major property of lectins is their specific saccharide- binding sites. Some lectins are composed of subunits with different binding sites. These include the lectin from the red kidney bean, *Phaseolus vulgaris*. It is composed of two different subunits combined into five different forms of noncovalently bound tetramers. Since subunits have very different specificities for cell surface receptors, each combination is considered to have a different function. The specificity of the binding sites of the lectins suggest that there are endogenous saccharide receptors in the tissues from which they are derived or on other cells or glycoconjugates with which the lectin is specialized to interact.

Metal Binding Sites

Biological activity of the lectins may be attributed to the metal ions which are the essential part of the native structure of most leguminous lectins. The most studied and fully sequenced lectin is concanavalin A. The metal binding sites of the concanavalin A are situated in the amino terminal part of the polypeptide chain. In this lectin, each subunit has aspartic 10 and 19, asparagine 14, histidine 24, serine 34, glutamic acid 8, and tyrosine 12 that are involved in the binding to one calcium and one magnesium ion.

Lectins of soybean, peas, faba bean, lentils, and sainfoin have amino acids that are involved in metal binding, which are conserved. The exception is of the tyrosine residue at position 12 of concanavalin A which is replaced with by phenylalanine in the other legume lectins.

Hydrophobic Sites

The stability of the native structure of most lectins is thought to be caused by the hydrophobic interactions. Such hydrophobic sites, forming cavities in the lectins structure, may play an important biological role. The hydrophobic binding sites of auxins, or

cytokinin and adenine, for instance, by concanavalin A may enhance the functions of lectins on the plant life cycle.

Glycosylation Sites

Despite the generalization that most lectins are considered glycoproteins, concanavalin A, lentils lectin, and wheatgerm agglutinin contain no covalently attached carbohydrates. However, non-glycoprotein lectins are believed to be synthesized as glycosylated precursors. This is supported by the following observation:

- 1) pro-concanavalin A is an inactive glycoprotein from which the glycosidic side chain is removed during post-translational processing.
- 2) Non-glycoprotein wheatgerm agglutinin molecules are produced by removing a carboxyl terminal glycopeptide from the glycosylated precursor during post-translational processing.

All glycoprotein lectins contain a peptide sequence: asparagine- X-threonine/serine, which is characteristic of glycosylation sites. These sequences are different in the non-glycoprotein lectins. Also, peptide sequences, which in one glycoprotein lectin contain the glycosidic side-chains, are not necessarily conserved in another glycoprotein lectin. This may suggest that the biological activity of the lectins may not be determined by carbohydrate part of their structure.

Carbohydrate Binding Sites

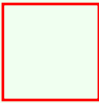
Lectins differ markedly in their  sugar-binding specificity. A sequence participating in carbohydrate-binding site of concanavalin A, for instance, are poorly conserved in other lectins.

Three Dimensional Structure

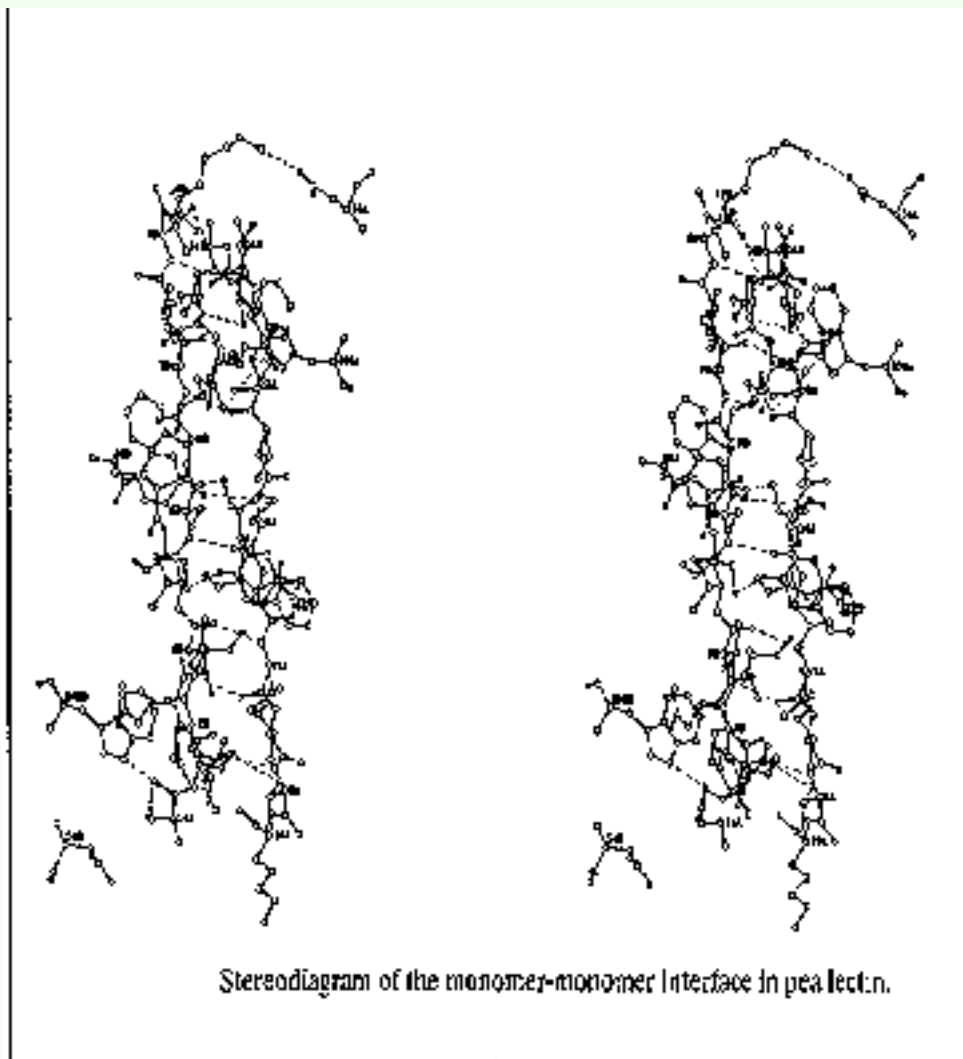

The three dimensional structures of lectins can be used to show the structural similarities and homologies of legume lectins. When the secondary structure of Viciae lectins, for instance, is compared with those

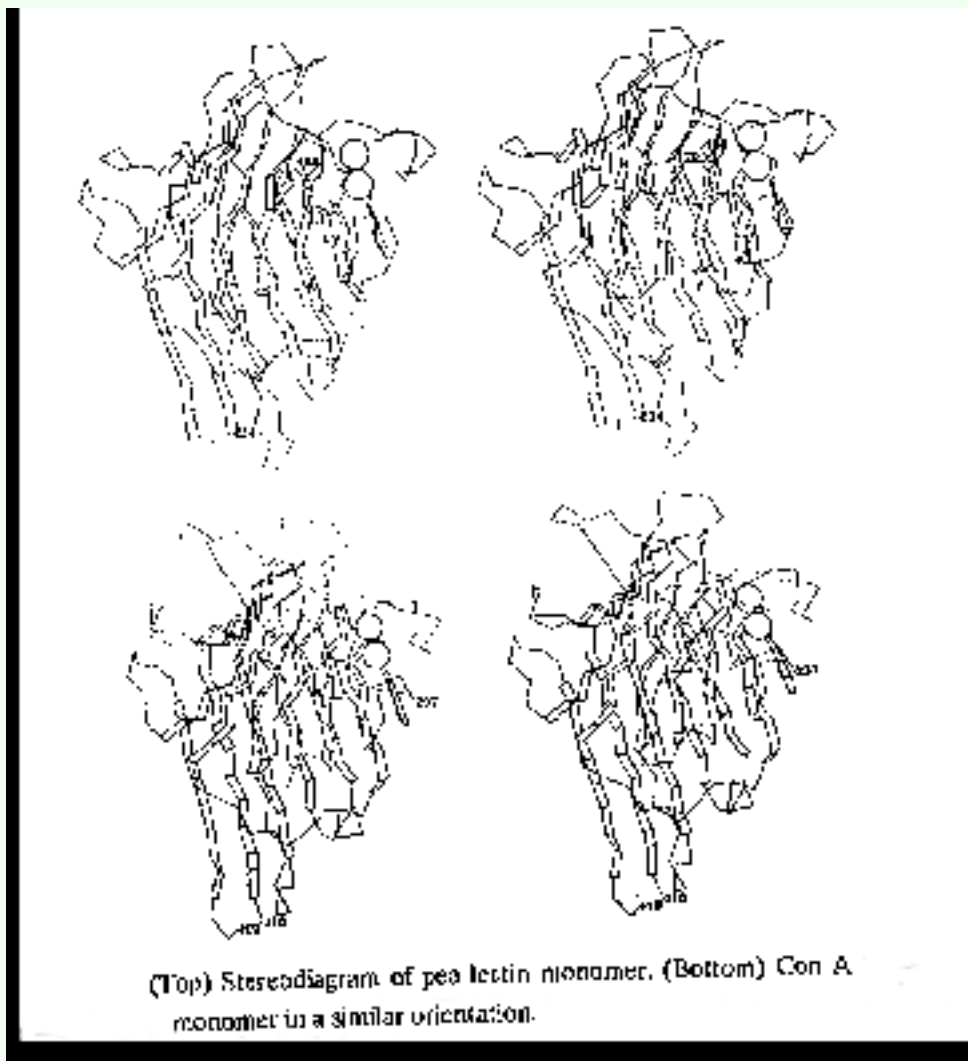

concanavalin A, an identical or homologous B- turn structures are found in these lectins. Hydrophobic profiles of two chains and single-chain lectins are superimposed, and concanavalin A has three domains that appear in some two-chain lectins of Viciaeae.

The two-chain and single-chain legume lectins exhibit high homology in the primary sequences and three-dimensional structures. Therefore evolution seems to have imposed only slight modification in the genetic coding for these lectins. This fact suggests the possibility of using lectins as an acceptable phylogenetic markers.

LECTINS IN PLANT TISSUES

Lectins in soybean plant are different from those in seeds. *Dolichos biflorus*'s lectins were studied in both the leaves and seeds. Lectins found to be produced with low level and constant for the period between 2-8 weeks after germination, then increased several folds in the next ten weeks. At this time extracts of stems and leaves contain several nanograms of lectin- like material per microgram of nitrogen, whereas mature seeds have about 1000 ng lectin per microgram. It is notable that in developing seeds the amount of lectin rises very abruptly. It is undetectable during the first 26 days after flowering but reaching a maximal level by day 28. Lectins from the stems and leaves do not agglutinate erythrocytes that could be agglutinated by seeds lectins. Stems and leaves

lectin is a dimer of a molecular weight of 68,000, in contrast to the tetrameric seed lectin with a molecular weight of 110,000.

TOXICITY OF LECTINS

Pathological lesions occur in animals injected with kidney beans extracts. Various tissues suffer from parenchymatous, fatty degeneration, and edema. In the liver local necrosis and fatty changes can be observed. Hemorrhages are observed in the stomach, the intestinal wall, and other organs. Distentions of capillary vessels may present in the Kidney and myocard with numerous thrombi. Morphological changes in rats fed navy beans include: increased weight of kidney and heart, pancreatic acinar atrophy, and fatty metamorphosis of the liver. Such changes may be attributed to the low availability of essential amino acids and low food intake of the animals consuming the raw bean diet. For example, rats fed raw kidney beans develop multiple histological lesions. Also, lectins from red kidney beans are found to induce small intestinal epithelial growth, crypt cell hyperplasia and DNA synthesis. Small amounts of isolated black bean agglutinin show low food absorption and nitrogen retention in rate.

The absorption of glucose from a ligated intestinal loop in anesthetized rats, previously fed a bean diet or given the black bean agglutinin by stomach tube, was much decreased. Raw kidney beans were found to interfere with vitamin E utilization in chicks. The hypoglycemia observed in rats fed a bean diet may indicate a reduced intestinal absorption of glucose.

Diet rich in raw soybean has a goitrogenic effect. This is indicated by the fact that fecal loss of thyroxine from the gut is higher in animals fed raw soybeans than in the controls. Raw soybean meals reduces fat and fatty acids absorption (not soybean trypsin inhibitor) in young chicks. Such meals also depresses the utilization of vitamin D in turkey. These effects are not found when the meals include heated soybean.

Ricin, abrin, croton, and related toxins, produce similar macroscopic and microscopic pathological lesions. The intensive inflammation with destruction of epithelial cells, edema, hyperemia, and hemorrhages in the lymphatic tissues are very common. Several signs of toxicity may include: fatty degeneration and necrosis in the liver, degenerative lesions of the myocard, and extension and presence of blood clots of capillaries of all organs. At the site of lectin application, local hemorrhages are frequently observed.

In vitro, plant lectins effect lymphocyte mitogenesis, aggregate immunoglobulin induce histamine release from basophils and mast cells. When raw ground garden beans are supplemented with essential nutrients diet, weight lose and death to rats may occur within 1-2 weeks, due to the toxicity of the lectins in the beans. Raw navy beans have been found toxic for Japanese quail but not toxic for germ-feed birds. However, several cases of human intoxication were reported due to ingestion of raw or partially cooked beans.

Effect on the Gastrointestinal Tract

When given orally to experimental animals, lectins interact with the mucosa of the gastrointestinal tract causing acute gastrointestinal symptoms, failure to thrive and even death. When administered parenterally, they can alter host resistance to infection or to tumor challenge. They even can be highly allergenic under certain conditions. In vitro and in vivo tests show that intestinal cell damage are caused by bean lectins. In this regard, intestinal invertase is strongly inhibited by bean lectin as well as the absorption of vitamin B. One of the possible explanation of the toxicity of the lectins, which are resistance to gastric and intestinal digestion, is the binding to the cell lining of the intestinal walls, causing lesions and interference with nutrients absorption.

Effects on Cell Membrane

The reaction between the agglutinin and the cell membrane is believed to result in an alteration of the cell function thus producing the toxic effect. Only those cells bearing the specific receptor groups for the respective lectin would be effected. For instance, significant changes in membrane properties are induced by binding of lectins to liver cells of diabetic rats. The changes may influence such cellular properties as aggregation and deformability of erythrocytes, permeability, electrical resistance, and binding properties of mitogen, hormone, and lipoprotein receptors. The binding of concanavalin A and ricin, for instance, can be reduced by 20-25% as a result of a membrane reduction of glycoprotein carbohydrates content.

Ricin Toxicity

After intravenous injection of ricin, both the intestinal tissue and the intestinal juice of rabbits became highly toxic, indicating its concentrating in this tissue and its secretion into the intestinal lumen, but it can not be found in urine. Ricin may be appear in the milk of lactating guinea pigs which had been injected after the birth of the litters (suckling young became markedly resistance against subsequent injections of the toxin).

Magnesium blood level decreases after injection of ricin in cats. Quantitative analysis of plasma, liver, and urine, of rats acutely poisoned with ricin, along with the observation of the reduced respiratory quotient of the liver, can be used to conclude that: the toxic action of ricin may be explained by an interference with some metabolic process in the liver, possibly the Krebs cycle. Also, a rise of the blood values of urea, glucose, bilirubin, transaminases, and lactic dehydrogenase in rats fed ricin could be observed. However, detection of albumin and hematuria could lead to the conclusion that a hepatonephritis with hepatic cytolysis may be an early manifestation of ricin intoxication. A lag period between the injection of a lethal amount of ricin and death is not less than 12 hours. Ricin is many times more toxic when injected than when given orally.

DETOXIFICATION

The destruction of ricin toxicity by heat has long been recognized (1889 by Stillmark). The presence of more than one toxic principle which differ in heat resistance in castor beans must be taken into account when working with products derived from these seeds.

Although the castor bean allergen is more resistance to boiling than ricin, it can be inactivated by autoclaving. For its safe use as fertilizer and for animal feeding, detoxification of castor pomace is essential. Steam heating significantly reduces the toxicity of pomace to become harmless for sheep, rabbits, and rats, when the beans is about 10% of their diet. When used before heating castor bean, calcium hydroxide may aid in achieving complete destruction of the ricin and the allergen.

However, animals can be immunized successfully when injected with heated ricin solution in order to resist the toxicity of castor bean cake. Mice can also be protected against the fatal action of ricin if injected with blood serum from immunized goats (when given not later than 6 hours after the ricin injection).

Autoclaving is proved very helpful in enhancing the nutritive value of legumes, an effect that is probably related to the destruction of toxic hemagglutinins and other growth inhibiting factors. For complete elimination of the toxicity of kidney bean and field bean, preliminary soaking prior to autoclaving is required. In addition, autoclaving for 5 minutes is sufficient to eliminate the toxicity of finely ground navy bean meal.

However, dry heating has been found to be less effective. Thirty minutes of dry heating had little effect on hemagglutinating activity of certain varieties of *V. vulgaris*, and activity was still detectable after 18 hours of heating. Whereas, heating of the soaked beans or autoclaving was fully effective.

Moreover, formaldehyde has been recognized to reduce the agglutinating and toxic actions of ricin and agglutinating activity of bean lectin, but phenol was inactive in this respect. Potato lectin was more rapidly destroyed by phenol than by formaldehyde.

Adsorption of lectins on erythrocytes or stroma that are brought into solution is observed after heating to 56 degree C. The agglutinating and the toxic activity from a bean lectin solution disappear when it is treated with stroma. For both ricin and kidney bean agglutinin, no agglutination of erythrocytes occurs at low pH, and adsorbed lectins are observed to dissociate from the erythrocytes.

LECTINS AND CANCER

lectins present on the surface of tumor cells are targeted for therapeutic purposes. It has been found that treatment with anti- lectin antibodies can suppress growth of tumor cells in agarose, and inhibit lung colonization in vivo. Lectins have the potential use in cancer treatment strategies due to the fact that lectins present on the surface of tumor cells are capable of binding exogenous carbohydrate-containing molecules and internalize them by endocytosis.

For example, wheat germ lectin (WGA) is found to induce lectin- dependent macrophage-mediated cytotoxicity against human bladder cancer (T-24) cells. Alveolar macrophage (AM) are phagocytes, mainly present in the pulmonary alveoli, are important in the antitumor defense mechanism of the lung because they can bind to the target cell- but are unable to induce cytolysis. However, studies have revealed that human AM tumorcidal activity can be induce by wheat germ lectins. Another finding is that the sensitivities of six human tumor cell lines depend on the number of receptor sites exist on the surface of WGA. Although the effector mechanism is still unknown, the binding of AM with tumor cells initiated by WGA may increase sensitivity to the cytotoxicity mediated by human AM.

In addition, WGA is found to enhance the cell killing ability of murine peritoneal macrphages. In vivo studies show that WGA has an inhibitory effect on the growth of murine tumors. The tumoricidal activity of human blood monocytes can be induced by the WGA. As a result, the monocytes are able to become cytotoxic to four different human tumor cell lines: T-24 bladder carcinoma, A-375 melanoma, ACHN renal carcinoma, and U373MG glioblastoma. Murine systems also show similar response. However, concanavalin A, PHA, PWM and SBA are unable to produce tumoricidal monocytes.

References

- Barondes, S. H. (1981). Lectins: Their multiple endogenous cellular functions. Annual Review of Biochemistry, Vol 50: 207- 231.
- Brownlee, M., and Cerami, A. (1981). The biochemistry of the complications of diabetes mellitus. Annual Review of Biochemistry. Vol. 50: 385-432.
- Cheeke, P., and Shull, Lee. (1985). Natural toxicants in feed and poisonous plants. Avi, Inc. Westport.
- Cooper-Driver, Gillian A. (1983). Chemical substances in plants toxic to animals. In Miloslav Rechcigl, Handbook of Naturally Occurring Food Toxicants, (pp. 213-240). CRC Press, Florida.
- Etzler, Marilyn, (1983). Introduction . In Irwin Goldstein, and Marilyn Etzler (Eds.), Chemical taxonomy, molecular biology, and function of plant lectins, (pp. 1-5). Progress in Clinical and Biological Research, Vol. 138. Alan R. Liss, Inc., NY.
- Jaffe, Werner G. (1969). Hemagglutinins. In Irvin Liener (Ed.), Toxic Constituents of Plant Foodstuffs, (pp. 69-101). Academic Press, NY.
- Jaffe, Werner (1983). Handbook of Naturally Occurring Food Toxicology. In Miloslav Rechcigl, Handbook of Naturally Occurring Food Toxicants, (pp. 31-38). CRC Press, Inc.,

Florida.

Lotan, R. (1983). Differentiation-associated modulation of lactoside binding lectins in cancer cells. In H. Gabius and S. Gabius (Eds.), *Lectins and Cancer*, (pp.153-169). Springer-Verlag, Berlin.

Nachbar, M., and Oppenheim, J. (1980). Lectins in the United States diet: a survey of lectins in commonly consumed foods and a review of the literature. *The American Journal of Clinical Nutrition*, Vol. 33, No. 11, 2338-2345.

Ogawara, M., Utsugi, M., Yamazaki, M., and Sone S. (1985). Induction of human monocyte-mediated tumor cell killing by a plant lectin, wheat germ agglutinin. *Japanese Journal of Cancer Research (Gann)*, Vol. 76, No. 11, 1107-1114.

Ogawara, M., Sone, S., and Ogura, T. (1987). Human alveolar macrophages: Wheat germ agglutinin-dependent tumor cell killing. *Japanese Journal of Cancer Research (Gann)*, Vol. 78, No. 3, 288- 295.

Peumans, W., Nsimba-Lubaki, M., Broekaert, W., and Van Damme, E.(1986). Are bark lectins of Elderberry (*Sambucus nigra*) and Black Locust (*Robinia pseudoacacia*) storage proteins?. In Leland Shannon and Maarten Chrispeels (Eds.), *Molecular biology of seed storage proteins and lectins*, (pp. 53-63). The American Society of Plant Physiologists.

Pusztai, A. (1991). *Plant lectins*. Cambridge University Press, Cambridge.

Suddath, F., Parks, E., Suguna, K, Subramanian, E., and Einspahr, H. (1986). The crystal structure of Pea lectin at 3.0 A resolution. In Leland Shannon and Maarten Chrispeels (Eds.), *Molecular biology of seed storage proteins and lectins*, (pp. 29- 43). The American Society of Plant Physiologists.

This series of web pages was created by Tareq Al-Ati, an undergraduate student at Cornell University for the AS625 class. All comments and suggestions are welcome.

WARNING: These web pages are only meant to be informative. Neither Cornell University nor the author of this site endorse or recommend the use of these plants.

Return to: [Poisonous Plants Homepage](#)

Home page: [Animal Science at Cornell University](#)

For problems or comments on this web page, contact the Animal Science [Webmaster](#)

RICIN TOXIN FROM CASTOR BEAN PLANT

Ricinus communis

Ricin is one of the most poisonous naturally occurring substances known.

Index

- [Castor Bean Plant, Poisoning, and Oil](#)
 - More about Ricin Toxin from Castor Beans
 - [Introduction](#)
 - [Mechanism of Toxic Action](#)
 - [Ricin Biosynthesis](#)
 - [Ricin Enzymatic Action](#)
 - [Ricin Structure](#)
 - [Ricin Uptake](#)
 - [Therapeutic Applications of Immunotoxins](#)
 - [IN VITRO](#)
 - [IN VIVO](#)
 - [Toxigenic Ablation](#)
 - [TOXIGENES](#)
 - [SUICIDE TRANSPORT](#)
 - [References](#)
-

Introduction

The seeds from the castor bean plant, *Ricinus communis*, are poisonous to people, animals and insects. One of the main toxic proteins is "**ricin**", named by Stillmark in 1888 when he tested the beans' extract on red blood cells and saw them agglutinate. Now we know that the agglutination was due to another toxin that was also present, called RCA (Ricinus communis agglutinin). **Ricin is a potent cytotoxin but a weak hemagglutinin, whereas RCA is a weak cytotoxin and a powerful hemagglutinin.**

Poisoning by **ingestion** of the castor bean is due to **ricin**, not RCA, because RCA does not penetrate the intestinal wall, and does not affect red blood cells unless given intravenously. If RCA is injected into the blood, it will cause the red blood cells to agglutinate and burst by hemolysis.

Perhaps just one milligram of ricin can kill an adult.

The symptoms of human poisoning begin within a few hours of ingestion.

The symptoms are:

- abdominal pain
- vomiting
- diarrhea, sometimes bloody.

Within several days there is:

- severe dehydration,
- a decrease in urine,
- and a decrease in blood pressure.

If death has not occurred in 3-5 days, the victim usually recovers. It is advisable to keep children away

from the castor bean plant or necklaces made with its seeds. In fact don't even have them in or around a house with small children. If they ingest the leaves or swallow the seeds, they may get poisoned. The highly toxic seeds beaded into necklaces, cause skin irritation at the contact point.

If the seed is swallowed without chewing, and there is no damage to the seed coat, it will most likely pass harmlessly through the digestive tract. However, if it is chewed or broken and then swallowed, the ricin toxin will be absorbed by the intestines.

It is said that just one seed can kill a child. Children are more sensitive than adults to fluid loss due to vomiting and diarrhea, and can quickly become severely dehydrated and die.

Castor bean plants in a garden should not be allowed to flower and seed.

[Castor Bean Plant, Poisoning, and Oil](#) [\[Ricin\]](#) [\[Mechanism of Toxic Action\]](#) [\[Ricin Biosynthesis\]](#) [\[Ricin Enzymatic Action\]](#) [\[Ricin Structure\]](#) [\[Ricin Uptake\]](#) [\[Therapeutic Applications of Immunotoxins\]](#) [\[Toxicogenic Ablation\]](#) [\[References\]](#)

[Return to Cornell poison plant home page](#)

[Return to Toxic Agents List](#)

Mechanism of Toxic Action

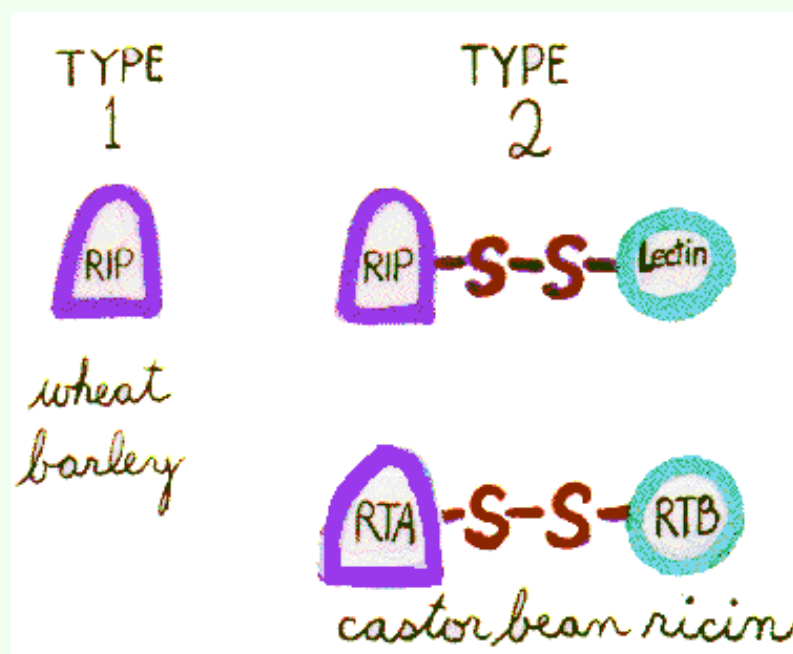

Many **cytotoxic proteins** from a variety of plants have been identified, and they are related to ricin both in structure and function. They **inhibit protein synthesis** by specifically and irreversibly inactivating **eukaryotic ribosomes**.

These "**ribosome-inactivating proteins**" (RIPs) are typically N-glycosylated, 30 kDa monomers (**Type 1 RIPs**). However, in order to bind to the cell surface galactosides and enter the cytosol to reach ribosomes, they require a second monomer, a galactose-binding, 30 kDa lectin. The monomers are joined by a disulfide bridge to form the toxic heterodimers (**Type 2 RIPs**).

Some plants, such as **wheat** and **barley**, have only **Type 1 RIPs**, and are **not poisonous**, while others, such as the **castor bean plant seed**, contain the **Type 2 RIPs** that are among the **most potent cytotoxins in nature**. 5% of the *Ricinus* seed consists of ricin and RCA (*Ricinus communis* agglutinin).

Ricin is a heterodimeric type 2 RIP. This ribosome-inactivating enzyme (32 kDa), also known as the A chain, is linked by a disulfide bond to the galactose/N-acetylgalactosamine-binding lectin (34 kDa), also called the B chain.

Ricin Biosynthesis

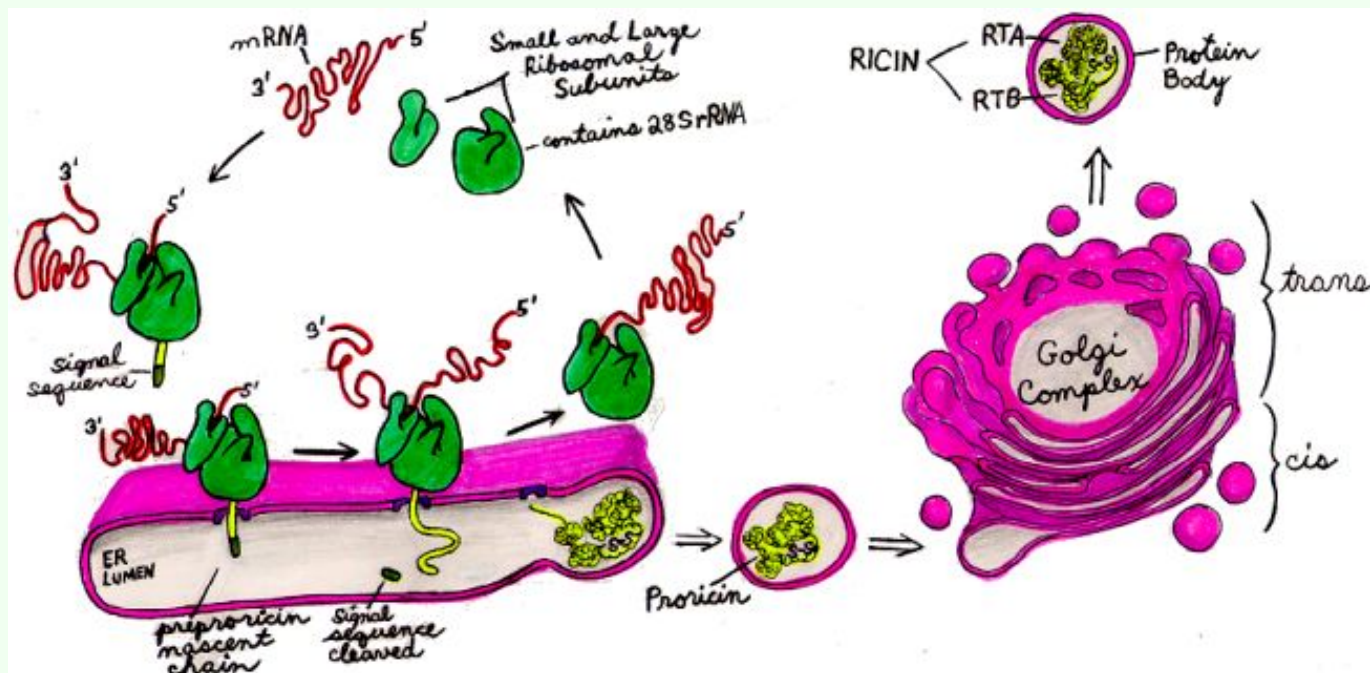

Ricin and RCA are synthesized in the endosperm cells of maturing seeds, and are stored in an organelle called the "protein body", a vacuolar compartment. When the mature seed germinates, the toxins are destroyed by hydrolysis within a few days.

Ricin begins synthesis as a **prepolypeptide** that contains both **A and B chains**. The **signal sequence** of the N₃-terminus targets the nascent chain to the **endoplasmic reticulum (ER)** and is then cleaved off. As the **proricin** polypeptide elongates it is N-glycosylated within the lumen of the ER. Protein disulfide isomerases catalyze **disulfide bond formation** as the proricin molecule folds itself. Proricin undergoes further oligosaccharide modifications within the **Golgi complex** and then is transported within vesicles to the **protein bodies**.

Ricin is not catalytically active until it is proteolytically cleaved by an endopeptidase within the protein bodies. This **splits** the polypeptide into the A chain and the B chain **still linked by a single disulfide bond**. Since ricin is inactive until then, the plant avoids poisoning its own ribosomes in case some proricin accidentally passes into the cytosol during synthesis and transport.

[\[Castor Bean Plant, Poisoning, and Oil\]](#) [\[Ricin\]](#) [\[Mechanism of Toxic Action\]](#) [\[Ricin Biosynthesis\]](#) [\[Ricin Enzymatic Action\]](#) [\[Ricin Structure\]](#) [\[Ricin Uptake\]](#) [\[Therapeutic Applications of Immunotoxins\]](#) [\[Toxicogenic Ablation\]](#) [\[References\]](#)

[Return to Cornell poison plant home page](#)

[Return to Toxic Agents List](#)

Ricin Enzymatic Action

The **ricin A** portion of the heterodimer is the enzyme that binds and **depurinates** a specific adenine of the **28S rRNA**. The adenine ring of the ribosome becomes sandwiched between two tyrosine rings in the **catalytic cleft** of the enzyme and is hydrolyzed by the enzyme's N-glycosidase action. The target adenine is a specific RNA sequence that contains the unusual tetranucleotide loop, **GAGA**. Ricin is more active against animal than plant ribosomes, and intact bacterial ribosomes are generally not susceptible.

Ricin Structure

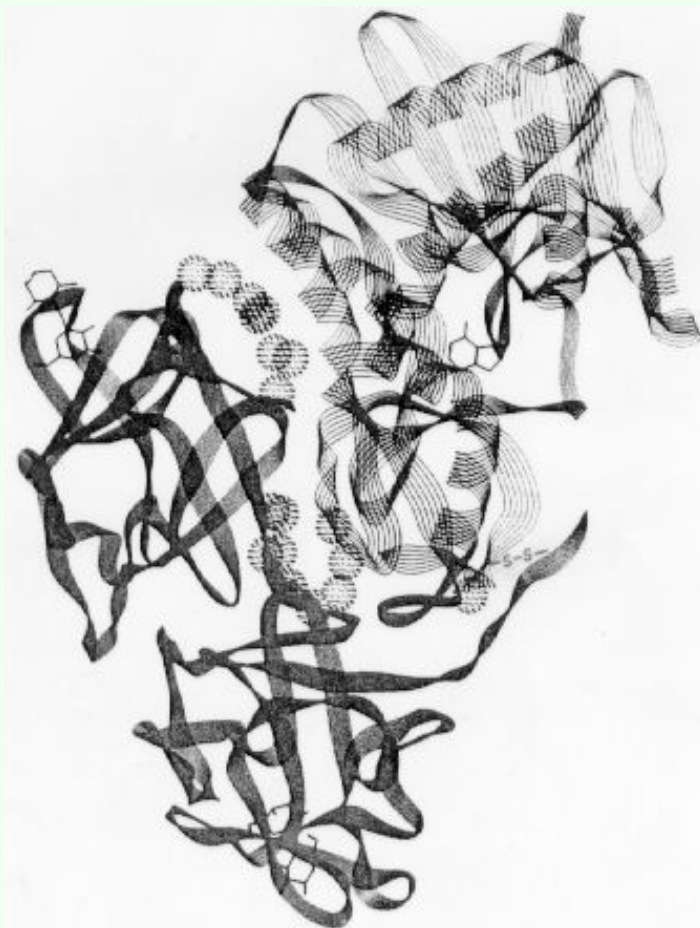

This figure from Lord et al, depicts a 3-dimensional ribbon drawing of ricin, modeled from X-ray crystallography data. **The upper right half, the dotted ribbon, is the A chain, and the lower left half, the solid ribbon, is the B chain.**

The **A chain (or RTA)** is a 267-amino acid globular protein. It has 8 alpha helices and 8 beta sheets. The substrate binding site is the cleft marked by the substrate adenine ring.

The **B chain (or RTB)** is a 262-amino acid protein that is shaped like a barbell. It has a binding site for galactose at each end, (depicted by lactose rings). These two sites allow hydrogen bonding to specific membrane sugars (galactose and N-acetyl galactosamine). A disulfide bridge (-S-S-) joins RTA with RTB (far-right, center). The spheres are trapped water molecules.

[\[Castor Bean Plant, Poisoning, and Oil\]](#) [\[Ricin\]](#) [\[Mechanism of Toxic Action\]](#) [\[Ricin Biosynthesis\]](#) [\[Ricin Enzymatic Action\]](#) [\[Ricin Structure\]](#) [\[Ricin Uptake\]](#) [\[Therapeutic Applications of Immunotoxins\]](#) [\[Toxicogenic Ablation\]](#) [\[References\]](#)

[Return to Cornell poison plant home page](#)

[Return to Toxic Agents List](#)

Ricin Uptake

The RTB portion of ricin binds to both glycoproteins and glycolipids at cell surfaces that terminate with galactose. It has two binding sites for galactose, and 106 to 108 ricin molecules may bind per cell. **However, just a single ricin molecule that enters the cytosol can inactivate over 1,500 ribosomes per minute and kill the cell.**

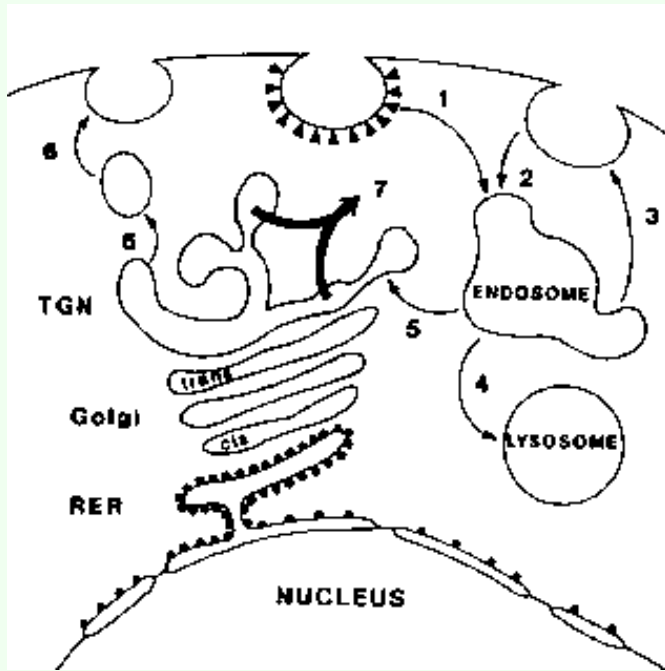

As shown in the diagram, the pathway for internalization of ricin involves:

1. endocytosis by coated pits and vesicles or,
2. endocytosis by smooth pits and vesicles. The vesicles fuse with an endosome.
3. Many ricin molecules are returned to the cell surface by exocytosis, or
4. the vesicles may fuse to lysosomes where the ricin would be destroyed.
5. If the ricin-containing vesicles fuse to the Trans Golgi Network, (TGN), there's still a chance they may
6. return to the cell surface.
7. Toxic action will occur when RTA, aided by RTB, penetrates the TGN membrane and is liberated into the cytosol.

Once inside the cytosol, the RTA catalyzes the depurination of the ribosomes, halting protein synthesis.

[\[Castor Bean Plant, Poisoning, and Oil\]](#) [\[Ricin\]](#) [\[Mechanism of Toxic Action\]](#) [\[Ricin Biosynthesis\]](#) [\[Ricin Enzymatic Action\]](#) [\[Ricin Structure\]](#) [\[Ricin Uptake\]](#) [\[Therapeutic Applications of Immunotoxins\]](#) [\[Toxicogenic Ablation\]](#) [\[References\]](#)

[Return to Cornell poison plant home page](#)

[Return to Toxic Agents List](#)

Therapeutic Applications of Immunotoxins

Ricin can be targeted to specific cells, such as **cancer cells**, by conjugating the RTA subunit to antibodies or growth factors that preferentially bind the unwanted cells. These immunotoxins have worked very well for *in vitro* applications, e.g. **bone marrow transplants**. Although they have not worked very well in many *in vivo* situations, progress in this area of research shows promise for the future.

IN VITRO APPLICATIONS

In **bone marrow transplant** procedures, **RTA-immunotoxins** have been used **successfully** to destroy T lymphocytes in bone marrow taken from histocompatible **donors**. This reduces rejection of the donor bone marrow, a problem called "graft-vs-host disease" (GVHD). In steroid-resistant, acute GVHD situations, RTA-immunotoxins helped alleviate the condition. Also, in **autologous bone marrow transplantation**, a sample of the patient's **own bone marrow** is treated with anti-T cell immunotoxins to destroy malignant T-cells in **T cell leukemias** and **lymphomas**.

IN VIVO APPLICATIONS

"For the in vivo treatment of solid tumors, considerable problems can arise due to poor access of the immunotoxin (IT) to the tumor mass; lack of IT specificity, tumor cell heterogeneity, antigen shedding, breakdown or rapid clearance of the IT, and dose-limiting side effects". (Lord et al.). One common problem encountered in patients treated with ricin-immunotoxins is the "vascular leak syndrome", in which fluids leak from blood vessels leading to hypoalbuminemia, weight gain and pulmonary edema. "Research efforts to expand and develop immunotoxins and therapies for clinical use in **cancer and AIDS** are continuing with strategies utilizing recombinant DNA technology (Lord et al.).

[\[Castor Bean Plant, Poisoning, and Oil\]](#) [\[Ricin\]](#) [\[Mechanism of Toxic Action\]](#) [\[Ricin Biosynthesis\]](#) [\[Ricin Enzymatic Action\]](#) [\[Ricin Structure\]](#) [\[Ricin Uptake\]](#) [\[Therapeutic Applications of Immunotoxins\]](#) [\[Toxigenic Ablation\]](#) [\[References\]](#)

[Return to Cornell poison plant home page](#)

[Return to Toxic Agents List](#)

Toxigenic Ablation

TOXIGENES

"Toxigenes are DNA fusions in which DNA encoding a potent toxin, e.g. RTA, is placed under the transcriptional control of a tissue- or developmental stage-specific promoter and/or enhancer. When expressed intracellularly, the toxigene product causes cell death. The introduction and expression of a toxigene in transgenic animals or plants may lead to **cell type-specific ablation**, which can be used to

- study developmental cell lineages or to
- generate animal models of degenerative diseases." (Lord et al.)

SUICIDE TRANSPORT

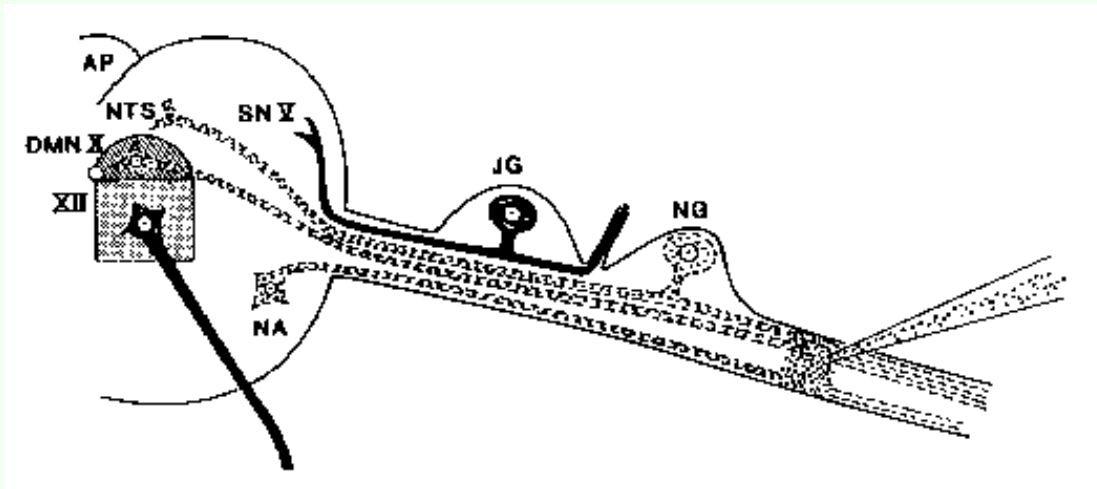

Diagram shows injection of ricin into vagal nerve and subsequent destruction of neurons (dashed neurons destroyed, solid neurons unaffected).

Neuroscientists can selectively destroy neurons by injecting ricin into nerves. Retrograde axonal transport mechanisms bring the toxin to the neuronal cell bodies where the ribosomes are localized.

Ultrastructural analysis reveals that ricin first causes the dispersion of polyribosomes, and then the rough endoplasmic reticulum disorganizes into smooth vesicles. The cell bodies (perikaryon) swell, the nuclei degenerate and the entire neuron disintegrates.

Since ricin is a N-acetyl galactosamine-binding lectin, it can be used with different lectins that have different

specificities to map **neuronal patterns of glycosylation**. When suicide transport is observed after injection of the toxin, it confirms the presence of **N-acetyl galactosamine** residues on the neuronal cell surface. Strategies in suicide transport work very well in studies of **adult** peripheral sensory and motor neurons because they are sensitive to ricin.

Neurons in the central nervous system of adults are resistant to ablation by ricin, whereas young developing brains are sensitive, suggesting that brain development involves changes in glycosylation of CNS neurons. The galactose terminal residues may be either clipped or masked by addition of sialic acids residues.

In suicide transport experiments, often some ricin **leaks out of the nerve**, causing systemic poisoning of the animal. This problem can be avoided by simultaneously administering a **ricin antiserum**.

The value of using suicide transport strategies is summarized (from Wiley and Oeltmann):

- anatomical mapping of neurons
- modeling of motor neuron degenerative diseases
- studying consequences of peripheral nerve damage and repair mechanisms
- mapping cellular neurotransmitter receptors
- disease-related applications including
 - eradication of latent herpes simplex virus in trigeminal sensory neurons
 - production and analysis of glial fibrillary bundles
 - treatment of equine neuromas

[\[Castor Bean Plant, Poisoning, and Oil\]](#) [\[Ricin\]](#) [\[Mechanism of Toxic Action\]](#) [\[Ricin Biosynthesis\]](#) [\[Ricin Enzymatic Action\]](#) [\[Ricin Structure\]](#) [\[Ricin Uptake\]](#) [\[Therapeutic Applications of Immunotoxins\]](#) [\[Toxicogenic Ablation\]](#) [\[References\]](#)

[Return to Cornell poison plant home page](#)

[Return to Toxic Agents List](#)

References

- Alber, J.I., and D.M. Alber. (1993) *Baby-Safe Houseplants and Cut Flowers: A Guide to Keeping Children and Plants Safely Under the Same Roof*. Story Communications Inc., Pownal, Vermont.
- Cooper, M.R., and A.W. Johnson. (1994) *Poisonous Plants and Fungi: An Illustrated Guide*. CAB International Bureau of Animal Health, Weybridge; London.
- Czapla, T.H., and I.A. Johnston. (1990) Effect of plant lectins on the larval development of European corn borer (Lepidoptera:pyralidae) and southern corn rootworm (Coleoptera:chrysomelidae). *J.Econ. Entomol*, Lanham,Md.: Entomological Society of America, 83(6):2480-2485.
- Frankel, A.E., (1993) Immunotoxin Therapy of Cancer. *Oncology (Huntington)*, 7(5):69-78; discussion79-80, 83-6.
- Knight, B. (1979) Ricin-a potent homicidal poison. *Br. Med. J.* 278:350-351.
- Lord, J.M., Roberts, L.M., and J.D. Robertus. (1994). *FASEB J.* Feb; 8(2):201-8.
- Matthews, R.W., and J.R. Matthews (1978). *Insect Behavior*, pub. Wiley and Sons, Inc. New York, pp.507.
- Okoye, JOA, Enunwaonye, CA. Okorie, A.U. and F.O.I. Anugwa (1987). Pathological effects of feeding roasted castor bean meal *Ricinus communis* to chicks. *Avian Pathol.* 16(2):283-290.
- Olaifa, J.I., Matsumura,F., Zeevaart, J.A.D., Mullin, C>A>, and P. Charalambous. (1991) Lethal amounts of ricinine in green peach aphids *myzus-persicae* suzler fed on castor bean plants. *Plant Sci. (Limerick)*, 73(2):253-256.
- Purushotham, N.P., Rao, M.S., and G.V. Raghavan (1986). Utilization of castor-meal in the concentrate mixture of sheep. *Indian J. Anim. Sci.* 56(10):1090-1093.
- Robertus, J.D. (1988). Toxin Structure. *Cancer Treat. Res.* 37:11-24.

Robertus, J. D. (1991) The structure and action of ricin, a cytotoxic N-glycosidase. Sem. in Cell Biol. 2:23-30.

Vitetta, E.S. and P.E. Thorpe, (1991) Immunotoxins containing ricin or its A chain, Sem. in Cell Biol. 2:47-58.

Wiley, R. G., and T. N. Oeltmann, (1991) Ricin and Related Plant Toxins: Mechanisms of Action and Neurobiological Applications; In, Handbook of Natural Toxins, Vol.6, ed. R.F.Keeler and A.T.Tu, Marcel Dekker, Inc., New York.

[\[Castor Bean Plant, Poisoning, and Oil\]](#) [\[Ricin\]](#) [\[Mechanism of Toxic Action\]](#) [\[Ricin Biosynthesis\]](#) [\[Ricin Enzymatic Action\]](#) [\[Ricin Structure\]](#) [\[Ricin Uptake\]](#) [\[Therapeutic Applications of Immunotoxins\]](#) [\[Toxigenic Ablation\]](#) [\[References\]](#)

This series of web pages was created by an undergraduate student at Cornell University for the AS625 class. All comments and suggestions are welcome.

WARNING These web pages are only meant to be informative. Neither Cornell University nor the author of this site endorse or recommend the use of these plants.

Return to:

[Return to Toxic Agents List](#)

[Poisonous Plants Homepage](#)

Home page: [Animal Science at Cornell University](#)

For problems or comments on this web page, contact the Animal Science [Webmaster](#)



Polypeptide Toxins in Amanita Mushrooms:

All of the toxins found in the *Amanita* spp. mentioned in this poisonous plants list are peptides. The distribution of the peptides varies in the different parts of the mushroom, with the cap being the most deadly part. The amatoxins, phallotoxins, and virotoxins are found in [A. bisporigera](#), [A. ocreata](#), [A. phalloides](#), [A. phalloides var. alba](#), [A. suballiacea](#), [A. tenuifolia](#), [A. virosa](#), and some other [mushrooms](#). The phallolysins are a recently discovered group of toxins as yet only seen in [A. phalloides](#). Ibotenic acid is found in [A. cothurnata](#), [A. muscaria var. formosa](#), [A. muscaria var. muscaria](#), and [A. pantherina](#).

1. [Amatoxins](#)
2. [Phallotoxins](#)
3. [Virotoxins](#)
4. [Phallolysins](#)
5. [Ibotenic acid/Muscimol](#)

[Return to the Toxic Agents List](#)

Back to the [INDEX](#)

1. Amatoxins

There are nine amatoxins:

- alpha-Amanitin
- beta-Amanitin
- gamma-Amanitin
- epsilon-Amanitin
- Amanin
- Amanin amide - only found in [A. virosa](#)
- Amanullin
- Amanullinic acid
- Proamanullin

Amatoxins are solely responsible for fatal human poisonings. They are bicyclic octapeptides which are much more potent than any of the other toxins. The amatoxins are taken up by the liver where they begin to cause damage. They are then secreted by the bile into the blood where they are taken up by the liver again, causing a cycle of damage and excretion. In the liver, amatoxins inhibit

RNA-polymerase II. The liver is slowly destroyed and is unable to repair itself due to the inactivation of the RNA-polymerase. Thus, the liver slowly dissolves with no hope of repair.

Back to the [TOP](#) of the page

2. Phallotoxins

There are seven naturally occurring phallotoxins:

- Phalloin
- Phalloidin
- Phallisin
- Prophalloin
- Phallacin
- Phallacidin
- Phallisacin

The phallotoxins are all derived from the same seven amino acid cyclic peptide backbone. There are two groups of phallotoxins, neutral and acidic. The neutral phallotoxins contain D-threonine, while the acidic ones contain beta-hydroxy-succinic acid.

Phallotoxins destroy liver cells by disturbing the equilibrium of G-actin with F-actin, causing it to shift entirely to F-actin. This leads to numerous exvaginations on the liver cell's membrane which render the cell susceptible to deformity by low-pressure gradients, even those of the portal vein in vivo. This is followed by loss of potassium ions and cytoplasmic enzymes which leads to depletion of ATP and glycogen causing the final downfall of the liver.

Back to the [TOP](#) of the page

3. Virotaxins

There are six virotaxins:

- Viroidin
- Desoxoviroidin
- Ala1-viroidin
- Ala1-desoxoviroidin
- Viroisin

- Desoxoviroisin

Although they have the same [toxicological](#) effects as and appear to be derived from the phallotoxins, the virotoxins are monocyclic heptapeptides, not bicyclic peptides.

Back to the [TOP](#) of the page

4. Phallolysins There are three phallolysins that are hemolytically active proteins, but, as previously stated, they are heat and acid labile and do not pose a threat to humans.

Back to the [TOP](#) of the page



5. Ibotenic acid/Muscimol Ibotenic acid is an Excitatory Amino Acid (EAA) and muscimol is its derivative. These toxins act by mimicking the natural transmitters glutamic acid and aspartic acid on neurons in the central nervous system with specialized receptors for amino acids. These toxins may also cause selective death of neurons sensitive to EAAs.

Back to the [TOP](#) of the page

Go to the [references](#) for this page.

This series of web pages was created by an undergraduate student at Cornell University for the AS625 class. All comments and suggestions are welcome.

WARNING: These web pages are only meant to be informative. Neither Cornell University nor the author of this site endorse or recommend the use of these plants.

Return to: [Poisonous Plants Homepage](#)
[List of Toxic Agents](#)

Home page: [Animal Science at Cornell University](#)

For problems or comments on this web page, contact the Animal Science [Webmaster](#)

SMCO

Several Brassica species contain considerable levels of S-methyl-L-cysteine sulphoxide (SMCO), an amino acid which is degraded in the rumen to dimethyl disulphide and is thought to be the primary cause of haemolytic anemia.

This series of web pages was created by an undergraduate student at Cornell University for the AS625 class. All comments and suggestions are welcome.

WARNING: These web pages are only meant to be informative. Neither Cornell University nor the author of this site endorse or recommend the use of these plants.

Return to: [Poisonous Plants Homepage](#)

[List of Toxic Agents](#)

Home page: [Animal Science at Cornell University](#)

For problems or comments on this web page, contact the Animal Science [Webmaster](#)

Tryptophan

Increased intake of L-tryptophan from lush pastures and its subsequent microbial degradation in the rumen is associated with pulmonary oedema and emphysema. Tryptophan is degraded in the rumen to the toxic metabolite 3-methylindole in a two-step degradation process. The rates of tryptophan degradation, however, depends on both availability of the substrate and dietary intake. There appears to be a greater tryptophan rate of conversion in ruminants fed on forage diets than those fed concentrate diets. Sudden dietary changes from a sparse feed to a lush, succulent pasture might cause acute bovine pulmonary emphysema, a respiratory disease of cattle. There is no effective treatment for this condition, and prevention by avoiding sudden dietary changes to lush pastures seems to be the only alternative.

This series of web pages was created by an undergraduate student at Cornell University for the AS625 class. All comments and suggestions are welcome.

WARNING: These web pages are only meant to be informative. Neither Cornell University nor the author of this site endorse or recommend the use of these plants.

Return to: [Poisonous Plants Homepage](#)

Home page: [Animal Science at Cornell University](#)

For problems or comments on this web page, contact the Animal Science [Webmaster](#)

Mimosine

Mimosine is a non-protein amino acid found in leaves, pods and seeds of tropical legumes of the genus *Leucaena*. Mimosine is degraded in the rumen to 3-hydroxy-4(1H)-pyridone (3,4DHP), a goitrogen. *Leucaena* consumption in ruminants may cause poor growth, alopecia, swollen and raw coronets above the hooves, lameness, mouth and esophageal lesions, depressed serum thyrosine levels, and goiter. Susceptibility of ruminants to intoxication, however, greatly depends on specific microbial populations. Further transfer of ruminant fluids from a resistant animal to a susceptible one results in a complete elimination of the toxic effects of Mimosine. This appears to be a possible solution to the toxicity of *leucaena* in ruminant animals.

This series of web pages was created by an undergraduate student at Cornell University for the AS625 class. All comments and suggestions are welcome.

WARNING: These web pages are only meant to be informative. Neither Cornell University nor the author of this site endorse or recommend the use of these plants.

Return to: [Poisonous Plants Homepage](#)

Home page: [Animal Science at Cornell University](#)

For problems or comments on this web page, contact the Animal Science [Webmaster](#)

Sesquiterpene Lactones and their toxicity to livestock

Cattle, sheep and horses

The objective of this web page is to describe the different classes of naturally-occurring sesquiterpene lactones. Because sesquiterpene lactones are responsible for the toxicity of several livestock poisons it is useful to focus on their effects on mammals such as cattle, sheep and horses that are most commonly exposed to sesquiterpene lactone poisoning.



[\[General description\]](#) [\[Representative Structure\]](#) [\[Distribution\]](#) [\[Biological activity\]](#)
[\[Poisons\]](#)

GENERAL DESCRIPTION

Sesquiterpene lactones constitute a large and diverse group of [biologically active](#) plant chemicals that have been identified in several plant families. However, the greatest numbers are found in the [Compositae](#) family with over 3000 reported different structures.

Sesquiterpene lactones (SQL) are a class of naturally occurring plant terpenoids that are formed from "head-total condensation of three isoprene units and subsequent cyclization and oxidative transformation to produce a cis or trans-fused lactone. Sesquiterpene lactones are [characteristic constituents](#) of Compositae. These secondary compounds are primarily classified on the basis of their carbocyclic skeletons into germanocranolides, guaianalides, eudesmalides, pseudoguaianolides and xanthanolides. The suffix "olide"

refers to the lactone function and is based on costunolide, a germanacranolide which is related to the ten-membered carbocyclic sesquiterpene, germacrone.

An individual plant species generally produces one skeletal type of SQL concentrated primarily in the leaves and flower heads. The percentage of SQL per dry weight may vary from 0.01% to 8%. Losses of livestock intoxicated by plants containing SQL are well known. In fact, they have been shown to exhibit a wide range of biological activities.

[\[General description\]](#) [\[Representative Structure\]](#) [\[Distribution\]](#) [\[Biological activity\]](#)
[\[Poisons\]](#)

REPRESENTATIVE STRUCTURES:

Possible biogenetic relationships of the different skeletal types of sesquiterpene lactones.

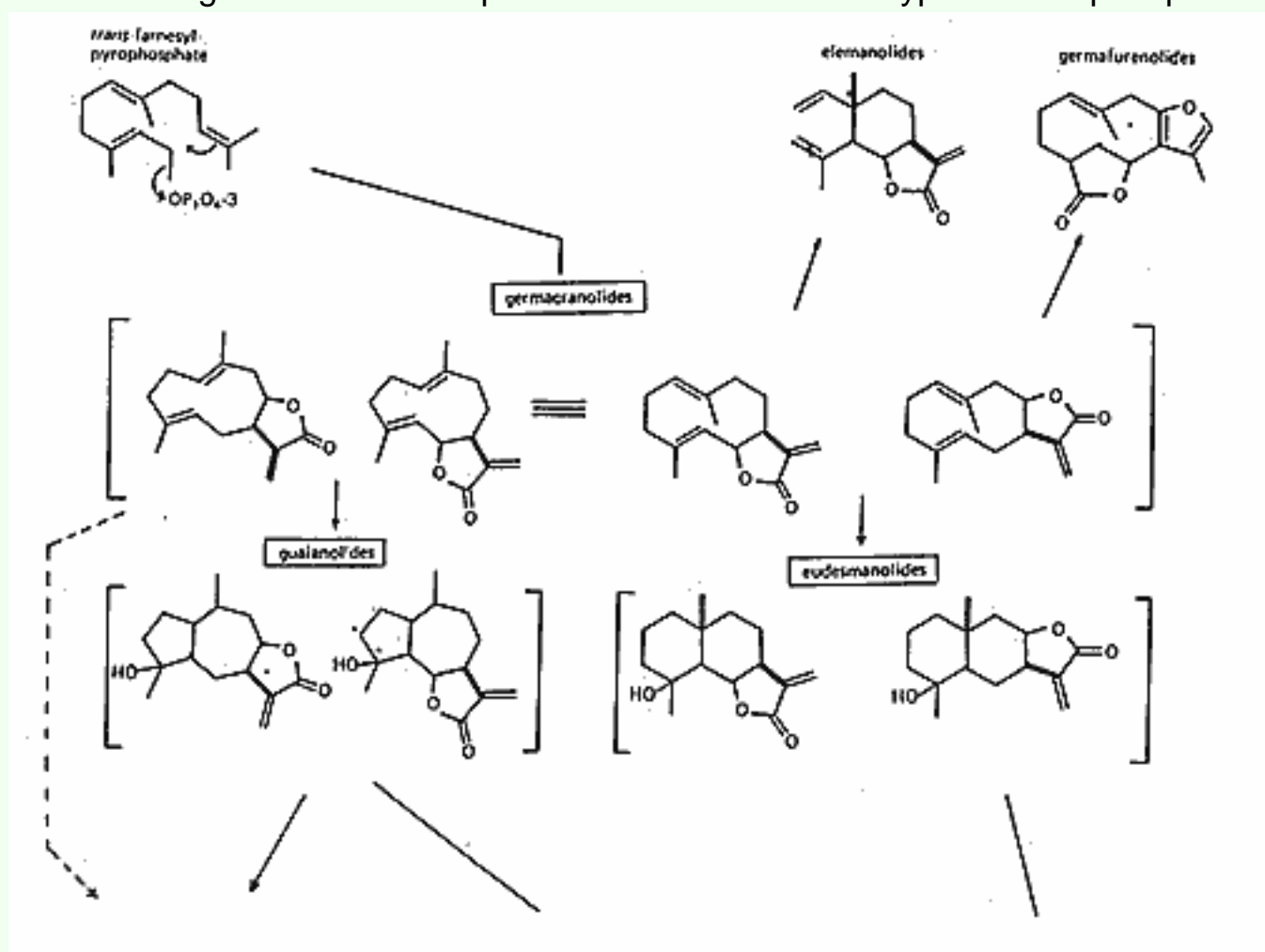

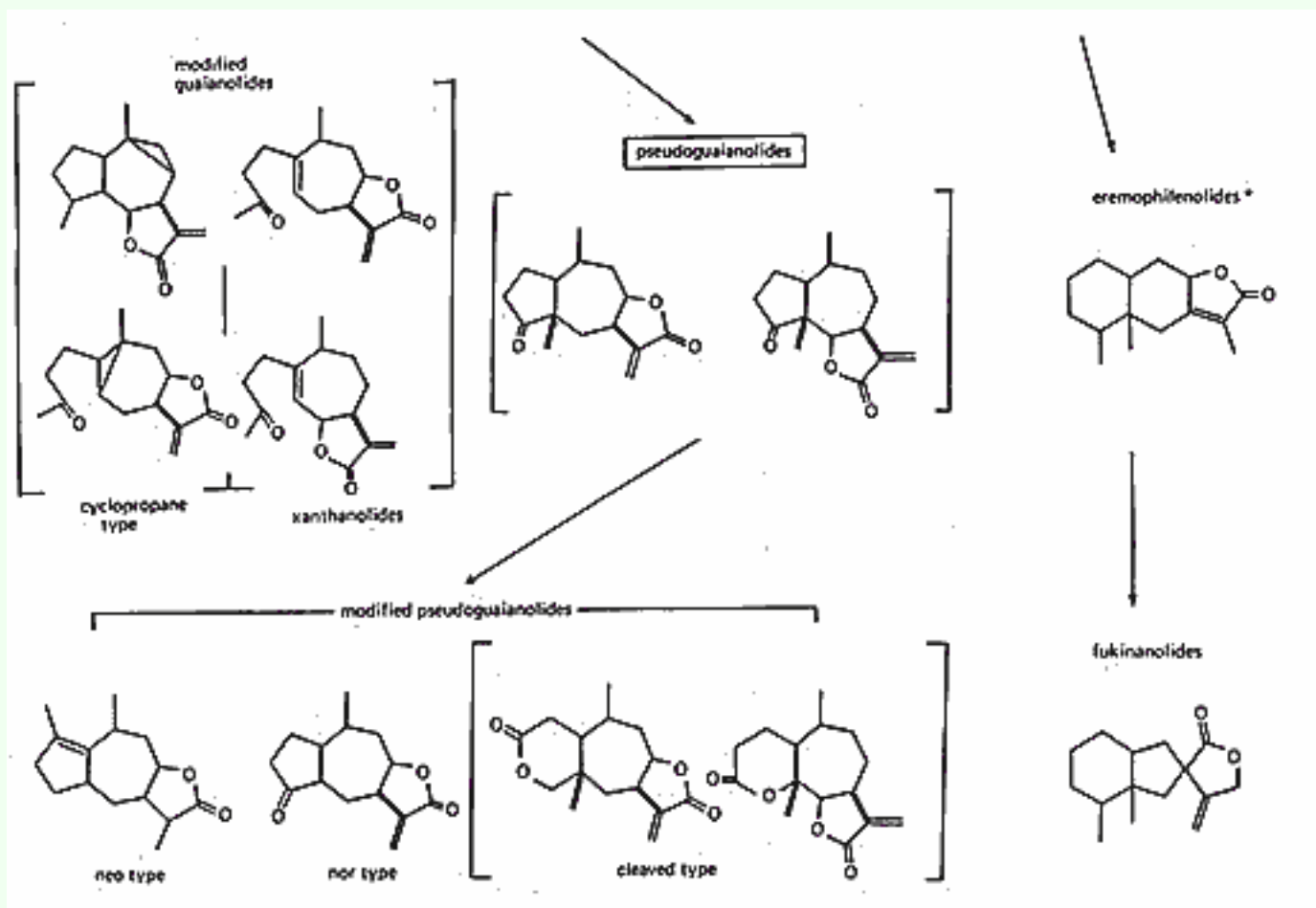

Photo from *Sesquiterpene Lactones. Chemistry, NMR and Plant Distribution*, University of Tokyo Press.

[\[General description\]](#) [\[Representative Structure\]](#) [\[Distribution\]](#) [\[Biological activity\]](#)
[\[Poisons\]](#)

DISTRIBUTION OF DIFFERENT STRUCTURAL CLASSES OF SESQUITERPENE LACTONES IN THE COMPOSITAE

Tribes (No. of genera)	No. of genera with sesquiterpene lactones	Type of lactones present
Eupatorieae (50)	4	Germacranolides Elemanolides Guaianolides Ambrosanolides Seco-Ambrosanolides

Vernonieae (50)	4	Germacranolides Elemanolides Guaianolides
Astereae (100)	1	Germacranolides Guaianolides Elemanolides
Inuleae (100)	5	Guaianolides Xanthanolides Ambrosanolides Helenanolides Seco-Eudesmanolides Seco-Ambrosanolides Germacranolides
Heliantheae (250)	24	Elemanolides Guaianolides Eudesmanolides Xanthanolides Ambrosanolides Helenanolides Seco-Eudesmanolides Seco-Ambrosanolides Seco-Helenanolides
Senecioneae (50)	4	Germacranolides Xanthanolides Eremophilanolides Helenanolides Bakkenolides
Anthemideae (50)	10	Germacranolides Elemanolides Guaianolides Helenanolides Cadinanolides Chrymoranolides
Arcototeae-Calenduleae (50)	1	Guaianolides

Cynareae (50)	8	Germacranolides Elemnolides Guaianolides Eudesmanolides
Mutisieae (55)	1	Eudesmanolides
Lactuceae (75)	7	Germanocranolides Eudesmanolides Guaianolides

[\[General description\]](#) [\[Representative Structure\]](#) [\[Distribution\]](#) [\[Biological activity\]](#)
[\[Poisons\]](#)

BIOLOGICAL ACTIVITY

The sesquiterpene lactones are highly irritating to the nose, eyes, and gastrointestinal tract. **Sheep** and **goats** are the main livestock species affected, primarily because the plants are unpalatable and rarely consumed in toxic quantities by **cattle** and **horses**. Sneezeweed poisoning is often referred to as "spewing sickness" because of the characteristic vomiting seen. Affected **sheep** may have a green stain around the mouth and stand with upturned heads attempting to retain the regurgitated plant material. Vomited material is often inhaled into the lungs, causing either death from inhalation pneumonia or permanent lung damage accompanied by chronic coughing. Primary lesions are gastrointestinal tract irritation, congestion of the liver and kidney, and pulmonary damage.

Since many sesquiterpene lactones are also **antimicrobial agents**, it is possible that they also exert their action by altering the microbial composition of rumen and thus affecting its vital metabolic function. Hence, rumen dysfunction may contribute to the toxicity caused by sesquiterpene lactones in livestock. They are also **neurotoxic**; a SQL, repin, has been implicated in causing a syndrome similar to Parkinson's disease in **horses**.

Livestock poisoning from foraging on bitter tasting plants of the family of Compositae is well documented. Besides its deleterious effects on domestic animals, it is well reported that many Compositae plants containing sesquiterpene lactones are also toxic to wild animals.

The toxicity of sesquiterpene lactones is due to [binding](#) of the exocyclic methylene group with tissue constituents, such as sulphhydryl groups and other nucleophilic components.

[\[General description\]](#) [\[Representative Structure\]](#) [\[Distribution\]](#) [\[Biological activity\]](#)
[\[Poisons\]](#)

SESQUITERPENE LACTONES PRESENT IN SPECIES OF COMPOSITAE POISONOUS TO ANIMALS.

Plant	Sesquiterpene lactones	Species affected
Baccharis cardifolia Tanacetum vulgare	Baccharis oil	Sheep, Cattle
Eupatorium urticifolium	Eupatorin	Cattle, Sheep, Goats
Geigeria sp.	Geigerin, Vermeerin	Sheep
Asteraceae growing in wild state		Herbivorous, animals in wild state
Hymenoxys odorata	Hymenolide Hymenoxin Odoratin Paucin Vermeerin Hymenovin	Sheep, Cattle
Hymenoxys richardsoni	Vermeerin Psilotropin	Sheep, Cattle
Helenium autumnale	Helenalin Mexicanin-E Bigelovin Tenulin Isotenulin	Sheep, Cattle
Centaurea solstitialis	Cynaropicrin	Horse
Lactuca virosa	Lactucin	Cattle

[Top of Page](#)

[\[General description\]](#) [\[Representative Structure\]](#) [\[Distribution\]](#) [\[Biological activity\]](#)

[\[Poisons\]](#)

This series of web pages was created by Stefania Carpino, an undergraduate student at Cornell University for the AS625 class. All comments and suggestions are welcome.

WARNING: These web pages are only meant to be informative. Neither Cornell University nor the author of this site endorse or recommend the use of these plants.

Return to:

[Return to Toxic Agents List](#)

[Poisonous Plants Homepage](#)

Home page: [Animal Science at Cornell University](#)

For problems or comments on this web page, contact the Animal Science [Webmaster](#)



Cornell University

Poisonous Plants Informational Database



Search for species like 'human'

Click on the scientific name to view the image(s). These links require [JavaScript](#) to be enabled in your browser.

REMEMBER to close each window after viewing

Scientific Name	Common Name(s)	Species Most Often Affected	Parts Poisonous	Primary Poison(s)
Abrus precatorius	Rosary Pea	all	seeds	abrin
Aconitum spp.	Monkshood, Aconite, or Wolfsbane	humans, cattle, goats	leaves, roots, all	aconitine
Aesculus spp.	Horse Chestnut, Buckeye	humans, cattle, goats	fruit	Unknown, possibly saporins, narcotic alkaloids, or glycosides.
Agrostemma githago	Corn Cockle	poultry, cattle, humans, goats	seeds	githagin
Amanita spp.	Monkey Agaric, Panther Cap, Death Cap, and Death Angel Mushrooms	all	cap?	toxalbumin
A. muscaria	Fly Agaric	all	cap?	ibotenic acid and muscimol
A. pantherina	Panther	all	cap?	ibotenic acid and muscimol
A. verna	Destroying Angels	all	cap?	ibotenic acid and muscimol
Apocynum spp.	Dogbane	horses, cattle, humans, sheep, cats, dogs, goats	rhizome	apocynamarin
Arisaema spp.	Jack in the Pulpit	humans	all	oxalate
Atropa belladonna	Belladonna or Deadly Nightshade	humans, goats	all	atropine and scopolamine

Brassica spp.	Rape, Cabbage, Turnips, Broccoli, Mustard	cattle, humans, swine, sheep, goats, poultry	roots, seeds	glucosinolates, brassica, anemia factor
Chelidonium majus	Celandine	cattle, humans	roots	isoquinoline alkoids
Chenopodium album	Lamb's Quarters	cattle, horses, humans, sheep, swine	all	nitrates
Cicuta spp.	Water Hemlock or Cowbane	all	roots, all	cicutoxin
Claviceps spp.	Ergot	all	fungus	indole alkaloid
Conium maculatum	Poison Hemlock	all	all	coniine
Convallaria majalis	Lily of the Valley	cats, dogs, humans, goats	all	cardiac glycosides and saponins
Daphne spp.	Daphne	cats, dogs, humans	berries, all	mezereinic acid anhydride
Datura spp.	Jimsonweed, Downy Thornapple, Devil's Trumpet, Angel's Trumpet	cattle, humans, horses, goats	flowers, leaves, seeds	atropine, scopolamine, and hyoscyamine
Delphinium spp.	Delphiniums and Larkspurs	cattle, humans, goats	all	alkaloids delphinine, ajacine, and others
Dicentra spp.	Bleeding Heart, Squirrel Corn, Dutchman's Breeches	cats, cattle, humans	all	isoquinolone alkaloids
Digitalis purpurea	Foxglove	cats, cattle, dogs, goats, horses, humans	flowers, leaves, seeds	cardiac or steroid glycosides
Eupatorium rugosum	White Snakeroot	cattle, dogs, goats, horses, humans, rabbits, sheep	all	tremetone

Euphorbia spp.	Poinsettia, Spurges, Snow on the Mountain	cattle, horses, humans, sheep	leaves, stems and sap	phorbol esters
Helleborus niger	Christmas Rose	humans	all	protoanemonin
Hyoscyamus niger	Henbane	humans	seeds	atropine, scopolamine, and hyoscyamine.
Iris spp.	Irises	cattle, humans, swine	rhizomes and rootstocks	irisin, iridin, or irisine
Laburnum anagyroides	Golden Chain or Laburnum	cattle, dogs, horses, humans, swine	Pods, seeds, all	cytisine
Lantana camara	Lantana, Red Sage, Yellow Sage, or West Indian Lantana	cattle, dogs, goats, cats, humans, sheep	unripe, green berries	triterpenes
Lathyrus spp.	Sweet Pea, Tangier Pea, Everlasting Pea, Caley Pea and Singletary Pea	horses, rodents, turkeys, sheep, humans	seeds	DABA, ODAP, amine, phenol, glycoside
Lobelia spp.	Great Lobelia, Cardinal Flower, and Indian Tobacco	humans, goats	all	lobelamine, lobeline
Medicago sativa	Alfalfa or Lucerne	cattle, chickens, humans, sheep	all	canavanine, saponins
Menispermum canadense	Moonseed	humans, goats	all	dauricine
Nerium oleander	Oleander	horses, cattle, sheep, dogs, humans, goats	all, leaves, stems	nerioside, oleandroside, saponins, cardiac glycosides
Nicotiana spp.	Tobacco and Tree Tobacco	humans, swine	leaves	nicotine, pyridine
Ornithogalum umbellatum	Star of Bethlehem	humans	bulbs, flowers, all	convallatoxin, convallaside

Papaver spp.	Various Poppies including Opium Poppy	cattle, humans	all	codine, morphine, protopine
Phytolacca americana	Pokeweed	cattle, sheep, humans, turkeys, swine, horses	all	phytolaccatoxin, phytolaccigenin
Podophyllum peltatum	Mayapple and Mandrake	cattle, humans, swine	all	alpha- and beta- peltatin, podophylloresin
Pteridium aquilinum	Bracken Fern	horse, cattle, sheep, humans, swine	all	prunasin, ptaquiloside, thiaminase
Rheum rhaponticum	Rhubarb	goats, humans, swine, horses	leaves	anthraquinones, oxalate
Ricinus communis	Castor Bean	all	seeds	ricin, albumin
Robinia pseudoacacia	Black Locust	horses, cattle, humans, poultry, sheep, goats	bark, leaves, seeds	robin, phasin
Sambucus canadensis	Elderberry	cattle, humans, goats	leaves, twigs, roots, unripe fruits	sambunigrin
Senecio spp.	Senecio, Groundsels, and Ragworts	horse, cattle, goats, sheep, human	leaves	jacobine, seneciphylline
Solanum spp.	Common Nightshade, Black Nightshade, Horse Nettle, Buffalo Bur, Potato	cattle, humans, rodents, sheep, horses, goats	leaves, immature fruit	soladulcidine, solanine
Symplocarpus foetidus	Eastern Skunk Cabbage	human	all	oxalate
Taxus cuspidata	Yew	all	leaves, seeds, twigs	taxine
Toxicodendron diversiloba	Poison oak	humans		

Toxicodendron radicans	Poison ivy	humans		
Toxicodendron vernix	Poison Sumac	humans		
Urtica spp.	Stinging Nettle	dogs, humans	hairs	acetylcholine, histamine, 5-hydroxytryptamine
Vicia spp.	Common Vetch, Hairy Vetch, Narrow leaved Vetch, Purple Vetch and Broad Beans	chickens, horses, humans	seeds	beta-cyano-L-alanine
Wisteria spp.	Wisteria	humans	all, flowers, seeds, leaves	wistarine
Xanthium strumarium	Cocklebur	cattle, humans, rodents, swine	seedlings, seeds	carboxyatractyloside
Zigadenus spp.	Death Camas	all	all, bulbs, leaves, flowers, pollen	zygacine

[Return to Main Search Page](#)



Cornell University

Poisonous Plants Informational Database



Plants of concern to ruminants...

Toxins that Affect the Ruminant

The ruminal microorganisms metabolize most of the naturally occurring toxins present in feeds to metabolites which do not pose a threat to the animal's health and thus are considered the first line of defence against natural toxicity. However, some compounds are metabolized to toxic metabolites in the rumen or inhibit the production of other essential compounds thereby causing distress in the animal. Diverse examples of naturally occurring toxins and the biochemical mechanisms by which they are detoxified in the rumen are going to be considered.

Ruminants acquire tolerance to increased concentrations of toxic materials in feeds. Increased tolerance to toxins can be related to a change in the microbial population in the rumen. Some of the toxins present in feeds that affect the performance of the ruminant animal include [oxalates](#), [nitrates](#), [pirrolizidine alkaloids](#), [mimosine](#), [phyto-oestrogens](#), [tryptophan](#), [SMCO](#), [phenolic monomers](#), and [mycotoxins](#).

This series of web pages was created by Manuel Hernandez, an undergraduate student at Cornell University for the AS625 class. All comments and suggestions are welcome.

WARNING: These web pages are only meant to be informative. Neither Cornell University nor the author of this site endorse or recommend the use of these plants.

Return to: [\[List of Toxic Agents\]](#) [\[Poisonous Plants Homepage\]](#)

Home page: [Animal Science at Cornell University](#)

For problems or comments on this web page, contact the Animal Science [Webmaster](#)

[A. muscaria](#)
[A. pantherina](#)
[A. verna](#)
[Abrus precatorius](#)
[Aconitum spp.](#)
[Aesculus spp.](#)
[Agrostemma githago](#)
[Allium spp.](#)
[Amanita spp.](#)
[Amaranthus spp.](#)
[Amsinckia intermedia](#)
[Apocynum spp.](#)
[Argemone mexicana](#)
[Asclepias spp.](#)
[Astragalus and Oxytropis spp.](#)
[Atropa belladonna](#)
[Brassica spp.](#)
[Cannabis sativa](#)
[Chelidonium majus](#)
[Chenopodium album](#)
[Cicuta spp.](#)
[Claviceps spp.](#)
[Conium maculatum](#)
[Convallaria majalis](#)
[Datura spp.](#)
[Delphinium spp.](#)
[Dicentra spp.](#)
[Digitalis purpurea](#)
[Eupatorium rugosum](#)
[Euphorbia spp.](#)
[Fagopyrum esculentum](#)
[Festuca arundinacea](#)
[Gelsemium sempervirens](#)
[Glechoma spp.](#)
[Halogeton glomeratus](#)
[Hypericum perforatum](#)
[Iris spp.](#)
[Laburnum anagyroides](#)
[Lantana camara](#)
[Lathyrus spp.](#)
[Leucothoe axillaris and](#)
[Leucothoe davisiae](#)
[Linum usitatissimum](#)

[Lobelia spp.](#)

[Lotus corniculatus](#)

[Lupinus spp.](#)

[Medicago sativa](#)

[Menispermum canadense](#)

[Metilotus alba and](#)

[Melilotus officinalis](#)

[Nerium oleander](#)

[Papaver spp.](#)

[Phytolacca americana](#)

[Pinus ponderosa](#)

[Podophyllum peltatum](#)

[Prunus spp.](#)

[Pteridium aquilinum](#)

[Quercus spp.](#)

[Ranunculus spp.](#)

[Rheum rhaponticum](#)

[Ricinus communis](#)

[Robinia pseudoacacia](#)

[Rumex spp.](#)

[Sambucus canadensis](#)

[Sanquinaria canadensis](#)

[Senecio spp.](#)

[Solanum spp.](#)

[Sorghum spp.](#)

[Taxus cuspidata](#)

[Tetradymia spp.](#)

[Trifolium spp.](#)

[Triglochin maritima](#)

[Veratrum californicum](#)

[Xanthium strumarium](#)

[Zigadenus spp.](#)



Cornell University

Poisonous Plants Informational Database



Search for species like 'cattle'

Click on the scientific name to view the image(s). These links require [JavaScript](#) to be enabled in your browser.

REMEMBER to close each window after viewing

Scientific Name	Common Name(s)	Species Most Often Affected	Parts Poisonous	Primary Poison(s)
Abrus precatorius	Rosary Pea	all	seeds	abrin
Aconitum spp.	Monkshood, Aconite, or Wolfsbane	humans, cattle, goats	leaves, roots, all	aconitine
Aesculus spp.	Horse Chestnut, Buckeye	humans, cattle, goats	fruit	Unknown, possibly saportins, narcotic alkaloids, or glycosides.
Agrostemma githago	Corn Cockle	poultry, cattle, humans, goats	seeds	githagin
Allium spp.	Commercial Onions, Wild Onions, Swamp Onions, and Chives	cattle, horses, children	bulbs, lleaves	SMCO
Amanita spp.	Monkey Agaric, Panther Cap, Death Cap, and Death Angel Mushrooms	all	cap?	toxalbumin
A. muscaria	Fly Agaric	all	cap?	ibotenic acid and muscimol
A. pantherina	Panther	all	cap?	ibotenic acid and muscimol
A. verna	Destroying Angels	all	cap?	ibotenic acid and muscimol
Amaranthus spp.	Pigweed	cattle, swine	leaves	nitrate
Amsinckia intermedia	Fiddleneck	horses, swine, cattle	seeds	intermedine, lycopsamine
Apocynum spp.	Dogbane	horses, cattle, humans, sheep, cats, dogs, goats	rhizome	apocynamarin
Asclepias spp.	Milkweed	sheep, cattle, goats	leaves, fruits, stems	desglucosyrioside, syrioside

Astragalus and Oxytropis spp.	Locoweed	horse, sheep, cattle	flowers, leaves, stems	selenium, nitro compounds, swainsonine
Brassica spp.	Rape, Cabbage, Turnips, Broccoli, Mustard	cattle, humans, swine, sheep, goats, poultry	roots, seeds	glucosinolates, brassica, anemia factor
Chelidonium majus	Celandine	cattle, humans	roots	isoquinoline alkoids
Chenopodium album	Lamb's Quarters	cattle, horses, humans, sheep, swine	all	nitrates
Cicuta spp.	Water Hemlock or Cowbane	all	roots, all	cicutoxin
Claviceps spp.	Ergot	all	fungus	indole alkaloid
Conium maculatum	Poison Hemlock	all	all	coniine
Datura spp.	Jimsonweed, Downy Thornapple, Devil's Trumpet, Angel's Trumpet	cattle, humans, horses, goats	flowers, leaves, seeds	atropine, scopolamine, and hyoscyamine
Delphinium spp.	Delphiniums and Larkspurs	cattle, humans, goats	all	alkaloids delphinine, ajacine, and others
Dicentra spp.	Bleeding Heart, Squirrel Corn, Dutchman's Breeches	cats, cattle, humans	all	isoquinolone alkaloids
Digitalis purpurea	Foxglove	cats, cattle, dogs, goats, horses, humans	flowers, leaves, seeds	cardiac or steroid glycosides
Eupatorium rugosum	White Snakeroot	cattle, dogs, goats, horses, humans, rabbits, sheep	all	tremetone
Euphorbia spp.	Poinsettia, Spurge, Snow on the Mountain	cattle, horses, humans, sheep	leaves, stems and sap	phorbol esters
Festuca arundinacea	Tall Fescue	cattle, horses	all	diaziphenanthrene, pyrrolizidine, and ergot
Halogeton glomeratus	Halogeton	sheep, cattle	leaves, stems	soluble oxalates
Iris spp.	Irises	cattle, humans, swine	rhizomes and rootstocks	irisin, iridin, or irisine

Laburnum anagyroides	Golden Chain or Laburnum	cattle, dogs, horses, humans, swine	Pods, seeds, all	cytisine
Lantana camara	Lantana, Red Sage, Yellow Sage, or West Indian Lantana	cattle, dogs, goats, cats, humans, sheep	unripe, green berries	triterpenes
Linum usitatissimum	Flax	cattle, sheep	all	cyanogenic glycoside
Lotus corniculatus	Birdsfoot Trefoil	cattle, sheep		CN tannini
Lupinus spp.	Lupine	cattle, goats	seeds	lupinine, anagyrine, sparteine, and hydroxylupanine
Medicago sativa	Alfalfa or Lucerne	cattle, chickens, humans, sheep	all	canavanine, saponins
Melilotus alba and Melilotus officinalis	White and Yellow Sweetclover	horses, cattle, sheep	stem	dicoumarol
Nerium oleander	Oleander	horses, cattle, sheep, dogs, humans, goats	all, leaves, stems	nerioside, oleandroside, saponins, cardiac glycosides
Papaver spp.	Various Poppies including Opium Poppy	cattle, humans	all	codine, morphine, protopine
Phytolacca americana	Pokeweed	cattle, sheep, humans, turkeys, swine, horses	all	phytolaccatoxin, phytolaccigenin
Pinus ponderosa	Ponderosa Pine	cattle	needles, young shoots	unknown
Podophyllum peltatum	Mayapple and Mandrake	cattle, humans, swine	all	alpha- and beta- peltatin, podophylloresin
Prunus spp.	Wild Cherries, Black Cherry, Bitter Cherry, Choke Cherry, Pin Cherry	horses, cattle, moose, sheep, swine, goats	seeds, leaves	amygdalin, prunasin
Pteridium aquilinum	Bracken Fern	horse, cattle, sheep, humans, swine	all	prunasin, ptaquiloside, thiaminase
Quercus spp.	Oak Trees	horse, cattle	acorns, young leaves	gallotannins, quercitrin, and quercetin
Ranunculus spp.	Buttercups or Crowfoot	cattle, goats, horses	all	protoanemonin

Ricinus communis	Castor Bean	all	seeds	ricin, albumin
Robinia pseudoacacia	Black Locust	horses, cattle, humans, poultry, sheep, goats	bark, leaves, seeds	robin, phasin
Rumex spp.	Dock	cattle, sheep	leaves	soluble oxalates
Sambucus canadensis	Elderberry	cattle, humans, goats	leaves, twigs, roots, unripe fruits	sambunigrin
Senecio spp.	Senecio, Groundsels, and Ragworts	horse, cattle, goats, sheep, human	leaves	jacobine, seneciphylline
Solanum spp.	Common Nightshade, Black Nightshade, Horse Nettle, Buffalo Bur, Potato	cattle, humans, rodents, sheep, horses, goats	leaves, immature fruit	soladulcidine, solanine
Sorghum spp.	Sorghum or Milo, Sudan Grass, and Johnson Grass	horses, cattle, goats	leaves, stems	dhurrin, nitrate
Taxus cuspidata	Yew	all	leaves, seeds, twigs	taxine
Tetradymia spp.	Horsebrush	sheep, cattle	leaves	
Trifolium spp.	Alsike Clover, Red Clover, White Clover	horse, cattle	all, leaves	nitrate
Triglochin maritima	Arrowgrass	cattle, sheep	all, leaves, flowers	taxiphillin, triglochinin
Xanthium strumarium	Cocklebur	cattle, humans, rodents, swine	seedlings, seeds	carboxyatractyloside
Zigadenus spp.	Death Camas	all	all, bulbs, leaves, flowers, pollen	zygacine

[Return to Main Search Page](#)



Cornell University Poisonous Plants Informational Database



Plants of concern to goat owners...

Toxic Plants and the Common Caprine

Unlike the public's vision of a goat, the cast iron-stomached beast that can eat everything from a tin can to plastic wrapping, there are many things that can kill a goat. Some poison plants are ingested by accident, while browsing, but a major reason for the toxic poisoning of goats comes as a result of starvation.

As with all nutritional toxicology, it is the size of the dose, and the poison present in the plant that will determine whether the animal lives or dies. This web page is devoted to the caprine species, and to many of the plants out there that can kill them. It gives a fairly comprehensive list of plants commonly found in areas with goats, but it is not complete.



[List of toxicants in plants poisonous to goats](#)

This list comes from an old Dairy Goat Management book that I had kicking around at home, and may be incomplete. For a more comprehensive, and more scientific list, consult Mary Smith, and David Sherman's *Goat Medicine*.

This series of web pages was created by Kevin Kirchofer, an undergraduate student at Cornell University for the AS625 class. All comments and suggestions are welcome.

WARNING: These web pages are only meant to be informative. Neither Cornell University nor the author of this site endorse or recommend the use of these plants.

Return to: [\[List of Toxic Agents\]](#) [\[Poisonous Plants Homepage\]](#)
Home page: [Animal Science at Cornell University](#)

For problems or comments on this web page, contact the Animal Science [Webmaster](#)

[A. muscaria](#)
[A. pantherina](#)
[A. verna](#)
[Abrus precatorius](#)
[Aconitum spp.](#)
[Aesculus spp.](#)
[Agrostemma githago](#)
[Amanita spp.](#)
[Apocynum spp.](#)
[Argemone mexicana](#)
[Asclepias spp.](#)
[Atropa belladonna](#)
[Brassica spp.](#)
[Cannabis sativa](#)
[Cicuta spp.](#)
[Claviceps spp.](#)
[Conium maculatum](#)
[Convallaria majalis](#)
[Datura spp.](#)
[Delphinium spp.](#)
[Digitalis purpurea](#)
[Eupatorium rugosum](#)
[Fagopyrum esculentum](#)
[Gelsemium sempervirens](#)
[Glechoma spp.](#)
[Hypericum perforatum](#)
[Lantana camara](#)
[Leucothoe axillaris and](#)
[Leucothoe davisiae](#)
[Lobelia spp.](#)
[Lupinus spp.](#)
[Menispermum canadense](#)
[Nerium oleander](#)
[Prunus spp.](#)
[Ranunculus spp.](#)
[Rheum rhaponticum](#)
[Ricinus communis](#)
[Robinia pseudoacacia](#)
[Sambucus canadensis](#)
[Sanquinaria canadensis](#)
[Senecio spp.](#)
[Solanum spp.](#)
[Sorghum spp.](#)
[Taxus cuspidata](#)

[Zigadenus spp.](#)



Cornell University

Poisonous Plants Informational Database



Search for species like 'sheep'

Click on the scientific name to view the image(s). These links require [JavaScript](#) to be enabled in your browser.

REMEMBER to close each window after viewing

Scientific Name	Common Name(s)	Species Most Often Affected	Parts Poisonous	Primary Poison(s)
Abrus precatorius	Rosary Pea	all	seeds	abrin
Amanita spp.	Monkey Agaric, Panther Cap, Death Cap, and Death Angel Mushrooms	all	cap?	toxalbumin
A. muscaria	Fly Agaric	all	cap?	ibotenic acid and muscimol
A. pantherina	Panther	all	cap?	ibotenic acid and muscimol
A. verna	Destroying Angels	all	cap?	ibotenic acid and muscimol
Apocynum spp.	Dogbane	horses, cattle, humans, sheep, cats, dogs, goats	rhizome	apocynamarin
Asclepias spp.	Milkweed	sheep, cattle, goats	leaves, fruits, stems	desglucosyrioside, syrioside
Astragalus and Oxytropis spp.	Locoweed	horse, sheep, cattle	flowers, leaves, stems	selenium, nitro compounds, swainsonine
Brassica spp.	Rape, Cabbage, Turnips, Broccoli, Mustard	cattle, humans, swine, sheep, goats, poultry	roots, seeds	glucosinolates, brassica, anemia factor
Chenopodium album	Lamb's Quarters	cattle, horses, humans, sheep, swine	all	nitrates
Cicuta spp.	Water Hemlock or Cowbane	all	roots, all	cicutoxin
Claviceps spp.	Ergot	all	fungus	indole alkaloid
Conium maculatum	Poison Hemlock	all	all	coniine

Eupatorium rugosum	White Snakeroot	cattle, dogs, goats, horses, humans, rabbits, sheep	all	tremetone
Euphorbia spp.	Poinsettia, Spurges, Snow on the Mountain	cattle, horses, humans, sheep	leaves, stems and sap	phorbol esters
Halogeton glomeratus	Halogeton	sheep, cattle	leaves, stems	soluble oxalates
Hypericum perforatum	St. Johns Wort, Klamath Weed	horses, sheep, goats	all	hypericum
Lantana camara	Lantana, Red Sage, Yellow Sage, or West Indian Lantana	cattle, dogs, goats, cats, humans, sheep	unripe, green berries	triterpenes
Lathyrus spp.	Sweet Pea, Tangier Pea, Everlasting Pea, Caley Pea and Singletary Pea	horses, rodents, turkeys, sheep, humans	seeds	DABA, ODAP, amine, phenol, glycoside
Leucothoe axillaris and Leucothoe davisiae	Drooping Leucothoe and Sierra Laurel	goats, sheep	leaves, nectar	andromedotoxin
Linum usitatissimum	Flax	cattle, sheep	all	cyanogenic glycoside
Lotus corniculatus	Birdsfoot Trefoil	cattle, sheep		CN tannini
Medicago sativa	Alfalfa or Lucerne	cattle, chickens, humans, sheep	all	canavanine, saponins
Melilotus alba and Melilotus officinalis	White and Yellow Sweetclover	horses, cattle, sheep	stem	dicoumarol
Nerium oleander	Oleander	horses, cattle, sheep, dogs, humans, goats	all, leaves, stems	nerioside, oleandroside, saponins, cardiac glycosides
Phytolacca americana	Pokeweed	cattle, sheep, humans, turkeys, swine, horses	all	phytolaccatoxin, phytolaccigenin
Prunus spp.	Wild Cherries, Black Cherry, Bitter Cherry, Choke Cherry, Pin Cherry	horses, cattle, moose, sheep, swine, goats	seeds, leaves	amygdalin, prunasin

Pteridium aquilinum	Bracken Fern	horse, cattle, sheep, humans, swine	all	prunasin, ptaquiloside, thiaminase
Ricinus communis	Castor Bean	all	seeds	ricin, albumin
Robinia pseudoacacia	Black Locust	horses, cattle, humans, poultry, sheep, goats	bark, leaves, seeds	robin, phasin
Rumex spp.	Dock	cattle, sheep	leaves	soluble oxalates
Senecio spp.	Senecio, Groundsels, and Ragworts	horse, cattle, goats, sheep, human	leaves	jacobine, seneciphylline
Solanum spp.	Common Nightshade, Black Nightshade, Horse Nettle, Buffalo Bur, Potato	cattle, humans, rodents, sheep, horses, goats	leaves, immature fruit	soladulcidine, solanine
Taxus cuspidata	Yew	all	leaves, seeds, twigs	taxine
Tetradymia spp.	Horsebrush	sheep, cattle	leaves	
Triglochin maritima	Arrowgrass	cattle, sheep	all, leaves, flowers	taxiphillin, triglochinin
Veratrum californicum	Corn Lily, False Hellbore	sheep	all	cylcopamine
Zigadenus spp.	Death Camas	all	all, bulbs, leaves, flowers, pollen	zygacine

[Return to Main Search Page](#)



Cornell University Poisonous Plants Informational Database



Plants of concern to horse owners...

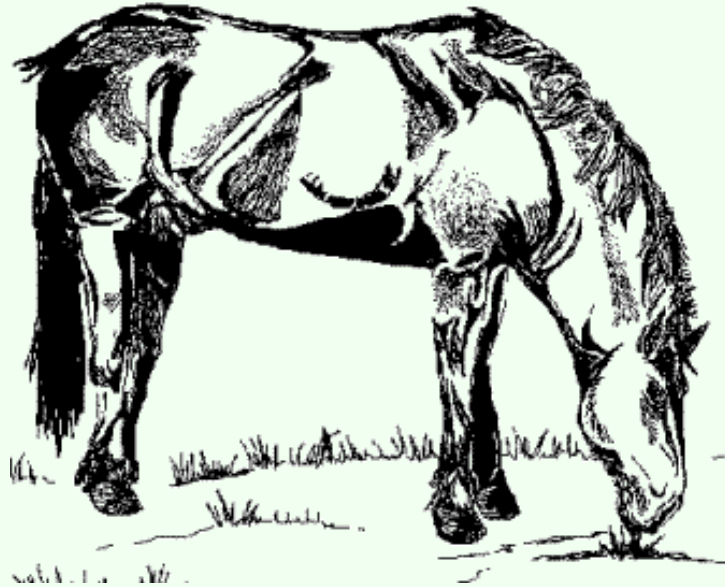

There are many poisonous plants and substances which are not represented here. Please do not assume that a specific plant is ok just because it is not listed.

[A. muscaria](#)
[A. pantherina](#)
[A. verna](#)
[Abrus precatorius](#)
[Acer rubrum](#)
[Acer saccharinum](#)
[Acer saccharum](#)
[Allium spp.](#)
[Amanita spp.](#)
[Amsinckia intermedia](#)
[Apocynum spp.](#)
[Astragalus and Oxytropis spp.](#)
[Centaurea solstitialis](#)
[Chenopodium album](#)
[Cicuta spp.](#)
[Claviceps spp.](#)
[Conium maculatum](#)
[Coronilla varia](#)
[Datura spp.](#)
[Digitalis purpurea](#)
[Equisetum arvense and other spp.](#)
[Eupatorium rugosum](#)
[Euphorbia spp.](#)
[Fagopyrum esculentum](#)
[Festuca arundinacea](#)
[Gelsemium sempervirens](#)
[Glechoma spp.](#)
[Hypericum perforatum](#)
[Laburnum anagyroides](#)
[Lathyrus spp.](#)
[Metilotus alba and Melilotus officinalis](#)
[Nerium oleander](#)
[Onoclea sensibilis](#)
[Phytolacca americana](#)
[Prunus spp.](#)
[Pteridium aquilinum](#)
[Quercus spp.](#)
[Ranunculus spp.](#)
[Rheum rhaponticum](#)
[Ricinus communis](#)
[Robinia pseudoacacia](#)

Return to: [Poisonous Plants Homepage](#)
Home page: [Animal Science at Cornell University](#)

For problems or comments on this web page, contact the Animal Science [Webmaster](#)

[*Senecio spp.*](#)

[*Solanum spp.*](#)

[*Sorghum spp.*](#)

[*Taxus cuspidata*](#)

[*Trifolium spp.*](#)

[*Vicia spp.*](#)

[*Zigadenus spp.*](#)



Cornell University

Poisonous Plants Informational Database



Search for species like 'poultry'

Click on the scientific name to view the image(s). These links require [JavaScript](#) to be enabled in your browser.

REMEMBER to close each window after viewing

Scientific Name	Common Name(s)	Species Most Often Affected	Parts Poisonous	Primary Poison(s)
Abrus precatorius	Rosary Pea	all	seeds	abrin
Agrostemma githago	Corn Cockle	poultry, cattle, humans, goats	seeds	githagin
Amanita spp.	Monkey Agaric, Panther Cap, Death Cap, and Death Angel Mushrooms	all	cap?	toxalbumin
A. muscaria	Fly Agaric	all	cap?	ibotenic acid and muscimol
A. pantherina	Panther	all	cap?	ibotenic acid and muscimol
A. verna	Destroying Angels	all	cap?	ibotenic acid and muscimol
Brassica spp.	Rape, Cabbage, Turnips, Broccoli, Mustard	cattle, humans, swine, sheep, goats, poultry	roots, seeds	glucosinolates, brassica, anemia factor
Cicuta spp.	Water Hemlock or Cowbane	all	roots, all	cicutoxin
Claviceps spp.	Ergot	all	fungus	indole alkaloid
Conium maculatum	Poison Hemlock	all	all	coniine
Ricinus communis	Castor Bean	all	seeds	ricin, albumin
Robinia pseudoacacia	Black Locust	horses, cattle, humans, poultry, sheep, goats	bark, leaves, seeds	robin, phasin
Taxus cuspidata	Yew	all	leaves, seeds, twigs	taxine
Zigadenus spp.	Death Camas	all	all, bulbs, leaves, flowers, pollen	zygacine

[Return to Main Search Page](#)



Cornell University

Poisonous Plants Informational Database



Search for species like 'swine'

Click on the scientific name to view the image(s). These links require [JavaScript](#) to be enabled in your browser.

REMEMBER to close each window after viewing

Scientific Name	Common Name(s)	Species Most Often Affected	Parts Poisonous	Primary Poison(s)
Abrus precatorius	Rosary Pea	all	seeds	abrin
Amanita spp.	Monkey Agaric, Panther Cap, Death Cap, and Death Angel Mushrooms	all	cap?	toxalbumin
A. muscaria	Fly Agaric	all	cap?	ibotenic acid and muscimol
A. pantherina	Panther	all	cap?	ibotenic acid and muscimol
A. verna	Destroying Angels	all	cap?	ibotenic acid and muscimol
Amaranthus spp.	Pigweed	cattle, swine	leaves	nitrate
Amsinckia intermedia	Fiddleneck	horses, swine, cattle	seeds	intermedine, lycopsamine
Brassica spp.	Rape, Cabbage, Turnips, Broccoli, Mustard	cattle, humans, swine, sheep, goats, poultry	roots, seeds	glucosinolates, brassica, anemia factor
Chenopodium album	Lamb's Quarters	cattle, horses, humans, sheep, swine	all	nitrates
Cicuta spp.	Water Hemlock or Cowbane	all	roots, all	cicutoxin
Claviceps spp.	Ergot	all	fungus	indole alkaloid
Conium maculatum	Poison Hemlock	all	all	coniine
Iris spp.	Irises	cattle, humans, swine	rhizomes and rootstocks	irisin, iridin, or irisine

Laburnum anagyroides	Golden Chain or Laburnum	cattle, dogs, horses, humans, swine	Pods, seeds, all	cytisine
Nicotiana spp.	Tobacco and Tree Tobacco	humans, swine	leaves	nicotine, pyridine
Phytolacca americana	Pokeweed	cattle, sheep, humans, turkeys, swine, horses	all	phytolaccatoxin, phytolaccigenin
Podophyllum peltatum	Mayapple and Mandrake	cattle, humans, swine	all	alpha- and beta- peltatin, podophylloresin
Prunus spp.	Wild Cherries, Black Cherry, Bitter Cherry, Choke Cherry, Pin Cherry	horses, cattle, moose, sheep, swine, goats	seeds, leaves	amygdalin, prunasin
Pteridium aquilinum	Bracken Fern	horse, cattle, sheep, humans, swine	all	prunasin, ptaquiloside, thiaminase
Rheum rhaponticum	Rhubarb	goats, humans, swine, horses	leaves	anthraquinones, oxalate
Ricinus communis	Castor Bean	all	seeds	ricin, albumin
Taxus cuspidata	Yew	all	leaves, seeds, twigs	taxine
Xanthium strumarium	Cocklebur	cattle, humans, rodents, swine	seedlings, seeds	carboxyatractyloside
Zigadenus spp.	Death Camas	all	all, bulbs, leaves, flowers, pollen	zygacine

[Return to Main Search Page](#)



Cornell University Poisonous Plants Informational Database



[A. muscaria](#)
[A. pantherina](#)
[A. verna](#)
[Abrus precatorius](#)
[Amanita spp.](#)
[Apocynum spp.](#)
[Cannabis sativa](#)
[Cicuta spp.](#)
[Claviceps spp.](#)
[Conium maculatum](#)
[Convallaria majalis](#)
[Daphne spp.](#)
[Dicentra spp.](#)
[Digitalis purpurea](#)
[Lantana camara](#)
[Ricinus communis](#)
[Taxus cuspidata](#)
[Zigadenus spp.](#)

Plants of concern to cat owners...

There are many poisonous plants and substances which are not represented here. Please do not assume that a specific plant is ok just because it is not listed.

[Common Cat Toxicities](#) (non-plant)

Return to: [Poisonous Plants Homepage](#)

Home page: [Animal Science at Cornell University](#)

For problems or comments on this web page, contact the Animal Science [Webmaster](#)





Cornell University Poisonous Plants Informational Database



Plants of concern to dog owners...

There are many poisonous plants and substances which are not represented here. Please do not assume that a specific plant is ok just because it is not listed.



[Common Dog Toxicities](#) (non-plant)

Return to: [Poisonous Plants Homepage](#)

Home page: [Animal Science at Cornell University](#)

For problems or comments on this web page, contact the Animal Science [Webmaster](#)

[A. muscaria](#)

[A. pantherina](#)

[A. verna](#)

[Abrus precatorius](#)

[Amanita spp.](#)

[Apocynum spp.](#)

[Cannabis sativa](#)

[Cicuta spp.](#)

[Claviceps spp.](#)

[Conium maculatum](#)

[Convallaria majalis](#)

[Daphne spp.](#)

[Digitalis purpurea](#)

[Eupatorium rugosum](#)

[Laburnum anagyroides](#)

[Lantana camara](#)

[Nerium oleander](#)

[Ricinus communis](#)

[Taxus cuspidata](#)

[Urtica spp.](#)

[Zigadenus spp.](#)

Be Careful of What You Feed to Your Green Iguana



Photo by Chris Estep and Wendell Leopard

Or He May Look Like This!!



Table of Contents

- [1. The Natural History of Green Iguana Digestion](#)
- [2. Feeding Ethics](#)
- [3. Dietary Adjustment](#)
- [4. Feeding Schedule](#)
- [5. Edible and Toxic Plants](#)
- [6. Construct of a Well Balanced Diet](#)
- [7. Basic Diet and Preparation](#)
- [8. Nutritional Disorders](#)
- [9. Popular Iguana Links](#)
- [10. Acknowledgments](#)

Natural History

Green iguanas (*Iguana iguana*) are large semi-arboreal to arboreal lizards of the primarily

New World Americas. They are almost an exclusively herbivorous reptile. Earlier beliefs were that the juveniles were insectivores, and then gradually grew into herbivorous adults. However recent studies on stomach content in wild iguanas have revealed that this is not the case. Iguanas are born herbivores and do not go through an ontogenetic shift from insectivore to herbivore. The digestive system is therefore designed to digest plant materials



and not, as some recommend, to digest meat in any amount. The green iguana has evolved an elaborate hindgut, housing a microbial fermentation system that allows it to utilize fiber as effectively as mammalian ruminants. The adult iguanas spend most of their time in the upper parts of the trees, while the juveniles are either on the ground or in the lower parts of the trees and bushes. Due to the iguana's habitat, its wild diet consists of a variety of leaves, small fruits and flowers - and this variety should be provided in captivity as well. It may sound easy to provide a

varied diet for the captive iguana, however the diet must also be a nutritiously balanced and healthy diet and this is why the iguana owner needs to learn some basic guidelines for making a proper Iguana-salad.

Photo by Chris Estep

Feeding Ethics

Iguanas don't recognize what we are trying to feed them as being proper food. They are attracted by certain shapes and colors, and may, like humans, get 'hooked' on junk foods, foods that either lack nutritional value or that are downright harmful to them, or foods that they are simply used to getting. This is a particular problem with pre-owned iguanas, iguanas being fed less than ideal diets, and those who have come from pet stores where they have been fed the generally inappropriate feed usually fed to them. One needs to learn how to deal with this syndrome, how to be patient, not give in, and eventually be rewarded with your iguana eating what it should!

Dietary Adjustment

There is no simple answer as to what is the best diet for iguanas. Green iguanas are hardy and extremely adaptable and will fare on a wide variety of different diets as long as they all meet a certain basic criteria. When keeping an iguana as a pet, one of the best ways to adjust the diet is to look at the veterinary problems with the associated with the diet at different stages in an iguana's life.

- In juvenile and immature animals primarily during the first two years but also up to the ages of 4-5 years, one of the most common problems associated with diet that veterinarians encounter is metabolic bone disease, caused by a lack of usable calcium. Green iguanas grow at a truly remarkable rate from hatchlings to sexual maturity,

approximately a 100 fold increase in weight in 3 years. This implies very rapid growth of all body structures including the skeletal system which will require large amounts of usable calcium.

- A diet higher in protein content will allow an iguana to maximize it's potential growth during the first two years. There is evidence from observations of juveniles both in the wild and in captivity, that given the opportunity, they will seek a higher protein diet such as insects and possibly carrion.
- Once sexual maturity is reached (2-3 years), growth slows down somewhat but continues at a fair rate for another year or two. In females during breeding, extra demands are placed for the production of eggs and for calcification of egg shells.
- At 4-5 years of age, the growth rate tapers drastically and the diet should be adjusted accordingly. One of the more common problems in older iguanas that are brought to veterinarians is visceral gout caused by the deposition of uric acid in the kidneys and other internal organs. This is a result of a diet too high in protein, particularly organ meat products. Another common problem usually seen in male iguanas upon autopsy is metastatic calcification, the deposition of calcium in the internal organs. Both of these conditions are fatal and can be prevented through proper diet.

From The Green Iguana Manual by Philippe de Vosjoli

Recommended Diet and Feeding Schedule:

For juveniles up to 2½ years of age:

Feeding Schedule: Daily. Twice daily or continuous availability for hatchlings.

Diet: 85-90% plant matter

10-15% animal protein sources and/or commercial pet diet

Vitamin/Mineral Supplementation: One small pinch of vitamin/mineral supplement per animal,

no more than once a day.

For iguanas 2½ years and up:

Feeding Schedule: Every 1-2 days

Diet: 95% plant matter

5% animal protein sources and/or commercial pet diet

Vitamin/Mineral Supplementation: One full pinch per 2 lbs twice a week or 1/8th of a teaspoon per 3-4 lbs of body weight per week.

Note: For mature females, increase calcium supplementation and protein sources (up to 15%) starting in late December and through egg-laying.

Edible and Toxic Foliage

Before you go about preparing a salad for your iguana, one of the first things the you as an owner of an iguana needs to learn is to distinguish between "good" and "bad" food. The "good" foods are those food items that can be fed on a daily basis, ones listed in the [Basic Iguana Diet](#). If you plan to have the iguana free roaming in the house it is a necessary to find out what plants can be placed in the home. Only those that are non toxic should present. Please refer to [Melissa Kaplan's Edible Plants](#) page to determine which house plants are safe to have accessible to the iguana.

There are also those plants which should either be avoided or only be used occasionally (ones every other week). Some of these include: spinach, romaine lettuce, onions, beets, beet greens, celery stalk, Swiss-chard, carrots, bananas, grapes, lettuce, kale, Chinese cabbage, broccoli, turnips, cauliflower and brussels sprouts. However there are some plants that are to be avoided all together. These plants are not edible and may have severe toxic consequences for the animal. Rhubarb is extremely toxic because of the formation of [calcium oxalate](#) crystals. For a complete list of plants toxic to iguanas and their pathways of toxicity, please refer to [Melissa Kaplan's Harmful Plants](#) complete listing. However, if you would like to view the plants for visual identification you can see the plants at the Cornell University pages of [Poisonous Plants](#). If your reptile does ingest something it should not have, watch it carefully for signs of distress. Signs will usually include respiratory changes (i.e. rate of breathing increases or decreases, breaths become shallower or deeper, breathing becomes labored or difficult), increased salivation, dry heaves, vomiting, lethargy, increased activity, rubbing mouth on ground or other surfaces, scratching at face or mouth, diarrhea or other alteration of feces. Don't wait to see if the signs will abate - call (or have someone call) your regular reptile vet or emergency reptile vet (have these numbers and locations on hand before you need them) and let them know what the animal ate, what the signs are, and that you are on your way. The [National Animal Poison Control Center](#) may also be able to offer you pertinent information, but in a potential emergency where time is of the essence, you should get your reptile to a vet who can administer an antidote and supportive therapy as quickly as possible.

A Well Balanced Diet

Calcium Rich Vegetables, where the Ca : P > 2 - 35% or more of the diet.

- Collards, mustard greens, alfalfa chow or pellets, dandelions, bok choy, swiss chard
- Beet greens, escarole, green beans, turnips
- *Note:* Kale and bok choy in small amounts only.

Other Vegetables: A variety weekly - 35% or more of diet.

- Romaine lettuce, frozen mixed vegetables (thawed), shredded squashes, zucchini, sweet potatoes
- Bell Peppers, various sprouts, grated carrots, okra, cooked sweet potatoes
- *Note:* Broccoli, cauliflower, brussel sprouts and other members of the cabbage family should be fed in small amounts because they may cause thyroid problems when fed

frequently in large quantities.

Grain/Fiber sources: Optional - up to 20% of diet.

- **Mixed grain bread and natural bran cereal**

Fruits: Offer a variety weekly - No more than 15% of diet.

- **Calcium Rich: Fresh or dried figs, papaya, raspberries**
- **Other: Melons, apples, plums, peaches, strawberries, tomatoes, bananas, grapes, kiwi**

Animal Protein sources: Up to 15% for hatchlings and sub adults. No more than 5% of adult diet.

- **Insects: Crickets, meal worms, king meal worms**
- **Meats: Cooked chicken, small pre killed mice**
- **Commercial pet diet: Soaked high quality dog or monkey chow**
- **Other: Hard boiled eggs**

- ***Note on primate diets:* If it weren't for the high D₃ content, these diets could probably make up a substantial percentage of an iguana diet but the high D₃ content in combination with calcium will cause **metastatic calcification** in mature iguanas. Thus they should be used in moderation.**

We receive a large volume of mail about feeding iguanas meat. A large vocal group of iguana fans oppose this despite the fact that iguanas can and do eat meat in the wild and in captivity. As stated above, animal protein should be NO MORE THAN 5%. Please do not email us further about this.



Photo by Chris Estep

Basic Iguana Diet and Preparation

Greens (30-40% of volume)

Romaine Kale Leaf Lettuce Collards Spinach Escarole Mustard Greens Parsley, etc.

Handling: All greens thoroughly rinsed and chopped or diced. Hatchlings or juveniles need finely chopped food to aid digestion. Gut Fauna in young iguanas can be overwhelmed by the large pieces of food.

Bulk Vegetables (30-40% of volume)

**Frozen mixed vegetables (carrots, corn, peas, limas) Green beans Zucchini Cabbage Peas
Avocado Broccoli Yams**

Handling: All vegetables should be fresh or frozen: thawed and served room temperature or slightly warm, chopped.

Fruit (10-30% of volume)

Banana Melon (Honey dew, Cantaloupe, etc.) Kiwi Grapes Papaya Mango Strawberries
Cherries Blueberries Peaches

Handling: All fruit washed and chopped into small pieces designed to be bite-sized for various size iguanas. Bananas served with skin.

Protein (1-5% of volume)

Cooked chicken

Dog or Monkey chow

Handling: Chicken meat chopped. Process food soaked.
iguana Diet Chart by Robert Ehrig of the International Iguana Society

Nutritional Disorders in Green Iguanas

Deficiency/ Metabolic Bone Disease

Causes:

Calcium deficiency is the lack of physiologically available calcium. Simply supplementing the diet with calcium will not assure that the calcium will be absorbed through the lining of the intestine and become usable. For the effective absorption of calcium through the intestinal lining an adequate amount of vitamin D₃ and the proper calcium/phosphorus ratio is required. It is recommended that in iguanas that minerals be provided in the ratio of 1 part D₃ to 2 parts calcium to 1 part phosphorus. These can be added in the form of vitamin supplements such as Rep-Cal[®] and TerraFauna Vitalife[®] using the proper dosage.

Secondary Causes:

Calcium deficiency can also be caused by the excessive feeding of oxalic acid. When ingested, oxalic acid has a high affinity for blood calcium. This causes a reduction of calcium levels as well as the formation of a potentially lethal, insoluble substance Calcium Oxalate. Refer to Melissa Kaplan's chart on the oxalate to calcium ratio of selected iguana foods to determine a suitable diet for your pet. Acute cases of ingestion of high levels of oxalic acid is potentially lethal. The deposition of the crystals in the kidneys will cause blockage, necrosis, and ultimately death. One plant to avoid at all costs is Rhubarb. The high content of oxalic acid in the rhubarb leaves are toxic will kill even the largest of the iguanas. 

Symptoms:

The symptoms of metabolic bone disease will vary depending on a number of factors, such as the age of the animal and duration of the disease. In juveniles, symptoms can include a soft lower jaw and deformities of the back and legs. In larger animals, osteoporosis and fibrous osteodystrophy may occur. These are characterized by the

swollen, smooth appearance of the hind limbs and swollen lower jaw. Animals with fibrous osteodystrophy are often initially perceived as rotund, fat animals until they manifest abnormal behaviors, usually the result broken limbs and bones now too weak to support the weight of the animal. Fibrous dystrophy results in swollen limbs due to the deposition of scar tissue around the ever-weakening and thinning bones to make up for the structural weakness.

Gout

Causes:

Visceral gout is a disease caused by the accumulation of urate crystals and characterized by the presence of particular lesions called "tophi". In captive herbivorous reptiles, the primary cause is excessive animal protein in the diet. It is a common cause of death in older iguanas fed a primarily high meat or canned dog food diet. The feeding of meats high in purines have been closely associated with high urate levels in herbivorous reptiles. A secondary cause is the lack of water which is needed to by the iguana to flush out uric acid derivatives. Once present, visceral gout is usually fatal.

Mineralization of Internal Organs/Metastatic Calcification

Causes:

Once an iguana matures and growth rate tapers, excessive calcium in the diet will be readily absorbed into the blood stream with high levels of vitamin D₃ and can accumulate in various internal organs. Over time this will eventually kill the animal. Care must be given to not over supplement the diet of adult iguanas. It is recommended that 100-200 IU/ of D₃ per kilogram (2.2 lb) be fed per week. The moral is that too much of a good thing is not always better.

Popular Iguana Links

- [Giant Green Iguana Care](#) - Melissa Kaplan's Very Informative Page on General Iguana Care.
- [Iguana Iguana](#) - provides up-to-date information on the proper care of the green iguana with interesting articles and graphics.
- [Flower Eating Dragon, Inc.](#) - an education organization offering publications, videos, cage plans, and other reptile information, plus lectures and workshops in the New England area.

Acknowledgments

1. Boyer, T. 1991. Common problems and treatment of green iguanas (*Iguana iguana*).
Bulletin of the Association of Amphibian and Reptilian Veterinarians.
Vol. 1 No. 1. pp. 8-11.
2. Frye, F. 1991. [A Practical Guide for Feeding Captive Reptiles](#).
Kreiger Publishing.
Malabar, Fl.
3. Troyer, K. 1983. Diet selection and digestion in *Iguana iguana*, the importance of age
and nutrient requirements. *Oecologia* (Berlin) 61:201-202.
4. Vosjoli, Philippe. 1992. [The Green Iguana Manual](#). Advanced
Vivarium Systems.
Lakeside, Ca.

[\[Top of Page\]](#)[\[Natural History\]](#)[\[Feeding Ethics\]](#)[\[Dietary Adjustment\]](#)
[\[Feeding Schedule\]](#)[\[Edible and Toxic Plants\]](#)[\[Well Balanced Diet\]](#)[\[Basic Diet and Preparation\]](#) [\[Nutritional Disorders\]](#)[\[Popular Iguana Links\]](#)[\[Acknowledgments\]](#)

This page is dedicated to Jurassic, my wonderful green iguana. - Ben Brault

This series of web pages was created by Ben Brault, an undergraduate student at Cornell University for the AS625 class. All comments and suggestions are welcome.

WARNING: These web pages are only meant to be informative. Neither Cornell University nor the author of this site endorse or recommend the use of these plants.

Return to: [Poisonous Plants Homepage](#)
[Plants of Special Concern...](#) Home page: [Animal Science at Cornell University](#)

For problems or comments on this web page, contact the Animal Science [Webmaster](#)



Cornell University

Poisonous Plants Informational Database



Search for species like 'rabbit'

Click on the scientific name to view the image(s). These links require [JavaScript](#) to be enabled in your browser.

REMEMBER to close each window after viewing

Scientific Name	Common Name(s)	Species Most Often Affected	Parts Poisonous	Primary Poison(s)
Abrus precatorius	Rosary Pea	all	seeds	abrin
Amanita spp.	Monkey Agaric, Panther Cap, Death Cap, and Death Angel Mushrooms	all	cap?	toxalbumin
A. muscaria	Fly Agaric	all	cap?	ibotenic acid and muscimol
A. pantherina	Panther	all	cap?	ibotenic acid and muscimol
A. verna	Destroying Angels	all	cap?	ibotenic acid and muscimol
Cicuta spp.	Water Hemlock or Cowbane	all	roots, all	cicutoxin
Claviceps spp.	Ergot	all	fungus	indole alkaloid
Conium maculatum	Poison Hemlock	all	all	coniine
Eupatorium rugosum	White Snakeroot	cattle, dogs, goats, horses, humans, rabbits, sheep	all	tremetone
Ricinus communis	Castor Bean	all	seeds	ricin, albumin
Taxus cuspidata	Yew	all	leaves, seeds, twigs	taxine
Zigadenus spp.	Death Camas	all	all, bulbs, leaves, flowers, pollen	zygacine

[Return to Main Search Page](#)

Poisonous Plants Informational Database

Adaptations to Toxicity

We live in a world that surrounds us with poison. Plants, looking to their own best interests, produce an incredible array of toxic concoctions. Human industry has presented us with harmful compounds previously unknown in nature, like DDT and PCB's. Even essential nutrients, like salt and vitamins, can be toxic if given at the right dose. As Paracelsus the physician once said, "All substances are poisons, there is none which is not a poison." And yet, toxic as our environment is, some animals have come up with astounding adaptations that allow them to find their niche amongst these deadly plants. Come meet these incredible survivors:

- [Cyanide eating Bamboo Lemurs live to tell the tale....](#)
 - ["Polly wants some poison": The detoxifying strategies of Amazon Macaws.](#)
 - [Ruminants: Talk about your iron stomachs!!](#)
 - ["Water, water, everywhere; Nor any drop to drink" - The salt glands of marine birds.](#)
 - [REFERENCES](#)
-

This series of web pages was created by Carrie Golash, an undergraduate student at Cornell University for the AS625 class. All comments and suggestions are welcome.

WARNING: These web pages are only meant to be informative. Neither Cornell University nor the author of this site endorse or recommend the use of these plants.

Return to: [\[Adaptations to Toxicity\]](#) [\[Poisonous Plants Homepage\]](#)

Home page: [Animal Science at Cornell University](#)

For problems or comments on this web page, contact the Animal Science [Webmaster](#)

Treating Livestock with Medicinal Plants: Beneficial or Toxic?

Plant List

This series of web pages will attempt to answer some basic questions about the safety and efficacy of some medicinal plants. More plants will be added as information is available. Please read the [introduction](#) before reading about the plants.

Index

- [*Buddleja americana*](#)
- [*Carica papaya*](#)
- [*Cecropia spp.*](#)
- [*Chenopodium ambrosioides* L.](#) (Wormseed)
- [*Eucalyptus spp.*](#)
- [*Gelsemium sempervirens*](#) (Yellow Jasmine)
- [*Gliricidia sepium*](#)
- [*Hyptis verticillata*](#)
- **NEW** [*Melinis minutiflora*](#) (Molasses grass)
- *Mentha x piperita* L. (Peppermint)
- [*Ocimum basilicum* L. and *O. americanum*](#) (Basil)
- **NEW** [*Petiveria alliacea*](#)
- **NEW** [*Portulaca oleracea*](#) (Purslane)
- [*Rheum palmatum* and *Rheum rhabarbarum*](#) (Rhubarb)
- [*Symphytum officinale*](#) (Comfrey)

When reading about the plants please remember that:

1. There is incomplete toxicity information on most of these plants;
 2. There is incomplete efficacy information on most of these plants; and
 3. The toxic dose and potentially effective dose could be very close.
-

This series of web pages was created by a graduate student at Cornell University. All comments and suggestions are welcome. If you would like to add to this medicinal plant database, please [e-mail](#) Webmaster.

WARNING: These web pages are only meant to be informative. Neither Cornell University nor the author of this site endorse or recommend the use of these plants.

Return to: [Medicinal Plants Homepage](#)

[Poisonous Plants Homepage](#)

Home page: [Animal Science at Cornell University](#)

For problems or comments on this web page, contact the Animal Science [Webmaster](#)

Melinis minutiflora

Index

- [Introduction and Common Names](#)
- [Chemical Compounds and Toxicity](#)
- [Uses and Efficacy](#)

Introduction

Melinis minutiflora Beauv. (listed under the Family Gramineae or Poaceae) also is referred to as *Panicum minutiflora* and *P. melinus*. It is a seed propagated tropical grass (C4) that grows to height of approximately 3 ft. It originated in Africa, though it can now be found in much of South and Central America, the Caribbean, and parts of India. *M. minutiflora* is considered a nuisance weed in many parts of the world including Hawaii, Brazil, Venezuela, and Colombia (Duke, 1983). Hawaii is currently tracking its spread on the islands.

Most of the research with this grass has focused on its nutritional value as a pasture grass. It can be an easy to establish pasture grass. However, it also can outgrow all other grasses and weeds in a pasture and form monotypic stands. Like many tropical grasses, it does not make good hay or silage (although it is used for hay and silage in some tropical countries). *M. minutiflora* can be overgrazed and damaged from repeated mowings (e.g., for making hay).

To learn more about the genus *Melinis* please refer to [L. Watson and M.J. Dallwitz's web site](#). [James A Duke's Handbook of Energy Crops](#) (1983, unpublished) provides nutrition information, as well as, chemical, medicinal, and ecology information. [The University of Hawaii's web site](#) has several pictures available of *M. minutiflora*. Common names for *Melinis minutiflora* include:

- Herbe molasses
- Molasses grass (U.S.)
- Puakatau
- Stinkgrass (U.S.)
- Yeragua (Colombia)
- Yerba agua (Dominican Republic)
- Yerba melao (Puerto Rico)

[Return to Index](#)

Chemical Compounds and Toxicity

Little is known about the chemical composition and toxicity of *M. minutiflora*. Preliminary chemical analyses at Cornell University indicate the presence of phenolics in the roots. The

volatile oil (from the glanular hairs) contains fatty acids, esters, and probably phenolics (Duke, 1983). The leaves contain calcium oxalate crystals (Lersten, 1983).

No toxicity studies could be found. Since little is known about the chemical composition (beyond nutritionally important compounds), it is difficult to assess the toxicity of the plant when used for medicinal purposes. Some phenolics are poisonous, while others are known to have antioxidant and anticancer properties.

Oxalates (including calcium oxalates) have caused adverse effects in livestock and can decrease the availability of calcium in a plant. For example, some of the calcium in alfalfa is in the oxalate form and unavailable to ruminants. Ruminants tend to be more tolerant of oxalates than non-ruminants (e.g., horses), because rumen microbes degrade the oxalate. Therefore, if ruminants are slowly exposed to a diet high in oxalates (over an approximately 4 day period), the population of oxalate degrading microbes in the rumen increases sufficiently to prevent oxalate poisoning. Given that *M. minutiflora* is used as a pasture plant and that most treatments with it are for external parasites, one might assume that the level of oxalates will not cause adverse effects. However, oxalate levels can vary with the growing season, so one should be cautious when using any oral treatments with the grass, especially with non-ruminants (Cheeke, 1998). Studies need to be conducted to determine the types of phenolics and other bioactive compounds in *M. minutiflora*, in order to better assess its potential toxicity, identify the active compounds, and determine variation in the compounds at different growth stages.

[Return to Index](#)

Uses and Efficacy

In the Dominican Republic, the roots of *M. minutiflora* are used for internal parasite infections in animals. The roots are washed, ground, mixed with water, and given as an oral treatment. The anti-parasitic properties of *M. minutiflora* are currently being studied at Cornell University. Preliminary tests have been conducted with *Haemonchus contortus*. These tests indicate that crude ethanol extracts of the grass decrease the viability of *H. contortus* eggs. Further studies on the effect on third stage larvae are underway.

M. minutiflora is insecticidal, arachnicidal, and an insect repellent. In Tanganyika, the leaves are rubbed on livestock to repel insects. Studies conducted by Mwangi, et al. (1995) and Hernandez, et al. (1990), demonstrate that the grass repels ticks (*Rhipicephalus appendiculatus* and *Boophilus microplus*). Studies also have shown that *M. minutiflora*, when inter-cropped with maize, repelled cereal stemborer females from oviposting on the maize (Khan, et al. 1997).

[Return to Index](#)

References

Not all of the references in the list below were used in writing this web page. They are included here so that a more complete resource list is available for those interested in the subject area.

- Calle, Alvarez J., Hernandez, E.L., Riano, I., and Galindo, G. 1986. Isolation and identification of some compounds in oil from a pasture grass *Melinis minutiflora*. Revista

- Colombiana de Ciencias Quimico-Farmacéuticas, (15): 83-86. (Spanish).
- Charchar, J.M. and Huang, C.S. 1991. Survival of *Pratylenchus brachyurus* in root pieces of molasses grass *Melinis minutiflora*. Brazilian Phytopathology (Fitopatologia Brasileira), 16(1): 22-25. (Portuguese).
 - Duke. 1983, unpublished. James A Duke's Handbook of Energy Crops, http://newcrop.hort.purdue.edu/newcrop/duke_energy/Melinis_minutiflora.html
 - Hernandez, L., Parra, D., and Ahumada, A. 1990. Repellent and acaricidal activity of the oil and some chromatographic fractions of the grass *Melinis minutiflora* against *Boophilus microplus*. Revista Colombiana de Ciencias Quimico-Farmacéuticas, (17): 45-50. (Spanish).
 - Juarez, Lagunes, F.I., Fox, D.G., Blake, R.W., and Pell, A.N. 1999. Evaluation of tropical grasses for milk production by dual-purpose cows in tropical Mexico. Journal of Dairy Science, 82(10): 2136-2145.
 - Kahn, Z.R., Chiliswa, P., Among Nyarko, K. Smart, L.E., Polaszek, A., Wandera, J., and Mula, M.A. 1997. Utilisation of wild gramineous plants for management of cereal stem borers in Africa. Insect Science and its Application, 17(1): 143-150.
 - Lersten, N.R. 1983. Crystals of calcium compounds in Gramineae. New Phytol, 93(4): 633-638.
 - Mwangi, Esther, N., Essuman, S., Kaaya, G.P., Nyandat, E., Munyinyi, D., and Kimondo, M.G. 1995. Repellence of the tick *Rhipicephalus appendiculatus* by the grass *Melinis minutiflora*. Tropical Animal Health and Production, 27(4): 211-216.
 - University of Hawaii. http://www.botany.hawaii.edu/faculty/cw_smith/mel_min.htm
 - Watson, L. and Dallwitz, M.J. Undated web site. <http://www.keil.ukans.edu/delta/grass/www/melinis.htm>
-

This series of web pages was created by a graduate student at Cornell University. All comments and suggestions are welcome. If you would like to add to this medicinal plant database, please [e-mail](#) Webmaster.

WARNING: These web pages are only meant to be informative. Neither Cornell University nor the author of this site endorse or recommend the use of these plants.

Return to: [Medicinal Plants Homepage](#)

[Poisonous Plants Homepage](#)

Home page: [Animal Science at Cornell University](#)

For problems or comments on this web page, contact the Animal Science [Webmaster](#)

Petiveria alliacea

Index

- [Introduction and Common Names](#)
- [Chemical Compounds and Nutritional Value](#)
- [Toxicity](#)
- [Uses and Efficacy](#)

Introduction

Petiveria alliacea (Family Phytolaccaceae), commonly known as anamu, is a herbaceous perennial. *P. alliacea* can be found growing in tropical areas of Central and South American, the Caribbean, and Africa. The leaves and roots of the plant have a strong odor. An excellent source of information on this plant is presented on the [Raintree Nutrition](#) web site. The Raintree site includes ethnobotanical data, references, and abstracts. Some of the common names for *Petiveria alliacea* include:

- Anamu (Dominican Republic)
- Apacin (Guatemala)
- Feuilles Ave
- Herbe Aux Poules
- Mucura (Peru)
- Petivere A Odeur Ail

A more complete list of common names can be found on the Raintree site.

Chemical Compounds and Nutritional Value

P. alliacea contains several biologically active compounds. The quantity of compounds varies in the plant parts. Primary compounds in the essential oil of the roots include: benzaldehyde, dibenzyl disulfide, dibenzyl trisulfide, and cis- and trans-stilbene. Some of the compounds in *P. alliacea* are listed below.

- benzaldehyde -- root
- benzoic acid -- root
- benzyl-2-hydroxyethyl-trisulfide -- leaf
- coumarin -- root
- isoarborinol
- isoarborinol acetate
- isoarborinol cinnamate

- isothiocyanates -- seed
- polyphenols -- leaf
- senfol -- leaf
- tannins -- leaf
- trithiolaniacine -- root

[Return to Index](#)

Toxicity

Few data on the toxicity of *P. alliacea* could be found in the literature. In one study with mice, oral doses did not cause toxicity. However, methanol extracts of the plant do cause uterus contractions, which can lead to abortion - one of its uses in traditional human medicine. Also, extracts have been shown to inhibit mitosis.

Caution should be taken if *P. alliacea* is fed to animals on a regular basis. The plant can accumulate nitrates and has caused nitrate poisoning in cattle. Also, in studies where cattle were fed *P. alliacea* regularly (3g/kg bodyweight/day), the cattle suffered several adverse reactions.

Uses and Efficacy

In the Dominican Republic, the roots of *Petiveria alliacea* are used in treatments for internal parasites in livestock and as an insect repellent. No studies on the anti-parasitic properties of *P. alliacea* in livestock could be found in the literature. However, when *P. alliacea* root was applied to soil, populations of *Meloidogyne incognita* were decreased compared to controls. Also, hexane extracts of the plant showed some activity against the blood protozoa *Trypanosoma cruzi in vitro*. Studies have shown that crude ethanol extracts exhibit some repellent activity against *Boophilus microplus* (tick species). Dibenzyltrisulfide, one of the compounds in the roots of *P. alliacea*, is insecticidal (*Cylas formicarius elegantulus* and *Hypothenemus hampei*) and acaricidal (*Boophilus microplus*).

In other studies, extracts of *P. alliaceae*: provided some protection against *Listeria monocytogenes* infections in mice, inhibited inflammation in induced paw oedema in mice, and reduced blood platelet aggregation *in vitro*.

P. alliacea has been used to treat the following ailments in humans:

- Abortifacient -- La, Trinidad, and Venezuela
- Ache (head, tooth) - Dominican Republic, Haiti, and Mexico
- Antiseptic -- Haiti
- Aphrodisiac
- Bite (snake)
- Cold -- Haiti, Mexico
- Counterirritant -- Trinidad
- Cystitis -- Trinidad

- Decoagulant -- Trinidad
- Depurative -- Haiti, La, Mexico, Trinidad, and Venezuela
- Diuretic - Brazil, Haiti, La, and Mexico
- Emmenagogue -- Dominican Republic, Guatemala, La, and Mexico
- Expectorant -- Haiti, La, and Mexico
- Fever -- Haiti, Mexico
- Flu - Dominican Republic and Trinidad
- Head cold -- Trinidad
- Hysteria - La and Mexico
- Inflammation - Dominican Republic
- Insecticide -- Dominican Republic
- Nerve -- La and Mexico>
- Paralysis -- Mexico
- Parturition
- Pertussis
- Piscicide
- Poison (Arrow) -- Brazil
- Rabies -- Mexico
- Repellant (Bat) - Panama (Choco)
- Repellant (Insect) - Dominican Republic, Haiti, and Mexico
- Rheumatism -- Mexico
- Rootcanal -- Venezuela
- Sedative - Brazil and Haiti

[Return to Index](#)

References

Not all of the references in the list below were used in writing this web page. They are included here so that a more complete resource list is available for those interested in the subject area.

- Asmus, R.M.F. and Ferraz, S. 1988. Antagonistic effects of some plant species, mainly legumes, on *Meloidogyne javanica*. Fitopatologia Brasileira. 13 (1): 20-24. (Portuguese)
- Ayala, J.R., Cruz, A.M., Miranda, Z. 1994. Effects of the aqueous extract of *Canavalia ensiformis*, *Bursera graveolens*, *Petiveria alliacea*, and *Parthenium hysterophorus* on sorghum germination. Technical note. Cuban *Trypanosoma cruzi*. J of Ethnopharmacology. 62 (2): 107-115.
- Caceres, A., B. Lopez, S. Gonzalez, I. Berger, I. Tada, and J. Maki. 1998. Plants used in Guatemala for the treatment of protozoal infections. I. screening of activity to bacteria, fungi and American trypanosomes of 13 native plants. J of Ethnopharmacology. 62(3): 195-202.
- Carrillo, C.M., Chinchilla, E.A., Gonzalez, L.A., Toledo, R.A., and Zambrana, H.G. 1997.

- The prevention of fowl cholera, with aqueous extracts of plants, in poultry production. *Agronomia Mesoamericana*. 8(2): 152-158. (Spanish)
- Elisabetsky, E. and Castilhos, Z.C. 1990. Plants used as analgesics by Amazonian caboclos as a basis for selecting plants for investigation. *International Journal of Crude Drug Research*. 28 (4): 309-320.
 - Germano, D.H.P., Sertie, J.A.A., Bacchi, E.M. 1995. Pharmacological assay of *Petiveria alliacea*. II: Oral anti-inflammatory activity and gastrotoxicity of a hydroalcoholic root extract. *Fitoterapia*. 66(3): 195-202.
 - Germano, D.H.P., Caldeira, T.T.O., Mazella, A.A.G., Sertie, J.A.A., and Bacchi, E.M. 1993. Topical anti-inflammatory activity and toxicity of *Petiveria alliacea*. *Fitoterapia*. 64 (5): 459-462.
 - Giron, L.M., Freire, V., Alonzo, A., and Caceres, A. 1991. Ethnobotanical survey of the medicinal flora used by the Caribs of Guatemala. *J of Ethnopharmacology*. 34(2-3): 173-187.
 - Guerra, M. de O., Maia, J.G.S., Peters, V.M., and Cabral, J.A. daS. 1988. Screening of Amazon native plants with a potential for inhibiting fertilization in rats. *Acta Amazonica (Supplement)*. 18 (1-2): 129-134. (Portuguese)
 - Johnson, L., Williams, L.A.D. and Roberts, E.V. 1997. An insecticidal and acaricidal polysulfide metabolite from the roots of *Petiveria alliacea*. *Pesticide Science*. 50(3): 228-232.
 - Malpezzi, E.L.A., Davino, S.C., Costa, L.V., Freitas, J.C., Giesbrecht, A.M. and Roque, N.F. 1994. Antimitotic action of extracts of *Petiveria alliacea* on sea urchin egg development. *Brazilian Journal of Medical and Biological Research*. 27(3): 749-754.
 - Mansingh, A. and L.A.D. Williams. 1998. Pesticidal potential of tropical plants - II. Acaricidal activity of crude extracts of several Jamaican plants. *Insect Science and its Application*. 18(2): 149-155.
 - Monache, F. delle and Suarez, L.E.C. 1992. 6-C-Formyl and 6-C-hydroxymethyl flavanones from *Petiveria alliacea* [leaves]. *Phytochemistry*. 31(7): 2481-2482.
 - Odeyemi, O. 1993. Insecticidal properties of certain indigenous plant oils against *Sitophilus zeamais* Mots. *Applied Entomology and Phytopathology*. 60 (1&2): 19-27.
 - Olaifa, J.I. and Akingbohunge, A.E. 1987. Antifeedant and insecticidal effects of extracts of *Azadirachta indica*, *Petiveria alliacea* and *Piper guineense* on the variegated grasshopper, *Zonocerus variegatus*. :405-418.
 - Olaifa, J.I., Erhun, W.O., and Akingbohunge, A.E. 1987. Insecticidal activity of some Nigerian plants. *Insect Science and its Application*. 8(2): 221-224.
 - Oluwole, F.S. and Bolarinwa, A.F. 1998. The uterine contractile effect of *Petiveria alliacea* seeds. *Fitoterapia*. 69(1): 3-6.
 - Ponte, J.J. da, A. Franco, and J. Silveira Filho. 1996. Preliminary investigation on the nematicide potential of Guine's plants (*Petiveria alliacea*). *Fitopatologia Venezuelana*. 9(1): 14-15. (Spanish)
 - Ponte, J.J. da, Franco, A., and Menezes, R.N. 1980. Preliminary report on the potentiality of "tipi" (*Petiveria alliacea*) as nematicide. *Fitopatologia Brasileira*. 5(3): 440-441.

(Portuguese)

- Quadros, M.R., A.R.M. Souza Brito, and M.L.S. Queiroz. 1999. *Petiveria alliacea* L. extract protects mice against *Listeria monocytogenes* infection - effects on bone marrow progenitor cells. *Immunopharmacology and Immunotoxicology*. 21 (1): 109-124.
- Ruiz, A. 1972. Clinical, morphological, histochemical and clinical pathological studies of anamu (*Petiveria alliacea*) poisoning in cattle. *Dissertation Abstracts International*. 33B(1): 490.
- Sabori, I., Cabrera, M., Lopez, C., and Muina, M. 1992. Identification of the shade plants, green cover plants and weeds susceptible to root-knot nematodes. *Revista Baracoa*. 22(1): 21-28. (Spanish)
- Sousa-J-R-de. Demuner-A-J. Pinheiro-J-A. Breitmaier-E. Cassels-B-K. 1990. Dibenzyl trisulphide and trans-n-methyl-4-methoxyproline from *Petiveria alliacea*. *Phytochemistry*. 29(11): 3653-3655.
- Souza, Brito A.R.M. and Souza, Brito A.A. 1993. Forty years of Brazilian medicinal plant research. *Journal of Ethnopharmacology*. 39 (1): 53-67.
- Trheebilcock, P.E., Villafane, A.F., Gil, P.A. 1978. Nitrate poisoning in cattle. *Revista Instituto Colombiano Agropecuario*. 13 (1): 119-125. (Spanish)
- Villar, R., Calleja, J.M., Morales, C., and Caceres, A. 1997. Screening of 17 Guatemalan medicinal plants for platelet antiaggregant activity. *Phytotherapy Research*. 11(6): 441-445.
- Williams, L.A.D., T.L. The, M.T. Gardner, C.K. Fletcher, A. Naravane, N. Gibbs, and R. Fleishhacker. 1997. Immunomodulatory activities of *Petiveria alliacea* L. *Phytotherapy Research*. 11(3): 251-253.

This series of web pages was created by a graduate student at Cornell University. All comments and suggestions are welcome. If you would like to add to this medicinal plant database, please [e-mail](#) Webmaster.

WARNING: These web pages are only meant to be informative. Neither Cornell University nor the author of this site endorse or recommend the use of these plants.

Return to: [Medicinal Plants Homepage](#)

[Poisonous Plants Homepage](#)

Home page: [Animal Science at Cornell University](#)

For problems or comments on this web page, contact the Animal Science [Webmaster](#)

Portulaca oleracea

Index

- [Introduction and Common Names](#)
- [Chemical Compounds and Nutritional Value](#)
- [Toxicity](#)
- [Uses and Efficacy](#)

Introduction

Portulaca oleracea (Family Portulacaceae), commonly known as purslane in the U.S., is an herbaceous weed. The origin of purslane is uncertain. It can be found growing wild and/or cultivated in much of the world. It existed in the New World before the arrival of Columbus, and was found in Europe by the late 16th century. It can be found growing in almost any unshaded area, including flower beds, corn fields, and waste places. Purslane can be found growing in cold climate areas (e.g., Canada) as well as warm areas (e.g., the Caribbean). It has been used in salads and as a medicinal plant (for people) for hundreds of years. To see pictures of purslane, please go to [the University of Hawaii's web site](#) or [Virginia Tech's web site](#). Common names for *Portulaca oleracea* include:

- Akulikuli-kula
- Ancharupa
- Beldroega
- Berbin
- Coupe-Pied
- Coupier
- Farfena (Central Oman)
- Gelang pasir
- Golasiman (Philippines)
- Krokot
- Ma Ch'Ih Hsien
- Ngalug (Philippines)
- Parpinah
- Perpine
- Pig weed
- Porcelana

- Pourpier Commun, Pourpier
- Purslane (U.S.)
- Pusley (U.S.)
- Rigla (Egypt)
- Semizotu
- Stilchi (Garo in India)
- Suberi-Hiyu
- Verdolaga (Dominican Republic)
- Vertolaga (Peruvian Amazon)

[Return to Index](#)

Chemical Compounds and Nutritional Value

P. oleracea contains many biologically active compounds and is a source of many nutrients. Some of the biologically active (and, in some case, potentially toxic compounds) include free oxalic acids, alkaloids, omega-3 fatty acids, coumarins, flavonoids, cardiac glycosides, and anthraquinone glycosides. It has high contents of Omega-3 fatty acids and protein (compared to other vegetables) (Ezekwe, et al. 1999). The quantity of these compounds in *P. oleracea* varies with the growing conditions (e.g., planting date, soil quality, fertilization) and the age of the plant. Some of the compounds in *Portulaca oleracea* are listed below. For a more complete list, go to [Dr.](#)

[Duke's Phytochemical Database](#).

- alanine -- plant and herb (570-13,400 ppm)
- alkaloids -- leaf (300 ppm)
- caffeic acid -- plant
- calcium oxalate -- herb
- catechol -- plant
- beta-cyanin -- herb
- digalactosyldiacylglycerol -- herb
- docosahexaenoic acid -- herb
- dopa -- plant
- eicosapentaenoic acid -- herb (10 ppm)
- HCN -- plant
- histidine -- herb (220-5,170 ppm)
- l-noradrenalin -- plant (2,500 ppm)
- linoleic acid -- herb (704-18,245 ppm) and seed (67,686 ppm)
- linolenic acid - herb (3,221-64,315 ppm) and seed (17,226 ppm)
- alpha-linolenic acid -- herb (4,000-80,000 ppm)
- lysine -- herb (650-13,200 ppm)
- methionine -- herb (90-2,814 ppm)

- norepinephrine -- plant
- oleic acid -- herb (16-2,160 ppm) and seed (49,935 ppm)
- omega-3's -- plant (30,000 ppm)
- oxalates -- shoot
- oxalic acid -- plant (1,679-16,790 ppm)
- phytin-p -- plant (4-40 ppm)
- saponin -- plant
- sinapic acid -- plant
- beta-sitosterol -- seed
- tannin -- plant
- threonine -- herb (470-9,400 ppm)
- tryptophan -- herb (160-3,400 ppm)
- valine -- herb (660-13,200 ppm)

[Return to Index](#)

Toxicity

No data on the toxicity of *P. oleracea* could be found in the literature. However, the plant does contain cardiac glycosides and oxalic acids, which can be toxic.

Uses and Efficacy

In the Dominican Republic, all parts of *Portulaca oleracea* are used in treatments for internal parasites. The plant always is mixed with other plants (e.g., *Chenopodium ambrosioides*). No in vitro or in vivo efficacy tests with the plant or extracts of the plant against common internal parasites could be found in the literature. In de Bairacli-Levy (1991), *P. oleracea* is listed as a treatment for parasites, a blood-cleanser, and to refresh the digestive system. The plant is to be fed fresh (after it has seeded) ad lib. While efficacy tests have not been conducted for these specific livestock uses, *Portulaca oleracea* has been extensively studied for other forms of bioactivity. In vitro and in vivo tests have been conducted with *P. oleracea* to determine, for example, its anti-inflammatory, analgesic, and anti-fungal activity. *P. oleracea* has been used to treat the following ailments in humans:

- Alexiteric -- China
- Alterative -- Turkey
- Anthrax -- China
- Antidote
- Antiphlogistic -- China
- Aperient -- Java
- Ardor -- Turkey
- Astringent - India and Sudan

- Bactericide -- China
- Bite (Bug, snake) - China and the Philippines
- Bladder -- India
- Bleorrhagia -- China
- Boil -- China
- Burn
- Cardiotonic -- Haiti
- Cold -- China
- Colic -- China
- Demulcent -- Sudan
- Dermatitis -- China
- Detergent -- India
- Diuretic -- China, Haiti, India, Sudan and Turkey
- Diarrhea and dysentery - China and the Philippines
- Dyspepsia -- China and Haiti
- Dysuria
- Ear ache
- Eczema -- China
- Edema -- China
- Emollient -- China, Dominican Republic and Turkey
- Empacho -- Trinidad
- Enteritis -- China
- Erysipelas -- China
- Fever -- China
- Fungicide
- Genital -- China
- Gonorrhoea
- Heat - India and the Philippines
- Hematuria
- Hemostat -- Haiti
- Hemoptysis
- Hemorrhage
- Herpes -- China
- Hyperglycemia
- Hypotension -- Trinidad
- Inflammation
- Insomnia -- Haiti

- Intestine -- China
- Kidney - Haiti and India
- Leucorrhoea -- China
- Liver
- Lung -- India
- Mouth
- Nausea -- China
- Opacity -- China
- Ophthalmia -- Malaya
- Palpitation -- Trinidad
- Pile -- China
- Poison -- Australia
- Poultice -- China
- Pruritis -- China
- Scald
- Scurvy -- China, Haiti, India and Turkey
- Sedative -- Turkey
- Soporific -- Haiti
- Sore -- China
- Spleen
- Swelling -- China
- Thirst -- China
- Tonic -- China
- Toothache
- Tumor -- Brazil, China, Colombia and Gabon
- Urogenital -- China, Kurdistan and Spain
- Vermifuge -- China, Dominican Republic, Iraq, Java, Trinidad and Venezuela
- Viricide
- Vulnerary -- India
- Wart -- Japan, Mexico and Peru
- Wound - China

[Return to Index](#)

References

Not all of the references in the list below were used in writing this web page. They are included here so that a more complete resource list is available for those interested in the subject area.

- Abivardi, C. 1971. Studies on the effects of 9 Iranian anti-helminthic plant extracts on the root-knot nematode *Meloidogyne incognita*. *Phytopathol Z.* 71 (4): 300-308.
- Banerjee, Gautam and Muckherjee, Ambarish. 1996. *Portulaca oleracea* L.: A gem of aliens in India. *Journal of Phytological Research.* 9 (2): 111-115.
- Barbakadze, V.V., Gakhokidze, R.A., Shengeliya, Z.S., and Usov, A.I. 1989. Preliminary study of water-soluble polysaccharides in some plants in the Georgian SSR USSR. *Khimiya Prirodnykh Soedinenii* (Tashkent). (3): 330-335. (Russian)
- Bairacli-Levy, Juliette de. 1991. *The Complete Herbal Handbook for Farm and Stable.* Faber, Boston.
- Belair, G. and Benoit, D.L. 1996. Host suitability of 32 common weeds to *Meloidogyne hapla* in organic soils of southwestern Quebec. *Journal of Nematology.* 28 (4 Suppl.): 643-647.
- Chun, K.J., Kim, Jin Kyu, Lee, Young Keun and Kim, Bong Hee. 1999. Effect of *Portulaca Oleracea* water extract on the changes of urine amino acid contents and survival rate by irradiation in mice. *Yakhak Hoeji.* 43 (2): 274-277. (Korean)
- Dr. Duke's Ethnobotanical and Phytochemical Databases at <http://probe.nalusda.gov:8300/cgi-bin/browse/ethnobotdb>.
- Elmi, A.A., Mebrahtu, T., Omara, Alwala T.R., and Ezekwe, M. 1997. Environmental effects on yield and agronomic traits of Purslane (*Portulaca* spp.). *Virginia Journal of Science.* 48 (3): 203-209.
- Eskander, E.F. and Jun, H. Won. 1995. Hypoglycaemic and hyperinsulinemic effects of some Egyptian herbs used for the treatment of diabetes mellitus (type II) in rats. *Egyptian Journal of Pharmaceutical Sciences.* 36 (1-6): 331- 342.
- Ezekwe, Michael O., Omara, Alwala Thomas R., and Membrahtu Tadesse. 1999. Nutritive characterization of purslane accessions as influenced by planting date. *Plant Foods for Human Nutrition* (Dordrecht), 54(3): 183-191.
- Garti, N., Slavin, Y., and Aserin, A. 1999. Surface and emulsification properties of a new gum extracted from *Portulaca oleracea* L. *Food Hydrocolloids.* 13 (2): 145-155.
- Garti, N., Aserin, A., and Slavin, Y. 1999. Competitive adsorption in O/W emulsions stabilized by the new *Portulaca oleracea* hydrocolloid and nonionic emulsifiers. *Food Hydrocolloids.* 13 (2): 139-144.
- Garti, N., Slavin, Y., and Aserin, A. 1999. *Portulaca oleracea* gum and casein interactions and emulsion stability. *Food Hydrocolloids.* 13 (2): 127-138.
- Ghazanfar, Shahina A. and Al-Sabahi, Ahmed Mohammed. 1993. Medicinal plants of northern central Oman (Arabia). *Economic Botany.* 47 (1): 89-98.
- Grieve, C.M. and Suarez, D.L. 1997. Purslane (*Portulaca oleracea* L.): A halophytic crop for drainage water reuse systems. *Plant and Soil.* 192 (2): 277-283.
- Guil, Guerrero Jose L. and Rodriguez, Garcia Ignacio. 1999. Lipids classes, fatty acids and carotenes of the leaves of six edible wild plants. *European Food Research and Technology,* 209(5): 313-316.
- Islam, M.W., Zakaria, M.N.M., Radhakrishnan, R., Habibullah, M., and Chan, K. 1998. Evaluation of analgesic activity of the aerial parts of *Portulaca oleracea* v. *sativa* and its comparison with two related spices. *Journal of Pharmacy and Pharmacology.* 50 (Suppl.): 226.

- Kamil, M., Jayaraj, A.F., Ahmad, F., Gunasekhar, C., Thomas, S., Habibullah, M., and Chan, K. 1998. Chemical standardization of *Portulaca oleracea* v. *sativa*. *Journal of Pharmacy and Pharmacology*. 50 (Suppl.): 259.
- Lichtenthaler, Hartmut K. and Schweiger, Joachim. 1998. Cell wall bound ferulic acid, the major substance of the blue-green fluorescence emission of plants. *Journal of Plant Physiology*. 152 (2-3): 272-282.
- Maheshwari, J.K. and Singh, J.P. 1984. Contribution to the ethnobotany of Bhoja tribe of Bijnor and Pauri Garhwal districts Uttar Pradesh India. *J Econ taxon Bot*. 5 (2): 253-260.
- Mitich, Larry W. 1997. Common purslane (*Portulaca oleracea*). *Weed Technology*. 11 (2): 394-397.
- Mizutani, Masanori, Hashidoko, Yasuyuki, and Tahara, Satoshi. 1998. Factors responsible for inhibiting the motility of zoospores of the phytopathogenic fungus *Aphanomyces cochlioides* isolated from the non-host plant *Portulaca oleracea*. *FEBS Letters*. 438 (3): 236-240.
- Norman, Helen A. and Simopoulos, Artemis P. XXXX. Profiles of omega-3 fatty acids and antioxidants in common purslane throughout plant development. *World Review of Nutrition and Dietetics; Nutrition and fitness for athletes*. Simopoulos, A.P. Pavlou, K.N. (Eds) 71. (P.O. Box: S. Karger AG) 186-187.
- Palaniswamy, Usha Rani, McAvoy, Richard, and Bible, Bernard. 1997. Omega-3-fatty acid concentration in *Portulaca oleracea* L. is altered by the source of nitrogen in hydroponic solution. *Hortscience*. 32 (3): 462-463.
- Pope, D.F., Thompson, A.C., and Cole, A.W. 1984. Phytotoxicity of root exudates and leaf extracts of nine plant species. Thompson, A.C. (Ed.). ACS (American Chemical Society) Symposium Series, 268. The chemistry of allelopathy: biochemical interactions among plants, 187th meeting, St. Louis, Mo.
- Portillo, Hector E., Pitre, Henry N., Meckenstock, Dan H. and Andrews, Keith L. 1996. Oviposition preference of *Spodoptera latifascia* (Lepidoptera: Noctuidae) for sorghum, maize and non-crop vegetation. *Florida Entomologist*. 79 (4): 552-562.
- Radhakrishnan, R. Zakaria, M.N.M. Islam, M.W. Ismail, A. Habibullah, M. Chan, K. 1998. Neuropharmacological actions of *Portulaca oleracea* v. *sativa*. *Journal of Pharmacy and Pharmacology*. 50 (Suppl.): 225.
- Sakai, Naomi, Inada, Kyouko, Okamoto, Michi, Shizuri, Yoshikazu, and Fukuyama, Yoshiyasu. 1996. Portuloside A, a monoterpene glucoside, from *Portulaca oleracea*. *Phytochemistry (Oxford)*. 42 (6): 1625-1628.
- Thangavel, Palaniswamy and Subburam, Venkatasamy. 1998. Effect of trace metals on the restoration potential of leaves of the medicinal plant, *Portulaca oleracea* Linn. *Biological Trace Element Research*. 61 (3): 313-321.
- Yoon, J.W., Ham, S.S., and Jun, H.S. 1999. *Portulaca oleracea* and tumor cell growth. *Official Gazette of the United States Patent and Trademark Office Patents*. 1219 (2): 1472
- Zakaria, M.N.M., Islam, M.W., Radhakrishnan, R., Habibullah, M., and Chan, K. 1998. Evaluation of anti-inflammatory activity of *Portulaca* species. *Journal of Pharmacy and Pharmacology*. 50 (Suppl.): 227.
- Zeng Xiaoling. 1999. A study of scavenging action of purslane aqueous extracts on oxygen

free radical. Hunan Yike Daxue Xuebao. 24 (2): 133-135. (Chinese)

This series of web pages was created by a graduate student at Cornell University. All comments and suggestions are welcome. If you would like to add to this medicinal plant database, please [e-mail](#) Webmaster.

WARNING: These web pages are only meant to be informative. Neither Cornell University nor the author of this site endorse or recommend the use of these plants.

Return to: [Medicinal Plants Homepage](#)

[Poisonous Plants Homepage](#)

Home page: [Animal Science at Cornell University](#)

For problems or comments on this web page, contact the Animal Science [Webmaster](#)

Treating Livestock with Medicinal Plants: Beneficial or Toxic?

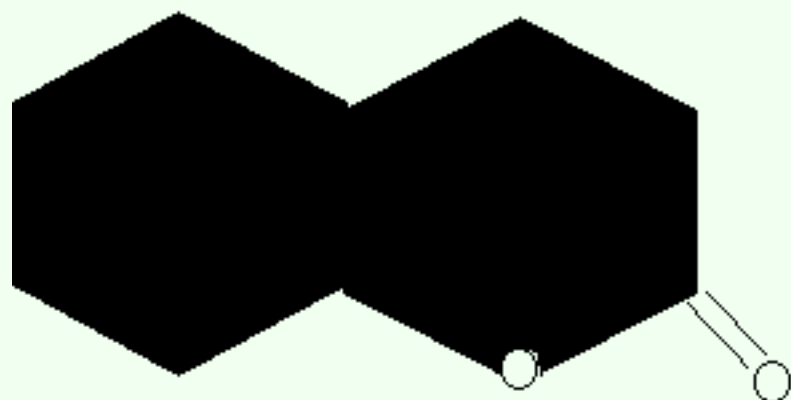

Coumarin

$C_9H_6O_2$ MW 146.15

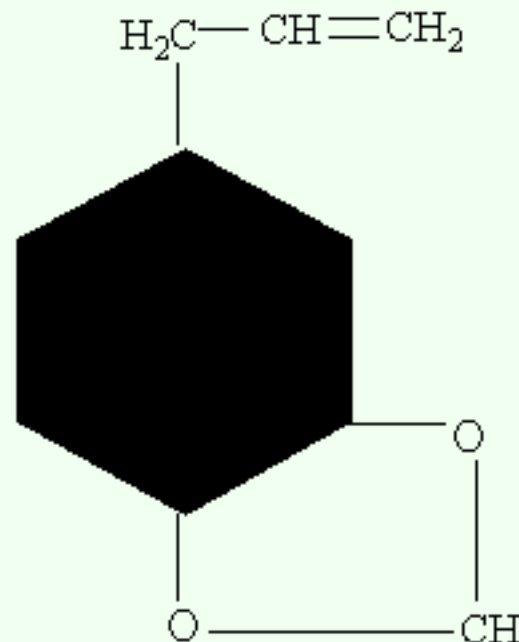

Safrole

$C_{10}H_{10}O_2$ MW 162.19

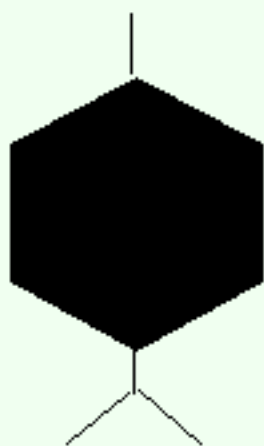

p-Cymene

$C_{10}H_{14}$ MW 134.22

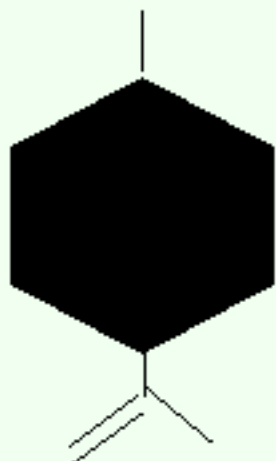

Limonene

$C_{10}H_{16}$ MW 136.24

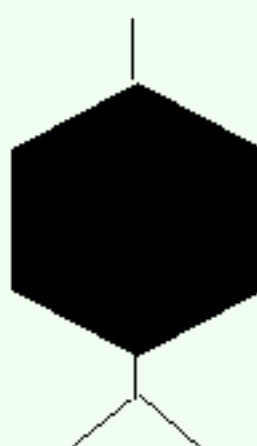

α -Terpinene

$C_{10}H_{16}$ MW 136.24

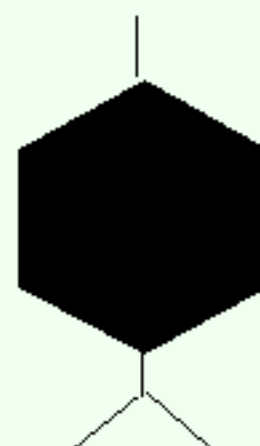

Ascaridole

$C_{10}H_{16}O_2$ MW 168.24

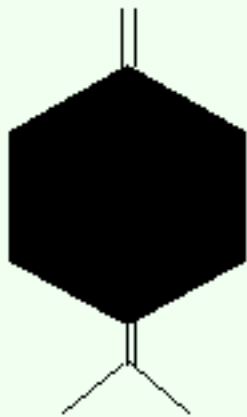

Myrcene
 $C_{10}H_{16}$ MW 136.24

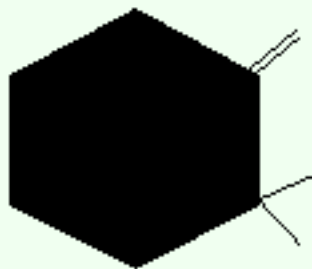

Camphene
 $C_{10}H_{16}$ MW 136.24

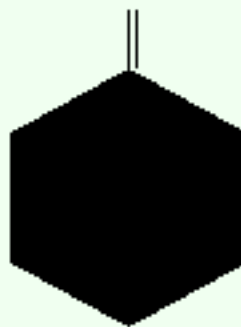

β -Pinene
 $C_{10}H_{16}$ MW 136.24

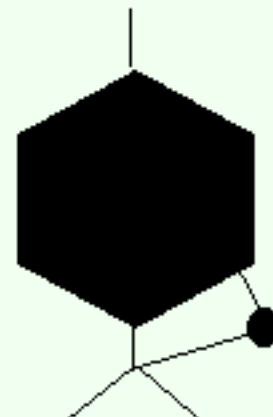

1,8-Cineole
 $C_{10}H_{18}O$ MW 154.25

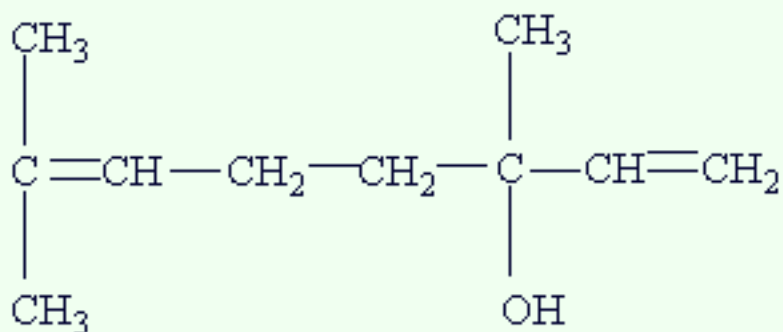

Linalool

$C_{10}H_{18}O$ MW 154.25

Return to: [Medicinal Plants Homepage](#)

[Poisonous Plants Homepage](#)

Home page: [Animal Science at Cornell University](#)

For problems or comments on this web page, contact the Animal Science [Webmaster](#)

Treating Livestock with Medicinal Plants: Beneficial or Toxic?

Other Resources on Medicinal Plants and Ethnoveterinary Medicine

Ethnoveterinary medicine is a growing area of research. More and more scientists, veterinary practitioners, field workers in developing countries, and livestock owners are becoming interested in medicinal plants. A simplistic definition for ethnoveterinary medicine is: local or indigenous knowledge and methods for caring for, healing, and managing livestock. This includes social practices and ways in which livestock are incorporated into farming systems.

There are lots of resources on medicinal plants. Here are just a few that I find interesting.

Resources on the Web

- [USDA - Dr. Duke's Phytochemical and Ethnobotanical Databases](#)
- [The Alternative Medicine Homepage](#)
- [Medicinal Herb Information](#)
- [Plant Data Bases](#)
- [Alternative Veterinary Medicine Resources](#)
- [Quack Medicine Watch](#)
- [AltVetMed](#)

Resources not on the Web

- [Proceedings of an International Conference on Traditional Medicinal Plants](#). 1991. Chief ed. K.E. Mshigeni. The United Republic of Tanzania, Ministry of Health. Dar Es Salaam University Press.
- [Ethnoveterinary Research and Development](#). 1996. Eds. C.M. McCorkle, E. Mathias, and T.W. Schillhorn van Veen. Intermediate Technology Pubs., London.
- [Chemistry, Biological and Pharmacological Properties of African Medicinal Plants](#). 1996. Proceedings of the first International IOCD-Symposium, Victoria Falls, Zimbabwe, Feb. 25-28, 1996. Eds. K. Hostettmann, F. Chinyanganya, M. Maillard, and J.L. Wolfender. University of Zimbabwe Pubs.
- [Ethnoveterinary Medicine in Asia: An Information Kit on Traditional Animal Health Care Practices](#), 4 vols. 1994. International Institute of Rural Reconstruction, Silang, Cavite, Philippines.

- Natural Veterinary Medicine: Ectoparasites in the Tropics. 1990. Uly Matzigkeit. AGRECOL. Margraf, Weikersheim, Germany.
 - Adverse Effects of Herbal Drugs Part 1 and 2. 1992. Eds. P.A.G.M. De Smet, K. Keller, R. Hansel, and R.F. Chandler. Springer-Verlag, NY.
 - Complementary and Alternative Veterinary Medicine: Principles and Practice. 1998. Eds. Allen M. Schoen and Susan G. Wynn. Mosby, St. Louis, MO.
-

This series of web pages was created by a graduate student at Cornell University. All comments and suggestions are welcome. If you would like to add to this medicinal plant database, please [e-mail](#) Webmaster.

WARNING: These web pages are only meant to be informative. Neither Cornell University nor the author of this site endorse or recommend the use of these plants.

Return to: [Medicinal Plants Homepage](#)
[Poisonous Plants Homepage](#)
Home page: [Animal Science at Cornell University](#)

For problems or comments on this web page, contact the Animal Science [Webmaster](#)

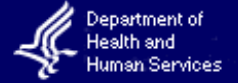

Search

Powered by Google

[A-Z Index](#)

[Site Map](#)

Products FDA Regulates

[Food](#)

Foodborne Illness, Nutrition, Dietary Supplements...

[Drugs](#)

Prescription, Over-the-Counter, Generic...

[Medical Devices](#)

Pacemakers, Contact Lenses, Hearing Aids...

[Biologics](#)

Vaccines, Blood Products...

[Animal Feed and Drugs](#)

Livestock, Pets...

[Cosmetics](#)

Safety, Labeling...

[Radiation-Emitting Products](#)

Cell Phones, Lasers, Microwaves...

[Combination Products](#)



FDA NEWS

[FDA to Determine Health Significance of Low Furan Levels in Foods](#)

[More Data Needed Before Plan B Contraceptive Can Go OTC](#)

[British Man Charged In Extortion Plot Involving Tainted Food](#)

[FDA to Modernize Food Manufacturing Rules](#)

[FDA Science Forum to be Held May 18-19](#)

[Recalls, Market Withdrawals, and Safety Alerts](#)

[Product Approvals](#)

[More FDA News - Press Releases, Meetings, Congressional Testimony, More](#)

Let Us Hear From You

[Report a Problem with a Product](#)

[Comment on Proposed Regulations](#)

[Petition FDA](#)

[Job Opportunities](#)

[Contact FDA](#)

Reference Room

[Laws FDA Enforces](#)

[Code of Federal Regulations](#)

[Federal Register](#)

[Guidance Documents](#)

[Dockets](#)

[Warning Letters](#)

[Manuals and Publications](#)

Food Industry

- [Register a Facility](#)
- [Prior Notice of Imports](#)

Hot Topics

- [Mercury in Fish](#)
- [BSE \('Mad Cow Disease'\)](#)
- [Ephedra](#)
- [Imported Drugs](#)
- [Counterterrorism](#)
- [Bioterrorism Act](#)
- [Counterfeit Drugs](#)
- [Buying Medicines Online](#)
- [More Hot Topics...](#)

FDA Activities

- [About FDA](#)
- [Advisory Committees](#)
- [Clinical Trials](#)
- [Commissioner's Page](#)
- [Field Operations](#)
- [Freedom of Information](#)
- [Imports](#)
- [International](#)
- [Major Initiatives](#)
- [MedWatch](#)
- [Pediatrics](#)
- [Science](#)
- [Toxicological Research](#)
- User Fees
 - [Animal Drugs](#)
 - [Human Drugs](#)
 - [Medical Devices](#)

Information For

[Subscribe to
FDA's Free E-mail
Newsletters](#)

Sign up for
any of more than
20 lists.



U. S. Food and Drug Administration
5600 Fishers Lane, Rockville MD 20857-0001
1-888-INFO-FDA (1-888-463-6332)

- [Consumers](#)
- [Patients](#)
- [Health Professionals](#)
- [Health Educators](#)
- [State/Local Officials](#)
- [Industry](#)
- [Press](#)
- [Women](#)
- [FDA Alumni](#)
- [Español](#)
- [Teens](#)
- **KIDS**

FDA Consumer

[Current Issue](#)

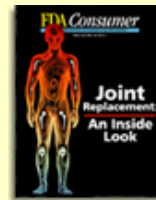

- [Joint Replacement: An Inside Look](#)
- [Take Our Quiz](#)
- [Subscribe](#)

[Search FDA Site](#) | [A-Z Index](#) | [Site Map](#) | [Contact FDA](#) | [Privacy](#) | [Accessibility](#) | [About This Website](#)

[FDA Website Management Staff](#)

USDA helps ensure that our products are safe and nutritious, and provides food aid to needy people overseas



Search

Browse by Subject

- ▶ Agriculture
- ▶ Education and Outreach
- ▶ Food and Nutrition
- ▶ Laws and Regulations
- ▶ Marketing and Trade
- ▶ Natural Resources and Environment
- ▶ Rural and Community Development
- ▶ Research and Science
- ▶ Travel and Recreation
- ▶ USDA Employee Services

You are here: **Home**

In the News

More 



[Remarks by Agriculture Secretary Ann M. Veneman Before the Inter-American Institute for Cooperation on Agriculture](#)

Agriculture Secretary Ann M. Veneman: "One of the greatest challenges before us is to improve the lives of millions of people around the world through better diets and improved nutrition."

- [Video of Opening Plenary Ministerial Conference Website](#)
- [USDA Ministerial Conference Info.](#)

[Transcript of Remarks by Agriculture Secretary Ann M. Veneman to the Consumer Federation of America's National Food Policy Conference](#)

[USDA Announces \\$190 Million In Loans To Support Rural Access To High-Speed Internet Technology](#)

[BSE Information and Resources](#)

Spotlights



[Healthy Forests Initiative](#)

Improving the health of our forests and rangelands.



[USDA eGov](#)

Making USDA, electronically available any place, any time.



[USDA Three-Year Review](#)

Agricultural accomplishments addressed by the Bush Administration.



[Faith Based Community Initiatives](#)

USDA helping people in need.

THREAT ADVISORY  elevated

I Want To...

- [View USDA Customer Statement](#)
- [Find a form](#)
- [Find weather and climate conditions](#)
- [Find commodity market reports](#)
- [Find current food recalls](#)
- [Apply for food stamps](#)
- [More...](#)

Announcements and Events

- [Ministerial Conference on Science and Technology To Increase Agricultural Productivity - May 10-11, 2004](#)
- [CRP: Planting for the Future - June 6-9, 2004](#)
- [Agriculture as a Producer and Consumer of Energy - June 24 - 25, 2004](#)



Find the information you need on the all new www.fsis.usda.gov

[View Botanical name list](#)

- [Aconite](#)
- [Alfalfa or Lucerne](#)
- [Alsike Clover](#)
- [Angel's Trumpet](#)
- [Arrowgrass](#)
- [Baneberry](#)
- [Belladonna](#)
- [Birdsfoot Trefoil](#)
- [Black Locust](#)
- [Bleeding Heart](#)
- [Bloodroot](#)
- [Bouncing Bet](#)
- [Bracken Fern](#)
- [Buckeye](#)
- [Buckwheat](#)
- [Buffalo Bur](#)
- [Buttercups or Crowfoot](#)
- [Castor Bean](#)
- [Celandine](#)
- [Christmas Rose](#)
- [Cocklebur](#)
- [Corn Cockle](#)
- [Corn Lily, False Hellbore](#)
- [Cow Cockle](#)
- [Creeping Charlie](#)
- [Crown Vetch](#)
- [Cherries, Black Cherry, Bitter Cherry, Choke Cherry, and Pin Cherry](#)
- [Daphne](#)
- [Death Angel Mushrooms](#)
- [Death Camas](#)
- [Death Cap Mushrooms](#)
- [Destroying Angels](#)
- [Delphiniums](#)
- [Devil's Trumpet](#)
- [Dock](#)
- [Dogbane](#)
- [Doll's-eyes](#)
- [Downy Thornapple](#)
- [Drooping Leucothoe](#)
- [Dutchman's Breeches](#)
- [Elderberry](#)
- [Ergot](#)
- [Fly Agaric](#)
- [Fiddleneck](#)
- [Flax](#)
- [Foxglove](#)
- [Golden Chain or Laburnum](#)

- [Great Lobelia, Cardinal Flower, and Indian Tobacco](#)
- [Ground Ivy, Creeping Charlie, and Gill-over-the-Ground](#)
- [Groundsels](#)
- [Halogeton](#)
- [Henbane](#)
- [Horsebrush](#)
- [Horse Chestnut](#)
- [Horse Nettle](#)
- [Horsetail](#)
- [Irises](#)
- [Jack-in-the-Pulpit](#)
- [Japanese Pieris](#)
- [Jessamine](#)
- [Jimsonweed](#)
- [Johnson Grass](#)
- [Klamath Weed](#)
- [Lamb's Quarters](#)
- [Lantana, Red Sage, Yellow Sage, or West Indian Lantana](#)
- [Larkspurs](#)
- [Lily-of-the-Valley](#)
- [Locoweed](#)
- [Lupine](#)
- [Marijuana](#)
- [Marsh Marigold or Cowslip](#)
- [Mayapple and Mandrake](#)
- [Mexican Poppy](#)
- [Milkweed](#)
- [Milo](#)
- [Monkey Agaric Mushrooms](#)
- [Monkshood](#)
- [Moonseed](#)
- [Mountain Fetterbush](#)
- [Nightshade, Black Nightshade or Deadly Nightshade](#)
- [Oak Trees](#)
- [Oleander](#)
- [Onions and Chives](#)
- [Panther](#)
- [Panther Cap Mushrooms](#)
- [Pigweed](#)
- [Poison Hemlock](#)
- [Poison ivy](#)
- [Poison oak](#)
- [Poison Sumac](#)
- [Potato](#)
- [Poinsettia](#)
- [Pokeweed](#)
- [Ponderosa Pine](#)
- [Poppies including Opium Poppy](#)
- [Prickly Poppy](#)

- [Ragworts](#)
- [Red Clover](#)
- [Rhubarb](#)
- [Rosary Pea](#)
- [Saint Johns Wort](#)
- [Senecio](#)
- [Sensitive Fern](#)
- [Sierra Laurel](#)
- [Skunk Cabbage](#)
- [Squirrel Corn](#)
- [Snow-on-the-Mountain](#)
- [Sorghum](#)
- [Spurges](#)
- [Star-of-Bethlehem](#)
- [Stinging Nettle](#)
- [Sudan Grass](#)
- [Sweet clover](#)
- [Sweet Pea, Tangier Pea, Everlasting Pea, Caley Pea and Singletary Pea](#)
- [Tobacco and Tree Tobacco](#)
- [Tung Oil Tree](#)
- [Vetch, Hairy Vetch, Narrow-leaved Vetch, Purple Vetch and Broad Beans](#)
- [Water Hemlock or Cowbane](#)
- [White Clover](#)
- [White Snakeroot](#)
- [Wisteria](#)
- [Wolfsbane](#)
- [Yellow Star Thistle](#)
- [Yew](#)

[View Botanical name list](#)

Scientific Name: *Brassica spp.*,

Common Name: Rape, Cabbage, Turnips, Broccoli, Mustard



Species Most Often Affected: cattle, humans, swine, sheep, goats, poultry

Poisonous Parts: roots, seeds

Primary Poisons: glucosinolates, brassica, anemia factor

[Scroll down for more images.](#)





Questions pertaining to *Brassica spp.*:
[I need information on some plants...](#)

This image is copyrighted. It may be used in teaching, printed, downloaded, or copied, provided it is in an educational setting and proper attribution is provided. Alteration of this image in any form is restricted.

Scientific Name: *Festuca arundinacea*

Common Name: Tall Fescue



Species Most Often Affected: cattle, horses

Poisonous Parts: all

Primary Poisons: diaziphenanthrene, pyrrolizidine, and ergot

Link to web page(s): plants/fescue.html

[Scroll down for more images.](#)



This image is copyrighted. It may be used in teaching, printed, downloaded, or copied, provided it is in an educational setting and proper attribution is provided. Alteration of this image in any form is restricted.

Scientific Name: *Hyoscyanamus niger*

Common Name: Henbane



Species Most Often Affected: humans

Poisonous Parts: seeds

Primary Poisons: atropine, scopolamine, and hyoscyamine.

Questions pertaining to *Hyoscyanamus niger*:

[Does this situation seem reasonable?](#)

This image is copyrighted. It may be used in teaching, printed, downloaded, or copied, provided it is in an educational setting and proper attribution is provided. Alteration of this image in any form is restricted.

Fescue Toxicosis in Horses

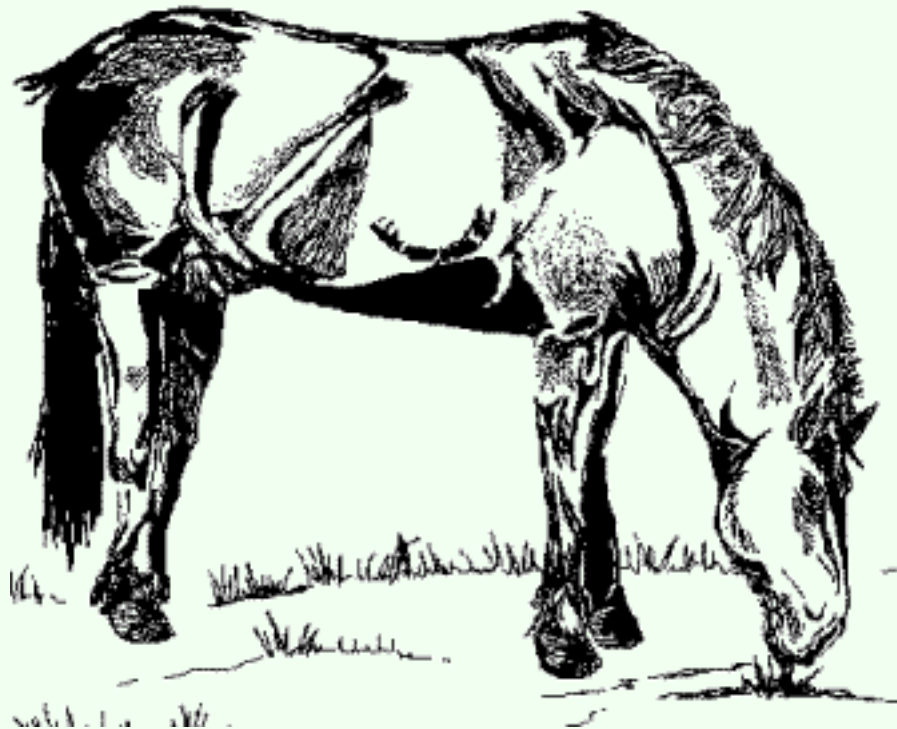

Equine fescue toxicosis is caused when pregnant mares eat [tall fescue](#) that is infected with an endophyte fungus, *Acremonium coenophialum*. Both the [mare](#) and the [foal](#) can be affected when the mare eats endophyte-infected fescue.

A pasture seeded with fescue may look appetizing to a horse (and its owner!), but don't judge a book by its cover!

All is not lost if your broodmare eats endophyte-infested fescue. [Treatment](#) is available, although [prevention](#) is the best protection.

[\[Fescue Toxicosis\]](#)[\[The Plant\]](#)[\[Fescue Pasture Mgmt & Eradication\]](#)[\[The Endophyte\]](#)[\[The Alkaloids\]](#)[\[Toxicosis in Mares\]](#)[\[Toxicosis in Foals\]](#)[\[Treatment\]](#)[\[Other Sources of Info\]](#)
[\[Return to list of toxicants\]](#)

[Click here for more info on the plant itself](#)

Acremonium coenophialum

The endophyte, *Acremonium coenophialum*, grows symbiotically with tall fescue. It is similar to the ergot fungus although *A. coenophialum* is evolutionarily derived from *Epicloe typhina*. This fungus is the reason for some of the advantages of fescue, such as

insect resistance. However, it is also the cause of the toxicity. The endophyte produces the toxic alkaloid substances (there is also some alkaloid production by the fescue itself). The major alkaloid produced is the indole alkaloid, ergovaline.

The endophyte grows between the plant cells. It is most proliferative in the spring, and closely associates with the growing flower and seed head. It is through contamination of the seed that infection of fescue is spread. Plant to plant or field to field transmission of the endophyte is very limited.

[\[Fescue Toxicosis\]](#)[\[The Plant\]](#)[\[Fescue Pasture Mgmt & Eradication\]](#)[\[The Endophyte\]](#)[\[The Alkaloids\]](#)[\[Toxicosis in Mares\]](#)[\[Toxicosis in Foals\]](#)[\[Treatment\]](#)[\[Other Sources of Info\]](#)
[\[Return to list of toxicants\]](#)

Fescue Alkaloids and Toxic Effects

Tall fescue produces the two diazaphenanthrene alkaloids, perlolidone and perloline. Under lab conditions, administering perloline to sheep has caused mild photosensitivity, increased pulse and respiration rates, loss of muscle control, convulsions, and comas. **However, perloline and perlolidone do not appear to be responsible for the fescue toxicities observed under field conditions.**

Rather, alkaloids produced by the endophyte appear to be the culprits.

Acremonium coenophialum produces both loline and ergopeptine classes of alkaloids. The lolines are saturated pyrrolizidine alkaloids with mild vasoconstrictive properties. They may possibly contribute to the hyperthermia (elevated body temperatures) and fescue foot (gangrene of the animal's extremities, often the rear hooves or tail tip) observed in cattle and sheep poisoned by fescue. However, the ergopeptine class of alkaloids produced by *Acremonium coenophialum* were shown in the mid-1970s to be the primary causative agents of fescue toxicity.

Ergopeptines are indole alkaloids that help chemically defend the fescue plants from insect pests and also have a positive influence on plant hormones and/or growth regulators. Unfortunately, they interfere with prolactin secretion, body temperature regulation, and feed intake of livestock grazing the infected fescue. Additionally, these alkaloids can constrict blood vessels, and reduce blood flow to the extremities.

The primary ergopeptine in fescue is

- ergovaline.

Others include

- ergosine
- ergonine, and
- lysergic acid amine (structurally similar to LSD)

[\[Fescue Toxicosis\]](#)[\[The Plant\]](#)[\[Fescue Pasture Mgnt & Eradication\]](#)[\[The Endophyte\]](#)[\[The Alkaloids\]](#)[\[Toxicosis in Mares\]](#)[\[Toxicosis in Foals\]](#)[\[Treatment\]](#)[\[Other Sources of Info\]](#)
[\[Return to list of toxicants\]](#)

Fescue Toxicosis: Effects on Broodmares

Unlike other livestock, the signs of fescue toxicity in horses are almost exclusively related to poor reproduction. Mares that consume large amounts of endophyte-infested tall fescue can suffer from a number of reproductive problems. These can include

- prolonged gestation
- abortion
- premature separation of the chorion
- dystocia
- thickened placenta
- retained placenta
- aglactia (suppression of lactation, i.e. no milk)

Additionally, mares who graze endophyte-infested fescue pastures in early pregnancy may have delayed pregnancy rates or early embryonic death.

Prolonged Gestation

The normal gestation length in horses is approximately 11 months. However, mares that graze on endophyte-infected fescue can have pregnancies that last up to 13 months or more. This is a problem because the fetus continues to grow during the extra time which can result in dystocia (difficult birth). The foals born after prolonged gestation may appear to be immature despite their extra fetal development.

The characteristics of a foal born after prolonged gestation include a large frame size and poorly developed muscles. Also, some foals may have overgrown hooves, while others may have premature and irregular eruption of baby teeth. These foals can also exhibit hyperthyroidism, resulting in poor suckling reflex, incoordination, and low body temperature.

[\[Fescue Toxicosis\]](#)[\[The Plant\]](#)[\[Fescue Pasture Mgnt & Eradication\]](#)[\[The Endophyte\]](#)[\[The Alkaloids\]](#)[\[Toxicosis in Mares\]](#)[\[Toxicosis in Foals\]](#)[\[Treatment\]](#)[\[Other Sources of Info\]](#)
[\[Return to list of toxicants\]](#)

Fescue Toxicosis: Effects on Foals

The newborn foal can suffer greatly from the effects of fescue toxicosis. The range of fetal deaths in the last third of pregnancy for herds affected by fescue toxicity varies from 0 to 100%.

Generalized symptoms associated with foals born to mares grazing on endophyte-infected fescue include

- [prolonged gestation](#)
- dystocia
- abnormal foal maturation
- weakness
- starvation (due to dam's agalactia)

Poor Immunity in Foals

Many foals born to mares pastured on endophyte-infected fescue have reduced immunity, which makes them highly susceptible to infections. Normally, foals receive antibodies from the mare in the form of colostrum, consumed almost immediately after birth. However, mares affected with fescue toxicosis are often agalactic, and so their production of milk is limited or nonexistent. Thus, the newborn foal is not able to consume enough colostrum to have an adequate transfer of antibodies from the mother to the foal. The foal is at risk to contract a number of illnesses and infections.

If a mare does not supply an adequate amount of milk or colostrum to the newborn foal, the foal should be given colostrum from a donor mare, or colostrum that is stored in a colostrum bank. If neither of these options is available, the foal should be given colostrum from another species of animal, followed by intravenous antibodies and a diet of supplemental milk. Cow or goat milk is often used, although additional sugar (in the form of dextrose) is added to more closely resemble the mare's milk.

[\[Fescue Toxicosis\]](#)[\[The Plant\]](#)[\[Fescue Pasture Mgmt & Eradication\]](#)[\[The Endophyte\]](#)[\[The Alkaloids\]](#)[\[Toxicosis in Mares\]](#)[\[Toxicosis in Foals\]](#)[\[Treatment\]](#)[\[Other Sources of Info\]](#)
[\[Return to list of toxicants\]](#)

Treatment of Fescue Toxicity

The best form of treating fescue toxicosis in horses is [prevention](#). However, this is not always possible. Nonpregnant horses can safely graze on endophyte-infected fescue pastures, as can broodmares during the second trimester of pregnancy. If a pregnant horse *must* graze on endophyte-infected fescue, there are pharmaceuticals available to

help reduce the adverse effects.

Some of the available drugs include

- domperidone (which prevents ergovaline from inhibiting prolactin release and, hence, prevents agalactia).
 - [More on obtaining this drug](#)
- perhenazine
- reserpine

[\[Fescue Toxicosis\]](#)[\[The Plant\]](#)[\[Fescue Pasture Mgmt & Eradication\]](#)[\[The Endophyte\]](#)[\[The Alkaloids\]](#)[\[Toxicosis in Mares\]](#)[\[Toxicosis in Foals\]](#)[\[Treatment\]](#)[\[Other Sources of Info\]](#)
[\[Return to list of toxicants\]](#)

More Information on Fescue Toxicosis in Horses

Fescue toxicosis is not unique to horses; it can affect any species of livestock that graze on endophyte-infected fescue. Some additional sources of information on fescue toxicosis include

- [Endophyte](#)
- [Tall Fescue Information System](#)
- [Hay for Horses](#)

Additional horse sites include

- [NetVet](#)
- [Horse Worldwide](#)
- [Gluck Equine Research Center](#)
- [Oklahoma State University Horse Resources](#)

This series of web pages was created by an undergraduate student at Cornell University for the AS625 class. All comments and suggestions are welcome.

WARNING: These web pages are only meant to be informative. Neither Cornell University nor the author of this site endorse or recommend the use of these plants.

Return to: [Poisonous Plants Homepage](#)
[List of Toxic Agents](#)

Home page: [Animal Science at Cornell University](#)

For problems or comments on this web page, contact the Animal Science [Webmaster](#)



Cornell University

Poisonous Plants Informational Database



Toxic Agents in Plants

ALKALOIDS

- [Indole Alkaloids](#) ([Beta-carbolines](#) etc.)
- Indolizidine
- [Piperidine](#)
- [Polycyclic Diterpene](#)
- [Pyridine](#)
- [Pyrrolizidine](#)
- Quinolizidine
- [Steroids](#)
- Tropane
- Tryptamine

ALCOHOLS AND KETONES

- Alcohols
 - Diacetone alcohol
 - Diethylene glycol
 - Ethanol
 - Ethylene glycol
 - Methanol
 - Propylene glycol
- Ketones
 - Cicutoxin
 - Tremetone
 - Tretatol

CARBOHYDRATES

- Oligosaccharides
- Beta-glucans
- Pectins
- Raffinose
- Simple Sugars

- Favism
- Fructose
- Galactose
- Lactose
- Sucrose
- Xylose

CHELATING POISONS

- [Nitrates](#)
- Nitrites
- [Oxalates](#)
- Phytates

GLYCOSIDES

- [Calcinogenic Glycosides](#)
- [Carboxyatractylosides](#)
- [Cardiac Glycosides](#)
- [Coumarins](#)
- Furocormarins
- [Glucosinolates \(Goitrogenic Glycosides\)](#)
- [Isoflavones and Coumestans](#)
- Nitroglycosides (Nitropropanol Glycosides)
- [Ranunculins](#)
- [Saponins](#)
- [Vicine/Covicine](#)

LIPIDS

- Fatty Acids
 - Cyclopropenoid fatty acids
 - Erucic acid
 - Fluoroacetate
- Glycolipids

METALS

- Heavy Metals
 - Copper
 - Mercury
 - [Selenium](#)
 - Arsenic

- [Lead](#)
- [Iron](#)

MYCOTOXINS

- [Aflatoxins](#)
- Citrinin
- Fungal Tremorgens
- Lupinosis
- Ochratoxins
- Patulin
- Rubratoxins
- Sporidesmin
- Stachybotryotoxins
- [Trichothecenes](#)
- [Zearalenone](#)

PHENOLIC TOXICANTS

- Cinnamic Acid
- Fagopyricin
- Gossypol
- Hypericin
- Pterocin
- Resorcinol
- Urushiol
- [Tannins](#)

PROTEINS AND AMINO ACIDS

- Allergens
 - Amylase Inhibitors
 - Enzymes
 - Lipoxidases
 - [Thiaminases](#)
 - Tocopheroxidase
- [Lectins](#)
 - Abris
 - Concanavalin
 - [Ricin](#)
 - Robin
- Plant Cytoplasmic Proteins

- [Polypeptides](#)
- Amino Acids
 - Nutrient
 - Leucine
 - Methionine
 - [SMCO](#)
 - [Tryptophan](#)
 - Non-nutrient
 - Arginine analogs
 - Canavanine
 - Indospecine
 - L amino D proline
 - dihydroxyphenylalanine
 - Lathyragens
 - [Mimosine](#)

RESINS

[SESQUITERPENE LACTONES](#)

VITAMINS

- Vitamin A
- Vitamin D metabolites

MISCELLANEOUS

- Ipomemaron - mycotoxin?
- Alsike Poisoning - mycotoxin?
- Red Maple Poisoning (similar to Brassica induced anemia)
- Plant Carcinogens
- N-Propyl Disulfide (similar to Brassica induced anemia)

Questions regarding content of this page, contact [Dr. Dan Brown](#)

Return to: [Cornell Poisonous Plants Home Page](#)

Return to: [Alphabetical List of Poisonous Plants](#)

Home page: [Animal Science at Cornell University](#)

For problems or comments on this web page, contact the Animal Science [Webmaster](#)

Structure of Beta-Carboline Alkaloids

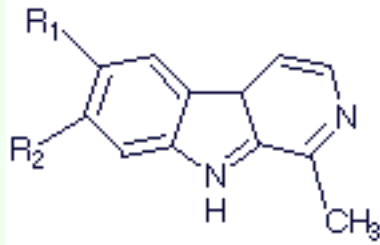

1. R₁ = H, R₂ = H, Harman
2. R₁ = H, R₂ = OMe, Harmine

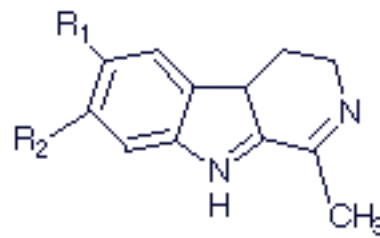

3. R₁ = H, R₂ = OMe, Harmaline
4. R₁ = H, R₂ = OH, Harmalol
5. R₁ = OMe, R₂ = H, 6-Methoxyharmalan

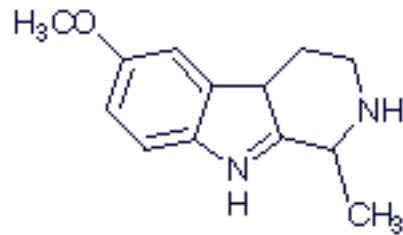

6. 6-Methoxy-tetrahydroharman



MIND BENDING BETA-CARBOLINES



Angiosperm Families Containing Beta-Carbolines

Apocynaceae

- *Amsonia tabernaemontana*
- *Apocynum cannabinum*
- *Apidosperma exalatum*
- *A. polyneuron*
- *Ochrosia nakainana*
- *Pleiocharpa mutica*

Bignoniaceae

- *Newbouldia laevis*

Calycanthaceae

- *Calycanthus occidentalis*

Chenopodiaceae

- *Hammada leptoclada*
- *Kochia scoparia*

Combretaceae

- *Guiera senegalensis*

Cyperaceae

- *Carex brevicollis*
- *C. parva*

Elaeagnaceae

- *Elaeagnus angustifolia*
- *E. commutata*
- *E. hortensis*
- *E. orientalis*
- *E. spinosa*
- *Hippophae rhamnoides*

- *Shepherdia argentea*
- *S. canadensis*

Fabaceae

- *Acacia baileyana*
- *A. complanata*
- *A. simplicifolia*
- *Anadenanthera peregrim*
- *Burkea africana*
- *Desmodium gangeticum*
- *D. gyrans*
- *S. pulchellum*
- *Mucuna pruriens*
- *Petalostylis labicheoides*
- *Prosopis nigra*

Gramineae

- *Arundo donax*
- *Festuca arundinacea*
- *Lolium perenne*
- *Phalaris aquatica*
- *P. arundinacea*

Lauraceae

- *Nectandra megapotamica*

Loganiaceae

- *Strychnos melinoniana*
- *S. usambarensis*

Malpighiaceae

- *Banisteriopsis argentea*
- *B. caapi*
- *B. inebrians*
- *B. lutea*
- *B. rusbyana*
- *Cabi pratensis*

Myristicaceae

- *Gymnacranthera paniculata*
- *Virola cuspidata*
- *V. rufula*
- *V. theidora*

Ochnaceae

- *Testulea gabonensis*

Palmae

- *Plectocomiopsis geminiflorus*

Papaveraceae

- *Meconopsis horridula*
- *M. napaulensis*
- *M. robusta*
- *M. rudis*
- *M. panuculata*
- *Papaver rhoeas*

Passifloraceae

- *Passiflora actinea*
- *P. alata*
- *P. alba*
- *P. bryonioides*
- *P. capsularis*
- *P. caerulea*
- *P. decaisneana*
- *P. edulis*
- *P. eichleriana*
- *P. foetida*
- *P. incarnata*
- *P. quadrangularis*
- *P. ruberosa*
- *P. subpeltata*
- *P. warmingii*

Polygonaceae

- *Calligonum minimum*

Rubiaceae

- *Borreria verticillata*
- *Leptactinia densiflora*
- *Nauclea diderrichii*
- *Ophiorrhiza japonica*
- *Pauridiantha callicarpoides*
- *P. dewevrei*
- *P. lyalli*

- *P. viridiflora*
- *Pavetta lanceolata*
- *Psychotria carthaginesis*
- *P. viridis*
- *Simira klugii*
- *S. rubra*
- *Uncaria attenuata*
- *U. canescens*
- *U. orientalis*

Rutaceae

- *Araliopsis tabouensis*
- *Findersia laevicarpa*
- *Xanthoxylum rhetsa*

Sapotaceae

- *Chrysophyllum lacourtianum*

Simaroubaceae

- *Ailanthus malabarica*
- *Perriera madagascariensis*
- *Picrasma ailanthoides*
- *P. crenata*
- *P. excelsa*
- *P. javanica*

Solanaceae

- *Vestia lycioides*

Symplocaceae

- *Symplocos racemosa*

Tiliaceae

- *Grewia mollis*

Zygophyllaceae

- *Fagonia cretica*
- *Nitraria schoberi*
- *Perganum harmala*
- *Tribulus terrestris*
- *Zygophyllum fabago*

This series of web pages was created by an undergraduate student at Cornell University for the AS625 class. All comments and suggestions are welcome.

WARNING: These web pages are only meant to be informative. Neither Cornell University nor the author of this site endorse or recommend the use of these plants.

Return to: [Poisonous Plants Homepage](#)

Home page: [Animal Science at Cornell University](#)

For problems or comments on this web page, contact the Animal Science [Webmaster](#)

MIND BENDING BETA-CARBOLINE REFERENCES

- [1] Allen, J.R. and B.R. Holmstedt. (1979). *Phytochemistry* (19) 1573-1582.
- [2] Poindexter, E. H., and R.D. Carpenter (1962). *Phytochemistry* (1) 215
- [3] Kettenes-van Den Bouch, J.J. and C.A. Salemink. (1977). *J. Chromatography*. (131) 422.
- [4] Proliac, A. and M. Blanc. (1976). *Helv. Chem. Acta*. (59) 2503
- [5] Rodriguez, E. and J.C. Cavin. (1982). *Journal of Ethnopharmacology* (6) 303-309.
- [6] Mckenna, D. and G.H.N. Towers. (1981). *Phytochemistry* 20(5) 1001-1004
- [7] Cavin J.C. and E. Rodriguez. (1980) *Journal of Chemical Ecology* (14) 475-484
- [8] Cooper, J.R. Bloom, F.E. and R.H. Roth (1991) *Biochemical Basis of Neuropharmacology* 338-380

[Back to Beta Carboline Home Page](#)

AYAHUASCA: VISIONARY VINE OF THE AMAZON



Banisteriopsis caapi (Malpighiaceae)

Ayahuasca, caapi, kahpi, mihi, dapa, and yage are all terms used in reference to the hallucinogenic drink made from the bark of the neotropical lowland rainforest lianas, *Banisteriopsis caapi* and *B. inebrians*. The drink was originally used by the indigenous people of the upper Amazon and Orinoco rivers and is prepared by boiling the bark in water. The hallucinogens present belong to the [beta-carboline](#) class of alkaloids and the major psychoactive ingredients are harmaline, and to a lesser extent, harmine and tetrahydro harmine. In addition to the hallucinogenic effects of the [beta-carbolines](#), *Psychotria viridis* or *Diplopterys cabrerana*, are often added. Both these plants contain dimethyl tryptamine (DMT) and it seems that the effects of DMT are strongly potentiated by the mono amine oxidase inhibiting [beta-carbolines](#).

Current research on the pharmacological effects of [beta-carbolines](#) and ayahuasca are being undertaken by research groups at the University of California at Los Angeles as part of the [Hoasca Project](#)

There is also a growing body of evidence that points to the use of isoquinoline and tryptamine-related alkaloids such as the [beta-carbolines](#) as a strategy for the control of intestinal helminths and other microbes by forest dwelling people. It is readily accepted that hallucinogen use by the indigenous people of tropical America has a long history and is an integral part of their culture. In addition, during native ceremonies, repeated references are made to the cleansing and purifying properties of these drugs. Because

these compounds are not only hallucinogens, but powerful emetics with antimicrobial and antihelminthic properties, [5-6] it is suspected that the use of ayahuasca is more than vision seeking--it is actually chemotherapy. The mode of this antihelminthic action is believed to be related to the similarity in structure of [serotonin](#) to the [beta-carboline alkaloids](#). It is possible that these indole alkaloids are antagonists of serotonin in intestinal worm metabolism but little comparative data on the effects of naturally occurring psychoactive drugs on parasitic worms is available. Work in this area is currently underway.

[Back to Beta Carboline Home Page](#)

This series of web pages was created by an undergraduate student at Cornell University for the AS625 class. All comments and suggestions are welcome.

WARNING: These web pages are only meant to be informative. Neither Cornell University nor the author of this site endorse or recommend the use of these plants.

Return to: [Poisonous Plants Homepage](#)

Home page: [Animal Science at Cornell University](#)

For problems or comments on this web page, contact the Animal Science [Webmaster](#)



NEUROPHARMACOLOGY of BETA-CARBOLINE ALKALOIDS

Beta-carbolines are a class of indole alkaloids which are structurally similar and biosynthetically derived from the amino acid L-tryptophan. Tryptophan derivatives are very important in Central Nervous System (CNS) function and include the neurotransmitter, serotonin, the Pineal metabolite, melatonin, the potent hallucinogen, dimethyl tryptamine (DMT); and the mono amine oxidase inhibitors (MAOI), the beta-carbolines.

A clue as to the beta-carboline's mode of action can be seen by examining their relationship to serotonin. It seems that ingestion of beta-carbolines raises serotonin levels and this increase is a result of the inhibited action of mono amine oxidase (MAO). Normally, MAO degrades the neurotransmitters serotonin, dopamine, and epinephrine. Therefore, inhibition of this enzyme seriously affects brain chemistry.

MAO inhibitors fall into two classes: Irreversible and reversible MAOIs. In addition they can inhibit either or both of the two types of the MAO enzyme, MAO-A and MAO-B which are associated with serotonergic and dopaminergic neurons respectively [8]. Irreversible MAOIs (e.g. the hydrazides iproniazid and phenelzine) bind permanently to the enzyme and cause MAO inhibition lasting 1-2 weeks after ingestion. They are used clinically to treat depression. Reversible MAOIs, such as moclobemide, which is used as an antidepressant, and the beta-carbolines harmine and harmaline, are effective for a much shorter time, usually less than twenty-four hours. There are significant dangers in using MAO inhibitors. Most MAOIs potentiate the cardiovascular effects of tyramine and other monoamines found in foods. There are therefore several foods that should be avoided when on MAOIs. Ingestion of aged cheese, beer, wine, pickled herring, chicken liver, yeast, large amounts of coffee, citrus fruits, canned figs, broad beans, chocolate or cream while MAO is inhibited can cause a hypertensive crisis including a dangerous rise in blood pressure. Effects of amphetamines, general anaesthetics, sedatives, anti-histamines, alcohol, potent analgesics and anticholinergic and antidepressant agents are prolonged and intensified. Overdosage of MAOIs by themselves is also possible with effects including hyperreflexia and convulsions[8].

Another result of ingesting beta-carbolines or other MAOIs at high doses is the occurrence of vivid visual hallucinations. It is not understood whether this hallucinatory effect is related directly to the inhibition of MAO, but due to the structural similarity to serotonin, it is possible that beta-carbolines are acting as serotonin antagonists in much the same way LSD does. The current theory implicates LSD temporarily binding to the

[serotonin](#) receptor. Upon the release of LSD an over abundance of [serotonin](#) is present in the CNS and affects perception. It is notable, however, that the hallucinations experienced from ingestion of [beta-carbolines](#) differ from those experienced with LSD.

[Back to Beta Carboline Home Page](#)

This series of web pages was created by an undergraduate student at Cornell University for the AS625 class. All comments and suggestions are welcome.

WARNING: These web pages are only meant to be informative. Neither Cornell University nor the author of this site endorse or recommend the use of these plants.

Return to: [Poisonous Plants Homepage](#)

Home page: [Animal Science at Cornell University](#)

For problems or comments on this web page, contact the Animal Science [Webmaster](#)



MIND BENDING BETA-CARBOLINES



BETA-CARBOLINE CONTAINING PLANTS

Images property of www.nepenthes.com

The [beta-carbolines](#) are distributed among [23 angiosperm plant families](#). The most commonly used trivial nomenclature of the [beta-carboline alkaloids](#) is based on the root "harm" from *Peganum harmala* the plant that was first known to contain these compounds.

Peganum harmala (Zygophyllaceae) is a weed and wasteland species native to the deserts of India whose range stretches through the Gobi desert into the former Soviet Union. The [mature *Peganum harmala*](#) or the Syrian rue is a common livestock poison in the former Soviet rangelands but specific information concerning the extent of its damage are difficult to locate. The content of [beta-carbolines](#) in the Syrian rue range from 2% to 4%.

- [mature *Peganum harmala*](#)
- [Peganum harmala habitat](#)
- [Peganum harmala drawing](#)

[Passiflora incarnata](#) (Passifloraceae) or the Maypop passion flower is a common ornamental in the United States. This species and other varieties have been used as model systems to investigate the effects [beta-carboline alkaloids](#) have on insect feeding patterns [7]. The amount of [beta-carbolines](#) in this species range from 0.5 -1.0%.

- [Mature *Passiflora incarnata*](#)
- [Passiflora incarnata seedling](#)

[Banisteriopsis caapi](#) (Malpighiaceae) is a liana native to the new world tropics where it is the principle ingredient in the hallucinogenic beverage [ayahuasca](#). This plant and the beverage have received attention lately by several members of the scientific community involved with the [Hoasca Project](#) and more underground information can be found by referencing the King of Brews. The [beta-carboline](#) content in [Banisteriopsis caapi](#) ranges from 1.0 - 2.0%.

- [Banisteriopsis caapi](#)
- [Banisteriopsis caapi](#)

[Back to Beta Carboline Home Page](#)

This series of web pages was created by an undergraduate student at Cornell University for the AS625 class. All comments and suggestions are welcome.

WARNING: These web pages are only meant to be informative. Neither Cornell University nor the author of this site endorse or recommend the use of these plants.

Return to: [Poisonous Plants Homepage](#)

Home page: [Animal Science at Cornell University](#)

For problems or comments on this web page, contact the Animal Science [Webmaster](#)

Conium maculatum (Poison Hemlock)

Index

- [Distribution](#)
 - [Description](#)
 - [How to Distinguish From Other Plants](#)
 - [Toxic ingredient: Piperidine Alkaloids](#)
-



Distribution

Poison hemlock is native to Europe. However, it is now widely distributed across the United States, especially in the Northern states. It is common along roadsides, hiking trails, ditches and field borders.

Description

Poison Hemlock can grow to be about 6 to 10 ft. tall. It has leaves and white flowerheads resembling those of parsnips, carrots, and water hemlock. It has a fleshy, white taproot, a main stem with characteristic light red spots and a disagreeable smell. All plant parts are poisonous. However, the seeds contain the highest concentration of poison. The conium alkaloids are volatile and can even cause toxic reactions when inhaled.



mottling on the stems

note the characteristic red

How to distinguish from other plants

Water hemlock does not have the same main taproot and stem. Instead, water hemlock has a branching, tuberous root stalk similar to that of a dahlia plant. The lower part of the stem of water hemlock is divided into chambers which contain its toxicant. Poison Hemlock is also commonly confused with wild carrot, cow parsnip, etc. Human deaths have occurred from harvesting and consuming the roots as wild carrots or parsnips. The stems should always be checked for red mottling. However, this characteristic is not always readily apparant.

More information describing this plant can be found under its [listing](#) in the Canadian Poisonous Plants Information System, courtesy of Derek B. Munro.

This series of web pages was created by Yuan-Kuo Chen, an undergraduate student at Cornell University for the AS625 class. All comments and suggestions are welcome.

WARNING: These web pages are only meant to be informative. Neither Cornell University nor the author of this site endorse or recommend the use of these plants.

Return to: [Poisonous Plants Homepage](#)

Home page: [Animal Science at Cornell University](#)

For problems or comments on this web page, contact the Animal Science [Webmaster](#)

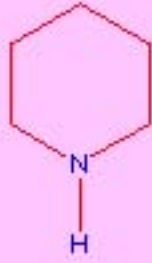

The saturated heterocyclic ring of a piperidine nucleus

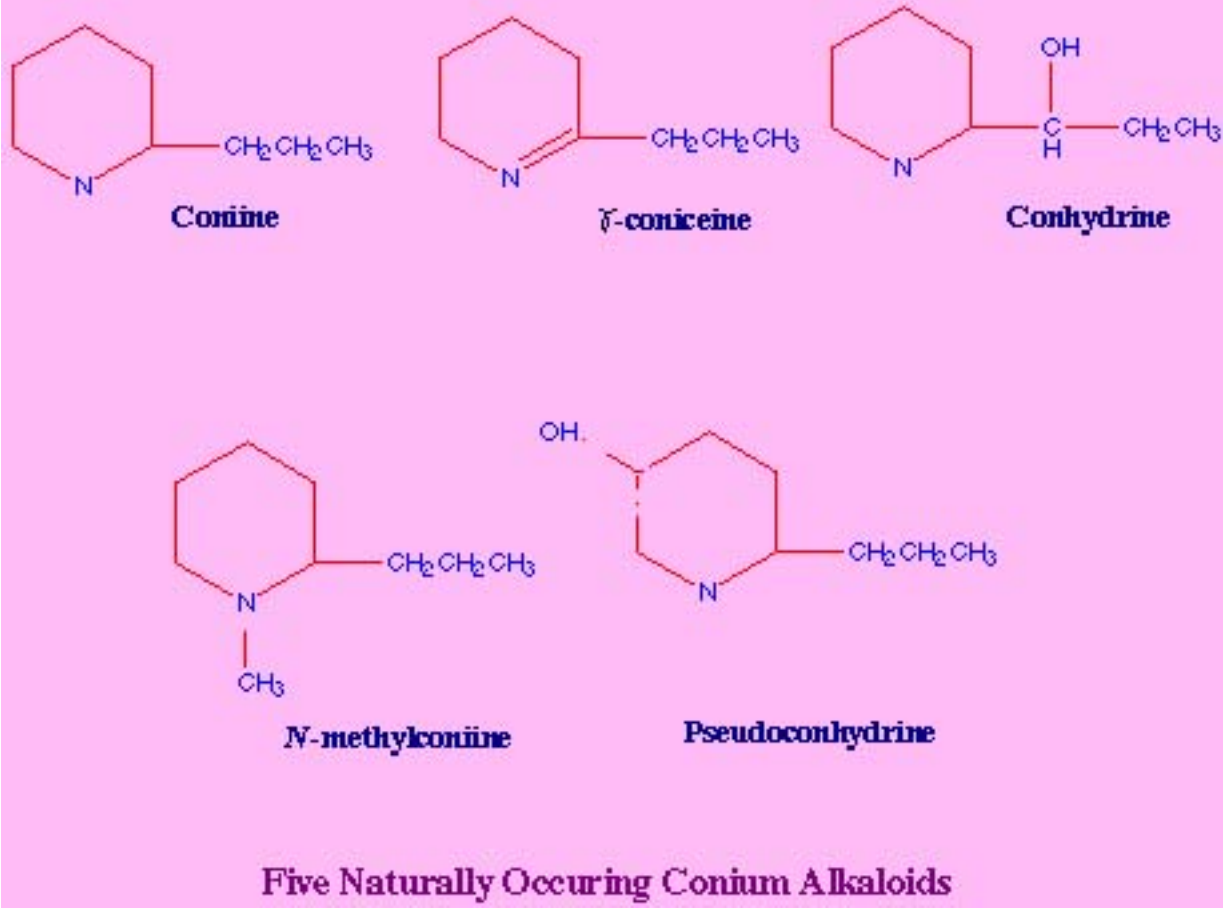

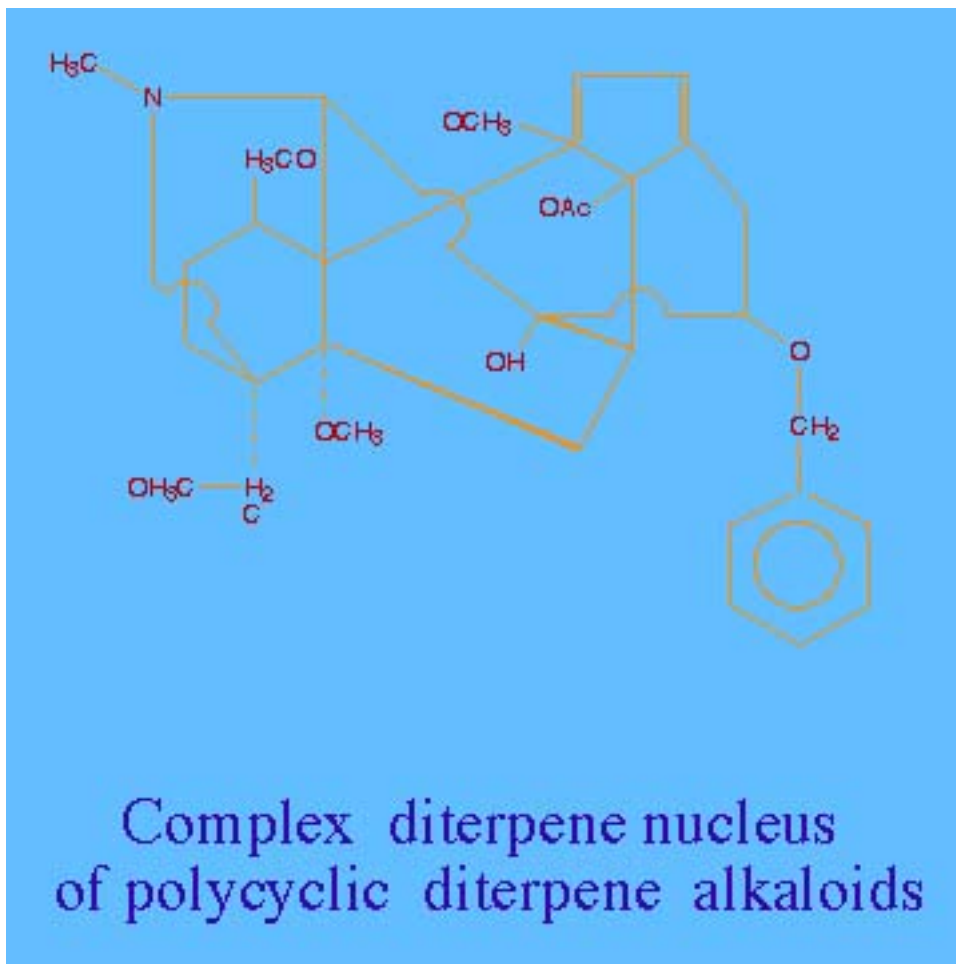

Nicotiana spp. (Tobacco and Tree Tobacco)

Distribution and description

Domestic tobacco (*N. tabacum*) is widely cultivated throughout the southeast United States. Wild tobaccos (*N. attenuata* and *N. trigonophylla*) are upright, leafy evergreen plants found in sandy, arid regions of the western US. Tree tobacco (*N. glauca*) is similar in appearance but can grow to be a small tree and is found at low elevations of Arizona and California.

Tobacco has large, simple, alternate, bright green, often sticky, leaves. Its stems are often sticky and hairy.



Tobacco flowers are organized in panicles. They have a tubular shape with 5 fused petals that flare at the mouth into 5 distinct lobes. They are fragrant and range in color from white to a very light pink, purple, or yellow.



More information describing them is available under the listing for [Nicotiana tabacum](http://www.ansci.cornell.edu/plants/tobacco.html),

Tobacco, in the Canadian Poisonous Plants Information System, courtesy of Derek B. Munro.

This series of web pages was created by an undergraduate student at Cornell University for the AS625 class. All comments and suggestions are welcome.

WARNING: These web pages are only meant to be informative. Neither Cornell University nor the author of this site endorse or recommend the use of these plants.

Return to: [Poisonous Plants Homepage](#)

Home page: [Animal Science at Cornell University](#)

For problems or comments on this web page, contact the Animal Science [Webmaster](#)



The Pyridine Alkaloid, Nicotine

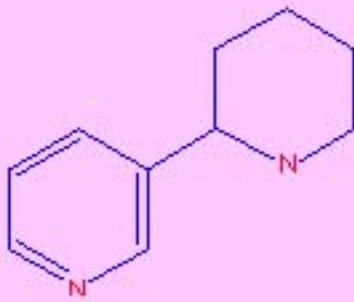

The Piperidine-Pyridine Alkaloid, Anabasine

Solanidine

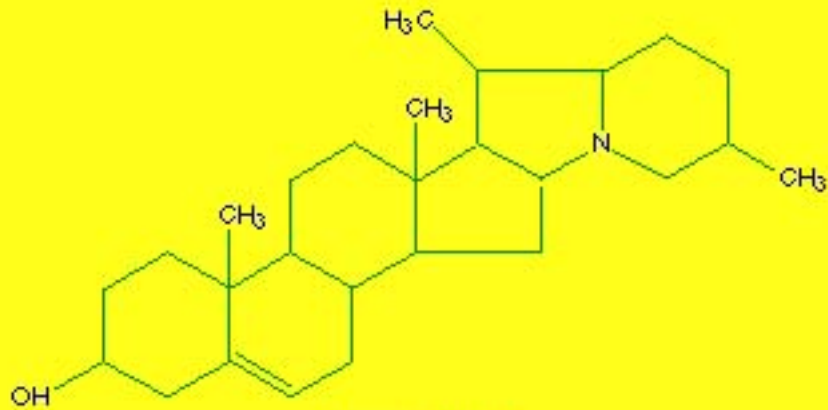

Veratramine

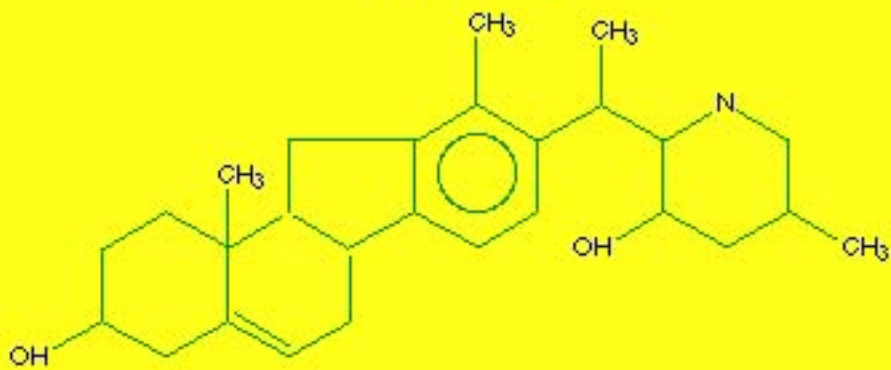

The two main types of steroid alkaloids in plants

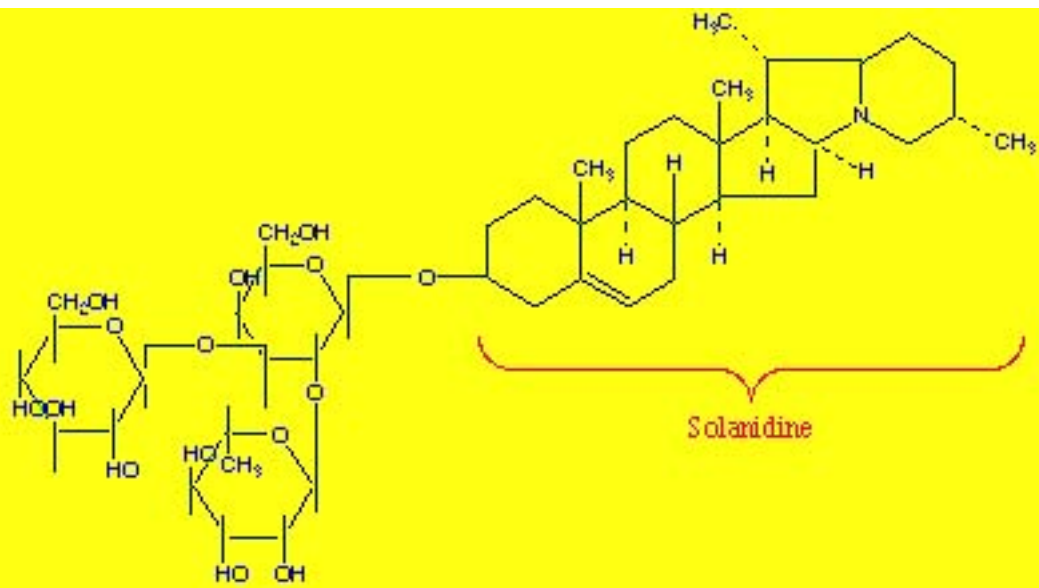

α - Solanine

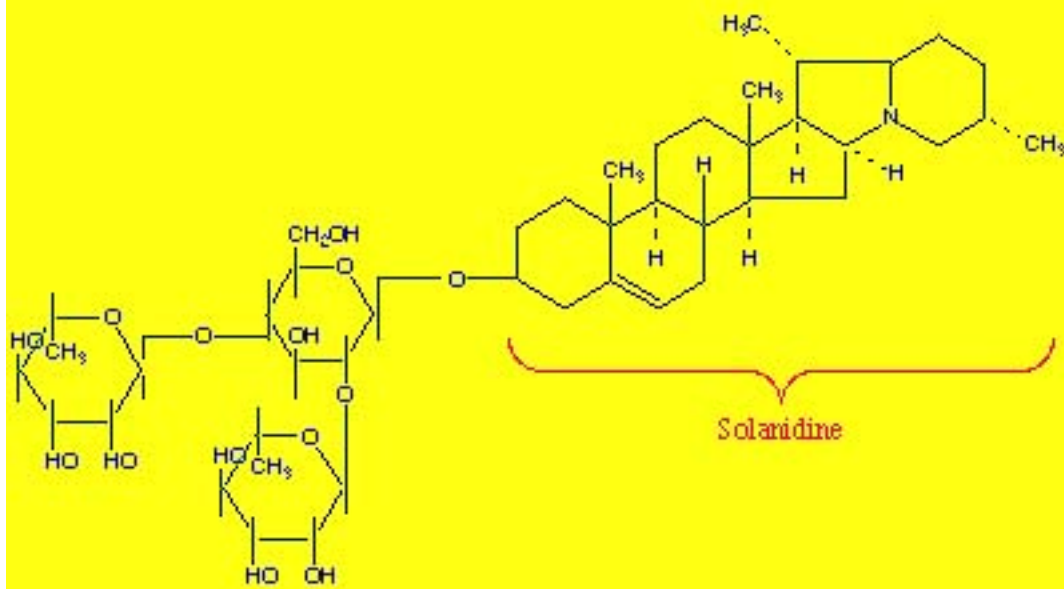

α - Chaconine

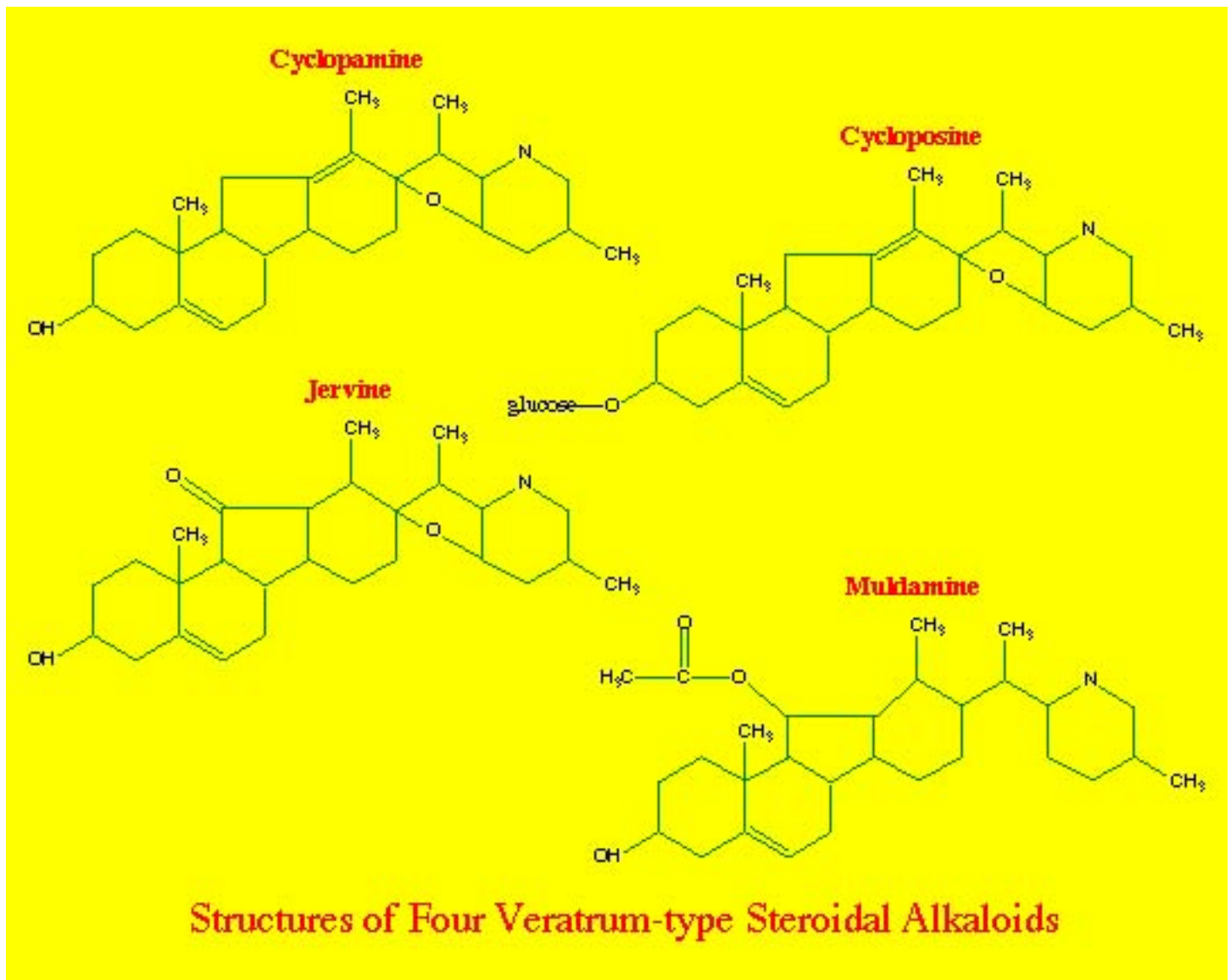

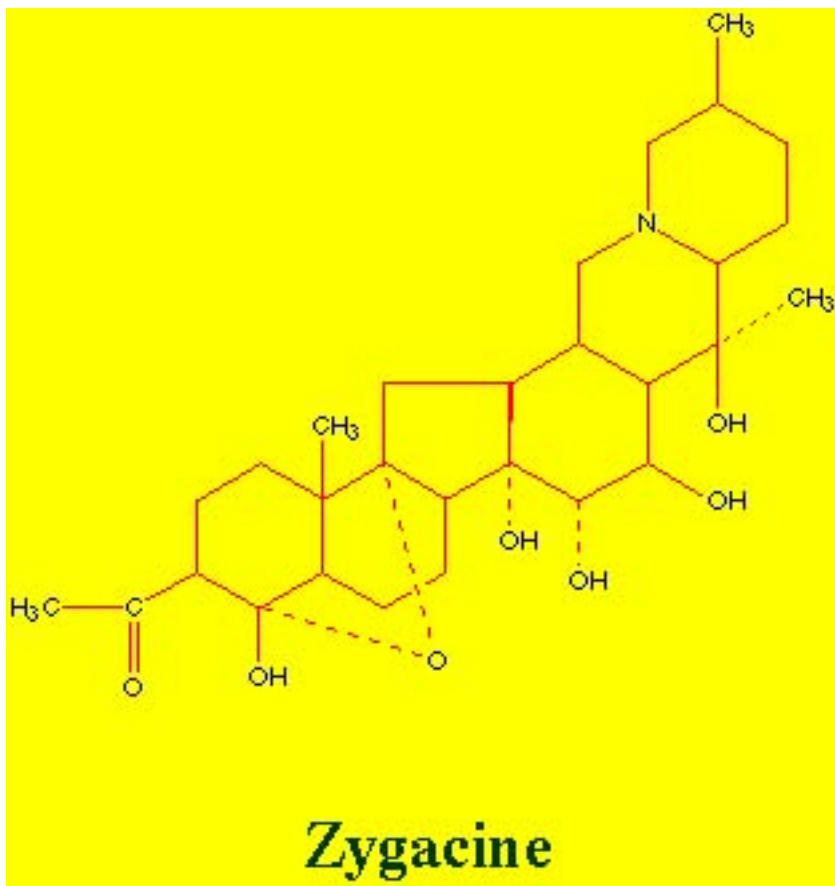

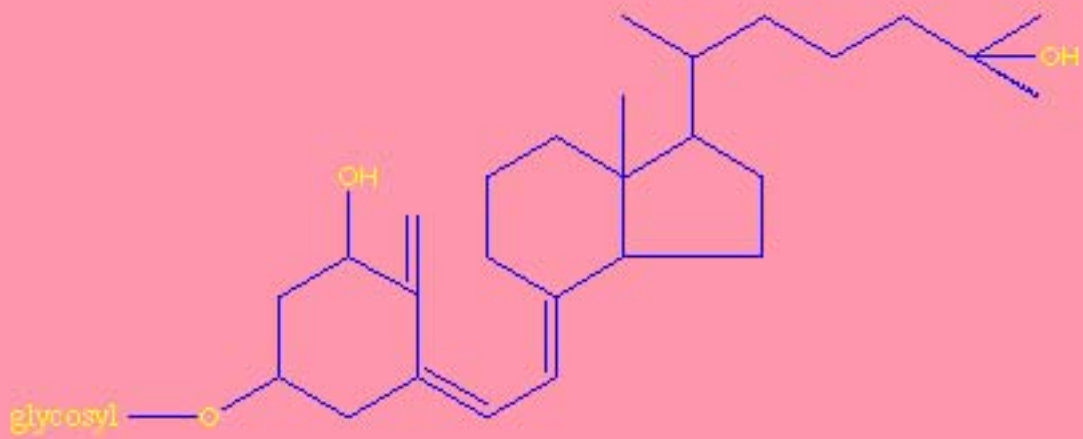

Basic Structure of a 1,25-dihydroxycholecalciferol glycoside

Formation of Coumarin and Dicoumarol

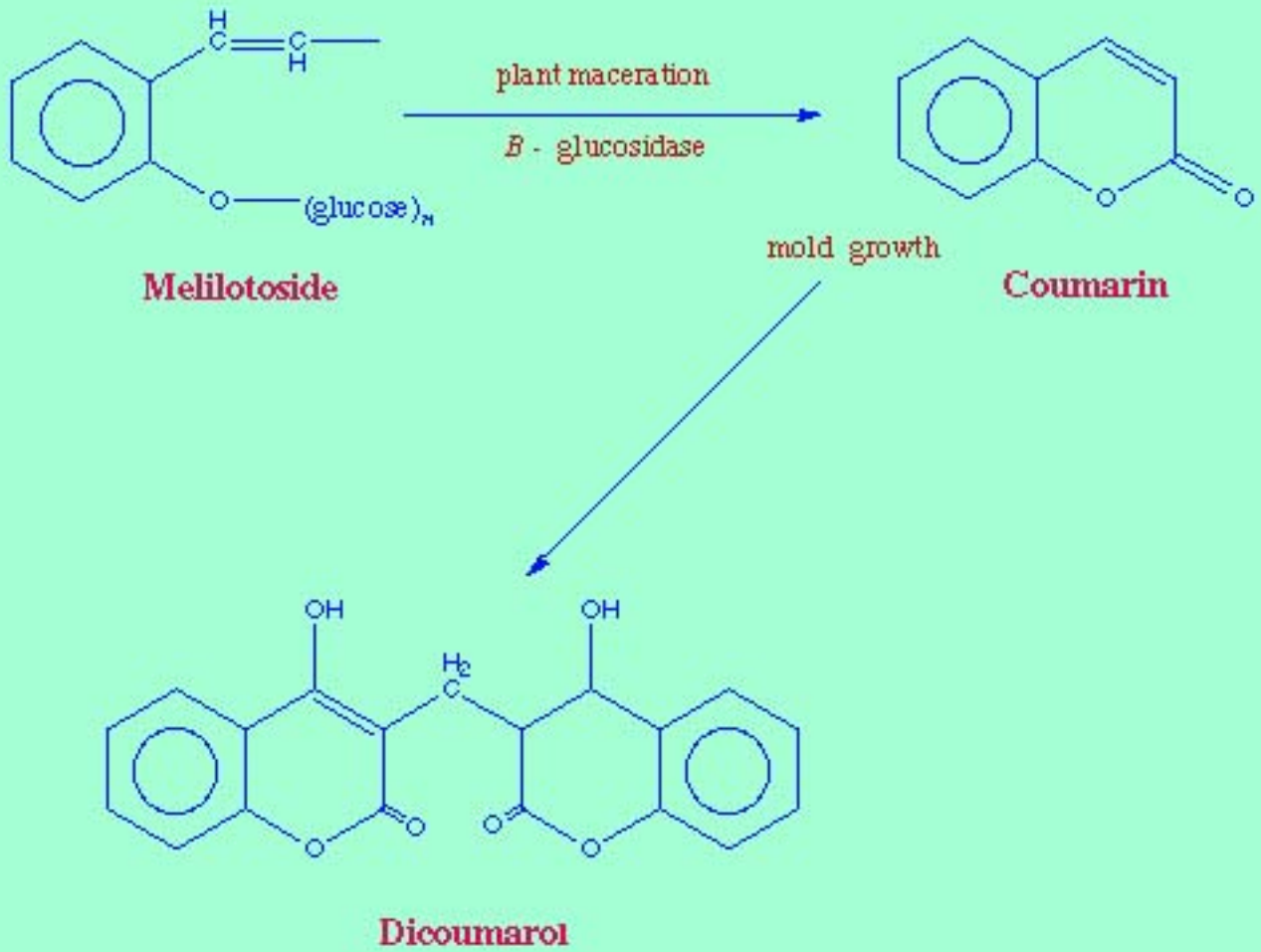

Process of Blood Clotting

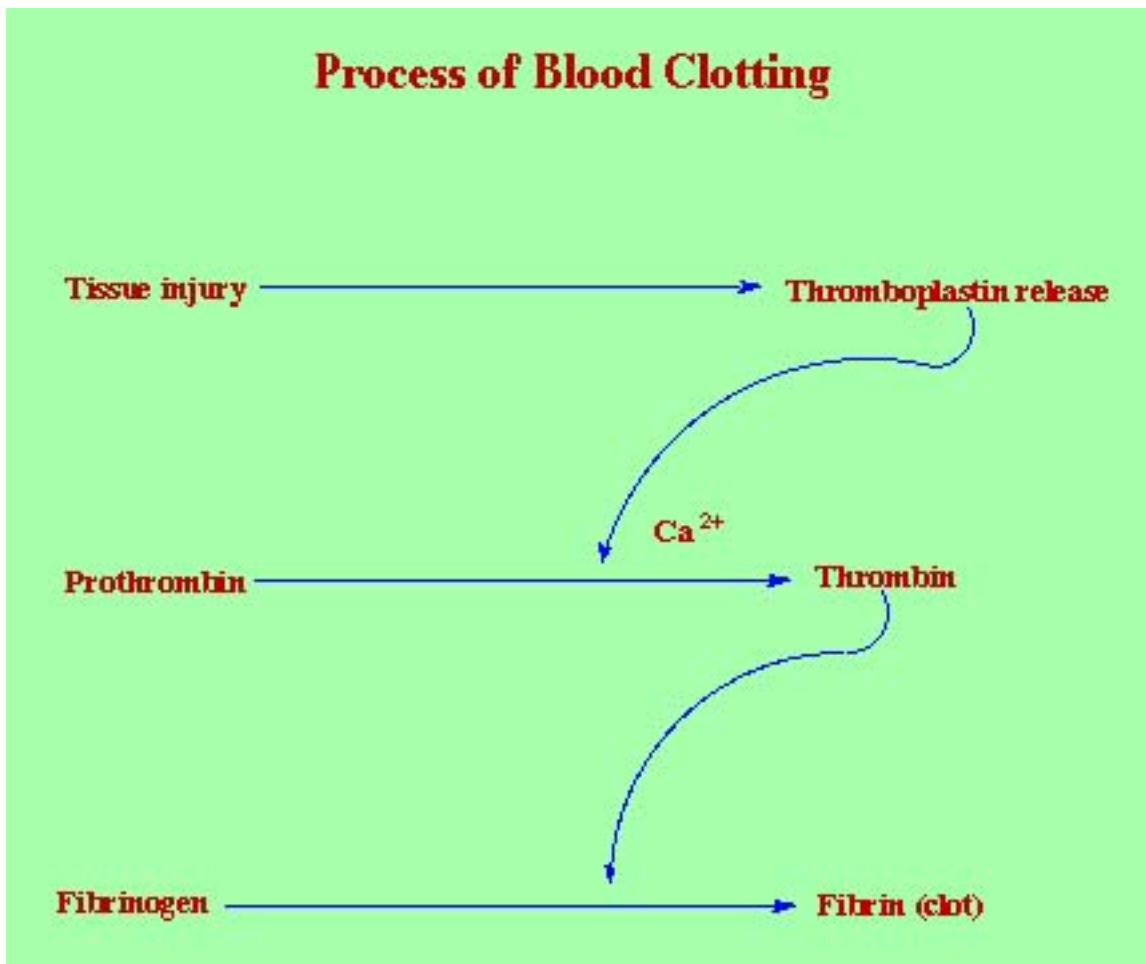

Most Furocoumarins have a furan ring fused with a coumarin nucleus and are derivatives of psoralen

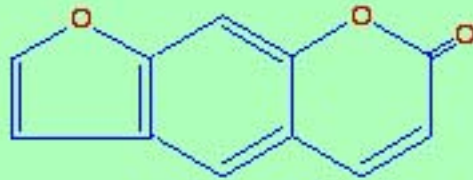

Psoralen

Selenium and Livestock

Map of Selenium Status in US

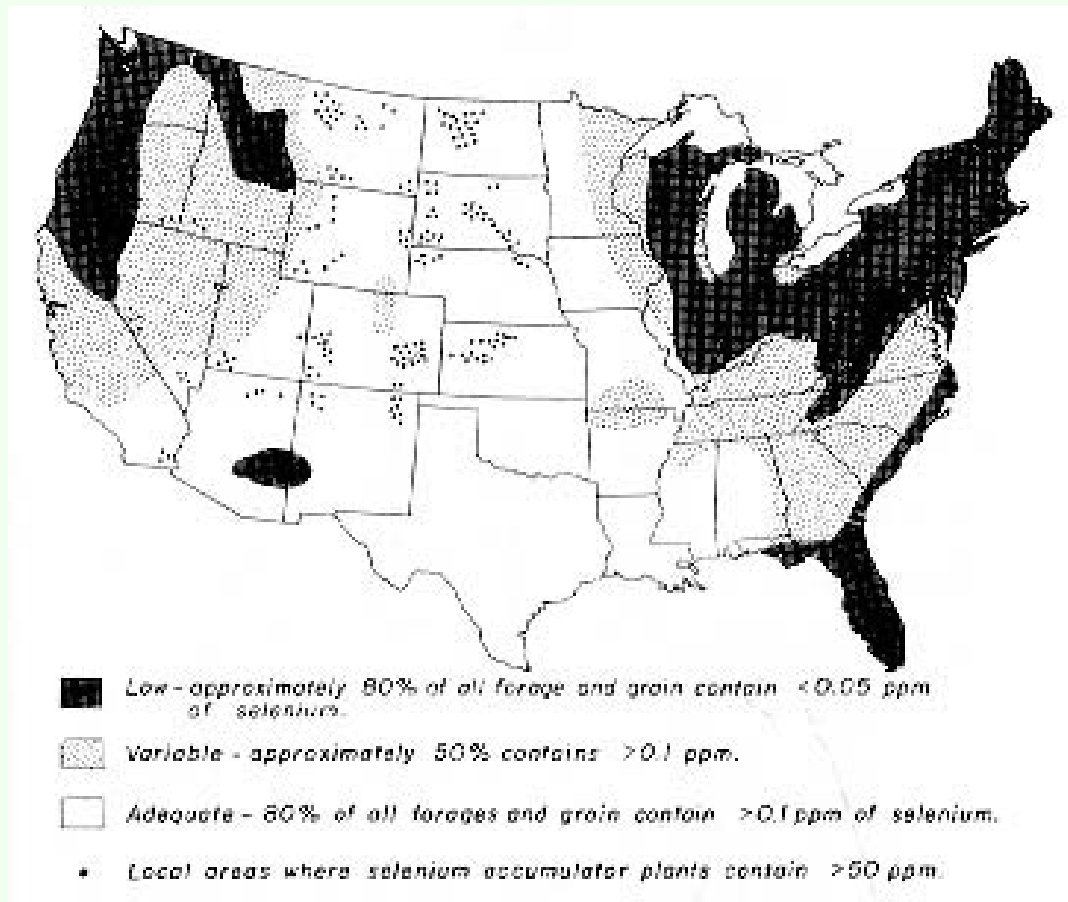

[Back to Selenium Page](#)

This series of web pages was created by an undergraduate student at Cornell University for the AS625 class. All comments and suggestions are welcome.

WARNING: These web pages are only meant to be informative. Neither Cornell University nor the author of this site endorse or recommend the use of these plants.

Return to:

[Return to Toxic Agents List](#)

[Poisonous Plants Homepage](#)

Home page: [Animal Science at Cornell University](#)

For problems or comments on this web page, contact the Animal Science [Webmaster](#)

The Toxicology of the *Astragalus* genus



[Click here for full size pictures of *Astragalus*](#)

To those of you with slow connections: these are a BIG color images ~120kb each



Members of the genus *Astragalus* are known by a number of different names. Those most widely used are **locoweed** and **milkvetch**. There are over 2000 species in this genus that are known currently, of which many are known to carry various toxins. (Williams, 1984) They can be found in North and South America, Asia, Europe, Northern Africa and Australia. There are nearly 400 species in North America whose range extends over most of most of the continent. (Ralphs, 1992) They are predominantly in the [central plains and grassland regions of the United States](#) where they are the most common of the Leguminosiae. Due to their range and toxicity, livestock poisoning by locoweed is the most widespread toxic plant problem in the western U.S., (Ralphs, James, Nielsen, Baker, Molyneux, 1988) costing millions of dollars both in livestock loss and in cost of plant control (Williams, 1984) Despite the unpleasant effects of *Astragalus* poisoning, animals often become habituated to eating, fueling their further intoxication by the plant. (Ralphs, Panter, James, 1990)

Astragali poison in three main ways:

- With the indolizidine alkaloid [swainsonine](#) as in the case of *A. lentiginosus* and *A. lusitanicus*
- With the nitropropanol bearing glycoside [miserotoxin](#) as in the case of *A. miser*

AND

- With toxic levels of [selenium metabolites](#) (Se) as in the case of *A. bisulcatus*

In this series of web pages I'd like to present a compilation of some of the toxicological information available on *Astragalus*. This will include a description of the specific toxicants named above, their modes of action, the physiological effects and the common symptoms of poisoning by [swainsonine](#), [miserotoxin](#) and [Se excess](#), as well as some [general effects of *Astragalus* intoxication](#). Also in these pages will be [some means to identify *Astragalus*](#), (whenever I could find them) and [that researchers have explored to control poisoning by these plants](#).

[References and Citations](#)

Return to [\[Alphabetical List\]](#) [\[Poison Plants Home Page\]](#)

These pages were created by [Mike Scimeca](#) as a term project for [Dr. Dan Brown's](#) class on [Nutritional Toxicology](#) in [Cornell's Animal Science department](#). I'd appreciate any comments that you have on these pages.

Astragalus and *Oxytropis* spp. (Locoweed and Milkvetch families)

The plant

Astragalus and *Oxytropis* are leguminous perennials found in large concentrations in western North America. Many species of *Astragalus* are not poisonous and are good rangeland forage plants. However, within the same species, concentrations of toxicants can vary widely from plant to plant so all locoweeds and milk vetches should be approached with caution and assumed potentially dangerous to livestock. Their leaves are alternate and pinnately compound. Flowers are leguminous and the fruit is a legume pod with kidney shaped seeds. The pod is often conspicuously enlarged causing the seeds to rattle in it when ripe, hence the common names, rattlebox and rattleweed, that are often assigned to it. The keel petal of *Oxytropis* tends to be long and pointed whereas that of *Astragalus* tends to be blunter.

Note that these two closely related genera also carry many of the same toxins. (James, Hartley, Panter, Nielsen)



locoweed foliage and flowers



locoweed pods



locoweed pods laid out for drying

Toxicology -symptoms and biochemistry

More information describing *Astragalus* and *Oxytropis* spp. is available under the listings for [*Astragalus lentiginosus*](#), Spotted Locoweed, [*Oxytropis lamberti*](#), Purple Locoweed, and [*Oxytropis sericea*](#), Locoweed, in the Canadian Poisonous Plants Information System, courtesy of Derek B. Munro.

Return to [\[Alphabetical List\]](#) [\[Poison Plants Home Page\]](#)



U.S. Environmental Protection Agency

Lead in Paint, Dust, and Soil

[Recent Additions](#) | [Contact Us](#) | [Print Version](#) Search:

[EPA Home](#) > [Prevention, Pesticides & Toxic Substances](#) >
[Pollution, Prevention & Toxics](#) > [Lead in Paint, Dust, and Soil](#) >
National Lead Information Center

The National Lead Information Center

[Basic Information](#)
[Lead in the News](#)
[Rules & Regulations](#)
[Education & Outreach](#)
[Technical Studies](#)
[Training & Certification](#)
[Other Lead Links](#)
[EPA Regions](#)

The National Lead Information Center (NLIC) provides the general public and professionals with information about lead hazards and their prevention. NLIC operates under a contract with the U.S. Environmental Protection Agency (EPA), with funding from EPA, the Centers for Disease Control and Prevention, and the Department of Housing and Urban Development.

Contact the National Lead Information Center to receive a general information packet, to order other documents, or for detailed information or questions.

By Phone: call and speak with a specialist Monday through Friday, 9:00 am to 7:00 pm eastern time (except Federal holidays) at **1(800) 424-LEAD [5323]**.

By Recorded Message: the NLIC telecommunications systems has the capability to receive recorded messages in English and Spanish 24-hours a day, seven days a week at **1(800) 424-LEAD [5323]**.

By FAX: 585-232-3111

By Mail: 422 South Clinton Avenue, Rochester, NY 14620

By E-mail: use the [form below](#) to send us your comments, questions, and/or document requests.

Online Document Request: You may use our online [Document Request Form](#) to order documents electronically.

Complete the form below and include your comments or questions and we will get back to you as soon as possible.

Your Name:

**Your
Organization:**

Your E-mail:

* required if
you seek reply

**Your Phone
Number:**

* will help us
contact you if
your e-mail is
not working

Comments:

Include mailing address if requesting paper copies of
publications

[EPA Home](#) | [Privacy and Security Notice](#) | [Contact Us](#)



U.S. Environmental Protection Agency

Lead in Paint, Dust, and Soil

[Recent Additions](#) | [Contact Us](#) | [Print Version](#) Search:

[EPA Home](#) > [Prevention, Pesticides & Toxic Substances](#) > [Pollution, Prevention & Toxics](#) > Lead in Paint, Dust, and Soil

[Basic Information](#)

[Lead in the News](#)

[Rules & Regulations](#)

[Education & Outreach](#)

[Technical Studies](#)

[Training & Certification](#)

[Other Lead Links](#)

[EPA Regions](#)



Lead is a highly toxic metal that was used for many years in products found in and around our homes. Lead may cause a range of health effects, from behavioral problems and learning disabilities, to seizures and death. Children 6 years old and under are most at risk, because their bodies are growing quickly.

Research suggests that the primary sources of lead exposure for most children are:

- deteriorating lead-based paint,
- lead contaminated dust, and
- lead contaminated residential soil.

EPA is playing a major role in addressing these residential lead hazards. In 1978, there were nearly three to four million children with elevated blood lead levels in the United States. In the 1990s, that number had dropped to 434,000 kids, and it continues to decline. While we still have a significant challenge, EPA is very proud of how federal, state, and private sector partners have coordinated efforts with the public to better protect our children.

Since the 1980's, EPA and its federal partners have phased out lead in gasoline, reduced lead in drinking water, reduced lead in industrial air pollution, and banned or limited lead used in consumer products, including residential paint. States and municipalities have set up programs to identify and treat lead poisoned children and to rehabilitate deteriorated housing. Parents, too, have greatly helped to reduce lead exposures to their children by cleaning and maintaining homes, having their children's blood lead levels checked, and promoting proper nutrition. The Agency's Lead Awareness Program continues to work to protect human health and the environment against the dangers of lead by developing regulations, conducting research, and designing educational outreach efforts and materials.

This site provides information about lead, lead hazards, and

Basic Information

[Facts about lead](#)

[Health effects of lead](#)

[Where lead is found](#)

[Where lead is likely to be a hazard](#)

[Checking your family and home for lead](#)

[What you can do to protect your family](#)





[Are you planning to buy or rent a home built before 1978](#)

[Remodeling or renovating a home with lead-based paint](#)

[Additional Resources](#)

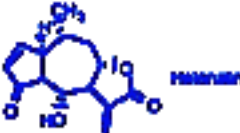
provides some simple steps to protect your family. For basic information start with the links to the right. For more specific information, and to search for and download documents use the links on the left. You can also order materials or speak to an information specialist by contacting [The National Lead Information Center \(NLIC\)](#) at **1-800-424-LEAD (5323)**.

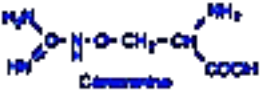
[EPA Home](#) | [Privacy and Security Notice](#) | [Contact Us](#)

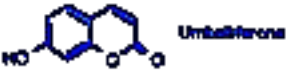
Family	Metabolites	Activity
Compositae	Sesquiterpene lactones:  Helenalin	Bitter tasting, some poisonous to cattle, antitumor, anthelmintics
Gramineae	Cyanogenic glucosides  Limonin	Almond smell, very toxic to mammals, antibiotics
Cruciferae	Glucosinolates:  Glucosyl-S-R	Irritating odor, cause blisters on skin, toxic to mammals, antitumor
Fabaceae	Non-protein aminoacids:  Canavanine	Insecticidal, neurotoxic to mammals, potential antiviral and antitumor
Geraniaceae	Hamiterpenoids:  Tiglic acid	Insect repellents, antifungal
Chenopodiaceae	Piperidine alkaloids:  Pseudopelletierine	Bitter tasting, neurotoxins, neurotoxins, antitumor
Umbelliferae	Coumarins:  Umbelliferone	Fish poisons, some toxic to rodents, antifungal, bactericidal

[\[go back\]](#)

Calendula arvensis



Anthemis arvensis

Urospermum dalechampii





Crysanthemum coronarium

[Go back](#) to General Description

This series of web pages was created by an undergraduate student at Cornell University for the AS625 class. All comments and suggestions are welcome.

WARNING: These web pages are only meant to be informative. Neither Cornell University nor the author of this site endorse or recommend the use of these plants.

Return to:

[Return to Toxic Agents List](#)

[Poisonous Plants Homepage](#)

Home page: [Animal Science at Cornell University](#)

For problems or comments on this web page, contact the Animal Science [Webmaster](#)

Calendula arvensis:

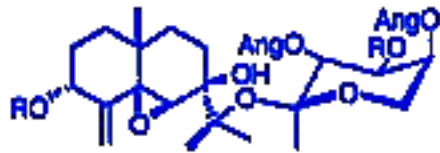

Anthemis arvensis:

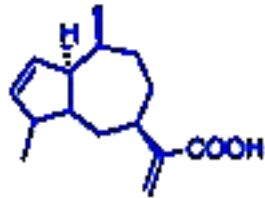

Aciphylla acid

Sonchus oleraceus:

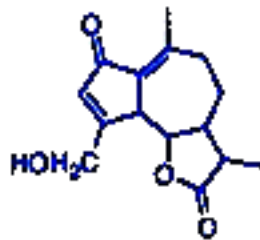

Jacquelinein

Urospermum dalechampii:

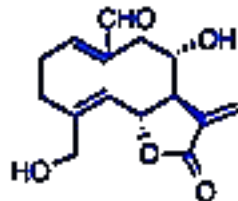

Urospermal A

[\[go back\]](#)

- DTWP001E: Net.Data is unable to locate the macro file plants_indiv.d2w.

Lactuca

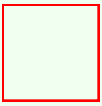

[\[go back\]](#)

Exocyclic Methylene Group

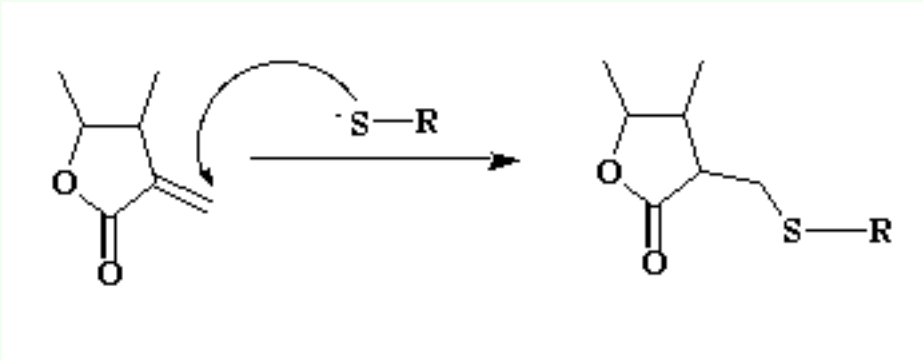

[\[return\]](#)

Buddleja americana

Index

- [Introduction and Description](#)
- [Common Names](#)
- [Chemical Compounds and Toxicity](#)
- [Uses and Efficacy](#)

Introduction and Description

Buddleja americana is a member of the family Loganiaceae and is native to Central America. The plant grows to a height of 3 meters. The leaves are oval (20cm) with white hairs on the edges. The flowers are very small and greenish-yellow. The plant has a strong odor.

Common Names

- Hoja blanca -- Honduras
- Salvia -- Honduras, El Salvador
- Zayolizcan

Chemical Compounds

Very little information regarding the types and quantity of chemical compounds in *Buddleja americana* could be found. Also, little toxic information could be found. The only information located stated that the plant contains saponic glycosides, alkaloids, tannins, sterols, and triterpenes, and that ethanol extracts are poisonous to fish. Since information on exact compounds could not be located, the following discussion is about general properties of these types of compounds.

Saponic glycosides occur in many temperate legume forages and are one of the causes of bloat in ruminants. They are bitter compounds and can decrease feed palatability and feed intake. While some saponins can decrease growth in swine and poultry, others have beneficial effects and are used as feed additives.

Alkaloids, in general, are bitter and toxic. However, many alkaloids have medicinal properties. Triterpenes are biochemically complex. Many terpenes have medicinal properties, though many also are toxic. Without better phytochemical information about this plant it is neither possible to determine if it contains compounds that may be medicinal nor ones that could be toxic.

[Return to Index](#)

Uses and Efficacy

As with the chemical composition and toxicity information, few data are available regarding the efficacy of *Buddleja americana*. Farmers in Honduras indicated that it was used to relieve stomach pain caused primarily by parasites. It normally is combined with plants that are supposed to kill the parasites. However, the only information regarding its efficacy was about its ability to control bacteria. Ethanol extractions were shown to inhibit *Escherichia coli* but not *Staphylococcus aureus*.

Some Uses in Humans:

- Headache -- Colombia
- Analgesic -- Mexico
- Burn -- Mexico
- Diuretic -- Mexico and El Salvador
- Cirrhosis -- Mexico
- Hepatitis -- Mexico
- Hypnotic -- Mexico
- Pain (stomach) -- Honduras
- Parasites -- Honduras
- Rheumatism -- Mexico and El Salvador
- Sore -- Mexico
- Tetanus -- Mexico
- Tumor -- Mexico
- Wound -- Honduras and Mexico

[Return to Index](#)

References

- Beckstrom-Sternberg, Stephen M., James A. Duke, and K.K. Wain. "The Ethnobotany Database." <http://probe.nalusda.gov:8300/cgi-bin/browse/ethnobotdb>. (ACEDB version 4.3-data version July 1994).
- Manual Popular de Plantas Medicinales Comunes de la Costa Atlantica de Honduras. 1996. Programa Tramil-Centroamérica/ENDA CARIBE.
- de Mena Guarero, M.G. 1994. Obtencion y Aprovechamiento de Extractos Vegetales de la Flora Salvadoreña. Editorial Universitaria, Salvador.

This series of web pages was created by a graduate student at Cornell University. All comments and suggestions are welcome. If you would like to add to this medicinal plant database, please [e-mail](#) Webmaster.

WARNING: These web pages are only meant to be informative. Neither Cornell University nor

the author of this site endorse or recommend the use of these plants.

Return to: [Medicinal Plants Homepage](#)

[Poisonous Plants Homepage](#)

Home page: [Animal Science at Cornell University](#)

For problems or comments on this web page, contact the Animal Science [Webmaster](#)

Carica papaya

Index

- [Introduction and Common Names](#)
- [Chemical Compounds](#)
- [Toxicity](#)
- [Uses and Efficacy](#)

Introduction

Carica papaya (Family Caricaceae) originated in Central America. It is an interesting tree in that the male and female parts exist in different trees. The fruits, leaves, and latex are used medicinally. Papain, a major compound in the fruit and latex has been used in brewing and wine making and the textile and tanning industries. Common names for papaya trees include:

- Betik petik
- Chich Put
- Fan Kua
- Gandul
- Katela gantung
- Kates
- Kavunagaci
- Kepaya
- Kuntaia
- Lechoso
- Lohong Si Phle
- Mapaza
- Mu Kua
- Papailler
- Papaw and pawpaw tree
- Papaya
- Papaye
- Papayer
- Pepol
- Tinti

- Wan Shou Kuo

[Return to Index](#)

Chemical Compounds

Carica papaya contains many biologically active compounds. Two important compounds are chymopapain and papain, which are supposed to aid in digestion. Papain also is used to treat arthritis. The level of the compounds vary in the fruit, latex, leaves, and roots. In addition, plant parts from male and female trees differ in the quantity of the compounds. For example, phenolic compounds tend to be higher male trees than female trees. The quantity of fresh papaya latex and dry latex (crude papain) also vary with the sex of the tree and the age of the tree. Female and hermaphrodite trees yield more crude papain than male trees and older fruit yields more than younger fruit. However, the activity of the papain is higher in the extracts from the younger fruit than the older fruit. Cultivars also vary in the quantity of the compounds. For example, the primary and secondary volatile compounds in the fruit of one cultivar studied were linalool and trans-linalool oxide, respectively. In another cultivar, the primary and secondary volatile compounds were cis-linalool oxide and linalool, respectively.

The following list of compounds found in parts of *Carica papaya* is not comprehensive. The quantity of the compounds are estimates based on several sources (listed in the references). For more information please refer to the references and the [USDA Phytochemical and Ethnobotanical Databases](#).

- alkaloids -- 1,300-4,000 ppm in leaves
- butanoic acid -- as much as 1.2mg/kg in fruit pulp
- methyl butanoate -- as much as 18% of the volatile components in the fruit
- carpaine -- leaves (1,000-1,500 ppm), bark, roots, and seeds
- dehydrocarpaines -- 1,000 ppm in leaves
- pseudocarpaine -- 100 ppm in leaves
- chymopapain-a and b -- latex and exudate
- flavonols -- 0-2,000 ppm in leaves
- benzylglucosinolate -- found in all parts of the plant, but highest in young leaves
- linalool -- as much as 94% of the volatile components in the fruit
- cis- and trans-linalool oxide -- fruit
- alpha-linolenic acid -- 250-2,238 ppm in fruit
- nicotine
- papain -- fruit and 53,000 ppm in latex and exudate
- alpha-phellandrene -- fruit
- tannins -- 5,000-6,000 ppm in leaves
- alpha-terpinene -- fruit
- gamma-terpinene -- fruit
- 4-terpineol -- fruit

- terpinolene -- fruit
- methyl-thiocyanate and benzyl-isothiocyanate

[Return to Index](#)

Toxicity

With the exception of infertility, the literature reviewed did not indicate any adverse reactions from the consumption of *Carica papaya* fruit, latex, or extracts. However, the leaves and roots of *Carica papaya* contain cyanogenic glucosides which form cyanide. The leaves also contain tannins. Both of these compounds, at high concentrations, can cause adverse reactions. Also, inhaling papaya powder (high in the enzymes papain and chymopapain, can induce allergies.

In trials with rats, daily oral doses of benzene and alcohol extracts (20mg/kg body weight (BW) for 30 days) did not effect body or reproductive organ weights or adversely effect liver or kidney function. However, aqueous extracts (1mg/kg BW for 7 or 15 days) and benzene extracts given orally to female rats caused infertility and irregular oestrous cycles. Male rats given ethanol seed extracts orally (10 or 50 mg/day for 30, 60, or 90 days) or intramuscularly (0.1 or 1.0 mg/day for 15 or 30 days) had decreased sperm motility. The oral doses also decreased testis mass and sperm count. Studies with aqueous seed extracts also decreased fertility in male rats. The fertility of the male and female rats returned to normal within 60 days after the treatments were discontinued.

In addition to decreasing infertility, papain might cause abortions shortly after conception. The papain apparently dissolves a protein(s) responsible for adhering the newly fertilized egg to the wall of the uterus.

[Return to Index](#)

Uses and Efficacy

The efficacy of treatments with *Carica papaya* is dependent on the quantity of the different compounds in the preparation. The quantity of the compounds, as previously indicated, differ in the fruit, latex, leaves, and roots and vary with the extraction method, age of the plant part, and the cultivar and sex of the tree.

The application of papaya latex that is probably of most interest to livestock producers is as an anthelmintic (dewormer). Satrija et al. (1994) tested the efficacy of papaya latex (at doses of 2, 4, and 8 g/kg BW) against *Ascaris suum* in 16 pigs. The eggs per gram (epg) on days 0, 1, 5, and 7 were determined using a modified McMaster technique and the adult worms were collected and sexed at necropsy on day 7. The 4- and 8-g/kg BW treatments significantly decreased the epg produced (by 99%) and the number of adult worms by 80 and 100%, respectively. The study conducted by Satrija et al. supports the results of other studies which indicate that papaya latex is effective against *Ascaridia galli* in chickens. One adverse effect of the treatment was transient diarrhea in the 8-g/kg BW group on day 1 of the study. In another study, water extracts of papaya seeds decreased *Ascaridia galli* infections in chicks by 41.7% (compared to piperazine hexahydrate which decreased infections by 99%).

In traditional veterinary medicine, papaya seeds also are used as dewormers. In Indonesia and the Philippines, air-dried seeds are ground and mixed with water - 3 g of seeds/kg bodyweight. The

animals are given the seed/water mixture once a day for 6 days. In Indonesia, papaya leaves are used as feed for animals after parturition - 2 leaves boiled in water fed every 2 days for 1 week. It also has been reported that papaya leaf extract is used as a prophylaxis against malaria, though no studies on this use could be found in the literature.

Results from studies on biological activities of *Carica papaya* parts, extracts, and isolated compounds are briefly summarized below:

- Antimicrobial
 - Latex (with a minimum protein concentration of 138 microliters/ml) and root extracts inhibited *Candida albicans*. However, aqueous extracts were not active.
 - Extracts of pulp and seeds showed bacteriostatic properties when tested against *Staphylococcus aureus*, *Escherichia coli*, *Salmonella typhi*, *Bacillus subtilis*, and other bacteria *in vitro*. However, in another study, aqueous extracts (type of extract and plant part not indicated) were not active against *Staphylococcus aureus* and *Escherichia coli* *in vitro*.
 - Alpha-D-mannosidase and N-acetyl-beta-D-glucosaminidase (isolated from latex) acted synergistically to inhibit yeast growth.
- Parasitic
 - Powdered air-dried seeds given orally to 4 dogs (60mg/kg BW for 30 days) decreased *Dirofilaria immitis* infections.
 - Papaya latex fed (at a rate of 2, 4, 6, or 8g/kg BW) to mice with experimental infections of *Heligmosomoides polygyrus* decreased infections rates by 55.5-84.5% compared to non-treated control mice.
 - Seeds at concentrations of less than 100 micrograms/ml exhibited activity against *Entamoeba histolytica* *in vitro*.
 - Benzylisothiocyanate (isolated from papaya) at concentrations of 100-300 micromoles inhibits the energy metabolism and affected the motor activity of *Ascaridia galli* *in vitro*
- Sedative and muscle relaxer -- studies with rats indicate that alcohol extracts (at a dose of 5 mg/kg BW intraperitoneally or greater) relaxed central muscles. The extracts (at a dose of 10 mg/kg BW intraperitoneally or greater) also had sedative properties.
- Purgative -- in one study with rats, aqueous extracts increased the number of wet feces and the movement of intestinal contents.

Papaya has been used to treat the following ailments in humans:

- Abortifacient -- Java, Panama, Sri Lanka, and Turkey
- Amebicide -- Japan
- Arthritis and rheumatism -- Haiti and Java
- Asthma and respiration -- Mauritius, Mexico, and Philippines
- Bactericide -- India
- Cancer -- Australia and Mexico
- Cardiotonic -- Turkey

- Colic -- Malaya
- Constipation and laxative -- Honduras, Panama, and Trinidad
- Corns and boils -- India, Malagasy, Malaya, and Philippines
- Decoagulant -- Trinidad
- Diarrhea and dysentery -- Honduras, Japan, Panama, and West Africa
- Digestive -- China, Dominican Republic, Panama, and Turkey
- Diuretic -- Trinidad
- Dyspepsia -- Mexico
- Dysuria -- Java
- Emmenagogue -- Mexico and Turkey
- Epithelioma -- St. Vincent
- Fever -- Java and Mexico
- Flu -- Trinidad
- Fumitory -- New Caledonia
- Hypertension -- Honduras and Trinidad
- Infection -- Panama
- Intestinal disorders -- Philippines
- Kidney -- Cameroon and Honduras
- Liver -- Honduras and Turkey
- Madness -- Ivory Coast
- Milk production (increase/stimulate) -- Indonesia and Malaysia
- Ophthalmology treatments -- Soviet Union
- Pectoral -- Mexico
- Scorpion bites -- Trinidad
- Smooth upper respiratory tract -- Nigeria
- Toothache -- Cote d'Ivoire and Samoa
- Tuberculosis -- Mexico
- Tumor (Uterus) -- Ghana Indochina Nigeria
- Ulcer -- Panama
- Urology treatments -- Soviet Union
- Venereal -- Trinidad
- Vermifuge -- Haiti, Malaya, Panama, Samoa, and Turkey
- Warts -- Indonesia, Jamaica, Peru, South Africa, and Sri Lanka

[Return to Index](#)

References

Not all of the references in the list below were used in writing this web page. Some references could not be easily located and others were in non-romance languages. They are included here so that a more complete resource list is available for those interested in the subject area.

- Akah, P.A., A.N. Oli, N.M. Enwerem, and K. Gamaniel. 1997. Preliminary studies on purgative effect of *Carica papaya* root extract. *Fitoterapia*, 68 (4): 327-331.
- Beckstrom-Sternberg, Stephen M., James A. Duke, and K.K. Wain. "The Ethnobotany Database." <http://probe.nalusda.gov:8300/cgi-bin/browse/ethnobotdb>. (ACEDB version 4.3 -data version July 1994).
- Beckstrom-Sternberg, Stephen M., and James A. Duke. "The Phytochemical Database." <http://probe.nalusda.gov:8300/cgi-bin/browse/phytochemdb>. (ACEDB version 4.3 - data version July 1994).
- Bennett, R.N., G. Kiddle, R.M. Wallsgrave. 1997. Biosynthesis of benzylglucosinolate, cyanogenic glucosides and phenylpropanoids in *Carica papaya*. *Phytochemistry*, 45 (1): 59-66.
- Bhattacharyya, R.K. and V.N.M. Rao. 1982. Phenolics content of Co.2 papaya (*Carica papaya* L.) as affected by growth regulants. *Journal of Research, Assam Agricultural University*, 3 (2): 214-215.
- Boom, B.M. 1989. Use of plant resources by the Chacobo. *Advances in Economic Botany*, 7: 78-96.
- Brocklehurst, K. and E. Salih. 1985. Fresh non-fruit latex of *Carica papaya* contains papain, multiple forms of chymopapain A and papaya proteinase OMEGA. *Biochemical Journal*, 228 (2): 525-527.
- Chinoy, N.J., Joshi Harsha, and Ghosh Shilpa. 1997. Toxicity related response of female albino rats treated with benzene and alcoholic papaya seed extracts. *Indian Journal of Environment and Toxicology*, 7 (2): 62-64.
- Chinoy, N.J., Joshi Harsha, and Ghosh Shilpa. 1997. Antifertility investigations of alcoholic papaya seed extract in female rats. *Journal of Medicinal and Aromatic Plant Sciences*, 19 (2): 422-426.
- Chinoy, N.J., K.G. Patel, and Chawla Sunita. 1997. Reversible effects of aqueous extract of papaya seed on microenvironment and sperm metabolism of cauda epididymis of rat. *Journal of Medicinal and Aromatic Plant Sciences*, 19 (3): 717-723.
- Chinoy, N.J. and P. Padman. 1996. Antifertility investigations on the benzene extract of *Carica papaya* seeds in male albino rats. *Journal of Medicinal and Aromatic Plant Sciences*, 18 (3): 489-494.
- Chinoy, N.J., Dilip Trivedi, and Harsha Joshi. 1995. Effect of *Carica papaya* seed extract on female rat ovaries and uteri. *Phytotherapy Research*, 9 (3): 169-175.
- Fischer, N. 1998. Flavour components in selected exotic fruits. *Food Australia*, 50 (4): 165-168.
- Flath, R.A. and R.R Forrey. 1977. Volatile components of papaya (*Carica papaya* L., *solo* variety). *Journal of Agricultural and Food Chemistry*, 25 (1): 103-109.
- Franco, M.R.B., Amaya D. Rodriguez, M.H. Damasio, and J.L.L. Carrillo. 1993. Volatile components and flavour of pawpaw (*Carica papaya*): a reappraisal. *Alimentos e Nutricao*,

5: 99-108.

- Franco, M.R.B. and Amaya D.B. Rodriguez. 1993. Volatile components of two pawpaw cultivars. *Arquivos de Biologia e Tecnologia*, 36 (3): 613-632.
- Ghosh, N.K., S.P.S. Babu, and N.C. Sukul. 1998. Antifilarial effect of a plant *Carica papaya*. *Japanese Journal of Tropical Medicine and Hygiene*, 26 (2): 117-119.
- Giordani, R., M.L. Cardenas, Traffort J. Moulin, and P. Regli. 1996. Fungicidal activity of latex sap from *Carica papaya* and antifungal effect of D(+)-glucosamine on *Candida albicans* growth. *Mycoses*, 39 (3-4): 103-110.
- Giordani, R. and L. Lafon. 1993. Action of *Carica papaya* latex on cell wall glycosidases from *Lactuca sativa* pith. *Phytochemistry*, 34 (6): 1473-1475.
- Giordani, R., A. Moulin, and R. Verger. 1991. Tributyrorylglycerol hydrolase activity in *Carica papaya* and other latices. *Phytochemistry*, 30 (4): 1069-1072.
- Giordani, R., M. Siepaio, Traffort J. Moulin, and P. Regli. 1991. Antifungal action of *Carica papaya* latex: isolation of fungal cell wall hydrolysing enzymes. *Mycoses*, 34 (11-12): 469-477.
- Grand, A. le. 1989. Anti-infectious phytotherapies of the tree-savanna, Senegal (West Africa) III: a summary of the phytochemical substances and the antimicrobial activity of 43 species. *Journal of Ethnopharmacology*, 25 (3): 315-338.
- Gundidza, M. 1986. Screening of extracts from Zimbabwean higher plants II: antifungal properties. *Fitoterapia*, 57 (2): 111-114.
- Gupta, A., C.O. Wambebe, and D.L. Parsons. 1990. Central and cardiovascular effects of the alcoholic extract of the leaves of *Carica papaya*. *International Journal of Crude Drug Research*, 28 (4): 257-266.
- Harsha, Joshi and N.J. Chinoy. 1996. Reversible antifertility effects of benzene extract of papaya seed on female rats. *Phytotherapy Research*, 10 (4): 327-328.
- House, P., S. Lagos-Witte, and C. Torres. 1992. Manual Popular de 50 Plantas Medicinales de Honduras, 3rd Ed. Guaymuras, Honduras.
- Idstein, H., C. Bauer, and P. Schreier. 1985. Volatile acids from tropical fruits: cherimoya (*Annona cherimolia* Mill.), guava (*Psidium guajava* L.), mango (*Mangifera indica* L. var. *alphonso*), pawpaw (*Carica papaya* L.). *Zeitschrift fur Lebensmittel-Untersuchung und -Forschung*, 180 (5): 394-397.
- IRR. 1994. Ethnoveterinary medicine in Asia: an information kit on traditional animal health care practices. Volume 2, Ruminants. International Institute of Rural Reconstruction, Silang, Cavite, Philippines.
- Kapanadze, I.S. and G.S. Khasaya. 1988. Some biological characteristics of pawpaw trees. *Subtropicheskie Kul'tury*, No. 1: 136-140.
- Kinyuy, W.C. 1993. Through integrated biomedical\ethnomedical preparations and ethnotaxonomy, effective malaria and diabetic treatments have evolved. *Acta Horticulturae*, No. 344: 205-214.
- Kumar, D., S.K. Mishra, H.C. Tripathi. 1991. Mechanism of anthelmintic action of benzylisothiocyanate. *Fitoterapia*, 62 (5): 403-410.

- Lohiya, N.K., R.B. Goyal, D. Jayaprakash, S. Sharma, M. Kumar, and A.S. Ansari. 1992. Induction of reversible antifertility with a crude ethanol extract of *Carica papaya* seeds in albino male rats. *International Journal of Pharmacognosy*, 30 (4): 308-320.
- Lorougnon, G. and L.A. Assi. 1989. The fight against toothache by the Betes of the Daloa region, Cote d'Ivoire. *Bulletin de la Societe Botanique de France, Actualites Botaniques*, 136 (3-4): 41-44.
- MacLeod, A. and N.M. Pieris. 1983. Volatile components of papaya (*Carica papaya* L.) with particular reference to glucosinolate products. *Journal of Agricultural and Food Chemistry*, 31 (5): 1005-1008.
- Madrigal, L.S., A.N. Ortiz, R.D. Cooke, and R.H. Fernandez. 1980. The dependence of crude papain yields on different collection ('tapping') procedures for papaya latex. *Journal of the Science of Food and Agriculture*, 31 (3): 279-285.
- Media Komunikasi Penelitian dan Pengembangan Tanaman Industri. 1991. Plants that stimulate mothers' milk production. No. 8: 32-35.
- Moore, D.J. 1980. A simple method of collecting and drying papaya (pawpaw) latex to produce crude papain. *Rural Technology Guide, Tropical Products Institute*, No.8.
- Ortega, A. and J.S. Pino. 1997. The volatile constituents of tropical fruits. II. Fruits of *Carica* species. *Alimentaria*, 35 (286): 27-40.
- Osato, J.A., L.A. Santiago, G.M. Remo, M.S. Cuadra, and A. Mori. 1993. Antimicrobial and antioxidant activities of unripe papaya. *Life Sciences*, 53 (17): 1383-1389.
- Pandey, A., B.R. Maity, K.R. Samaddar. 1996. Antifungal activity of plant latex towards certain fungal organisms. *Journal of Mycopathological Research*, 34 (1): 35-40.
- Pousset, J.L., B. Boum, and A. Cave. 1981. Antihaemolytic action of xylitol isolated from *Carica papaya* bark. *Planta Medica*, 41 (1): 40-47.
- Redina, E.F., L.G. Mezhlum'yan, L.G. Bazhenov, and P.Kh. Yuldashev. 1998. Determination of lysozyme in papaya latex preparations. *Chemistry of Natural Compounds*, 33 (5): 600.
- Sandhya, Rani P. and L. Veerannah. 1996. Studies on the biochemical constituents of root exudates of papaya. *South Indian Horticulture*, 44 (5/6): 118-120.
- Satrija, F., P. Nansen, S. Murtini, and S. He. 1995. Anthelmintic activity of papaya latex against patent *Heligmosomoides polygyrus* infections in mice. *Journal of Ethnopharmacology*, 48 (3): 161-164.
- Satrija, F., P. Nansen, H. Bjorn, S. Murtini, and S. He. 1994. Effect of papaya latex against *Ascaris suum* in naturally infected pigs. *Journal of Helminthology*, 68 (4): 343-346.
- Satyanarayanan, Rao V. and K.S. Krishnaiah. 1982. Note on the comparative efficacy of some indigenous anthelmintics against *Ascaridia galli* infection in chicks. *Indian Journal of Animal Sciences*, 52 (6): 485-486.
- Schwab, W. and P. Schreier. 1988. Aryl beta -D-glucosides from *Carica papaya* fruit. *Phytochemistry*, 27 (6): 1813-1816.
- Sheu, F. and Y.T. Shyu. 1996. Determination of benzyl isothiocyanate in papaya fruit by solid phase extraction and gas chromatography. *Journal of Food and Drug Analysis*, 4 (4): 327-334.

- Siddiqui, M.A., A. Haseeb, and M.M. Alam. 1987. Evaluation of nematicidal properties in some latex bearing plants. *Indian Journal of Nematology*, 17 (1): 99-102.
- Suhaila, Mohamed, Hassan Zahariah, and Abd Hamid Norhashimah. 1994. Antimicrobial activity of some tropical fruit wastes (guava, starfruit, banana, papaya, passionfruit, langsung, duku, rambutan and rambai). *Pertanika Journal of Tropical Agricultural Science*, 17 (3): 219-227.
- Tang, C.S. 1979. New macrocyclic DELTA 1-piperidine alkaloids from papaya leaves: dehydrocarpaine I and II. *Phytochemistry*, 18 (4): 651-652.
- el Tayeb, O., M. Kucera, V.O. Marquis, and H. Kucerova. 1974. Contribution to the knowledge of Nigerian medicinal plants. III. Study on *Carica papaya* seeds as a source of a reliable antibiotic, the BITC. *Planta Medica*, 26 (1): 79-89.
- Thomas, O.O. 1989. Re-examination of the antimicrobial activities of *Xylopiya aethiopica*, *Carica papaya*, *Ocimum gratissimum* and *Jatropha curcas*. *Fitoterapia*, 60 (2): 147-155.
- Tona, L., K. Kambu, N. Ngimbi, K. Cimanga, and A.J. Vlietinck. 1998. Antiamoebic and phytochemical screening of some Congolese medicinal plants. *Journal of Ethnopharmacology*, 61 (1): 57-65.
- Topuriya, L.I., V.I. Rossinskii, and G.S. Erkomashvili. 1978. Alkaloids of *Carica papaya*. *Khimiya Prirodnikh Soedinenii*, No.3: 414.
- Wagh, A.N., M.N. Bhalekar, and P.N. Kale. 1993. Effect of age of fruit on yield and quality of crude papain in some varieties of papaya. *Maharashtra Journal of Horticulture*, 7 (1): 41-45.
- Winterhalter, P., D. Katzenberger, and P. Schreier. 1986. 6,7-Epoxy-linalool and related oxygenated terpenoids from *Carica papaya* fruit. *Phytochemistry*, 25 (6): 1347-1350.
- Withopf, B., E. Richling, R. Roscher, W. Schwab, and P. Schreier. 1997. Sensitive and selective screening for 6'-O-malonylated glucoconjugates in plants. *Journal of Agricultural and Food Chemistry*, 45 (3): 907-911.

This series of web pages was created by a graduate student at Cornell University. All comments and suggestions are welcome. If you would like to add to this medicinal plant database, please [e-mail](#) Webmaster.

WARNING: These web pages are only meant to be informative. Neither Cornell University nor the author of this site endorse or recommend the use of these plants.

Return to: [Medicinal Plants Homepage](#)
[Poisonous Plants Homepage](#)

Home page: [Animal Science at Cornell University](#)

For problems or comments on this web page, contact the Animal Science [Webmaster](#)

Cecropia spp.

Index

- [Introduction and Description](#)
- [Common Names](#)
- [Chemical Compounds](#)
- [Toxicity](#)
- [Uses and Efficacy](#)

Introduction and Description

Cecropia spp. belong to the family Cecropiaceae (previously included in the family Moraceae) and are native to tropical America. The trees are reported to have a milky caustic latex, and many of them are attractive to ants. *C. peltata*, the species for which the most information was easily accessible, grows to a height of 20-25m. The bark is gray and red and has rings. The "umbrellas" can be 1m in diameter and the leaves which make up the umbrella can be 30-40cm in diameter. The branches are hollow.

Common Names

Cecropia spp.

- Trumpet Tree
- Trumpet Wood
- Snake Wood
- Yagrumo
- Yagrumo Hembra
- Llagrumo Hembra
- Bois Canot
- Guarumo
- Guarima
- Guarumbo
- Trompeta

C. peltata

- Bois Canon
- Bois Trompette
- Grayumbe

- Grayumbo
- Guarumo -- Honduras
- Trompette
- Trompettier
- Trumpet Tree
- Yagruma
- Yagrumo

[Return to Index](#)

Chemical Compounds

No information on chemical compounds in *Cecropia* spp. could be found.

Toxicity

The only toxicity information available indicates that *Cecropia* spp. may cause itching and skin rashes. These reactions are caused by the leaves and by the ants residing in the trees.

Uses and Efficacy

Cecropia peltata is used by some Honduran farmers to aid animals during birthing. It is given during labor to speed up the birthing process and after labor so that the placenta is quickly expelled. No information on the preparation or doses was available.

The only study that could be located regarding its medicinal properties indicated that leaf extracts had antigonorrheal activity.

Some Uses in Humans: *Cecropia* spp.

- Asthma -- Mexico
- Astringent -- Venezuela
- Cardiac -- Venezuela
- Dysentery -- Mexico
- Liver -- Mexico
- Masticatory -- Colombia
- Tonic -- Venezuela
- Ulcer -- Mexico
- Venereal -- Mexico
- Warts -- Mexico
- Wounds -- Mexico

C. peltata

- Asthma -- Haiti and Mexico

- Astringent -- Haiti
- Cardiotonic -- Haiti, Mexico, and Uruguay
- Caustic -- Mexico
- Chorea -- Mexico
- Cough and bronchitis -- Haiti and Trinidad
- Diabetes -- Mexico
- Diarrhea and dysentery -- Haiti
- Diuretic -- Mexico and Uruguay
- Dropsy -- Mexico
- Fever -- Trinidad
- Flu -- Trinidad
- Gonorrhoea -- Haiti
- Hepatitis -- Mexico
- Herpes -- Haiti
- Liver
- Nerve -- Mexico
- Obesity -- Mexico
- Poison -- Mexico
- Snake bites and scorpions -- Trinidad
- Warts, calluses, and corns -- Brazil, Cuba, Dominican Republic, French Guinea, Jamaica, Martinique, and Mexico
- Wounds -- Haiti

[Return to Index](#)

References

- Beckstrom-Sternberg, Stephen M., James A. Duke, and K.K. Wain. "The Ethnobotany Database." <http://probe.nalusda.gov:8300/cgi-bin/browse/ethnobotdb>. (ACEDB version 4.3 -data version July 1994).
- Beckstrom-Sternberg, Stephen M., and James A. Duke. "The Phytochemical Database." <http://probe.nalusda.gov:8300/cgi-bin/browse/phytochemdb>. (ACEDB version 4.3 - data version July 1994).
- Caceres, A., H. Menendez, E. Mendez, E. Cohobon, B.E. Samayoa, E. Jauregui, E. Peralta, G. Carrillo. 1995. Antigonorrhoeal activity of plants used in Guatemala for the treatment of sexually transmitted diseases. *J Ethnopharmacology* 48: 85-88.
- Paquet, J. 1981. Manual de Dendrologia de Algunas Especies de Honduras. Programa Forestal ACDI-COHDEFOR.

This series of web pages was created by a graduate student at Cornell University. All comments and suggestions are welcome. If you would like to add to this medicinal plant database, please [e-mail](#) Webmaster.

WARNING: These web pages are only meant to be informative. Neither Cornell University nor the author of this site endorse or recommend the use of these plants.

Return to: [Medicinal Plants Homepage](#)
[Poisonous Plants Homepage](#)

Home page: [Animal Science at Cornell University](#)

For problems or comments on this web page, contact the Animal Science [Webmaster](#)

Chenopodium ambrosioides

Index

- [Introduction](#)
- [Description](#)
- [Common Names](#)
- [Chemical Compounds](#)
- [Toxicity](#)
- [Uses and Efficacy](#)

Introduction

Chenopodium ambrosioides (Family Chenopodiaceas) originated in Central America, though it has been distributed to much of the world. It has been used as an anthelmintic (medicine for controlling internal parasites) for many years. In the early 1900s it was one of the major anthelmintics used to treat ascarids and hookworms in humans, cats, dogs, horses, and pigs. Usually, oil of chenopodium was used. It was sometimes referred to as Baltimore Oil, because of the large production facility in Baltimore that specialized in extracting the oil from the plant. Chenopodium was replaced with other, more effective and less toxic anthelmintics in the 1940s.

Chenopodium is still used to treat worm infections in humans in many countries. In Honduras, as well as other Latin American countries, the whole plant or the leaves are ground and added to water. This mixture is then consumed. In a few areas in Latin America, the plant also is used to treat worm infections in livestock. [Return to Index](#)

Description

Chenopodium ambrosioides is an herb that grows to a height of 40cm. The leaves are oval (up to 4cm long and 1cm wide) and toothed. The flowers are small and green, and the seeds are very small and green when fresh and black when dry. The plant has a very strong odor. Seeds can be purchased through seed catalogues. [Return to Index](#)

Common Names

- American Wormseed -- U.S.
- Apazote, Epazote, Ipazote -- Latin America
- Paico -- Peru
- Wurmsaamen Gansefuss -- Germany
- L'anserine vermifuge -- France

- Erva de Santa Maria -- Brazil

[Return to Index](#)

Chemical Compounds

There are many compounds in *Chenopodium*. The compound considered to be the active ingredient is ascaridole, a monoterpene. The major components of oil of chenopodium are: ascaridole (60-80%), isoascaridole, p-cymene, limonene, and x-terpinene. The level of the different compounds varies depending on the part of the plant, age of the plant, and whether it is dried or fresh plant material.

The quantity of ascaridole (or other compounds) in chenopodium can be determined using gas chromatography and mass spectrometry (GC/MS). The major compounds in chenopodium can be extracted with methanol or hexanes and then sent through the GC/MS.

Some of the Compounds in *Chenopodium ambrosioides* (for a more complete list see [USDA Phytochemical and Ethnobotanical Databases](#)):

- Alpha-pinene -- plant 440-4800 ppm
- Ascaridole -- leaves 185-18000 ppm
- D-camphor -- plant
- Essential oil -- fruit 1830-25000 ppm, leaves 2000-3000 ppm
- L-pinocarvone -- plant 1040-11400 ppm
- Limonene -- plant
- P-cymene -- leaves 365-4400 ppm
- P-cymol -- plant 730-8000 ppm
- Saponins -- roots 25000 ppm
- Terpinene -- plant
- Terpinyl-acetate -- plant 75 ppm
- Terpinyl-salicylate -- plant 75 ppm

[Return to Index](#)

Toxicity

Oil made from *Chenopodium ambrosioides* is very toxic. However, little is known about the toxicity of fresh and dried plant material, how the oil and plant are metabolized, and why toxic reactions occur. The reaction that animals have to chenopodium seem to vary. For example, one goat can show signs of mild toxicity, while another goat, from the same herd, may not show any adverse effects. Therefore, using this treatment can be risky. Signs of toxicity include: salivation, increased heart rate and respiration, changes in blood chemistry, decreased rumen motility, decreased contractions in the intestines, and convulsions. Oil of chenopodium can cause skin reactions, and it is dangerous to inhale.

Oil of chenopodium has caused death or adverse reactions at doses of:

- Goats -- 0.2ml/kg body weight (BW)
- Sheep -- 0.1ml/kg BW
- Cats -- 0.2ml/kg BW
- Dogs -- 0.2ml/kg BW (vomiting)
- Rabbits -- 0.5ml

The dose that causes adverse effects is very close to the dose that is supposed to be efficacious. Therefore, extreme caution should be used when treating an animal with this plant or the oil made from the plant. Other than treating the symptoms, there is no known cure to an overdose from this plant and the oil. [Return to Index](#)

Uses and Efficacy

Oil of Chenopodium and paste from fresh plant are primarily used to treat internal parasites in humans and non-ruminant animals. However, good data on efficacy is not available. Trials done in the early 1900s usually did not have control animals to which the treated animals could be compared.

In vitro studies with oil of chenopodium and chenopodium extracts have shown that it inhibits egg development of parasites and inhibits maturation of larva. However, these results have not been confirmed in in vivo studies.

Current research is being done on the potential of using chenopodium to treat ruminants at Cornell University. Results of the completed trials show that oil of chenopodium does decrease fecal egg counts. However, the decrease is not very large and does not compare to the control that can be achieved with other anthelmintics. Also, the effective dose does cause some adverse reactions in the animals. Oil of chenopodium has been shown (in vitro) to decrease egg hatching of *Haemonchus contortus*, a common parasite of small ruminants. Further research is needed to determine the efficacy, dose, and practical applications for oil and fresh plant material of *Chenopodium ambrosioides*.

When oil of chenopodium was in common use, it was administered via gel capsules and followed up with castor or linseed oil. Often, the person or animal taking the drug fasted first.

Recommended doses were:

- Dogs -- 0.03-0.1ml/kg BW followed by 30ml castor oil, fast for 24h before treatment
- Horses -- 16-18 ml and 1L of linseed oil, fast for 36h before treatment
- Swine -- 0.5-1ml/11.5kg BW, followed by 60ml castor oil
- Cats -- 0.03-0.05ml/kg BW, followed by 30ml castor oil
- Chickens -- 0.3ml in 3ml castor oil

Doses being tested are:

- Goats -- 0.2ml/kg BW
- Sheep -- 0.1ml/kg BW

Doses with fresh plant material are harder to determine, since the quantity of compounds in the plants varies so much. The only information on fresh plant doses are for humans. One book recommends two cups of a plant/water mixture (8 leaves with water) per day for adults and 3-4

tablespoons of the mixture per day for children over five. The book warns against giving the treatment to children under 5 and pregnant women.

Some Other Uses (in humans):

- Amebicide -- Trinidad
- Analgesic -- China
- Anemia -- Colombia
- Arthritis -- China
- Asthma -- Dominican Republic, Panama, Trinidad, and Turkey
- Bite(Bug) -- China
- Dysentery -- Panama and Trinidad
- Fungicide -- Trinidad
- Narcotic -- U.S.
- Nerves -- Mexico, Turkey, and U.S.
- Stimulant -- Trinidad and Turkey
- Stomach (ache) and/or colic -- Brazil, Chile, China, Dominican Republic, Haiti, Honduras, Mexico, Turkey, and Venezuela
- Vermifuge -- Bahamas, Brazil, China, Dominican Republic, Guatemala, Haiti, Mexico, Panama, Spain, Trinidad, Turkey, U.S., and Venezuela

[Return to Index](#)

References

- Beckstrom-Sternberg, Stephen M., James A. Duke, and K.K. Wain. "The Ethnobotany Database." <http://probe.nalusda.gov:8300/cgi-bin/browse/ethnobotdb>. (ACEDB version 4.3 -data version July 1994).
- Beckstrom-Sternberg, Stephen M., and James A. Duke. "The Phytochemical Database." <http://probe.nalusda.gov:8300/cgi-bin/browse/phytochemdb>. (ACEDB version 4.3 - data version July 1994).
- Bliss, A.R. 1925. A Pharmacodynamic study of the anthelmintic properties of western oils of chenopodium. *J of AVMA*, 19: 625-630.
- Craig, C.F. and E.C. Faust. 1940. Clinical Parasitology. Lea & Febiger: Philadelphia.
- Gibson, T.E. 1962. *Veterinary Anthelmintic Medication*, 2nd ed., Technical communication #33 of the Commonwealth Bureau of Helminthology, St. Albans, Herts.
- Guenther, E. 1952. The Essential Oils, vol. 6. D. Van Nostrand Co., NY: 151-161.
- Hall, M.C. 1930. The use of drugs in the treatment of diseases caused by nematode and trematode worms. 11th Int. Vet. Congress, London. John Bale, Sons & Danielsson, Ltd: London.
- House, P., S. Lagos-Witte, and C. Torres. 1992. Manual Popular de 50 Plantas Medicinales de Honduras, 3rd Ed. Guaymuras, Honduras.

- Jones, L.M. 1965. Veterinary Pharmacology and Therapeutics. Iowa State Univ. Press: Ames, Iowa: 607-608.
- Kato, S. 1997. Thesis, Cornell University, Ithaca, NY.
- Ketzis, J.K and D.L. Brown. 1998. The potential of using *Chenopodium ambrosioides* as an anthelmintic in goats. Proceedings of the 2nd Int. Conf. on Novel Approaches to the Control of Helminth Parasites of Livestock, March 22-26, Baton Rouge, LA.
- Kliks, M.M. 1985. Studies on the traditional herbal anthelmintic *Chenopodium ambrosioides* L.: ethnopharmacological evaluation and clinical field trials. Soc. Sci. Med. 21 (8): 879-886.
- Manual Popular de Plantas Medicinales Comunes de la Costa Atlantica de Honduras. 1996. Programa Tramil-Centroamérica/ENDA CARIBE.
- Opdyke, D.L.J. 1976. Monographs on fragrance raw materials. Food and Cosmetics Toxicology, 14S: 713-715.
- Salant, W. and C.W. Mitchell. 1916. The influence of oil of chenopodium on intestinal contractility. Amer. J. Of Phy., 39: 37-52.
- Salant, W. 1917. The pharmacology of the oil of chenopodium. JAMA, 69 (24): 2016-2017.
- Taylor, E.L. 1930. The use of drugs in the treatment of diseases caused by nematode and trematode worms. 11th Int. Vet. Congress, London. John Bale, Sons & Danielsson, Ltd: London.
- Wynn, S.G. 1996. Anthelmintic therapy in holistic veterinary practice. J. of the Amer. Holistic Vet. Med. Assoc., 15 (1): 15-19.

This series of web pages was created by a graduate student at Cornell University. All comments and suggestions are welcome. If you would like to add to this medicinal plant database, please [e-mail](#) Webmaster.

WARNING: These web pages are only meant to be informative. Neither Cornell University nor the author of this site endorse or recommend the use of these plants.

Return to: [Medicinal Plants Homepage](#)
[Poisonous Plants Homepage](#)

Home page: [Animal Science at Cornell University](#)

For problems or comments on this web page, contact the Animal Science [Webmaster](#)

Eucalyptus spp.

Index

- [Introduction](#)
- [Common Names](#)
- [Chemical Compounds](#)
- [Toxicity](#)
- [Uses and Efficacy](#)

Introduction

Eucalyptus spp. (Family Myrtaceae) originated in Australia. It now grows in almost all tropical and subtropical areas and is cultivated in many other climates. Much research has been conducted on the medicinal properties of *Eucalyptus spp.* Of the different species, *E. globulus* has been the most widely studied. Eucalyptus is used to treat many human ailments and some livestock ailments. Eucalyptus extracts, oils, or fresh leaves are used in steam inhalation treatments, consumed in teas, or used in bathing.

While *Eucalyptus* trees are well known for their medicinal properties and their strong fragrance, they are best known as the feed source for koala. The koala only eat a few species of *Eucalyptus*. However, there are over 500 species of the tree.

[Return to Index](#)

Common Names

- Blue Gum tree
- Eucalipto
- Eucalypt
- Eucalyptus
- Fever tree
- Lemon Eucalyptus
- Okaliptus
- Silver-leaf Ironbark

[Return to Index](#)

Chemical Compounds

There are many compounds in *Eucalyptus spp.*. While the same compounds exist in many of the species, some compounds can be found in only one or a few species. Within species the quantity of essential oil and the specific compounds in the essential oil and extracts of dry and fresh leaves, buds, mature fruit, and bark vary with the origin of the tree and the age of the leaves. The following discussion and list of *Eucalyptus spp.* and the compounds in them is not comprehensive. The quantity of the compounds in the oils and plant parts are estimates based on several sources (listed in the references). For more information please refer to the references and the [USDA Phytochemical and Ethnobotanical Databases](#).

E. globulus is one of the more important species of Eucalyptus. The essential oil in the leaves is commonly used for medicinal purposes. The quantity of essential oil ranges from less than 1.5 to over 3.5%. On average, between 70 and 95% of the oil is 1,8-cineole (eucalyptol). However, some studies have shown the oil to contain as little as 4% 1,8-cineole. The essential oil from the fruit, buds, and branches contain from 15-57% 1,8-cineole. Activities contributed to this compound include: anesthetic, antibronchitic, antidiarrheal, antilaryngitic, antipharyngitic, antiseptic, antitussive, CNS-stimulant, choleric, counterirritant, dentifrice, expectorant, fungicide, hepatotonic, herbicide, hypotensive, pesticide, and sedative. Other major components in the oil are:

- aromadendrene -- 8-23% in fruit, bud, and branch oils and 50-350 ppm in the leaves
- camphene -- traces in leaf oil
- cryptone -- 0-18% in leaf oil
- p-cymene -- <1-27% in leaf oil
- d-limonene -- traces in leaf oil
- alpha-phellandrene -- traces in leaf oil
- alpha-pinene -- <1-18% in leaf oil
- beta-pinene -- traces in leaf oil
- spathulenol -- <1-17% in leaf oil
- gamma-terpinene -- traces in leaf oil
- alpha-thujene -- 0-12% in fruit, bud, and branch oils

Other important compounds found in the leaves, buds, branches, and bark include:

- antioxidants (from bark) -- eriodictyol, naringenin, quercetin, rhamnagin, rhamnetin, taxifolin
- citriodorol
- cuminaldehyde -- 25-135 ppm in the leaves
- epiglobulol -- one study indicated 28,000 ppm in leaves
- euglobins -- These compounds are believed to have anti-tumor promoting activity.
- d-linalool -- leaves
- pinocarvone -- leaves
- rutin -- leaves
- tannins -- as much as 11% have been found in dry powdered leaves. Several activities have

been attributed to tannins including antidiarrhetic, antimutagenic, antinephritic, antioxidant, antiviral, bactericide, cancer-preventive, hepatoprotective, pesticide, psychotropic, and viricide properties.

- gamma-terpinene -- leaves
- terpineol -- leaves

E. citriodora essential oil contains mainly citronellol (approximately 58%), which is best known for its aromatic properties. Other compounds in the plant include:

- aromadendrene
- citronellal -- 50-18,020 ppm in the leaves
- citronellic acid -- 1% in leaf oil
- citronellol -- 7.6% in leaf oil and 230-4,000 ppm in the leaves
- citronellyl acetate -- 24% in leaf oil and 20-130 ppm in the leaves
- p-cymene -- 10-180 ppm in the leaves
- limonene -- 20-1,420 ppm in the leaves
- linalool -- 15-180 ppm in the leaves
- alpha-pinene -- 5-380 ppm in the leaves
- tannin
- terpinene -- 1-180 ppm in the leaves
- terpinolene -- 5-160 ppm in the leaves
- ursolic acid

E. camaldulensis essential oil (from the leaves) ranges from less than 1 to over 2%. The quantity of 1,8-cineole in the oil ranges from 15-78%. Other compounds in the leaves include:

- betulinic acid
- eucalyptic and eucalyptolic acid
- oleanolic acid
- ursolic acid

Other *Eucalyptus* spp. of note and some of the compounds in them include:

- *E. amplifolia*, *E. blakelyi*, *E. grandis*, and *E. tereticornis* contain euglobals.
- *E. cladocalyx* contains traces of cyanogenic glycosides.
- *E. cornea* leaves contain up to 25% tannins.
- *E. dives* oil contains 33% piperitone.
- *E. dunnii* oil contains 48-58% 1,8-cineole, 5-7% globulol, 10-16.5% alpha-pinene, and 3-8% alpha-terpineol.
- *E. macarthurii* oil contains 50% geranyl acetate.
- *E. macrocarpa* contains macrocarpal A, believed to be antibacterial.
- *E. macarorrhyncha* contains 12-20% rutin.
- *E. maidenii* and *E. smithii* oils contain 70-85% 1,8-cineole.

- *E. viminalis* oil contains high quantities of phellandrene (an inhalation irritant) and traces of cyanogenic glycosides.

[Return to Index](#)

Toxicity

Eucalyptus spp. contain high levels of phenolics and terpenoids which can be toxic. Animals such as the koala which eat *Eucalyptus* have developed methods for detoxifying the compounds in the liver. In addition, they have bacteria that degrade tannin-protein complexes. Most animals do not have this ability.

Several adverse reactions have been attributed to the use of or contact with *Eucalyptus* oils, extracts, and fresh and processed plant material. Some of the specific compounds that can be toxic or cause adverse reactions include: 1,8-cineole, cyanogenic glycosides, rutin, and tannins. Most studies on adverse reactions have been conducted with rodents and most documented cases of adverse reactions focus on humans. Less information is available on livestock.

Overdoses of the oil in humans cause gastro-intestinal burning, abdominal pain, vomiting, and convulsions, depress respiration and the central nervous system, and may lead to comas and death. The data on deaths caused by consumption of eucalyptus oil in humans are not consistent -- death has occurred after consumption of as little as 4-5 ml, while other people have become ill and recovered after consuming 120-220 ml of the oil. Based on rodent studies, the oral LD50 (the orally consumed dose that is lethal to 50% of the animals) for eucalyptus oil is very high -- 4.44g/kg body weight(BW) for rats and 3.32g/kg BW for mice. The LD50 is lower when only 1,8-cineole is used -- 2.48g/kg BW for rats. The dermal LD50 for rabbits is greater than 5g/kg BW.

Eucalyptus oil is not believed to be teratogenic or contaminate milk. However, some studies have indicated that citronellal and phellandrene, which can be found in some *Eucalyptus spp.*, are weak mutagenics and carcinogenics, respectively.

It is very difficult to determine the potential for adverse reactions with the use of *Eucalyptus* treatments. This is because, as previously stated, the type and quantity of compounds depends on the species (which often is not indicated on the label of purchased preparations), the age of the leaves, the method used for drying leaves, buds, and bark, and the preparation methods of essential oils and extracts. In addition, many studies on adverse reactions do not indicate the species or preparation method used, complicating the situation. While *Eucalyptus spp.* can cause adverse reactions, the U.S. Food and Drug Administration has approved the use of eucalyptus oil and 1,8-cineole (eucalyptol) for human food use. The Council of Europe also has approved the use of the oil as a human food additive (at a level of 15 ppm). In France, infusions of *E. globulus* leaves can be registered as products for the treatment human benign bronchial disorders without toxicological studies. However, some toxicological studies are required for the registration of powdered leaf formulas.

While not related to the use of *Eucalyptus* in treatments, I find it interesting that growing certain species of *Eucalyptus* can cause its own problems. In Australia sawfly larvae, which contain poisonous polypeptides, often gather in mounds beneath *E. melanophloia*. When cattle consume

the larvae, they become uncoordinated, tremble, and can suffer permanent liver damage.

[Return to Index](#)

Uses and Efficacy

As with toxicity, the efficacy of eucalyptus oils and extracts is most likely dependent on their chemical composition. In general, oils from *Eucalyptus spp.* have antimicrobial properties. Two studies which tested the oils from several species showed that *E. citriodora* had the most antimicrobial activity. There was no relationship between 1,8-cineole content and antimicrobial activity. Other studies have demonstrated that the oil and leaf extracts of *Eucalyptus spp.* have antifungal and repellent activity.

The applications that are probably of most interest to livestock producers are as a mastitis preventative and treatment, as a treatment for endometritis, and as an anthelmintic (dewormer). An herbal gel called AV/AMP/14 (produced by Dabur Ayurved Ltd. and contains *Cedrus deodara*, *Curcuma longa*, *Glycyrrhiza glabra*, and *Eucalyptus globulus*) was used to treat and prevent subclinical mastitis in crossbred cows. Twice daily topical applications to the udder significantly reduced somatic cell counts (Pavneesh et al. 1996 and Joshi et al. 1996).

In a study on bovine endometritis, cows with endometritis were given, via an intrauterine infusion, 100 mls of a 10% solution of a tincture (alcohol and water mixtures) of *Eucalyptus globulus*. The eucalyptus tincture was compared to tinctures of *Allium sativum* (garlic, believed to have antimicrobial activity) and *Gnaphalium conoideum* (a plant that has no antimicrobial properties). The parameters measured in the study included the number of infusions given (which were repeated every 48 h until there was a change in the endometritis) and the days to first visible oestrus, days open, and number of services before conception. All of these time periods are believed to be longer when there are infections in the reproductive tract. The eucalyptus and garlic tinctures significantly reduced the days to first visible oestrus and the days open, although fewer garlic treatments were needed. There were no significant differences between the three treatments in the number of services required for conception. The study did not include any approved, commercially available treatments for endometritis (Esparza-Borges and Ortiz-Marquez 1996).

Fresh leaves, leaf-extracts, and growth regulators and their intermediaries (which are endoperoxides) of *Eucalyptus grandis* were tested for their anthelmintic properties by Bennet-Jenkins and Bryant (1996). Leaves were fed to 5 goats with experimental infections of *Haemonchus contortus* (the barberpole worm) (and natural infections of *Ostertagia*) for seven days (two days with lucerne/oaten chaff and five days as the sole source of feed). At necropsy, the number of adult *H. contortus* in the *E. grandis*-fed goats was 91% lower than the number in 4 control goats. There was no significant difference in the number of *Ostertagia*. Isolated *E. grandis* compounds (and synthetic congeners) were effective *in vitro* and *in vivo* (in mice and sheep) -- but practical formulation and administration methods for these compounds have not been identified.

Another application that may be of interest to livestock producers is as a treatment for ectoparasites and non-specific skin infections. Two experimental herbal mixtures (AV/EPP/14 and AV/AAGD/14 produced by Dabur Ayurved Limited in India), which contain *Eucalyptus globulus* oil along with several other plant oils, have been tested on dogs to treat ectoparasites, fungal skin infections, and non-specific skin infections. While the mixtures appear to be effective, no

comparative treatments were used in the studies. Also, it is unknown which plant oils in the mixtures contain the most active ingredients -- that is, the eucalyptus oil may not have been the effective ingredient in the herbal mixture (Agrawal 1997 and Bhilegaonkar and Maske 1997).

Many *in vitro* and a few *in vivo* tests have been conducted with extracts and oils of different *Eucalyptus* species. Following is a summary of some of the specific activities identified for *Eucalyptus* spp.:

- Eucalyptus oil (species not specified)
 - antibacterial -- concentrations ranging from 0.16 to >20 microliters/ml inhibited 22 bacterial strains *in vitro*.
 - antifungal -- concentrations ranging from 0.25 to 10 microliters/ml inhibited 11 fungi *in vitro*.
 - repellent activity -- effective in repelling *Pediculus humanus* (human body louse), with citronellal being the active compound.
- Isolated compounds from *Eucalyptus* spp.
 - ursolic acid -- exhibited anticholestatic activity and protected against hepatotoxicity (induced by paracetamol and galactosamine) in rats.
 - euglobals -- were shown to have antitumor properties.
- *E. camaldulensis* -- ethanol extracts showed activity against bacteria and fungi.
- *E. globulus*
 - antimicrobial -- essential oil has limited activity against *Paenibacillus* larvae, the causal agent of American foulbrood disease and methanol extracts of leaves at concentrations of 10mg/ml or less inhibited *Staphylococcus aureus*, *Escherichia coli*, *Pseudomonas aeruginosa*, and *Candida albicans* *in vitro*.
 - antispasmodic -- water/alcohol extracts of leaves decreased smooth muscle contractions *in vitro*.
 - antifungal -- the oil is believed to have limited antifungal activity, although water extracts were not effective against the fungi *Epidermophyton floccosum*, *Microsporium canis*, and *Trichophyton mentagrophytes*.
- *E. macarthurii* and *E. riwagum* -- mixed results were obtained when the essential oils were tested for antibacterial and antifungal activity *in vitro*.
- *E. citriodora*
 - antiinflammatory -- alcohol extracts of the leaves given to mice at concentrations of 100, 300, and 1,000 mg/kg BW inhibited induced paw oedema in mice by 12, 22, and 49%, respectively.
 - antibacterial and antifungal activity -- essential oil inhibited *Bacillus megaterium*, *Staphylococcus aureus*, *Escherichia coli*, *Candida albicans*, *Aspergillus niger*, and *Zygorrhynchus* spp. *in vitro* and inhibited ringworm causing fungi.

Listed below are some uses of *E. globulus* in humans:

- Anodyne -- China
- Antimalaria -- Honduras

- Antiseptic -- China, Honduras, and Turkey
- Arthritis -- China
- Asthma
- Astringent -- Turkey
- Bronchitis -- Mexico and U.S.
- Burn -- China
- Cancer -- Australia (Aborigine), China, Spain, and U.S.
- Catarrh -- Mexico, Turkey, and U.S.
- Cold -- Honduras and Mexico
- Cough -- Honduras
- Deodorant -- Turkey
- Diabetes -- Mexico
- Diaphoretic
- Diphtheria
- Dysentery -- China
- Expectorant -- Honduras
- Fever -- China, Honduras, and Turkey
- Flu -- Mexico
- Gingivitis -- U.S.
- Hemostat -- Turkey
- Inflammation
- Inhalant
- Insect repellent -- Honduras and Venezuela
- Laryngitis -- Mexico
- Malaria -- Spain and Venezuela
- Miasma -- Venezuela
- Purgative
- Respiratory
- Skin diseases (ringworm) -- Guatemala
- Sores, wounds -- China
- Spasms -- Honduras and Turkey
- Stimulant -- Turkey
- Suppurative
- Throat
- Tuberculosis -- China
- Vermifuge

- Tumors (Breast)

[Return to Index](#)

References

Not all of the references in the list below were used in writing this web page. Some references could not be easily located and others were in non-romance languages. They are included here so that a more complete resource list is available for those interested in the subject area.

- Adhikari, S.R., R. Shakya, H.D. Shrestha, D.M. Shakya, and D. Shrivastava. 1992. Variation of essential oil and eucalyptol content of randomly selected *Eucalyptus camaldulensis* trees. *Banko Janakari*, 3 (4): 3-7.
- Agrawal, A.K. 1997. Therapeutic efficacy of a herbal gel for skin affections in dogs. *Indian Veterinary Journal*, 74 (5): 417-419.
- Alippi, A.M., J.A. Ringuet, E.L. Cerimele, M.S. Re, and C.P. Henning. 1996. Antimicrobial activity of some essential oils against *Paenibacillus* larvae, the causal agent of American foulbrood disease. *Journal of Herbs, Spices & Medicinal Plants*, 4 (2): 9-16.
- Alkofahi, A., R. Batshoun, W. Owais, and N. Najib. 1997. Biological activity of some Jordanian medicinal plant extracts. Part II. *Fitoterapia*, 68 (2): 163-168.
- Argilagos, G.B., B.V. Perez, M.M. Izada, O.R. Garcia, Y.L. Mas, and H.R. Torrens. 1993. Effect of an eucalyptus based drug (Eucabev) on enterotoxigenic *E. coli* F5 receptors. *Revista de Produccion Animal*, 7 (3): 135-136.
- Atta, A.H. and A. Alkofahi. 1998. Anti-nociceptive and anti-inflammatory effects of some Jordanian medicinal plant extracts. *Journal of Ethnopharmacology*, 60 (2): 117-124.
- Beckstrom-Sternberg, Stephen M., James A. Duke, and K.K. Wain. "The Ethnobotany Database." <http://probe.nalusda.gov:8300/cgi-bin/browse/ethnobotdb>. (ACEDB version 4.3 -data version July 1994).
- Beckstrom-Sternberg, Stephen M., and James A. Duke. "The Phytochemical Database." <http://probe.nalusda.gov:8300/cgi-bin/browse/phytochemdb>. (ACEDB version 4.3 - data version July 1994).
- Bennet-Jenkins, Eva and C. Bryant. 1996. Novel sources of anthelmintics. *International Journal for Parasitology*, 26 (8/9): 937-947.
- Bhilegaonkar, N.G. and D.K. Maske. 1997. Efficacy of a herbal compound AV/EPP/14 against ectoparasites of dogs. *Indian Veterinary Journal*, 74 (10): 869-870.
- Caceres, A., B.R. Lopez, M.A. Giron, and H. Logemann. 1991. Plants used in Guatemala for the treatment of dermatophytic infections. 1. Screening for antimycotic activity of 44 plant extracts. *Journal of Ethnopharmacology*, 31: 263-276.
- Chalchat, J.C., A. Muhayimana, J.B. Habimana, J.L. Chabard. 1997. Aromatic plants of Rwanda. II. Chemical composition of essential oils of ten *Eucalyptus* species growing in Ruhande Arboretum, Butare, Rwanda. *Journal of Essential Oil Research*, 9 (2): 159-165.
- Chalchat, J.C., J.L. Chabard, M.S. Gorunovic, V. Djermanovic, and V. Bulatovic. 1995. Chemical composition of *Eucalyptus globulus* oils from the Montenegro coast and east coast of Spain. *Journal of Essential Oil Research*, 7 (2): 147-152.

- Chanegriha, N., Cherif Y. Foudil, A. Baailouamer, and B.Y. Meklati. 1998. Antimicrobial activity of Algerian cyprus and eucalyptus essential oils. *Rivista Italiana EPPOS*, No. 25: 11-16.
- Cheeke, P.R. 1998. Natural Toxicants in Feeds, Forages, and Poisonous Plants, 2nd ed. Interstate Pubs., IL.
- Cheng, Q. and J.K. Snyder. 1988. Revised structures of robustadiols A and B from *Eucalyptus robusta*. *Journal of Organic Chemistry*, 53(19): 4562-4567.
- Darben, T., B. Cominos, and C.T. Lee. 1998. Topical eucalyptus oil poisoning. *Australasian Journal of Dermatology*, 39 (4): 265-267.
- Dellacassa, E., P. Menendez, P. Moyna, and P. Cerdeiras. 1989. Antimicrobial activity of Eucalyptus essential oils. *Fitoterapia*, 60 (6): 544-546.
- Esparza, Borges H. and Marquez A. Ortiz. 1996. Therapeutic efficacy of plant extracts in the treatment of bovine endometritis. *Acta Horticulturae*, No. 426: 39-46.
- Giron, L.M., G.A. Aguilar, A. Caceres, and G.L. Arroyo. 1988. Anticandidal activity of plants used for the treatment of vaginitis in Guatemala and clinical trial of a *Solanum nigrescens* preparation. *Journal of Ethnopharmacology*, 22 (3): 307-313.
- Gobel, H., G. Schmidt, M. Dworschak, H. Stolze, and D. Heuss. 1995. Essential plant oils and headache mechanisms. *Phytomedicine*, 2 (2): 93-102.
- Gobel, H., G. Schmidt, and D. Soyka. 1994. Effect of peppermint and eucalyptus oil preparations on neurophysiological and experimental algesimetric headache parameters. *Cephalalgia*, 14 (3): 228-234.
- Gundidza, M., F. Chinyanganya, and S. Mavi. 1993. Antimicrobial activity [against 12 bacteria and 7 fungi] of the essential oil from *Eucalyptus maidenii*. *Planta Medica*, 59 (7): A705.
- Hajji, F., Tetouani S. Fkih, and Elaraki A. Tantaoui. 1993. Antimicrobial activity of twenty-one Eucalyptus essential oils. *Fitoterapia*, 64 (1): 71-77.
- Hmamouchi, M., Elaraki A. Tantaoui, Safi N. Es, and A. Agoumi. 1990. Elucidation of the antibacterial and antifungal properties of the essential oils of Eucalyptus. *Plantes Medicinales et Phytotherapie*, 24 (4): 278-289.
- House, P., S. Lagos-Witte, and C. Torres. 1992. Manual Popular de 50 Plantas Medicinales de Honduras, 3rd Ed. Guaymuras, Honduras.
- Izzo, A.A., R. Capasso, F. Senatore, S. Seccia, and P. Morrica. 1996. Spasmolytic activity of medicinal plants used for the treatment of disorders involving smooth muscles. *Phytotherapy Research*, 10 (Supplement 1): S107-S108.
- Joshi, H.C., M. Kumar, M.J. Saxena, and M.B. Chhabra. 1996. Herbal gel for the control of subclinical mastitis. *Indian Journal of Dairy Science*, 49 (9): 631-634.
- Lee, InKyoung, BongSik Yun, JongPyung Kim, SungHyun Chung, GyuSeop Shim, and IckDong Yoo. 1998. Antioxidative compounds isolated from the stem bark of *Eucalyptus globulus*. *Korean Journal of Pharmacognosy*, 29 (3): 163-168.
- Lis, Balchin M., S.G. Deans, and E. Eaglesham. 1998. Relationship between bioactivity and chemical composition of commercial essential oils. *Flavour and Fragrance Journal*, 13 (2): 98-104.

- Lis, Balchin M., S. Deans, and S. Hart. 1996. Bioactivity of New Zealand medicinal plant essential oils. *Acta Horticulturae*, No. 426: 13-30.
- Manual Popular de Plantas Medicinales Comunes de la Costa Atlantica de Honduras. 1996. Programa Tramil-Centroamérica/ENDA CARIBE.
- Mizrahi, I., Traverso J. Rodriguez, M.A. Juarez, A.L. Bandoni, L. Muschietti, and C. van Baren. 1997. Composition of the essential oil of *Eucalyptus dunnii* Maiden growing in Argentina. *Journal of Essential Oil Research*, 9 (6): 715-717.
- Mumcuoglu, K.Y., R. Galun, U. Bach, J. Miller, and S. Magdassi. 1996. Repellency of essential oils and their components to their components to the human body louse, *Pediculus humanus humanus*. *Entomologia Experimentalis et Applicata*, 78 (3): 309-314.
- Murata, M., Y. Yamakoshi, S. Homma, K. Aida, K. Hori, and Y. Ohashi. 1990. Macrocarpal A, a novel antibacterial compound from *Eucalyptus macrocarpa*. *Agricultural and Biological Chemistry*, 54 (12): 3221-3226.
- Navarro, V., M.L. Villarreal, G. Rojas, and X. Lozoya. 1996. Antimicrobial evaluation of some plants used in Mexican traditional medicine for the treatment of infectious diseases. *Journal of Ethnopharmacology*, 53 (3): 143-147.
- Nikogosyan A.N., G.S. Grigoryan, A.G. Safaryan, S.K. Khachatryan, and I.G. Sokhikyan. 1988. The effect of medicinal plants on some blood indices of intact lambs. *Biologicheskii Zhurnal Armenii*, 41 (6): 525-528.
- Ou, M., N.S. Wang, Y.W. Li, X.Q. Chen, X.C. Liu, H.S. Lou, and C. Lu. 1992. Chinese-English manual of commonly-used [preparations] in traditional Chinese medicine.
- Pages, N., G. Fournier, F. Le Luyer, and M.C. Marques. 1990. Essential oils and their teratogenic potential: essential oil of *Eucalyptus globulus*. Preliminary study on mice. *Plantes Medicinales et Phytotherapie*, 24 (1): 21-26.
- Pattnaik, S., V.R. Subramanyam, and C. Kole. 1996. Antibacterial and antifungal activity of ten essential oils in vitro. *Microbios*, 86 (349): 237-246.
- Pavneesh, Madan, S.K. Pandey, M.B. Chhabra, and M.J. Saxena. 1996. Efficacy of a topical herbal gel for mastitis control. *International Journal of Animal Sciences*, 11 (2): 289-291.
- Shukla, B., P.K.S. Visen, G.K. Patnaik, S.C. Tripathi, R.C. Srimal, R. Dayal, and P.C. Dobhal. 1992. Hepatoprotective activity in the rat of ursolic acid isolated from eucalyptus hybrid. *Phytotherapy Research*, 6 (2): 74-79.
- Siddiqui, B.S., Farhat, Begum Sabira, and Siddiqui Salimuzzaman. 1997. Isolation and structural elucidation of acylated pentacyclic triterpenoids from the leaves of *Eucalyptus camaldulensis* var. *obtusa*. *Planta Medica*, 63 (1): 47-50.
- Takasaki, M., T. Konoshima, M. Kozuka, and H. Tokuda. 1995. Anti-tumor-promoting activities of euglobals from Eucalyptus plants. *Biological & Pharmaceutical Bulletin*, 18 (3): 435-438.
- Tandon, S.K., S. Chandra, S. Gupta, and Jawahar Lal. 1995. Pharmacological effects of alcoholic extract of *Eucalyptus citriodora* leaves. *Indian Veterinary Journal*, 72 (7): 762-764.
- Tibballs J. 1995. Clinical effects and management of eucalyptus oil ingestion in infants and young children. *Medical Journal of Australia*, 163 (4): 177-180.

- Whitman, B.W. and H. Ghazizadeh. 1994. Eucalyptus oil [from *Eucalyptus spp.* including *E. globulus*]: therapeutic and toxic aspects of pharmacology in humans and animals. *Journal of Paediatrics and Child Health*, 30 (2): 190-191.
 - XuanDung Nguyen and Nghia Thin Nguyen. 1992. Some important medicinal and aromatic plants from Vietnam. *Recent advances in medicinal, aromatic and spice crops (Volume 2)*. International conference held on 28-31 January 1989, at New Delhi, India: 299-308.
 - Yadav, P. and N.K. Dubey. 1994. Screening of some essential oils against ringworm fungi. *Indian Journal of Pharmaceutical Sciences*, 56 (6): 227-230.
-

This series of web pages was created by a graduate student at Cornell University. All comments and suggestions are welcome. If you would like to add to this medicinal plant database, please [e-mail](#) Webmaster.

WARNING These web pages are only meant to be informative. Neither Cornell University nor the author of this site endorse or recommend the use of these plants.

Return to: [Medicinal Plants Homepage](#)

[Poisonous Plants Homepage](#)

Home page: [Animal Science at Cornell University](#)

For problems or comments on this web page, contact the Animal Science [Webmaster](#)

Gelsemium sempervirens

Index

- [Introduction and Description](#)
- [Common Names](#)
- [Chemical Compounds](#)
- [Toxicity](#)
- [Uses and Efficacy](#)

Introduction and Description

Gelsemium sempervirens belongs to the family Loganiaceae. It grows in the piedmont and coastal areas of the southeastern U.S. It is an early flowering climbing vine. The flowers are yellow, funnel shaped, and have a strong odor. The roots and rhizome of yellow jessamine were historically used to treat migraine headaches and types of neuralgia.

Common Names

- Carolina Jessamine -- U.S.
- Gelber Jasmin -- Germany
- Jasmin sauvage -- France
- Sariyasemin
- Yellow Jessamine

[Return to Index](#)

Chemical Compounds

Gelsemium sempervirens contains ergot type alkaloids. Following is a list of some of the compounds in the root of the plant. Potential activities of some of the compounds are listed as well as the quantities of the compounds in parts per million. For further information regarding the compounds in the plant refer to [USDA Phytochemical and Ethnobotanical Databases](#).

- 9-Hydroxysemperoside
- Brasoside
- Emodin-monomethylether
- Fabiatin
- Gelsedine -- activity CNS depressant
- Gelsemicine -- CNS depressant, convulsant, hypotensive, and respirapalytic

- Gelsemide
- Gelsemide-7-glucoside
- Gelsemidine -- CNS depressant
- Gelsemine -- analgesic, CNS depressant, CNS stimulant, cardiodepressant, and hypotensive
- Gelseminine
- Gelsemiol
- Gelsemiol-1-glucoside
- Gelsemiol-3-glucoside
- Gelsevirine -- CNS depressant
- Ipuranol
- n-Pentatriacontane
- Scopoletin -- allelochemic, analgesic, antiasthmatic, antiedemic, antifeedant, antiinflammatory, antileukotrienogenic, antiseptic, antitumor, CNS stimulant, cancer preventive, hypoglycemic, hypotensive, myorelaxant, pesticide, phytoalexin, spasmolytic, and uterosedative
- Sempervirine
- Tannin -- antidiarrheic, antidysenteric, antimutagenic, antinephritic, antioxidant, antiradicular, antiviral, bactericide, cancer-preventive, hepatoprotective, pesticide, psychotropic, and viricide

[Return to Index](#)

Toxicity

All parts of *G. sempervirens* are toxic, including the flower and nectar. The primary toxic compounds are gelsemine and gelseminine, which act as motor nerve depressants. Symptoms of toxicity in humans include difficulty in use of voluntary muscles, muscle rigidity and weakness, dizziness, loss of speech, dry mouth, visual disturbances, trembling of extremities, profuse sweating, respiratory depression, and convulsions. In Germany, human therapeutic use of the rhizome is not permitted, because it is not believed that efficacy has been adequately documented and serious risks are known. In some Australian states, the use of *G. sempervirens* is restricted and subject to poison control. The therapeutic dose in humans and the toxic dose are very close. No data could be found regarding livestock toxicity. However, many ergot alkaloids are known to be toxic to livestock.

Uses and Efficacy

It has been claimed that *G. sempervirens* can be used to treat several types of ailments. However, there is little substantial proof. There are some testimonials regarding its effectiveness in treating various ailments in cats (e.g., fever with shivering, muscle weakness, and vertigo). The doses used were: 30cc BID for 2 days and 3 doses of 30cc 12 hrs apart.

Some Uses in Humans:

- Analgesic -- Mexico
- Anodyne -- Mexico, Turkey, and U.S.
- Asthma -- Mexico
- Cephalgia -- Mexico
- CNS-depressant -- U.S.
- Cough -- U.S.
- Dermatologic aid -- U.S.
- Depressant
- Dysmenorrhea -- Mexico
- Fever -- Turkey and U.S.
- Gonorrhoea -- Mexico
- Hypertension-- Mexico
- Malaria -- Mexico and Turkey
- Migraine
- Neuralgia -- Europe
- Parturition -- U.S.
- Pertussis -- Mexico
- Pleurisy -- U.S.
- Poison, homicide -- Mexico, Turkey, and U.S.
- Polio
- Rheumatism -- Mexico
- Sedative, nerves, hysteria -- Mexico and Turkey
- Shortwindedness -- U.S.
- Spasm -- Mexico and Turkey
- Stomach ache -- U.S.
- Tonic -- Turkey

[Return to Index](#)

References

- Beckstrom-Sternberg, Stephen M., James A. Duke, and K.K. Wain. "The Ethnobotany Database." <http://probe.nalusda.gov:8300/cgi-bin/browse/ethnobotdb>. (ACEDB version 4.3 -data version July 1994).
- Beckstrom-Sternberg, Stephen M., and James A. Duke. "The Phytochemical Database." <http://probe.nalusda.gov:8300/cgi-bin/browse/phytochemdb>. (ACEDB version 4.3 - data version July 1994).
- Blackwell, W.H. 1990. Poisonous and Medicinal Plants. Prentice Hall: Englewood Cliffs, NJ.

- Cheeke, P.R. 1998. Natural Toxicants in Feeds, Forages, and Poisonous Plants, 2nd ed. Interstate Pubs., IL.
- Demers, J. 1998. *Gelsemium sempervirens*. J Am Holistic Vet Med Assoc 16 (4): 21-22.
- Keeler, R.F., K.R. van Kamen, and L.F. James, eds. 1978. Effects of Poisonous Plants on Livestock. Academic Press: NY.
- De Smet, P.A.G.M., K. Keller, R. Hansel, and R.F. Chandler, eds. 1992. Adverse Effects of Herbal Drugs Part 1 and 2. Springer-Verlag, NY.

[Return to Index](#)

This series of web pages was created by a graduate student at Cornell University. All comments and suggestions are welcome. If you would like to add to this medicinal plant database, please [e-mail](#) Webmaster.

WARNING: These web pages are only meant to be informative. Neither Cornell University nor the author of this site endorse or recommend the use of these plants.

Return to: [Medicinal Plants Homepage](#)
[Poisonous Plants Homepage](#)

Home page: [Animal Science at Cornell University](#)

For problems or comments on this web page, contact the Animal Science [Webmaster](#)

Gliricidia sepium

Index

- [Introduction and Description](#)
- [Common Names](#)
- [Chemical Compounds](#)
- [Toxicity](#)
- [Uses and Efficacy](#)

Introduction and Description

Gliricidia sepium is a leguminous tree and belongs to the family Fabaceae. *Gliricidia*, which originated in Central America, is used in many tropical and sub-tropical countries as live fencing. That is, it is planted along the side of fields, and the trunks are used as fence posts. During the dry season, when much of the forage is gone, the tree limbs are cut and the foliage is offered to livestock.

Gliricidia trees are a medium size, with composite leaves. The flowers are reddish and on the end of branches without leaves. The fruit is a pod about 10-15 cm. Typically, it can be found growing in acid soils with low to medium fertility.

Common Names

Usually *Gliricidia sepium* is just called *gliricidia*. There are only a few local names for the tree.

- Cacao de nance, cacahnanance -- Honduras
- Kakawate -- Philippines
- Mata Raton
- Madre Cacao -- Guatemala
- Madriado -- Honduras

[Return to Index](#)

Chemical Compounds

There are many compounds in *Gliricidia sepium*. The ones most researched are the tannins. In one study, *Gliricidia* was found to contain 40.7g of condensed tannins/kg dry matter. Tannins bind to protein and can make plants with high levels have an astringent dry mouth taste. The exact quantity of tannins varies with the location of the tree. The active medicinal compounds may be the tannins or other compounds such as afrormosin, medicarpin, or some isoflavins. Most of the research with *gliricidia* and its compounds have focused on nutritive quality. However, some

studies have focused on the ability of the plant and/or roots to decrease soil nematode populations, and control insects or fungi.

Some of the Compounds in *Gliricidia sepium*(for a more complete list see [USDA Phytochemical and Ethnobotanical Databases:](#)

- Afrormosin (an isoflavan) -- reported to be an antitumor promoting agent
- Formononetin (an isoflavan)
- Gliricidin-6a -- wood
- Gliricidol-9A -- wood
- Medicarpin (a pterocarpan) -- reported to be antifungal
- 7,4'-dihydroxy-3'-Methoxyisoflavin
- 2'-O-Methylsepiol -- plant
- Tannin -- reported to have potential antidiarrheic, antidysenteric, antimutagenic, antinephritic, antioxidant, antiradicular, antiviral, bactericide, cancer-preventive, hepatoprotective, pesticide, psychotropic, and viricide activities
- 7,3',4'-Trihydroxyflavanone -- plant

[Return to Index](#)

Toxicity

No published studies could be found regarding the toxicity of using gliricidia to repel insects. However, many animals cannot tolerate the consumption of large quantities of gliricidia. The tannins bind proteins and decrease the nutritive value of the plant. Some animals, such as goats, can consume larger quantities of plants with tannins than other animals such as cattle and sheep. Goats, unlike cattle and sheep, have a salivary protein binding factor that binds to the tannins.

[Return to Index](#)

Uses and Efficacy

Gliricidia is used by farmers in some Latin American countries to repel insects. The leaves are ground up and combined with water. The animal is then bathed with the resulting paste. According to some of the farmers, if this is repeated every 7-14 days, the number of torsalo (tropical warble fly) infections is decreased. No published studies could be found to substantiate this claim. However, when interviewing farmers and checking goats in Honduras, I found that the goats who the farmers claimed to have bathed with gliricidia had only 2-3 torsalos, while others had 10 or more. Also, one study did indicate that the heartwood of gliricidia contains compounds that attract and are toxic to certain insects (e.g., southern army worm, cabbage looper, yellow woolly bear, and *Glyptotermes dilatatus*, a termite).

In the Philippines, gliricidia is washed and pounded to extract the juice from the leaves. It is then applied to the area affected by external parasites once to twice a day for one week. In Guatemala, the bark and leaves of gliricidia are used to treat human skin diseases.

Research has been conducted on both the antifungal and antimicrobial properties of gliricidia extracts. In a brine shrimp toxicity test, a general screening method indicative of cytotoxicity and pesticidal activity, the LC50 was 454ug.ml (CI 328-608). , medicarpin, one of the compounds in the leaves and heartwood of gliricidia, is supposed to be antifungal. In an antifungal study, gliricidia extracts inhibited the germination of *Drechslera oryzae* only 6%. However, in another study, 50ug of stem chloroform extracts inhibited the growth of *Cladosporium cucumerinum* and slightly inhibited the growth of *Candida albicans*. In contrast, in another study, the antimicrobial properties of extracts from the bark of gliricidia were tested. It was effective against bacteria causing dermatitis. However, it was not effective against enterobacteria or *Candida albicans*. The discrepancy in the effectiveness against *Candida albicans* could be because of the quantity of plant extract used or the types of extracts used. In another study, leaf extracts were found to be effective against the dermatophytes *Microsporum canis*, *Trichophyton mentagrophytes* var *algodonosa*, and *T. rubrum*. It was not effective against *Epidermophyton floccosum*, *M. gypseum* or *T. mentagrophytes* var *granulare*.

In another study, gliricidia was found to inhibit the growth of various strains of *Neisseria gonorrhoea* in *in vitro* tests. Tinctures made from the leaves were used for these tests.

Some Uses in Humans:

- Headache
- Briuse
- Burn -- Panama
- Cold, cough -- Curacao
- Debility
- Expectorant -- Curacao
- Fatigue
- Fever -- Panama
- Gangrene -- Guatemala
- Gonorrhoea -- Guatemala
- Insecticide
- Insect repellent -- Curacao, Guatemala, and Honduras
- Itch, skin, sores -- Curacao, Guatemala, Honduras, and Panama
- Poison (Humans and animals) -- Panama and Venezuela
- Rodenticide (rats) -- Guatemala, Honduras, Panama, El Salvador, Venezuela
- Shade tree (for other crops) -- Sri Lanka
- Sedative -- Curacao
- Tumor -- Guatemala
- Ulcer -- Guatemala

[Return to Index](#)

References

- Beckstrom-Sternberg, Stephen M., James A. Duke, and K.K. Wain. "The Ethnobotany Database." <http://probe.nalusda.gov:8300/cgi-bin/browse/ethnobotdb>. (ACEDB version 4.3 -data version July 1994).
- Beckstrom-Sternberg, Stephen M., and James A. Duke. "The Phytochemical Database." <http://probe.nalusda.gov:8300/cgi-bin/browse/phytochemdb>. (ACEDB version 4.3 - data version July 1994).
- Caceres, A., B.R. Lopez, M.A. Giron, and H. Logemann. 1991. Plants used in Guatemala for the treatment of dermatophytic infections. 1. Screening for antimycotic activity of 44 plant extracts. *J Ethnopharmacology* 31: 263-276.
- Caceres, A., H. Menendez, E. Mendez, E. Cohobon, B.E. Samayoa, E. Jauregui, E. Peralta, G. Carrillo. 1995. Antigonorrhoeal activity of plants used in Guatemala for the treatment of sexually transmitted diseases. *J Ethnopharmacology* 48: 85-88.
- Cheeke, P.R. 1998. Natural Toxicants in Feeds, Forages, and Poisonous Plants, 2nd ed. Interstate Pubs., IL.
- Ganesan, T. 1994. Antifungal properties of wild plants. *Adv Plant Sci* 7(1): 185-187.
- Herath, H.M.T., R.S. Dassanayake, A.M.A. Priyadarshani, S. De Silva, G.P. Wannigama, and J. Jamie. 1998. Isoflavonoids and a pterocarpan from *Gliricidia sepium*. *Phytochemistry* 47 (1): 117-119.
- House, P., S. Lagos-Witte, and C. Torres. 1992. Manual Popular de 50 Plantas Medicinales de Honduras, 3rd Ed. Guaymuras, Honduras.
- Jackson, F.S., T.N. Barry, C. Lascano, and B. Palmer. The extractable and bound condensed tannin content of leaves from tropical tree, shrub and forage legumes. *J Sci Food Agric* 71 (1): 103-110.
- Mshigeni, K.E., chief ed. 1991. Proceedings of an International Conference on Traditional Medicinal Plants. The United Republic of Tanzania, Ministry of Health. Dar Es Salaam University Press.
- Palacpac-alo, A.M. 1990. Save your animals! Try medicinal herbs. *PCARRD Monitor* 18 (2): 3, 8-9.
- Rahalison, L., M. Hamburger, K. Hostettmann, M. Monod, E. Frenk, M.P. Gupta, A.I. Santana, M.D. Correa A. and A.G. Gonzalez. 1993. Screening for antifungal activity of Panamanian plants. *Int J Pharmacog* 31 (1): 68-76.
- van Soest, P.J. 1994. Nutritional Ecology of the Ruminant 2nd ed. Cornell Univ. Press, Ithaca, NY.

[Return to Index](#)

This series of web pages was created by a graduate student at Cornell University. All comments and suggestions are welcome. If you would like to add to this medicinal plant database, please [e-mail](#) Webmaster.

WARNING: These web pages are only meant to be informative. Neither Cornell University nor

the author of this site endorse or recommend the use of these plants.

Return to: [Medicinal Plants Homepage](#)

[Poisonous Plants Homepage](#)

Home page: [Animal Science at Cornell University](#)

For problems or comments on this web page, contact the Animal Science [Webmaster](#)

Hyptis verticillata

Index

- [Introduction and Description](#)
- [Common Names](#)
- [Chemical Compounds](#)
- [Toxicity](#)
- [Uses and Efficacy](#)

Introduction and Description

Hyptis verticillata belongs to the family Lamiaceae and originated in Central America. It grows to a height of approximately 2 meters. The leaves are oval and the flowers are white.

[Return to Index](#)

Common Names

- Herbe Au Diable
- Herbe Bourrique
- Hierba Martina -- Mexico
- Malcasada Grande
- Maman-Houanne
- Mamanhouane
- Mastuerzo
- Quitadolor -- Honduras
- Wild mint
- Verbena -- Honduras and El Salvador

[Return to Index](#)

Chemical Compounds

Little research has been done on the compounds in *Hyptis verticillata*. Some research on the lignin composition has been done. Cadina-4,10(15)-diene-3-one is believed to be an active compound. (For more information regarding the compounds see [USDA Phytochemical and Ethnobotanical Databases](#).)

Some of the Compounds in *Hyptis verticillata*

- Cadina-4,10(15)-diene-3-one
- Dehydropodophyllotoxin -- cytotoxic
- 4'-Demethyldesoxypodophyllotoxin -- cytotoxic
- Epipodorhizol
- Hyptinin
- Maslinic acid
- 5'-Methoxydehydropodophyllotoxin -- cytotoxic
- Oleanolic acid
- B-Peltatin -- plant (antimiotic)
- Podorhizol
- Rosmarinic acid -- antibacterial
- Sideritoflavone -- antibacterial
- Ursolic acid

[Return to Index](#)

Toxicity

No published studies on the toxicity of *Hyptis verticillata* could be found. However, it is believed that lignans have phytoestrogen activity. Also, phenolic compounds formed after oxidative reactions of phenolic precursors such as rosmarinic acid can effect endocrine function.

Uses and Efficacy

Hyptis verticillata is used by some farmers in Honduras to treat infections after castration. No studies have been conducted to prove its efficacy regarding this use. However, some compounds have been shown to be antimiotic and inhibit *Candida albicans*. On TLC plates, rosmarinic acid at levels of 5ug, 7.5ug, and 5ug were found to inhibit *Bacillus subtilis*, *Micrococcus luteus*, and *Escherichia coli*, respectively. Effectiveness against these bacteria could explain the antiseptic properties of infusions prepared from the plant.

Research has been conducted on *Hyptis verticillata* acaricidal and insecticidal activities. Cadina-4,10(15)-diene-3-one, isolated from *Hyptis verticillata*, has been shown to have chemosterilant activity against the cattle tick and be toxic against the sweet potato pest *Ipomoea* spp. The compound did not kill adult ticks, but did decrease oviposition and egg hatching.

Other laboratory studies have shown that sideritoflavone is antiphlogistic, and several compounds in *Hyptis verticillata* are cytotoxic, antiviral, and antidiarrhoic. None of the compounds, however, have been tested in animals.

Some Uses in Humans:

- Aches (head, back, stomach) -- Dominican Republic, Honduras, Mexico, and El Salvador
- Colds -- Africa and the Caribbean

- Dyspepsia
- Itch
- Pectoral -- Haiti
- Rheumatism -- Mexico
- Sedative -- Haiti and El Salvador
- Skin infections -- Mexico and other Central American countries
- Spasm -- Dominican Republic
- Stings
- Tooth pain -- Honduras

[Return to Index](#)

References

- Beckstrom-Sternberg, Stephen M., James A. Duke, and K.K. Wain. "The Ethnobotany Database." <http://probe.nalusda.gov:8300/cgi-bin/browse/ethnobotdb>. (ACEDB version 4.3 -data version July 1994).
- Beckstrom-Sternberg, Stephen M., and James A. Duke. "The Phytochemical Database." <http://probe.nalusda.gov:8300/cgi-bin/browse/phytochemdb>. (ACEDB version 4.3 - data version July 1994).
- Cheeke, P.R. 1998. Natural Toxicants in Feeds, Forages, and Poisonous Plants, 2nd ed. Interstate Pubs., IL.
- House, P., S. Lagos-Witte, and C. Torres. 1992. Manual Popular de 50 Plantas Medicinales de Honduras, 3rd Ed. Guaymuras, Honduras.
- Kuhnt, M., A. Probstle, R. Bauer, and M. Heinrich. 1993. Biological and pharmacological investigations of *Hyptis verticillata*. *Planta Med* 59S: A665.
- Kuhnt, M., A. Probstle, H. Rimpler, R. Bauer, and M. Heinrich. 1995. Biological and pharmacological activities and further constituents of *Hyptis verticillata*. *Planta Med* 61: 227-232.
- Kuhnt, M., H. Rimpler, and M. Heinrich. 1994. Lignans and other compounds from the Mixe Indian medicinal plant *Hyptis verticillata*. *Phytochemistry* 36(2): 485-489.
- Novelo, M., J.G. Cruz, L. Hernandez, and R. Pereda-Miranda. 1993. Phytotoxic constituents from *Hyptis verticillata*. *J Natural Prod* 56(10): 1728-1736.
- Porter, R.B.R., P.B. Reese, L.A.D. Williams, and D.J. Williams. 1995. Acaricidal and insecticidal activities of cadina-4,10(15)-diene-3-one. *Phytochemistry* 40(3): 735-738.

This series of web pages was created by a graduate student at Cornell University. All comments and suggestions are welcome. If you would like to add to this medicinal plant database, please [e-mail](#) Webmaster.

WARNING: These web pages are only meant to be informative. Neither Cornell University nor the author of this site endorse or recommend the use of these plants.

Return to: [Medicinal Plants Homepage](#)

[Poisonous Plants Homepage](#)

Home page: [Animal Science at Cornell University](#)

For problems or comments on this web page, contact the Animal Science [Webmaster](#)

Ocimum basilicum, *O. americanum*, and *O. micranthum*

Index

- [Introduction and Description](#)
- [Common Names](#)
- [Chemical Compounds](#)
- [Toxicity](#)
- [Uses and Efficacy](#)

Introduction and Description

Ocimum basilicum (common basil), *O. americanum*, and *O. micranthum* are members of the family Lamiaceae. These plants, as well as oils from them, have received lots of attention for their potential medicinal properties. Of these plants, *O. basilicum* is the most widely used. It is used in cosmetics, liqueurs, medicines, and perfumes.

Most *Ocimum* spp. can be grown and found throughout the world. However, they are not native to all areas. For example, *O. micranthum* originated in Central America. It grows to a height of approximately 50cm. The leaves are oval and slightly toothed, and the flowers are white or purple. *O. basilicum* looks very similar, but grows a bit taller (50-80cm).

[Return to Index](#)

Common Names

- Albahaca -- (*O. micranthum* in Honduras and Salvador), (*O. basilicum* in Guatemala)
- Balanoi -- (*O. basilicum* in the Philippines)
- Chahchabram
- Chiu Ts'Eng T'A
- Dama-Kasseh -- *Ocimum* spp. in Ethiopia
- Feslegen
- Hung que -- (*O. basilicum* in Vietnam)
- I Tzu Ts'Ao
- Lo Le
- Mreas preou -- (*O. basilicum* in Cambodia)
- Msubasha -- (*O. Suave*) Tanzania
- Ofgahng -- *Ocimum* spp. in Ethiopia

- Raihan Al Malik, Raihana, and Rainan
- Saint Josephwort
- Selaseh, Selasih, Selaseh hitam, and Selaseh jantan
- Sweet basil -- U.S.
- Taibedle -- Ocimum spp. in Ethiopia

[Return to Index](#)

Chemical Compounds

There are many compounds in *Ocimum* spp. The dried leaves of *O. basilicum* contain 0.20-1% essential oil. The major compounds in the oil are linalool and methylchaviol. The exact amounts, however, vary considerably. For example, in some studies camphene has been found in *O. americanum* and not in *O. basilicum*. Conversely, cineole has been found in *O. basilicum* and not in *O. americanum*. Also, differences in the potassium to calcium ratio in the culture media can change the quantity of the major constituents in the essential oil.

Some of the Compounds in *Ocimum basilicum*(for a more complete list see [USDA Phytochemical and Ethnobotanical Databases.](#)):

- Caffeic acid -- Leaf 19,000 ppm
- 1,8-Cineole -- plant 776 ppm, essential oil 1.6-8%
- p-Coumaric acid -- Leaf 760 ppm
- p-Cymene -- plant 1-16 ppm, essential oil <0.1%
- Limonene -- plant 2-934 ppm, essential oil <1.0%
- Linalool -- plant 30-300 ppm, essential oil 1.1-65.4%
- Methylchaviol -- plant 238-8,780 ppm, essential oil 13.5-87.2%
- Methyl cinnamate -- plant 1-2,800 ppm, essential oil 0-11.2%
- Myrcene -- leaf 2-80 ppm, essential oil 0.1-2%
- alpha-Pinene -- plant 2-180 ppm, essential oil 0.2-0.4% (all essential oil compositions are based on relative abundance)
- B-Pinene -- plant 3-160 ppm, essential oil <1.0%
- Quercetin
- Rutin -- leaf
- Safrole -- plant 60-400 ppm
- alpha-Terpinene -- essential oil 0.03-0.2%
- Tryptophan -- leaf 2,210 ppm

[Return to Index](#)

Toxicity

There is little available literature on the toxicity of *Ocimum* spp. However, *O. basilicum*, the species that appears to be used the most medicinally and the one for which the most analysis has been done, contains several potentially dangerous compounds. Some of these compounds are: safrole, rutin, caffeic acid, tryptophan, and quercetin.

Acute bovine pulmonary emphysema (ABPE), a respiratory disease in cattle, is caused by absorbed metabolites of tryptophan. Usually, ABPE occurs in cattle over 2-3yrs of age that are suddenly moved onto lush pasture. Tryptophan is toxic at a dose of 0.25-0.35g/kg body weight (BW). Whether or not a dose of *Ocimum* spp. could cause ABPE is not known.

P-coumaric acid and caffeic acid (phenolic acids) can inhibit digestion of plant cell walls in ruminants, because of their antimicrobial activity. When these phenolic acids are metabolized by rumen microbes, benzoic acid, 3-phenyl-propionic acid (PPA), and cinnamic acid may be formed. When these compounds are detoxified, hippuric acid is formed. PPA can decrease metabolic efficiency. Detoxifying the compounds costs the animal nitrogen, which also can decrease productivity.

Quercetin (a flavanoid) may be a cocarcinogen in bracken fern (*Pteridium aquilinum*). It has been suggested that it may interact with Bovine papilloma virus type 4, leading to malignant epithelial papillomas in the upper alimentary tract. Adverse effects from quercetin in *Ocimum* spp., when used to treat animals, is not known.

Safrole, which was used to flavor sodas, was banned as a food additive in the U.S. It has been shown to cause cancer in rats. Oil of *Ocimum* also contains d-limonene, which has anticarcinogenic properties.

[Return to Index](#)

Uses and Efficacy

Both the essential oil, leaves, seeds, flowers, and roots of *Ocimum* spp. are used as medicines. The essential oil has been shown in vitro to have antibacterial activity against *Staphylococcus aureus*, *Salmonella enteritidis* and *Escherichia coli*, antiseptic activity against *Proteus vulgaris*, *Bacillus subtilis*, and *Salmonella paratyph*, and antifungal activity against *Candida albicans*, *Penicillium notatum*, and *Microsporeum gyseum*.

Oils from some *Ocimum* spp. have been shown to repel insects and have larvicidal activity against houseflies, blue bottle flies, and mosquitoes. The effective concentration of the oil to kill 90% of the larva ranged from 113-283 ppm. Camphor, d-limonene, myrcene, and thymol are some of the compounds in the oil that may provide the repellent properties. Eugenol and methylchavicol may be responsible for the larvicidal activity.

Little published information can be found about the use of oil from *Ocimum* and fresh plant materials in the treatment of animals. Therefore, efficacious doses are not known. However, *O. basilicum* has been used as an expectorant in animals. Also, *O. micranthum* has been combined with *Chenopodium ambrosioides* to treat stomach pain and colic in animals. It also has been used

as a paste to massage the udder of livestock.

Some Uses in Humans:

- Alcoholism -- India
- Aphrodisiac -- India, Philippines
- Bites (dog, bug, snake) -- China
- Circulation -- China
- Collapse, convulsion, and delirium -- India
- Croup -- Iraq
- Depression -- Greece
- Diarrhea -- Honduras, Iraq, Kurdistan, Philippines
- Diuretic -- Sudan, Turkey
- Ear ache, deafness -- India, Panama, Philippines, Salvador
- Fever -- Honduras, India, Mexico
- Fungicide -- Philippines
- Halitosis
- Headache -- Honduras, India, Panama, Salvador
- Infection, inflammation -- China, Philippines
- Kidney -- China, India, Turkey
- Labor, parturition -- China, India
- Medicine -- Samoa
- Regular menstrual flow -- Honduras, Philippines, Salvador
- Nerves -- Honduras, Salvador
- Repellent -- Tanzania
- Spasm -- China, Haiti, India, Spain, Turkey
- Stimulant -- Philippines, Sudan, Turkey
- Stomach (carminative, pain, cancer, diaphragm tumors, colic) -- Algeria, Cambodia, China, Europe,
- Haiti, Laos, Philippines, Salvador, Turkey, Venezuela, Vietnam
- Throat and toothache
- Wart -- Greece

[Return to Index](#)

- Beckstrom-Sternberg, Stephen M., James A. Duke, and K.K. Wain. "The Ethnobotany Database." <http://probe.nalusda.gov:8300/cgi-bin/browse/ethnobotdb>. (ACEDB version 4.3 -data version July 1994).
- Beckstrom-Sternberg, Stephen M., and James A. Duke. "The Phytochemical Database." <http://probe.nalusda.gov:8300/cgi-bin/browse/phytochemdb>. (ACEDB version 4.3 - data version July 1994).

- Characteristics of essential oil from basil (*Ocimum basilicum* L.) grown in Australia. J. Agric. Food Chem. 44: 877-881.
 - van Duong, Nguyen. 1993. Medicinal Plants of Vietnam, Cambodia, and Laos. Masada, Y. 1976. Analysis of Essential Oils by Gas Chromatography and Mass Spectrometry. John Wiley & Sons, Inc., NY.
 - de Mena Guarero, M.G. 1994. Obtencion y Aprovechamiento de Extractos Vegetales de la Flora Salvadoreña. Editorial Universitaria, Salvador.
 - McCorkle, C.M., E. Mathias, and T.W. Schillhorn van Veen, eds. 1996. Ethnoveterinary Research and Development. Intermediate Technology Pubs., London.
 - Takano, T. 1993. Effects of the ratios of K to Ca in the nutrient solution on the growth, nutrient uptake, essential oil content and composition of basil. Acta Hort. #331: 129-135.
-

This series of web pages was created by a graduate student at Cornell University. All comments and suggestions are welcome. If you would like to add to this medicinal plant database, please [e-mail](#) Webmaster.

WARNING: These web pages are only meant to be informative. Neither Cornell University nor the author of this site endorse or recommend the use of these plants.

Return to: [Medicinal Plants Homepage](#)
[Poisonous Plants Homepage](#)

Home page: [Animal Science at Cornell University](#)

For problems or comments on this web page, contact the Animal Science [Webmaster](#)

Rheum palmatum and *Rheum rhabarbarum*

Index

- [Introduction and Description](#)
- [Common Names](#)
- [Chemical Compounds](#)
- [Toxicity](#)
- [Uses and Efficacy](#)

Introduction and Description

Rheum palmatum is commonly known as Chinese rhubarb, and *Rheum rhabarbarum* (also known as *R. rhaponticum*) is commonly referred to as wild rhubarb in the U.S. Both plants belong to the family Polygonaceae. Rhubarb has very broad leaves and elongated, often reddish, petioles (leaf stalks).

The petioles of rhubarb are edible, though the leaf blades are very toxic. The roots and rhizomes of *R. palmatum* and the roots of *R. rhabarbarum* are used in medicinal treatments. *R. palmatum* is considered a stronger medicinal than *R. rhabarbarum*. The most common medicinal use of these plants is as a laxative in humans.

Common Names

R. palmatum

- Chinese rhubarb
- Da huang
- Rawend
- Rhubarb
- Rhabarber -- Germany
-

R. rhabarbarum

- Garden rhubarb
- Papaz ravendi
- Rapontik -- Germany
- Rhapontic -- France
- Wild rhubarb

[Return to Index](#)

Chemical Compounds

The roots of *Rheum* spp. contain anthranoid derivatives (approx. 3-4%). The predominant type of anthranoid derivatives are rhein, emodin, aloe-emodin, chrysophanol and physcion. *R.*

rhabarbarum, unlike *R. palmatum*, contains rhaponticin, which has estrogen-like actions. The detection of rhaponticin is used to determine if *R. palmatum* has been mixed with *R. rhabarbarum* in supposedly pure medicinal mixtures.

Following is a list of compounds in *R. palmatum* and *R. rhabarbarum*. The compounds are divided by plant and the parts of the plant. Potential activities of some of the compounds are listed as well as the quantities of the compounds in parts per million. Rhubarb roots contain several minerals, though only a few are listed below. For further information regarding the compounds in the plant refer to [USDA Phytochemical and Ethnobotanical Databases](#).

Rheum palmatum Root

- 3,5,4'-Trihydroxystilbene-4'-o-beta-d-glucopyranoside
- 4-(p-Hydroxyphenyl)-2-butanone-beta-d-glucoside
- Aloe-emodin -- antiherpetic, antileukemic, antiseptic, antitubercular, antitumor, antiviral, bactericide, cathartic, cytotoxic, genotoxic, pesticide, purgative, termitifuge, and viricide
- Chrysophanol -- 690-3,190, antiseptic, bactericide, candidicide, cathartic, hemostat, pesticide, and purgative
- Cinnamic acid -- anesthetic, antiinflammatory, bactericide, cancer-preventive, choleric, fungicide, herbicide, laxative, pesticide, and vermifuge
- d-Catechol
- Emodin -- antiaggregant, antifeedant, antiinflammatory, antimutagenic, antiseptic, antitumor (breast), antiulcer, antiviral, cathartic, cytotoxic, gonadotropic, immunosuppressive, pesticide, purgative, spasmolytic, styptic, vasoelaxant, viricide
- Gallic acid -- anticarcinomic, antifibrinolytic, antioxidant, antiseptic, antiviral, astringent, bacteristatic, cancer-preventive, carcinogenic, hemostat, nephrotoxic, pesticide, styptic, and xanthine-oxidase-inhibitor
- Hyperin -- antiinflammatory, antioxidant, antitussive, antiviral, capillarifortificant, capillarigenic, diuretic, hepatoprotective, hypotensive, pesticide, and viricide
- Physcion -- antiseptic, cathartic, pesticide, and purgative
- Physcion-8-o-beta-d-gentiobioside
- Physcion-diglucoside
- Quercitrin -- aldose-reductase-inhibitor, antiarrhythmnic, anticataract, antifeedant, antifu,antihemorrhagic, antiinflammatory, antiviral, CNS depressant, cancer preventive, cardiogenic, choleric, detoxicant, diuretic, dye, hepatogenic, hypotensive, paralytic, pesticide, spasmolytic, vasopressor, and viricide
- Rhein -- anticarcinomic, antiseptic, antitumor, antiviral, bactericide, candidicide, cathartic, cytotoxic, pesticide, proteinase-inhibitor, purgative, and viricide
- Rheinoides -- 12,900

- Rheosmin
- Sennoside-a -- 2,000-8,740, purgative
- Sennoside-b -- purgative
- Tannins -- 50,000-100,000, antidiarrheic, antidyenteric, antimutagenic, antinephritic, antioxidant, antiradicular, antiviral, bactericide, cancer-preventive, hepatoprotective, pesticide, psychotropic, and viricide
- Tetrarin

Rhizomes

- Iron -- 100-180
- Magnesium -- 1,980-2,560
- Manganese
- Potassium -- 6,330-21,600

Rheum rhabarbarum Root

- (+)-Catechin and (+)-Catechin-5-o-glucoside
- (-)-Epicatechin and (-)-Epicatechin-3-o-gallate
- 1,2,6-tri-o-Galloyl-glucose and 1,6-di-o-Galloyl-glucose
- 1-o-Galloyl-glycerol
- 2-o-Cinnamoylglucogallin
- 3,5,4'-Trihydroxystilbene-4'-o-(6''-o-galloyl)-glucoside
- 3,5,4'-Trihydroxystilbene-4'-o-glucoside
- 4-(p-Hydroxyphenyl)butanone-o-glucoside
- 6-Hydroxymusizin-8-o-glucoside
- 6-o-Galloyl-glucose
- Aloe-emodin-8-o-glucoside
- Anhydrorhapontigenin
- Emodin -- for activity refer to *R. palmatum* root
- Emodin-8-o-glucoside
- Emodin methyl ether
- Chrysarone
- Chrysarone methyl ether
- Chrysophanic acid
- Chrysophanin
- Chrysophanol -- for activity refer to *R. palmatum* root
- Chrysophanol-1-o-glucoside and chrysophanol-8-o-glucoside
- Chrysopontin, chrysorhapontin, and desoxyrhaponticin
- Ferulic acid

- Fallic acid -- for activity refer to *R. palmatum* root
- Gallic acid-3-o-(6'-o-galloyl)-glucoside and gallic acid-4-o-(6'-o-galloyl)-glucoside
- Glucochrysarone
- Glycogallin
- Isoemodin
- Isolindleyin
- Isorhapontigenin
- Lindleyin -- analgesic, antiarthritic, and antiinflammatory
- Methyl chrysophanic acid
- p-Coumaric-acid
- Physcion -- for activity refer to *R. palmatum* root
- Physcion-8-o-glucoside
- Procyanidin-b1,3'-o-gallate
- Rhapontic acid
- Rhaponticin -- estrogenic, 14,200
- Rhapontigenin
- Rhein -- for activity refer to *R. palmatum* root
- Rheinoides -- 12,900
- Sennoside-a and sennoside-b -- for activity refer to *R. palmatum* root
- Sinapic acid -- cancer preventive
- Torachryson-8-o-glucoside

Petiole

- alpha-Tocopherol -- 2-48
- Arsenic -- 0.01
- Cadmium
- Caffeic acid
- Calcium -- 600-18,462
- Fumaric acid
- Gallic acid -- 53
- Oxalic acid -- 4,400-13,360
- Protocatechuic-acid
- Quercetin-3-glucoside
- Quercetin-3-rhamnoside
- Quercetin-3-rutinoside
- Rubidium
- Sinapic acid

- Vanillic acid

Leaf

- alpha-Tocopherol -- 1,197-1,238
- Anthraquinone-glycosides
- Anthrones -- 10,000-15,000
- Calcium oxalate
- Cyanidin-3-glucoside
- Cyanidin-3-rutinoside
- Dihydroxyglutamic acid
- Isoquercitrin
- Oxalic acid -- 3,000-11,000
- Rutin -- 6,000

[Return to Index](#)

Toxicity

The leaf blades of *R. rhabarbarum* are very toxic. They contain high levels of oxalic acid which can interact with blood calcium. Precipitation of calcium oxalate in the renal tubules can lead to renal failure. Symptoms of oxalate poisoning in humans include: nausea, vomiting, abdominal pain, anuria, and hemorrhages. In ruminants, oxalic acid can be degraded by rumen bacteria. The tolerance of ruminants to oxalate can be increased by gradually increasing the amount of oxalate in the diet. In general, however, oxalate is considered toxic to ruminants.

The active compounds (those that provide the laxative effect) in these plants also can cause side effects. Chronic consumption of anthranoid derivatives can turn urine a yellow or red color. Chronic use may also cause liver damage. During normal (non-chronic) use, anthranoid derivative laxatives cause increased losses of body water and electrolytes. Potassium loss may be responsible for symptoms such as a decrease in muscle activity and cardiac arrhythmia.

Many anthranoid derivatives have been shown in *in vitro* tests to be mutagenic. Positive results of mutagenicity have been obtained with chrysophanol, aloe-emodin, emodin, and chrysarobin in *Salmonella*/microsome assays. Tests with rhein were negative. There is some indication that chronic use of anthranoid derivative laxatives could be carcinogenic.

[Return to Index](#)

Uses and Efficacy

While *Rheum* spp. have definite laxative properties when used to treat human ailments, no scientific studies could be found proving its effectiveness in the treatment of livestock. In livestock, it is used as a treatment for diarrhea, chronic constipation, gastritis, anemia, nervousness, and lack of appetite. According to one source, the dose for livestock should be very small (1-2 roots, finely sliced). Also, some medicinal plant sources for humans and livestock

recommend purchasing the powdered root versus trying to grow the plant and prepare the treatment at home.

Some Uses in Humans: *R. palmatum*

- Astringent -- China and U.S.
- Constipation -- China and U.S.
- Stomach (cancer) -- China and Japan
- Tonic -- China
- Tumor

R. rhabarbarum

- Laxative -- France and Turkey
- Astringent -- Turkey
- Depurative -- Turkey
- Stomachic -- Turkey
- Tonic -- Turkey

[Return to Index](#)

References

- de Bairacli Levy, Juliette. 1988. The Complete Herbal Handbook for Farm and Stable. Faber and Faber: Boston.
- Beckstrom-Sternberg, Stephen M., James A. Duke, and K.K. Wain. "The Ethnobotany Database." <http://probe.nalusda.gov:8300/cgi-bin/browse/ethnobotdb>. (ACEDB version 4.3 -data version July 1994).
- Beckstrom-Sternberg, Stephen M., and James A. Duke. "The Phytochemical Database." <http://probe.nalusda.gov:8300/cgi-bin/browse/phytochemdb>. (ACEDB version 4.3 - data version July 1994).
- Blackwell, W.H. 1990. Poisonous and Medicinal Plants. Prentice Hall: Englewood Cliffs, NJ.
- Cheeke, P.R. 1998. Natural Toxicants in Feeds, Forages, and Poisonous Plants, 2nd ed. Interstate Pubs., IL.
- De Smet, P.A.G.M., K. Keller, R. Hansel, and R.F. Chandler, eds. 1992. Adverse Effects of Herbal Drugs Part 1 and 2. Springer-Verlag, NY.

[Return to Index](#)

This series of web pages was created by a graduate student at Cornell University. All comments and suggestions are welcome. If you would like to add to this medicinal plant database, please [e-mail](#) Webmaster.

WARNING: These web pages are only meant to be informative. Neither Cornell University nor

the author of this site endorse or recommend the use of these plants.

Return to: [Medicinal Plants Homepage](#)

[Poisonous Plants Homepage](#)

Home page: [Animal Science at Cornell University](#)

For problems or comments on this web page, contact the Animal Science [Webmaster](#)

Symphytum officinale -- Comfrey

Index

- [Introduction and Description](#)
- [Common Names](#)
- [Chemical Compounds](#)
- [Toxicity](#)
- [Uses and Efficacy](#)

Introduction and Description

Symphytum officinale, more commonly known as comfrey, belongs to the family Boraginaceae. Comfrey is a common wild plant in parts of the U.S. and is cultivated in much of the world. It is a perennial herb with deep roots. Comfrey has large, rough, prickly leaves and pinkish or creamy bell-like flowers. When it is not flowering, it is often confused with foxglove (*Digitalis spp.*). Comfrey is commonly used to make tea. It also has been promoted in the past as a forage crop.

There seems to be a great deal of difference in opinion regarding the medicinal use of comfrey. In some sources used for this web page, the medicinal use of comfrey is highly criticized. In fact, it has been banned from sale in some countries such as Canada. However, in another source used for this web page, comfrey was promoted as a great medicinal plant and people were advised to ignore the findings of scientists.

[Return to Index](#)

Common Names

- Borraja
- Bourrache
- Buyuk Karakafesotu
- Comfrey
- Consoude
- Consuelda
- Hirehari-So
- Liane Chique

[Return to Index](#)

Chemical Compounds

Comfrey contains at least eight pyrrolizidine alkaloids (PA). The amount of PAs in roots ranges from 0.3-0.4%. The content in leaves usually is lower. (For more information regarding the compounds in comfrey refer to [USDA Phytochemical and Ethnobotanical Databases](#)).

Some of the compounds in Comfrey are:

- Acetyllycopsamine (PA) -- roots and leaves
- Allantoin -- leaf 13,000ppm, root 6,000-8,000 ppm
- Caffeic acid -- root
- Echimidine (PA) -- roots and leaves
- Heliosupine (PA) -- roots and leaves
- Intermedine (PA) -- roots and leaves
- Lasiocarpine (PA) -- roots and leaves
- Lycopsamine (PA) -- roots and leaves
- Mucilage -- roots
- Rosmarinic acid -- leaf 5,000 ppm
- Symphytine (PA) -- roots and leaves
- Tannic acids -- roots

[Return to Index](#)

Toxicity

There are several dangers associated with the use of comfrey. One of the biggest problems is that people accidentally collect foxglove instead of comfrey. Foxglove is deadly. Among other things, it can cause irregular heart beats and convulsions.

Another problem with comfrey is that it contains at least eight pyrrolizidine alkaloids (PA). While the level of PAs in fresh plant may not be very high, ready-to-use preparation often have high levels (e.g., 270-2900 mg/kg). PAs are hepatoxins and can cause irreversible liver damage. One of the problems is that the effects of the alkaloids can be cumulative. Therefore, damage to the liver may not be associated to the alkaloids in comfrey. Sometimes toxicity signs will not be present until an animal is stressed by something that requires greater liver function (e.g., lactation). Also, the leaves and roots of comfrey have been shown to be carcinogenic. PAs from comfrey given to rats caused mortality. Liver pathology was characteristic of PA toxicosis. When rats were fed dietary levels of 0.5% roots and 8% leaves, they formed hepatomas.

There are species differences in susceptibility to PAs. Horses and cattle are most commonly poisoned by PAs, while sheep are much more resistant. Goats are more susceptible than sheep, and pigs are more susceptible than cattle and horses. Common clinical signs from PA toxicity include: jaundiced skin (from impaired liver function); rough unkempt appearance; diarrhea; prolapsed rectum; edema of tissues of the digestive tract; dullness; photosensitization; and abnormal behaviour. Horses may have neurological signs such as "head pressing." Poisoned cattle may have

a bloated appearance. Further information on PAs and species differences is presented in Cheeke 1998.

[Return to Index](#)

Uses and Efficacy

Comfrey has been promoted and used as a medicinal plant for years. However, no published studies could be found to support the medicinal claims.

In the Philippines, the leaves are made into a decoction and used as a drench for swine to treat fevers. One half to one cup of the decoction is given to the swine 3 times a day for 2-3 days. It also is recommended as a treatment for dogs after hip dysplasia. The dose is one tablespoon of minced leaves or three comfrey tablets twice a day, five days a week until the problem is gone. Some other oral uses of comfrey in dogs include treating rickets, arthritis, and rheumatism. For livestock, it is recommended as a treatment for internal hemorrhaging, ulcers, arthritis, broken bones, and rheumatism. Preparation consists of boiling one pound of comfrey in 1.5 quarts of water for one hour. Ground-ivy and Spanish liquorice can be added. A half pint drench is given to the animal three times/day. Molasses is supposed to be added to the mixture when the treatment is for ulcers. The dose for treating broken bones in livestock is two handfuls of well bruised roots/day.

Comfrey leaves and roots also are used topically to treat wounds, arthritis, sprains, and broken bones. In these applications, allantoin is believed to be the effective compound. Absorption of PAs through the skin, based on tests with rats, is 20-50 times lower than when orally administered, thus decreasing the toxic risks.

Some Uses in Humans:

- Arthritis
- Astringent -- Europe and Turkey
- Bone injuries
- Cancer -- U.S.
- Circulation -- China
- Diarrhea -- Haiti
- Expectorant -- Turkey
- Hemostat-- Turkey
- Inflammation, sores and swelling-- China, Europe and Spain
- Pectoral -- Haiti
- Sedative -- Turkey
- Stimulant -- Turkey
- Wounds

[Return to Index](#)

References

- Bairacli Levy, Juliette de. 1991. The Complete Herbal Handbook for Farm and Stable, 4th ed. Faber and Faber, NY.
- Bairacli Levy, Juliette de. 1986. The Complete Herbal Handbook for the Dog and Cat. Arco Pub., Ltd., NY.
- Beckstrom-Sternberg, Stephen M., James A. Duke, and K.K. Wain. "The Ethnobotany Database." <http://probe.nalusda.gov:8300/cgi-bin/browse/ethnobotdb>. (ACEDB version 4.3 -data version July 1994).
- Beckstrom-Sternberg, Stephen M., and James A. Duke. "The Phytochemical Database." <http://probe.nalusda.gov:8300/cgi-bin/browse/phytochemdb>. (ACEDB version 4.3 - data version July 1994).
- Cheeke, P.R. 1998. Natural Toxicants in Feeds, Forages, and Poisonous Plants, 2nd ed. Interstate Pubs., IL.
- Mateo, C.D. 1992. Herbal medicine in livestock and poultry production. Proceedings 8th Congress of the Federation of Asian Veterinary Associations, 21-25 Nov. 1992, Manila, Philippines: 783-792.
- de Smet, P.A.G.M., K. Keller, R. Hansel, and R.F. Chandler, eds. 1992. Adverse Effects of Herbal Drugs Part 1. Springer-Verlag, NY.

This series of web pages was created by a graduate student at Cornell University. All comments and suggestions are welcome. If you would like to add to this medicinal plant database, please [e-mail](#) Webmaster.

WARNING: These web pages are only meant to be informative. Neither Cornell University nor the author of this site endorse or recommend the use of these plants.

Return to: [Medicinal Plants Homepage](#)
[Poisonous Plants Homepage](#)

Home page: [Animal Science at Cornell University](#)

For problems or comments on this web page, contact the Animal Science [Webmaster](#)

UCMP Glossary

**Browse the UCMP Glossary
alphabetically or by volume.**

The terms and in this glossary are important to practicing biologists and paleontologists in various fields. We have tried to make the exhibits easy to understand without the glossary, but using this glossary may make your visit more enjoyable.

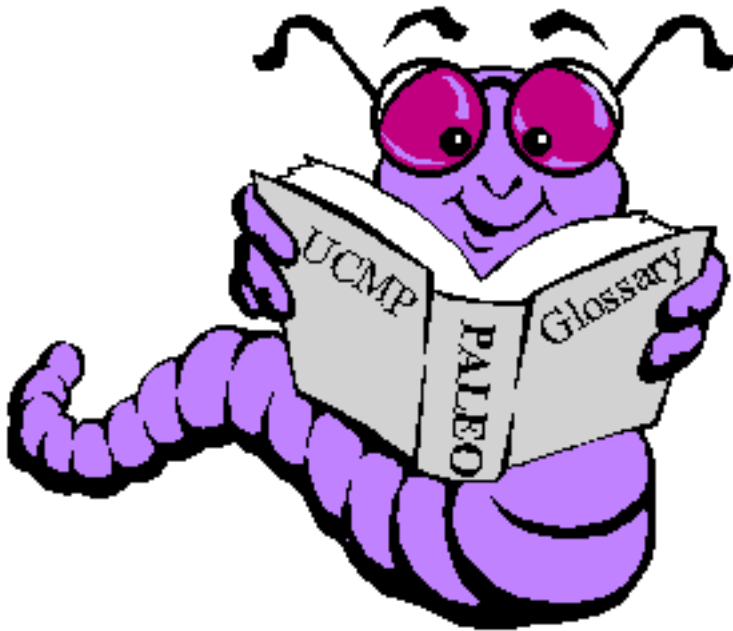

Browse Alphabetically:

[A](#) | [B](#) | [C](#) | [D](#) | [E](#) | [F](#) | [G](#) | [H](#) | [I](#) | [J](#) | [K](#) | [L](#) |
[M](#) | [N](#) | [O](#) | [P](#) | [Q](#) | [R](#) | [S](#) | [T](#) | [U](#) | [V](#) | [W](#) | [X](#) |
[Y](#) | [Z](#) |

Browse by Volume:

[Volume 1:
Phylogenetics](#)

[Volume 6: Life
History](#)

[Volume 2:
Geology](#)

[Volume 7:
Zoology](#)

[Volume 3:
Biochemistry](#)

[Volume 8:
Botany](#)

[Volume 4: Cell
Biology](#)

[Volume 9:
Paleogeography](#)

[Volume 5:
Ecology](#)

[authors](#)



[help](#)

UCMP Glossary: Phylogenetics



| [Phylogenetics](#) | [Geology](#) | [Biochemistry](#) | [Cell biology](#) |
[Ecology](#) | [Life history](#) | [Zoology](#) | [Botany](#) | [Paleogeography](#) |

adaptation -- Change in an organism resulting from natural selection; a structure which is the result of such selection.

anagenesis -- Evolutionary change along an unbranching lineage; change without speciation.

ancestor -- Any organism, population, or species from which some other organism, population, or species is descended by reproduction.

basal group -- The earliest diverging group within a clade; for instance, to hypothesize that [sponges](#) are basal [animals](#) is to suggest that the lineage(s) leading to sponges diverged from the lineage that gave rise to all other animals.

character -- Heritable trait possessed by an organism; characters are usually described in terms of their states, for example: "hair present" vs. "hair absent," where "hair" is the character, and "present" and "absent" are its states.

clade -- A monophyletic taxon; a group of organisms which includes the most recent common ancestor of all of its members and all of the descendants of that most recent common ancestor. From the Greek word "klados", meaning branch or twig.

cladogenesis -- The development of a new clade; the splitting of a single lineage into two distinct lineages; speciation.

cladogram -- A diagram, resulting from a cladistic analysis, which depicts a hypothetical branching sequence of lineages leading to the taxa under consideration. The points of branching within a cladogram are called nodes. All taxa occur at the endpoints of the cladogram.

convergence -- Similarities which have arisen independently in two or more organisms that are not closely related. Contrast with homology.

crown group -- All the taxa descended from a major cladogenesis event, recognized by possessing the clade's synapomorphy. See: stem group.

derived -- Describes a character state that is present in one or more subclades, but not all, of a clade under consideration. A derived character state is inferred to be a modified version of the primitive condition of that character, and to have arisen later in the evolution of the clade. For example, "presence of hair" is a primitive character state for all mammals, whereas the "hairlessness" of whales is a derived state for one subclade within the Mammalia.

diversity -- Term used to describe numbers of taxa, or variation in morphology.

endosymbiosis -- When one organism takes up permanent residence within another, such that the two become a single functional organism. Mitochondria and plastids are believed to have resulted from endosymbiosis.

evolution -- Darwin's definition: descent with modification. The term has been variously used and abused since Darwin to include everything from the origin of man to the origin of life.

evolutionary tree -- A diagram which depicts the hypothetical phylogeny of the taxa under consideration. The points at which lineages split represent ancestor taxa to the descendant taxa appearing at the terminal points of the cladogram.

extinction -- When all the members of a clade or taxon die, the group is said to be extinct.

gradualism -- A model of evolution that assumes slow, steady rates of change. Charles Darwin's original concept of evolution by natural selection assumed gradualism. Contrast with punctuated equilibrium.

hierarchy -- A series in which each element is categorized into successive ranks or grades with each level subordinate to the one above.

homology -- Two structures are considered homologous when they are inherited from a common ancestor which possessed the structure. This may be difficult to determine when the structure has been modified through descent.

hypothesis -- A concept or idea that can be falsified by various scientific methods.

ingroup -- In a cladistic analysis, the set of taxa which are hypothesized to be more closely related to each other than any are to the outgroup.

lineage -- Any continuous line of descent; any series of organisms connected by reproduction by parent of offspring.

monophyletic -- Term applied to a group of organisms which includes the most recent common ancestor of all of its members and all of the descendants of that most recent common ancestor. A monophyletic group is called a clade. [More?](#)

outgroup -- In a cladistic analysis, any taxon used to help resolve the polarity of characters, and which is hypothesized to be less closely related to each of the taxa under consideration than any are to each other.

paraphyletic -- Term applied to a group of organisms which includes the most recent common ancestor of all of its members, but not all of the descendants of that most recent common ancestor. [More?](#)

parsimony -- Refers to a rule used to choose among possible cladograms, which states that the cladogram implying the least number of changes in character states is the best.

phylogenetics -- Field of biology that deals with the relationships between organisms. It includes the discovery of these relationships, and the study of the causes behind this pattern. [More?](#)

phylogeny -- The evolutionary relationships among organisms; the patterns of lineage branching produced by the true evolutionary history of the organisms being considered.

plesiomorphy -- A primitive character state for the taxa under consideration.

polarity of characters -- The states of characters used in a cladistic analysis, either original or derived. Original characters are those acquired by an ancestor deeper in the phylogeny than the most recent common ancestor of the taxa under consideration. Derived characters are those acquired by the most recent common ancestor of the taxa under consideration.

polyphyletic -- Term applied to a group of organisms which does not include the most recent common ancestor of those organisms; the ancestor does not possess the character shared by members of the group. [More?](#)

primitive -- Describes a character state that is present in the common ancestor of a clade. A primitive character state is inferred to be the original condition of that character within the clade under consideration. For example, "presence of hair" is a primitive character state for all mammals, whereas the "hairlessness" of whales is a derived state for one subclade within the Mammalia.

pseudoextinction -- The apparent disappearance of a taxon. In cases of pseudoextinction, this disappearance is not due to the death of all members, but the evolution of novel features in one or more lineages, so that the new clades are not recognized as belonging to the paraphyletic ancestral group, whose members have ceased to exist. The Dinosauria, if defined so as to exclude the birds, is an example of a group that has undergone pseudoextinction.

punctuated equilibrium -- A model of evolution in which change occurs in relatively rapid bursts, followed by longer periods of stasis.

radiation -- Event of rapid cladogenesis, believed to occur under conditions where a new feature permits a lineage to move into a new niche or new habitat, and is then called an adaptive radiation.

rank -- In traditional taxonomy, taxa are ranked according to their level of inclusiveness. Thus a **genus** contains one or more **species**, a **family** includes one or more genera, and so on.

relatedness -- Two clades are more closely related when they share a more recent common ancestor between them than they do with any other clade.

reticulation -- Joining of separate lineages on a phylogenetic tree, generally through hybridization or through lateral gene transfer. Fairly common in certain land plant clades; reticulation is thought to be rare among metazoans.

selection -- Process which favors one feature of organisms in a population over another feature found in the population. This occurs through differential reproduction—those with the favored feature produce more offspring than those with the other feature, such that they become a greater percentage of the population in the next generation.

sister group -- The two clades resulting from the splitting of a single lineage.

stasis -- A period of little or no discernible change in a lineage.

stem group -- All the taxa in a clade preceding a major cladogenesis event. They are often difficult to recognize because they may not possess synapomorphies found in the crown group.

synapomorphy -- A character which is derived, and because it is shared by the taxa under consideration, is used to infer common ancestry.

systematics -- Field of biology that deals with the diversity of life. Systematics is usually divided into the two areas of [phylogenetics](#) and [taxonomy](#).

taxon -- n. Any named group of organisms, not necessarily a clade; a taxon may be designated by a Latin name or by a letter, number, or any other symbol; **taxa-** pl.

taxonomy -- The science of naming and classifying organisms.

vicariance -- Speciation which occurs as a result of the separation and subsequent isolation of portions of an original population.

Last updated:2004-04-20



UCMP Glossary: Geology



| [Phylogenetics](#) | **Geology** | [Biochemistry](#) | [Cell biology](#) |
[Ecology](#) | [Life history](#) | [Zoology](#) | [Botany](#) | [Paleogeography](#) |

abyssal plain -- The ocean floor offshore from the [continental margin](#), usually very flat with a slight slope.

accrete -- v. To add terranes (small land masses or pieces of crust) to another, usually larger, land mass.

alkaline -- Term pertaining to a highly basic, as opposed to acidic, substance. For example, hydroxide or carbonate of sodium or potassium.

allochthonous -- Refers to something formed elsewhere than its present location. Antonym of [autochthonous](#).

amber -- Fossilization where the organism is entrapped in resin and preserved whole.

andesite -- [Igneous volcanic](#) rock, less [mafic](#) than [basalt](#), but more mafic than [dacite](#); rough volcanic equivalent of [diorite](#).

anticline -- A fold of rock layers that is convex upwards. Antonym of [syncline](#).

archipelago -- n. A group of islands; an expanse of water with scattered islands.

asphalt -- A dark bituminous substance found in natural beds. Residue from petroleum distillation.

autochthonous -- Refers to something formed in its present location. Antonym of [allochthonous](#).

Banded Iron Formation -- n. Rock consisting of alternating light and dark layers of iron-rich chert (the dark layers have more iron minerals) formed from 3.8 to 1.7 billion years ago.

basalt -- Highly [mafic igneous volcanic](#) rock, typically fine-grained and dark in color; rough volcanic equivalent of [gabbro](#).

basement rock -- n. The oldest rocks in a given area; a complex of metamorphic and igneous rocks that underlies the sedimentary deposits. Usually Precambrian or Paleozoic in age.

basin -- n. Any large depression in which sediments are deposited.

Basin and Range Province -- n. One of the most extensive systems of fault-bounded mountains separated by sediment-filled valleys, extending across Idaho, Oregon, Nevada, Utah, Arizona, New Mexico, California, and northern Mexico.

bedrock -- n. The general term referring to the rock underlying other unconsolidated material, i.e. soil.

biostratigraphy -- n. The study of rock layers (e.g., distribution, environment of deposition, age) based on their fossils; **biostratigraphic**- adj.

biostratinomy -- The study of what happens between the death of an organism and burial. Part of [taphonomy](#).

bioturbation -- n. The disturbance of sediment by organisms, e.g. burrows, trails, or complete mixing.

blueschist -- [Metamorphic](#) rock formed under great pressures, but not so great temperatures.

calcareous -- adj. Term used to describe a structure, secreted by an organism, that consists of or contains calcium carbonate (CaCO_3), e.g., the shell of a bivalve.

caldera -- n. A large circular volcanic depression, often originating due to collapse.

carbon film -- Thin layer of carbon remains of past life found in [sedimentary rocks](#).

carbonate -- n. (adj.) A mineral composed mainly of calcium (Ca) and carbonate (CO₃) ions, may also include magnesium (Mg), iron (Fe) and others; n. rock or sediments derived from debris of organic materials composed mainly of calcium and carbonate (e.g., shells, corals, etc.) or from the inorganic precipitation of calcium (and other ions) and carbonate from solution (seawater). For example, [limestone](#) or [dolomite](#). **carbonate platform** – n. A broad (100s of meters), flat, shallow submarine expanse of carbonate rock, more common in the early-middle Paleozoic. **carbonate bank** – n. A narrow (10s of meters), fairly flat, shallow, submarine plateau of carbonate rock, more common from the middle-late Paleozoic to the present, e.g., the Bahama Banks.

casts -- Fossils formed when water containing minerals leaks into a mold. The minerals harden to form a copy of the original structure or organism.

chalk -- A soft compact calcite, CaCO₃, with varying amounts of silica, quartz, feldspar, or other mineral impurities, generally gray-white or yellow-white and derived chiefly from fossil seashells.

chert -- Hard, dense [sedimentary rock](#), composed of interlocking quartz crystals and possibly amorphous silica (opal). The origin of the silica is normally biological, from [diatoms](#), [radiolaria](#) or [sponge spicules](#). Synonymous with flint.

clast -- n. An individual grain or constituent of a rock; **clastic**- adj. Describes a rock or sediment composed mainly of fragments of preexisting rocks or minerals that have been transported some distance from their place of origin, e.g., sandstone, shale.

compactions -- Fossils that have undergone some degree of flattening of their three-dimensional structure.

compression -- [Fossil](#) formed when an organism is flattened (compressed) and a thin film of organic material from its body is left in the rock.

concretion -- n. A hard, rounded mass, commonly of silica, calcite, dolomite, iron oxide, pyrite, or gypsum, that formed within a rock from the precipitation of these minerals around a nucleus, such as a leaf, bone, shell, or fossil, and ranging in diameter from centimeters to meters.

conglomerate -- A coarse-grained [sedimentary rock](#), with **clasts** larger than 2 mm.

continental crust -- The Earth's [crust](#) that includes both the continents and the **continental shelves**.

continental margin -- n. The ocean floor from the shore of continents to the [abyssal plain](#).

continental rise -- n. Part of the **continental margin**; the ocean floor from the **continental slope** to the [abyssal plain](#). The continental rise generally has a gentle slope and smooth topography.

continental shelf -- n. The part of the continental margin from the coastal shore to the continental slope; usually extending to a depth of about 200 meters and with a very slight slope, roughly 0.1 degrees; includes continental and oceanic sediments down to the ocean floor.

continental slope -- n. Part of the **continental margin**; the ocean floor from the **continental shelf** to the **continental rise** or [oceanic trench](#). Usually to a depth of about 200 meters. The continental slope typically has a relatively steep grade, from 3 to 6 degrees.

copal -- Brittle aromatic yellow to red resins of recent or fossil origin, obtained from tropical trees.

coprolites -- Fossilized feces.

core -- That portion of the interior of the Earth that lies beneath the [mantle](#), and goes all of the way to the center. The Earth's core is very dense, rich in iron and the source of the magnetic field.

craton -- n. A part of the Earth's crust that has attained stability and has been little deformed for a long period of time, refers only to continents; **cratonic**- adj.

cross-bedding -- (n) The arrangement of sedimentary beds tilted at different angles to each other, indicating that the beds were deposited by flowing wind or water.

crust -- n. The outermost layer of the Earth, varying in thickness from about 10 kilometers (6 miles) below the oceans, to 65 kilometers (about 40 miles) below the continents; represents less than 1 percent of the Earth's volume.

dacite -- [Igneous volcanic](#) rock, less [mafic](#) than [andesite](#), typically fine-grained and light in color; rough volcanic equivalent of [granodiorite](#).

delta -- n. A low, nearly flat accumulation of sediment deposited at the mouth of a river or stream, commonly triangular or fan-shaped; **deltaic**– adj.

deposition -- Any accumulation of material, by mechanical settling from water or air, chemical precipitation, evaporation from solution, etc.

diagenesis -- All of the changes that occur to a fossil (or more generally any [sediment](#)) after initial burial; includes changes that result from chemical, physical as well as biological processes. The study of diagenesis is part of [taphonomy](#).

diatomite -- Diatomite, or diatomaceous earth, is a siliceous sedimentary rock formed from the accumulations of [diatoms](#) or other nanoplankton.

diorite -- [Igneous plutonic](#) rock, less [mafic](#) than [gabbro](#), but more mafic than [granite](#) and granodiorite; rough plutonic equivalent of [andesite](#).

dip -- The angle that a bedding plane or [fault](#) makes with the horizontal when measured perpendicular to the [strike](#) of the bedding plane or fault.

dolomite -- A [carbonate sedimentary rock](#) composed of more than 50 percent of the mineral calcium-magnesium carbonate ($\text{CaMg}(\text{CO}_3)_2$).

drill core -- n. A column of material (e.g., mud, ice, rock) removed from the earth by drilling. Often used as a tool for exploration of natural resources.

drumlin -- n. Elongated mound of glacial sediment deposited parallel to ice flow.

epicenter -- Point on the Earth's surface directly above the [focus](#) of an earthquake.

erosion -- n. The processes by which materials of the Earth's [crust](#) are worn away, loosened, or dissolved while being transported from their place of origin.

erratic -- n. A large, isolated boulder left behind by a glacier.

escarpment -- n. A steep or vertical cliff, either above or below sea level.

esker -- n. A ridge of glacial sediment deposited by a stream flowing in and under a melting glacier.

estuary -- n. An area where fresh water comes into contact with seawater, usually in a partly enclosed coastal body of water; a mix of fresh and salt water where the current of a stream meets the tides; **estuarine**– adj.

evaporite -- n. a deposit of salt minerals (e.g., halite, gypsum, anhydrite) left behind by the evaporation of seawater, usually forms within a restricted basin.

extrusive -- [Igneous](#). Antonym of [intrusive](#).

fault -- n. (v.) A fracture, or large crack, in the Earth's crust where one side moves up/down/sideways relative to the other; **fault block**- n. pieces of crust that have slipped into or alongside a fault; **fault zone**- n. an area with multiple faults.

felsic -- Term used to describe the amount of light-colored feldspar and silica minerals in an [igneous](#) rock. Complement of [mafic](#).

focus -- The initial point within the Earth that ruptures in an earthquake, directly below the [epicenter](#).

fold -- Bent rock [strata](#).

fossil -- Any evidence of past life, including remains, traces, imprints as well as life history artifacts. Examples of artifacts include fossilized bird's nests, bee hives, etc.

fossil record -- All of the fossils that have existed throughout life's history, whether they have been found or not.

fossiliferous -- adj. Rich in fossils.

freezing -- To preserve an organism without any significant alteration to its chemical composition by subjecting it to freezing temperatures.

gabbro -- Highly [mafic igneous plutonic](#) rock, typically dark in color; rough plutonic equivalent of [basalt](#).

Gastroliths -- Fossilized gizzard stones, usually only applicable in the fossil study of reptiles

geologic maps -- Maps that show the types and ages of rock of an area. These maps are used by paleontologists to find areas that are likely to contain fossils they are interested in.

glass -- A non-crystalline rock that results from very rapid cooling of magma.

granite -- Highly [felsic igneous plutonic](#) rock, typically light in color; rough plutonic equivalent of [rhyolite](#). Granite is actually quite rare in the U.S.; often the term is applied to any quartz-bearing plutonic rock.

granodiorite -- [Igneous plutonic](#) rock, less [felsic](#) than granite, typically light in color; rough plutonic equivalent of [dacite](#).

graywacke -- [Sandstone](#) composed of poorly sorted angular [clasts](#).

hydrothermal vent -- n. A place on the seafloor, generally associated with spreading centers, where warm to super-hot, mineral-rich water is released; may support a diverse community of organisms.

hypersaline -- adj. Extremely salty, having much more salt than normal seawater.

Ichnology -- The study of trace fossils.

igneous rock -- Any rock solidified from molten or partly molten material.

impressions -- Prints or marks made when an organism's body has been compressed (flattened). Impressions are different from compressions because no thin organic material is left behind.

interbedded -- adj. Describes beds (layers) of rock lying between or alternating with beds of a different kind of rock.

intrusion -- n. Magma (and the rock it forms) that has pushed into pre-existing rock; **intrusive**- adj.; [plutonic](#)- syn. [extrusive](#)- ant.

island arc -- n. A curved chain of islands that rise from the sea floor, usually near a continent. The convex side usually faces the open ocean, while the concave side usually faces the continent, e.g., the Aleutian Islands in Alaska; **volcanic arc**- syn.

isotope -- One of two or more variations of the same chemical element, differing in the number of neutrons not the number of protons.

kame -- n. A short, steep-sided knoll of glacial sediment.

karst -- n. A type of topography formed by dissolution of rocks like limestone and gypsum that is characterized by sinkholes, caves, and subterranean passages.

kettle lakes -- n. Lakes formed as water fills a hole formerly occupied by a block of stranded ice.

lava -- Any molten material that is [extrusive](#) or [volcanic](#), or the rock that forms from a molten extrusive.

limestone -- A [carbonate sedimentary rock](#) composed of more than 50 percent of the mineral calcium carbonate (CaCO₃).

limy -- adj. Describes sediments, soils, or rocks that contain a significant amount of lime (calcium oxide, CaO).

loess -- n. A widespread, loose deposit consisting mainly of silt; most loess deposits formed during the Pleistocene as an accumulation of wind-blown dust carried from deserts, alluvial plains, or glacial deposits.

lowland -- n. (adj.) Large area of relatively low relief, usually applied to coastal regions that do not rise high above sea level. *upland, highland* – ant.

mafic -- Term used to describe the amount of dark-colored iron and magnesium minerals in an [igneous](#) rock. Complement of [felsic](#).

magma -- n. Molten rock generated within the Earth; forms intrusive (solidifies below the surface) and extrusive (solidifies above the surface) igneous rocks.

mantle -- That portion of the interior of the Earth that lies between the [crust](#) and the [core](#).

marine terrace -- n. A platform of marine deposits (typically sand, silt, gravel) sloping gently seaward. Such a platform may be exposed along the coast, forming cliffs, due to uplift and/or the lowering of sea level, e.g., Marine terraces of coastal Southern California.

marl -- n. A loose, crumbly deposit consisting of clay and calcium carbonate and formed in marine or freshwater conditions.

melange -- A body of rocks consisting of large blocks (mappable size) of different rocks jumbled together with little continuity of contacts.

metamorphic rock -- Any rock derived from other rocks by chemical, mineralogical and structural changes resulting from pressure, temperature or shearing stress.

metamorphism -- n. The process of altering the chemical or mineralogical composition of a rock through different amounts of heat and pressure below the surface of the Earth; **metamorphose**- v.

microfossil -- n. A very small fossil, best studied with the aid of a microscope, e.g. foraminifera, radiolarians, and small vertebrate fossils such as teeth. *macrofossil*-ant.

mid-oceanic ridges -- Elongated rises on the ocean floor where [basalt](#) periodically erupts, forming new oceanic crust; similar to continental [rift zones](#).

mineralization -- The process of replacing any organism's original material with a mineral.

molds -- Fossils formed when the sediment surrounding a buried organism hardens. When the organism decays, its impression is left in the rock and can be seen if the rock is broken open.

moraine -- n. A mound or ridge of sediment deposited by a glacier; **lateral moraine**- n. deposited to the side of a glacier; **terminal moraine**- n. deposited to the front of a glacier; **ground moraine**- n. deposited on the land surface.

oceanic crust -- n. The Earth's [crust](#) which is formed at [mid-oceanic ridges](#), typically 5 to 10 kilometers thick with a density of 3.0 grams per centimeter cubed.

oceanic trench -- Deep steep-sided depression in the ocean floor caused by the [subduction](#) of [oceanic crust](#) beneath either other oceanic crust or [continental crust](#).

orogeny -- n. The tectonic processes of folding, faulting, and uplifting of the earth's crust that result in the formation of mountains.

outcrop -- Any place where [bedrock](#) is visible on the surface of the Earth.

paleosol -- Soil horizon from the geologic past.

peat -- n. A deposit of partly decayed plant remains in a very wet environment; marsh or swamp deposit of plant remains containing more than 50 percent carbon.

permineralization -- Fossilization process that occurs when minerals, carried by ground water, enter and harden in the pores of an organism's structures.

Phanerozoic -- n. The geologic eon that includes the interval of time from approximately 543 million years ago to the present, comprising the Paleozoic, Mesozoic, and Cenozoic eras.

pillow lava -- [Lava](#) extruded beneath water characterised by [pillow-type shapes](#).

plate -- n. Rigid parts of the Earth's [crust](#) and part of the Earth's upper [mantle](#) that move and adjoin each other along zones of seismic activity. The theory that the crust and part of the mantle are divided into plates that interact with each other causing seismic and tectonic activity is called **plate tectonics**.

pluton -- n. Any body of igneous rock that solidified below the earth's surface.

plutonic -- Applies to igneous rocks formed beneath the surface of the Earth; typically with large crystals due to the slowness of cooling. Synonym of [intrusive](#). Antonym of [volcanic](#).

radio-carbon dating -- Method for determining the age of an organic substance by measuring the amount of the carbon [isotope](#), carbon-14, remaining in the substance; useful for determining ages in the range of 500 to 70,000 years.

rebound -- v. To spring back after a weight has been removed.

red bed -- n. Sedimentary layers composed primarily of sandstone, siltstone, and shale, that are predominantly red in color due to the presence of iron oxides; often used in reference to the Permian or Triassic sediments of the western U.S.

reef -- n. A large ridge or mound-like structure within a body of water that is built by calcareous organisms such as corals, red algae, and bivalves; **barrier reef**- n. A reef growing offshore from a land mass and separated by a lagoon or estuary, e.g, the Great Barrier Reef of Australia; **patch reef**- n. A discontinuous reef growing in small areas, separated by bare areas of sand or debris, often part of a larger reef complex.

replacement -- Fossilization process that occurs when an organism is completely decomposed and replaced by mineral.

rhyolite -- Highly [felsic igneous volcanic](#) rock, typically light in color; rough volcanic equivalent of [granite](#).

rift -- n. A long, narrow crack in the entire thickness of the Earth's crust, which is bounded by normal [faults](#) on either side and forms as the crust is pulled apart; v. To split the Earth's crust; **rift zone**- n. The area on continents where a trough bounded by normal faults is forming; the site of crustal extension, similar to that which occurs at [mid-oceanic ridges](#); **rift basin** or **rift valley**- n. The long, and fairly wide trough that has formed as a section of the Earth's crust has dropped down along faults, e.g., African Rift Valley in East Africa.

rock cycle -- The process through which one type of rock (igneous, sedimentary, or metamorphic) is converted into another.

salt lick -- n. A natural or artificial deposit of exposed salt that animals lick for nutrients.

sandstone -- [Sedimentary rock](#) composed of sand-sized [clasts](#).

sea-floor spreading -- n. The process of adding to the Earth's crust at mid-ocean ridges as magma wells up and forces previously formed crust apart.

sediment -- Any solid material that has settled out of a state of suspension in liquid.

sedimentary rock -- Any rock resulting from the consolidation of [sediment](#).

siderite -- Also called ironstone, that is a concretion of iron carbonate. Common in the [Mazon Creek](#) fossil beds.

silicification -- Process whereby silica replaces the original material of a substance. For example, silicified wood.

sill -- n. A sheet-like igneous intrusion that parallels the plane of the surrounding rock.

sinkhole -- n. A natural depression in the surface of the land caused by the collapse of the roof of a cavern or subterranean passage, generally occurring in limestone regions.

soil -- Unconsolidated materials above [bedrock](#).

stratigraphy -- n. The study of rock layers, especially their distribution, environment of deposition, and age; **stratigraphic**, adj.

stratum -- A layer of [sedimentary rock](#); plural is **strata**.

strike -- The direction or trend of a bedding plane or [fault](#), as it intersects the horizontal.

subduction -- n. A geologic process in which one edge of one crustal [plate](#) is forced below the edge of another; **subduct**– v.; **subduction zone**- n. A long narrow area in which subduction is taking place, e.g. the Peru-Chile trench, where the Pacific Plate is being subducted under the South American Plate.

subsidence -- n. The sudden sinking or gradual downward settling of the Earth's surface with little or no horizontal motion.

syncline -- A fold of rock layers that is convex downwards. Antonym of [anticline](#).

taphonomy -- The study of what happens to a [fossil](#), from the time of its initial creation (e.g. the death of an organism or the imprint left by the movement of an organism) and the time that the fossil is discovered by a paleontologist. For example, shells or bones can be moved by running water, and later be [compressed](#) by overlying [sediment](#). Taphonomy is often broken into two parts, [biostratinomy](#) and the study of [diagenesis](#).

tectonic -- adj. Describing the forces that cause the movements and deformation of Earth's crust on a large scale, also describes the resulting structures or features from these forces.

terrane -- n. A general term used to refer to a piece of the crust that is usually smaller than a continent but larger than an island; **exotic terrane**- n. terrane that has an unknown origin or a different origin than its surrounding rocks.

topography -- n. The relief features of the Earth's surface, above and below sea level; the set of landforms in a region.

trace fossil -- Evidence left by organisms, such as burrows, imprints, coprolites, or footprints. Trace fossils are not preserved parts of the organism.

tuff -- n. A general term for consolidated rocks made of material ejected from volcanic explosions.

turbidite -- n. The sediments or rocks that formed as a result of a turbidity flow.

turbidity current -- n. A bottom fast-flowing current that moves down a slope, depositing suspended sediments over the floor of a body of water

turbidity flow -- n. A flow of dense, muddy water moving down a slope due to a turbidity current

unconformity -- Any interruption of the continuity of a [depositional](#) sequence.

undifferentiated -- adj. Unable to distinguish between. Undifferentiated rocks: rocks for which it is not possible to specify finer age divisions.

upland -- n. (adj.) An area that is higher relative to the surrounding areas, but not mountainous; **highland**– syn.; *lowland*– ant.

uplift -- n. (v.) The process or result of raising a portion of the Earth's crust through different tectonic mechanisms.

volcanic -- adj. Describes the action or process of magma and gases rising to the crust and being extruded onto the surface and into the atmosphere; also applies to the resulting igneous rocks that cool on the surface of the Earth, including beneath water, which typically have small crystals due to the rapidity of cooling.

volcanically - adv. **extrusive** - syn. [plutonic](#) - ant.

volcanism -- n. The process by which magma and associated gases rise to the Earth's crust and are extruded, or expelled, onto the surface and into the atmosphere.

weathering -- n. The physical, chemical, and biological processes by which rock is broken down into smaller pieces.

Last updated:2004-04-20



UCMP Glossary: Biochemistry



| [Phylogenetics](#) | [Geology](#) | **Biochemistry** | [Cell biology](#) |
[Ecology](#) | [Life history](#) | [Zoology](#) | [Botany](#) | [Paleogeography](#) |

alginate -- component of the cell walls of many [rhodophytes](#) and [kelps](#). Alginates have an affinity for water, and so help to slow dessication when the algae are exposed to the air; they are commercially important in the production of paper, toothpaste, beer, and frozen foods.

amino acid -- unit molecule from which proteins are constructed by polymerization.

ATP -- "adenosine triphosphate". A relatively stable, high energy molecule used to fuel chemical reactions within cells.

biochemistry -- the study of those molecules used and manufactured by living things.

bioluminescence -- the production of light by a chemical reaction within an organism. The process occurs in many bacteria and protists, as well as certain animals and fungi.

brevitoxin -- neurotoxin produced by the [dinoflagellate](#) *Ptychodiscus brevis*.

calcite -- A common crystalline form of natural calcium carbonate, CaCO_3 , that is the basic constituent of limestone, marble, and chalk. Also called calcspar.

calcium carbonate -- a "salt" used by many marine invertebrates, such as corals and [echinoderms](#), and by protists, such as [coccolithophorids](#), to construct their exoskeletons.

carbohydrates -- class of biochemical compounds which includes sugars, starch, chitin, and steroids.

cellulose -- carbohydrate polymer of the simple sugar glucose. It is found in the cell walls of [plants](#) and [green algae](#), as well as dinoflagellates. Cellulose is the most abundant compound on earth that is manufactured by living things.

chitin -- n. A carbohydrate polymer found in the cell walls of [fungi](#) and in the exoskeletons of [arthropods](#), which provides strength for support and protection; **chitinous**- adj.

chlorophyll -- n. The green-colored pigment that absorbs light during photosynthesis, often found in plants, algae, and some bacteria; it includes a porphyrin ring, and often has a long hydrophobic tail. [More info?](#)

collagen -- long proteins whose structure is wound into a triple helix. The resulting fibers have a high tensile strength. Collagen is a primary component of mammalian hair.

dinosteranes/dinosteroids -- chemicals found in [dinoflagellates](#), which have been useful in documenting their existence early in the fossil record.

DNA -- "deoxyribonucleic acid". The nucleic acid which carries the genetic code of an organism. It is the primary component of chromosomes. [MORE?](#)

enzyme -- complex protein which helps to speed biochemical reactions. Enzymes are important in the construction and degradation of other molecules.

flagellin -- protein which is the primary component of [prokaryotic](#) flagella.

fucoxanthin -- yellowish-brown pigment found in some members of the [Chromista](#), including kelps and diatoms.

glucose -- simple sugar, and the primary product of photosynthesis. It is polymerized to make cellulose and chitin.

glycoprotein -- a membrane-bound protein which has attached branching carbohydrates. These may function in cell-cell recognition, such as in human blood groups and immune system response, as well as in resisting compression of cells.

hemoglobin -- protein complex found in the blood of most [chordates](#) and the roots of certain legumes. It binds oxygen molecules, and in chordates serves as the means by which the oxygen is supplied to the cells of the body.

histones -- [proteins](#) attached to the DNA of eukaryotes which allows it to be packaged into chromosomes.

hydrophilic -- "water loving". Hydrophilic compounds dissolve easily in water, and are usually polar.

hydrophobic -- "water fearing". Hydrophobic compounds do not dissolve easily in water, and are usually non-polar. Oils and other long hydrocarbons are hydrophobic.

integrin -- adhesive protein of the extracellular matrix in [animals](#).

ion -- an atom or small molecule which carries a positive or negative charge.

laminarin -- a beta-glucan polysaccharide produced by many [chromists](#) through photosynthesis.

lipids -- a class of biochemical compounds which includes fats, oils, and waxes.

luciferase -- enzyme which activates luciferin to produce bioluminescence.

luciferin -- compound whose activated form emits light.

neurotoxin -- poison which interferes with nerve function, usually by affecting the flow of ions through the cell membrane.

nucleic acid -- class of biochemical compounds which includes DNA and RNA. They are among the largest molecules known. [MORE?](#)

nucleotide -- unit from which nucleic acids are constructed by polymerization. It contains a sugar, a phosphate group, and an organic base. ATP is a nucleotide.

peptidoglycan -- carbohydrate polymer cross-linked by proteins. It is found in the cell wall of Gram positive [bacteria](#), where it stains with the dye crystal-violet.

peridinin -- carotenoid pigment found in dinoflagellates.

phosphate -- an ion consisting of a phosphorus atom and four oxygen atoms. Among other things, it is used in the construction of nucleic acids.

photosynthesis -- biochemical process in which light energy is absorbed by chlorophyll, and is used to fuel the building of sugar molecules.

phycocyanin -- blue, water-soluble pigment found in the [cyanobacteria](#) and the [red algae](#).

phycoerythrin -- red, water-soluble pigment found in the cyanobacteria and red algae.

pigment -- any colorful compound, used by living things to absorb or block sunlight, and in sexual displays. [More info?](#)

polymer -- a large molecule constructed from many smaller identical units. These include proteins, nucleic acids, and starches.

protein -- class of biochemical compounds constructed from amino acids. Proteins may be structural, such as those that make up hair and cartilage, or they may be reactive, such as the enzymes.

proteinaceous -- describes any structure which is composed of protein.

proteoglycan --

rbcL -- a gene which is located in the chloroplast of photosynthetic organisms. It codes for the large subunit of the protein rubisco, and its sequence has been useful in plant phylogenies.

RNA -- "ribonucleic acid". The nucleic acid which carries the DNA message into parts of the cell where it is interpreted and used. The 18S ribosomal RNA sequence has been used in many groups of organisms to reconstruct phylogeny.

rubisco -- protein which fixes carbon in photosynthetic organisms. It binds molecules of carbon dioxide to a five-carbon molecule. Rubisco is the most common protein on earth.

saxitoxin -- neurotoxin found in a variety of dinoflagellates. If ingested, it may cause respiratory failure and cardiac arrest.

silica -- amorphous silicon dioxide (glass). It is a structural component in many organisms, such as [diatoms](#) and [horsetails](#).

spongin -- proteinaceous compound of which the spicules in [Demospongiae](#) are composed.

starch -- a complex polymer of glucose, used by plants and green algae to store surplus sugar for later use.

sugar -- any of several small carbohydrates, such as glucose, which are "sweet" to the taste.

Last updated:2004-04-20



UCMP Glossary: Cell **biology**



| [Phylogenetics](#) | [Geology](#) | [Biochemistry](#) | **Cell biology** |
[Ecology](#) | [Life history](#) | [Zoology](#) | [Botany](#) | [Paleogeography](#) |

amoeboid -- Having no definite shape to the cell, able to change shape.

amphiesma -- The outer covering of a [dinoflagellate](#), consisting of several membrane layers.

aperture -- Small opening, for example the opening in the test of a foram.

bacteriophage -- [Virus](#) which infects and destroys a bacterial host. Some phages, however, will incorporate their DNA into that of their host, and remain dormant for an extended period. For this reason, they have become essential tools of genetic engineers.

capsid -- The protein "shell" of a free virus particle.

cell -- Fundamental structural unit of all life. The cell consists primarily of an outer plasma membrane, which separates it from the environment; the genetic material (DNA), which encodes heritable information for the maintenance of life; and the cytoplasm, a heterogeneous assemblage of ions, molecules, and fluid.

cell cycle -- Complete sequence of steps which must be performed by a cell in order to replicate itself, as seen from [mitotic](#) event to mitotic event. Most of the cycle consists of a growth period in which the cell takes on mass and replicates its DNA. Arrest of the cell cycle is an important feature in the reproduction of many organisms, including humans.

cell membrane -- The outer membrane of a cell, which separates it from the environment. Also called a plasma membrane or plasmalemma.

cell wall -- Rigid structure deposited outside the cell membrane. [Plants](#) are known for their cell walls of [cellulose](#), as are the green algae and certain protists, while [fungi](#) have cell walls of [chitin](#).

chloroplast -- A chlorophyll-containing plastid found in algal and green plant cells.

chromosome -- Linear piece of eukaryotic DNA, often bound by specialized proteins known as histones.

coenocytic -- Condition in which an organism consists of filamentous cells with large central vacuoles, and whose nuclei are not partitioned into separate compartments. The result is a long tube containing many nuclei, with all the cytoplasm at the periphery.

colonial -- Condition in which many unicellular organisms live together in a somewhat coordinated group. Unlike true multicellular organisms, the individual cells retain their separate identities, and usually, their own membranes and cell walls.

contractile vacuole -- In many protists, a specialized vacuole with associated channels designed to collect excess water in the cell. Microtubules periodically contract to force this excess water out of the cell, regulating the cell's osmotic balance.

cytoplasm -- All the contents of a cell, including the plasma membrane, but not including the nucleus.

cytoskeleton -- Integrated system of molecules within eukaryotic cells which provides them with shape, internal spatial organization, motility, and may assist in communication with other cells and the environment. Red blood cells, for instance, would be spherical instead of flat if it were not for their cytoskeleton.

dikaryotic -- Having two different and distinct nuclei per cell; found in the [fungi](#). A dikaryotic individual is called a dikaryon.

diploid -- Having two different sets of chromosomes in the same nucleus of each cell. Most metazoans and plants are diploid. Compare with [haploid](#).

double membrane -- In mitochondria and plastids, there is a two-layered membrane which surrounds the organelle. This is believed to be the result of endosymbiosis, with the outer membrane coming from the eukaryotic cell, and the inner membrane belonging to the original prokaryote which was "swallowed".

endoplasmic reticulum -- (ER) network of membranes in eukaryotic cells which helps in control of protein synthesis and cellular organization.

eukaryote -- n. An organism whose cells have cytoskeletons for support and their DNA contained in a nucleus, separated from the other contents of the cell; e.g., protists, plants, animals, and fungi; **eukaryotic**- adj.

extracellular matrix -- (ECM) Region outside of [metazoan](#) cells which includes compounds attached to the plasma membrane, as well as dissolved substances attracted to the surface charge of the cells. The ECM functions both to keep animal cells adhered together, and well as buffering them from their environment.

eyespot -- Light-sensitive organelle found in many groups of protists, and in some metazoans.

filament -- Long chain of proteins, such as found in hair, muscle, or in flagella.

fission -- Division of single-celled organisms, especially prokaryotes, in which mitosis does not occur. Also used to refer to mitosis in certain unicellular fungi.

flagellum -- n. Hair-like structure attached to a cell, used for locomotion in many protists and prokaryotes. The prokaryotic flagellum differs from the eukaryotic flagellum in that the prokaryotic flagellum is a solid unit composed primarily of the protein flagellin, while the eukaryotic flagellum is composed of several protein strands bound by a membrane, and does not contain flagellin. The eukaryotic flagellum is sometimes referred to as an undulipodium.

frustule -- The mineral "skeleton" of a [diatom](#) or other unicellular organism.

Golgi apparatus -- Eukaryotic organelle which package cell products, such as enzymes and hormones, and coordinate their transport to the outside of the cell.

haploid -- Having a single set of chromosomes in the nucleus of each cell. Mosses, and many protists and fungi, are haploid, as are some insects, bryophytes, and the gametes of all organisms. Contrast with [diploid](#).

haptonema -- Peg-like structure unique to the [Prymnesiophyta](#); its function is not known.

lorica -- A vase-shaped or cup-shaped outer covering. Found in many protists, including some flagellates, ciliates, [chrysophytes](#), and [choanoflagellates](#), as well as in some animal cells.

lysosome -- Eukaryotic organelle which carries digestive enzymes. The lysosome fuses with a vacuolar membrane containing ingested particles, which are then acted upon by the enzymes.

mastigoneme -- Small hair-like filaments found on the "hairy" flagellum of the [Chromista](#).

membrane -- Semi-fluid structure which bounds all cells, and partitions the interior of eukaryotic cells. It consists primarily of two lipid layers, with proteins "dissolved" in the lipids.

mesokaryotic -- Nuclear condition unique to the [dinoflagellates](#) in which the chromosomes remain permanently condensed.

microtubules -- Type of filament in eukaryotic cells composed of units of the protein tubulin. Among other functions, it is the primary structural component of the eukaryotic flagellum.

microvilli -- Thin fingerlike protrusions from the surface of a cell, often used to increase absorptive capacity or to trap food particles. The "collar" of [choanoflagellates](#) is actually composed of closely spaced microvilli.

mitochondrion -- Complex organelle found in most eukaryotes; believed to be descended from free-living bacteria that established a symbiotic relationship with a primitive eukaryote. Mitochondria are the site of most of the energy production in most eukaryotes; they require oxygen to function. See: **double membrane**.

mitosis -- The process of nuclear division in eukaryotes. It is one step in cytokinesis, or cellular division. [MORE ?](#).

MTOC -- (microtubule organizing center) MTOCs are bundles of protein tubes which may be found at the base of a [eukaryotic](#) flagellum. In animals, they also function in creating the arrays of microtubules that pull the chromosomes apart during mitosis.

multicellular -- Any organism which is composed of many cells is termed multicellular.

nanometer -- n. A unit of measure; one millionth (10^{-9}) of a meter.

nuclear membrane -- The double membrane which surrounds the eukaryotic nucleus. It has many pores in its surface which regulate the flow of large compounds into and out of the nucleus.

nucleoid -- Region in prokaryotes where the DNA is concentrated. Unlike a nucleus, it is not bound by a membrane.

nucleus -- Membrane-bound organelle which contains the DNA in the form of chromosomes. It is the site of DNA replication, and the site of RNA synthesis.

organelle -- n. A membrane-bound structure in a eukaryotic cell that partitions the cell into regions which carry out different cellular functions, e.g., mitochondria, endoplasmic reticulum, lysosomes.

plasma membrane -- Outer membrane of a cell, sometimes called the cell membrane. The term plasma membrane is used more frequently when discussing prokaryotes.

plasmid -- Circular loop of DNA in prokaryotes. Eukaryotic DNA is organized into chromosomes.

plastid -- Any of several pigmented cytoplasmic organelles found in plant cells and other organisms, having various physiological functions, such as the synthesis and storage of food.

prokaryotic -- Literally "before the nucleus", the term applies to all [bacteria](#) and [archaea](#). Prokaryotic cells have no internal membranes or cytoskeleton. Their DNA is circular, not linear.

protoplasm -- All the contents of a cell, including the nucleus. (see: cytoplasm)

pseudopodia -- Fingerlike extensions from an amoeboid cell; literally "false feet".

repeat sequences -- The length of a nucleotide sequence that is repeated in a tandem cluster.

reticulopodia -- Long thread-like pseudopodia that branch apart and rejoin, forming a fine network. They are characteristic of [forams](#).

ribosome -- (ribosomal RNA)

syncytic -- see [Hexactinellida](#)

test -- n. A hard shell produced by some unicellular protists; may be made of calcium carbonate, silica, or sand grains.

theca -- General term for any stiff outer covering of a unicellular protist, and usually made up of interlocking plates. [dinoflagellates](#) and [diatoms](#) are examples of protists with thecae.

transduction -- [Viral](#) transfer of DNA to new host.

trichocyst -- Organelle in [ciliates](#) and [dinoflagellates](#) which releases long filamentous proteins when the cell is disturbed. Used as a defense against would-be predators.

ultrastructure -- The detailed structure of a specimen, such as a **cell**, **tissue**, or **organ**, that can be observed only by electron microscopy. Also called fine structure.

undulipodium -- Another term for a eukaryotic flagellum.

vacuole -- Membrane-bound fluid-filled space within a cell. In most plant cells, there is a single large vacuole filling most of the cell's volume. Some bacterial cells contain gas vacuoles.

Last updated:2004-04-20



UCMP Glossary: Ecology



| [Phylogenetics](#) | [Geology](#) | [Biochemistry](#) | [Cell biology](#) |
Ecology | [Life history](#) | [Zoology](#) | [Botany](#) | [Paleogeography](#) |

absorption -- The taking in of water and dissolved minerals and nutrients across cell membranes. Contrast with [ingestion](#).

aerobic -- Pertaining to the presence of free oxygen. Aerobic organisms require oxygen for their life processes.

anaerobic -- Pertaining to the absence of free oxygen. Anaerobic organisms do not require oxygen for their life processes, in fact oxygen is toxic to many of them. Most anaerobic organisms are [bacteria](#) or [archaeans](#).

autotroph -- Any organism that is able to manufacture its own food. Most [plants](#) are autotrophs, as are many [protists](#) and [bacteria](#). Contrast with [consumer](#). Autotrophs may be **photoautotrophic**, using light energy to manufacture food, or **chemoautotrophic**, using chemical energy.

benthic -- Organisms that live on the bottom of the ocean are called benthic organisms. They are not free-floating like pelagic organisms are.

biological/biotic factors -- Living factors such as decomposers, scavengers and predators.

biomes -- The world's major communities, classified according to the predominant vegetation and characterized by adaptations of organisms to that particular environment. [MORE?](#)

boreal -- adj. Describes the northern biotic area that is dominated by tundra, taiga, and coniferous forests.

canopy -- Layer of vegetation elevated above the ground, usually of tree branches and epiphytes. In tropical forests, the canopy may be more than 100 feet above the ground.

carnivore -- Literally, an organism that eats meat. Most carnivores are [animals](#), but a few fungi, plants, and protists are as well.

consumer -- Any organism which must consume other organisms (living or dead) to satisfy its energy needs. Contrast with [autotroph](#).

cyst -- n. A small, capsule-like sac that encloses an organism in its resting or larval stage, e.g., a resting spore of an alga.

decomposer -- An organism that breaks down the tissue and/or structures of dead organisms.

decomposition -- The breakdown of dead organic material by detritivores or saprophytes.

dessication -- Mummification.

detritus -- Accumulated organic debris from dead organisms, often an important source of nutrients in a food web.

detritivore -- Any organism which obtains most of its nutrients from the detritus in an ecosystem.

disease -- Organisms suffer from disease when their normal function is impaired by some genetic disorder, or more often from the activity of a parasite or other organism living within them. Many diseases are caused by [viruses](#), [bacteria](#), or [fungi](#).

ecosystem -- All the organisms in a particular region and the environment in which they live. The elements of an ecosystem interact with each other in some way, and so depend on each other either directly or indirectly.

environment -- The place in which an organism lives, and the circumstances under which it lives. Environment includes measures like moisture and temperature, as much as it refers to the actual physical place where an organism is found.

food chain/food web -- All the interactions of predator and prey, included along with the exchange of nutrients into and out of the soil. These interactions connect the various members of an ecosystem, and describe how energy passes from one organism to another.

frugivore -- Animal which primarily eats fruit. Many [bats](#) and [birds](#) are frugivores.

generalist -- Organism which can survive under a wide variety of conditions, and does not specialize to live under any particular set of circumstances.

grassland -- Region in which the climate is dry for long periods of the summer, and freezes in the winter. Grasslands are characterized by [grasses](#) and other erect herbs, usually without trees or shrubs. Grasslands occur in the dry temperate interiors of continents, and first appeared in the [Miocene](#).

Groundwater -- Water found underground as a result of rainfall, ice and snow melt, submerged rivers, lakes, and springs. This water often carries minerals. These minerals can accumulate in the remains of buried organisms and eventually cause fossilization.

habitat -- The place and conditions in which an organism lives.

halophile -- Organism which lives in areas of high salt concentration. These organisms must have special adaptations to permit them to survive under these conditions.

herbivore -- Literally, an organism that eats [plants](#) or other autotrophic organisms. The term is used primarily to describe animals.

host -- Organism which serves as the habitat for a parasite, or possibly for a symbiont. A host may provide nutrition to the parasite or symbiont, or simply a place in which to live.

ingestion -- The intake of water or food particles by "swallowing" them, taking them into the body cavity or into a vacuole. Contrast with [absorption](#).

inorganic -- Not containing carbon. Not from living things. Ex., minerals, water, oxygen, etc.

intertidal -- The coastal zone measuring from the lowest to the highest tide mark. The intertidal zone is subject to alternating periods of flooding and drying.

kelp forest -- Marine ecosystem dominated by large [kelps](#). These forests are restricted to cold and temperate waters, and are most common along the western coasts of continents. Kelp forests first appeared in the [Miocene](#).

limnology -- The study of river system ecology and life.

litter -- Leaf litter, or forest litter, is the detritus of fallen leaves and bark which accumulate in forests.

macroscopic -- Objects or organisms that are large enough to be seen with the naked eye.

marine -- Refers to the ocean.

microscopic -- Objects or organisms that are too small to be seen with the naked eye.

monsoonal -- adj. Describes a climate pattern with a wind system that changes direction with the seasons; this pattern is dominant over the Arabian Sea and Southeast Asia.

morphology -- n. The form and structure of anything, usually applied to the shapes, parts, and arrangement of features in living and fossil organisms.

niche -- n. The portion of the environment which a species occupies, defined in terms of the conditions under which an organism can survive, and may be affected by the presence of other competing organisms.

nitrogen fixation -- The conversion of gaseous nitrogen into a form usable by plants. Ususally by [bacteria](#).

nocturnal -- Active only at night.

nutrient -- Any element or simple compound necessary for the health and survival of an organism. This includes air and water, as well as food.

nutrient cycling -- All the processes by which nutrients are transferred from one organism to another. For instance, the carbon cycle includes uptake of carbon dioxide by plants, ingestion by animals, and respiration and decay of the animal.

omnivore -- Literally, an organism that will eat anything. Refers to animals who do not restrict their diet to just plants or other animals.

organic -- adj. Pertaining to compounds containing carbon. Also refers to living things or the materials made by living things. *inorganic*– ant.

parasite -- n. An organism that lives on or within a host (another organism); it obtains nutrients from the host without benefiting or killing (although it may damage) the host; **parasitic**- adj.; **parasitism**- n. a type of symbiotic relationship in which one organism benefits and the other does not.

pathogenic -- Organism which causes a disease within another organism.

pelagic -- Pelagic organisms swim through the ocean, and may rise to the surface, or sink to the bottom. They are not confined to live on the bottom as benthic organisms do.

periphyton -- Dense strands of algal growth that cover the water surface between the emergent aquatic plants. [Spirogyra](#) is commonly responsible for this growth.

photic zone -- Region of the ocean through which light penetrates; and the place where photosynthetic marine organisms live.

phytoplankton -- Tiny, free-floating, photosynthetic organisms in aquatic systems. They include [diatoms](#), [desmids](#), and [dinoflagellates](#).

plankton -- n. Very small, free-floating organisms of the ocean or other aquatic systems, including phytoplankton, which produce their own nutrients through photosynthesis, or zooplankton, which get their nutrients from organisms.

pollinator -- Animal which carries pollen from one [seed plant](#) to another, unwittingly aiding the plant in its reproduction. Common pollinators include [insects](#), especially bees, butterflies, and moths, [birds](#), and [bats](#).

predator -- Organism which hunts and eats other organisms. This includes both carnivores, which eat animals, and herbivores, which eat plants.

prey -- Organism hunted and eaten by a predator.

producer -- Any organism which brings energy into an ecosystem from inorganic sources. Most [plants](#) and many protists are producers.

rain shadow -- n. The dry region on the leeward side of a mountain range, where rainfall is noticeably less than on the windward side. For example, the White Mountains in east central California are in the rain shadow of the Sierra Nevada.

riparian -- Having to do with the edges of streams or rivers.

salinity -- A measure of the salt concentration of water. Higher salinity means more dissolved salts.

saprophyte -- Organism which feeds on dead and decaying organisms, allowing the nutrients to be recycled into the ecosystem. [Fungi](#) and [bacteria](#) are two groups with many important saprophytes.

scavenger -- An organism that feeds upon dead and dying organisms.

seaweed -- Any large photosynthetic [protist](#), including [rhodophytes](#) and [kelps](#). Seaweeds are not true [plants](#), but like plants they can make their own food. [More info?](#)

specialist -- Organism which has adopted a lifestyle specific to a particular set of conditions. Contrast with [generalist](#).

substrate -- "Supporting surface" on which an organism grows. The substrate may simply provide structural support, or may provide water and nutrients. A substrate may be inorganic, such as rock or soil, or it may be organic, such as wood.

symbiosis -- n. A relationship between two organisms that live in intimate contact with each other; includes mutualism (both organisms benefit, they rely on each other for survival), parasitism (one organism benefits at its host's expense) and commensalism (one partner benefits and the other is neither benefitted nor harmed); **symbiotic**- adj.

temperate -- Region in which the climate undergoes seasonal change in temperature and moisture. Temperate regions of the earth lie primarily between 30 and 60 degrees latitude in both hemispheres.

terrestrial -- Living on land, as opposed to marine or aquatic.

tropical -- Region in which the climate undergoes little seasonal change in either temperature or rainfall. Tropical regions of the earth lie primarily between 30 degrees north and south of the equator.

upwelling -- The raising of benthic nutrients to the surface waters. This occurs in regions where the flow of water brings currents of differing temperatures together, and increases productivity of the ecosystem.

zooplankton -- Tiny, free-floating organisms in aquatic systems. Unlike [phytoplankton](#), zooplankton cannot produce their own food, and so are consumers.

Last updated:2004-04-20



UCMP Glossary: Life history



| [Phylogenetics](#) | [Geology](#) | [Biochemistry](#) | [Cell biology](#) |
[Ecology](#) | **Life history** | [Zoology](#) | [Botany](#) | [Paleogeography](#) |

adult -- The mature stage of an organism, usually recognized by the organism's attaining the ability to reproduce.

asexual reproduction -- A type of reproduction involving only one parent that usually produces genetically identical offspring. Asexual reproduction occurs without **meiosis** or **syngamy**, and may happen through budding, by the division of a single cell, or the breakup of an entire organism into two or more parts.

clone -- An identical copy of an organism. Most plants, fungi, algae, and many other organisms naturally reproduce by making clones of themselves as a form of **asexual reproduction**.

development -- The process by which a multicellular organism is produced from a single cell.

diploid life cycle -- Occurs when the only multicellular stage in an organism's life cycle is [diploid](#).

dispersal -- The scattering of organisms of a species, often following a major reproductive event. Spores and larvae are commonly dispersed into the environment. Pollen or gametes may also be dispersed, but in this case the intent is to target another individual so that reproduction may occur. Organisms may disperse as spores, seeds, eggs, larvae, or adults.

dormancy -- A period of suspended growth and metabolic activity. Many plants, seeds, spores, and some invertebrates become dormant during unfavorable conditions.

egg -- (1) A large gamete without flagellae that is fertilized by a sperm cell. An egg cell is also called an ovum. (2) A complex multicellular structure in which an animal embryo develops.

embryo -- Once a **zygote** begins to undergo cellular divisions, it becomes an embryo.

female -- In organisms with separate sexes, the one which produces eggs.

fertilization -- The process by which an egg is made capable of generating offspring. It is often synonymous with [syngamy](#).

gamete -- Reproductive cells which fuse to form a **zygote**. Gametes are **haploid**, and may be differentiated into egg and sperm.

gametophyte -- The haploid stage in the life cycle of an organism undergoing alternations of generations. The gametophyte is multicellular and mitotically produces gametes. In plants, the gametophyte nourishes the zygote and young [sporophyte](#).

germination -- The process by which a seedling emerges and develops from a seed, or by which a sporeling emerges and develops from a spore.

haploid life cycle -- Occurs when the only multicellular stage in an organism's life cycle is [haploid](#).

haploid-diploid life cycle -- Occurs when a multicellular [diploid](#) phase, or **sporophyte**, alternates with a multicellular [haploid](#) phase, or **gametophyte**. Only [plants](#) and certain algae possess this kind of life cycle, which is also called "alternation of generations".

karyogamy -- A process of fusion of the nuclei of two cells; the second step in **syngamy**.

larva -- Among invertebrates, an immature stage in the life cycle which usually is much smaller than, and morphologically different from, the adult. In insects with **metamorphosis**, the larva must become a **pupa** before reaching adulthood.

male -- In organisms with separate sexes, the one which produces sperm.

meiosis -- A two-stage type of cell division in sexually reproducing organisms. In meiosis, a diploid cell divides to produce four haploid cells, each with half the original chromosome content. For this reason, meiosis is often called a "reduction division". In organisms with a diploid life cycles, the products of meiosis are usually called **gametes**. In organisms with an alternation of generations, the products of meiosis are called spores.

metamorphosis -- n. A process of developmental change whereby a larva reaches adulthood only after a drastic change in morphology; occurs in most amphibians and insects, for some insects, this change may include another stage (pupa) before the adult stage; **metamorphose**- v.

motile -- Able to move oneself about, capable of self-locomotion.

nymph -- In aquatic insects, the larval stage.

plasmogamy -- A process of fusion of the cytoplasm of two cells; the first step in **syngamy**.

pupa -- In metamorphosing insects, a stage between the **larva** and adult during which the organism undergoes major developmental changes.

reproduction -- The manufacture of offspring as part of an organism's life cycle. This is not the same as **dispersal**. Reproduction may be sexual, involving the fusion of gametes, or asexual.

sedentary -- Living in a fixed location, as with most plants, tunicates, sponges, etc. Contrast with [motile](#).

seed -- A structure produced by [seed plants](#) which encapsulates the embryo. The seed often provides nourishment during germination, but may lie dormant for many years first.

sexual reproduction -- A type of reproduction in which two parents give rise to offspring that have unique combinations of genes inherited through the gametes of the two parents. Sexual reproduction involves **meiosis** and **syngamy**.

spore -- n. A single cell that is dispersed as a reproductive unit, or that encapsulates a cell during unfavorable environmental conditions; in organisms with an alternation of generations; the products of meiosis are spores.

sporophyte -- The diploid stage in the life cycle of an organism undergoing an alternation of generations. The sporophyte is multicellular and develops from a zygote. The mature sporophyte meiotically produces haploid spores that later generate the [gametophyte](#) generation.

syngamy -- The process of union of two gametes; sometimes called fertilization. It encompasses both **plasmogamy** and **karyogamy**.

zygote -- The product of gamete fusion. In organisms with a haploid life cycle, the zygote immediately undergoes **meiosis**, but in organisms with a multicellular diploid stage, the zygote is merely the first stage in the diploid portion of the life cycle.

Last updated:2004-04-20



UCMP Glossary: Zoology



| [Phylogenetics](#) | [Geology](#) | [Biochemistry](#) | [Cell biology](#) |
[Ecology](#) | [Life history](#) | **Zoology** | [Botany](#) | [Paleogeography](#) |

abdomen -- Region of the body furthest from the mouth. In [insects](#), the third body region behind the head and thorax.

ambulacra -- Row of tube feet of an [echinoderm](#).

amniotic egg -- n. An egg that can be laid on land due to the presence of a fluid-filled amniotic sac (**amnion**) that cushions and protects the developing embryo; **amniote**- n. Any of a group of land-dwelling vertebrates that have an amnion during embryonic development, including reptiles, birds, and mammals.

anapsid -- n. A vertebrate distinguished by a skull with no openings in the side behind the eyes, e.g. turtles.

anus -- End of the digestive tract, or gut, through which waste products of digestion are excreted, as distinct from the mouth.

bipedal -- adj. Describes an animal that walks on two legs.

biramous -- [Arthropod](#) appendages that are biramous have two branches, an outer branch and an inner branch. These branches may have separate functions; in [crustaceans](#), for instance, the inner branch of a leg is used for walking, while the outer branch may be paddle-shaped or feathery and often functions as a gill. Contrast with **uniramous**.

blood -- Fluid which circulates throughout the body of an animal, distributing nutrients, and often oxygen as well.

book lung -- A set of soft overlapping flaps, covered up by a plate on the abdomen, through which oxygen is taken up and carbon dioxide given off. Characteristic of many terrestrial [arachnids](#) such as scorpions and spiders.

brain -- Collection of nerve cells usually located at the anterior end of an animal, when present at all. The nerves coordinate information gathered by sense organs, locomotion, and most internal body activities.

cephalon -- In [trilobites](#), the head shield bearing the eyes, antennae, and mouth.
[More info?](#)

chaetae -- Stiff bristles characteristic of [annelids](#).

chela -- The claw of an [arthropod](#).

chelicera -- The first pair of appendages of a **chelicerate** arthropod. Originally a short clawed appendage, the chelicerae of many arachnids are highly modified for feeding; in [spiders](#), for instance, they are modified into poisonous fangs.

chordate -- n. An animal with a notochord (a cartilaginous rod that extends the length of the body), dorsal hollow nerve cord (a fluid-filled tube that runs the length of the body), gill slits or pouches, and a tail at some stage in its life cycle.

clitellum -- In [annelids](#), a swelling of the body towards the head of the animal, where the gonads are located. Both oligochaetes and leeches have a clitellum.

cnidocyst -- The "stinging cell" of a [cnidarian](#).

coelom -- Fluid-filled cavity within the body of an animal; usually refers to a cavity lined with specialized tissue **peritoneum** in which the gut is suspended. The structure and development of the coelom is an important character for recognizing major groups of animals.

compound eye -- Found in many but not all [arthropods](#), a compound eye is composed of a large number of small, closely packed simple eyes (**ommatidia**), each with its own lens and nerve receptors.

cuticle -- 1) In animals, a multilayered, extracellular, external body covering, usually composed of fibrous molecules such as chitin or collagen, and sometimes strengthened by the deposition of minerals such as calcium carbonate. 2) A waxy layer which seals the outer surface of land plants, helping to retain moisture.

diapsid -- n. A vertebrate distinguished by a skull with two pairs of openings in the side behind the eyes, e.g., lizards, snakes, crocodiles, dinosaurs, and pterosaurs.

ectoderm -- The outer basic layer of tissue in those animals with true tissues. In vertebrates, for instance, the embryonic ectoderm differentiates into the skin and also the nervous system.

endoderm -- The innermost basic layer of tissue in those animals with true tissues. Forms the gut and its derivatives: in vertebrates, these include the liver, trachea, and lungs.

epidermis -- The outermost layer of cells or skin. This tissue often contains specialized cells for defense, gas exchange, or secretion.

epithelium -- Layer of cells which lines a body cavity; cells may be ciliated or unciliated, and may be **squamous** (flat, scale-shaped), **cuboidal** (cube-shaped), or **columnar** (column-shaped). Your stomach and cheeks are lined with epithelium.

esophagus -- That portion of the gut which connects the pharynx to the stomach.

exoskeleton -- n. An external, often hard, covering or integument that provides support and protection to the body.

gastrodermis -- In [cnidarians](#), the endodermis which lines the gut cavity. The term is often used instead of endodermis since cnidarians only have two tissue layers instead of three.

genus -- n. A category in the classification of plants and animals between species and family; **genera**- pl.

gill -- In aquatic animals, highly [vascularized](#) tissues with large surface area; these are extended out of the body and into the surrounding water for gas exchange.

gill arches -- Stiffenings which support the flesh between the gill slits of [chordates](#). In most vertebrates, the first gill arches have been modified to form the [jaw](#), and in tetrapods, the inner ear bones.

gill slit -- A slitlike or porelike opening connecting the pharynx of a [chordate](#) with the outside of the body. Gill slits may contain the gills and be used for gas exchange, as in most fish, but may also be used for filter-feeding, or may be highly modified in land-dwelling vertebrates.

gnathobase -- The expanded and hardened base of the appendage of many arthropods, notably [trilobites](#), [crustaceans](#), and marine [cheliceramorphs](#). Used to macerate food items before ingestion.

gut (enteron) -- Body cavity formed between the mouth and anus in which food is digested and nutrients absorbed; it consists of the [mouth](#), [pharynx](#), [esophagus](#), [stomach](#), [intestine](#), and [anus](#), though some animals do not have all these regions.

head -- That part of the body at the "front" end, where the brain, mouth, and most sensory organs are located.

heart -- Muscular pump which circulates the blood.

intestine -- The portion of the digestive tract between the stomach and anus; it is the region where most of the nutrients are absorbed.

jaw -- Often loosely applied to any movable, toothed structures at or near the mouth of an animal, such as the [scolecodonts](#) of [annelids](#). In [vertebrates](#), the jaw is derived from the first **gill arch**.

jointed -- When stiff body parts are connected by a soft flexible region, the body is said to be jointed.

librigenae -- The "free cheeks"; separate, detachable portions of the trilobite cephalon. [More info?](#)

lophophore -- Complex ring of hollow tentacles used as a feeding organ. The tentacles are covered by cilia, which generate a current to bring food particles into the mouth. The structure is only found in the [brachiopods](#), [phoronids](#), and [bryozoans](#). [More info?](#)

marsupial -- n. (adj.) A mammal whose young are born while still embryos, and must crawl into its mother's external pouch (called the **marsupium**) to finish development.

mesoderm -- In animals with three tissue layers (i.e. all except [sponges](#) and [cnidarians](#)), the middle layer of tissue, between the **ectoderm** and the **endoderm**. In vertebrates, for instance, the mesoderm forms the skeleton, muscles, heart, spleen, and many other internal organs.

mesogloea -- Jellylike material between the outer ectoderm and the inner endoderm of [cnidarians](#). May be very thin or may form a thick layer (as in many jellyfish).

mouth -- Front opening of the digestive tract, into which food is taken for digestion. In [flatworms](#), the mouth is the only opening into the digestive cavity, and is located on the "belly" of the worm.

mucus -- Sticky secretion used variously for locomotion, lubrication, or protection from foreign particles.

muscle -- Bundle of contractile cells which allow animals to move. Muscles must act against a [skeleton](#) to effect movement.

myotome -- Segment of the body formed by a region of muscle. The myotomes are an important feature for recognizing early [chordates](#).

nematocyst -- Older name for a [cnidocyst](#).

nerve -- A bundle of **neurons**, or nerve cells. More properly, it is a bundle of axons.

nerve cord -- Primary bundle of nerves in chordates, which connects the brain to the major muscles and organs of the body.

neuron -- A specialized cell that can react to stimuli and transmit impulses. A neuron consists of a **body** which contains the nucleus; **dendrites**, which are short branches off the body that receive incoming impulses; and a long **axon** which carries impulses away from the body and to the next neuron.

notochord -- Characteristic of [chordates](#), the notochord is a stiff rod of tissue along the back of the body. In vertebrates, the backbone is deposited around the notochord and nerve cord.

organ -- Collection of tissues which performs a particular function or set of functions in an animal or plant's body. The heart, brain, and skin are three organs found in most animals. The leaf, stem, and root are three organs found in most plants. Organs are composed of **tissues**, and may be organized into larger **organ systems**.

organ system -- Collection of organs which have related roles in an organism's functioning. The nervous system, vascular system, and muscle system are all organ systems.

osculum -- The main opening through which filtered water is discharged. Found in [sponges](#).

papilla(e) -- Cellular outgrowths. These look like little bumps or fingers on the surface of cells.

parapodia -- A sort of "false foot" formed by extension of the body cavity. Polychaetes and some insect larvae have parapodia in addition to their legs, and these provide extra help in locomotion.

pedipalps -- The second pair of appendages of [cheliceromorphs](#). In many arachnids, such as spiders, the pedipalps are enlarged in the male and used for copulation.

pharyngeal slits -- Characteristic of [chordates](#), pharyngeal slits are openings through which water is taken into the pharynx, or throat. In primitive chordates the pharyngeal slits are used to strain water and filter out food particles; in fishes they are modified for respiration. Most terrestrial vertebrates have pharyngeal slits only in the embryonic stage.

pharynx -- Cavity in the digestive tract just past the mouth itself. May be muscularized for sucking or swallowing in various animals.

phylum -- n. A category in the hierarchy of animal classification between class and kingdom; **phyla**- pl.

placenta -- n. In mammals, a tissue formed within the uterus through which nutrients are passed from the mother to the embryo (and later the fetus) and its wastes are removed; **placental**- n. (adj.) A mammal whose young form a placenta as they develop in the mother's uterus.

pleurae -- In trilobites and other arthropods, pleurae are elongated flat outgrowths from each body segment, that overlie and protect the appendages.

pore -- Any opening into or through a tissue or body structure.

proboscis -- Elongated organ, usually associated with the mouth. The proboscis is an important feeding appendage in [echiurans](#).

pygidium -- In trilobites, the posterior division of the body, formed by fusion of the **telson** with one or more posterior **pleurae**.

segmentation -- In many animals, the body is divided into repeated subunits called **segments**, such as those in centipedes, [insects](#), and [annelids](#). Segmentation is the state of having or developing a body plan in this way.

septum -- Partition which divides up a larger region into smaller ones, such as in the central body cavity of some anthozoa.

siphon -- Opening in [molluscs](#) or in [urochordates](#) which draws water into the body cavity. In many molluscs, the siphon may be used to expel water forcibly, providing a means of propulsion.

skeleton -- Support structure in animals, against which the force of muscles acts. Vertebrates have a skeleton of [bone](#) or cartilage; arthropods have one made of [chitin](#); while many other invertebrates use a **hydrostatic** skeleton, which is merely an incompressible fluid-filled region of their body.

spicule -- Crystalline or mineral deposits found in sponges, sea cucumbers, or urochordates. They are structural components in many [sponges](#), and may serve a protective function in other organisms.

spiracle -- In insects and some other terrestrial arthropods, a small opening through which air is taken into the **tracheae**. Insects have several spiracles, arranged along the sides of the abdomen.

spongocoel -- Central body cavity of sponges. [More Info?](#)

synapsid -- n. A vertebrate distinguished by a skull with one pair of openings in the side behind the eyes, e.g., mammals and their close relatives.

telson -- The last segment of the abdomen in many arthropods. May be flat and paddlelike, buttonlike, or long and spiny, as in the [horseshoe crabs](#).

tentacles -- Appendages which are flexible, because they have no rigid skeleton. Cnidarians and molluscs are two kinds of organisms which may have tentacles.

tetrapod -- n. A vertebrae that has (or whose close relatives have) four limbs with digits, not fins.

thorax -- In insects, the second body region, between the head and abdomen. It is the region where the legs and wings are attached.

tissue -- A group of cells with a specific function in the body of an organism. Lung tissue, vascular tissues, and muscle tissue are all kinds of tissues found in some animals. Tissues are usually composed of nearly identical cells, and are often organized into larger units called **organs**.

tracheae -- Internal tubes through which air is taken for respiration. Vertebrates with lungs have a single trachea carrying air to the lungs, while insects and some other land-living arthropods have a complex network of tracheae carrying air from the **spiracles** to all parts of the body.

tube feet -- Extensions of the water-vascular system of [echinoderms](#), protruding from the body and often ending in suckers. May be used for locomotion and/or for maintaining a tight grip on prey or on the bottom.

tubercle -- Any small rounded protrusion. In pycnogonids and some cheliceramorph arthropods, the central eyes are carried on a tubercle.

uniramious -- Among [arthropods](#), uniramous refers to appendages that have only one branch. Insects, centipedes and millipedes, and their relatives are uniramous arthropods; land-living chelicerates such as scorpions, spiders, and mites are also uniramous but probably descended from ancestors with biramous appendages. Contrast with **biramous**.

vascular -- Refers to a network of tubes which distribute nutrients and remove wastes from the tissues of the body. Large multicellular animals must rely on a vascular system to keep their cells nourished and alive.

vertebra -- A component of the **vertebral column**, or backbone, found in [vertebrates](#).

zooxanthellae -- Symbiotic [dinoflagellates](#) in the genus *Symbiodinium* that live in the tissues of a number of marine invertebrates and protists, notably in many foraminiferans, cnidarians, and some mollusks.

Last updated:2004-04-20

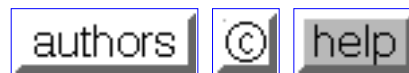

UCMP Glossary: Paleogeography



| [Phylogenetics](#) | [Geology](#) | [Biochemistry](#) | [Cell biology](#) |
[Ecology](#) | [Life history](#) | [Zoology](#) | [Botany](#) | **Paleogeography** |

Avalonia -- n. A separate plate in the Early Paleozoic consisting of much of Northern Europe, Newfoundland, Nova Scotia, and some coastal parts of New England.

Baltica -- n. A separate continental plate of the Early Paleozoic composed of the United Kingdom, Scandinavia, European Russia and Central Europe; named for the Baltic Sea.

Bering Land Bridge -- n. The vast tundra plain that was exposed between Asia and North America during the Last Glacial Maximum, about 21,000 years ago; it served as a migration route for people, animals, and plants. Also known as **Beringia**.

Cathaysian terranes -- n. A set of small landmasses that developed in tropical to subtropical latitudes on the eastern side of Pangea during the Permian and Triassic, includes modern North China (Sino-Korea), South China (Yangtze), Eastern Qiangtang, Tarim, and Indochina.

Cimmerian terranes -- n. An archipelago of small landmasses that developed in tropical and subtropical latitudes on the eastern side of Pangea during the Triassic, blocks that comprised it include modern Turkey, Iran, Afghanistan, Tibet, and Malaysia; also called **Cimmeria**.

Congo craton -- n. A separate continental plate that rifted from the supercontinent Rodinia in the Late Precambrian; contained a large part of north-central Africa.

Cretaceous Western Interior Seaway -- n. The epicontinental sea that formed as marine waters from the north spread over North America from around 130 to 70 million years ago (Ma), at its peak in the Middle Cretaceous (~ 90 Ma) it extended from present-day Utah to the Appalachians and from the Arctic to the Gulf of Mexico; also referred to as the **Western Interior Seaway**

Euramerica -- n. A supercontinent that existed in the Late Silurian through Devonian, formed by the collision of Baltica, Laurentia, and Avalonia; included modern North America, Greenland, Scandinavia, and Europe; also called the “Old Red Continent” for the red color of its oxidized deposits.

Gondwana -- n. A supercontinent that existed from Cambrian to Jurassic time, mainly composed of South America, Africa, Madagascar, India, Antarctica, and Australia.

Iapetus Ocean -- n. A relatively small ocean that existed between the continents of Laurentia, Baltica, and Avalonia from the Late Precambrian to the Devonian.

Laurasia -- n. A supercontinent that existed from the Jurassic to Early Tertiary after splitting from Pangea; composed of Laurentia, Baltica, Avalonia, (modern North America, Scandinavia, Greenland, Western and Central Europe); eventually fragmented into Eurasia and North America in the Tertiary with the opening of the North Atlantic Ocean.

Laurentia -- n. A separate continental plate that existed from the Late Precambrian to Silurian, consisting of the major part of North America, northwest Ireland, Scotland, Greenland, and pieces of Norway and Russia.

Paleo-Tethys Ocean -- n. A large ocean that originated between eastern Gondwana, Siberia, Kazakhstan, and Baltica in the Ordovician and finally closed in the Jurassic; replaced by the Tethys Ocean as eastern Pangea was assembled.

Pangea -- n. A supercontinent that existed from the the end of the Permian to the Jurassic, assembled from large continents like Euramerica, Gondwana, and Siberia, as well as smaller landmasses like the Cathaysian and Cimmerian terranes; Greek for “all lands.”

Pannotia -- n. A supercontinent that existed in the Late Precambrian and gave rise to the continents of Gondwana, Laurentia, Siberia, and Baltica in the Cambrian.

Panthalassic Ocean -- n. A vast ocean that existed from the Late Precambrian to the Jurassic, circling the globe and connecting to smaller oceans that developed throughout the Phanerozoic; also known as the **Panthalassa**.

Rodinia -- n. A supercontinent that existed during the Late Precambrian before the supercontinent Pannotia; the oldest supercontinent for which we have a good record; Russian for "homeland."

Siberia -- n. A separate continental plate that existed from the Latest Precambrian to the Carboniferous, composed of a large part of central Russia, namely Siberia.

Tethys Ocean -- n. A small ocean that existed from the Triassic to the Jurassic; as Pangea was split into Gondwana and Laurasia in the Jurassic, an arm developed westward called the **Tethys Seaway** or **Tethys Sea**.

Last updated:2004-04-20



Introduction to the Anthophyta

the flowering plants



If you have ever stopped to smell the roses, then you are familiar with the largest group of [plants](#), the Anthophyta. The distinctive feature of this group is the **flower**, a cluster of highly-specialized leaves which participate in reproduction. Not all flowers are as conspicuous as the *Magnolia* blossom in the picture above; oaks, ivy, and [grasses](#) also produce flowers, but because they are not as showy we often do not notice them.

The flowering plants are important in many ways above and beyond their aesthetic appeal in flower arrangements. Not a day goes by in which our lives are not affected by flowering plants. Nearly all of our food comes from flowering plants; grains, beans, nuts, fruits, vegetables, herbs and spices almost all come from plants with flowers, as do tea, coffee, chocolate, wine, beer, tequila, and cola. Much of our clothing comes from them as well -- cotton and linen are made from "fibers" of flowering plants, as are rope and burlap, and many commercial dyes are extracted from other flowering plants. We also owe them credit for a large number of our drugs, including over-the-counter medicines such as aspirin, prescribed drugs such as digitalis and atropine, and controlled drugs such as opium, cocaine, marijuana, and tobacco.

Click on the buttons below to find out more about the Anthophyta.

You can navigate deeper into the Anthophyte groups by selecting Systematics!



You can find more information about floristics, collections, and images of flowering plants by looking through our [Listings of Remote Catalogs](#).

For images covering much of angiosperm diversity, try the flowering plant image collection at the [University of Wisconsin](#).

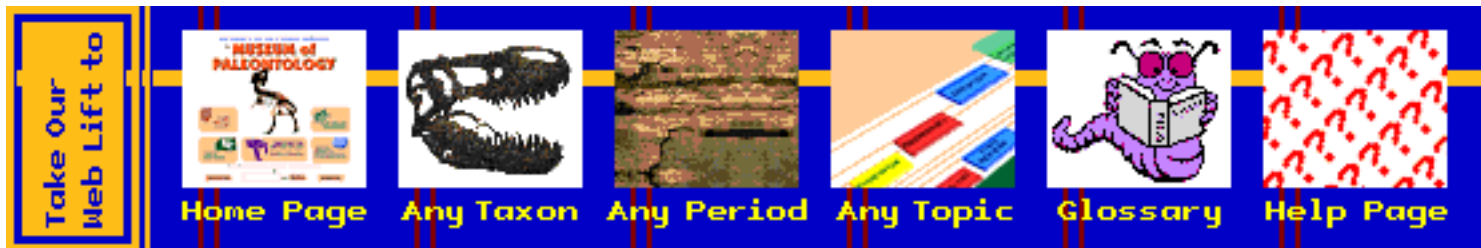
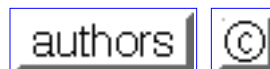

Image of *Magnolia* blossom by Brian R. Speer



Fossil Record

Life History
& Ecology

Systematics

More on
Morphology

Anthophyta: More on Morphology

Angiosperms produce their reproductive organs within a flower.

Like other seed plants, angiosperms are **heterosporangiate**, producing pollen and ovules in different organs. Unlike most seed plants, however, the pollen and ovule-bearing organs are usually produced together in a **bisporangiate strobilus** called a **flower**.

In the center of a typical flower are the **carpels**, modified leaves which enclose the ovules. These are often fused to form a single **pistil** in the center of the flower. Surrounding the carpels are several narrow stalks topped by pollen sacs; these pollen-bearing stalks are called **stamens**. Around these reproductive organs is the **perianth**, usually consisting of an outer whorl of **sepals** and an inner whorl of **petals**. In monocots and "primitive" dicots, the sepals and petals may be indistinguishable, as in the lily shown at right. In this case the perianth parts are called **tepals**.

The first flowering plants had numerous floral parts spiralled around a central axis, much like the flowers of *Magnolia*. In most angiosperms, however, the floral parts are relatively few, and are arranged in a **whorl**, in which a set of parts are all attached around the central axis at the same level, instead of being attached in a staggered spiral. The parts of these earliest flowers were likely very large and radially arranged; they were not fused to each other, as is common in many groups today.

In many angiosperms, the flowers are arranged in clusters called **inflorescences**. The flowers may be attached along a tall stalk, arranged in broad open clusters, or pressed tightly together so that



the cluster looks like a single flower.

Angiosperm means "vessel seed".

Angiosperms differ from other [seed plants](#) in that they enclose their ovules (and seeds) within a carpel. The carpel is a modified leaf bearing the ovules, but the carpel is folded onto itself, wrapping the ovules inside. The "vessel" which the carpel forms gives the angiosperms their name.

Although the carpels are hypothesized to give extra protection to the developing ovules and seeds, there is a problem with encasing the ovules -- how to get the pollen to the ovule so that it can deliver the sperm? In angiosperms, the pollen tube does not simply grow through an opening in the tissue surrounding the ovule, but it must penetrate and grow *through* the tissue.

This feature of angiosperms allows for sexual selection and pollen competition in ways that are not possible in other seed plants. The carpel tissue can "screen" arriving pollen, and selectively prevent growth of certain genotypes. In some flowers, this increases outbreeding, as the plant prevents its own pollen from germinating.

A fruit is a matured ovary.

Once the pollen has fertilized the egg cell contained within the ovule, the ovule develops into a seed, and the ovary of the enclosing carpel begins to enlarge and ripen, forming the **fruit**. This is the botanical definition of a fruit, and is not the same as the popular usage of "fruit". For example, a botanist considers acorns, tomatoes, green beans, and coconuts to be fruits. The individual grains of wheat and rice are also fruits by this definition. By contrast, strawberries are NOT fruits; the individual hard bits on the outside of the strawberry are the matured ovaries, and are properly considered fruits, while the fleshy red portion is actually stem tissue stimulated to growth by the maturing fruits.

It should also be pointed out that ALL flowering plants produce fruits, and that not all fruits are edible. The fruit of the potato plant is quite poisonous, and should not be eaten. Cotton bolls are dry fruits from which we harvest cotton fibers.

You can read about the morphological differences between [monocots and dicots](#) on our server.

California State University has an online interactive [Fruit Key](#) with illustrations.

Learn [How to Identify Flowering Plants](#) from Botany Online.

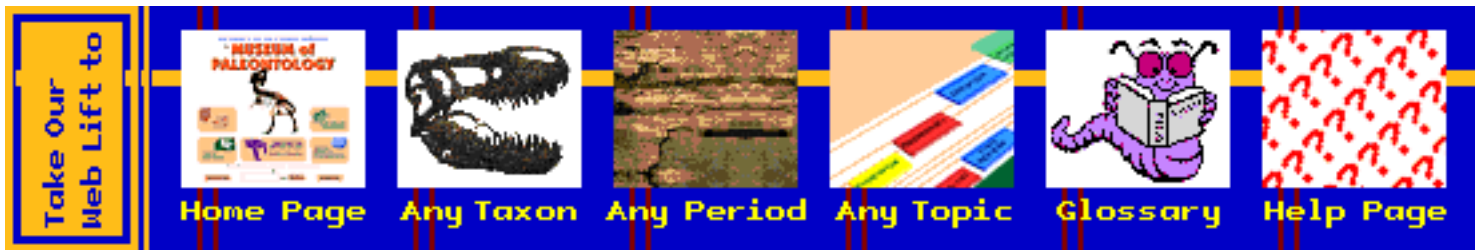
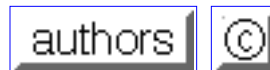

Image of lily flower courtesy of the [Jepson Herbarium](#), and used with permission.

Source:

E.M.Gifford and A.S.Foster. 1989. Morphology and Evolution of Vascular Plants, 3rd ed.
W.H.Freeman and Company, New York.



UCMP Glossary: G



| [A](#) | [B](#) | [C](#) | [D](#) | [E](#) | [F](#) | **G** | [H](#) | [I](#) | [J](#) | [K](#) | [L](#) | [M](#) | [N](#) | [O](#) | [P](#) | [Q](#) | [R](#) |
[S](#) | [T](#) | [U](#) | [V](#) | [W](#) | [X](#) | [Y](#) | [Z](#) |

gabbro -- Highly [mafic igneous plutonic](#) rock, typically dark in color; rough plutonic equivalent of [basalt](#).

gamete -- Reproductive cells which fuse to form a **zygote**. Gametes are **haploid**, and may be differentiated into egg and sperm.

gametophyte -- The haploid stage in the life cycle of an organism undergoing alternations of generations. The gametophyte is multicellular and mitotically produces gametes. In plants, the gametophyte nourishes the zygote and young [sporophyte](#).

gastrodermis -- In [cnidarians](#), the endodermis which lines the gut cavity. The term is often used instead of endodermis since cnidarians only have two tissue layers instead of three.

Gastroliths -- Fossilized gizzard stones, usually only applicable in the fossil study of reptiles

generalist -- Organism which can survive under a wide variety of conditions, and does not specialize to live under any particular set of circumstances.

genus -- n. A category in the classification of plants and animals between species and family; **genera**- pl.

geologic maps -- Maps that show the types and ages of rock of an area. These maps are used by paleontologists to find areas that are likely to contain fossils they are interested in.

germination -- The process by which a seedling emerges and develops from a seed, or by which a sporeling emerges and develops from a spore.

gill -- In aquatic animals, highly [vascularized](#) tissues with large surface area; these are extended out of the body and into the surrounding water for gas exchange.

gill arches -- Stiffenings which support the flesh between the gill slits of [chordates](#). In most vertebrates, the first gill arches have been modified to form the [jaw](#), and in tetrapods, the inner ear bones.

gill slit -- A slitlike or porelike opening connecting the pharynx of a [chordate](#) with the outside of the body. Gill slits may contain the gills and be used for gas exchange, as in most fish, but may also be used for filter-feeding, or may be highly modified in land-dwelling vertebrates.

glass -- A non-crystalline rock that results from very rapid cooling of magma.

glucose -- simple sugar, and the primary product of photosynthesis. It is polymerized to make cellulose and chitin.

glycoprotein -- a membrane-bound protein which has attached branching carbohydrates. These may function in cell-cell recognition, such as in human blood groups and immune system response, as well as in resisting compression of cells.

gnathobase -- The expanded and hardened base of the appendage of many arthropods, notably [trilobites](#), [crustaceans](#), and marine [cheliceramorphs](#). Used to macerate food items before ingestion.

Golgi apparatus -- Eukaryotic organelle which package cell products, such as enzymes and hormones, and coordinate their transport to the outside of the cell.

Gondwana -- n. A supercontinent that existed from Cambrian to Jurassic time, mainly composed of South America, Africa, Madagascar, India, Antarctica, and Australia.

gradualism -- A model of evolution that assumes slow, steady rates of change. Charles Darwin's original concept of evolution by natural selection assumed gradualism. Contrast with punctuated equilibrium.

grain -- (1) The texture of wood, produced by the kinds of **xylem** cells present. (2) The **fruit** of a member of the [grasses](#).

granite -- Highly [felsic igneous plutonic](#) rock, typically light in color; rough plutonic equivalent of [rhyolite](#). Granite is actually quite rare in the U.S.; often the term is applied to any quartz-bearing plutonic rock.

granodiorite -- [Igneous plutonic](#) rock, less [felsic](#) than granite, typically light in color; rough plutonic equivalent of [dacite](#).

grassland -- Region in which the climate is dry for long periods of the summer, and freezes in the winter. Grasslands are characterized by [grasses](#) and other erect herbs, usually without trees or shrubs. Grasslands occur in the dry temperate interiors of continents, and first appeared in the [Miocene](#).

graywacke -- [Sandstone](#) composed of poorly sorted angular [clasts](#).

Groundwater -- Water found underground as a result of rainfall, ice and snow melt, submerged rivers, lakes, and springs. This water often carries minerals. These minerals can accumulate in the remains of buried organisms and eventually cause fossilization.

guard cells -- Pair of cells which surround a **stomate** and regulate its size by altering their shape.

gut (enteron) -- Body cavity formed between the mouth and anus in which food is digested and nutrients absorbed; it consists of the [mouth](#), [pharynx](#), [esophagus](#), **stomach**, [intestine](#), and [anus](#), though some animals do not have all these regions.

gymnosperm -- n. A plant that produces seeds, which are not enclosed; includes any [seed plant](#) that does not produce flowers.

gynostemium -- The central reproductive stalk of an [orchid](#), which consists of a **stamen** and **pistil** fused together.

Last updated:2004-04-20



UCMP Glossary: S



| [A](#) | [B](#) | [C](#) | [D](#) | [E](#) | [F](#) | [G](#) | [H](#) | [I](#) | [J](#) | [K](#) | [L](#) | [M](#) | [N](#) | [O](#) | [P](#) | [Q](#) | [R](#) |
 S | [T](#) | [U](#) | [V](#) | [W](#) | [X](#) | [Y](#) | [Z](#) |

salinity -- A measure of the salt concentration of water. Higher salinity means more dissolved salts.

salt lick -- n. A natural or artificial deposit of exposed salt that animals lick for nutrients.

sandstone -- [Sedimentary rock](#) composed of sand-sized [clasts](#).

saprophyte -- Organism which feeds on dead and decaying organisms, allowing the nutrients to be recycled into the ecosystem. [Fungi](#) and [bacteria](#) are two groups with many important saprophytes.

saxitoxin -- neurotoxin found in a variety of dinoflagellates. If ingested, it may cause respiratory failure and cardiac arrest.

scavenger -- An organism that feeds upon dead and dying organisms.

sea-floor spreading -- n. The process of adding to the Earth's crust at mid-ocean ridges as magma wells up and forces previously formed crust apart.

seaweed -- Any large photosynthetic [protist](#), including [rhodophytes](#) and [kelps](#). Seaweeds are not true [plants](#), but like plants they can make their own food. [More info?](#)

secondary growth -- Growth in a plant which does not occur at the tips of the stems or roots. Secondary growth produces wood and bark in [seed plants](#).

sedentary -- Living in a fixed location, as with most plants, tunicates, sponges, etc. Contrast with [motile](#).

sediment -- Any solid material that has settled out of a state of suspension in liquid.

sedimentary rock -- Any rock resulting from the consolidation of [sediment](#).

seed -- A structure produced by [seed plants](#) which encapsulates the embryo. The seed often provides nourishment during germination, but may lie dormant for many years first.

segmentation -- In many animals, the body is divided into repeated subunits called **segments**, such as those in centipedes, [insects](#), and [annelids](#). Segmentation is the state of having or developing a body plan in this way.

selection -- Process which favors one feature of organisms in a population over another feature found in the population. This occurs through differential reproduction—those with the favored feature produce more offspring than those with the other feature, such that they become a greater percentage of the population in the next generation.

sepal -- The outermost structures of a flower. [More info?](#)

septum -- Partition which divides up a larger region into smaller ones, such as in the central body cavity of some anthozoa.

sexual reproduction -- A type of reproduction in which two parents give rise to offspring that have unique combinations of genes inherited through the gametes of the two parents. Sexual reproduction involves **meiosis** and **syngamy**.

shoot -- Usually, the above ground portion of a plant, bearing the leaves. Contrast with **root**.

Siberia -- n. A separate continental plate that existed from the Latest Precambrian to the Carboniferous, composed of a large part of central Russia, namely Siberia.

siderite -- Also called ironstone, that is a concretion of iron carbonate. Common in the [Mazon Creek](#) fossil beds.

silica -- amorphous silicon dioxide (glass). It is a structural component in many organisms, such as [diatoms](#) and [horsetails](#).

silicification -- Process whereby silica replaces the original material of a substance. For example, silicified wood.

sill -- n. A sheet-like igneous intrusion that parallels the plane of the surrounding rock.

sinkhole -- n. A natural depression in the surface of the land caused by the collapse of the roof of a cavern or subterranean passage, generally occurring in limestone regions.

siphon -- Opening in [molluscs](#) or in [urochordates](#) which draws water into the body cavity. In many molluscs, the siphon may be used to expel water forcibly, providing a means of propulsion.

siphonostele -- When a plant's vascular tissue develops as a central cylinder, it is said to have a siphonostele. See also protostele and eustele.

sister group -- The two clades resulting from the splitting of a single lineage.

skeleton -- Support structure in animals, against which the force of muscles acts. Vertebrates have a skeleton of [bone](#) or cartilage; arthropods have one made of [chitin](#); while many other invertebrates use a **hydrostatic** skeleton, which is merely an incompressible fluid-filled region of their body.

soil -- Unconsolidated materials above [bedrock](#).

specialist -- Organism which has adopted a lifestyle specific to a particular set of conditions. Contrast with [generalist](#).

spermatophyte -- A [seed plant](#).

spicule -- Crystalline or mineral deposits found in sponges, sea cucumbers, or urochordates. They are structural components in many [sponges](#), and may serve a protective function in other organisms.

spiracle -- In insects and some other terrestrial arthropods, a small opening through which air is taken into the **tracheae**. Insects have several spiracles, arranged along the sides of the abdomen.

spongin -- proteinaceous compound of which the spicules in [Demospongiae](#) are composed.

spongocoel -- Central body cavity of sponges. [More Info?](#)

sporangiophore -- A stalk to which sporangia are attached.

sporangium -- A chamber inside of which spores are produced through [meiosis](#).

spore -- n. A single cell that is dispersed as a reproductive unit, or that encapsulates a cell during unfavorable environmental conditions; in organisms with an alternation of generations; the products of meiosis are spores.

sporophyll -- Any leaf which bears sporangia is called a sporophyll.

sporophyte -- The diploid stage in the life cycle of an organism undergoing an alternation of generations. The sporophyte is multicellular and develops from a zygote. The mature sporophyte meiotically produces haploid spores that later generate the [gametophyte](#) generation.

stamen -- Part of a flower, the tip of which produces pollen and is called the **anther**. [More info?](#)

starch -- a complex polymer of glucose, used by plants and green algae to store surplus sugar for later use.

stasis -- A period of little or no discernible change in a lineage.

stem group -- All the taxa in a clade preceding a major cladogenesis event. They are often difficult to recognize because they may not possess synapomorphies found in the crown group.

stigma -- The sticky tip of a **pistil**. Or, the dense region of pigments found in many photosynthetic protists which is sensitive to light, and thus functions somewhat like a miniature eye. [More info?](#)

stipe -- A scientific term for "stalk".

stipules -- Paired appendages found at the base of the leaves of many [flowering plants](#).

stomata -- Openings in the epidermis of a stem or leaf of a plant which permit gas exchange with the air. In general, all plants except liverworts have stomata in their sporophyte stage.

stratigraphy -- n. The study of rock layers, especially their distribution, environment of deposition, and age; **stratigraphic**, adj.

stratum -- A layer of [sedimentary rock](#); plural is **strata**.

streptophytes -- The [clade](#) consisting of the [plants](#) plus their closest relatives, the [charophytes](#).

strike -- The direction or trend of a bedding plane or [fault](#), as it intersects the horizontal.

strobilus -- A tightly clustered group of **sporophylls** arranged on a central stalk; commonly termed a "cone" or "flower".

style -- The narrow stalk of the **pistil**, located above the ovary but below the **stigma**.

subduction -- n. A geologic process in which one edge of one crustal [plate](#) is forced below the edge of another; **subduct**– v.; **subduction zone**- n. A long narrow area in which subduction is taking place, e.g. the Peru-Chile trench, where the Pacific Plate is being subducted under the South American Plate.

subsidence -- n. The sudden sinking or gradual downward settling of the Earth's surface with little or no horizontal motion.

substrate -- "Supporting surface" on which an organism grows. The substrate may simply provide structural support, or may provide water and nutrients. A substrate may be inorganic, such as rock or soil, or it may be organic, such as wood.

sugar -- any of several small carbohydrates, such as glucose, which are "sweet" to the taste.

symbiosis -- n. A relationship between two organisms that live in intimate contact with each other; includes mutualism (both organisms benefit, they rely on each other for survival), parasitism (one organism benefits at its host's expense) and commensalism (one partner benefits and the other is neither benefitted nor harmed); **symbiotic**- adj.

synangium -- A cluster of sporangia which have become fused in development.

synapomorphy -- A character which is derived, and because it is shared by the taxa under consideration, is used to infer common ancestry.

synapsid -- n. A vertebrate distinguished by a skull with one pair of openings in the side behind the eyes, e.g., mammals and their close relatives.

syncline -- A fold of rock layers that is convex downwards. Antonym of [anticline](#).

syncytic -- see [Hexactinellida](#)

syngamy -- The process of union of two gametes; sometimes called fertilization. It encompasses both **plasmogamy** and **karyogamy**.

systematics -- Field of biology that deals with the diversity of life. Systematics is usually divided into the two areas of [phylogenetics](#) and [taxonomy](#).

Last updated:2004-04-20



Introduction to the Anthocerotophyta

The hornworts

Most people are unaware of hornworts, though they are a quite common and widespread group of [plants](#) which may be found in tropical forests, along streamsides, and in disturbed fields around the world. Most species are small and unassuming greasy blue-green patches, but some tropical species can cover large areas of soil or the sides of trees. Because of their unique morphology, there have been many questions about relationships and origin of the Anthocerotophyta.

Hornworts are a very unusual group of plants.

The group's common name "hornwort" refers to the tall narrow **sporophytes** which are embedded in the top of the plant. As in other bryophytes, the sporophyte remains attached to its parent **gametophyte** throughout its life, but unlike these other plants, the sporophyte continues to grow throughout its life; this happens as a group of cells at the base of the horn divide repeatedly. This continuous growth from a **near-basal meristem** is unique among plants to hornworts.

As the sporophyte grows longer, it splits into two halves lengthwise, releasing the spores as they mature. Along with the spores are cells called **pseudoelaters**, which change shape as they dry out and thereby assist in scattering the spores.

When a spore germinates, it produces a flat **thalloid** plant with a greasy blue-green color and odd morphology. The best way to recognize a hornwort, and especially to tell it apart from a liverwort or fern gametophyte, is to look at the plant under a low-power microscope; hornworts will generally have a single large **chloroplast** per cell. This is an especially useful character for sterile material, but you must look at *fresh* material, since hornworts tend to dry up and fall apart if not kept moist, and will quickly rot if immersed.



Hornworts are a problematic group for evolutionary biologists.

The oldest hornwort fossils are spores from the late [Cretaceous](#) (Maastrichtian), which have been compared to the spores of the living genus *Phaeoceros*. A somewhat older fossil, *Notothylicites filiformis*, has been described as a hornwort from the Santonian (Late Cretaceous) of Czechoslovakia, but the identification of the fossil as a hornwort is not entirely certain -- the fossil preserves the whole plant, but in rather poor detail, and might be better interpreted as a liverwort. Most hornwort fossils are [Miocene](#) spores found in Europe and assigned to the Anthocerotaceae.

Such a late date for oldest fossils of hornworts is curious, considering that most cladistic analyses of living plants suggests that the group originated early in the history of land plants, probably before the [Devonian](#), and should be one of the oldest lineages of plants. The presence of a **columella**, or small column of tissue, running up through the center of the capsule is reminiscent of [mosses](#) and of "**rhyniophytes**", such as *Horneophyton*, and further supports the idea of an early divergence. The delicate hornworts may not have been easily preserved, which might explain the absence of a Paleozoic record. However, it seems puzzling that their spores, which would be much more likely to be preserved, are not encountered either.



Above, you can see pictures of the hornwort *Phaeoceros*. On the left is a plant with young sporophytes beginning to elongate from the top of the gametophyte. On the right is a plant with older sporophytes, which have split open and begun to release spores. Click on either picture to see

an enlarged version.

There are usually two or three families recognized in the Anthocerotophyta, as listed below. Because of the uncertain relationships of fossil hornworts, only living taxa are included in the list here.

NOTOTHYLALES

Notothyladaceae -- *Notothylas*

ANTHOCEROTALES

Anthocerotaceae -- 3 to 6 genera, including *Anthoceros* and *Phaeoceros*

Dendroceroaceae -- *Dendroceros* and *Megaceros*

For additional information about [hornwort classification](#), visit the [Tree of Life](#). You can also view hornwort images at the [University of Wisconsin](#), the source of the images used here (by permission).

Or for additional information about bryophytes in general, try the homepage of the [American Bryological and Lichenological Society](#).

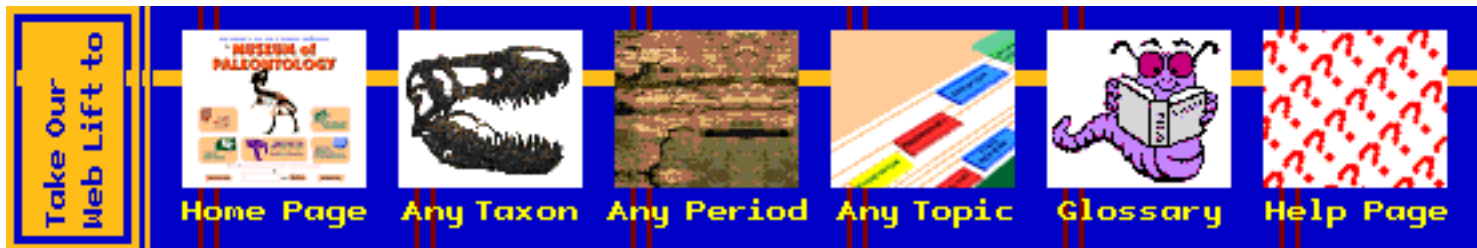

Sources:

J. Hyvonen and S. Piippo. 1993. Cladistic analysis of the hornworts (Anthocerotophyta). J. Hattori Bot. Lab. 74: 105-119.

P. Kenrick. 1994. Alternation of generations in land plants: new phylogenetic and palaeobotanical evidence. Biol. Rev. 69: 293-330.

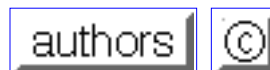

Introduction to the Cycads

Legacy of the Mesozoic



Cycads are an ancient group of [seed plants](#) with a crown of large compound leaves and a stout trunk. They are a minor component of the flora in tropical and subtropical regions today, but during the [Jurassic Period](#), they were a common sight in many parts of the world. For this reason, the Jurassic is often referred to as the "Age of Cycads".

Today only a handful of cycads still exist, and many are facing possible extinction in the wild (such as *Microcycas* in western Cuba). However, because of their large attractive leaves, many cycads have found a home in public and private gardens around the world. The above photograph shows a group of "Sago Palms", *Cycas revoluta*, growing outside the Hertz music building on the U.C. Berkeley campus. Though cycads are often known by this name, they are not closely related to the palms.

Click on the buttons below to find out more about the Cycads.

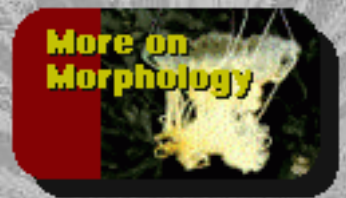
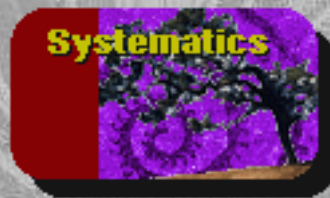

For oodles of cycad information and links, visit [The Cycad Pages](#) at the [Royal Botanic Gardens](#) in Sydney, Australia. Or read the [Virtual Cycad Encyclopedia](#) by the Palm and Cycad Societies of Florida.

Information on living cycads of Mexico, mostly in Spanish, is available from [Q'Taxa](#) at the University of California - Riverside. There are several nice cycad images on [Andy Boze's](#) page on [cycads](#), with many quality pictures of cycad cones and seeds. See cycads when you visit [Carnavon National Park](#) in Queensland, Australia or the [Fairchild Tropical Garden](#), long respected for having the largest collection of cycads in the US, and one of the largest such collections in the world.

You might also scan the [International Palm Society](#) listings of palm and cycad affiliated societies.

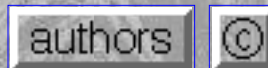
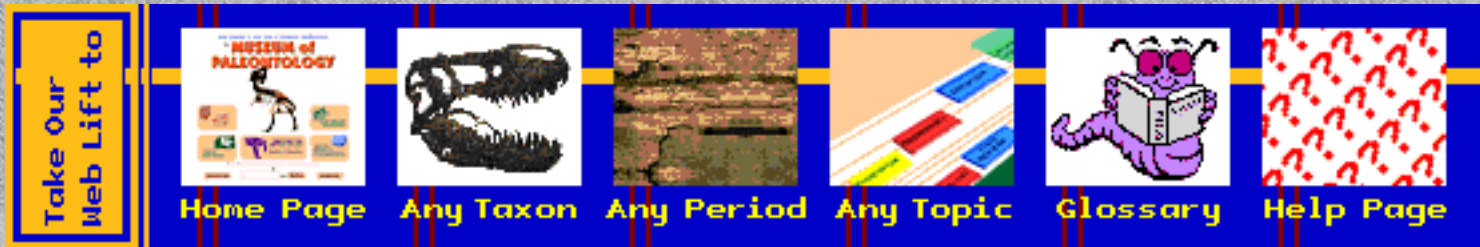

Monocots versus Dicots

The Two Classes of Flowering Plants

Contents

- [The history behind the classes](#)
 - [The fuzzy distinction between the classes](#)
 - [The characters which distinguish the classes](#)
 - [Common questions about the classes](#)
-

The history behind the classes.

Traditionally, the [flowering plants](#) have been divided into two major groups, or **classes**,: the Dicots (Magnoliopsida) and the [Monocots](#) (Liliopsida). Many people take this separation into two classes for granted, because it is "plainly obvious", but botanists have not always recognized these as the two fundamental groups of angiosperms. Although Theophrastus (circa 370 BC) is credited with first recognizing differences between the two groups, classification of plants was based upon overall growth form -- trees, herbs, vines -- until the 1600s.

In 1682, [John Ray](#) published his *Methodus Plantarum Nova*, in which Dicotyledones and Monocotyledones were first given formal taxonomic standing. This system was popularized by the French botanist Antoine Laurent de Jussieu in his *Genera Plantarum* of 1789, a work which improved upon, and gradually replaced, the system of plant classification devised by [Linnaeus](#).

The fuzzy distinction between the classes.

Even after the general acceptance of Monocots and Dicots as the primary groups of flowering plants, botanists did not always agree upon the placement of families into one or the other class. Even in this century some plants called [paleoherbs](#) have left problems for taxonomy of angiosperms. These plants have a mix of characters which do not occur together in most other flowering plants. For instance, the [Nymphaeales](#), or water lilies, have reticulate venation in their leaves, and what may be a single cotyledon in the embryo. It is not clear whether it is a single lobed cotyledon, or two which have been fused. The water lilies also have a vascular arrangement in their stem similar to that of monocots.

There are also monocots which possess characters more typical of dicots. The [Dioscoreales](#) and Smilacaceae have broad reticulate-veined leaves; the Alismataceae have acropetal leaf development; and *Potamogeton* is one of several monocots to have floral parts in multiples of

four.

This "fuzziness" in the definitions of Monocotyledonae and Dicotyledonae is not simply the result of poor botany. Rather, it is a real phenomenon resulting from the shared ancestry of the two groups. It is now believed that some of the dicots are more closely related to monocots than to the other dicots, and that the angiosperms do not all fit neatly into two clades. In other words, the dicots include a basal **paraphyletic** group from which the monocots evolved. [Click here](#) for a cladogram which illustrates our current understanding of basal angiosperm relations.

The characters which distinguish the classes.

Despite the problems in recognizing basal angiosperm taxa, the standard distinctions between dicots and monocots are still quite useful. It must be pointed out, however, that there are many exceptions to these characters in both groups, and that *no single character* in the list below will infallibly identify a flowering plant as a monocot or dicot.

The table summarizes the major morphological differences between monocots and dicots; each character is discussed in more detail below. For more information, refer to the page on [monocot morphology](#).

MONOCOTS	DICOTS
Embryo with single cotyledon	Embryo with two cotyledons
Pollen with single furrow or pore	Pollen with three furrows or pores
Flower parts in multiples of three	Flower parts in multiples of four or five
Major leaf veins parallel	Major leaf veins reticulated
Stem vascular bundles scattered	Stem vascular bundles in a ring
Roots are adventitious	Roots develop from radicle
Secondary growth absent	Secondary growth often present

- **Number of cotyledons** -- The number of cotyledons found in the embryo is the actual basis for distinguishing the two classes of angiosperms, and is the source of the names Monocotyledonae ("one cotyledon") and Dicotyledonae ("two cotyledons"). The **cotyledons** are the "seed leaves" produced by the embryo. They serve to absorb nutrients packaged in the seed, until the seedling is able to produce its first true leaves and begin photosynthesis.
- **Pollen structure** -- The first angiosperms had pollen with a single furrow or pore through the outer layer (**monosulcate**). This feature is retained in the monocots, but most dicots are descended from a plant which developed three furrows or pores in its pollen (**triporate**).
- **Number of flower parts** -- If you count the number of petals, stamens, or other floral parts, you will find that monocot flowers tend to have a number of parts that is divisible by three, usually three or six. Dicot flowers on the other hand, tend to have parts in multiples of four or five (four, five, ten, etc.). This character is not always reliable, however, and is not easy to use in some

flowers with reduced or numerous parts.

- **Leaf veins** -- In monocots, there are usually a number of major leaf veins which run parallel the length of the leaf; in dicots, there are usually numerous auxillary veins which reticulate between the major ones. As with the number of floral parts, this character is not always reliable, as there are many monocots with reticulate venation, notably the aroids and Dioscoreales.
 - **Stem vascular arrangement** -- Vascular tissue occurs in long strands called **vascular bundles**. These bundles are arranged within the stem of dicots to form a cylinder, appearing as a ring of spots when you cut across the stem. In monocots, these bundles appear scattered through the stem, with more of the bundles located toward the stem periphery than in the center. This arrangement is unique to monocots and some of their closest relatives among the dicots.
 - **Root development** -- In most dicots (and in most seed plants) the root develops from the lower end of the embryo, from a region known as the **radicle**. The radicle gives rise to an **apical meristem** which continues to produce root tissue for much of the plant's life. By contrast, the radicle aborts in monocots, and new roots arise **adventitiously** from nodes in the stem. These roots may be called prop roots when they are clustered near the bottom of the stem.
 - **Secondary growth** -- Most seed plants increase their diameter through secondary growth, producing wood and bark. Monocots (and some dicots) have lost this ability, and so do not produce wood. Some monocots can produce a substitute however, as in the palms and agaves.
-

Common questions about the classes.

Having taught in introductory botany for more than five years, I have fielded many questions from students, and present below some of the more common questions and misconceptions. Thanks go to my students for taking an active role in their own education, and asking these questions

Q: Are pine trees monocots or dicots?

A: Pines are **conifers**, and are neither monocots nor dicots. Only flowering plants are considered to be members of these two classes. This question is similar to asking whether a chicken is a monocot or a dicot; it is neither.

Q: Do all dicots produce flowers?

A: Yes, sort of. All dicots and monocots are flowering plants, and so are descended from flower-producing plants. However, the flowers are not always large and showy the way we expect flowers to be. Oaks, maples, and sycamore are all dicot trees, but they do not produce obvious flowers. Grasses and cattails are monocots whose flowers are often overlooked because they do not have sepals or petals.

There are also some flowering plants which flower only rarely. Duckweeds are tiny flowering plants which reproduce and spread primarily by **vegetative growth**; they grow by cellular division, and the resulting cluster will then break apart.

Q: If monocots don't have wood, then what supports palm trees?

A: Palms rely on overlapping leaf bases, thickened enlarged cells, and prop roots to stay up. This strategy is also used by cycads and tree ferns. We hope to have a special exhibit soon expanding

on the architecture of trees which will explain this in more detail.

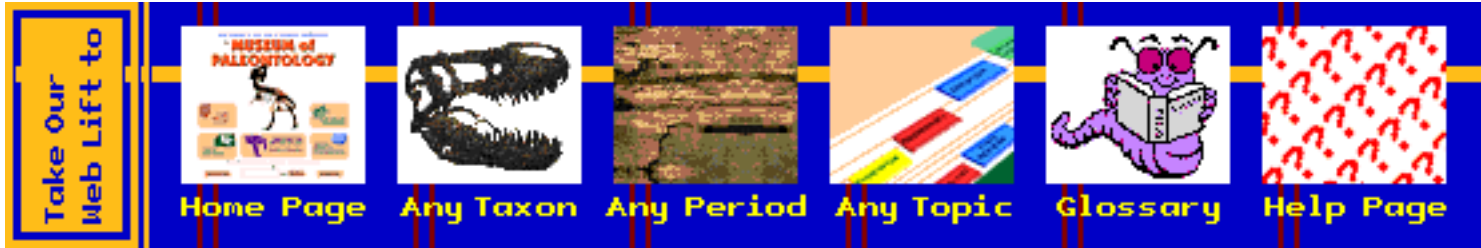

authors ©

Introduction to the Plantae

The green kingdom



The Plantae includes all land plants: mosses, [ferns](#), conifers, [flowering plants](#), and so on—an amazing range of diverse forms. With more than 250,000 species, they are second in size only to the [arthropoda](#).

Plants have been around for a very long time. The plants first appeared in the [Ordovician](#), but did not begin to resemble modern plants until the Late Silurian. By the close of the [Devonian](#), about 360 million years ago, there were a wide variety of shapes and sizes of plants around, including tiny creeping plants and tall forest trees.

The most striking, and important, feature of plants is their green color, the result of a pigment called [chlorophyll](#). Plants use chlorophyll to capture light energy, which fuels the manufacture of food—sugar, starch, and other carbohydrates. Without these food sources, most life on earth would be impossible. There would still be mushrooms and algae, but there would be no fruits, vegetables, grains, or any animals (which ultimately rely on plants for their food too!)

Another important contribution of plants is their shaping of the environment. Think of a place without plants. The only such places on earth are the arctic wastelands, really arid deserts, and the deep ocean. Everywhere else, from the tundra to the rainforest to the desert, is populated by plants. In fact, when we think of a particular landscape, it is the plants which first come to mind. Try to picture a forest without trees, or a prairie without grasses. It is the plants which produce and maintain the terrestrial environment as we know it.

Click on the buttons below to find out more about the Plant Kingdom.

You can navigate deeper into the Plantae groups by selecting Systematics!

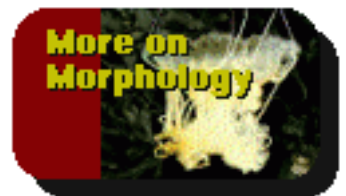
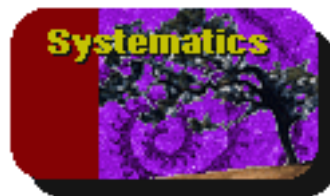
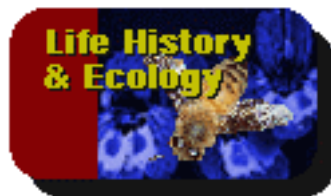
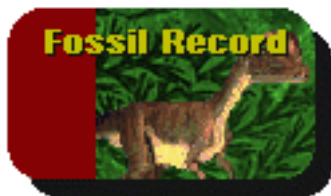

We have an extensive list of [Botanical Collections Catalogs](#) on the Internet, including links to gardens, museums, floras, and image collections.

Visit also the following sites for additional information on paleobotany, plant systematics, and evolution:

- [Botany Online](#) -- A Hypertextbook
- [Land Plants On Line](#)
- [Australian National Botanic Gardens](#)
- [Missouri Botanical Garden](#)
- [International Organisation of Palaeobotany](#)
- [Illinois State Museum: Plants of Mazon Creek](#)
- [UCMP Virtual Paleobotany Laboratory](#)

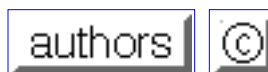
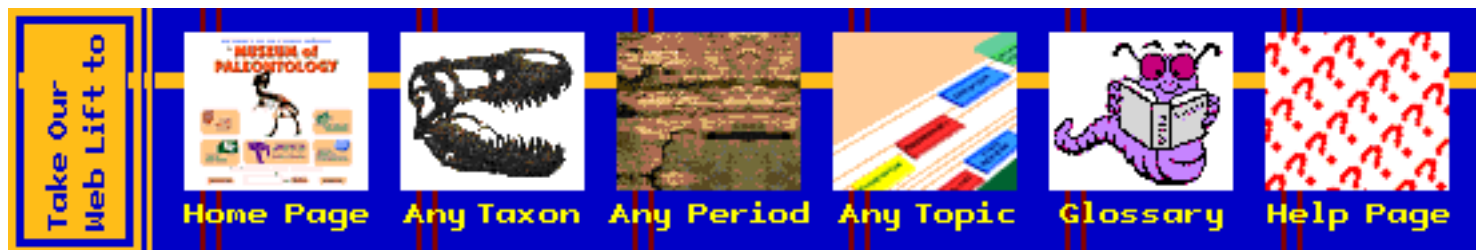

UCMP Glossary: A



| [A](#) | [B](#) | [C](#) | [D](#) | [E](#) | [F](#) | [G](#) | [H](#) | [I](#) | [J](#) | [K](#) | [L](#) | [M](#) | [N](#) | [O](#) | [P](#) | [Q](#) | [R](#) |
[S](#) | [T](#) | [U](#) | [V](#) | [W](#) | [X](#) | [Y](#) | [Z](#) |

abdomen -- Region of the body furthest from the mouth. In [insects](#), the third body region behind the head and thorax.

absorption -- The taking in of water and dissolved minerals and nutrients across cell membranes. Contrast with [ingestion](#).

abyssal plain -- The ocean floor offshore from the [continental margin](#), usually very flat with a slight slope.

accrete -- v. To add terranes (small land masses or pieces of crust) to another, usually larger, land mass.

adaptation -- Change in an organism resulting from natural selection; a structure which is the result of such selection.

adult -- The mature stage of an organism, usually recognized by the organism's attaining the ability to reproduce.

adventitious roots -- A root that grows from somewhere other than the primary root, for example, roots that arise from stems or leaves.

aerobic -- Pertaining to the presence of free oxygen. Aerobic organisms require oxygen for their life processes.

alginate -- component of the cell walls of many [rhodophytes](#) and [kelps](#). Alginates have an affinity for water, and so help to slow desiccation when the algae are exposed to the air; they are commercially important in the production of paper, toothpaste, beer, and frozen foods.

alkaline -- Term pertaining to a highly basic, as opposed to acidic, substance. For example, hydroxide or carbonate of sodium or potassium.

allochthonous -- Refers to something formed elsewhere than its present location. Antonym of [autochthonous](#).

alternation of generations -- Life cycle in which **haploid** and **diploid** generations alternate with each other.

amber -- Fossilization where the organism is entrapped in resin and preserved whole.

ambulacra -- Row of tube feet of an [echinoderm](#).

amino acid -- unit molecule from which proteins are constructed by polymerization.

amniotic egg -- n. An egg that can be laid on land due to the presence of a fluid-filled amniotic sac (**amnion**) that cushions and protects the developing embryo; **amniote**- n. Any of a group of land-dwelling vertebrates that have an amnion during embryonic development, including reptiles, birds, and mammals.

amoeboid -- Having no definite shape to the cell, able to change shape.

amphiesma -- The outer covering of a [dinoflagellate](#), consisting of several membrane layers.

anaerobic -- Pertaining to the absence of free oxygen. Anaerobic organisms do not require oxygen for their life processes, in fact oxygen is toxic to many of them. Most anaerobic organisms are [bacteria](#) or [archaeans](#).

anagenesis -- Evolutionary change along an unbranching lineage; change without speciation.

anapsid -- n. A vertebrate distinguished by a skull with no openings in the side behind the eyes, e.g. turtles.

ancestor -- Any organism, population, or species from which some other organism, population, or species is descended by reproduction.

andesite -- [Igneous volcanic](#) rock, less [mafic](#) than [basalt](#), but more mafic than [dacite](#); rough volcanic equivalent of [diorite](#).

anemophily -- Seed plants which are pollinated by wind are said to be anemophilous.

angiosperm -- n. A group of plants that produce seeds enclosed within an ovary, which may mature into a fruit; [flowering plants](#).

anther -- The pollen producing tip of a **stamen**; part of a flower. [More info?](#)

antheridium -- The organ on a [gametophyte](#) plant which produces the sperm cells.

anthophyte -- A flowering plant, or any of its closest relatives, such as the Bennettitales, Gnetales, or Pentoxylales.

anticline -- A fold of rock layers that is convex upwards. Antonym of [syncline](#).

anus -- End of the digestive tract, or gut, through which waste products of digestion are excreted, as distinct from the mouth.

aperture -- Small opening, for example the opening in the test of a foram.

apical meristem -- Group of cells at the growing tip of a branch or root. It divides cells to create new tissues.

archegonium -- The organ on a [gametophyte](#) plant which produces the egg cell, and nurtures the young [sporophyte](#).

archipelago -- n. A group of islands; an expanse of water with scattered islands.

asexual reproduction -- A type of reproduction involving only one parent that usually produces genetically identical offspring. Asexual reproduction occurs without **meiosis** or **syngamy**, and may happen through budding, by the division of a single cell, or the breakup of an entire organism into two or more parts.

asphalt -- A dark bituminous substance found in natural beds. Residue from petroleum distillation.

ATP -- "adenosine triphosphate". A relatively stable, high energy molecule used to fuel chemical reactions within cells.

autochthonous -- Refers to something formed in its present location. Antonym of [allochthonous](#).

autotroph -- Any organism that is able to manufacture its own food. Most [plants](#) are autotrophs, as are many [protists](#) and [bacteria](#). Contrast with [consumer](#). Autotrophs may be **photoautotrophic**, using light energy to manufacture food, or **chemoautotrophic**, using chemical energy.

Avalonia -- n. A separate plate in the Early Paleozoic consisting of much of Northern Europe, Newfoundland, Nova Scotia, and some coastal parts of New England.

axil -- The angle formed between a leaf stalk and the stem to which it is attached. In flowering plants, buds develop in the axils of leaves.

Last updated:2004-04-20



Introduction to the Uniramia

Beetles and millipedes and flies and centipedes and....



The largest major group of [arthropods](#) is a clade that includes insects, millipedes, centipedes, and their relatives. This group, the Uniramia, was formerly defined to include the [Onychophora](#), which are now considered a separate clade. It is restricted here to include only "true" arthropods with exoskeletons and jointed appendages.

Uniramians have strictly **uniramous** appendages; that is, their legs have only one branch. Most are terrestrial, but some are aquatic for part or all of their life cycles. They make up by far the most common and diverse major clade of arthropods, and in fact make up over three-fourths of all known animal species on the planet -- and probably an even greater proportion of the total number of species, known and unknown. As the paleontologist J. Kukulová-Peck once put it: To a first approximation, every animal is an insect. Think about that the next time you call Orkin Pest Control.

Click on the buttons below to learn more about the Uniramia.

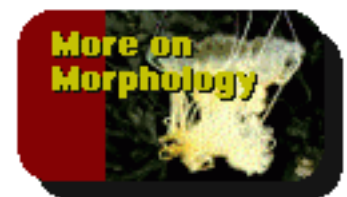
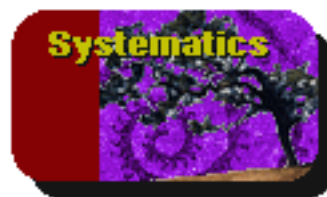

There is an immense amount of entomological information on the WWW. Click [here](#) for a list of

servers pertaining to insects and other uniramians, courtesy of the Department of Entomology at Colorado State University. Or click [here](#) for recipes.

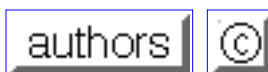
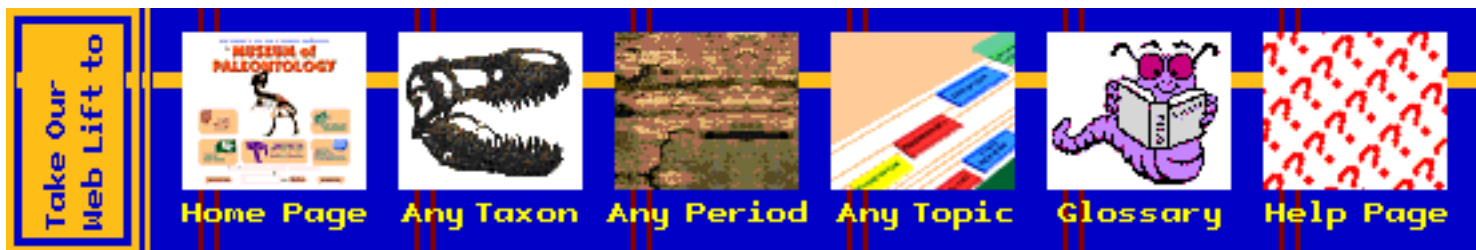

Glumiflorae

Grasses, sedges, rushes, and cattails



The Glumiflorae are the grasses, sedges, rushes, and cattails, and are easily recognized by their “grassy” appearance. Though you might not guess it by looking at them, they are [flowering plants](#), producing numerous tiny flowers without showy petals.

The Glumiflorae is one of the largest and most familiar groups of plants. They are arguably the single-most important group of organisms on the planet today, providing us with corn, rice, wheat, and barley—the four highest grossing crops, as well as sugar cane. Their ecological importance in maintaining soil stability and providing turf has made them a common sight in yards and lawns around the world.

Click on the buttons below to learn more about the Glumiflorae.

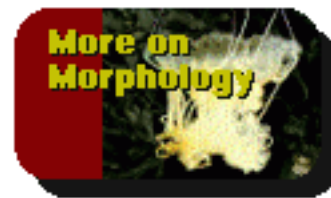

For more information about the Glumiflorae, try the [Texas A&M listings for the Commelinidae](#)
[Glumiflorae pictures](#) at Wisconsin (includes Commelinaceae too).

[Grain Genes](#), UDSA/NAL Plant Genome Research Program

[American Bamboo Society](#)

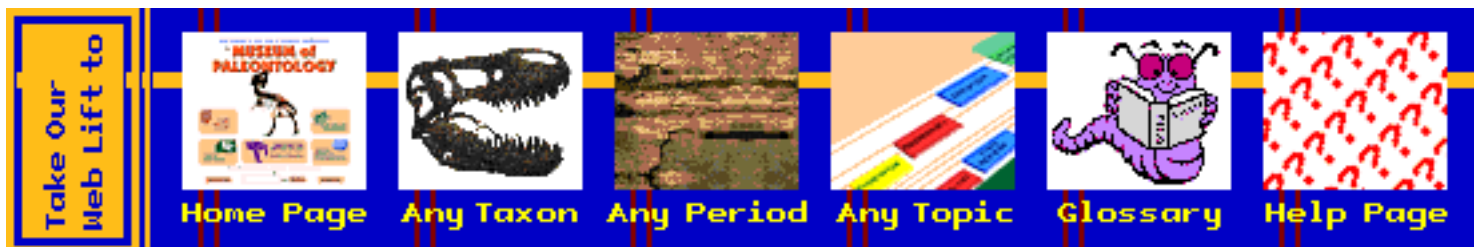

Image of *Avena* by Brian R. Speer.

authors ©

Introduction to the Spermatophytes

The seed plants



The **spermatophytes**, which means "seed plants", are some of the most important organisms on Earth. Life on land as we know it is shaped largely by the activities of seed plants. Soils, forests, and food are three of the most apparent products of this group.

Seed-producing plants are probably the most familiar [plants](#) to most people, unlike mosses, liverworts, horsetails, and most other seedless plants which are overlooked because of their size or inconspicuous appearance. Many seedplants are large or showy. Conifers are seed plants; they include pines, firs, yew, redwood, and many other large trees. The other major group of seed-plants are the [flowering plants](#), including plants whose flowers are showy, but also many plants with reduced flowers, such as the oaks, grasses, and palms.

Click on the buttons below to find out more about the Spermatophytes.

You can navigate deeper into the Spermatophyte groups by selecting Systematics!



For information about collections on plants cataloged on-line, or for images, checklists, and databases, try our list of [Botanical Collection Catalogs](#).

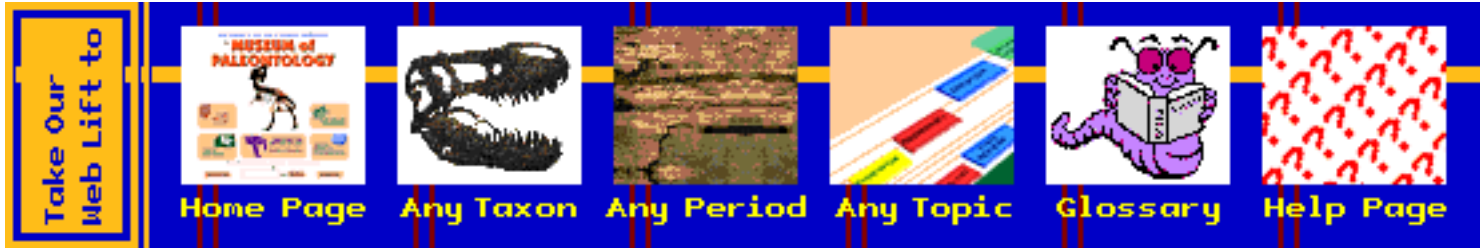

authors



Orchidales

Orchids and their kin



The Orchidales include the orchids and three smaller families. Together, they are one of the largest groups of [plants](#), although they are not of particular ecological or economic importance. *Vanilla* is cultivated for the strong flavor of its fruits; the little black specks in vanilla ice cream are actually the seeds from the orchid. Many kinds of orchids are cultivated and bred for their delicate and often bizarre flowers. The orchid pictured at right above is *Phalaenopsis McLellans*, a commonly cultivated genus. On the left is *Epipactis gigantea*, a native California orchid.

Unlike their closest relatives, most orchids have only a single large stamen attached to the pistil to form the **gynostemium**, visible in the center of an orchid flower. The flowers are bilaterally symmetrical, a necessity for reliable pollination by [bees](#). Many tropical species of orchid will rely on a single species of euglossine bee to pollinate them, and the bee will visit only that particular species of orchid which its kind pollinates. Because of this, the orchid must ensure that its pollen is properly delivered. This is most often achieved by gluing the whole supply of pollen to the visiting bee in a mass called the **pollinia**. When the bee visits another orchid of the same species, thousands of pollen grains are delivered, allowing the plant to mature thousands of tiny dust-like seeds.

The first orchids were large terrestrial plants, but like bromeliads, orchids took to the trees, where they have diversified to become the largest family of flowering plants. They are able to survive in the treetops in part because many species form **mycorrhizal** associations with [fungi](#). The fungi increase the area over which the orchid can acquire nutrients and water, while the orchid provides food to the fungus which it makes by photosynthesis.

Because orchids are primarily tropical epiphytes and small herbs, they do not have a fossil record. However, like palms and some members of the Iridales, they have **plicate** (corrugated) leaves, and these leaf forms are among the earliest known fossil [monocots](#).

The Orchidales may be divided into the following families:

Burmanniaceae

Thismiaceae

Corsiaceae

Orchidaceae - the orchids

Apostasioideae - *Apostasia* and *Neuwiedia*

Cypripedoideae - lady's slippers (4 genera)

Orchidoideae - most orchids (750 genera)

The first three families are sometimes put into another order, the **Burmnniales**, but are still considered the closest relatives of the Orchidaceae, so this separation is largely a matter of opinion. The Orchidales have traditionally been considered the "pinnacle" of monocot evolution, and so are listed last in many floras. This view does not reflect any biologically meaningful information, and so has been abandoned.

For more information about the Orchidales, try [Steve Saunders' exhaustive WWW orchid resource list](#), the [Orchidales Resources List](#) at Texas A&M, or the DELTA descriptions for the [Burmanniaceae](#), [Corsiaceae](#), and the [Orchidaceae](#)

Extensive horticultural information is available from [The Orchid House](#) in Ontario, Canada.

For images of Orchids on the Web, visit [Texas A&M Botany](#), and the [University of Wisconsin](#).
View images of [Malagasy Orchidaceae](#) at the Missouri Botanical Garden

And Gerry Carr has the only [picture of *Burmannia*](#) I've seen on the web.



Orchid images courtesy the [Jepson Herbarium](#), and used with permission.

Sources:

Robert L. Dressler. 1981. *The Orchids: Natural History and Classification*, 332 pp. Harvard University Press, Cambridge.

R. M. T. Dahlgren and H. T. Clifford. 1982. *The Monocotyledons: A comparative Study*, 378 pp. Academic Press, London and New York.

UCMP Glossary: P



| [A](#) | [B](#) | [C](#) | [D](#) | [E](#) | [F](#) | [G](#) | [H](#) | [I](#) | [J](#) | [K](#) | [L](#) | [M](#) | [N](#) | [O](#) | **P** | [Q](#) | [R](#) |
[S](#) | [T](#) | [U](#) | [V](#) | [W](#) | [X](#) | [Y](#) | [Z](#) |

Paleo-Tethys Ocean -- n. A large ocean that originated between eastern Gondwana, Siberia, Kazakhstan, and Baltica in the Ordovician and finally closed in the Jurassic; replaced by the Tethys Ocean as eastern Pangea was assembled.

paleoherb -- Any member of a group of basal [flowering herbs](#) which may be the closest relatives of the [monocots](#). They include the water lilies, Piperales, and Aristolochiales.

paleosol -- Soil horizon from the geologic past.

Pangea -- n. A supercontinent that existed from the the end of the Permian to the Jurassic, assembled from large continents like Euramerica, Gondwana, and Siberia, as well as smaller landmasses like the Cathaysian and Cimmerian terranes; Greek for "all lands."

Pannotia -- n. A supercontinent that existed in the Late Precambrian and gave rise to the continents of Gondwana, Laurentia, Siberia, and Baltica in the Cambrian.

Panthalassic Ocean -- n. A vast ocean that existed from the Late Precambrian to the Jurassic, circling the globe and connecting to smaller oceans that developed throughout the Phanerozoic; also known as the **Panthalassa**.

papilla(e) -- Cellular outgrowths. These look like little bumps or fingers on the surface of cells.

paraphyletic -- Term applied to a group of organisms which includes the most recent common ancestor of all of its members, but not all of the descendants of that most recent common ancestor. [More?](#)

parapodia -- A sort of "false foot" formed by extension of the body cavity. Polychaetes and some insect larvae have parapodia in addition to their legs, and these provide extra help in locomotion.

parasite -- n. An organism that lives on or within a host (another organism); it obtains nutrients from the host without benefiting or killing (although it may damage) the host; **parasitic**- adj.; **parasitism**- n. a type of symbiotic relationship in which one organism benefits and the other does not.

parenchyma -- A generalized cell or tissue in a plant. These cells may manufacture or store food, and can often divide or differentiate into other kinds of cells.

parsimony -- Refers to a rule used to choose among possible cladograms, which states that the cladogram implying the least number of changes in character states is the best.

pathogenic -- Organism which causes a disease within another organism.

peat -- n. A deposit of partly decayed plant remains in a very wet environment; marsh or swamp deposit of plant remains containing more than 50 percent carbon.

pedipalps -- The second pair of appendages of [cheliceromorphs](#). In many arachnids, such as spiders, the pedipalps are enlarged in the male and used for copulation.

pelagic -- Pelagic organisms swim through the ocean, and may rise to the surface, or sink to the bottom. They are not confined to live on the bottom as benthic organisms do.

peptidoglycan -- carbohydrate polymer cross-linked by proteins. It is found in the cell wall of Gram positive [bacteria](#), where it stains with the dye crystal-violet.

perennial -- A plant which continues to grow after it has reproduced, usually meaning that it lives for several years.

perianth -- The **sepals** and **petals** of a flower are together called the perianth; literally "around the anthers". [More info?](#)

peridinin -- carotenoid pigment found in dinoflagellates.

periphyton -- Dense strands of algal growth that cover the water surface between the emergent aquatic plants. [Spirogyra](#) is commonly responsible for this growth.

peristome -- A set of cells or cell parts which surround the opening of a moss sporangium. In many mosses, they are sensitive to humidity, and will alter their shape to aid in spore dispersal.

permineralization -- Fossilization process that occurs when minerals, carried by ground water, enter and harden in the pores of an organism's structures.

petal -- One of the outer appendages of a flower, located between the outer **sepals** and the **stamens**. Petals often display bright colors that serve to attract pollinators. [More info?](#)

Phanerozoic -- n. The geologic eon that includes the interval of time from approximately 543 million years ago to the present, comprising the Paleozoic, Mesozoic, and Cenozoic eras.

pharyngeal slits -- Characteristic of [chordates](#), pharyngeal slits are openings through which water is taken into the pharynx, or throat. In primitive chordates the pharyngeal slits are used to strain water and filter out food particles; in fishes they are modified for respiration. Most terrestrial vertebrates have pharyngeal slits only in the embryonic stage.

pharynx -- Cavity in the digestive tract just past the mouth itself. May be muscularized for sucking or swallowing in various animals.

phloem -- Nutrient-conducting tissue of vascular plants.

phosphate -- an ion consisting of a phosphorus atom and four oxygen atoms. Among other things, it is used in the construction of nucleic acids.

photic zone -- Region of the ocean through which light penetrates; and the place where photosynthetic marine organisms live.

photosynthesis -- biochemical process in which light energy is absorbed by chlorophyll, and is used to fuel the building of sugar molecules.

phragmoplast -- The cell plate formed during cell division.

phycocyanin -- blue, water-soluble pigment found in the [cyanobacteria](#) and the [red algae](#).

phycoerythrin -- red, water-soluble pigment found in the cyanobacteria and red algae.

phylogenetics -- Field of biology that deals with the relationships between organisms. It includes the discovery of these relationships, and the study of the causes behind this pattern. [More?](#)

phylogeny -- The evolutionary relationships among organisms; the patterns of lineage branching produced by the true evolutionary history of the organisms being considered.

phylum -- n. A category in the hierarchy of animal classification between class and kingdom; **phyla**- pl.

phytomelanin -- a papery "sooty" black layer over the seed of plants in the [Asparagales](#), which includes agaves, aloes, onions and hyacinths. It is an important character for defining the group.

phytoplankton -- Tiny, free-floating, photosynthetic organisms in aquatic systems. They include [diatoms](#), [desmids](#), and [dinoflagellates](#).

pigment -- any colorful compound, used by living things to absorb or block sunlight, and in sexual displays. [More info?](#)

pillow lava -- [Lava](#) extruded beneath water characterised by [pillow-type shapes](#).

pinnately compound -- Leaves which are divided up like a feather are said to be pinnately compound.

pistil -- The central set of organs in a flower; it is composed of one or more **carpels**. [More info?](#)

pith -- To severely damage the brain of a frog, also any central region of **parenchyma** tissue within a plant stem.

pits -- Thin regions of the cell wall in xylem conducting cells. Their structure is an important characteristic for recognizing different kinds of wood.

placenta -- n. In mammals, a tissue formed within the uterus through which nutrients are passed from the mother to the embryo (and later the fetus) and its wastes are removed; **placental**- n. (adj.) A mammal whose young form a placenta as they develop in the mother's uterus.

plankton -- n. Very small, free-floating organisms of the ocean or other aquatic systems, including phytoplankton, which produce their own nutrients through photosynthesis, or zooplankton, which get their nutrients from organisms.

plasma membrane -- Outer membrane of a cell, sometimes called the cell membrane. The term plasma membrane is used more frequently when discussing prokaryotes.

plasmid -- Circular loop of DNA in prokaryotes. Eukaryotic DNA is organized into chromosomes.

plasmodesmata -- Cytoplasmic connections between neighboring cells in plant tissues.

plasmogamy -- A process of fusion of the cytoplasm of two cells; the first step in **syngamy**.

plastid -- Any of several pigmented cytoplasmic organelles found in plant cells and other organisms, having various physiological functions, such as the synthesis and storage of food.

plate -- n. Rigid parts of the Earth's [crust](#) and part of the Earth's upper [mantle](#) that move and adjoin each other along zones of seismic activity. The theory that the crust and part of the mantle are divided into plates that interact with each other causing seismic and tectonic activity is called **plate tectonics**.

platyspermic -- Having seeds which are flattened and disc-like. Contrast with **radiospermic**.

plesiomorphy -- A primitive character state for the taxa under consideration.

pleurae -- In trilobites and other arthropods, pleurae are elongated flat outgrowths from each body segment, that overlie and protect the appendages.

plicate -- Folded like a paper fan, as in the leaves of palms, cyclanthoids, and some orchids.

pluton -- n. Any body of igneous rock that solidified below the earth's surface.

plutonic -- Applies to igneous rocks formed beneath the surface of the Earth; typically with large crystals due to the slowness of cooling. Synonym of [intrusive](#). Antonym of [volcanic](#).

polarity of characters -- The states of characters used in a cladistic analysis, either original or derived. Original characters are those acquired by an ancestor deeper in the phylogeny than the most recent common ancestor of the taxa under consideration. Derived characters are those acquired by the most recent common ancestor of the taxa under consideration.

pollen -- The **microspore** of [seed plants](#).

pollen tube -- In [seed plants](#), the extension of the male gametophyte as it emerges from the pollen grain in search of the female gametophyte.

pollination -- Process of transferring the pollen from its place of production to the place where the egg cell is produced. This may be accomplished by the use of wind, water, [insects](#), [birds](#), [bats](#), or other means. Pollination is usually followed by **fertilization**, in which sperm are released from the pollen grain to unite with the egg cell.

pollinator -- Animal which carries pollen from one [seed plant](#) to another, unwittingly aiding the plant in its reproduction. Common pollinators include [insects](#), especially bees, butterflies, and moths, [birds](#), and [bats](#).

pollinia -- A mass of fused pollen produced by many [orchids](#).

polymer -- a large molecule constructed from many smaller identical units. These include proteins, nucleic acids, and starches.

polyphyletic -- Term applied to a group of organisms which does not include the most recent common ancestor of those organisms; the ancestor does not possess the character shared by members of the group. [More?](#)

pore -- Any opening into or through a tissue or body structure.

predator -- Organism which hunts and eats other organisms. This includes both carnivores, which eat animals, and herbivores, which eat plants.

prey -- Organism hunted and eaten by a predator.

primitive -- Describes a character state that is present in the common ancestor of a clade. A primitive character state is inferred to be the original condition of that character within the clade under consideration. For example, "presence of hair" is a primitive character state for all mammals, whereas the "hairlessness" of whales is a derived state for one subclade within the Mammalia.

proboscis -- Elongated organ, usually associated with the mouth. The proboscis is an important feeding appendage in [echiurans](#).

producer -- Any organism which brings energy into an ecosystem from inorganic sources. Most [plants](#) and many protists are producers.

prokaryotic -- Literally "before the nucleus", the term applies to all [bacteria](#) and [archaea](#). Prokaryotic cells have no internal membranes or cytoskeleton. Their DNA is circular, not linear.

protein -- class of biochemical compounds constructed from amino acids. Proteins may be structural, such as those that make up hair and cartilage, or they may be reactive, such as the enzymes.

proteinaceous -- describes any structure which is composed of protein.

proteoglycan --

protoplasm -- All the contents of a cell, including the nucleus. (see: cytoplasm)

protostele -- When a plant's vascular tissue develops in a solid central bundle, it is said to have a protostele. See also siphonostele and eustele.

pseudoelaters -- Moisture-sensitive cells produced in the sporangium of [hornworts](#).

pseudoextinction -- The apparent disappearance of a taxon. In cases of pseudoextinction, this disappearance is not due to the death of all members, but the evolution of novel features in one or more lineages, so that the new clades are not recognized as belonging to the paraphyletic ancestral group, whose members have ceased to exist. The Dinosauria, if defined so as to exclude the birds, is an example of a group that has undergone pseudoextinction.

pseudopodia -- Fingerlike extensions from an amoeboid cell; literally "false feet".

pteridophyte -- Plant in which the **sporophyte** generation is the larger phase and in which the **gametophyte** lives an existence independent of its parent sporophyte. Pteridophytes are almost all vascular plants, and include the [lycophytes](#), [trimerophytes](#), [sphenophytes](#), and ferns.

pteridosperm -- An extinct group of [seed plants](#) which bore fern-like leaves.

punctuated equilibrium -- A model of evolution in which change occurs in relatively rapid bursts, followed by longer periods of stasis.

pupa -- In metamorphosing insects, a stage between the **larva** and adult during which the organism undergoes major developmental changes.

pycnoxylic -- Wood in which there is little or no **parenchyma** tissue among the xylem is called pycnoxylic. Conifers and [flowering plants](#) have pycnoxylic wood. Contrast with [mannoxylic](#).

pygidium -- In trilobites, the posterior division of the body, formed by fusion of the **telson** with one or more posterior **pleurae**.

Last updated:2004-04-20



Introduction to the Lycophyta

Club mosses and Scale trees

The lycophytes are a small and inconspicuous group of [plants](#) today, but in the Carboniferous some lycophytes were forest-forming trees more than 35 meters tall. Lycophytes are the oldest extant group of vascular plants, and dominated major habitats for 40 million years.

The club mosses (Lycopodiales) are usually evergreen, and have been used as Christmas decorations, though their flammable spores and increasing rarity has made this illegal in some states. Other lycophytes, such as *Selaginella*, may form extensive carpets in the understory of wet tropical forests.

The most significant feature of lycophytes are **microphylls**, a kind of leaf which has arisen and evolved independently from the leaves of other vascular plants. The microphyll has only a single unbranched strand of vascular tissue, or **vein**, whereas **megaphylls**, found in other plants with leaves, have multiple veins, usually branching one or more times within the leaf.

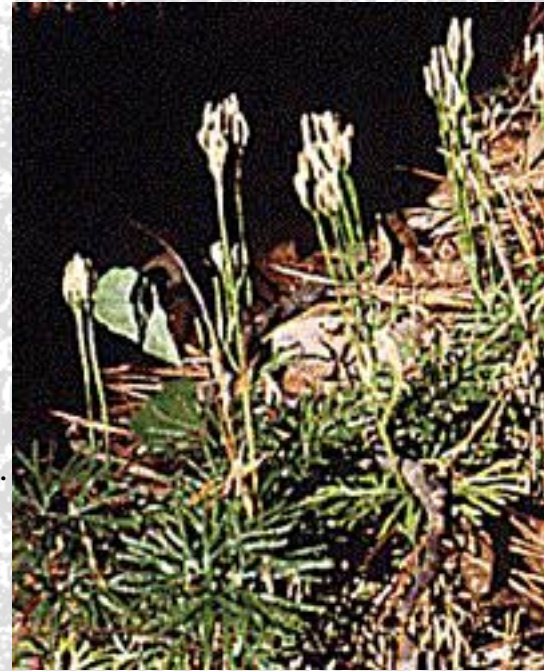

Click on the buttons below to learn more about the Lycophyta.

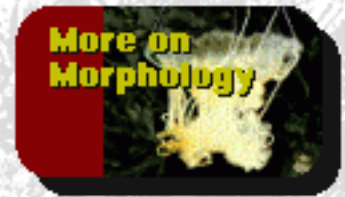
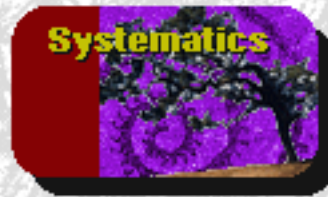

The University of Wisconsin offers images of lycophytes used in their [General Botany](#) courses.

Or peruse Dr. John Clayton's article on [New Zealand native plants](#) for use in aquaria, including *Isoetes*.

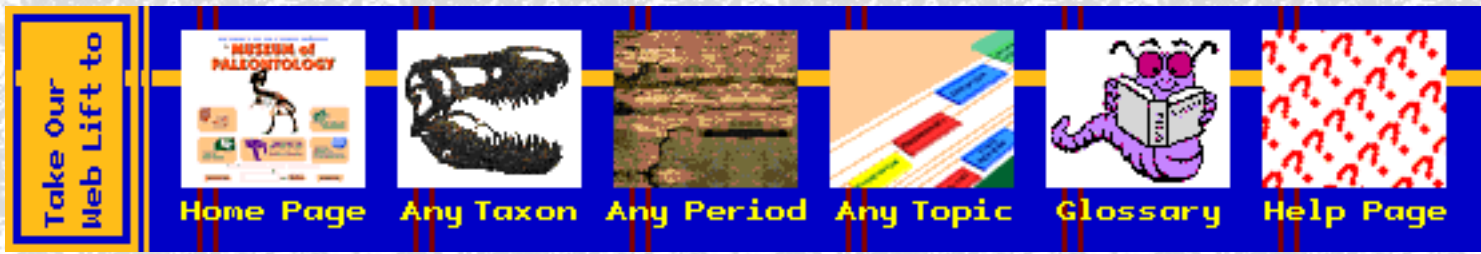

authors ©

Introduction to the Fungi

Of athlete's foot, champignons, and beer. . .



The Kingdom Fungi includes some of the most important organisms, both in terms of their ecological and economic roles. By breaking down dead organic material, they continue the cycle of nutrients through ecosystems. In addition, most vascular [plants](#) could not grow without the symbiotic fungi, or **mycorrhizae**, that inhabit their roots and supply essential nutrients. Other fungi provide numerous drugs (such as penicillin and other antibiotics), foods like mushrooms, truffles and morels, and the bubbles in bread, champagne, and beer.

Fungi also cause a number of plant and animal diseases: in humans, ringworm, athlete's foot, and several more serious diseases are caused by fungi. Because fungi are more chemically and genetically similar to animals than other organisms, this makes fungal diseases very difficult to treat. Plant diseases caused by fungi include rusts, smuts, and leaf, root, and stem rots, and may cause severe damage to crops. However, a number of fungi, in particular the yeasts, are important "model organisms" for studying problems in genetics and molecular biology.

Click on the buttons below to learn more about the Fungi.

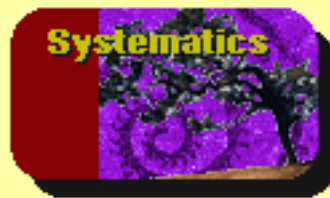

For more about fungus:

Try the [Fun Facts About Fungi](#) page at the University of Michigan or visit [Mykoweb](#), an on-line mushroom museum with many nice photos and links. For those with some biological training, try the excellent home page for the [Introductory Mycology](#) course taught by Joseph Spatafora.

We don't have a large exhibit on fungi. Until we do, may we suggest that you try the [images of fungi](#) offered by Tom Volk through the University of Wisconsin-La Crosse. Or consult the extensive listings of the [WWW Virtual Library of Mycology](#) to access links to on-line mycological information. The [WWW Virtual Library Yeast Page](#) provides links to sources of information on yeasts, in particular to sources dealing with genetics and molecular biology.

We also maintain a list of on-line [Mycological and Lichenological Collection Catalogs](#) which you can search for more information.

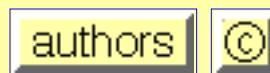
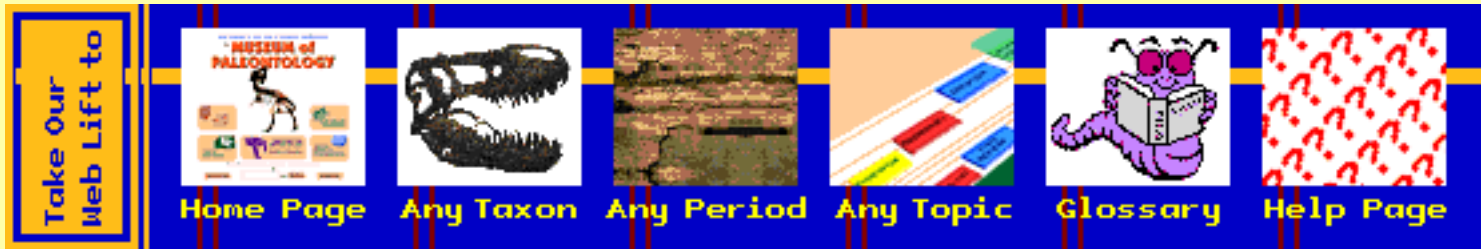

Fossil Record

Life History
& Ecology

Systematics

More on
Morphology

Fungi: Life History and Ecology

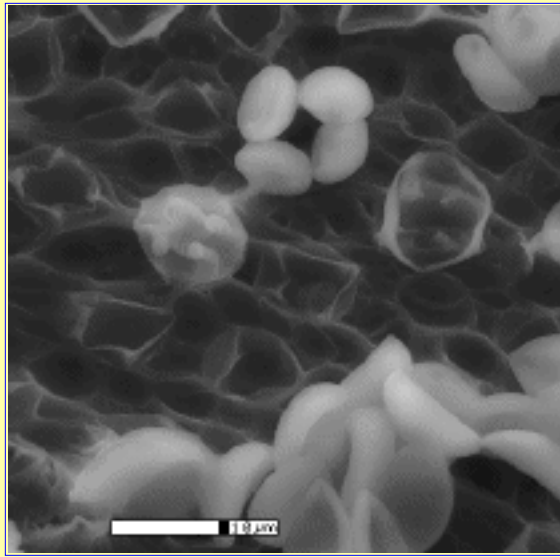

*This photograph taken using the UCMPE
Environmental Scanning Electron Microscope*

Fungi exist primarily as filamentous dikaryotic organisms.

As part of their life cycle, fungi produce spores. In this electron micrograph of a mushroom gill, the four spores produced by meiosis (seen in the center of this picture) are carried on a clublike **sporangium** (visible to the left and right). From these spores, haploid **hyphae** grow and ramify, and may give rise to asexual sporangia, special hyphae which produce spores without meiosis.

The sexual phase is begun when haploid hyphae from two different fungal organisms meet and fuse. When this occurs, the cytoplasm from the two cells fuses, but the nuclei remain separate and distinct. The single hypha produced by fusion typically has two nuclei per "cell", and is known as a **dikaryon**, meaning "two nuclei". The dikaryon may live and grow for years, and some are thought to be many centuries old. Eventually, the dikaryon forms sexual sporangia in which the nuclei fuse into one, which then undergoes meiosis to form haploid spores, and the cycle is repeated.

Some fungi, especially the [chytrids](#) and zygomycetes, have a life cycle more like that found in many [protists](#). The organism is haploid, and has no diploid phase, except for the sexual sporangium. A number of fungi have lost the capacity for sexual reproduction, and reproduce by asexual spores or by vegetative growth only. These fungi are referred to as Fungi Imperfecti, and

include, among other members, the athlete's foot and the fungus in bleu cheese. Other fungi, such as the yeasts, primarily reproduce through asexual **fission**, or by **fragmentation** -- breaking apart, with each of the pieces growing into a new organism.

Fungi are heterotrophic.

Fungi are not able to ingest their food like animals do, nor can they manufacture their own food the way plants do. Instead, fungi feed by **absorption** of nutrients from the environment around them. They accomplish this by growing through and within the **substrate** on which they are feeding. Numerous hyphae network through the wood, cheese, soil, or flesh from which they are growing. The hyphae secrete digestive enzymes which break down the substrate, making it easier for the fungus to absorb the nutrients which the substrate contains.

This filamentous growth means that the fungus is in intimate contact with its surroundings; it has a very large surface area compared to its volume. While this makes diffusion of nutrients into the hyphae easier, it also makes the fungus susceptible to desiccation and ion imbalance. But usually this is not a problem, since the fungus is growing within a moist substrate.

Most fungi are **saprophytes**, feeding on dead or decaying material. This helps to remove leaf litter and other debris that would otherwise accumulate on the ground. Nutrients absorbed by the fungus then become available for other organisms which may eat fungi. A very few fungi actively capture prey, such as *Arthrotrichum* which snares nematodes on which it feeds. Many fungi are **parasitic**, feeding on living organisms without killing them. Ergot, corn smut, Dutch elm disease, and ringworm are all diseases caused by parasitic fungi.

Mycorrhizae are a symbiotic relationship between fungi and plants.

Most [plants](#) rely on a symbiotic fungus to aid them in acquiring water and nutrients from the soil. The specialized roots which the plants grow and the fungus which inhabits them are together known as **mycorrhizae**, or "fungal roots". The fungus, with its large surface area, is able to soak up water and nutrients over a large area and provide them to the plant. In return, the plant provides energy-rich sugars manufactured through photosynthesis. Examples of mycorrhizal fungi include truffles and *Auricularia*, the mushroom which flavors sweet-and-sour soup.

In some cases, such as the vanilla [orchid](#) and many other orchids, the young plant cannot establish itself at all without the aid of its fungal partner. In liverworts, mosses, [lycophytes](#), ferns, conifers, and [flowering plants](#), fungi form a symbiotic relationship with the plant. Because mycorrhizal associations are found in so many plants, it is thought that they may have been an essential element in the transition of plants onto the land.

More information on one ecologically and economically important group of fungi, the Uredinales or rust fungi, is available through the [Arthur Herbarium](#) at [Purdue University](#).

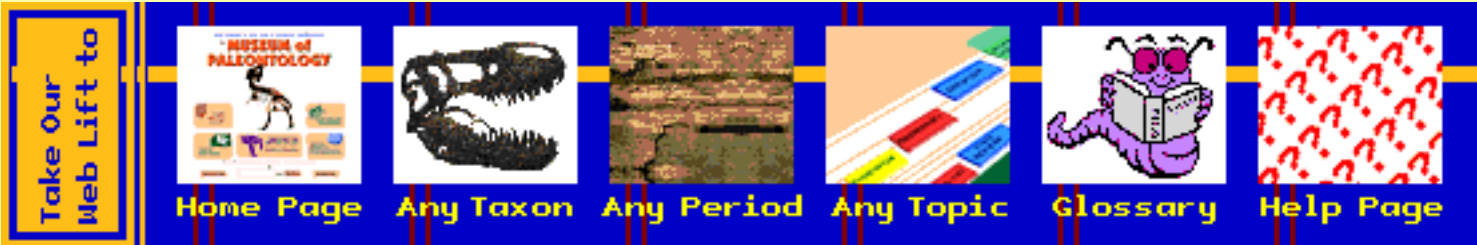

authors



Introduction to the Liliopsida

The Monocots

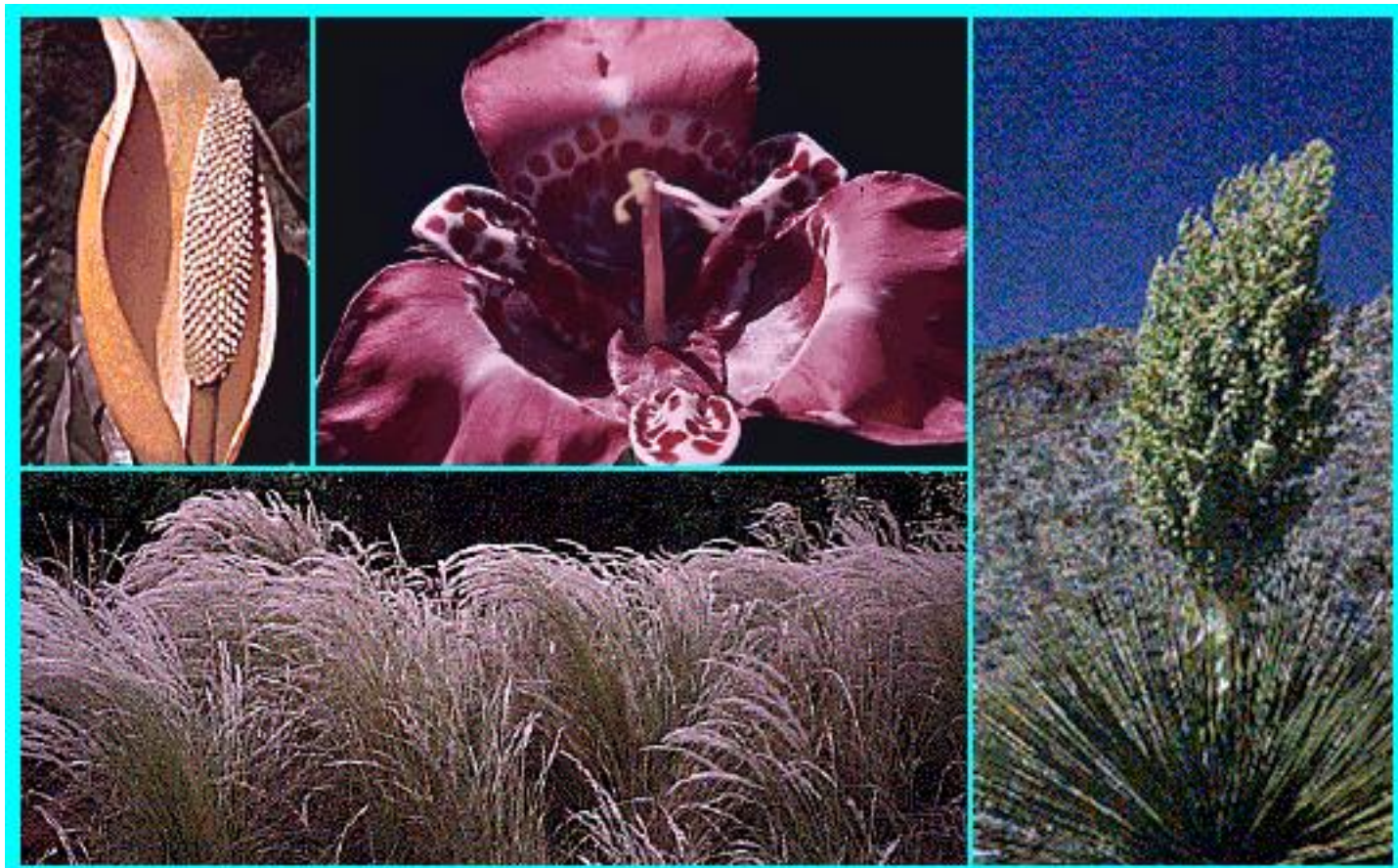

The Monocotyledonae comprise one-quarter of all [flowering plant](#) species. They include some of the largest and most familiar groups of plants, including lilies, [orchids](#), [agaves](#), palms, and [grasses](#). Though often described as having a stereotype morphology, the monocots are actually quite diverse, ranging from tiny duckweeds to large palms and climbing vines.

Economically, monocots are perhaps the most important organisms on earth. Our four most important foods -- corn, rice, wheat, and barley -- all come from monocots. Bamboo and palms are a primary source of building materials and fibers in many tropical countries. Sugar cane, pineapples, dates, bananas, and many of our familiar tropical fruits also come from monocots.

Click on the buttons below to learn more about the Monocots.

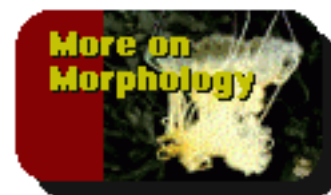
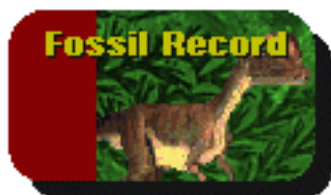

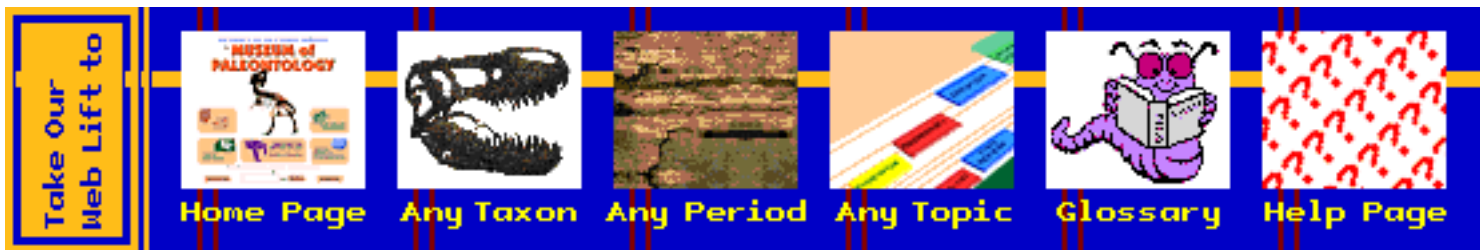
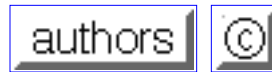

Photo of pampas grass by Brian R. Speer; all others courtesy the [Jepson Herbarium](#), and used with permission.



Asparagales

The Asparagales include nearly 5000 species of agaves, aloes, onions, day-lilies and related plants. As such, they are one of the most structurally diverse groups of [monocots](#), ranging from small herbs to flowering Agaves that may reach more than ten meters in height. They provide us with asparagus, onion, and garlic, as well as many garden plants, such as daffodils. Agave was of particular importance to the Aztecs, supplying fibers for instruments and paper, as well as the drink now called tequila.



The picture above shows some of the structural and taxonomic diversity in the Asparagales. The plants shown are (clockwise, from upper left): *Aloe saponaria* growing in La Jolla, California; *Amaryllis*, a common ornamental; *Dracaena draco*, a sizeable tree on the Canary Islands; *Triteilia*, a relative of the onion; and *Maianthemum dilatatum*, an understory herb growing in northern California. All pictures courtesy of the Jepson Herbarium.

Most members of the Asparagales produce a tight cluster of leaves at the base of the plant or on top of a squat trunk; from the top of this, a long stalk develops bearing the flowers. A few members, such as Asparagus and Solomon's seal have leaves attached along the stem.

A permineralized fossil plant called *Protoyucca* is known from the [Miocene](#) of northwestern Nevada. Its vascular structure and secondary growth are not unlike those found in the Joshua tree (*Yucca brevifolia*).

The Asparagales have been lumped into the [Liliales](#) since the beginning of this century, though they share no synapomorphies with that group. They have recently been removed again, and are now distinguished (mostly) by the presence of a layer of **phytomelanin** around their seeds. This appears as a papery "sooty" black layer over the seed.

For more information about the Asparagales, try the DELTA descriptions for the [Agavaceae](#), [Alliaceae](#), [Amaryllidaceae](#), [Anthericaceae](#), [Aphyllanthaceae](#), [Asparagaceae](#), [Asphodelaceae](#), [Asteliaceae](#), [Blandfordiaceae](#), [Calectasiaceae](#), [Convallariaceae](#), [Cyanastraceae](#), [Dasypogonaceae](#), [Doryanthaceae](#), [Dracaenaceae](#), [Eriospermaceae](#), [Hanguanaceae](#), [Hemerocallidaceae](#), [Herreriaceae](#), [Hostaceae](#), [Hyacinthaceae](#), [Hypoxidaceae](#), [Ixoliriaceae](#), [Luzuriagaceae](#), [Nolinaceae](#), [Philesiaceae](#), [Phormiaceae](#), [Ruscaceae](#), [Tecophilaeaceae](#), [Velloziaceae](#), and the [Xanthorrhoeaceae](#)

Learn about the [relationships of Agavaceae](#) and other closely allied families. You can view images of [Agavaceae](#) at Texas A&M Botany. They also have images of the [Amaryllidaceae and Hemerocallidaceae](#) listed under the Liliaceae. View images of [Malagasy Dracaenaceae](#) at the Missouri Botanical Garden

Check out the information about [Yucca](#) and other vegetation of the [Eastern Mojave](#) provided by [Tom Schweich](#) or scan through the visitor information for [Joshua Tree National Monument](#) or try [this page](#) for information about the Park.

Horticultural information is available from the [Friends of the Daylily \(Hemerocallis\)](#), or at [The Haworthia Page](#) maintained by the [British Cactus and Succulent Society](#)

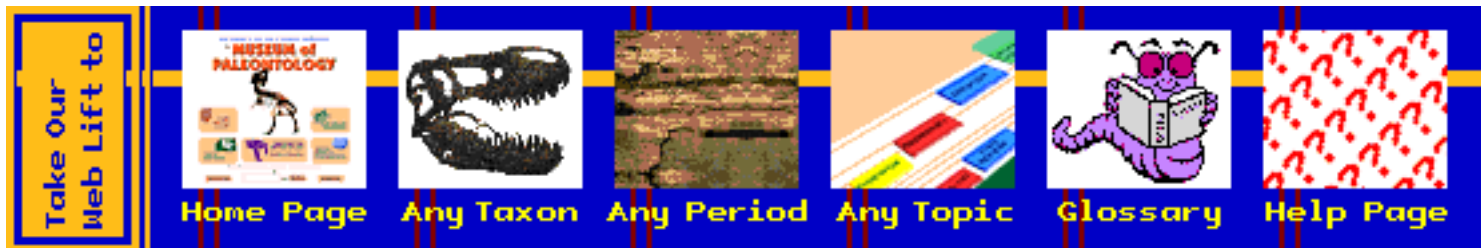

Sources:

R. M. T. Dahlgren and H. T. Clifford. 1982. *The Monocotyledons: A comparative Study*, 378 pp. Academic Press, London and New York.

W. D. Tidwell and L. R. Parker. 1990. *Protoyucca shadishii* gen. et sp. nov., and arborescent monocotyledon with secondary growth from the Middle Miocene of northwestern Nevada, USA. *Rev. Palaeobot. Palynol.* 62: 79-95.

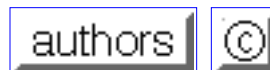

Introduction to the Aves

The Birds



The vertebrate class Aves includes the birds, an extremely distinctive and successful clade, with an estimated 9000 species worldwide, including the snowy owl pictured here. Although descended from the [dinosaurs](#), birds have evolved remarkable specializations for flight: a unique "one-way" breathing system, light yet strong hollow bones, a skeleton in which many bones are fused or lost, powerful flight muscles, and -- most importantly -- feathers.

Click on the buttons below to learn more about birds.

You can navigate deeper into the birds by selecting "Systematics"!

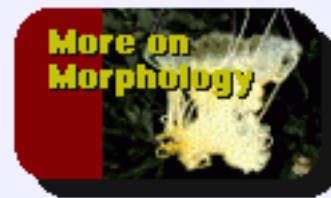
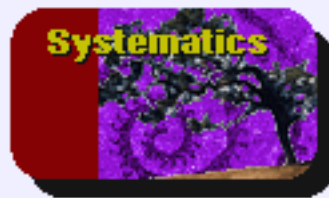

UCMP Special Exhibit: [Vertebrate Flight](#)

Visit our series of pages on the wonder of flight in vertebrates, including a discussion of [avian flight](#).



Interested in birds? There are several good ornithology sites on the Web. Check out the [California State University BioWeb](#) listing of ornithological sites, or the list of [Electronic Resources on Ornithology](#). All of these have extensive lists of links to Web sites. [Birding on the Web](#) is also an excellent site.

We also maintain our own list of [On-line Ornithology Collections and Resources](#).

For a remarkable set of images of birds in flight, check out [How Birds Fly](#). Serious avian aficionados will be interested in the great multivolume reference book, [The Birds of North America](#).

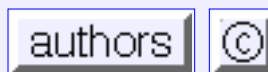

Chiroptera

Night fliers

Small and furry, bats are the only [mammals](#) to have achieved powered flight. Their arms are spindly, with membranes stretched between the fingers on each hand. This arrangement makes their wings quite different from those of [birds](#) and [pterosaurs](#), and in fact the bats have evolved flight quite independently.

Most bats also differ from other flying animals in their reliance on hearing for navigation. While birds have large eyes and keen sight, many bats have a poor sense of vision, and must rely on hearing sonar echos to find their way around. This might make bats easy prey for strong fliers with keen sight, but they get around this problem because they are **nocturnal**, coming out at night, or by living in tropical forests, where the light is dim and the obstacles are many.

Despite their resemblance to [rodents](#), bats are not closely related to mice at all. Though their exact placement is still uncertain, there is recent evidence that they may be more closely related to the [primates](#). Whatever their relationships, bats are among the most successful groups of mammals: there are nearly 1,000 species of bats around the world, making up about one quarter of all mammal species.



Click on the buttons below to learn more about the Chiroptera.

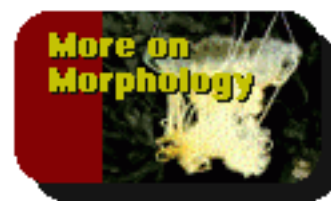
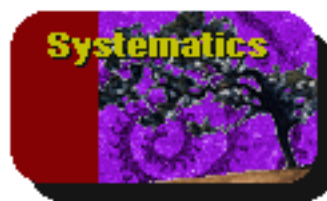
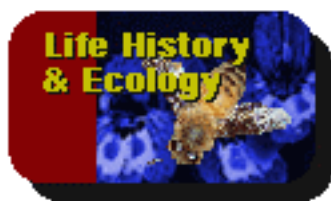
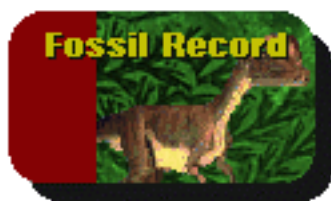

UCMP Special Exhibit: [Vertebrate Flight](#)

Want to learn more about flight? What do a pterosaur, a bat, and a bird have in common? How do we know they evolved flight independently? Find out for yourself!



To learn much more about bats -- from their scientific names to how to keep them out of your belfry -- visit the informative Website maintained by [Bat Conservation International](#). Hear an archived radio broadcast about bats, read fascinating background information, or follow bat-related links from the [Watershed Radio](#) Website. Or try this [bat conservation and information page](#) (maintained in Germany) for links to many more on-line sources of bat information.



Introduction to the Trimerophytes

A number of fossil vascular [plants](#) of the [Devonian](#) are superficially similar to the "rhyniophytes" but show some features not found in the rhyniophytes. These plants are grouped together in the Trimerophytophyta, the "trimerophytes." This group is almost certainly **paraphyletic**; that is, it does not include all the descendants of a common ancestor. Nonetheless, trimerophytes are of great evolutionary interest, because they include fossils that are close to the common ancestry of prominent plant taxa, such as ferns, [progymnosperms](#), and [sphenophytes](#). The trimerophytes appear to form a sort of basal group close to the ancestry of these major taxa.

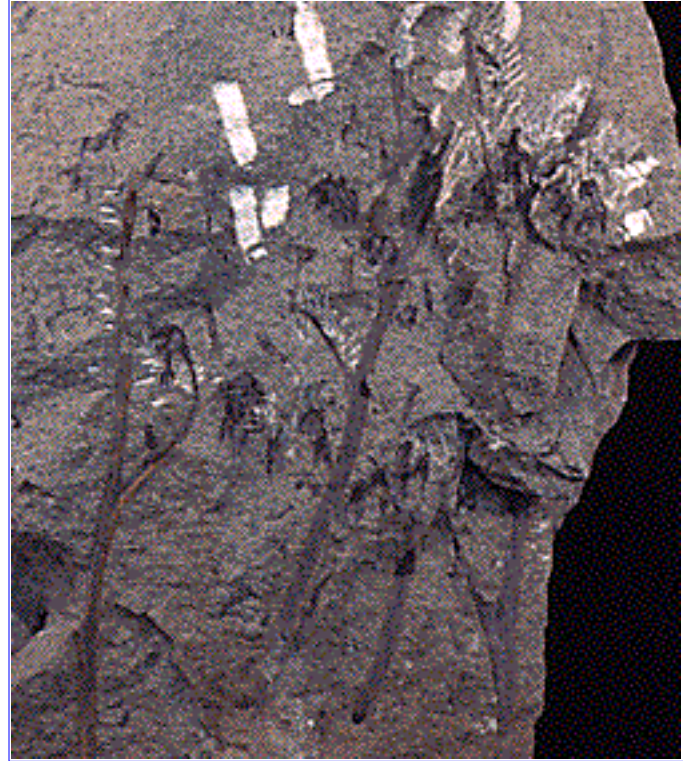

Like the rhyniophytes, trimerophytes lacked leaves and roots; most of the plant body consisted of branching stems that were photosynthetic throughout their length. Vascular tissue was present, forming a solid central bundle in the center of the stem, or **protostele**. However, whereas rhyniophytes branched **dichotomously** -- stems always branched into two equal branches -- trimerophytes branched **pseudomonopodially**, which is a way of saying that branching was unequal, forming a main stem, or axis, with several smaller lateral branches. You can see this pattern of branching in the picture of *Psilophyton forbesii*, at right. Lateral branches typically branched dichotomously, and were often shortened to form bushy "webs" of small, closely spaced branches. Some trimerophytes also bore **enations** -- small flaps of tissue lacking vascularization, and therefore not true leaves -- on the main stems, giving them a superficially "thorny" appearance.

Like the rhyniophytes, but unlike the superficially similar [zosterophylls](#) from the same time period, trimerophytes bore sporangia at the tips of branches. The spindle-shaped sporangia produced only one type of spore: trimerophytes were thus **homosporous**. Spores released from the sporangia would have germinated into **gametophytes**, but no fossil trimerophytes gametophytes have been identified, and we do not know whether trimerophytes, like their later relatives the ferns, sphenopsids, and seed plants, had small, inconspicuous gametophytes.

Trimerophytes varied in size from a few centimeters to nearly a meter tall; large trimerophytes were among the largest plants of the Early Devonian. One of the meter-high trimerophytes, *Pertica quadrifaria*, has attained some post-extinction fame as the state fossil of Maine. Another species in this genus is pictured below.

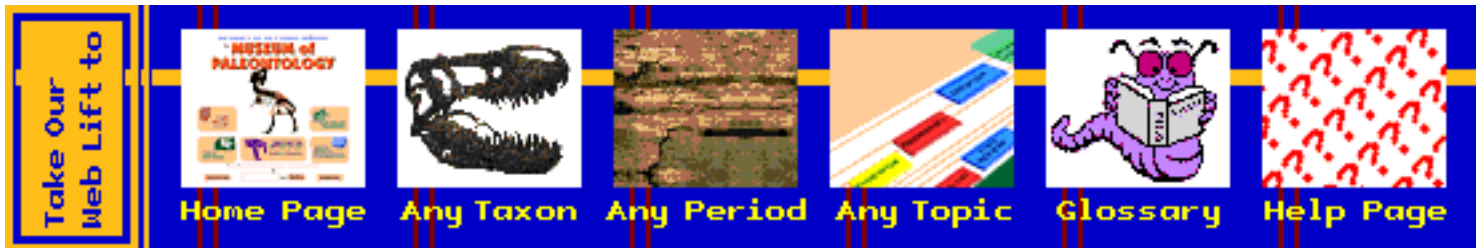

Source:

Stewart, W.N. and Rothwell, G.W. 1993. *Paleobotany and the Evolution of Plants*. Second edition. Cambridge University Press, Cambridge.

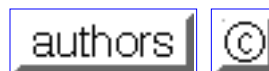

Introduction to the Sphenophyta

Yesterday's trees, today's horsetails



Three hundred million years ago, a walk through a lowland forest or swamp, or along a riverbank or floodplain, would have revealed a great variety of trees, even though the familiar conifers and [flowering plants](#) of today were not present. Prominent among the trees of the time, and also common in the shrubbery, were plants in the Sphenophyta, distinguished by their straight stems with branches or leaves arranged in regular whorls. Some [Paleozoic](#) sphenophytes grew up to thirty meters tall (nearly 100 feet).

Today, the sphenophytes consist of only one genus, *Equisetum*, with about thirty living species known worldwide. A few species, like the tropical Mexican species pictured above, may reach ten feet in height, but most living species are small, weedy plants -- remnants of former glory. *Equisetum* are known as horsetails, foxtails, or scouring rushes -- this last name is derived from the fact that *Equisetum* stores granules of silica within its cells, making it an effective tool for scrubbing pots and polishing wood. These plants are sometimes pestiferous weeds, and are somewhat toxic to livestock, but they also have medicinal value: *Equisetum* was used in traditional native American and Ukrainian medicine to stop bleeding, and recent research has shown that *Equisetum* is also effective as a diuretic.

Click on the buttons below to find out more about the Sphenophyta.

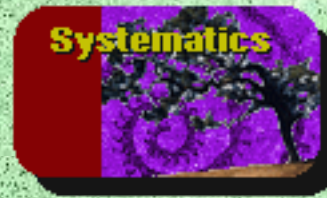

[Images of living sphenophytes](#) are available from the [University of Wisconsin](#).

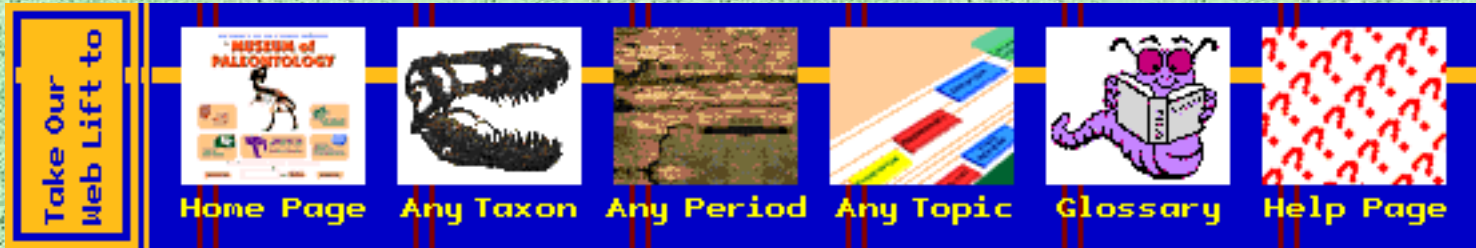

authors



UCMP Glossary: M



| [A](#) | [B](#) | [C](#) | [D](#) | [E](#) | [F](#) | [G](#) | [H](#) | [I](#) | [J](#) | [K](#) | [L](#) | **M** | [N](#) | [O](#) | [P](#) | [Q](#) | [R](#) |
[S](#) | [T](#) | [U](#) | [V](#) | [W](#) | [X](#) | [Y](#) | [Z](#) |

macroscopic -- Objects or organisms that are large enough to be seen with the naked eye.

mafic -- Term used to describe the amount of dark-colored iron and magnesium minerals in an [igneous](#) rock. Complement of [felsic](#).

magma -- n. Molten rock generated within the Earth; forms intrusive (solidifies below the surface) and extrusive (solidifies above the surface) igneous rocks.

magnoliid -- Any member of the basal assemblage of [flowering plants](#).

male -- In organisms with separate sexes, the one which produces sperm.

mannoxylic -- Wood in which there is a great deal of **parenchyma** tissue among the xylem is called mannoxylic. [Cycads](#) and **pteridosperms** have mannoxylic wood. Contrast with [pycnoxylic](#).

mantle -- That portion of the interior of the Earth that lies between the [crust](#) and the [core](#).

marine -- Refers to the ocean.

marine terrace -- n. A platform of marine deposits (typically sand, silt, gravel) sloping gently seaward. Such a platform may be exposed along the coast, forming cliffs, due to uplift and/or the lowering of sea level, e.g., Marine terraces of coastal Southern California.

marl -- n. A loose, crumbly deposit consisting of clay and calcium carbonate and formed in marine or freshwater conditions.

marsupial -- n. (adj.) A mammal whose young are born while still embryos, and must crawl into its mother's external pouch (called the **marsupium**) to finish development.

mastigoneme -- Small hair-like filaments found on the "hairy" flagellum of the [Chromista](#).

megaspore -- In plants which are **heterosporous**, the larger kind of spore is called a megaspore; it usually germinates into a female (egg-producing) **gametophyte**. Contrast with **microspore**.

meiosis -- A two-stage type of cell division in sexually reproducing organisms. In meiosis, a diploid cell divides to produce four haploid cells, each with half the original chromosome content. For this reason, meiosis is often called a "reduction division". In organisms with a diploid life cycles, the products of meiosis are usually called **gametes**. In organisms with an alternation of generations, the products of meiosis are called spores.

melange -- A body of rocks consisting of large blocks (mappable size) of different rocks jumbled together with little continuity of contacts.

membrane -- Semi-fluid structure which bounds all cells, and partitions the interior of eukaryotic cells. It consists primarily of two lipid layers, with proteins "dissolved" in the lipids.

meristem -- Group of undifferentiated cells from which new tissues are produced. Most plants have **apical meristems** which give rise to the primary tissues of plants, and some have **secondary meristems** which add wood or bark.

merophytes -- Group of cells which have all been produced from the same initial cell. Leaves and stems in particular are often built from specific patterns of merophytes.

mesoderm -- In animals with three tissue layers (i.e. all except [sponges](#) and [cnidarians](#)), the middle layer of tissue, between the **ectoderm** and the **endoderm**. In vertebrates, for instance, the mesoderm forms the skeleton, muscles, heart, spleen, and many other internal organs.

mesogloea -- Jellylike material between the outer ectoderm and the inner endoderm of [cnidarians](#). May be very thin or may form a thick layer (as in many jellyfish).

mesokaryotic -- Nuclear condition unique to the [dinoflagellates](#) in which the chromosomes remain permanently condensed.

metamorphic rock -- Any rock derived from other rocks by chemical, mineralogical and structural changes resulting from pressure, temperature or shearing stress.

metamorphism -- n. The process of altering the chemical or mineralogical composition of a rock through different amounts of heat and pressure below the surface of the Earth; **metamorphose**- v.

metamorphosis -- n. A process of developmental change whereby a larva reaches adulthood only after a drastic change in morphology; occurs in most amphibians and insects, for some insects, this change may include another stage (pupa) before the adult stage; **metamorphose**- v.

microfossil -- n. A very small fossil, best studied with the aid of a microscope, e.g. foraminifera, radiolarians, and small vertebrate fossils such as teeth. *macrofossil*-ant.

microphyll -- A kind of leaf, specifically one which has a single, unbranched vein in it. Microphylls are only found in the [lycophytes](#).

microscopic -- Objects or organisms that are too small to be seen with the naked eye.

microspore -- In plants which are **heterosporous**, the smaller kind of spore is called a microspore; it usually germinates into a male (sperm-producing) **gametophyte**. Contrast with **megaspore**.

microtubules -- Type of filament in eukaryotic cells composed of units of the protein tubulin. Among other functions, it is the primary structural component of the eukaryotic flagellum.

microvilli -- Thin fingerlike protrusions from the surface of a cell, often used to increase absorptive capacity or to trap food particles. The "collar" of [choanoflagellates](#) is actually composed of closely spaced microvilli.

mid-oceanic ridges -- Elongated rises on the ocean floor where [basalt](#) periodically erupts, forming new oceanic crust; similar to continental [rift zones](#).

mineralization -- The process of replacing any organism's original material with a mineral.

mitochondrion -- Complex organelle found in most eukaryotes; believed to be descended from free-living bacteria that established a symbiotic relationship with a primitive eukaryote. Mitochondria are the site of most of the energy production in most eukaryotes; they require oxygen to function. See: **double membrane**.

mitosis -- The process of nuclear division in eukaryotes. It is one step in cytokinesis, or cellular division. [MORE ?](#).

molds -- Fossils formed when the sediment surrounding a buried organism hardens. When the organism decays, its impression is left in the rock and can be seen if the rock is broken open.

monophyletic -- Term applied to a group of organisms which includes the most recent common ancestor of all of its members and all of the descendants of that most recent common ancestor. A monophyletic group is called a clade. [More?](#)

monsoonal -- adj. Describes a climate pattern with a wind system that changes direction with the seasons; this pattern is dominant over the Arabian Sea and Southeast Asia.

moraine -- n. A mound or ridge of sediment deposited by a glacier; **lateral moraine**- n. deposited to the side of a glacier; **terminal moraine**- n. deposited to the front of a glacier; **ground moraine**- n. deposited on the land surface.

morphology -- n. The form and structure of anything, usually applied to the shapes, parts, and arrangement of features in living and fossil organisms.

motile -- Able to move oneself about, capable of self-locomotion.

mouth -- Front opening of the digestive tract, into which food is taken for digestion. In [flatworms](#), the mouth is the only opening into the digestive cavity, and is located on the "belly" of the worm.

MTOC -- (microtubule organizing center) MTOCs are bundles of protein tubes which may be found at the base of a [eukaryotic](#) flagellum. In animals, they also function in creating the arrays of microtubules that pull the chromosomes apart during mitosis.

mucus -- Sticky secretion used variously for locomotion, lubrication, or protection from foreign particles.

multicellular -- Any organism which is composed of many cells is termed multicellular.

muscle -- Bundle of contractile cells which allow animals to move. Muscles must act against a [skeleton](#) to effect movement.

mycorrhizae -- Symbiotic association between a [fungus](#) and the roots or rhizoids of a [plant](#). [More info?](#)

myotome -- Segment of the body formed by a region of muscle. The myotomes are an important feature for recognizing early [chordates](#).

Last updated:2004-04-20



UCMP Glossary: C



| [A](#) | [B](#) | **C** | [D](#) | [E](#) | [F](#) | [G](#) | [H](#) | [I](#) | [J](#) | [K](#) | [L](#) | [M](#) | [N](#) | [O](#) | [P](#) | [Q](#) | [R](#) |
[S](#) | [T](#) | [U](#) | [V](#) | [W](#) | [X](#) | [Y](#) | [Z](#) |

calcareous -- adj. Term used to describe a structure, secreted by an organism, that consists of or contains calcium carbonate (CaCO_3), e.g., the shell of a bivalve.

calcite -- A common crystalline form of natural calcium carbonate, CaCO_3 , that is the basic constituent of limestone, marble, and chalk. Also called calcspar.

calcium carbonate -- a "salt" used by many marine invertebrates, such as corals and [echinoderms](#), and by protists, such as [coccolithophorids](#), to construct their exoskeletons.

caldera -- n. A large circular volcanic depression, often originating due to collapse.

canopy -- Layer of vegetation elevated above the ground, usually of tree branches and epiphytes. In tropical forests, the canopy may be more than 100 feet above the ground.

capsid -- The protein "shell" of a free virus particle.

carbohydrates -- class of biochemical compounds which includes sugars, starch, chitin, and steroids.

carbon film -- Thin layer of carbon remains of past life found in [sedimentary rocks](#).

carbonate -- n. (adj.) A mineral composed mainly of calcium (Ca) and carbonate (CO_3) ions, may also include magnesium (Mg), iron (Fe) and others; n. rock or sediments derived from debris of organic materials composed mainly of calcium and carbonate (e.g., shells, corals, etc.) or from the inorganic precipitation of calcium (and other ions) and carbonate from solution (seawater). For example, [limestone](#) or [dolomite](#). **carbonate platform** – n. A broad (100s of meters), flat, shallow submarine expanse of carbonate rock, more common in the early-middle Paleozoic. **carbonate bank** – n. A narrow (10s of meters), fairly flat, shallow, submarine plateau of carbonate rock, more common from the middle-late Paleozoic to the present, e.g., the Bahama Banks.

carnivore -- Literally, an organism that eats meat. Most carnivores are [animals](#), but a few fungi, plants, and protists are as well.

carpel -- A unit of the **pistil**; it is evolutionarily a modified leaf.

casts -- Fossils formed when water containing minerals leaks into a mold. The minerals harden to form a copy of the original structure or organism.

cataphyll -- In [cycads](#), a scale-like modified leaf which protects the developing true leaves.

Cathaysian terranes -- n. A set of small landmasses that developed in tropical to subtropical latitudes on the eastern side of Pangea during the Permian and Triassic, includes modern North China (Sino-Korea), South China (Yangtze), Eastern Qiangtang, Tarim, and Indochina.

cell -- Fundamental structural unit of all life. The cell consists primarily of an outer plasma membrane, which separates it from the environment; the genetic material (DNA), which encodes heritable information for the maintenance of life; and the cytoplasm, a heterogeneous assemblage of ions, molecules, and fluid.

cell cycle -- Complete sequence of steps which must be performed by a cell in order to replicate itself, as seen from [mitotic](#) event to mitotic event. Most of the cycle consists of a growth period in which the cell takes on mass and replicates its DNA. Arrest of the cell cycle is an important feature in the reproduction of many organisms, including humans.

cell membrane -- The outer membrane of a cell, which separates it from the environment. Also called a plasma membrane or plasmalemma.

cell wall -- Rigid structure deposited outside the cell membrane. [Plants](#) are known for their cell walls of [cellulose](#), as are the green algae and certain protists, while [fungi](#) have cell walls of [chitin](#).

cellulose -- carbohydrate polymer of the simple sugar glucose. It is found in the cell walls of [plants](#) and [green algae](#), as well as dinoflagellates. Cellulose is the most abundant compound on earth that is manufactured by living things.

cephalon -- In [trilobites](#), the head shield bearing the eyes, antennae, and mouth.
[More info?](#)

chaetae -- Stiff bristles characteristic of [annelids](#).

chalk -- A soft compact calcite, CaCO₃, with varying amounts of silica, quartz, feldspar, or other mineral impurities, generally gray-white or yellow-white and derived chiefly from fossil seashells.

character -- Heritable trait possessed by an organism; characters are usually described in terms of their states, for example: "hair present" vs. "hair absent," where "hair" is the character, and "present" and "absent" are its states.

chela -- The claw of an [arthropod](#).

chelicera -- The first pair of appendages of a **chelicerate** arthropod. Originally a short clawed appendage, the chelicerae of many arachnids are highly modified for feeding; in [spiders](#), for instance, they are modified into poisonous fangs.

chert -- Hard, dense [sedimentary rock](#), composed of interlocking quartz crystals and possibly amorphous silica (opal). The origin of the silica is normally biological, from [diatoms](#), [radiolaria](#) or [sponge spicules](#). Synonymous with flint.

chitin -- n. A carbohydrate polymer found in the cell walls of [fungi](#) and in the exoskeletons of [arthropods](#), which provides strength for support and protection;
chitinous- adj.

chlorophyll -- n. The green-colored pigment that absorbs light during photosynthesis, often found in plants, algae, and some bacteria; it includes a porphyrin ring, and often has a long hydrophobic tail. [More info?](#)

chloroplast -- A chlorophyll-containing plastid found in algal and green plant cells.

chordate -- n. An animal with a notochord (a cartilaginous rod that extends the length of the body), dorsal hollow nerve cord (a fluid-filled tube that runs the length of the body), gill slits or pouches, and a tail at some stage in its life cycle.

chromosome -- Linear piece of eukaryotic DNA, often bound by specialized proteins known as histones.

Cimmerian terranes -- n. An archipelago of small landmasses that developed in tropical and subtropical latitudes on the eastern side of Pangea during the Triassic, blocks that comprised it include modern Turkey, Iran, Afghanistan, Tibet, and Malaysia; also called **Cimmeria**.

clade -- A monophyletic taxon; a group of organisms which includes the most recent common ancestor of all of its members and all of the descendants of that most recent common ancestor. From the Greek word "klados", meaning branch or twig.

cladogenesis -- The development of a new clade; the splitting of a single lineage into two distinct lineages; speciation.

cladogram -- A diagram, resulting from a cladistic analysis, which depicts a hypothetical branching sequence of lineages leading to the taxa under consideration. The points of branching within a cladogram are called nodes. All taxa occur at the endpoints of the cladogram.

clast -- n. An individual grain or constituent of a rock; **clastic**- adj. Describes a rock or sediment composed mainly of fragments of preexisting rocks or minerals that have been transported some distance from their place of origin, e.g., sandstone, shale.

clitellum -- In [annelids](#), a swelling of the body towards the head of the animal, where the gonads are located. Both oligochaetes and leeches have a clitellum.

clone -- An identical copy of an organism. Most plants, fungi, algae, and many other organisms naturally reproduce by making clones of themselves as a form of **asexual reproduction**.

cnidocyst -- The "stinging cell" of a [cnidarian](#).

coelom -- Fluid-filled cavity within the body of an animal; usually refers to a cavity lined with specialized tissue **peritoneum** in which the gut is suspended. The structure and development of the coelom is an important character for recognizing major groups of animals.

coenocytic -- Condition in which an organism consists of filamentous cells with large central vacuoles, and whose nuclei are not partitioned into separate compartments. The result is a long tube containing many nuclei, with all the cytoplasm at the periphery.

collagen -- long proteins whose structure is wound into a triple helix. The resulting fibers have a high tensile strength. Collagen is a primary component of mammalian hair.

colonial -- Condition in which many unicellular organisms live together in a somewhat coordinated group. Unlike true multicellular organisms, the individual cells retain their separate identities, and usually, their own membranes and cell walls.

columella -- A small column of tissue which runs up through the center of a spore capsule. It is present in [hornworts](#), mosses, and some rhyniophytes.

compactions -- Fossils that have undergone some degree of flattening of their three-dimensional structure.

compound eye -- Found in many but not all [arthropods](#), a compound eye is composed of a large number of small, closely packed simple eyes (**ommatidia**), each with its own lens and nerve receptors.

compound leaves -- n. Leaves with two or more leaflets attached to a single leaf stem.

compression -- [Fossil](#) formed when an organism is flattened (compressed) and a thin film of organic material from its body is left in the rock.

concretion -- n. A hard, rounded mass, commonly of silica, calcite, dolomite, iron oxide, pyrite, or gypsum, that formed within a rock from the precipitation of these minerals around a nucleus, such as a leaf, bone, shell, or fossil, and ranging in diameter from centimeters to meters.

conglomerate -- A coarse-grained [sedimentary rock](#), with **clasts** larger than 2 mm.

Congo craton -- n. A separate continental plate that rifted from the supercontinent Rodinia in the Late Precambrian; contained a large part of north-central Africa.

consumer -- Any organism which must consume other organisms (living or dead) to satisfy its energy needs. Contrast with [autotroph](#).

continental crust -- The Earth's [crust](#) that includes both the continents and the **continental shelves**.

continental margin -- n. The ocean floor from the shore of continents to the [abyssal plain](#).

continental rise -- n. Part of the **continental margin**; the ocean floor from the **continental slope** to the [abyssal plain](#). The continental rise generally has a gentle slope and smooth topography.

continental shelf -- n. The part of the continental margin from the coastal shore to the continental slope; usually extending to a depth of about 200 meters and with a very slight slope, roughly 0.1 degrees; includes continental and oceanic sediments down to the ocean floor.

continental slope -- n. Part of the **continental margin**; the ocean floor from the **continental shelf** to the **continental rise** or [oceanic trench](#). Usually to a depth of about 200 meters. The continental slope typically has a relatively steep grade, from 3 to 6 degrees.

contractile vacuole -- In many protists, a specialized vacuole with associated channels designed to collect excess water in the cell. Microtubules periodically contract to force this excess water out of the cell, regulating the cell's osmotic balance.

convergence -- Similarities which have arisen independently in two or more organisms that are not closely related. Contrast with homology.

copal -- Brittle aromatic yellow to red resins of recent or fossil origin, obtained from tropical trees.

coprolites -- Fossilized feces.

core -- That portion of the interior of the Earth that lies beneath the [mantle](#), and goes all of the way to the center. The Earth's core is very dense, rich in iron and the source of the magnetic field.

cotyledon -- n. The "seed leaves" produced by the embryo of a seed plant that serve to absorb nutrients packaged in the seed, until the seedling is able to produce its first true leaves and begin photosynthesis; the number of cotyledons is a key feature for the identification of the [two major groups of flowering plants](#).

craton -- n. A part of the Earth's crust that has attained stability and has been little deformed for a long period of time, refers only to continents; **cratonic**- adj.

Cretaceous Western Interior Seaway -- n. The epicontinental sea that formed as marine waters from the north spread over North America from around 130 to 70 million years ago (Ma), at its peak in the Middle Cretaceous (~ 90 Ma) it extended from present-day Utah to the Appalachians and from the Arctic to the Gulf of Mexico; also referred to as the **Western Interior Seaway**

cross-bedding -- (n) The arrangement of sedimentary beds tilted at different angles to each other, indicating that the beds were deposited by flowing wind or water.

crown group -- All the taxa descended from a major cladogenesis event, recognized by possessing the clade's synapomorphy. See: stem group.

crust -- n. The outermost layer of the Earth, varying in thickness from about 10 kilometers (6 miles) below the oceans, to 65 kilometers (about 40 miles) below the continents; represents less than 1 percent of the Earth's volume.

cuticle -- 1) In animals, a multilayered, extracellular, external body covering, usually composed of fibrous molecules such as chitin or collagen, and sometimes strengthened by the deposition of minerals such as calcium carbonate. 2) A waxy layer which seals the outer surface of land plants, helping to retain moisture.

cyst -- n. A small, capsule-like sac that encloses an organism in its resting or larval stage, e.g., a resting spore of an alga.

cytoplasm -- All the contents of a cell, including the plasma membrane, but not including the nucleus.

cytoskeleton -- Integrated system of molecules within eukaryotic cells which provides them with shape, internal spatial organization, motility, and may assist in communication with other cells and the environment. Red blood cells, for instance, would be spherical instead of flat if it were not for their cytoskeleton.

Last updated:2004-04-20

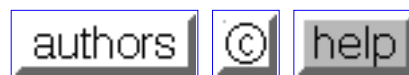

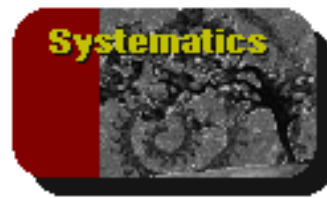

"Green Algae": Systematics, Part 2

The Charophytes

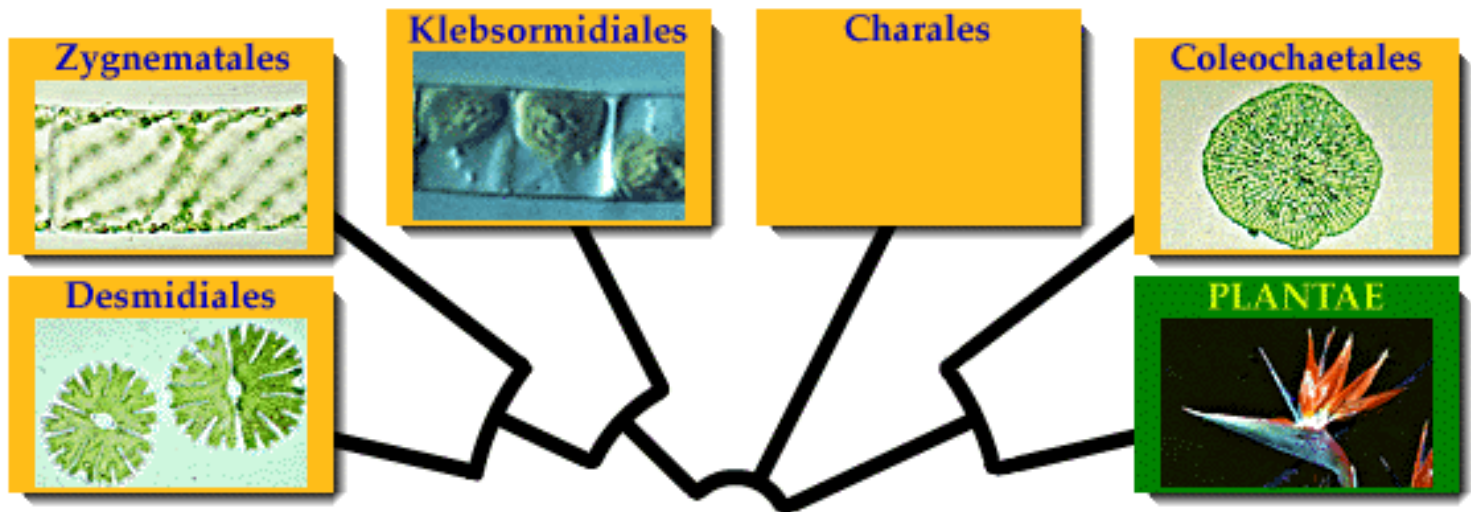

Charophytes are well known to students of biology. Spirogyra, stoneworts, and desmids are all members of this fresh-water group of "[green algae](#)". The charophytes have gained even more attention recently because they are now known to be the most closely related group of organisms to the Plantae. The charophytes are in fact **paraphyletic** with respect to the Plantae -- some members of the group are more closely related to the plants than to the other charophytes, though there is still considerable debate as to the exact relationships among the various members.

Unlike the other green algae, the charophytes share with plants the **phragmoplast** method of cell division, and the asymmetric arrangement of their sperm flagella. This latter character is only observable in the Charales and Coleochaetales, since members of the remaining orders do not produce flagellated gametes as part of their life cycle.

Visit the [Tree of Life](#) for more information about the relationships of the [charophytes](#) to each other, and to the plants.

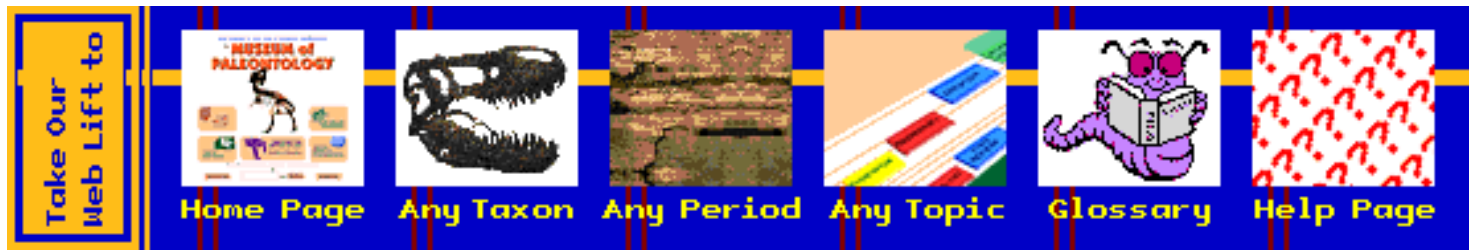

authors ©

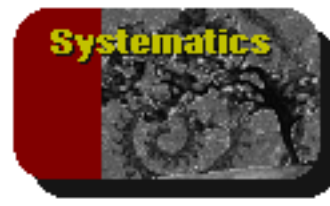

Plantae: More on Morphology

[CLICK HERE FOR A TABLE](#) comparing the gametophytes and sporophytes of the major extant divisions. The table is **linked** to each of the divisions pictured.

Plant cells have a cell wall, large central vacuole, and plasmodesmata.

Like other eukaryotes, plants have a nucleus, plasma membrane, mitochondria, and other organelles, but plant cells differ from animal, fungal, and protist cells in a number of important ways. The most obvious difference is the presence of a **cell wall** which surrounds each cell. It is composed primarily of **cellulose**, a complex carbohydrate made from glucose. Cellulose provides structural support while remaining flexible; flower petals, for instance, are flexible but will snap if folded too far.

When plant cells divide, they must form a new cell wall between them, and this is accomplished by the formation of a **phragmoplast**, a system of microtubules oriented *along* the axis of cell division which helps to guide the deposition of cellulose. This is also an important difference from the "green algae", which produce a **phycoplast** during mitosis, in which the microtubules lie *perpendicular* to the axis of division. Only plants and [charophytes](#) divide their cells with the aid of a phragmoplast.



Neighboring cells in plants are connected across their cell walls by extensions of the cells through pores called **plasmodesmata**. A plasmodesma allows cells to transfer nutrients, water, and some other diffusible materials without having to pass them across membranes or other barriers. They are also important for understanding how diseases spread through the tissues of a plant.

At maturity, most plant cells are filled with a single large **vacuole**, such that the nucleus, plastids, and other organelles are all close to the cell membrane. This can be seen in the picture at right. At the far right is the nearly transparent nucleus, and clusters of plastids can be seen toward the bottom and left. Those plastids which appear to be in the "middle" of the cell are actually at the

periphery; remember that there is a cell wall toward you, and a wall on the far side of the cell, with the vacuole filling most of the space in between.

The vacuole is a membrane-bound bag of fluid, containing ions, stored nutrients, and waste materials. The storage of waste materials is a very important function of the vacuole, since plants cannot excrete their wastes the way [animals](#) do. The vacuole also assists the cell in maintaining **turgor pressure**. The high concentration of materials in the vacuole causes water to diffuse into the cell, increasing its volume. Because of the cell wall, however, the amount of space into which the cell can expand is limited. The cell thus exerts outward pressure on its cell wall, and when all cells are maintaining this pressure, the plant gains rigidity. You can notice this by comparing crisp fresh celery with celery that has sat around and grown limp. The old celery has lost fluids, and is no longer rigid.

Plastids manufacture food through photosynthesis.

Plastids are perhaps the most important feature of plants, that is, from the perspective of animals that live on land. The plastid is an organelle which contains [chlorophyll](#). The chlorophyll captures the energy of light, and makes it accessible to the plant for **photosynthesis**. This provides the energy plants use to manufacture sugars, which are then used as a fuel source for continued growth. The sugars are often linked together for easy storage into a complex carbohydrate called **starch**. Without these sugars and starch, life on land as we know it would be impossible, for there would be practically no food -- no grains, no fruits, no vegetables. Another useful by-product of photosynthesis is oxygen, though plants are not the most important producers of this gas. Most of our oxygen comes from [phytoplankton](#) in the earth's oceans.

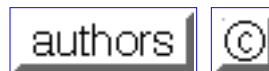
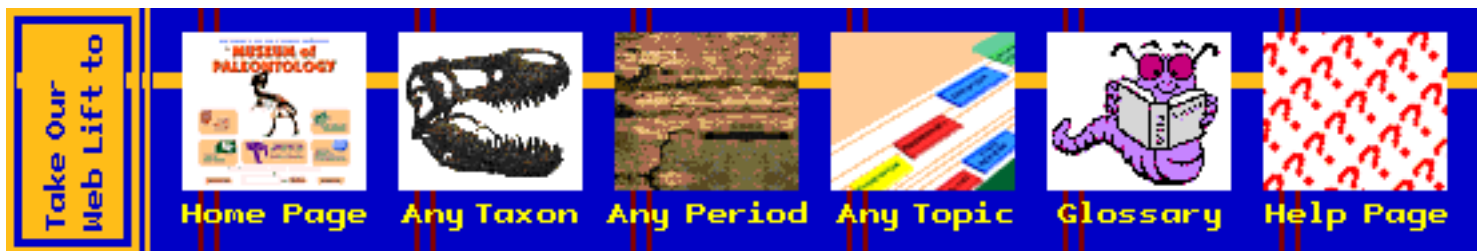

[Allen Collins](#) began this glossary project that seeks to provide basic information related to Paleobiology during May and June of 1995.

[Brian Speer](#) added pages on biochemical and cellular terms used on this server, 18 July and 27 July 1995.

[Ben Waggoner](#) expanded the cellular and zoological pages on 13 August 1995.

[Ben Waggoner](#) and [Brian Speer](#) created the infrastructural pages on 10 August 1995.

[Rob](#) did some minor editing, and added some text.

[Brian Speer](#) added the ecology volume on 18 October 1995.

[Ben Waggoner](#) and [Brian Speer](#) added the zoology volume on 26 November 1995.

[Allen Collins](#) added the geology volume on December 6, 1995.

[Brian Speer](#) added the botany volume on 12 February 1996.

[Brian Speer](#) added the life history volume on 27 September 1998.

Colleen Whitney converted the glossary to update dynamically from a database (September, 2003).

Sarah Rieboldt added the Paleogeography glossary, and added and updated numerous terms in other sections of the glossary (October 2003).

Copyright Statement

Copyright 1994–2004 by the Regents of the University of California, all rights reserved.

All materials appearing on the UCMP Web Servers (WWW.UCMP.BERKELEY.EDU and ANNIE.UCMP.BERKELEY.EDU) may not be reproduced or stored in a retrieval system without prior written permission of the publisher and in no case for profit.

Contact the [UCMP Webmaster](#) to inquire about use of these materials.

[Home](#) | [What's new](#) | [About UCMP](#) | [History of life](#) | [Fossil collections](#) | [Other resources](#)





HELP

To get help in finding your way around, or to understand the mechanics of our server, select from any of the statements below. Clicking on one of these statements will take you to some hints and links to help you. If you have never visited our site before, you may want to see our page for [first-time visitors](#).

Help! I'm lost!

Take me to the [UCMP Home Page](#).

Show me [how to navigate](#).

I can't find it!

How do I [look for something](#) on the server?

Please explain the [exhibit layout and format](#).

Just take me to the [dinosaurs](#), the [sharks](#), or to the pages about the world's [biomes](#).

How does it work?

What is that [blue "Web Lift" bar](#) at the bottom of the screen?

Please explain the [exhibit layout](#).

I found a problem.

I need to contact the [webmaster](#).

I found a [link that doesn't work](#).

[Home](#) | [What's new](#) | [About UCMP](#) | [History of life](#) | [Collections](#) | [Other resources](#)

Google

UCMP ©

Lost in the Woods

The Child Survival section

This *Child Survival* program is presented to students, cubs, guides, parents and interest groups across North America. It is not a "Hug a Tree" program. It goes into more detail and adds more Rules for Survival. The presentation is about one hour and thirty minutes. The maximum group size is about one hundred and twenty (or whatever the instructor can handle). The film, "*Lost in the Woods*" by Barry Casson, is shown as part of the presentation. Experiments taken from the book, "*Lost in the Woods*" by Colleen Politano, are done during each session.

The Instructor package is available from SARBC. Please see below for a link.

[Discussing Feelings](#)

[Child's survival Kit](#)

[The 9 Rules for survival](#)

[Instructor Kit](#)

From Ken Hill

[Children's Woodsproofing](#)

The Lost in the Woods program is available three ways:

- Requesting an Instructor (Victoria Area)
- Purchasing the Video and Instructors Kit
- Borrowing the video and Instructors Kit (BC Only)

To request an Instructor please use this [form](#). Instructors provided by SARBC are available in the Greater Victoria Area.

To purchase the Video and Instructors Kit, please use this [form](#). We now accept credit cards, or you may order by sending a cheque to SARBC.

To borrow the video and Instructors Kit, please use this [form](#). Kits are available on a first come, first serve basis and presently are limited in quantity.

[No Javascript SARBC Site](#)

Meat and Potatoes

SEARCH MANAGEMENT

- [Quick Reference Math](#)
- [Computer Programs](#)
- [Behaviour Characteristics](#)
- [Speed Tables](#)
- [Statistics](#)
- [Incident Command System](#)
- [Incident Management](#)
- [Probability of Location](#)

SEARCH

- [Map and Compass](#)
- [Navigation](#)
- [Night Vision](#)
- [SAR Dogs](#)
- [Search Dog Handbooks](#)
- [SAR Logbook](#)
- [Tracker Logbook](#)
- [SAR Pocket Cards](#)

RESCUE

- [Rope Rescue](#)
- [Urban SAR - Heavy](#)
- [Urban SAR - Lite](#)

COMMUNICATIONS

- [Communications](#)

INFORMATION

- [Critical Incident Stress](#)
- [Elementary School Preplan](#)
- [Hypothermia](#)
- [Liability Info](#)
- [RCMP Role - SAR](#)
- [Alaska Protocols](#)
- [Techniques of Instruction](#)
- [Ken Hill's Page](#)





Hosting Services

[Home](#)[Hosting & Web](#)[HD Sanitizing](#)[Data Recovery](#)[Company Profile](#)[Links](#)[Consultancy](#)

Total Management Hosting Services

Domain registration, account setup and hosting, manage your web site. Basic web site design is optional.

Regular updates (for specials or promos) available at a small extra charge.

Starter package pricing is based on 1GB bandwidth monthly and 10MB disk space.

PC Security is a special area of interest. We can help! Computer security, data security and data erasure services are available.

If your computer no longer responds as it once did, or, you are experiencing crashes, you may have viruses, spyware, trojans or parasites on your computer. We can get rid of these pests for you with no data loss. If you take your computer to a computer store, they usually just reformat your hard drive and reinstall the operating system, resulting in data loss - all of your data is gone. Call us - we will do it right.

We are pleased to offer Web Design services for local or distance clients.

[Web Site Design](#) | [Company Profile](#) | [Consultancy](#) | [HD Sanitizing](#) | [Data Recovery](#)

250-744-0989

All Content Copyright © 2000-2003 [MCD Planning Resources Inc.](#) All rights reserved.

Please note that HTML email is automatically deleted due to spam.

Spammers: No email address on this site has ever been used on any list. You will be charged \$500.00 for each spam email.

Revised: May 21, 2003.

Lost in the Woods - Child Survival K-7 Discussing Feelings

SARBC

Search and Rescue Society of British Columbia

Discussing Feelings

by Gary O'Brien, SARBC

Because children have fears, which can be more intense than those of an adult, they are discussed by the instructor during the Child Survival lecture. The following words are addressed to the students, and elaborated.

Talking about FEELINGS, and knowing how to deal with them, is very important.

Nobody likes being scared or frightened.

Help yourself keep calm by singing, whistling or even telling yourself jokes or stories. Do anything it takes to make yourself feel better. Try using your imagination to pretend you are somewhere else that you really enjoy.

You usually do not have to worry about wild animals. They do not like to be near people. If they hear or smell you, they will usually run away.

A good rule is Answer a Noise with a Noise. If you hear a noise in the woods, make a noise back. If it is an animal it will run away, if it is a searcher then you will be found.

The fear of dark can be easily overcome by memorizing your surroundings during daylight so that you can see with your memory when it gets dark. Nothing changes just because it gets dark. Try practicing in your bedroom.

There is no punishment for being lost and yet children have been known to hide or run away from searchers in fear of punishment. Children should not have any fear of returning home. Mom and Dad, or whoever is looking after you are going to be very happy to see you again. There will be NO punishment.

There are Friendly strangers who will help you when needed. Some of these are police officers, fire fighters, ambulance personnel and Search and Rescue teams. Generally, these Friendly strangers always work in groups.

[Back](#)

[Home Page](#) | [Index](#)

Last Updated: Wednesday, November 01, 1995
by [MCDPRI](#)

Lost in the Woods - Child Survival Kit

SARBC

Search and Rescue Society of British Columbia

Lost in the Woods - Child Survival Kit

by Gary O'Brien, SARBC

During the presentation of this Child Survival lecture, the instructor would show the students each item and how it is made. For instance the reflector is tin foil pasted to cardboard (no sharp edges), and, the right and safe way to tear a face hole in the bright orange garbage bag is demonstrated.

Make an Emergency Survival Kit (and practice using it):

1. A Zip Lock sandwich bag for the container (also used as a cup for drinking water)
2. A snack of high energy trail mix (contained in its own zip lock bag)
3. A whistle used for calling for help (three short blasts)
4. A signal flag approximately 10cm by 100cm (cut from orange plastic garbage bag)
5. A reflector for sending signals (use soft, flexible material)
6. A large, bright color garbage bag used as poncho (pre-tear slit for face opening - Do not "cut" hole)

[Back](#)

[Home Page](#) | [Index](#)

Last Updated: Wednesday, November 01, 1995
by [MCDPRI](#)

Lost in the Woods Instructor Kit

SARBC

Search and Rescue Society of British Columbia

Lost in the Woods - Instructor Kit

by Gary O'Brien, SARBC

The Lost in the Woods Child Survival presentation Instructor kit includes:

1. Video - Lost in the Woods, 24 minutes, by Barry Casson
2. Video - Lost in the Woods Instructor teaching a group of students, 1 hour 20 minutes
This video is to give an Instructor some ideas about presenting the material.
3. Book - Lost in the Woods by Colleen Politano
4. Handout - Illustrated 9 Rules, suitable for copying
5. Handout - Canadian EPC pamphlet, substitute FEMA pamphlet to suit
6. Certificate - Sample, change and copy to suit
7. Overview of the presentation for Instructors

Note: Every child should receive the illustrated 9 Rules handout, the others are optional.

[Back](#)

[Home Page](#) | [Index](#)

Last Updated: Wednesday, November 01, 1995
by [MCDPRI](#)

Children's Woodsproofing

SARBC

Search and Rescue Society of British Columbia

Children's Woodsproofing

Copyright © 1996
Kenneth A. Hill, PhD
Training Officer (External)
Waverley Ground Search and Rescue
Nova Scotia, Canada
October, 1987

Objectives

The Woodsproofing concept arose primarily out of concern for the survival of children who become lost, particularly those who defeat the efforts of search teams through mobility, and fail to take the simplest precautions against hypothermia.

Through the program, members of the Woodsproofing Committee of Waverley Ground Search and Rescue hope,

1. to provide a large number of children, especially younger children, with basic information about how they should react if they become lost;
2. to provide parents and other adults with information about prevention; and,
3. through exposure and interaction with children, encouraging their trust in members of ground search teams, who would no longer be regarded as "strangers".

Disclaimer

The term "woodsproofing" is a misnomer, as it suggests there is some assurance that children will actually use the information they receive from the program, and that the information, even if it is used, is guaranteed to save them in all possible situations.

We can make no such guarantees.

We employ the term as a convenience, for communicating to the public (who are already familiar with the term "streetproofing"), and because of its conventional usage to denote similar programs elsewhere.

The program we provide is aimed at teaching several basic principles to children (and their parents) that will help ground search teams find the most children in the shortest amount of time and with the least amount of discomfort to the lost child. Nevertheless, suggestions for a more accurate label are welcome.

Methods

Overview.

As presently constituted, the Woodsproofing program is aimed primarily at boys and girls between five and ten years of age, and their parents.

Though the specifics of individual sessions may vary, the overall structure of the program is the same:

1. children and their parents are shown the film entitled "Lost in the Woods" (see Appendix),
2. parents and other adults are separated from the children, and the two groups are spoken to by team members who specialize in these respective tasks, and
3. the groups are subsequently reunited for some less formal activity, such as a demonstration by the team's dog handler, followed by informal interaction between team members and the audience.

Parent participation.

Involvement of the parents in the Woodsproofing session is considered important for two reasons:

1. it is felt that the concept of prevention would be more fruitfully discussed with the parents than their children, and
2. the ability of the child to use woodsproofing skills may depend on how they believe the parent will respond to their being lost.

Regarding the latter point, a child who expects his parents to be angry may be reluctant to remain put and wait for searchers to find him; rather, he may fearfully thrash through the woods in the hope of finding his way out as soon as possible.

Consequently, during the woodsproofing session, parents are asked to clearly communicate the message to their child that they will not react punitively should the child become lost.

In addition, participation by the parents in the child's woodsproofing should enhance the child's involvement in the session and the perceived significance of the lessons being taught.

Preparation.

Some preparation is necessary before the session is to begin.

First, there should be one WGSR person in charge, who is responsible for scheduling the event, recruiting sufficient WGSR people to attend the session, bringing the film, projector, extra reel, extension cord, screen, and books, and generally overseeing the events of the session.

A minimum of two WGSR people are required to present a woodsproofing session, so long as the size of the group of children is small (about 15 or fewer). One person will address the children, the other will speak to the adults.

However, the session will be more successful if additional team members are also present, preferably dressed in orange coveralls, backpacks, and gear (e.g., radios). The sight of WGSR people in full search attire tends to facilitate interaction between team members and the audience, and provides the child with an opportunity to see what a searcher looks like, should they ever become lost.

Introduction and film presentation.

When ready to begin the session, the team member in charge should stand before the group and introduce him/herself to the audience. In a sentence or two, he or she will briefly describe the scheduled events, i.e., that a film will be presented, and that afterwards we would like to speak with the children and adults separately, because we have different things to talk to them about.

At that point, the children are asked to come to the front of the room and sit on the floor before the screen. No child over five should be allowed to stay back with his or her parent, if it can be avoided.

The film tends to build feelings of tension and parental concern; parents who are observed watching the film with their children typically spend considerable time consoling the child nonverbally, such as holding and patting.

We want to delay the release of this parental concern in order to maximize the parent's motivation to cooperate with our suggestions about prevention (described below).

Post-film discussion: the children.

The children should be addressed by someone who feels comfortable with an audience of this age range and is able to establish rapport.

The speaker should either crouch or sit on a chair with the children huddled on the floor around him.

The children's attention should be captured and maintained as much as possible, without becoming heavyhanded or "bossy."

One useful approach is to insist (in a friendly way) that the children raise their hands when they want to answer a question ("just like in school").

This also provides the advantage of calling on the more reticent, shyer children for their input as well (even the ones who don't raise their hands), before answers can be blurted out by the more gregarious children.

The speaker can begin the session by introducing himself and any other WGSR people there.

The objective for this part of the discussion is to ensure, through repetition, that the children remember four basic points made in the film:

1. to stay in an open place,
2. to stay warm by buttoning up your coat,
3. to cover your head, and
4. to build a survival bed of leaves and tree boughs.

Additional points about not eating strange berries or hugging a tree are optional and up to the discretion of the speaker; however, it should be noted that the more one tries to teach the younger children under these circumstances the less they will remember.

After making the statement about raising hands, the speaker can ask the children, "What happened to Calvin?" (the boy in the film).

After the children answer (usually emphatically) that Calvin "got lost," the speaker can ask how this happened.

The children typically respond with the fact that he was following a deer.

You can elaborate this with something like, "That's right! He was following a deer and not paying attention to where he was going." (Always reward the children's responses; there are no "wrong" answers.)

It is best to emphasize throughout the discussion that Calvin reacted intelligently to his predicament. He did "all the right things," because he was a "smart kid" (a comment one searcher actually makes in the film).

This will highlight the fact that he is someone to emulate and to learn from.

The speaker can ask, "What was the first 'right thing' that Calvin did, once he realized he was lost?"

The correct answer is that he stayed in an open place, rather than continuing to try to find his way out of the woods.

The second 'right thing' is that he buttoned up his jacket to stay warm; the third is that he covered his head with his hood; and the fourth is that he built a survival bed to provide further protection from the elements.

Calvin was scared, but he kept cool; he remembered all the things to do that he had been told about.

Repetition is necessary if the children are going to remember the four points under conditions of high stress and anxiety - that is, should they become lost themselves.

Each time an additional "right thing" is introduced, previous points should be repeated. Use the same wording each time, and get the children to recite along with you as you go through the list of "right things."

Pretend you can't remember them yourself, children will enjoy the game of reminding you what all the right things are.

Repeat the list until you're sure they'll remember it, then go through it once again. It's better to err on the side of overkill.

At this point, you can change the focus of the discussion from the film to the children themselves.

Ask if any of them have ever been lost. Some hands may go up rather tentatively, and you might hear some tall tales about being lost in the woods under harrowing conditions much worse than Calvin's.

Frequently, though, no one raises their hand.

Now ask if anyone has ever been lost in the shopping centre or the supermarket and you'll get a more positive response.

Then ask those children what they did when they got lost. Almost always, they will answer that they told "someone who works there."

Repeat this phrasing to the children. The point you want to get across is that, when you are lost, some strangers are safe to approach for help.

One hurdle for a successful Woodsproofing session is to overcome the typical warning not to speak to strangers, and certainly not to follow them anywhere.

The point of using the shopping centre example, which many children are familiar with, is that you can get around this hurdle by using an exception that the children are already aware of, rather than trying to introduce a new exception.

Thus, when a child is lost in the woods, search and rescue people are safe (despite the fact they are strangers) because "they work there" (in the woods, looking for lost people).

A third and final objective for the discussion with the children is to talk about how their parents will react if they should indeed happen to get lost in the woods.

Begin this discussion by asking the question, "How do you think your Mom and Dad will feel if you become lost, and you're late for supper?"

Many children have difficulty answering this question, because the phrase "late for supper" suggests parental anger and punishment. Some will answer that their parents would be "sad," and you should reward these answers enthusiastically.

Elaborate on this with phrases like "terribly worried," or "scared to death," emphasizing that anger would be the farthest thing from the parent's mind.

Finally, add the statement that, "When (not 'if') you're found, your Mom and Dad would be very happy to see you, and probably give you a big hug."

Among children's worst fears is abandonment by the parents, the withdrawal of love and concern.

For example, a not uncommon worry is that the parents will have moved away while the child is attending school, and not a few children have emitted, at one time or another, an internal sigh of relief to find the family car still parked in the driveway.

When a child is lost in the woods, this fear can be magnified to the dimensions of terror, making a panic reaction all the more likely.

You can confront this fear directly by asking the question, "If you got lost, would your parents wait a few days for you to come home, or what?"

You'll receive some nervous laughter, because even young children realize that this fear is irrational.

Emphasize that, in fact, parents will know that their child is lost, that they will be very worried about them, and that they will send someone to look for them right away. That "someone," of course, is us.

Post-film discussion: the parents.

The objective for the discussion with the children's parents is prevention. There are two general areas to be addressed.

One area refers to practical steps that parents can take to prevent their child from wandering off in the woods and getting lost, and the second has to do with the child's attitude.

Regarding the practical steps, suggest to the parents that they purchase some brightly colored forestry tape ("flagging"), available at many sporting goods stores and other retail outlets (e.g., Canadian Tire).

When the family goes camping, the parent can use the tape to mark off a clearly visible perimeter, beyond which the child is instructed not to travel without an adult.

Families who live near wooded areas can engage in a similar activity around their homes. As the child grows and becomes increasingly familiar with the area inside the tape, the perimeter can be extended.

A related activity, which should be recommended, is that the parent take the child for a walk (it could be the same time as the perimeter is being set up) and engage the child in building a survival bed.

The child should be allowed to pick the "best spot" (an open space), and to gather sufficient boughs and leaves to make the bed (advise the parents not to chop down any branches, as the child will not have this advantage should he ever need to make a survival bed).

The parent can pretend to "tuck" the child into his new bed. This will likely be an enjoyable activity and will help ensure that the child will remember this important step should they ever become lost.

This is a skills-oriented approach to prevention. An alternative approach, one which is found in many families who live near wooded areas, is a policy of avoidance.

That is, children are instructed (usually quite ominously) not to go into the woods at all.

This policy is comparable to telling children who live by the sea not to go near the water, for fear of drowning, rather than teaching them to swim.

Children who are kept out of the forest, through parental fears of their becoming lost, are being deprived of an educational experience and an esthetically pleasing place to play.

What is worse, they are totally unprepared, both emotionally and practically, in the event that they should wander into the woods anyway, despite parental admonitions.

No parent realistically expects their child to mind them 100% of the time. However, parents whose children have received woodsproofing, and who live near wooded areas, should be less apprehensive about the consequences of their child straying beyond the perimeter.

Other ways that parents can prepare their children for the woods include always ensuring that the child has adequate protection from hypothermia. The point should be made that hypothermia kills many more people in fair but wet weather than in cold weather.

There are many types of compact windbreakers and plastic sheets that fit into pouches; these can easily be slipped into a pocket or a backpack. The low-budget version is a large, orange garbage bag, which provides an instant portable tent (the child can poke a hole to see out).

Children should also be provided with a whistle, hanging from a lanyard around the neck, with instructions to blow three times if they need help (and only then).

Children can also be provided with high-calorie foods, such as dried fruit or candy, a provision which few children will object to carrying.

Unfortunately, many children will likely consume these "emergency" supplies at their first opportunity.

As important as these skills and provisions are to the child's survival, the most important thing a parent can do is to facilitate in their child the appropriate attitude toward being lost.

Recall that, coincidentally with the parental discussion, the children are being told that their parents will not be angry at them if they become lost and will not punish them when they're found.

We would be irresponsible to assume that this will always be true, and to let it go at that. A major objective of the parental discussion is to ensure that the parents understand that, if they need someone to blame, it is the parents' fault if the child gets lost - not the child's.

Consequently, they should make sure that they communicate to their children the very points that we make to the children during the woodsproofing session:

1. that they will not be angry at them if they become lost, and
2. that they will send people to look for them right away.

Children who are persuaded of these statements are better prepared emotionally to control their panic and to follow the basic survival steps, especially regarding staying in one place.

In fact, parents should be instructed to communicate this message immediately upon rejoining their children after the discussion. Almost all parents will gladly comply with this request.

Problems to avoid.

Actually, if you remember to bring all the equipment, have sufficient manpower to run the session, and have good directions about how to find the location, there will be few problems of any consequence. However, one area that is sometimes problematic is dealing with a group of kids (usually boys) who have gotten out of control.

The first rule is never to allow yourself (or any other WGSR person) to be put in charge of controlling the children (either intentionally or by default). That is, always make sure there is at least

one leader around who will stay in the vicinity of the children and will take the initiative in controlling them if they get out of hand.

Thus, when the parents and children separate, one or two of the group leaders could be asked to stay in the room with the children. It's a good idea to mention this request to the group leader before the session begins.

On the other hand, if you find that unruly behaviour is a frequent problem during the children's sessions, you might wonder whether the sessions are lasting too long, or even if your presentation of the discussion might be the problem.

Talking to young children, especially involving them in an extended conversation, is harder than it looks; you may be losing their interest after the first few minutes of the discussion. Try watching someone who seems to be good at it, then have them watch you leading a discussion, with the goal of making some constructive criticism.

Summary

The following is an outline of the central points discussed in this paper:

I. Discussion With the Children:

1. Stay in an open place.
2. Button up your coat to stay warm.
3. Cover your head.
4. Make a survival bed of leaves and tree boughs.
5. "Mess up your yard" (leave clues for searchers).

Additional points:

6. Searchers are "safe" strangers.
7. Your parents will worry about you and send searchers right away.
8. When you're found your parents won't punish you.

II. Discussion With the Parents:

1. Parents are responsible for prevention - don't blame the child.
2. Establish perimeters around camp sites and homes near wooded areas.
3. Practice making a survival bed with your child.
4. Make sure your child understands that you won't be angry if they become lost.

Appendix: Materials

VHS Video or Book

"Lost in the Woods" [SARBC](#), P.O. Box 187, Victoria, BC, V8W 2M6

Book

Colleen Politano (author), LOST IN THE WOODS: CHILD SURVIVAL, Porthole Press, Ltd., 2082 Neptune Road, Sidney, BC V8L 3X9

Addendum: 1996

The "Woodsproofing for Children" program was developed in the fall of 1986 by the Waverley team in response to the death of 9-year-old Andy Warburton.

Since that time more than 50,000 children (really!) in Nova Scotia have received woodsproofing as described herein.

There is at least one documented case where a woodsproofed child had benefitted from this training, and several known cases where woodsproofed children had been found by family or neighbors in their "hasty searches" before calling the police.

We used to have to search for at least one or two children every year, sometimes more. Since the woodsproofing program began, 10 years ago, we've had only one search for a lost child in the targeted age group (knocking on wood).

Remember: "The best search is the one you don't have to conduct."

Kenneth Hill, Search Director, Waverley Ground Search and Rescue khill@husky1.stmarys.ca

[Back to Child Survival Page](#)

[Back to Ken Hill's Page](#)

[Home Page](#) | [Index](#)

Last Updated: Thursday, 25-Dec-2003 13:00:26 PST
by [MCDPRI](#)

Welcome to the Lost in the Woods Request an Instructor page
Please fill out the form and someone will contact you.
For other contacts, please see our Contacts page.

Enter your e-mail address

Enter your name

Organization

Address 1

Address 2

City

Province

Postal Code

Country

Contact Phone Numbers

Dates Required:

First Choice

Second Choice

For Instructor:

How large a group?

What age group?

Where is the workshop to take place?

Optional - Leave a comment?

If you would like to leave a private [message](#) about these pages, click on [message](#).



Copyright © 2004 Search and Rescue Society of British Columbia

P.O. Box 187

Victoria, BC V8W 2M6

250-384-6696 fax 250-383-6849

E-mail: [SARBC Contacts](#)

Last Updated: Sunday, 22-Feb-2004 16:19:22 PST

by [MCDPRI](#)



Welcome to the Lost in the Woods Media Order page
Please fill out the form to order the Lost in the Woods Instructor Kit.
For other contacts, please see our Contacts page.

Enter your e-mail address

Enter your name

Organization

Address 1

Address 2

City

Province

Postal Code

Country

Contact Phone Numbers

SHIP the package to (if different than above):

Enter your name

Organization

Address 1

Address 2

City

Province

Postal Code

Country

Visa or Mastercard Credit Card Information:

Enter the number (no spaces or dashes)

Enter the Expiry Date

Name as shown on the Card

Instead of using the form, just call us at 250-384-6696 to order your kit.

Optional - Leave a comment?

If you would like to leave a private [message](#) about these pages, click on [message](#).



Copyright © 2004 Search and Rescue Society of British Columbia

P.O. Box 187

Victoria, BC V8W 2M6

250-384-6696 fax 250-383-6849

E-mail: [SARBC Contacts](#)

Last Updated: Sunday, 22-Feb-2004 16:19:22 PST

by [MCDPRI](#)



Welcome to the Lost in the Woods Media Loan Request page
To Borrow the Kit, please fill out the form and someone will contact you.
For other contacts, please see our Contacts page.

Notice: the Kit will be available by May 2004

Enter your e-mail address

Enter your name

Organization

Address 1

Address 2

City

Province

Postal Code

Country

Contact Phone Numbers

SHIP the package to (if different than above):

Enter your name

Organization

Address 1

Address 2

City

Province

Postal Code

Country

Dates Required:

First Choice

Second Choice

For Instructor:

How large a group?

What age group?

Optional - Leave a comment?

If you would like to leave a private [message](#) about these pages, click on [message](#).



Copyright © 2004 Search and Rescue Society of British Columbia

P.O. Box 187

Victoria, BC V8W 2M6

250-384-6696 fax 250-383-6849

E-mail: [SARBC Contacts](#)

Last Updated: Wednesday, 03-Mar-2004 22:18:53 PST

by [MCDPRI](#)



Quick Reference Math

SARBC

Search and Rescue Society of British Columbia

Keep in mind that SARBC assumes no responsibility for the use or mis-use of information provided here.

Math and Info Pocket Card templates in Acrobat PDF format

[Basic Formulae, Proportional POA, Height of Object](#) (PDF document - 12k)

[Team Leader info, Terrain Analysis, Acronyms, BC layout](#) (PDF document - 14k)

[Numerical Influence of Clue, O'Connor, Probability Zones, Scenario Analysis](#) (PDF document - 17k)

[Speed Tables](#) (PDF document - 9k)

[Influence of Clue - full page](#) (PDF document - 10k)

[O'Connor Method - full page](#) (PDF document - 5k)

The following formulae are included in the Pocket Card templates above.

Consideration of the maximization of the ROW POA - through the utilization of resources and area segment coverage (single/multiple - same/different resources)

ROW POA[updated] = ROW POA[current] / (1-OPOS)

The ROW POA as calculated by shifted POA should be the same as this result.

OVERALL POS

OPOS = (POD 1)*(POA1) + (POD2)*(POA2) + (PODn)*(POAn)

Relative Increase

For what-if use of resources

RI = 100(ROW POA[updated] - ROW POA[current] / ROW POA[current])

Proportional POA

Some people feel more confident using values which are proportional (or relational) to each other. They don't want to worry about whether or not they add up to 100%. Also see next page for the O'Connor method (letters).

To use proportional initial POA's, don't worry about whether the values add up to 100%.

Example:

		Converted to %
Segment 1	- 29	21%
Segment 1	- 35	25%
Segment 1	- 40	28%
Segment 1	- 18	13%
Segment 1	- 13	9%
ROW	- 5	4%
TOTAL	- 140	100%(rounded)

Potential Clue Influence Levels for Search Segments

A - Clue strongly suggests subject is in segment
 B -
 C - Clue suggests subject is in segment
 D -
 E - Clue suggests nothing about subject in/not in segment
 F -
 G - Clue suggests subject is not in segment
 H -
 I - Clue strongly suggests subject is not in segment

Clue Authenticity Ratings

Clue is Very Likely Authentic
 Clue is Likely Authentic
 Clue is Even: As Likely Authentic as Not
 Clue is Likely Not Authentic
 Clue is Very Likely Not Authentic

Numerical Influence of Clue

Potential Influence Level
Authenticity Rating

	A	B	C	D	E	F	G	H	I
Very Likely Auth	100.0	70.7	50.0	35.4	25.0	17.7	12.5	8.8	6.3
Likely Auth	100.0	77.1	59.5	45.9	35.4	27.3	21.0	16.21	2.5
Even: Auth/Not Auth	100.0	84.1	70.7	59.5	50.0	42.0	35.4	29.7	25.0
Likely Not Auth	100.0	91.7	84.1	77.1	70.7	64.8	59.5	54.5	50.0
Very Likely Not Auth	100.	100.	100.	100.	100.	100.	100.	100.	100.

This allows us to reflect the Influence of a clue to POA's, and change them accordingly.

To apply the values above to the current POA distribution, use the following formula.

$$D = S1[\text{old}] * IOC[1] + S2[\text{old}] * IOC[2] + S3[\text{old}] * IOC[3] + \dots + Sn[\text{old}] * IOC[n]$$

(S=area segment POA)

$$S1[\text{new}] = (S1[\text{old}] * IOC[1] / D * 100$$

$$S2[\text{new}] = (S2[\text{old}] * IOC[2] / D * 100$$

$$S3[\text{new}] = (S3[\text{old}] * IOC[3] / D * 100$$

$$\dots$$

$$Sn[\text{new}] = (Sn[\text{old}] * IOC[n] / D * 100$$

To reverse the effect of a bad clue, apply the complement of the bad clue to the current POA distribution to undo its effects.

To use the O'Connor method (letters) instead of the Mattson Method (percentages):

A - Very Likely
 B -
 C - Likely
 D -

- E - Even Chance
- F -
- G - Unlikely
- H -
- I - Very Unlikely

O'Connor Method - Relative value to determine initial POA's

	VERY LIKELY		-	<-	->	-	VERY UNLIKELY		
	A	B	C	D	E	F	G	H	I
If lowest letter used is:									
A	1								
B	2	1							
C	3	2	1						
D	4	3	2	1					
E	5	4	3	2	1				
F	6	5	4	3	2	1			
G	7	6	5	4	3	2	1		
H	8	7	6	5	4	3	2	1	
I	9	8	7	6	5	4	3	2	1

As an example, If you evaluated area segments and they ranged from Very Likely to Unlikely (A - G), then, going down the side to "G", use the numbers under the top row.

If there were 4 area segments, and they were evaluated as:

- Segment 1 - G
- Segment 2 - A
- Segment 3 - C
- Segment 4 - D

Then:

- The total will be 17 (7+1+5+4) or (G+A+C+D)
- The person's POA for Segment 1 is 7/17
- The person's POA for Segment 2 is 1/17
- The person's POA for Segment 3 is 5/17
- The person's POA for Segment 4 is 4/17

Which now have to be converted to percentages:

Seg 1 - 41% Seg 2 - 6% Seg 3 - 29% Seg 4 - 24% = 100% (rounded)

Area - with variable searcher spacing (meters/feet) and searcher speed (Km or Mi per hour)

(Sq Km)
 AREA = (# searchers x hours x speed x spacing) / # sweeps x 1000

(Sq Mi)
 AREA = (# searchers x hours x speed x spacing) / # sweeps x 5280

Scenario Analysis
 (Conditional Probabilities)

Segment	Initial POA		Weighted POA		Planning POA
	Area A	Area B	Area A(p=.70)	Area B(p=.30)	
1	.30	.10	.70 x .30=.210	.30 x .10=.030	.210+.030=.240
2	.25	.05	.70 x .25=.175	.30 x .05=.015	.175+.015=.190
3	.20	.05	.70 x .20=.140	.30 x .05=.015	.140+.015=.155
4	.10	.30	.70 x .10=.070	.30 x .30=.090	.070+.090=.160
5	.05	.25	.70 x .05=.035	.30 x .25=.075	.035+.075=.110
6	.05	.20	.70 x .05=.035	.30 x .20=.060	.035+.060=.095

ROW	.05	.05	.70 x .05=.035	.30 x .05=.015	.035+.015=.050
	(p = probability that scenario is valid)				
	Area A (Seg 1-3)		Area B (Seg 4-6)		

Scenario Analysis is the consideration of alternate search scenarios. It is common for an overhead team to consider all the segments in a search area and assign POA's. Each planner is assuming his/her scenario and assigning POA's accordingly - accounting for a divergence between planners for each segment. Indeed, five people may allocate their POA according to five different scenarios, that is, making entirely different assumptions about the lost person's behaviour. As a result, the averaged, or Mattson POA's may be less than optimal for planning purposes.

Scenario analysis involves having the Plans Chief present a number of explicit scenarios to those assigning POA's to the segments. They are asked to estimate the probability of each scenario (as decimal). Planners then assign POA's to all of the segments for each of the scenarios.

For example:

If there are two scenarios, planners would estimate POA for each segment twice.

Once a planner has assigned POA to every segment for every scenario, each POA is weighted by multiplying it by the probability of the scenario to which it applies.

The weighted POA for each segment are then summed across scenarios, yielding one set of POA for a given planner.

These planning POA can then be averaged with the POA from other planners in the usual manner, yielding a set of consensus or Mattson POA with which to plan the search.

The table above represents hypothetical POA for one planner.

The planner has assigned a probability of .70 for Area A and .30 for Area B. His un-weighted POA assignments appear in the 2nd and 3rd columns. In the 2nd column, for example, these POA estimates are made under the assumption that the Area A scenario is valid, while POA appearing in the 3rd column pertain to the Area B scenario.

[Home Page](#) | [Back to Analysis and Math Page](#) | [Index](#)

Last Updated: Thursday, 25-Dec-2003 13:01:37 PST
by [MCDPRI](#)

SAR Computer Programs

- [CASIE3.ZIP](#)
- [EMSW120.ZIP](#) Windows program - roster, training records, etc. - easily configured for SAR apps (642k)
- [PODSHT20.ZIP](#) Excel worksheet - Probability of Detection - POD (32k)
- [RURF.ZIP](#) Windows program for Relative Urgency Rating Factors (417k)
- [SCENARIO.ZIP](#) DOS program - Scenario Analyzer (36k)
- [SCHMASTR.HQX](#) MACINTOSH program - Searchmaster (Ken Hill) - It is a general purpose search management utility, having much similarity to CASIE III (with additional features, such as graphics capabilities for estimating segment sizes, utilities for determining distance and direction between two map points, etc., etc.) (use BinHex 4.0 or Stuffit to convert - 216k)
- [SHIFT131.ZIP](#) SHIFTPOA V1 R3.10 - DOS Search analysis program for Search Managers - other related programs included (415k) - Y2K compliant
- [SOS.ZIP](#) Windows program for managing air-marine searches - demo (1450k - 1996)

Navigation Related Computer Programs

- [The Navigation Page](#) Many Map, GIS and GPS resources

Misc Computer Programs & Files

- [FTP Directory of /pub/ems/sar/programs](#) SAR programs
- [FTP Directory of /pub/ems](#) Programs for SAR, EMS, Fire, Etc.
- [FTP Directory of /RESCUE](#)
- [Computers in SAR Digest](#) Text files
- [TRIAGE1.ZIP](#) Principles & Practices - Part 1 - DOS - from ERRI (526k - 1994)

Dive related Computer Programs

- [CDIVER.ZIP](#) Dive Log - DOS - needs CDIVEDLL.ZIP as well (466k - 1994)
- [CDIVEDLL.ZIP](#) Dive Log - DLL's (396k - 1994)
- [NITROX.ZIP](#) Worksheet for using Nitrox (190k - 1994)
- [SCUBA.ZIP](#) Dive Tables - DOS - based on 1987 RDP (PADI) (47k - 1988)

Marine related Computer Programs

- [DEVIAT.ZIP](#) Marine deviation calc program -DOS (30k - 1992)
- [FLOAT.EXE](#) Float plan for Windows (312k - 1993)
- [MNAV_D1.ZIP](#) Marine oriented DOCS and PGMS - DOS - 1/3 (200k - 1990)
(A couple could be used for land SAR too)
- [MNAV_D2.ZIP](#) Marine oriented DOCS and PGMS - DOS - 2/3 (232k - 1990)
(A couple could be used for land SAR too)
- [MNAV_D3.ZIP](#) Marine oriented DOCS and PGMS - DOS - 3/3 (230k - 1990)
(A couple could be used for land SAR too)
- [TIDES304.ZIP](#) Tides for Pacific Northwest - DOS program (123k - 1994)
For BC coast take this and BCTIDCUR.ZIP
- [BCTIDCUR.ZIP](#) Tides for US Pacific Northwest - DOS (155k - 1993)
Data for BC coast take this and TIDES304.ZIP

[See the Links too](#)

BEHAVIOUR CHARACTERISTICS

SARBC

Search and Rescue Society of British Columbia

LOST PERSON BEHAVIOUR CHARACTERISTICS

Small Children (1 - 3 yrs)	Fishermen
Small Children (3 - 6 yrs)	Mentally Retarded
Children (6 - 12 yrs)	Despondents
Hunters	Miscellaneous
Hikers/Climbers	Skiers
Walkaways - Elderly, Alzheimer	Nova Scotia - All Categories

[SPEED TABLES](#) [STATISTICS](#)

[Lost Person Behaviour](#)
 Distances Traveled by Category of Subject
 343 cases studied - from Ken Hill, Nova Scotia

NEW [Distance Traveled During Urban and Suburban Walks Led by 3- to 12-Year-Olds](#) **NEW**
Tables for Search Managers
 by Edward H. Cornell and C. Donald Heth

These Stats are compiled from U.S. sources, except Climber Stats (Canada). and stats from Nova Scotia and Alberta

These Stats are NOT complete. Use your own judgement when considering them.

BEHAVIOUR CHARACTERISTICS OF SMALL CHILDREN (1-3 YRS)

		MI	
Median	Hilly	.3dn	
	Flat	1.2	
33% up			
11% same			
56% down			
Hilly	25%Z	.1 up	.4 dn
	50%Z	.5	.5
	75%Z	1.5	1.4

- No concept of being lost.

- No navigational skills.
- Tend to wander aimlessly.
- Remain in general area.
- Attracted by random events (a tunnel, path or animal).
- Usually found sleeping (anywhere--against a rock, under/in a log, under a bush, under a picnic table).

DETECTABILITY

90% in good weather
 75% in bad weather
 (will retreat if weather foul)

TRAVEL AIDS

57% used paths, trail
 (others scoot under bush)

[Top of Page](#)

BEHAVIOUR CHARACTERISTICS OF SMALL CHILDREN (3-6 YRS)

		MI	
Median	Hilly	.3d	
	Flat	1.2	
33% up			
11% same			
56% down			
Hilly	25%Z	.1 up	.4 dn
	50%Z	.5	.5
	75%Z	1.5	1.4
	89%	1.6	2.6

- Have definite interest (playmate, pet or exploring).
- More mobile, can go further than 1-3 yr old.
- Attracted by something familiar.
- Concept of lost, try return home or go back to someplace they are familiar with.
- When tired, will sleep in some shelter (cave, hollow).
- Stranger resistant at first.

DETECTABILITY

90% in good weather
 75% in bad weather
 (will retreat if weather foul)

TRAVEL AIDS

57% used paths, trail
 (others scoot under bush)

[Top of Page](#)

BEHAVIOR CHARACTERISTICS OF CHILDREN (6 - 12 yrs)

		MI	
Median	Hilly	1.6dn	
	Flat	1.2	
33% up			

8% same			
58% down			
Hilly	25%Z	1.0 dn	2.0 dn
	50%Z	.5 up	2.1 dn
	75%Z	2.0 up	4.0 dn
	92%	2.6 up	4.1 dn

- Oriented to familiar setting, confused in a strange environment.
- May intentionally run away if mad, or to avoid punishment, or gain attention.
- May not answer until cold/hungry.
- Similiar fears as adult, only enhanced - greater sense of fear/loneliness/helplessness.
- Navigation & direction skills much more developed.
- Often lost as a result of being placed in a strange environment by adults.
- Often will not answer when called, darkness usually brings on a willingness to accept help & be found.

DETECTABILITY

65% in good weather
 10% in bad weather
 (will hide if weather foul)

TRAVEL AIDS

87% used paths, trail

YOUNG PERSONS:

93% found within 2 mi.

[Top of Page](#)

BEHAVIOUR CHARACTERISTICS OF HUNTERS

		MI	
Median	Flat	1.6	
	Hilly	2.0dn	
6% up			
11% same			
83% down			
Hilly	25%Z	1.8dn	2.8dn
	50%Z	.7dn	3.1dn
	75%Z	.8up	4.0dn
	93%	3.0up	6.0dn

- Tend to concentrate on game, not navigation.
- Tend to overextend into dark and push beyond physical abilities.
- Often try to take short cuts.
- Tendency to follow game to dense underbrush or deep snows, deadfall areas, boulder fields, etc. with little regard for exhaustion or navigation.
- Often only prepared for the day.
- Unprepared for extremely foul weather-heavy storms/improved hunting.
- When weather turns colder most take shelter.

REASON LOST: Disoriented, misjudge time/distance, accidental or intentional separation

DETECTABILITY

83% in good weather * Communicative
 66% in bad weather * Mobile
 Detectability enhanced due to bright clothing

17% wear dark clothing

TRAVEL AIDS

39% used natural drainages
(paths, trails usually not available)

- Generally 15-35 yrs old.
- 85% good physical condition.
- Most are in good mental condition.
- 33% have much experience, most have limited experience.
- 80% properly equipped & clothed, 50% no survival training (East US).
- 40% adequate equip/clothing, 40-50% questionable, 20% inadequate for Colorado.
- Cause - human error caused by subject.
- Weather a factor in 18%, darkness in 33%.
- Many wander about and go cross-country (in the west).
- Civilization and landmarks not attractors.
- 66% found within 2 mi from PLS.
- Calif. 87% found within 5 mi.
- Colo. 78% found within 5 mi.
- East US 97% found within 4 mi.
- 90% not moving for more than 24 hrs.
- Calif. and Colo. 45% moved at night. East US 80% moved at night.
- 25-60% found by SAR using attraction, confinement, hasty and heli-search.
- 25-45% found themselves.

[Top of Page](#)

BEHAVIOUR CHARACTERISTICS OF HIKERS

	MI		
MEDIAN	2.5dn		
25% UP			
20% SAME			
55% DOWN			
Hilly	25%Z	2.0dn	3.0dn
	50%Z	.6dn	3.6dn
	75%Z	.4up	6.1dn
	83%Z	4.0up	6.0dn

- Generally relies on trails with set destination.
- Trails create problems if overgrown, snow covered, poor junctions, slide over trail, trail not maintained, poorly defined junctions.
- Mismatched abilities:one may get tired, fall behind and eventually get disoriented/lost.
- Take other trails or short cuts - cutting switchbacks-leading to disorientation or going down wrong hill or drainage.
- Poor or no map or compass.
- Very dependent on trails and travel aids for navigation.

REASON LOST: 40% Disoriented
20% accidental & intentional
separation, poor supervision
25-30% misjudge time/distance

DETECTABILITY

75% in good weather
67% in bad weather

TRAVEL AIDS

75% used paths, trail or drainage

- Largely under 30 yrs old. 33% are 10-15 yrs old.
- Good physical and mental condition.
- Not necessarily experienced, less than 20% with much experience, most with little experience.
- 40% adequately equipped/clothed, 30% questionable, 30% not.
- Cause - human error caused by subject, weather, darkness.
- 82-90% found within 5 mi of PLS.
- 67% found within 2 mi of PLS.
- 92% moving less than 24 hrs.
- 30-40% travelled at night.
- 40% found by hasty team.
- 17% confinement/attraction instrumental.
- 5% found by dogs.
- 3% found by line searchers.

Those who travelled more than 10 mi, also descended several thousand feet, and followed trails, as opposed to going cross-country.

[Top of Page](#)

BEHAVIOUR CHARACTERISTICS OF Hiker-Climbers

CLIMBERS:

- Range from "Hill walkers" to "Scramblers" to "Rock climbers" to "Ice climbing" to "Alpine Mountaineering".
- Best climbing ages are "30-35" not uncommon "14-60".
- Climb for the pure joy of climbing.
- They do not need to have a great deal of physical strength nor superior co-ordination.
- Avalanches are the major cause of fatalities.
- Falling is the major cause of injuries.
- Stranded by weather or rock fall (landslide).
- Well equipped and self-sufficient.
- Tend to stay on or near routes.
- ** Check for scuff marks near cliff.

Many climbing accidents never get reported because of pride.

1959 to 1982

No. of accidents	Canada - 365	B.C. - 158
No. involved	Canada - 733	B.C. - 312
No. injured	Canada - 283	B.C. - ?
No. killed	Canada - 139	B.C. - 66

Break-down for 4w's and how climbers were injured or killed in CANADA.
(Sorry, no stats for U.S.)

TYPE OF TERRAIN	GOING UP/DOWN	ESTIMATE OF EXPERIENCE
ROCK - 236	ASCENDING - 250	LITTLE OR NONE - 248
SNOW - 212	DECENDING - 159	MODERATE - 165
ICE - 29	UNKNOWN - 39	EXPERIENCED - 180

AGE OF CLIMBERS / MONTH OF ACCIDENT

UNDER 15	11	JAN	6	JULY	136
15 - 20	158	FEB	27	AUG	140
21 - 25	160	MAR	26	SEPT	25
26 - 30	112	APRIL	10	OCT	20
31 - 35	46	MAY	25	NOV	3
36 - 50	58	JUNE	26	DEC	5
OVER 50	6				
UNKNOWN	152				

IMMEDIATE CAUSE OF ACCIDENT / CONTRIBUTORY CAUSES

SLIP AND FALL	231	CLIMBING UNROPED	83
FALLING OBJECT	107	EXCEEDING ABILITIES	105
EXCEED ABILITIES	34	INADEQUATE EQUIPMENT	53
FAILURE OF EQUIPMENT	29	FAULTY EQUIPMENT	13
STRANDED	29	PARTY SEPARATED	9
ILLNESS	23	CLIMBING ALONE	28
FAILURE TO STAY ON ROUTE	11	ILLNESS	7
UNKNOWN	15	DARKNESS	7
OTHER	11	BAD WEATHER	14

AFFILIATION WITH CLIMBING CLUBS

UNAFFILIATED	103
AFFILIATED	202
UNKNOWN	272

[Top of Page](#)

BEHAVIOUR CHARACTERISTICS OF WALKAWAYS - Elderly, Alzheimer's, etc.)

		MI	
Median	Flat	1.0	
	Hilly	1.2dn	
70% down			
Hilly	25%Z	.5dn	1.8dn
	50%Z	0.0	2.4dn
	75%Z	.4up	2.6dn
	90%	1.0up	3.0dn

- May be affected by senility or Alzheimer's; mentally retarded, or a form of psychosis.
- Sometimes oriented to the past.
- Behaviour characteristics very similar to that of children.
- Easily attracted by things.
- Active ones will overexert themselves.
- If active and lucid, likely to overextend self rapidly.
- High hypothermia risk - lower normal temperatures.
- Many have suboptimal nutrition, are less able to generate heat from reserve calories, and are poorly clothed.

*** 44% travelled more than 4 mi (Calif.), 84% (East US) less than 2 mi.

DETECTABILITY * Often deaf or hard of hearing
59% in good weather
10% in bad weather
(Difficulty in locating subjects, most found in prone position regardless of weather condition)

TRAVEL AIDS
47% used travel aids - (hunters used path or game trail).
Those lost in bush areas seldom used any type of trail.
Frequently found under brush, or in densely treed areas.

[Top of Page](#)

BEHAVIOUR CHARACTERISTICS OF FISHERMEN

- Usually well oriented.
- Reason accident related, usually boat - swept of feet,
● boat overturned or went over waterfall, falls over cliff.
- Often recovery mission.

DETECTABILITY

TRAVEL AIDS

[Top of Page](#)

BEHAVIOUR CHARACTERISTICS OF MENTALLY RETARDED

	MI
Flat median	1.2
Hilly median	1.6
33% up	
8% same	
58% down	

- Act and react similar to kids 6-12.
- Usually does not respond to name called.
- Remain in same area for days.
- Usually hidden from view - fright, hiding from elements.
- No physical impairments but will not help themselves.
- Easily attracted by sights and sounds.
- May set off to explore without any sense of direction or how to return.

DETECTABILITY

(kids 6-12)
65% in good weather
10% in bad weather
(due to bad weather crawl under logs, heavy branches)

TRAVEL AIDS

67% used travel aids - (used paths, game trails, streams or drainages).
33% were found in brushy areas.

[Top of Page](#)

BEHAVIOUR CHARACTERISTICS OF DESPONDENTS

FLAT TERRAIN	
MEDIAN	.8 MI
RANGE	.06-2.1 MI
50% Z	.4-1.0 MI

- Often seeking solitude.
- Usually found within sight and sound of civilization.
- All maintain they weren't lost - merely getting away to think.
- Felt intruded upon.
- Some avoided being found.
- (US) Found near prominent locations ex. scenic lake/hill, lookout.
- (US) Tend not to go into underbrush.
- (US) Most tend to go upward to distinctive locations.
- (CAN) Tend to settle down in first secluded spot, often next to a tree.
- (CAN) Attracted to secluded, open spaces, surrounded by trees, some distance away from trails. Don't travel far.

DETECTABILITY

Not responsive to searchers - feel it is an intrusion upon their solitude.

TRAVEL AIDS

Usually stay in one place.

[Top of Page](#)

BEHAVIOUR CHARACTERISTICS OF MISC. CATEGORY

		MI	
Median	Flat	1.6	
	Hilly	1.6dn	
Hilly	25%Z	.6dn	1.6dn
	50%Z	0	3.0dn
	75%Z	1.4up	3.1dn
	84%	2.5up	3.2dn
66% went down			

- Pinecone, berry, mushroom pickers; rock hounds; photographers.
- Poor survival risk.
- Go in good weather, no extra clothing.
- Generally unprepared (physically, clothing).
- Complete disorientation.
- Attempts to find their way usually gets them further into trouble - because of disorientation.
- Intentions are usually to stay in one location.
- Doesn't know the area.
- Little or no food, water or survival gear.

REASON LOST: disoriented, poor supervision, intentional separation

DETECTABILITY

75% in good weather

50% in bad weather

(will retreat if weather foul) * high % are communicative.

TRAVEL AIDS

50% used paths, trail or drainage

- More cases for young [<8 yrs old] and older [>60 yrs old].
- Generally good physical condition.
- 65-70% in good mental condition.
- 40-50% adequately equipped.
- 45-55% properly clothed, 30% questionable, 15% not.
- Cause - human error, caused by subject.
- Greater likelihood to wander about or go cross-country.
- 69% found within 2 mi of PLS.
- 90% found within 5 mi of PLS.
- 33% found within 1/2 mi of PLS.
- 90% not moving more that 24 hrs.
- 30-50% move at night.
- Found by variety of techniques.

[Top of Page](#)

BEHAVIOUR CHARACTERISTICS OF SKIERS

- Generally under 35 yrs old.
- Almost all are in good physical and mental condition.
- 33% have much experience, significant number with some experience.
- Generally well equipped and clothed.
- 60% have survival training.
- Cause - Human error caused by subject - 33% weather, 20% darkness.
- 54% found within 2 mi. from PLS.
- 82-85% found within 5 mi.
- 83% are not moving more than 24 hrs.
- 30-45% move at night.
- 50% found by hasty search, visual tracking. 50% by themselves.

REASON LOST:

Disoriented, misjudge time/distance

30% accidental & intentional separation.

20% poor or no map.

DETECTABILITY

* 50% Mobile * Almost all are communicative

TRAVEL AIDS

Used path or trail or drainages.

25% attracted by civilization.

[Top of Page](#)

[Home Page](#) | [Index](#)

Last Updated: Thursday, 25-Dec-2003 13:01:30 PST
by [MCDPRI](#)

SPEED TABLES

SARBC

Search and Rescue Society of British Columbia

SPEED TABLES
Hiker Speed Table
Bike Speed Table
Canoe Speed Table
Ski Touring Speed Table
Snowshoeing Speed Table

These Stats are compiled from U.S. sources.

These Stats are NOT complete. Use your own judgement when considering them.

SPEED TABLES Hiker Speed Table

MPH = Miles per Hour

MPD = Miles per Day

	LEVEL-MPH	LEVEL-MPD	LEVEL-MPH	LEVEL-MPD	UPHILL-MPH	UPHILL-MPD
CATEGORY	NO PACK	NO PACK	WITH PACK	WITH PACK	NO PACK	NO PACK
Beginner	1.5-2	8-12	1-1.5	7-9	.75	5
Experienced	2-2.5	12-15	1.5-2	10-12	1	6-8
Expert	3-4	16-24	3	12-18	1.25-2	8-12

	UPHILL-MPH	UPHILL-MPD	DNHILL-MPH	DNHILL-MPD	DNHILL-MPH	DNHILL-MPD
CATEGORY	WITH PACK	WITH PACK	NO PACK	NO PACK	WITH PACK	WITH PACK
Beginner	.5	3	2	7	1.5	5
Experienced	.75	6	2-3	9-10	2	7
Expert	1-1.5	6-10	2.5-3.5	10-14	2-2.5	10

[Top of Page](#)

SPEED TABLES Bike Speed Table

H = Hilly or Headwind

MPH = Miles per Hour

MPD = Miles per Day

	LEVEL-MPH	LEVEL-MPD	LEVEL-MPH	LEVEL-MPD
CATEGORY	NO PACK	NO PACK	WITH PACK	WITH PACK
Beginner	5	15-30	4	10-20
Experienced	10	40-60	8	30-50
Expert	16	60-100	13	50-80

	H-MPH	H-MPD	H-MPH	H-MPD
CATEGORY	NO PACK	NO PACK	WITH PACK	WITH PACK
Beginner	4	10-20	2.5	8-15
Experienced	8	30-50	6	25-40
Expert	13	50-80	10	40-60

[Top of Page](#)

SPEED TABLES Canoe Speed Table

MPH = Miles per Hour

MPD = Miles per Day

	NO WIND	NO WIND	HEAD WIND	HEAD WIND	TAIL WIND	TAIL WIND
CATEGORY	MPH	MPD	MPH	MPD	MPH	MPD
Beginner	1	4-6	.5	2-3	1.5	5-8
Experienced	2	10-12	1-1.5	6-9	3	12-18
Expert	3	14-18	1.5-2	9-12	3.5	16-21

[Top of Page](#)

SPEED TABLES Ski Touring Speed Table

MPH = Miles per Hour

MPD = Miles per Day

TRACK/TRAIL				
CATEGORY	MPH-NO PACK	MPD-NO PACK	MPH-WITH PACK	MPD-WITH PACK
Beginner	1.25	8	.75	4.5
Experienced	2.5	15	1.5	9
Expert	3-3.5	21	2.25	14

NO TRACK/TRAIL				
CATEGORY	MPH-NO PACK	MPD-NO PACK	MPH-WITH PACK	MPD-WITH PACK
Beginner	.5	3	.25	1.5
Experienced	1.25	8	.75	4.5
Expert	2	12	1	6

[Top of Page](#)

SPEED TABLES

Snowshoeing Speed Table

MPH = Miles per Hour

MPD = Miles per Day>

BROKEN TRAIL				
CATEGORY	MPH-NO PACK	MPD-NO PACK	MPH-WITH PACK	MPD-WITH PACK
Beginner	.75-1	4-6	.5	1-3
Experienced	2	12	1	6
Expert	2.25	15	2	10-12

UNBROKEN TRAIL				
CATEGORY	MPH-NO PACK	MPD-NO PACK	MPH-WITH PACK	MPD-WITH PACK
Beginner	.5	3	.25	1.5
Experienced	1	6	.75	4
Expert	1.25	8	1	6

[Top of Page](#)

[Back to Behaviour Characteristics](#)

[Back to POL Page](#) | [Back to Incident Management](#)

[Home Page](#) | [Index](#)

Last Updated: Thursday, 25-Dec-2003 13:00:41 PST
by [MCDPRI](#)

Lost Person Behaviour

Distances Traveled by Category of Subject

Nova Scotia, Canada

(343 Cases)

<i>Category</i>	<i>No. of Cases</i>	<i>Median</i>	<i>Range</i>	<i>50% Zone</i>
Hunters	117	2.40 km 1.49 mi	.10 - 19.31 km .06 - 12.00 mi	1.50 - 3.83 km 0.93 - 2.38 mi
Hikers	38	2.24 km 1.39 mi	.22 - 24.00 km .14 - 14.91 mi	1.38 - 4.20 km 0.86 - 2.61 mi
Fishers	35	1.43 km 0.89 mi	.45 - 17.70 km .28 - 11.00 mi	0.86 - 3.82 km 0.53 - 2.37 mi
Misc. Adults	39	1.80 km 1.12 mi	.10 - 19.00 km .06 - 11.81 mi	0.81 - 3.83 km 0.50 - 2.38 mi
Youths (13-15 yrs)	23	1.49 km 0.93 mi	.40 - 7.00 km .25 - 4.35 mi	0.93 - 2.93 km 0.58 - 1.82 mi
Children (7-12 yrs)	13	1.48 km 0.92 mi	.14 - 8.00 km .09 - 4.97 mi	0.90 - 2.41 km 0.56 - 1.50 mi
Young Children (1-6 yrs)	13	1.10 km 0.68 mi	.40 - 2.65 km .25 - 1.65 mi	0.67 - 2.01 km 0.42 - 1.25 mi
Despondents	27	0.81 km 0.50 mi	.10 - 5.63 km .06 - 3.50 mi	0.50 - 1.28 km 0.31 - 0.80 mi
Walkaways	38	0.95 km 0.59 mi	.10 - 5.43 km .06 - 3.37 mi	0.50 - 1.55 km 0.31 - 0.96 mi

*Compiled by Ken Hill (khill@husky1.stmarys.ca)
Halifax Regional Search and Rescue
April, 2001*

Incident Command System

SARBC

Search and Rescue Society of British Columbia

The Incident Command System section

[ICS Forms for Search and Rescue](#)

[ICS Forms Catalog](#)

From the FTP library:

[ICSHELP.ZIP](#)

Windows Help files - ICS forms manual, Incident Commander Field Book, Field Ops Guide (552k)

[ICS.ZIP](#)

Microsoft Access database - ICS forms to interactively fill in (during incident), and docs.
(1meg - each over 4 megs expanded)

The original DB from New Mexico was for Ver 1.1 of Access. It has been converted to Access 2 and Access 97. Both versions are in the zip file.

[SOFC.ZIP](#)

Standards Of Fire Cover Database - from Australia (168k)

[Home Page](#) | [Index](#)

Last Updated: Thursday, 25-Dec-2003 13:01:39 PST
by [MCDPRI](#)

Incident (Overhead) Management

SARBC

Search and Rescue Society of British Columbia

The Incident (Overhead) Management section

[Search/Incident Management Forum](#)

[Decision Aids for Search and Rescue Forum](#)

Usenet-like, with support for threaded discussions, keyword searches, reply quoting, icons, etc.

Aeronautical / Marine SAR - Canada

◆ [CASARA Management Forms and Policy Manual](#) *Not complete - contact CLO for complete package*

◆ [National SAR Manual - Canada](#)

Ground SAR - Canada

◆ [An Introduction to Ground Search Management for the Police Authority](#) Kenneth A. Hill, Ph.D.

◆ [Crime Scene Investigation *** More Forensics Links](#)

◆ [Computer Programs and Math for SAR](#)

◆ [Checklist for Evaluating SAR Research](#) Kenneth A. Hill, Ph.D.

◆ [Incident Command System Overview](#) a SAR ICS Model

◆ [Incident Command System \(ICS\) National Model](#)

◆ [ICS Glossary of Terms](#) MDI SAR

◆ [Interviewing - Tips](#) as a Lesson Plan

◆ [Interviewing - Tips](#) as a Powerpoint presentation (85k)

◆ [Kern County Office of Emergency Services, SEMS - STANDARDIZED EMERGENCY MANAGEMENT SYSTEM - ICS](#)

◆ [Lost Person Behavior Characteristics](#)

◆ [Lost Person Behavior Research - Distance Travelled by Category](#) Kenneth A. Hill, Ph.D. ***

◆ [Next of Kin - Your Most Valuable Resource](#)

◆ [Probability of Location \(POL\)](#)

- ◆ [Quick Reference Math](#)
- ◆ [Role of the Management Team in a Large Search](#)
- ◆ [Search and Rescue - A Workable Format](#) Five Paragraph Operation Order [SMEAC] - from the 80's, but timeless
- ◆ [Search Management Rationale](#) rationale for good management, and more - from the 80's, but timeless
- ◆ [Search Probability Theory](#) history of POD, and team exercises - from the 80's, but timeless
- ◆ [SAR-L Discussion List Page](#) for more items/links from the folks on the list - incl ICS
- ◆ [Selecting, Managing, and Motivating Your Overhead Team](#) by James Cooke - from [BASARC Home Page](#)
- ◆ [Time Line Analysis](#)

[See the Links too](#)

[Home Page](#) | [Index](#)

Last Updated: Thursday, 25-Dec-2003 13:01:48 PST
by [MCDPRI](#)

Probability of Location (POL)

SARBC

Search and Rescue Society of British Columbia

Probability of Location (POL)

[Mike Doyle](#)

Have you ever wanted to mark the spot on a map, showing the location of a missing person? For a few of the lost person [categories](#), this is possible to a point. You may end up with more than one "X" on the map. But at least you can send teams to check the "X"s out, instead of just sending searchers to the traditional high POA area segments.

Some of the information relating to predicting the location of a missing person would be found in [Behaviour Characteristics](#), [Speed Tables](#), [Missing Person Statistics](#), [Questionnaire](#) items (age, carrying, plans, psych profile, terrain profile, medical profile, weather profile, etc.), witnesses, friends, family, co-workers, etc.

More information can be found in publications from [NASAR](#)

Really good [Interviewing](#) skills are important. Without information, it is difficult to run an effective search. Planning is guesswork at best.

The area of search planning that has received the least amount of attention, is [Time Line Analysis](#). **NEW!** Without a contiguous time line, planning becomes dependent upon guesswork again. Analysing a Time line is of paramount importance for predicting lost person behaviour and location.

It is all very well to go out with the high tech gadgets, and the high tech search patterns, but why not go to the "X"s first?

How do you predict where the "X"s are? Start with the above, know your missing person, law of opposites, and, time line. Is that it? No, much more discussion is needed.

I'm going to say that the stats mentioned here are reasonably old, and haven't been updated with the new stuff.

To kick off "X" marks the spot (POL), why not look at a specific category.

Starting with "Despondent", it is my *personal* experience that one can very quickly come up with a few likely spots - one of which the subject will be at.

I'm sure you have knowledge of other categories, where the subjects have fit a set of behaviour characteristics. If so, you know where the next one is likely to be. Is there a category where POL cannot be used effectively?

If anyone has any thoughts on the matter they wish to share, please leave a post in the [Probability of Location Discussion area](#).

Probability of Location background and support files

- This is a new Discussion area.

  [Probability of Location Discussion Forum](#)

- Usenet-like, with support for threaded discussions, keyword searches, reply quoting, icons, etc.
-

- ◆ [Behaviour Characteristics](#) by Category
 - ◆ [Interviewing - Tips](#) as a Lesson Plan
 - ◆ [Interviewing - Tips](#) as a Powerpoint presentation (85k)
 - ◆ [Missing Person Questionnaire](#)
 - ◆ [Speed Tables](#) Hiker, Biker, Canoe, Etc.
 - ◆ [Missing Person Statistics](#)
-

See these pages for related information

- ◆ [Critical Incident Stress \(CIS\)](#)
 - ◆ [Hypothermia](#)
 - ◆ [Incident Management](#)
 - ◆ [Lost in the Woods](#)
 - ◆ [Navigation](#)
-

[Home Page](#) | [Index](#)

Copyright © 1996-98
Last Updated: Thursday, 25-Dec-2003 13:01:43 PST
by [MCDPRI](#)

Map and Compass

SARBC

Search and Rescue Society of British Columbia

This Map and Compass section comprises:

- ◆ [Compass Direction Finder](#)
- ◆ [Ed Williams' Aviation Page](#) Why? Good decl calc and more...
- ◆ [Geomagnetic Field Synthesis Program Input Form](#) *Interactive!*
- ◆ [GSC Canadian Geomagnetic Reference Field](#) calculate Magnetic Declination using MIRP - *Interactive!*
- ◆ [GSC Magnetic Declination](#) (What do you mean "North isn't North")
- ◆ [GSC North Pole](#) Tracking the North Magnetic Pole
- ◆ [How To Use a Compass](#)
- ◆ [Kyoto University in Japan](#). The seven magnetic parameters - 1995 BW world charts
- ◆ [Magnetic Field Program Download User Information Form](#) Free Software
- ◆ [Map Tools](#)
- ◆ [National \(USA\) Geophysical Data Center - 1995 world chart in Color](#)
- ◆ [Orienteering](#)
- ◆ [TopoZone - The Web's Topographic Map](#) **NEW!**
- ◆ [Understanding and Using a Compass](#)
- ◆ [Understanding and Using a Map](#)
- ◆ [Map and Compass Glossary](#)
- ◆ [Map and Compass Appendix](#)
- ◆ [Navigation Links](#)
- ◆ [North Magnetic Dip Pole](#) So, where is it?

[Also see the Navigation Page for much more, including GPS](#)

[Home Page](#) | [Index](#)

14385 E-mail: [Ray Talson](#)

Last Updated: Thursday, 25-Dec-2003 13:01:26 PST

Navigation

SARBC

Search and Rescue Society of British Columbia

[Clock](#)

[United States Naval Observatory Time](#)

The Navigation section

Map and Compass

[Directory of /pub/data - USGS DEM's Digital Maps](#)

[Map Datasets Digital Maps](#)

[Map and Compass](#) from a long time ago - to now - lots of stuff!

[Robert's GIS/Mapping Page](#)

[Sam Wormley's Maps & Mapping Agencies](#)

[Sam Wormley's UTM - Universal Transverse Mercator Resources](#)

[TOPORAMA](#) Canadian maps from Natural Resources Canada **NEW!**

[USGS Mapping Information: Home Page](#)

[WORLD OF MAPS](#) Maps for anywhere - World - Rec, Travel, etc.

Map related Computer Programs

[Coordinate Conversions - Programs](#)

[DOWNLOAD GSMCAD AND GSMAP SOFTWARE](#)

[Directory of /pub/personal/victorf - Victor Fraenckel's ftp site](#) UTM <-> Lat/Long programs

- Inverse -- for dist. between two lat/lon pairs
- Direct -- input lat/lon, az & dist; derive lat/lon
- Rule2LL -- scale lat/lon from quad sheet
- UTM2LL -- UTM -> lat/lon
- LL2UTM -- lat/lon -> UTM
- and more...

[ftp.blm.gov GIS Utilities](#)

[Malcolm Drury's website for UTMCON.ZIP](#) DOS *freeware* program for Lat/Long - UTM grid conversion (64k) - New Ver 3.0 **UPDATED**

[Geographic Magnetic Calculator](#) UTM-Lat/Long Converter from this page

No Map and Compass or GPS: No Problem!

[Bushwalker's Guide to the Galaxy](#)

Emergency Locator Transmitter Direction Finding

[MAEL/DF88 Simulation](#)

GPS Computer Programs and related - FTP download

[Directory of /pub/pcsoft/utms](#) Software from government - UTMS converts geographic coordinates Universal Transverse Mercator (UTM) coordinates - from [NGS \(NOAA\)](#)

[FTP Directory of /navigation](#) Lots of items here

[GPS/Amateur Radio Workstation Software](#)

[GPS FTP directory](#) Peter Bennett's FTP directory - Public Domain Files - Marine too

[GIS Utilities - ftp.blm.gov](#) Software from government - LLUTM.ZIP - Quickbasic src/exe for lat/lon to/from utm

[GPS.ZIP](#)

GPS info to computer using com port, formatted - WIN (307k - 1994)

[GPXFER.EXE](#)

GPS waypoints from computer to GPS - DOS (159k - 1995)

[JNAV82.ZIP](#)

GPS info to computer using com port, logging - DOS (115k - 1993)

[MAEL/LLCalc Operation](#) Lat-Long Calculator for Win95

[RockWare, Inc. - Earth Science Solutions](#)

Global Positioning System (GPS) Computer Program and Info WWW Links

[A Practical Guide to GPS -With Emphasis on UTM](#)

[Dave Ransom Software Home Pages](#)

<http://www.cnde.iastate.edu/maps.html> Digital Maps

[Fugawi Moving Map Navigation Software for GPS Receivers](#)

[Garmin Web Site](#)

Amateur Radio call signs, Direction Finding simulator, Lat/Long calculator, Telemetry program, and more

[GPS Information Source - MIT GLONASS](#)

[GPS Kindergarten &Up](#)

[GPS links](#) Global Positioning System links - info

[Global Positioning System \(GPS\) - A comprehensive introduction](#) University of Texas

[GPS Navigation in Land Search](#) Hill, Bower

[Global Positioning System \(GPS\) Resources](#) Excellent links to resources

[GSS Geomatics Information Center](#)

[Handheld GPS's in backcountry](#)

[Index of /igsch/software/qc/dos/](#) Software from government

[Land Surveying and Geomatics: Software](#) Excellent ***

[NAVSTAR Global Positioning System](#)

[Sam Wormley's Global Positioning System \(GPS\) Resources at ISU](#)

[US Coast Guard Navigation Center - GPS, DGPS, LORAN, OMEGA, LNM](#)

[USNO GPS Data & Information Files](#)

Emergency Management and Search Systems

Emergency Management Informations Programs

[ESRI - Home of The GIS People](#)

ARC View/Info

Search Operations System - Marine and Air Search Programs - designed for RCC's

[Home Page](#) | [Index](#)

NIGHT VISION

SARBC

Search and Rescue Society of British Columbia

Review

There are two types of sensors in the eye: rods and cones.

Cones function well in brightly lit surroundings, perceive colour and much detail.

Rods are far more sensitive than cones, giving night vision with the pupils wide open. Rods do not distinguish colours or see fine detail.

Both rods and cones respond to a wide range of colours, but rods are very insensitive to red light.

Rods respond to various colours, but give a sensation only of black, grey or white.

Rods and cones are distributed non-uniformly across the retina.

Cones are only in the center. While in the periphery, the rods dominate.

Thus, the best visual acuity in good illumination is obtained for that part of the image focused on the center (fovea). The eye is most sensitive in conditions of weak illumination to images focused off-center (on the periphery of the retina).

Rods are de-sensitized by light (very quickly). It takes 20-30 minutes to re-sensitize (or dark adapt).

If light is needed, yet it is important to keep eyes dark-adapted, then use a red filter on the light. Rods are not sensitive to red light.

Night Observation Procedures

- look for shapes, shadows, contrast and movement
- since the center of the pupil is insensitive, all looking should be toward a side
- Eyes should be kept in motion - to keep the rods at their peak of sensitivity
- don't stare directly at a sighted object
- to avoid eye fatigue, every few minutes the observer should close their eyes for a few seconds to allow them to rest

Remember:

- allow eyes to become dark-adapted
 - colours are not discernable
 - details cannot be seen
 - use red light only
-

Using Binoculars at night

One measure of the effectiveness of binoculars for night use is *exit pupil*. This is the diameter of the bundle of light rays exiting toward the eye from the eye-piece of the binoculars.

This number is found by dividing the objective lens diameter by the power (7x35 = 5mm exit pupil, or, 7x50 = 7mm exit pupil). The pupil of the eye is about 7mm when fully dialated. If the exit pupil is less than 7mm, then the eye isn't fully used.

(For day use, a small exit pupil is satisfactory, since the eye pupil is only about 2mm in diameter. However, the large exit pupil is advantageous because of ease of centering the eye behind the eye-piece.)

Use

Binoculars should be held aimed straight forward and the eyes turned off-center - to avoid using the insensitive center of the retina. This requires practice, but is very effective.

[Back to Basic & Team Leader Page](#)

[Home Page](#) | [Index](#)

Last Updated: Thursday, 25-Dec-2003 13:00:48 PST
by [MCDPRI](#)

Search (SAR) Dogs

SARBC

Search and Rescue Society of British Columbia

The Search (SAR) Dog section

This is a new usenet-like Discussion area, with support for threaded discussions, keyword searches, reply quoting, icons, etc.

[Tracking Trailing Scenting SAR Dog Discussion Forum](#)

Search K9 Articles

 [Using Dogs as Ground Search Resources](#)

 [General Info \(77 Facts\)](#)

 [Dog Term Glossary](#)

 [Dog Training - General](#)

 [Picking a Dog Handler](#)

 [Water Search](#)

 [Understanding Search Dogs](#)

Search K9 Sites to Visit

- [911BC K-9 Search and Recovery Team](#)
- [1st Special Response Group](#)
- [Absaroka Search Dogs Home Page](#)
- [Alaska Search and Rescue Dogs \(ASARD\)](#)
- [ARDA-American Rescue Dog Association](#)
- [Arizona Search Track and Rescue, Inc.](#)
- [Avalanche Rescue Dog's World](#)
- [Beartooth Search Dogs, Montana](#)
- [Barren River Area Search Dog Association](#)
- [Brazos Valley Texas Search & Rescue Team](#)
- [Canine Outfitters](#)
- [Canine Search and Recovery](#)
- [Canine Search and Rescue](#)
- [Central Montana Bloodhound Search Team](#)
- [CHESARDA Chesapeake Search & Rescue Dogs](#)
- [Disaster And Wilderness Ground Searchers, Inc. K-9](#)

- [Durham Search and Rescue Dog Team](#)
- [ÉLETJEL Rescue Team from Hungary](#)
- [Florida Special Response Team K-9](#)
- [GLSAR of Michigan Home Page - K9 Unit](#)
- [Highland Detector Dogs](#)
- [K-9 Search Rescue Unit and Training Center](#)
- [K-9 Alert Search and Rescue Dogs, Inc](#)
- [K9 Emergency Response Teams \(KERT\)](#)
- [Les chiens de la Gendarmerie](#)
- [Leerburg Home Page K9 training - books & videos](#)
- [Louisiana Search And Rescue Dog Team](#)
- [Michigan Search Dog Association](#) **NEW!**
- [Mid-Atlantic D.O.G.S. Search and Rescue Team](#)
- [National Bloodhound Association of Switzerland \(NBAS\)](#) Excellent site - Good Info!
- [National Bloodhound Training Institute](#)
- [National Disaster Search Dog Foundation Home Page](#) **Updated**
- [North American Search Dog Network](#)
- [NC SAR Dog Association, Incorporated](#)
- [Northeast Search and Rescue K-9 Service, Stroudsburg, PA](#)
- [Obstacles, Inc. - 800.281.1601](#)
- [Ohio K-9 Search Team, Inc.](#)
- [People and Paws SAR](#)
- [RCMP Civilian Search Dog Association - Alberta](#)
Excellent resource for civilian SAR K9 and Handler RCMP training standards, and much more.
- [REDOG Homapage](#)
- [Rescue International K9 Training Page](#)
- [RiverBend Search and Rescue Dog Association](#)
- [SAR dogs Australia](#)
- [SAR-Dogs Resource web](#)
- [Sedgwick County Emergency Management K9 Search Team](#)
- [SOSARD Web Site - Southern Ontario Search and Rescue Dogs](#)
- [Specialised Search Dog Response Rescue](#)
- [Tri-State Search and Rescue Dogs](#)
- [WCSAR - Wake Canine Search & Rescue, Inc., Raleigh, NC, USA - Homepage](#)
- [Westhaven's Raven V Salmans](#) and their new SAR page [Search and Rescue Dogs in Canada](#)
- [U.K.S.A.R.D \(United Kingdom Search And Rescue Dogs \)](#)
- [World Kennel Club/Cliff Culp](#)

Ticks, Lyme Disease & Ehrlichiosis Sites for K9 & Handlers

- [Ehrlichiosis Page](#)
- [Emergence of the Ehrlichioses as Human Health Problems](#)
- [Entomology Image Gallery: Insect Pictures](#)
- [Lyme Disease Foundation](#)
- [Lyme Disease Links](#)
- [National Lyme Disease Network](#)
- [Managing Lyme Disease](#)
- [Tick-Borne Illnesses](#)

Other

- [Dogs Against Drugs](#)
- [SAR Dog Community Calendar](#)
- [SAR, Guide, Guard and Family GSDs](#)

[Home Page](#) | [Index](#)

Last Updated: Thursday, 25-Dec-2003 13:42:42 PST
by [MCDPRI](#)

Rope Rescue Page

[Search and Rescue Society of British Columbia](#)

Rope Rescue

Postings from people interested in Rope Rescue - evaluation, testing, use, experiences, agree/disagree, what's best/worst, etc.

- This is a new usenet-like Discussion area, please use this one instead of the 2nd one.
◆ [Rope Rescue Discussion Forum](#)
 - Usenet-like, with support for threaded discussions, keyword searches, reply quoting, icons, etc.
-

Please note that these pages are for discussion only.
If you are not familiar with rigging systems, *do not* try these out.

A New Look at an Old Problem

- ◆ [Point Loading](#) on Litter Rigs
- ◆ [Rotational Litter Rigs](#) Roto rigs
- ◆ [Multi Point Force Distributing Anchor](#) M.P.F.D.A.
- ◆ [More Anchors](#) Mazinaw, Kanata, Outouais
- ◆ [R.A.D. SYSTEMS](#)

New stuff for comment or discussion

- ◆ [A Knot for Equalizing Anchor Systems](#) *for comment - graphics - there are 7 jpgs on the page - from 17-48k each*

Links to conventional, new and SRT information

- ◆ [AMSAR Technical Rope Rescue Seminar - American Search & Rescue Institute, Inc.](#)
- ◆ [Belay Article from Technical Rescue Magazine Issue Eight](#)
Test of manual and automatic belay devices on different ropes ***
From the [Technical Rescue Articles page](#) from [Technical Rescue Magazine](#)
- ◆ [Belay Article Update - December 1996](#)
Test of manual and automatic belay devices on different ropes ***
From the [Technical Rescue Articles page](#) from [Technical Rescue Magazine](#)
- ◆ [Considerations for Rope Rescue](#)
by Kenneth N. Laidlaw - from [BASARC Home Page](#)

- ◆ [Expedition Rescue Guide \(Caving\)](#)
- ◆ [Lifeline '97 - annual fun highline - pics](#) held near Mt. Arrowsmith on Vancouver Island - June 27-July 1, 1997
- ◆ [OA Guide to Belaying at the Climbing Wall](#)
- ◆ [Urban H.A.R.T. - Equipment Spotlight \(September\)](#) MIO rope grab device

Knots - more Knots

- ◆ [Climbing Knot Dictionary - Illustrated](#) From Dave Hunt **UPDATED**
- ◆ [Knots on the Web \(Peter Suber\)](#) Great collection of links to other knot resources
- ◆ [Knot Primer for the Blue Ridge Mtn. Rescue Group Inc.](#)
- ◆ [Ropers Knots Page](#) Knot site on knot-work in real rope and lines **UPDATED**

Keep in mind that SARBC assumes no responsibility for the use or mis-use of information provided here.

[SARBC Home Page](#) | [SARBC Index](#)

Last Updated: Thursday, 25-Dec-2003 13:01:31 PST
by [MCDPRI](#)

"Urban" Search and Rescue

SARBC

Search and Rescue Society of British Columbia

Urban Search and Rescue (USAR)

◆ [Urban Search and Rescue \(USAR\) Discussion Forum](#)

Usenet-like, with support for threaded discussions, keyword searches, reply quoting, icons, etc.

◆ **Urban Search and Rescue (USAR) Discussion List**

To subscribe, email to: LISTSERV@HOME.EASE.LSOFT.COM
and put in the body: **SUBSCRIBE USAR** and your **FULL NAME**

There is also the request that you identify your affiliation and interest in USAR to the list after you join.

"Urban" Search and Rescue

- ◆ [The 5 Stages of Rescue](#) Anyone remember these?
 - ◆ [The 5 Stages of Rescue](#) In More Detail
 - ◆ [Rules for Urban Rescue Response](#)
 - ◆ [Earthquake todo's during and after](#)
-

Links to other "Urban" Search and Rescue sites and information

- [ACUTE COMPARTMENT SYNDROME \(ACS\)](#)
- [American Rescue Team Home Page](#)
- [Disaster Center](#)
- [FEMA Urban Search and Rescue Response System](#)
- [FEMA Urban Search and Rescue Task Forces](#)
- [Santa Barbara County Sheriff's Search and Rescue Team Urban Search and Rescue Training Outline](#)
- [South Florida Urban Search And Rescue Home Page](#)
- [SPECRESCUE INTERNATIONAL](#)
- [URBAN SEARCH AND RESCUE \(LIGHT RESCUE\) PROCEDURES](#) from SBSAR Search and Rescue

[See the Links too](#)

[Home Page](#) | [Index](#)

Urban Rescue - Lite

SARBC

Search and Rescue Society of British Columbia

This Urban Rescue - Lite section comprises:



[HR tools for each medium-sized Building - per floor](#)



[A list for Building Response Personnel](#) Floor Wardens, Fire Wardens, Etc.

[Home Page](#) | [Index](#)

Last Updated: Thursday, 25-Dec-2003 13:01:24 PST
by [MCDPRI](#)

Communications for SAR

SARBC

Search and Rescue Society of British Columbia

This Communications for SAR section comprises:

Web Site information

[Disaster Communications](#) **NEW!**

[ELECTRONIC ENGINEERING TECHNOLOGY SOFTWARE SITE](#)

[Ham Radio Online - Real-Time Disaster Report](#)

[Ham Radio Software and Sites](#)

[Radio Amateurs of Canada](#)

[Telephone Pioneers Amateur Radio Club](#)

[Tucson Amateur Packet Radio \(TAPR\) Home Page](#)

FTP Sites

[Communications manual - pdf format](#) Western State Mountain Rescue Team

From [Chris Kenedy](#) - use Acrobat reader to view it - (WSCMRTC.PDF 1898k)

[Directory of /pub/ham/vhf-work](#)

[Directory of /tapr/SIG/aprssiig/files](#)

[OAK Software Repository](#)

[See the Links too](#)
[Home Page](#) | [Index](#)

Copyright © 1995-2001

Last Updated: Thursday, 25-Dec-2003 13:01:43 PST

by [MCDPRI](#)

Critical Incident Stress

- [Helping Children cope with Disaster](#)
- [Helping Adolescents cope with Disaster](#)
- [Critical Incident Stress Syndrome 1](#) *What is it?*
- [Critical Incident Stress Syndrome 2](#) *What it does*
- [Critical Incident Stress Syndrome 3](#) *Conducting a mini-debriefing*
- [Critical Incident Stress Syndrome 4](#) *Do's & Don'ts*
- [Critical Incident Stress Syndrome 5](#) *Reactions*
- [Critical Incident Stress - DISASTER.ZIP](#) *14 CIS papers - several sources*
- [Self Evaluation Lifestyle Quiz](#) *downloadable as a WP6.1 doc thanks to Keith Austin - STRESS-O.ZIP (4k)*
- [Burnout Quiz](#)

Links to other CIS/Trauma sites and information

- [American Psychological Association PsychNET \(SM\)](#)
- [Behavior OnLine: The Mental Health and Behavioral Science Meeting Place](#)
- [Canadian Traumatic Stress Network](#)
- [Critical Incident Stress Management](#)
- [David Baldwin's Trauma Information Pages](#)
- [Easton-Snelgrove Inc. Managing Critical Incidents - TRAUMA MANAGEMENT - Courses coming up soon!](#)
- [Federation of Behavioral, Psychological and Cognitive Sciences](#)
- [Greg Nail's Home Page](#) *Good Mental Health Resource Page*
- [Growth House - Resource directory for end of life issues](#) *including hospice information, bereavement, and related topics. Good CIS references too*
- [ICISF: Welcome to Our Homepage](#) *(International CIS Foundation)*
- [International Society for Traumatic Stress Studies On Line](#)
- [Knowledge Exchange Network \(KEN\) - National Mental Health Services](#)
- [National Center for PTSD](#) *There are now 10,750 papers covered by this electronic index to the traumatic stress literature*
- [Trauma](#)
- majordomo@listp.apa.org *DISCUSSION LIST FOR SERIOUS MHP's (for list info send: info traumatic-stress)*
- [Victim-Assistance Online](#) *& DISCUSSION LIST FOR CISM*
- [9-1-1 Emergency Services](#)

[See the Disaster Links too](#)

[Add a link](#)

Elementary School Preplan

Search Action Plan for Elementary Schools Prepared by:

Loreen Keefe and Michael Doyle
Search and Rescue Society of British Columbia (SARBC)
March 1988 Updated July 1995

In cooperation with:

Wishart School Principal, staff and parents
Wishart Safe Arrival program volunteers
Colwood Detachment R.C.M.P., Community Policing Branch

Example Elementary School Search Action Plan

INTRODUCTION

There was a case of two missing six year old girls. They disappeared after being dropped off at their Elementary school. They were missing for about an hour. During that time, it became clear that there really was no plan for such an event. The Safe Arrival program volunteers know their program, and know of a child's absence within moments of roll call. But what to do after notification?

SARBC volunteered to draft a plan, which would address what to do next.

The Plan, which follows, is the result of several consultations with school staff, Principal, Safe Arrival program volunteers and the RCMP.

Please note that Sections D-E are School specific.

PREAMBLE

"Safe Arrival Program"

At the beginning of each school year, children are sent home with the "Safe Arrival" Form. Parents are asked to list the following phone numbers:

- home, both parent's business numbers, and three alternate numbers (neighbors, relatives and friends). This information is then put on a rollex card file at the school.
- If a child is to be absent from school, a "Contact Parent" is to be notified.
- Each morning, a volunteer from the Safe Arrival program phones the designated "Contact Parent" and gets a list of all the children who will be absent that day.
- Teachers take "roll-call" at school.
- Absentees are checked with the "Contact Parent's list".
- If a child is absent and not on the list, then the following occurs:
 - Parent(s)/Guardian notified.
If unable to contact the parent/guardian, check back with the teacher to see if the child has arrived in the interim. Siblings are questioned regarding the whereabouts of missing child.
 - If at this point the child is still missing, the "Safe Arrival" volunteer notifies the

Principal of the school.

NOTE : The above procedure is based on the assumption that the child is registered in the "Safe Arrival" program.

NOTE : In the school records, it is noted who is the child's court appointed guardian and any stipulations.

SECTION A GUIDELINES and INSTRUCTIONS

ITEM 1

Safe Arrival program personnel will advise the Principal (Search Coordinator), and will contact parents of the missing child. They will advise parents that their child has not arrived at school. If the child is not at home and parents are unaware of their child's whereabouts, instruct the parents they are responsible for the following:

- Attempt to locate their child by contacting the homes of their child's friends, and check with family and neighbors.
- Check the route the child normally takes to school and areas the child frequents.
- If there is no adult at the child's home, make arrangements for someone to be there, or parents should return home, in case child returns and/or additional information is needed.

Parents must be given a fixed time to locate the child, minimum 20 min - maximum 30 min, with the understanding that the school will be contacting the RCMP after 30 minutes. Advise the parents that if they are unable to locate their child within thirty minutes, they are to contact both their local RCMP Detachment and the school.

*** Obtain description of child's clothing***

ALSO SEE PARENT/GUARDIAN RESPONSIBILITIES

ITEM 2

Missing child's siblings and classmates are to be questioned regarding the following:

- Known intentions of the missing child (identify child's friends).
- Possible sightings of the missing child.
- Areas the missing child frequents/plays.

ITEM 3

Search Coordinator will establish a Search Headquarters - a quiet room with access to telephone, tables, paper, pens, etc.

Search Coordinator is to complete "Missing Child Information Form". (For information: school records, teacher and child's parents)

- Include child's picture on the form as well.
- Photocopy several copies for searchers.

Search Coordinator will stay at search headquarters.

ITEM 4

Search Coordinator will dispatch search teams and document all information and decisions.

Search Coordinator is responsible for the following briefings:

School Staff : Notify that child is missing, description of child and subsequent procedures.

Staff Search Teams :

- Description of missing child -see "Missing Child Information Form".
- Search Procedures :

NOTE: The Search Coordinator will, in advance, assign personnel by function, to search each Zone.

- Building Search - Thorough search of all rooms, including small spaces that a child could hide in. (ie.cupboards, etc.)
- Outbuildings and Grounds Search - Thorough, systematic search for child and possible

articles that the child may have dropped. Periodically, call out the child's name and listen for at least ten seconds for a response.

- In the event of clues or items found, note precisely where found. Bring back to Search HQ.
- Give searchers deadlines to return to Search HQ.
- In the event that the child is found and there is suspicion of foul play, send someone for help, don't disturb the area and administer First-Aid as necessary. (See Section F for more info.)

NOTE: School staff (Searchers), do not leave the school grounds, only "call and listen" from the perimeters. The Search Coordinator will also document the following:

- Child's home address on the map.
- Areas searched and any observations.
- General public sightings (Witness reports).
- Any applicable information for the search effort.

The Search Coordinator will, if the child is not found within 30 minutes, notify the RCMP, and have copies of the following documents:

- Missing Child Information Form - completed.
- Log or list of what has been done so far.
- Map with the school and the child's house identified on it.
- List of areas the child would frequent.

SECTION A PARENT/GUARDIAN RESPONSIBILITIES

The news of a missing child sends a chill through any caring person, especially the Parents or Guardians. Sometimes, what to do first or next seems to be confusing, as thoughts of what could have happened, race through our minds. There are some things which can be done, now.

If a child is found to be missing from school, then the child's Parents/Guardians are notified by the school.

Once notified that their child is missing from school, Parents/Guardians should be prepared to help the search effort by doing the following:

- Arrange to leave work if it becomes necessary.
- Attempt to locate their child by contacting the homes of their child's friends, and check with family and neighbors.
- Check the route the child normally takes to school and areas the child frequents.
- If there is no adult at the child's home, make arrangements for someone to be there, or Parents/Guardians should return home, in case child returns and/or additional information is needed.

Parents/Guardians are RESPONSIBLE for the duties outlined by numbers 2, 3 and 4 above.

Parents/Guardians have a fixed time to locate their child, minimum 20 min - 30 min maximum, with the understanding that the school will be contacting the RCMP within 30 minutes.

If the Parents/Guardians are unable to locate their child within 30 minutes, they are to contact both their local RCMP Detachment and the school.

Give Description of child's clothing to School Search Coordinator.

If the Parents/Guardians feel they must go to the school, they should understand that they come under the direction and control of the Search Coordinator.

SECTION C MISSING CHILD INFORMATION FORM (PLEASE PRINT)

Date: _____ Time (reported missing): _____
Name: _____ Nickname: _____
Password: _____
Parent/Guardian Name: _____
Address: _____ Phone #: _____
LAST KNOWN LOCATION: _____
Age: _____ Mental Age: _____ Sex: _____ Race: _____
Height: _____ Weight: _____ Build: _____
Hair colour: _____ Hair Length: _____
Eye colour: _____ Wear glasses?: _____
Physical characteristics: _____ (ie. scars etc.)
Physical condition: _____
Coat: _____ Shirt: _____
Dress: _____ Sweater: _____
Pants: _____ Skirt: _____ Hat: _____
Other: _____ Boots: _____
Shoes: _____
Runners: _____ Other: _____
Lunch kit: _____ Food: _____
Backpack/School bag: _____ Toys: _____
School books: _____ Other: _____
Home room Teacher: _____ Phone #: _____
Classroom #: _____
Known intentions: _____
Areas child frequents: _____
Ever been lost before: _____ Where found: _____
Actions taken: _____
Point last seen: _____
Home to school arrangements: _____

Transporter's Name: _____ Phone #: _____
Names of child's friends: _____

Description, Names of companion(s), if any: _____

Circumstances of disappearance : _____

**SECTION C
WITNESS REPORT FORM**

Name of witness: _____
Address: _____
Telephone #: _____ Business #: _____
Reached for further information: _____
Time Period at Alternate Number/Address: _____
Time period Time sighted: _____
Location: _____
Direction of travel: _____
Child alone?: _____
Description of incident: (record in own words of witness)

Compiled by: _____

Date: _____ Time: _____

SECTION D
AREAS CHILDREN FREQUENT - SCHOOL SPECIFIC
EXAMPLE ONLY

This would show a map of the area with the following information numbered on the map.

Grade One

- (1) Yards and houses of friends
- (2) Streets near both their own home and friends

Grade Two

School yards of the following schools:

- (3) Wishart
- (4) Dunsmuir
- (5) Sangster
- (2) Friend's homes
- (6) Ocean View Park

Grade Four

- (7) Gravel Pit
- (8) Webb Place - underdeveloped area

Grade Five and Six

- (9) Metchosin Road - near firehall
- (4) Dunsmuir School Ground
- (10) "Forest Area" - off Wishart Road, going towards Metchosin Road
- (11) Reservoir - Latoria Road
- (12) New Town Houses - Mary Anne Crescent
- (12) Play Ground - Mary Anne Crescent
- (7) Gravel Pit
- (13) Winthrop Path - Near Bunker Road

Grade Five

- (3) Fields behind school

Grade Six

- (9, 10) Around Church
- (15) Forest Behind School
- (7) Gravel Pit
- (14) By Johnny's Store
- (3) Path Between Portables

Grade Six and Seven

- (3) Forest beyond School Field

- (6) Ocean View Park
- (9,10) Church Parking Lot
- (10) End of Wishart Place

NOTE : The above areas are located on Colwood Street Maps. (You would see accompanying Map for locations of bracketed items.)

ENTER CHILD'S HOME ADDRESS: _____

SECTION E SCHOOL LAYOUT

This section would show the school layout, as well as, all rooms by floor.

SECTION F PRESERVATION OF EVIDENCE

Compiled from lectures given by RCMP and District Coroner. This information is to be given to Field Team Leaders only in certain situations (this is a very sensitive topic).

In the case of suspected foul play, or death of the missing person:

- Safeguard the scene by sealing off the entire area. Allow only people actually engaged in the investigation into the area. Record the names of all people who came into contact with the scene area. If relieved of this duty by Police officer in charge, note his/her name, and time.
 - a. Note any vehicles in the immediate area and record their licence plate numbers.
 - b. Note any people in the area not involved with the search, and write down a general description of each person.
- The first member on the scene, or the Team Leader if immediately available, will be responsible for completing a file including: names of all persons present; all relevant times; the condition of the scene; the condition, description, and location of the victim; type of day; description of the area; a rough sketch of the scene also noting any peculiar or unusual items or pieces of evidence (signs of struggle, weapons, bloodstains, etc.).
- Try to hold all witnesses, if any, and limit conversation between them. Treat suspects as witnesses, try and hold as a witness.
- In the case of violent or sexual crime, record the FIRST statements of the victim, and who the victim made them to.
- First-aid and evacuation, if necessary, must be the prime concern. However, try to protect the scene as much as possible. Use only the people necessary, the rest of the team must be excluded from the area.
- One person should approach the scene to determine the course of action. The rest of the team should stay back.
- All team members who had any part of 1,2,3,4 or 5 above should record their observations and should be prepared to attend a Coroner's inquest if one is called.

This concludes the Search Action Plan.

Hypothermia

- [Hypothermia Discussion Forum - Usenet Like](#)
- [Res-Q-Air and Heat Treat Discussion Forum](#)
- [Altitude Illness - Hypothermia](#)
- [Cold Injuries from National Outdoor Leadership School](#)
- [Cold Injuries & Cold Water Near Drowning Guidelines "Alaska Protocols"](#)
- [Hypothermia \(cold survival\)](#)
- [Hypothermia - Physiology, Signs, Symptoms and Treatment considerations](#)
- [Hypothermia - Powerpoint - Zip Gaelic Wolf - Hypothermia Download Page](#)
- [Hypothermia - Powerpoint - EXE \(zip\) Download here \(690k\)](#)
- [Hypothermia - Powerpoint - ZIP Download here \(657k\)](#)
- [Hypothermia Prevention, Recognition and Treatment](#)
- [Hypothermia-Related Deaths -- Alaska, October 1998-April 1999](#)
- [Hypothermia - SPECIAL SITUATIONS Andrew D Weinberg, MD An important study to be read! Excellent paper! ***](#)
- [Hypothermia / Surviving the cold / Workers' Compensation Board of B.C. link updated again](#)
- [Hypothermia Treatment Devices, Protocols & Articles Courtesy of Robert Douwens at Res-Q Products](#)
- [OA Guide to Hypothermia & Cold Weather Injuries](#)
- [Safety And Survival Hypothermia](#)
- [Special Report On Cold Stress \(Hypothermia\) And Heat Stress](#)
- [THERMAL AND CARDIOVASCULAR CHANGES DURING THREE METHODS OF RESUSCITATION FROM MILD HYPOTHERMIA John Hayward One of the most important studies to be read! Check out the difference between cardiac, esophageal, tympanic, rectal temperatures. ***](#)
- [Winter Camping and Hypothermia](#)
- [Winter Camping and Hypothermia Information](#)

Hypothermia Graphics

- [Warning Signs of Hypothermia](#)
- [Heat Loss - Losing it 5 ways](#)
- [Treatment in the Field/Hospital](#)
- [H.E.L.P. and Huddle - Cold Water Survival](#)

[More Links](#)

Liability

Some of these articles have appeared in SARNEWS or are published by SARBC

- [Liability of Search and Rescuers - Part 1](#) *Introduction*
- [Liability of Search and Rescuers - Part 2](#) *Case Law*
- [Liability of Search and Rescuers - Part 3](#) *Case Law*
- [Liability of Search and Rescuers - Part 4](#) *Case Law*
- [Liability of Search and Rescuers - Part 5](#) *Case Law*
- [Liability of Search and Rescuers - Part 6](#) *Example Scenarios*
- [Liability of Search and Rescuers - Part 7](#) *Scenarios Continued*
- [Liability of Search and Rescuers - Part 8](#) *(References)*
- [The Risk of Rescue - The Plight of the Good Samaritan](#)
- [A COMPENDIUM OF LEGAL ISSUES IN SEARCH AND RESCUE](#) *from John Chaffey*
- [Liability - on a Search?](#)

See the [SAR](#) and [Disaster](#) Links too



**Safe Homes
Safe Communities**

RCMP 

ROYAL CANADIAN MOUNTED POLICE

Community, Contract and Aboriginal Policing

SEARCH AND RESCUE: RCMP ROLE

[back](#)

In Canada, except within federally owned National Parks, the overall responsibility for land and inland water search and rescue (SAR) rests with the provinces, territories and municipalities. Typically this responsibility is delegated to the police force of jurisdiction.

The police force of jurisdiction in all provinces except Ontario and Quebec; in both territories, and in various municipalities is the Royal Canadian Mounted Police (RCMP). In these areas, police services, including SAR, is performed pursuant to formal police services agreements.

The RCMP recently completed an extensive review of its search and rescue policy and training requirements. The review resulted in a revitalized search and rescue program which will enable the RCMP to provide SAR services in a more effective and cost efficient manner.

In order to achieve these objectives the RCMP is placing special emphasis on:

- Response;
- Interdepartmental Cooperation;
- Prevention, and
- Volunteers.

New initiatives in these areas will create and maintain a solid framework for search and rescue in the areas where the RCMP has a contractual responsibility.

RESPONSE

In the area of response, new RCMP policy will clearly outline the roles and responsibilities of RCMP personnel within a province, territory or municipality.

RCMP SAR Coordinators ensure that regional issues, including policy, training and resources are promptly addressed. Each province or territory served by the

RCMP has a SAR coordinator.

Detachment Commanders ensure that complaints of lost or overdue persons are promptly investigated and a "Lost/Missing Person Report" is compiled. When warranted, a SAR trained RCMP Search Commander is appointed and a search is initiated.

RCMP Search Commanders assume overall on-site authority for the organization and management of the actual search and ensure the search is well organized and managed according to proven management procedures. The assistance of a SAR trained volunteer civilian Search Manager and SAR trained volunteers may be requested.

Initial SAR responses may involve one or more of the following: Police Service Dog Team; trained volunteer SAR civilian dog team; Trained volunteer "Hasty Team" (in some areas RCMP Hasty Teams are used); RCMP helicopter equipped with Forward Looking Infrared (FLIR); trained volunteer "specialist" teams, e.g. avalanche, white water, ice rescue, etc.; trained volunteer SAR divers (although most areas use RCMP Dive Teams); trained human trackers and other SAR trained persons.

Subsequent or more concentrated searches may involve the use of SAR trained volunteer teams; (who conduct open or closed grid searches); the Civil Air Search and Rescue Association (CASARA), or other provincial agencies with SAR capabilities; or in the case of inland water searches, the [Canadian Coast Guard Auxiliary](#) (CCGA).

Training

Under recently released new SAR policy, the minimum training requirement for RCMP Search Commanders will be a "basic SAR" and "SAR management" course.

As a standard for training, the RCMP has formally recognized "basic", "advanced" and "management" SAR courses produced by, or based on the principles of, the United States based Emergency Response Institute (ERI), and the U.S. National Association for Search and Rescue (NASAR).

Canadian courses which meet these standards include, but are not limited to, the Provincial Emergency Program (PEP), in the province of British Columbia, and the Emergency Measures Organization (EMO), in the Yukon.

The RCMP has also initiated action to introduce sessions on SAR at the recruit training level, as well as on Detachment Commander training courses.

These training initiatives will ensure a standard and uniform level of SAR training is provided throughout the RCMP.

Equipment

A variety of RCMP-owned equipment may be utilized in SAR operations. Equipment is generally referred to as "multi-tasked", which means that the equipment used by the RCMP to conduct a wide variety of police services,



- [Home](#)
- [About the RCMP](#)
- [Priorities](#)
- [Programs and Services](#)
- [Operations](#)
- [Strategic Direction](#)
- [Corporate Management and Comptrollership](#)
- [National Police Services](#)
- [Technology](#)
- [Newsroom](#)
- [Careers / Recruiting](#)

including SAR; and "primary SAR" which means the primary purposes for acquiring this equipment was to perform a SAR function.

Multi-tasked equipment owned and operated by the RCMP includes 404 inshore water transport; 8 patrol vessels (8 m or more in length), 26 fixed wing aircraft and 9 helicopters, five of which are equipped with FLIR. The FLIR equipped helicopters are stationed at Vancouver, British Columbia; Edmonton, Alberta; Fredericton, New Brunswick; Gander, Newfoundland and Whitehorse, Yukon. All multi-tasked helicopters are equipped with mounts to accommodate FLIR.

Primary SAR equipment owned and controlled by the RCMP includes: 1 - 7.3 m Zodiac Hurricane 730-0B located in Iqaluit, NWT; 1 - 8.2 m Boston Whaler located in Yellowknife, NWT; 8 - Zodiac markIII Grand Raid Inflatables located at strategic locations in Newfoundland; 1 - 8.2 m welded aluminum cuddy cabin boat located at Agassiz; and 1 - 9.1 m aluminum cuddy cabin located in Hay River, NWT. In some instances, primary SAR equipment is operated by SAR trained civilian volunteers, pursuant to formal written agreements.

Interdepartmental Cooperation

RCMP divisions are identified by a single alphabetic prefix, i.e. British Columbia is "E" Division. An RCMP division generally identified equates to a province or territory ([see map](#)). As the province or territory has overall responsibility for SAR, requirements may vary by region.

RCMP Divisions either have, or will be developing, formal written agreements or Memorandums of Understanding (MOUs) within each provincial or territory served by the RCMP, as well as with other applicable federal departments. These MOUs will clarify the respective roles of each agency.

The agreements will clarify, within the confines of the province, the roles of the Civilian Air Search & Rescue Association, (CASARA); the Canadian Marine Rescue Association (CMRA); Canadian Parks Service; Departments of Forestry and Natural Resources, as well as Workers Compensation Coverage for volunteers and other government and non-governmental agencies with an interest in SAR and provincial expectations or standards for SAR volunteers.

On a national level the RCMP at "HQ" Ottawa works very closely with the National Search and Rescue Secretariat (NSS). The role of the NSS is to enhance the provision of effective, efficient and economical SAR service in Canada by facilitating the development of the National Search and Rescue Plan (NSP). The NSP is a unique undertaking by federal and participating provincial, municipal and private SAR organizations with the objective of saving lives by enhancing SAR prevention and the provision, throughout Canada's accepted areas of responsibility, of effective and affordable SAR services.

RCMP "HQ" is also an active participant on the Interdepartmental Committee on Search and Rescue (ICSAR) which includes representatives from DND, CCG, Parks Canada, Fisheries and Oceans, and Environment Canada.

Prevention

It is often said that if the general public were properly trained through extensive "preventive" programs, there would be few requirements in Canada for either "searches" or "rescues".

Although individuals are primarily responsible for their own safety, the RCMP has recently undertaken a number of new prevention initiatives. These initiatives are being directed at three target groups: school children ages 5-12; special interest groups, and the general public.

School children are taught how to survive in the woods when lost. Videos are used to instill SAR awareness to special interest groups. Videos include two 1995 presentations developed by the RCMP in "K" Division (Alberta). Prevention brochures are disseminated to the general public during police week and during other special occasions. Brochures include one entitled "Prepared for the Woods", which is produced by Emergency Preparedness Canada.

Volunteers

Properly trained civilian volunteers are, at the very least, equally as effective as highly trained paid professionals, and in many instances are more readily available.

While the RCMP Search Commander maintains authority for the organization and management of the search, national RCMP policy promotes, whenever feasible, the organization and use of this valuable resource. The exact level and extent of civilian involvement in SAR generally varies by province, according to provincial guidelines, standards, Workers Compensation and local RCMP requirements.

Provincial standards and certification are invaluable in pre-determining the qualifications of volunteers. This is especially true in the case of volunteer SAR dog teams as the Search Commander has a obligation to ensure both the handler and the dog will recognize clues; will not destroy evidence; will not injure the lost person, and will not become lost or injured themselves.

To the extent possible, potential volunteer search managers will be encouraged to attend RCMP-sponsored search management courses, together with potential RCMP SAR Commanders. Furthermore, it is RCMP policy that when feasible, the RCMP will also assist in the training of volunteers.

The RCMP is committed to the principles of community based policing and SAR is an excellent example of the high level of partnership and commitment between the police and the community.

Conclusion

Recent developments have brought a new level of SAR importance and accountability in the RCMP and a greater reliance on the development and use of trained volunteers. Through improved response, prevention and inter-departmental cooperation, it is hoped that many search emergencies can be avoided and that many lives will be saved.

The RCMP has undertaken numerous efforts to enhance the general effectiveness of its national SAR program. This has involved an examination of, and in some cases, a complete overhaul of our force's responsibilities, levels of service, standards, training, allocation of resources, and types of resources.

No amount of police resources and equipment will ever replace the vital knowledge and commitment of the citizen within the community. The role of invaluable volunteers in SAR can only be expected to grow in the future.

Content created: date
Content revised: date

[Return to Top](#)

[Important Notices](#)

State of Alaska - Cold Water Near Drowning Guidelines

- [AK-HYPO.ZIP](#) *Download latest revision - 01/96 - Word 6 format (47K)*
- [Cold Injuries & Cold Water Near Drowning Guidelines](#) *Now available as a pdf file zipped to 43k - by popular demand*

Table of Contents

- [Introduction](#)
- [Hypothermia: General Points](#)
- [Hypothermia: General Public](#)
- [Hypothermia: First Responder/Emergency Medical Technician I](#)
- [Hypothermia: Emergency Medical Technician II](#)
- [Hypothermia: Emergency Medical Technician III/Paramedic](#)
- [Hypothermia: Small/Bush Clinic](#)
- [Hypothermia: Hospital](#)
- [Cold Water Near Drowning: General Points](#)
- [Cold Water Near Drowning: General Public](#)
- [Cold Water Near Drowning: First Responder/Emergency Medical Technician I](#)
- [Cold Water Near Drowning: Emergency Medical Technician II](#)
- [Cold Water Near Drowning: Emergency Medical Technician III](#)
- [Cold Water Near Drowning: Paramedic](#)
- [Cold Water Near Drowning: Small/Bush Clinic](#)
- [Cold Water Near Drowning: Hospital](#)
- [Frostbite: Introduction](#)
- [Frostbite: General Points](#)
- [Frostbite: Evaluation and Treatment](#)
- [Frostbite: References](#)
- [Alaska 24 Hour Emergency Departments](#)

- [Temperature Conversions](#)
- [Acknowledgements](#)
- [Index](#)

INTRODUCTION

These guidelines have been developed for use by prehospital , clinic and hospital personnel dealing with cold problems in Alaska. They are meant to be guidelines, not absolute rules, governing the treatment of hypothermia and cold water near drowning.

Field personnel, from first responders through paramedics, may not want to carry the full set of guidelines with them. It may be more practical simply to carry the portion pertinent to their level of training, and to be generally familiar with the content for their level.

The full set of guidelines probably would be best utilized in hospital radio rooms, where calls come in from prehospital personnel with various levels of training.

To illustrate:

If a call comes in to Dillingham hospital from Naknek about a hypothermic patient, the hospital personnel need to ask the level of training of the prehospital personnel. If the caller is an EMT-II, for example, the hospital personnel can then turn to Hypothermia-EMT-II and direct the EMT in appropriate treatment.

Readers should note that these protocols are primarily designed to be used in EMS education and as a reference for the treatment of cold injuries and for use in assisting in the development of local standing orders. In the absence of standing orders, they may be used to guide the treatment of cold injuries until communication with a physician is established.

These guidelines are **not** intended to serve as a comprehensive teaching document on cold related illnesses and injuries. Consequently, those teaching the treatment of cold injuries must be prepared to elaborate on pathophysiology and treatment.

[Back to the Table of Contents](#)

HYPOTHERMIA: GENERAL POINTS

A.

The evaluation and treatment of hypothermia whether wet or dry, on land or water, are similar. Specific differences are covered in the following pages.

B.

In the cold patient, a rectal temperature is one of the vital signs. In terms of the ABC's, think:

A - Airway B - Breathing C - Circulation D - Degrees

C.

In the cold patient, body core temperature becomes an important sign. While obtaining a body core temperature is

important and useful for assessing and treating hypothermia, there is tremendous variability in individual physiologic responses at specific temperatures and a low reading thermometer may not always be available. Therefore, these guidelines are not solely based on the patient's measured temperature.

D.

Assessment of temperature:

1. The simplest assessment of a patient's body temperature may be performed by placing an ungloved hand against the skin of the patient's back or chest. If the skin feels warm, hypothermia is unlikely. This method, however, does not provide a reliable estimate of the patient's core temperature.
2. Axillary and oral measurements are poor measures of core temperature. Rectal temperatures more closely approximate the core temperature and are a practical method for use in the field. It is acknowledged that other methods of estimating the core temperature exist. Use of techniques other than rectal measurements should be evaluated for their accuracy and practicality in the field. The decision to use a methodology other than rectal temperatures should be made in consultation with the service's physician medical director.
3. Patients with cold skin should have a rectal temperature taken with a low reading thermometer. Household thermometers are useless in this setting. Low reading rectal thermometers should be capable of measuring temperatures as low as 70°F.
4. CAUTION: Electronic thermometers may not be accurate if they are left in the cold.

E:

The hypothermic patient should be assessed carefully for coexisting injuries and illnesses. The signs and symptoms of hypothermia may be mimicked by alcohol, diabetes, altitude sickness, overdose and other conditions. As a result, a thorough assessment of the patient is imperative. Associated significant illness or injury may exacerbate hypothermia. Splinting should be performed, when indicated, with caution to prevent additional injuries to frostbitten tissues.

F.

Ensure that items, oxygen, and fluids (both oral and IV) coming into contact with the patient, are warmed.

G.

Since cold skin is easily injured, avoid direct application of hot objects or excessive pressure (e.g. uninsulated hot water bottles, tourniquets).

H.

As in any resuscitation, a positive attitude is important. The hypothermic patient may appear to be beyond help because of skin color, pupil dilation, and depressed vital signs. However, patients suffering from severe hypothermia have been resuscitated. Therefore, be cautious about assuming the patient cannot be resuscitated. It is also wise to be cautious about what you say during the resuscitation. Seemingly unconscious patients frequently remember what is said and done.

I.

Severe cold injuries are encountered relatively infrequently. Consequently, it is necessary that you preplan the management of these conditions and that you are familiar with the appropriate equipment.

J.

The inside of the ambulance and any rooms where hypothermia patients are treated should be warm enough to prevent further heat loss, ideally above 80° F (26.7° C).

K.

CPR has no significant effect on survival of the hypothermic patient in the following situations, and, in accordance with state law and local standing orders, CPR should not be initiated when:

1. Cold water submersion patients who have been under the water for more than 1 hour.
2. Hypothermia patients with a core temperature of less than 60° F (15.5° C).
3. Obvious fatal injuries, e.g. decapitation.
4. Frozen patients, e.g. ice formation in the airway.
5. The chest wall is so stiff that compression is impossible.
6. Rescuers are exhausted or at danger.

L.

Recent legislation (1994 HB 39) has empowered EMTs, paramedics and physicians-assistants to declare death in the field following 30 minutes of properly performed advanced life support, even when the patient is hypothermic. It is recommended in these cases, however, that resuscitations be continued for at least 60 minutes and be combined with the rewarming techniques found in these guidelines before being terminated. Please note that this legislation does not authorize Emergency Trauma Technicians and the general public to pronounce a patient dead.

M.

The patient with severe hypothermia must be handled very gently. The cold heart is very prone to cardiac arrest. Even cautious movement of the patient may induce cardiac arrest.

N.

The indications for the pneumatic anti-shock garments are the same as for normothermic patients. The use of the PASG is controversial and they should be used in accordance with established local protocols.

O.

The pulse should be checked for up to 45 seconds when assessing a hypothermic patient or a patient who has been removed from cold water.

[Back to the Table of Contents](#)

HYPOTHERMIA: GENERAL PUBLIC

A.

Assessment of Patient

1. **Severe Hypothermia:** If the patient is cold and has any of the following signs or symptoms, he is considered to

have severe hypothermia:

- a. Temperature of 90° F (32.2° C) or less.
- b. Depressed vital signs, such as a slow pulse and/or slow respiration.
- c. Altered level of consciousness, including slurred speech, staggering gait, decreased mental skills, or the lack of response to verbal or painful stimuli.
- d. No shivering in spite of being very cold. (Note: This sign is potentially unreliable and may be altered by alcohol intoxication.)

2. **Mild Hypothermia:** If the patient is cold and does not have any of these signs or symptoms, he is considered to have mild hypothermia.

B.

Basic Treatment for Hypothermia

1. Prevent further heat loss. Insulate from the ground, protect from the wind, eliminate evaporative heat loss by removing wet clothing or by covering the patient with a vapor barrier (such as a plastic garbage bag), cover the head and neck and move the patient to a warm environment. Consider covering patient's mouth and nose with a light fabric to reduce heat loss through respirations.
2. Activate the emergency medical services system to provide transport to a medical facility.
3. Do not give alcohol.

C.

Treatment for Mild Hypothermia

1. Treat the patient as outlined in Section B.
2. If there is no way to get to a medical facility, rewarm the patient gradually by:
 - a. Placing patient in as warm an environment as possible.
 - b. Increasing heat production through exercise and calorie/fluid replacement. This method of adding heat is particularly important when emergency care is not readily available as in remote or prolonged transport environment.
 - c. Rewarming passively through the application of insulated heat packs to high heat transfer/loss areas such as the head, neck, underarms, sides of the chest wall, and groin, and heavy insulation to prevent further heat loss.
 - d. Considering warm showers and warm bath if the patient is alert.
 - e. Placing patient in a sleeping bag and providing contact with a warm body. The patient should **not** be placed a sleeping bag with another individual who is hypothermic. This method should be considered a last resort since it may endanger the rescuer and is less efficient than other methods.
3. Encourage the patient to drink warm fluids as soon as he, or she, is capable of swallowing and protecting his or her airway.

D.

Treatment for Severe Hypothermia with Signs of Life (e.g. Pulse and Respirations Present)

1. Treat the patient as outlined in sections B and C above with the following exceptions:
 - a. Do **not** put severely hypothermic patients in a shower or bath.
 - b. Do **not** give a patient oral fluids unless he or she is capable of swallowing and protecting his or her airway.
2. Treat patients who are hypothermic very gently (do not rub or manipulate extremities).

E.

Treatment for Severe Hypothermia with No Life Signs

1. Treat as above.
2. If no pulse (after checking for up to 45 seconds) and no respirations and no contraindications as listed in section K, start CPR.
3. Use mouth-to-mask breathing.
4. Reassess the patient's physical status periodically.
5. Transfer to a medical facility as soon as possible.

[Back to the Table of Contents](#)

HYPOTHERMIA: FIRST RESPONDER/EMERGENCY MEDICAL TECHNICIAN I

A.

Assessment of Patient

1. **Severe Hypothermia:** If the patient is cold and has any of the following signs or symptoms, he is considered to have severe hypothermia:
 - a. Temperature of 90° F (32.2° C) or less.
 - b. Depressed vital signs, such as a slow pulse and/or slow respiration.
 - c. Altered level of consciousness, including slurred speech, staggering gait, decreased mental skills, or the lack of response to verbal or painful stimuli.
 - d. No shivering in spite of being very cold. (Note: This sign is potentially unreliable and may be altered by alcohol intoxication.)
2. **Mild Hypothermia:** If the patient is cold and does not have any of these signs or symptoms, he is considered to have mild hypothermia.

B.

Basic Treatment for Hypothermia

1. Prevent further heat loss. Insulate from the ground, protect from the wind, eliminate evaporative heat loss by removing wet clothing or by covering the patient with a vapor barrier (such as a plastic garbage bag), cover the head and neck and move the patient to a warm environment. Consider covering patient's mouth and nose with a light fabric to reduce heat loss through respirations.
2. Treat and transport to a medical facility.
3. Do not give alcohol.
4. When administered, oxygen should be heated to 105° - 108° F (40.5° - 42.2° C), measured at the mouth, and humidified, if possible.
5. Splinting should be performed, when indicated, with caution to prevent additional injuries to frostbitten tissues.

C.

Treatment for Mild Hypothermia

1. Treat the patient as outlined in Section B.
2. If there is no way to get to a medical facility, rewarm the patient gradually by:
 - a. Placing patient in as warm an environment as possible.
 - b. Increasing heat production through exercise and calorie/fluid replacement. This method of adding heat is particularly important when emergency care is not readily available as in remote or prolonged transport environment.
 - c. Rewarming passively through the application of insulated heat packs to high heat transfer/loss areas such as the head, neck, underarms, sides of the chest wall, and groin, and heavy insulation to prevent further heat loss.
 - d. Considering warm showers and warm bath if the patient is alert.
 - e. Placing patient in a sleeping bag and providing contact with a warm body.
The patient should **not** be placed a sleeping bag with another individual who is hypothermic. This method, however, should be considered a last resort, however, since it may endanger the rescuer and is less efficient than other methods.
3. Encourage the patient to drink warm fluids as soon as he, or she, is capable of swallowing and protecting his or her airway.

D.

Treatment for Severe Hypothermia with Signs of Life. (i.e. Pulse and Respirations Present):

1. Obtain a core temperature (rectal).
2. Treat the patient as outlined in sections B and C above with the following exceptions:
 - a. Do **not** put severely hypothermic patients in a shower or bath.
 - b. Do **not** give a patient oral fluids unless he or she is capable of swallowing and protecting his or her airway.
3. Treat patients who are hypothermic very gently (do not rub or manipulate extremities).

4. Transport patient to a medical facility as soon as possible.
5. Reassess the patient's physical status periodically.

E.

Treatment for Severe Hypothermia with No Life Signs:

1. Treat as above.
2. If no pulse (after checking for up to 45 seconds) and no respirations and no contraindications as listed in section K, start CPR.
3. Use mouth-to-mask breathing.
4. Advanced airway devices: The indications and contraindications for advanced airway devices are the same in both the hypothermic and the warm patient. However, hypothermic patients may be more difficult to intubate, precipitation of ventricular fibrillation may be a danger, and intubation should only be attempted under optimum conditions by skilled personnel only if the airway is inadequate.
5. If the rescuers are authorized to use an automated external defibrillator and the device states that shocks are indicated, one set of three stacked shocks should be delivered. If the core temperature of the patient cannot be determined or is above 86° F, treat the patient as if normothermic. If the patient's core temperature is below 86° F, discontinue use of the AED after the initial three shocks.
6. If resuscitation has been provided in conjunction with rewarming techniques for more than 60 minutes without the return of spontaneous pulse or respiration, contact the base physician for recommendations. If contact with a physician is not possible, Emergency Medical Technicians may consider terminating the resuscitation in accordance with HB 39 and local protocols.

[Back to the Table of Contents](#)

HYPOTHERMIA: EMERGENCY MEDICAL TECHNICIAN II

A.

Assessment of Patient

1. **Severe Hypothermia:** If the patient is cold and has *any* of the following signs or symptoms, he is considered to have severe hypothermia:
 - a. Temperature of 90° F (32.2° C) or less.
 - b. Depressed vital signs, such as a slow pulse and/or slow respiration.
 - b. Alternate level of consciousness, including slurred speech, staggering gait, decreased mental skills, or the lack of response to verbal or painful stimuli.
 - d. No shivering in spite of being very cold. (Note: This sign is potentially unreliable and may be altered by alcohol intoxication.)

2. **Mild Hypothermia:** If the patient is cold and does not have any of these signs or symptoms, he is considered to have mild hypothermia.

B.

Basic Treatment for Hypothermia

1. Prevent further heat loss. Insulate from the ground, protect from the wind, eliminate evaporative heat loss by removing wet clothing or by covering the patient with a vapor barrier (such as a plastic garbage bag), cover the head and neck and move the patient to a warm environment. Consider covering patient's mouth and nose with a light fabric to reduce heat loss through respirations.
2. Treat and transport to a medical facility.
3. Do not give alcohol.
4. When administered, oxygen should be heated to 105° - 108° F (40.5° - 42.2° C), measured at the mouth, and humidified, if possible.
5. Splinting should be performed, when indicated, with caution to prevent additional injuries to frostbitten tissues.
6. Do not give coffee or alcohol.
7. I.V. Therapy
 - a. Indications for I.V.'s are the same for mildly hypothermic patients as they are for normothermic patients.
 - b. Most hypothermic patients are dehydrated and may require aggressive fluid resuscitation.
 - c. Do not delay transport, communications, or other therapy by taking a long time to start an I.V. I.V.'s are difficult to start in cold patients.
 - d. The recommended fluid for rehydration is a balanced salt solution, such as normal saline or ringer's lactate.
 - e. I.V.'s should be heated to 104° - 108° F (40° - 42° C), when possible.
8. Medications:
 - a. Indications for medications are the same for mildly hypothermic patients as they are for normothermic patients.
 - b. Medications are inefficient and poorly metabolized in the hypothermic patient. In addition, due to delayed metabolism, medications given in normal therapeutic doses to severely hypothermic patients can result in toxicity when the patient is rewarmed.
 - c. As with any person with altered consciousness, Narcan and 50% dextrose should be considered when there is a reasonable suspicion that their use is warranted.
 - d. Sodium bicarbonate is not to be used unless specifically ordered by a physician.

C.

Treatment for Mild Hypothermia

1. Treat the patient as outlined in Section B.

2. If there is no way to get to a medical facility, rewarm the patient gradually by:
 - a. Placing patient in as warm an environment as possible.
 - b. Increasing heat production through exercise and calorie/fluid replacement. This method of adding heat is particularly important when emergency care is not readily available as in remote or prolonged transport environment.
 - c. Rewarming passively through the application of insulated heat packs to high heat transfer/loss areas such as the head, neck, underarms, sides of the chest wall, and groin, and heavy insulation to prevent further heat loss.
 - d. Considering warm showers and warm bath if the patient is alert.
 - e. Placing patient in a sleeping bag and providing contact with a warm body. The patient should **not** be placed a sleeping bag with another individual who is hypothermic. This method, however, should be considered a last resort, however, since it may endanger the rescuer and is less efficient than other methods.
3. Encourage the patient to drink warm fluids as soon as he, or she, is capable of swallowing and protecting his or her airway.

D.

Treatment for Severe Hypothermia with Signs of Life (e.g. Pulse and Respirations Present):

1. Obtain a core temperature (rectal).
2. Treat the patient as outlined in sections B and C above with the following exceptions:
 - a. Do **not** put severely hypothermic patients in a shower or bath.
 - b. Do **not** give a patient oral fluids unless he or she is capable of swallowing and protecting his or her airway.
3. Treat patients who are hypothermic very gently (do not rub or manipulate extremities).
4. Administer 10 cc/kilogram of a balanced salt solution as a bolus followed by 5 cc/kg/hr as a continuous infusion.
5. Transport patient to a medical facility as soon as possible.
6. Reassess the patient's physical status periodically.

E.

Treatment for Severe Hypothermia with No Life Signs:

1. Treat as above.
2. If no pulse (after checking for up to 45 seconds) and no respirations and no contraindications as listed in section K on page 2, start CPR.
3. Use mouth-to-mask breathing.
4. Advanced airway devices: The indications and contraindications for advanced airway devices are the same in both the hypothermic and the warm patient. However, hypothermic patients may be more difficult to intubate, precipitation of ventricular fibrillation may be a danger, and intubation should only be attempted under optimum conditions by skilled personnel only if the airway is inadequate.

5. If the rescuers are authorized to use an automated external defibrillator and the device states that shocks are indicated, one set of three stacked shocks should be delivered. If the core temperature of the patient cannot be determined or is above 86° F, treat the patient as if normothermic. If the patient's core temperature is below 86° F, discontinue use of the AED after the initial three shocks.
6. If resuscitation has been provided in conjunction with rewarming techniques for more than 60 minutes without the return of spontaneous pulse or respiration, contact the base physician for recommendations. If contact with a physician is not possible, Emergency Medical Technicians may consider terminating the resuscitation in accordance with HB 39 and local protocols.

[Back to the Table of Contents](#)

HYPOTHERMIA: EMERGENCY MEDICAL TECHNICIAN III/PARAMEDIC

A.

Assessment of Patient

1. **Severe Hypothermia:** If the patient is cold and has *any* of the following signs or symptoms, he is considered to have severe hypothermia:
 - Temperature of 90° F (32.2° C) or less.
 - Depressed vital signs, such as a slow pulse and/or slow respiration.
 - Altered level of consciousness, including slurred speech, staggering gait, decreased mental skills, or the lack of response to verbal or painful stimuli.
 - No shivering in spite of being very cold. (Note: This sign is potentially unreliable and may be altered by alcohol intoxication.)
2. **Mild Hypothermia:** If the patient is cold and does not have any of these signs or symptoms, he is considered to have mild hypothermia.

B.

Basic Treatment for Hypothermia

1. Prevent further heat loss. Insulate from the ground, protect from the wind, eliminate evaporative heat loss by removing wet clothing or by covering the patient with a vapor barrier (such as a plastic garbage bag), cover the head and neck and move the patient to a warm environment. Consider covering patient's mouth and nose with a light fabric to reduce heat loss through respirations.
2. Treat and transport to a medical facility.
3. Do not give alcohol.
4. When administered, oxygen should be heated to 105° - 108° F (40.5° - 42.2° C), measured at the mouth, and humidified, if possible.

5. Splinting should be performed, when indicated, with caution to prevent additional injuries to frostbitten tissues.

6. 6. I.V. Therapy

- Indications for I.V.'s are the same for mildly hypothermic patients as they are for normothermic patients.
- Most hypothermic patients are dehydrated and may require aggressive fluid resuscitation.
- Do not delay transport, communications, or other therapy by taking a long time to start an I.V. I.V.'s are difficult to start in cold patients.
- The recommended fluid for rehydration is a balanced salt solution, such as normal saline or ringer's lactate.
- I.V.'s should be heated to 104° - 108° F (40° - 42° C), when possible.

7. Medications:

- a. Indications for medications are the same for mildly hypothermic patients as they are for normothermic patients.
- b. Medications are inefficient and poorly metabolized in the hypothermic patient. In addition, due to delayed metabolism, medications given in normal therapeutic doses to severely hypothermic patients can result in toxicity when the patient is rewarmed.
- As with any person with altered consciousness, Narcan and 50% dextrose should be considered when there is a reasonable suspicion that their use is warranted.
- Sodium bicarbonate is not to be used unless specifically ordered by a physician.

C.

Treatment for Mild Hypothermia

1. Treat the patient as outlined in Section B.
2. If there is no way to get to a medical facility, rewarm the patient gradually by:
 - Placing patient in as warm an environment as possible.
 - Increasing heat production through exercise and calorie/fluid replacement. This method of adding heat is particularly important when emergency care is not readily available as in remote or prolonged transport environment.
 - Rewarming passively through the application of insulated heat packs to high heat transfer/loss areas such as the head, neck, underarms, sides of the chest wall, and groin, and heavy insulation to prevent further heat loss.
 - Considering warm showers and warm bath if the patient is alert.
 - Placing patient in a sleeping bag and providing contact with a warm body. The patient should **not** be placed a sleeping bag with another individual who is hypothermic. This method, however, should be considered a last resort, however, since it may endanger the rescuer and is less efficient than other methods.
3. Encourage the patient to drink warm fluids as soon as he, or she, is capable of swallowing and protecting his or her airway.

D.

Treatment for Severe Hypothermia with Signs of Life (i.e. Pulse and Respiration Present):

1. Obtain a core temperature (rectal).
2. Treat the patient as outlined in sections B and C above with the following exceptions:
 - Do **not** put severely hypothermic patients in a shower or bath.
 - Do **not** give a patient oral fluids unless he or she is capable of swallowing and protecting his or her airway.
3. Treat patients who are hypothermic very gently (do not rub or manipulate extremities).
4. Administer 10 cc/kilogram of a balanced salt solution as a bolus followed by 5 cc/kg/hr as a continuous infusion.
5. Transport patient to a medical facility as soon as possible.
6. Reassess the patient's physical status periodically.

E.

Treatment for Severe Hypothermia with No Life Signs (CPR Required)

1. Treat as above.
2. If no pulse (after checking for up to 45 seconds) and no respirations and no contraindications as listed in section K on page 2, start CPR.
3. Use mouth-to-mask breathing.
4. Advanced airway devices: The indications and contraindications for advanced airway devices are the same in both the hypothermic and the warm patient. However, hypothermic patients may be more difficult to intubate, precipitation of ventricular fibrillation may be a danger, and intubation should only be attempted under optimum conditions by skilled personnel only if the airway is inadequate.
5. Guidelines have not been established for the use of advanced cardiac life support procedures in the hypothermic patient. One series of defibrillation attempts if the patient is in ventricular fibrillation (200 ws, 300 ws, 360 ws, OR 200 ws, 200 ws, 360 ws) is reasonable followed by a bolus of bretylium/lidocaine. If successful the patient should be transported immediately to the nearest medical facility. If unsuccessful and the patient's core temperature is below 86° F, the patient should immediately be transported to the nearest medical facility without further attempts at defibrillation. If the temperature is above 86° F, continue with resuscitation as if the patient was normothermic. Additional treatment should be determined by the medical director.
Note: Shivering can mimic ventricular fibrillation.
6. If the cardiac rhythm is asystole, as assessed in two different leads, do not attempt defibrillation. Additional ACLS medications should be used with caution in accordance with physician signed standing orders and as stated in B--7 of this section.
7. If resuscitation has been provided in conjunction with rewarming techniques for more than 60 minutes without the return of spontaneous pulse or respiration, contact the base physician for recommendations. If contact with a physician is not possible, Emergency Medical Technicians may consider terminating the resuscitation in accordance with HB 39 and local protocols.

[Back to the Table of Contents](#)

HYPOTHERMIA: SMALL/BUSH CLINIC

A.

The extent of the evaluation and treatment in small/bush clinics is defined by the training of the personnel and the available equipment as outlined in the foregoing guidelines.

B.

For transfer to a higher medical facility, the patient must be stabilized in the clinic rather than transferred as an unstable patient. If the patient is requiring CPR or is otherwise with unstable vital signs, then the necessary equipment and trained personnel-if not already at the clinic-should be sent to the clinic in order to stabilize the patient for transfer to a higher medical facility.

C.

Once the rewarming process has started in the clinic, it should be continued until transfer is possible and appropriate or the patient recovers.

[Back to the Table of Contents](#)

HYPOTHERMIA: HOSPITAL

A.

General Points

1. Treat to the level of your ability as your hospital equipment, staff, and skills dictate.
2. All patients should be stabilized before any transport to another facility. The patient should be kept in the sending hospital until the patient is stable or accepted by the receiving hospital.

B.

Evaluation

1. Initial attention to the ABCs and CPR as needed.
2. Vital signs, including rectal temperature.
3. Brief history.
4. Brief physical exam:
 - a. Feel for skin temperature.
 - b. Level of consciousness and neurological examination.

- c. Cadiopulmonary exam.
 - d. Associated trauma.
 - e. Weight.
5. Suggested laboratory and x-ray evaluation, depending on available staffing and equipment:
- a. Chest x-ray.
 - b. 12 lead electrocardiogram.
 - c. Urine: urinalysis, sodium and osmolality.
 - d. Blood: CBC, BUN, creatinine, electrolytes, sugar, platelets, PTT, prothrombin time, liver function tests, amylase.
 - e. Arterial blood gases.

C.

Monitoring and Treatment

1. Basic treatment is the same as that indicated for prehospital personnel in these guidelines.
2. Physiologic monitoring. Pulse oximetry or transcutaneous oxygen monitoring may be unreliable due to peripheral vasoconstriction. Consider topical methyl salicylate as a skin vasodilator. All patients should be on a cardiac monitor.
3. Administer 10 cc/kilogram of a crystalloid solution (5% dextrose in normal saline) as a bolus followed by 5 cc/kg/hr as a continuous infusion. Large amounts of fluid may be necessary for complete fluid resuscitation. A CVP line may help to determine fluid status. I.V.'s should be heated to 104° - 108° F (40° - 42° C), when possible.
4. Urinary bladder catheter, preferably with a thermistor.
5. Nasogastric tube or orogastric tube, if the patient is unconscious and intubated.
6. Endotracheal/Nasotracheal tube is indicated in the unconscious patient after careful neck evaluation.
7. Ventilate with moist air or oxygen heated to 105° - 108° F (40.5° - 42.2° C), measured at the mouth, and humidified, if possible.
8. Continue monitoring until stable and warm.

D.

Adding Heat

1. The recommended possibilities include:

EXTERNAL METHODS	INTERNAL METHODS
Gradual Spontaneous Rewarming	Warm Steam Inhalation/Ventilation (105° - 108° F) = (40.5° - 42.2° C)
Warming Blankets	Peritoneal Lavage (105° - 110° F) = (40.5° - 43.3° C)

Tub Bath (Up to 100° F (37.7°C))	Extracorporeal Circulation
	Warm Gastric/Bladder Lavage (105° - 110° F) = (40.5° - 43.3° C)
	Warm IV's (104° - 108° F) = (40° - 42° C)
	Chest Lavage via Chest Tubes

2. Regardless of the method chosen for adding heat, the patient must be under total physiologic control and the temperatures of devices, fluids, and gasses used for rewarming should be monitored.
3. Tub bath is one of the most rapid rewarming methods and requires *immediate* laboratory results and extremely close physiological monitoring.
4. For Severe Hypothermia without Signs of Life: Warm the core as rapidly as possible, using one or more of the internal methods, preferably cardiopulmonary bypass, if available.
5. For Severe Hypothermia with Life Signs: Use the rewarming method available in the facility which is most familiar to you.

E.

Most Common Problems

1. Arrhythmias:
 - a. Arrhythmias other than ventricular fibrillation will usually convert spontaneously with rewarming. If treatment is not working, continue rewarming.
 - b. In ventricular fibrillation with a core temperature of less than 85° F, consider one attempt at defibrillation (200 ws, 300 ws, 360 ws OR 200 ws, 200 ws, 360 ws) and intravenous bretylium/lidocaine.
2. Dehydration: Monitor and treat accordingly.
3. Hyperkalemia: Monitor and treat accordingly. (Do not infuse potassium in I.V.'s until serum potassium is obtained.)
4. Hyperglycemia and hypoglycemia: Monitor and treat accordingly.
5. Arterial Blood Gasses: Monitor and treat accordingly.

F.

Transferring Patients to Tertiary Care Facilities

1. The general indications to transfer the patient from a smaller hospital to a tertiary care facility are:
 - a. Lack of nursing and support staff.
 - b. Lack of equipment to properly provide for a critically ill patient.

2. Specifically, the patient should be transferred if there is:
 - a. no capability for continuous arterial blood gas monitoring;
 - b. profound neurological depression;
 - c. associated significant trauma; or
 - d. associated significant frostbite.
3. The patient should not be transferred until he or she has been accepted by the receiving medical facility and has been stabilized as much as possible to ensure safe transport.

[Back to the Table of Contents](#)

COLD WATER NEAR DROWNING: GENERAL POINTS

- A.
For the purposes of this document, cold water is defined as being less than 70° F (21.1° C).
- B.
Anyone submerged long enough to be unconscious should be transported to the hospital, *even if they he or she has regained consciousness*.
- C.
If the person has been under water for **LESS** than one hour, full resuscitative efforts should employed. If the person has been under water for **MORE** than one hour, resuscitation efforts are usually unsuccessful.
- D.
Recent legislation (1994 HB 39) has empowered EMTs, paramedics and physicians-assistants to declare death in the field following 30 minutes of properly performed advanced life support, even when the patient is hypothermic. It is recommended in these cases, however, that resuscitations be continued for at least 60 minutes and be combined with the rewarming techniques found in these guidelines before being terminated. Please note that this legislation does not authorize Emergency Trauma Technicians and the general public to pronounce a patient dead.
- E.
If it is not known how long the person has been under water, you should consider him/her to have been under water less than one hour.
- F.
There is no difference between fresh and salt water near drowning regarding outcome or treatment.
- G.
If it does not delay rescue, maintain the patient's body in a horizontal position while removing him/her from the water.
- H.

These principles apply to *any* near drowning, not just those in cold water. The difference between warm and cold water is that in submersions greater than 6 minutes, the chance for survival in warm water is much less than in cold water. The colder the water, the better the chance for survival.

I.

Because hypothermia is rarely profound (below 85° F (29.4° C) in cold water near drowning, the hypothermia aspect of the problem is less critical than the pulmonary or coagulation aspects. Thus, rewarming is done very cautiously and gradually, without the need for invasive techniques such as peritoneal lavage or AV shunts.

J.

Many near drowning patients die of a particular type of disseminated intravascular coagulation, not from their pulmonary problems.

K.

Persons surviving an immersion episode should be transported to the nearest medical facility for further evaluation. Accumulation of fluid in the lungs (noncardiogenic pulmonary edema) may develop 6 - 24 hours after submersion.

[Back to the Table of Contents](#)

COLD WATER NEAR DROWNING: GENERAL PUBLIC

Evaluation and Treatment

1. The Heimlich Maneuver should be used only when a foreign body airway obstruction is suspected.
2. CPR *must* be started immediately when the patient is determined to be pulseless, pulse check of up to 45 seconds.
3. Assess carefully for associated injuries.
4. Follow the General Public section on hypothermia for additional therapy as needed.

[Back to the Table of Contents](#)

COLD WATER NEAR DROWNING: FIRST RESPONDER/EMERGENCY MEDICAL TECHNICIAN I

Evaluation and Treatment

1. The Heimlich Maneuver should be used only when a foreign body airway obstruction is suspected.
2. CPR *must* be started immediately when the patient is determined to be pulseless after a pulse check of up to 45 seconds.
3. Assess carefully for associated injuries.

4. Follow the Emergency Medical Technician I section on Hypothermia for additional therapy as needed.

[Back to the Table of Contents](#)

COLD WATER NEAR DROWNING: EMERGENCY MEDICAL TECHNICIAN II

Evaluation and Treatment

1. The Heimlich Maneuver should be used only when a foreign body airway obstruction is suspected.
2. CPR *must* be started immediately when the patient is determined to be pulseless after a pulse check of up to 45 seconds.
3. Assess carefully for associated injuries.
4. Follow the Emergency Medical Technician II section on Hypothermia for additional therapy as needed, with the following exceptions.
 - a. If the main problem is not severe hypothermia, medication should be used as in the normothermic patient.
 - b. Because hypovolemia is generally not a problem in cold water near drownings, a balanced salt solution should be infused at a 'to keep open' rate.

[Back to the Table of Contents](#)

COLD WATER NEAR DROWNING: EMERGENCY MEDICAL TECHNICIAN III

Evaluation and Treatment

1. The Heimlich Maneuver should be used only when a foreign body airway obstruction is suspected.
2. CPR *must* be started immediately when the patient is determined to be pulseless after a pulse check of up to 45 seconds.
3. Assess carefully for associated injuries.
4. Follow the Emergency Medical Technician III/Paramedic section on Hypothermia on page 19 (including the 45 second pulse check) for additional therapy as needed, with the following exceptions.
 - a. If the main problem is not severe hypothermia, medication should be used as in the normothermic patient.
 - b. Because hypovolemia is generally not a problem in cold water near drownings, a balanced salt solution should be infused at a 'to keep open' rate.

[Back to the Table of Contents](#)

COLD WATER NEAR DROWNING: PARAMEDIC

Evaluation and Treatment

1. The Heimlich Maneuver should be used only when a foreign body airway obstruction is suspected.
2. CPR *must* be started immediately when the patient is determined to be pulseless after a pulse check of up to 45 seconds.
3. Assess carefully for associated injuries.
4. Follow the Emergency Medical Technician-III/Paramedic section on Hypothermia on page 19 (including the 45 second pulse check) for additional therapy as needed, with the following exceptions.
 - a. If the main problem is not severe hypothermia, medication should be used as in the normothermic patient.
 - b. Because hypovolemia is generally not a problem in cold water near drownings, a balanced salt solution should be infused at a 'to keep open' rate.

[Back to the Table of Contents](#)

COLD WATER NEAR DROWNING: SMALL/BUSH CLINIC

Evaluation and Treatment

1. The extent of the evaluation and treatment in small/bush clinics is defined by the training of the personnel and the available equipment as outlined in the foregoing guidelines.
2. It is very important to clear the airway with any of the standard maneuvers, but no specific maneuvers are mandatory to expel water from the lungs. Do not do the Heimlich maneuver on these patients unless there is evidence of a solid foreign body airway obstruction.
3. CPR *must* be started immediately when the patient is determined to be pulseless after a pulse check of up to 45 seconds.
4. Assess carefully for associated injuries.
5. Follow the Small/Bush Clinic Section on Hypothermia for additional therapy as needed, with the following exceptions.
 - a. If the main problem is not severe hypothermia, medication should be used as in the normothermic patient.
 - b. Because hypovolemia is generally not a problem in cold water near drownings, a balanced salt solution should be infused at a 'to keep open' rate.

[Back to the Table of Contents](#)

COLD WATER NEAR DROWNING: HOSPITAL

A.

Evaluation

The evaluation of the cold water near drowning patient is generally the same as indicated in the Hospital section of the hypothermia guidelines except for the laboratory evaluation, which in near drowning should be, in order:

1. Arterial blood gases.
2. Chest x-ray.
3. 12 lead electrocardiogram.
4. Electrolytes, BUN, CBC.
5. Scan the serum for pinkness (indicating hemolysis).
6. Institute cardiorespiratory monitoring.
7. I.V. therapy D5W at keep open levels. (In children, 1/4 - 1/2 maintenance rate.)

B.

Therapy

1. Attention to the ABC's, with respiratory support, intubation, etc., as needed.
2. Rewarming. Active rewarming methods (warm air inhalation, external heat sources, etc.) should be used as indicated by rectal temperature.

Once circulation has been established, do only passive rewarming (light sheets or light blankets; room temperature). Note that these patients often become hyperthermic.

3. Aspiration pneumonitis and pulmonary edema may be treated with appropriate diuretics, and mechanical ventilation and oxygenation.
4. Profound neurological depression: Consider aggressive cerebral resuscitation, as per Conn3, with intraventricular pressure monitoring, diuretics, and barbiturates.
5. Hemolysis - Treat as with any patient with hemolysis.
6. Disseminated Intravascular Coagulation - Treat as with any patient with DIC.
7. Renal insufficiency - Treat as with any patient with renal insufficiency.
8. Cardiopulmonary bypass is an appropriate therapy when the patient has resistant hypoxemia and cannot be rewarmed.

C.

Transferring the Near Drowning Patient to a Tertiary Care Facility

1. First the patient should be stabilized at the nearest hospital with intubation as necessary, and ventilation.

2. The general indications to transfer the patient from a small hospital to a tertiary care facility are:
 - a. Lack of nursing and support staff.
 - b. Lack of equipment to properly provide ongoing care for a critically ill patient.
3. Specifically, the patient should be transferred if there is:
 - a. no capability for arterial oxygen monitoring..
 - b. deterioration of pulmonary status.
 - c. renal insufficiency.
 - d. hemolysis.
 - e. profound neurological depression.
 - f. significant associated trauma.

[Back to the Table of Contents](#)

FROSTBITE: INTRODUCTION

Frostbite is the freezing of tissue and may involve only superficial tissues or may extend to the bone. The onset and severity of frostbite may be affected by air temperature, wind speed, duration of exposure, amount of exposed area, and predisposing conditions such as:

- poor or inadequate insulation from the cold or wind;
- impaired circulation from tight clothing or shoes;
- fatigue;
- altitude;
- immersion;
- injuries;
- circulatory disease;
- poor nutrition;
- dehydration;
- hypothermia;
- alcohol or drug use; and
- tobacco products.

A discussion of the pathophysiology of frostbite is beyond the scope of this document. Simply put, damage to the frostbitten tissues is caused by crystallization of water within the tissues, typically between the cells, as well as changes in electrolyte

concentration within the cells.

Frostbite is frequently seen in Alaska, although, in most circumstances, the frostbite is superficial and treated by the patient at home. Occasionally, it is severe enough to warrant transport to a medical facility for evaluation and treatment. Seldom will it be necessary for emergency medical personnel to perform in-field rewarming for deep frostbite. It may, however, be necessary to treat patients with superficial frostbite who have sustained other injuries, (e.g. a motor vehicle crash patient who has been exposed to sub-zero temperatures while awaiting the arrival of rescue and medical personnel).

These guidelines are designed to assist prehospital emergency medical personnel in assessing and treating frostbite. In-hospital treatment is beyond the scope of this section and readers are encouraged to refer to "Cold Injury: A Collection of Papers by William J. Mills, M.D. and Colleagues," which appeared in the January/February/March 1993 issue of *Alaska Medicine*, the official journal of the Alaska State Medical Association and the American Society for Circumpolar Health.

[Back to the Table of Contents](#)

FROSTBITE: GENERAL POINTS

Hypothermia and other life threatening conditions may be present in the patient with frostbite and must be evaluated and treated immediately.

When caring for a patient in extremely cold temperatures, take great care to prevent hypothermia, tissues from becoming frostbitten, and already frostbitten tissues from becoming worse.

If transporting a patient with frostbite which will not be rewarmed in the field, the medical provider should protect the frostbitten parts from additional injury and temperature changes.

Superficial frostbite affects the dermis and shallow subcutaneous layers of the skin and is recognized by white or gray colored patches. The affected skin feels firm, but not hard. The skin initially turns red and, once frostbitten, is not painful. No tissue loss will occur when treated properly.

Deep frostbite affects the dermal and subdermal layers and may involve an entire digit or body part. The skin feels hard and cold and the affected tissue is white or gray. A pulse cannot be felt in the deeply frostbitten tissue and skin will not rebound when pressed.

Large blisters on the frostbitten area indicate that deep frostbite has partially thawed.

Treatment of deep frostbite is usually extremely painful and best accomplished in a medical facility. If you can get the patient to a medical facility within a reasonable amount of time, or do not have the capability to rewarm the tissues properly or cannot prevent refreezing, you should transport the patient rather than attempt to rewarm the tissue in the field. Advice should be sought from a physician by radio or telephone before electing to rewarm frostbitten tissue in the field, whenever possible.

In most circumstances, the risks posed by improper rewarming or refreezing outweigh the risks of delaying treatment

for deep frostbite.

Tissue which is thawed and then refrozen almost always dies. Consequently, the decision to thaw the frostbitten tissue in the field commits the provider to a course of action which may involve pain control, maintaining warm water baths at a constant temperature, and protecting the tissue from further injury during rewarming and eventual transport. If rewarmed in the field, frostbitten extremities cannot be used for ambulation.

It is reasonable to consider rewarming the frostbitten tissue in a controlled manner if uncontrolled, spontaneous, rewarming is likely to occur during prolonged evacuation or transport.

Make plans for transporting the patient as early as circumstances allow. In some circumstances, when frostbite is not severe and is not complicated by other injuries, and there are resources available to monitor the patient's progress, a physician should be consulted. He or she may decide the patient should not be transported. This should be clearly understood and carefully documented by the prehospital provider.

Do not:

- rub the frozen part;
- allow the patient to have alcohol or tobacco;
- apply ice or snow;
- attempt to thaw the frostbitten part in cold water;
- attempt to thaw the frostbitten part with high temperatures such as those generated by stoves, exhaust, etc.; and
- break blisters which may form.

Frostbitten tissues should be handled extremely gently before, during, and after rewarming.

[Back to the Table of Contents](#)

FROSTBITE: EVALUATION AND TREATMENT

Anticipate, assess and treat the patient for hypothermia, if present.

Assess the frostbitten area carefully since the loss of sensation may cause the patient to be unaware of soft tissue injuries in that area.

Obtain a complete set of vital signs and the patient's temperature.

Obtain a patient history, including the date of the patient's last tetanus immunization.

If there is frostbite distal to a fracture, attempt to splint the fracture in a manner which does not compromise distal circulation.

Determine whether rewarming the frostbitten tissue can be accomplished in a medical facility. If it can, transport the patient

while protecting the tissue from further injury from cold or impacts.

If the decision is made to rewarm frostbitten tissue in the field, you should prepare a warm water bath (approximately 100° - 106° F) in a container large enough to accommodate the frostbitten tissues without them touching the sides or bottom of the container.

Advanced life support personnel should administer morphine or other analgesics in accordance with physician signed standing orders or on-line medical control if the frostbitten area is extensive and the medical providers are authorized to do so.

A source of additional warm water must be available.

Shock due to frostbite is very uncommon. However, medical personnel should always be alert for shock and begin treatment at the earliest sign it is developing. If the frostbite patient develops shock, personnel should perform a thorough examination for additional injuries.

Remove jewelry and clothing, if present, from the affected area.

If possible, consult a physician regarding the administration of oral analgesics, such as acetaminophen, ibuprofen or aspirin.

Water should be maintained at approximately 100° - 106° F and gently circulated around the frostbitten tissue until the distal tip of the frostbitten part becomes flushed.

Pain after rewarming usually indicates that tissue has been successfully rewarmed.

After re-warming, let the frostbitten tissues dry in the warm air. Do **not** towel dry.

After thawing, tissues that were deeply frostbitten may develop blisters or appear cyanotic. Blisters should not be broken and must be protected from injury.

Pad between affected digits and bandage affected tissues loosely with a soft, sterile dressing.

Rewarmed extremities should be kept at a level above the heart, if possible.

Protect the rewarmed area from refreezing and other trauma during transport. A frame around the frostbitten area should be constructed to prevent blankets from pressing directly on the injured area.

Do not allow an individual who has frostbitten feet except when the life of the patient or rescuer is in danger. Once frostbitten feet are rewarmed, the patient becomes nonambulatory.

[Back to the Table of Contents](#)

FROSTBITE: REFERENCES

Community Health Aid Manual, Robert Burgess, M.D., U.S. Government Printing Office, SN 017-026-00106-9, pages 336-338.

Emergency Care, Seventh Edition, Harvey Grant, et al, Brady Publishing, 1995.

Paramedic Emergency Care, Second Edition, Bledsoe, Porter, and Shade, Brady Publishing, 1995, pages 876-877.

Emergency Care of the Sick and Injured, Sixth Edition, Crosby and Lewallen, American Academy of Orthopedic Surgeons, 1995, pages 410-412.

Hypothermia, Death by Exposure, Wm. W. Forgey, M.D., ICS Books, 1985, pages 105-110.

Wilderness EMT Curriculum, Goth, Peter, Wilderness Medical Associates, 1990, pages 16:1 - 16:3.

"Cold Injury: A Collection of Papers by William J. Mills, M.D. and Colleagues", Alaska Medicine, Volume 35, Number 1.

[Back to the Table of Contents](#)

24 HOUR EMERGENCY DEPARTMENTS

24 Hour Emergency Departments

(All in area code 907)

For more information, contact your nearest referring medical facility or one of the following:

INTERIOR REGION

Fairbanks Memorial Hospital, Fairbanks - 452-8181

SOUTHERN REGION

Alaska Native Medical Center, Anchorage - 279-6661

Central Peninsula General Hospital, Soldotna - 224-4404

Alaska Regional Hospital - Alaska, Anchorage, - 276-1131

Providence Hospital, Anchorage - 562-2211

Valley Hospital, Palmer - 745-4813

SOUTHEAST REGION

Bartlett Memorial Hospital, Juneau - 586-2611

[Back to the Table of Contents](#)

TEMPERATURE CONVERSIONS

Centigrade	Fahrenheit
44.0	111.2
43.0	109.4
42.0	107.6
41.0	105.8
40.0	104.0
39.0	102.2
38.0	100.4
37.0	98.6
36.0	96.8
35.0	95.0
34.0	93.2
33.0	91.4
32.0	89.6
31.0	87.8
30.0	86.0
29.0	84.2
28.0	82.4
27.0	80.6
26.0	78.8
25.0	77.0
24.0	75.2
23.0	73.4
22.0	71.6
21.0	69.8
20.0	68.0
19.0	66.2
18.0	64.4
17.0	62.6
16.0	60.8
15.0	59.0
14.0	57.2
13.0	55.4
12.0	53.6
11.0	51.8
10.0	50.0

[Back to the Table of Contents](#)

ACKNOWLEDGMENTS

Results of a Conference on Hypothermia & Cold Water Near Drowning July 11-12, 1981 Anchorage, Alaska

Participants:

William Doolittle, M.D.

John Hayward, Ph.D.

William Mills, M.D.

Martin Nemiroff, M.D.

Tim Samuelson, M.D., Moderator

Published by

Emergency Medical Services Section

Division of Public Health

Alaska Department of Health & Social Services

Juneau, Alaska

1982

1988 Revision:

Participants in the 1988 Conference on Cold Injuries and Cold Water Near Drowning:

Frank Hollingshead, M.D., Moderator

Matt Anderson, EMS Training Coordinator

Peter Hackett, M.D.

John Hall, M.D., State EMS Medical Director

Harvey Huyett, MICP

William Mills, M.D.

Capt. Martin Nemiroff, M.D.

David Sonneborn, M.D.

Michael Westley, M.D.

Casie Williams, R.N., M.Ed.

1996 Revision:

David Ingraham, M.D., Editor

Special thanks to the following individuals for their substantive reviews:

Sandy Call, EMT Instructor

Scott Call, MICP

Mike Motti, EMT Instructor

Leo Zeek, MICP, EMS Training Coordinator, IREMSC, Inc.

Reprinting

This booklet is copyrighted by the Alaska Community Health and Emergency Medical Services Section. It may be copied in its entirety, or in part, so long as proper credit is given.

[Back to the Table of Contents](#)

INDEX

ACLS	17
Advanced cardiac life support	17
Advanced life support	2, 25, 45
Airway	1, 2, 6, 8, 12, 13, 16, 17, 27, 29, 31, 33, 35, 37
Ambulance	2
Arrest	2
Assess	27, 29, 31, 33, 35, 37, 45
Assessing	1, 3, 41
Assessment	1, 2, 5, 7, 11, 15
Asystole	17
Authorized	8, 13, 45
Bicarbonate	12, 16
Brady	47
Breathing	1, 6, 8, 13, 17
Bretylium	17, 23
Certification	7
Certified	7
Chest	1, 2, 5, 8, 12, 16, 21, 22, 39
Code	49
Compression	2
CPR	2, 6, 8, 13, 17, 19, 21, 27, 29, 31, 33, 35, 37
Curriculum	47

Defibrillation	17, 23
Defibrillator	8, 13
Device	8, 13
Devices	8, 13, 17, 22
Documented	44
Education	1
Evidence	37
Examination	21, 45
Facilities	23
Fibrillation	8, 13, 17, 23
First Responder	7, 29
Fracture	45
Hospital	1, 21, 23, 25, 39-41, 49
Hypovolemia	31, 33, 35, 37
I.V.	11, 15, 21, 23, 39
Injuries	1, 2, 7, 11, 15, 27, 29, 31, 33, 35, 37, 41, 44, 45, 53
Intubation	8, 13, 17, 39, 40
Legislation	2, 25
Lidocaine	17, 23
Management	2
Mandatory	37
Manual	47
Medical Control	45
Medical Director	1, 17, 53
Medications	11, 15, 17, 22
Monitor	21, 23, 44
Monitoring	21-23, 39, 40
Nursing	23, 40
On-line medical control	45
Oxygen	2, 7, 11, 15, 21, 22, 40
Oxygenation	39
Pain	43, 45
Paramedic	15, 33, 35, 47
Paramedics	1, 2, 25
Patient	1-3, 5-8, 11-13, 15-17, 19, 21-23, 25, 27, 29, 31, 33, 35
Physician	1, 9, 12, 13, 16, 17, 43-45
Physicians	2, 25
Physiologic	1, 21, 22
Practical	1
Prehospital	1, 21, 41, 44
Procedures	17

Protocols	1, 3, 7, 9, 13, 17
Pulseless	27, 29, 31, 33, 35, 37
Radio	1, 43
Rate	31, 33, 35, 37, 39
Rescuer	6, 8, 12, 16, 46
Resuscitated	2
Resuscitation	2, 8, 9, 11, 13, 15, 17, 21, 25, 39
Resuscitations	2, 25
Rhythm	17
Rules	1
Scope	41
Shock	3, 45
Shocks	8, 13
Skills	5, 7, 11, 15, 21
Stacked	8, 13
STANDARD	37
Standing orders	1, 2, 17, 45
Surgeons	47
Survival	2, 25
Training	1, 19, 37, 53
Transcutaneous	21
Transport	5, 7, 8, 11, 12, 15, 16, 21, 23, 41, 43, 45, 46
Trauma	2, 21, 23, 25, 40, 46
Unconscious	2, 21, 25
Ventilation	22, 39, 40
Ventricular	8, 13, 17, 23

1. Community Health Aides should use the protocols for their level of EMS certification. CHAs who are not certified as EMTs should use the EMT-I protocols for cold injuries.
2. Drug therapy should be moderated because in the cold patient medications are both inefficient and poorly metabolized.
3. "Cerebral Salvage in Near Drowning following Neurological Classification by Triage," A. W. Conn, Canadian Anesthesia Society Journal, Volume 27, No. 3, May, 1980

[Back to the Table of Contents](#)

Published in HTML code for WWW browsers by Mike Doyle - Feb. 1996

Techniques of Instruction

SARBC

Search and Rescue Society of British Columbia

This Techniques of Instruction section comprises:

- ◆ [Techniques of Instruction](#) AMOL - Lesson Plan Format
- ◆ [Techniques of Instruction](#) Lesson Plan in more detail
- ◆ [Techniques of Instruction](#) Basic Example - Interviewing Tips **NEW**

[See the Links too](#)

[Home Page](#) | [Index](#)

Last Updated: Thursday, 25-Dec-2003 13:01:24 PST
by [MCDPRI](#)

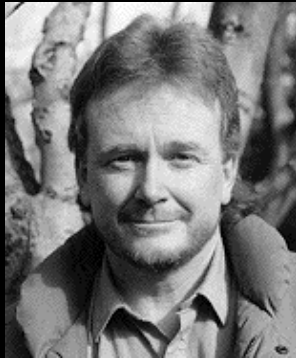

Ken Hill's Page

Ken Hill's other Home Page

Child Survival

[Children's Woodsproofing Hill](#)

Global Positioning System (GPS)

[GPS Navigation in Land Search Hill, Bower](#)

Ground Search Management (ICS)

[A Checklist for Evaluating SAR Research Hill](#)

[An Introduction to Ground Search Management for the Police Authority Hill](#)

Text version for [DOS](#) and [Macintosh](#)

[Lost Person Behavior Research - Distance Travelled by Category of Lost Person Hill](#) 

From our FTP library

 [SCENARIO.ZIP](#)

DOS program - [Scenario Analyzer](#) (36k)

 [SCHMASTR.HQX](#)

MACINTOSH program - Searchmaster - It is a general purpose search management utility, having much similarity to CASIE III (with additional features, such as graphics capabilities for estimating segment sizes, utilities for determining distance and direction between two map points, etc., etc.) (use BinHex 4.0 or Stuffit to convert - 216k)

Ken Hill may be reached at: khill@husky1.stmarys.ca

[Home Page](#) | [Index](#)

Last Updated: Thursday, 25-Dec-2003 13:01:38 PST
by [MCDPRI](#)



[Home](#) > [Herb FAQs](#) > Medicinal herb FAQ

Medicinal herb FAQ: [Intro](#) - [Single herbs](#) - [Herbs for specific things](#) - [Processing herbs](#) - [General info](#) - [Information sources](#) - [Schools](#) - [Related forums](#)

The Medicinal HerbFAQ

Contents

Last updated 25Apr04 - Have a comment? [Tell me](#).

All you ever wanted to know - and ask on a newsgroup - more often than once a month - about medicinal herbs. A FAQ for alt.folklore.herbs and the medicinal herblist. Version 1.38k.

Contents

- 1 [Introduction](#)
 - 1.1 [Contributors](#)
 - 1.2 [Wishlist](#)
- 2 [Single herbs](#)
 - 2.1 [Valeriana](#)
 - 2.1.1 [Valium is not derived from Valerian](#)
 - 2.2 [Yohimbe](#)
 - 2.2.1 [Yohimbe is a MAO inhibitor, yohimbine isn't](#)
 - 2.3 [Absinthe FAQ pointer](#)
 - 2.3.1 [More on Absinthe](#)
 - 2.4 [St. John's Wort \(Hypericum\)](#)
 - 2.4.1 [SJW and photosensitivity](#)
 - 2.4.2 [SJW and MAO inhibition](#)
 - 2.4.3 [About standardized hypericin content in SJW](#)
 - 2.5 [Ginseng](#)
 - 2.6 [Stevia Leaf - Too Good To Be Legal?](#)
 - 2.6.1 [Changed legal status of Stevia Leaf](#)
 - 2.7 [Poison Ivy / Oak / Sumac](#)

- 2.7.1 [How to recognize PI/PS/PO](#)
- 2.7.2 [How to avoid the rash](#)
- 2.7.3 [Why does it give you a rash? / Spreading the oil about](#)
- 2.7.4 [What helps](#)
- 2.7.5 [Jewelweed, *Impatiens*](#)
- 2.7.6 [How to get rid of poison ivy in your yard](#)
- 2.8 [Echinacea](#)
 - 2.8.1 [Using Echinacea](#)
 - 2.8.2 [Echinacea - poaching and extinction](#)
- 2.9 [Feverfew and migraine](#)
- 2.10 [Kava kava](#)
- 2.11 [Pau d'arco - updated 25Apr04](#)
- 2.12 [Wild yam and contraception](#)
 - 2.12.1 [Edible vs. true yam](#)
 - 2.12.2 [Wild yam cream and natural progesterone](#)
- 2.13 [Red raspberry and pregnancy](#)
- 2.14 [Green tea and caffeine](#)
- 2.15 [Comfrey hepatotoxicity](#)
 - 2.15.1 [Hepatotoxicity update](#)
- 2.16 [Pennyroyal](#)
- 2.17 [Cat's Claw](#)
- 2.18 [Golden Seal appeal - and Goldthread too](#)
- 2.19 [Ma Huang or Ephedra sinensis](#)
- 2.20 [Skullcap and Teucrium adulteration](#)
- 2.21 [Mellow mallows](#)
- 2.22 [Not an herb, but: Melatonin](#)
- 3 [Herbs for specific things](#)
 - 3.1 [Herbs for mosquitoes and other bothersome bugs](#)
 - 3.1.1 [Repelling them](#)
 - 3.1.2 [And now you're bitten...](#)
 - 3.2 [Herbs for migraines](#)
 - 3.3 [Herbs for vivid dreams](#)
 - 3.4 [Herbs and weight loss](#)

- 3.5 [Herbs to make you sleep](#)
 - 3.5.1 [Insomnia therapeutics](#)
- 3.6 [Aphrodisiacs](#)
- 3.7 [Herbal Abortives and Birth Control](#)
 - 3.7.1 [Herbal Abortives and Common Sense](#)
- 3.8 [Herbs and female infertility](#)
- 3.9 [Herbs, ADD, and replacing Ritalin](#)
- 3.10 [Herbs for Sunburn](#)
- 3.11 [The gall bladder flush](#)
- 3.12 [Herbs for cough](#)
- 3.13 [Herbs for constipation](#)
- 4 [Processing herbs](#)
 - 4.1 [Making essential oil](#)
 - 4.2 [Pointer to the How-to of Tinctures](#)
 - 4.3 [Herbal oils](#)
 - 4.4 [Balms and liniments](#)
- 5 [General Info](#)
 - 5.1 [Introduction to side effects, safety and toxicity of medicinal herbs](#)
 - 5.1.1 [Medicinal plant actions cannot be reduced to the effects of their isolated 'active constituents'](#)
 - 5.1.2 [Medicinal herbs act 'multi-systemically'](#)
 - 5.1.3 [Herbs act on the healing processes in the body](#)
 - 5.1.4 [Herbs act multi-dimensionally](#)
 - 5.1.5 [Side effects vs. contraindications](#)
 - 5.1.6 [Safety and toxicity of herbal medicines](#)
 - 5.1.7 [Pregnancy](#)
 - 5.1.8 [Understanding toxicity research - politics and ideology](#)
 - 5.1.9 [Further reading](#)
 - 5.2 [Wildcrafting Ethics and similar things](#)
 - 5.2.1 [Wildcrafting checklist](#)
 - 5.2.2 [How do I find out about endangered plants \(in the USA\)?](#)
 - 5.2.3 [What plants shouldn't I pick?](#)
 - 5.2.4 [United Plant Savers](#)

- 5.3 [Different schools of Herbal Healing](#)
 - 5.3.1 [Traditions in Western Herbal Medicine](#)
 - 5.3.2 [Ayurveda - an introduction](#)
 - 5.3.3 [Pointers to homeopathy sites etc.](#)
 - 5.3.4 [What is Traditional Chinese Medicine?](#)
 - 5.3.5 [Flower essences](#)
 - 5.3.6 [Aromatherapy intro](#)
- 5.4 [The Ames Test](#)
- 5.5 [Trying out the placebo effect](#)
- 5.6 [How to find an herbalist / ND](#)
- 5.7 [Politics and herbal medicine](#)
- 6 [Information Sources](#)
 - 6.1 [Good books on herbal medicine](#)
 - 6.1.1 [Good books to get started with](#)
 - 6.1.2 [Specialty books: women's herbals, men's herbals etc.](#)
 - 6.1.2.1 [Going for broke \(and I wish you luck\)](#)
 - 6.1.3 [In-depth books, by organ system](#)
 - 6.1.4 [Chinese herbs, or TCM \(Traditional Chinese Medicine\)](#)
 - 6.2 [Good books for further studies](#)
 - 6.3 [Good periodicals](#)
 - 6.3.1 [For enthusiasts \(emphasis on color pictures\)](#)
 - 6.3.2 [For professional herbalists \(emphasis on case studies\)](#)
 - 6.3.3 [For universities \(emphasis on scientific studies\)](#)
 - 6.4 [Online commercial databases](#)
 - 6.4.1 [Napralert](#)
 - 6.4.2 [Medline](#)
 - 6.4.3 [Ingenta](#)
 - 6.4.4 [IBIDS](#)
 - 6.5 [Herb programs](#)
 - 6.5.3 [Demo or shareware herb programs](#)
 - 6.5.4 [Commercial herb programs](#)
 - 6.6 [Other online information sources](#)
 - 6.6.1 [FTP](#)

- 6.6.2 [WWW](#)
- 6.7 [Pointers to related documents](#)
 - 6.7.1 [Plants by Mail FAQ pointer](#)
 - 6.7.2 [Carpal Tunnel Syndrome WWW page pointer](#)
 - 6.7.3 [Hint for Kombucha posters](#)
 - 6.7.4 [Hint for Essiac posters](#)
 - 6.7.5 [Thinking of growing herbs for sale?](#)
 - 6.7.6 [Saw Palmetto and Prostata problems: Newsgroup/FAQ pointer](#)
 - 6.7.7 [Natural high FAQ pointer](#)
 - 6.7.8 [Natural vision FAQ pointer](#)
 - 6.7.9 [Smoking herbs document pointer](#)
 - 6.7.10 [Pointer to herbal-medical glossary](#)
 - 6.7.11 [Menopausal discomforts](#)
- 7 [Schools etc.](#)
 - 7.1 [Some hands-on schools I know of in the US](#)
 - 7.2 [Some hands-on schools in Canada](#)
 - 7.3 [Some correspondence courses I know of in the US](#)
 - 7.4 [Some schools and correspondence courses elsewhere](#)
 - 7.5 [About correspondence schools, and licensing of herbalists](#)
 - 7.6 [Accreditation of ND schools and ND licensing in the US](#)
- 8 [Related forums](#)
 - 8.1 [Mailing lists \(= email\)](#)
 - 8.1.1 [The Medicinal Herblast](#)
 - 8.1.2 [The Aromatherapy List](#)
 - 8.1.3 [The Kombucha List](#)
 - 8.1.4 [The Paracelsus List](#)
 - 8.1.5 [The Homeopathy List](#)
 - 8.1.7 [The Culinary Herblast](#)
 - 8.1.9 [The Wellpet List](#)
 - 8.1.10 [The Holisticat List](#)
 - 8.1.12 [The Apothecary List](#)
 - 8.1.13 [The HolisticBird List](#)
 - 8.1.14 [The Toiletries List](#)

- 8.1.16 [The Aboutherbs List](#)
- 8.1.17 [The UK Herbal List](#)
- 8.1.18 [The Herbgardening List](#)
- 8.1.19 [The Forageahead List](#)
- 8.1.20 [The HolisticPet List](#)
- 8.2 [Newsgroups](#)
- 8.4 [Newsgroup \(and mailing list\) netiquette](#)
- 8.5 [Dealing with spam and trolls](#)

[Home](#) - [Herb FAQs](#) - [Articles](#) - [Classic texts](#) - [Archives](#) - [Links I like](#) - [Pictures](#) - [Plant names](#)





Henriette's Herbal Homepage

Herbal medicine and culinary herbs:
one of the oldest and largest herbal information sites on the net.

Welcome. On this site you'll find

- The [culinary herb FAQ](#) and the [medicinal herb FAQ](#)
- [Classic herbal works](#) - *added more 03May04* - including major ones like
 - [King's American Dispensatory](#)
 - [Felter's Eclectic Materia Medica](#)
 - [Ellingwood's American Materia Medica](#)as well as minor ones, and links to classic herbal works elsewhere
- 4668 [Botanical plant photos](#), and a couple hundred less botanical photos
- [Herbal forum archives](#)
- [Best of the Herbal Forums](#) - (BoHF) - *added more 04May04*
- [Links I like](#)
- [Plant names](#) - *updated 23Apr04*
- [Herbal FTP files](#) on [ibiblio.org](#), mirrored on [sunsite.sut.ac.jp](#)
- [Henriettes örtsidor](#): my Swedish pages
- [Henrietten yrttisivuja](#): my Finnish pages
- Neat stuff like [Herbal articles](#)
- [Site history, plus short author bio](#)
- [Site statistics](#): size of the site, and some usage statistics - *updated 08May04*
- [Best of RHOD](#), which is completely unrelated to herbs

Last updated 08May04 - Have a comment? [Tell me](#). Or try [YIM](#)

Please [sign my guestbook](#) - I love to see new things there.

[Home](#) - [Herb FAQs](#) - [Herbal Articles](#) - [Classic texts](#) - [Archives](#) - [Links I like](#) - [Herbal Pictures](#) - [Plant names](#)

Home



Henriette's Herbal Homepage





The HerbFAQs

Last updated 25Apr04 - Have a comment? [Tell me](#).

[The Medicinal herbFAQ](#)

"All you ever wanted to know - and ask on a newsgroup - more often than once a month - about medicinal herbs." A FAQ and resource list for alt.folklore.herbs and the medicinal herblist. First posted 24Mar95.

Version 1.38k, last updated 25Apr04.

Posted monthly on alt.folklore.herbs, alt.answers and news.answers; here's [the html version](#). You'll also find it as textfiles in seven pieces and as one big textfile, here: [textfiles/](#)

[The Culinary herbFAQ](#)

"All you ever wanted to know - and ask on a newsgroup - more often than once a month - about culinary herbs." A FAQ on growing, harvesting, using and preserving culinary herbs, for rec.gardens, alt.folklore.herbs, and the culinary herblist. First posted 28Jul95.

Version 1.17b, last updated 22Jul03.

Posted monthly on rec.gardens.edible, alt.folklore.herbs, alt.answers, rec.answers, news.answers and rec.food.preserving; here's [the html version](#). You'll also find it as textfiles in seven pieces and as one big textfile, here: [textfiles/](#)





[Home](#) > [Herb FAQs](#) > [Medicinal herb FAQ](#) >

[Medicinal herb FAQ](#): [Intro](#) - [Single herbs](#) - [Herbs for specific things](#) - [Processing herbs](#) - [General info](#) - [Information sources](#) - [Schools](#) - [Related forums](#)

The Medicinal HerbFAQ

1 Introduction

Hi all,

This is the (umpth + n) edition of the FAQ / Resource list. (I've lost track).

Feel free to send additions, corrections and comments.

[hetta . spamcop.net](mailto:hetta.spamcop.net) (no blanks)

1.1 Contributors

FAQ Keeper: Henriette Kress, [hetta . spamcop.net](mailto:hetta.spamcop.net) (no blanks)

Contributors so far (listed alphabetically): ;)

Aine Maclir, Al Czap, Alex Standefer, amethyst, Andy + Sharon, Anita Hales , August West, bahwi.technologist.com, Barbara Heller, Callie, Carolyn Mohny, Cathy Weigl, Christopher Hedley, Clarke Hoover, Colette Gardiner, Coyote Osborne, Craige Roberts, Dale Kemery, David Powner, Dennis McClain-Furmanski, Dorene Petersen, Duane Weed, Elizabeth Perdomo, Elizabeth Toews, Eric Yarnell, Eugenia Provence, George M. Carter, Gerry Creager, Gloria Mercado-Martin, Howie Brounstein, Jack Campin, James Mally, N.D., Jim Bardon, J. Mark Taylor, Jonathan Treasure, Julia Moravcsik, JunieWrite.aol.com, Kathjokl, Kay Klier, Kenneth R. Robertson, Kevin Jones, Kris Gammon, Lawrence London, Lupo LeBoucher, Marcia Elston, Mark D. Gold, Mary Jo Gilsdorf, Maven, Michael Moore, Michael M. Zaroni, Miriam Kresh, Noel Gilmore, Patricia Harper, Paul Bergner, Paul Iannone, Penny, Peggy Wilbur, Peter&Janine, Peter Gail, Peter L. Schuerman, P. Mick Richardson, Rene Burrough, Rob McCaleb, Robert Gault, Robert Hensley, Robyn Klein, Ron Rushing, Roy Collins, Roy Upton, Rusty Taylor, Samson, Sara Klein Ridgley, PhD, Satin, Shannon Brophy, Sharon Rust, skeevers.netcom.com, Stuart Cullen, Suzanne E. Sky, Thimbleberry, Thomas Mueller, Tim Birdsall, Tim Keenan, Todd Caldecott, vicki, urban shaman

1.2 Wishlist

Actually there isn't much important stuff missing anymore. The following topics are currently up for grabs:

Wanted for chapter 2 (Single herbs):

- Ginkgo

Wanted for chapter 3 (Herbs for specific things):

- Herbs for flu

Wanted in addition:

- Anything else you see posted every so often, but that I haven't included in the FAQ or on the wishlist.

If you wish to contribute send me a short note; I'll keep track of who promised to do what, and if you can't find the time to put something together in two months your topic will be up for grabs again.

Your contribution can be as long as you wish to make it; but it should be GOOD (like all the entries in this FAQ - thanks, folks).

Also, if you really know what you are talking about I'd like to hear your comments on any entry in this FAQ.

(Strange - all I ever get is 'Good Show. Keep it up.', but no-one ever tells me if they found any errors.)

[Home](#) - [Herb FAQs](#) - [Articles](#) - [Classic texts](#) - [Archives](#) - [Links I like](#) - [Pictures](#) - [Plant names](#)





[Home](#) > [Herb FAQs](#) > [Medicinal herb FAQ](#) >

[Medicinal herb FAQ: Intro](#) - [Single herbs](#) - [Herbs for specific things](#) - [Processing herbs](#) - [General info](#) - [Information sources](#) - [Schools](#) - [Related forums](#)

The Medicinal HerbFAQ

2 Single Herbs

2 Single herbs

- 2.1 [Valeriana](#)
 - 2.1.1 [Valium is not derived from Valerian](#)
- 2.2 [Yohimbe](#)
 - 2.2.1 [Yohimbe is a MAO inhibitor, yohimbine isn't](#)
- 2.3 [Absinthe FAQ pointer](#)
 - 2.3.1 [More on Absinthe](#)
- 2.4 [St. John's Wort \(Hypericum\)](#)
 - 2.4.1 [SJW and photosensitivity](#)
 - 2.4.2 [SJW and MAO inhibition](#)
 - 2.4.3 [About standardized hypericin content in SJW](#)
- 2.5 [Ginseng](#)
- 2.6 [Stevia Leaf - Too Good To Be Legal?](#)
 - 2.6.1 [Changed legal status of Stevia Leaf](#)
- 2.7 [Poison Ivy / Oak / Sumac](#)
 - 2.7.1 [How to recognize PI/PS/PO](#)
 - 2.7.2 [How to avoid the rash](#)
 - 2.7.3 [Why does it give you a rash? / Spreading the oil about](#)
 - 2.7.4 [What helps](#)
 - 2.7.5 [Jewelweed, *Impatiens*](#)
 - 2.7.6 [How to get rid of poison ivy in your yard](#)
- 2.8 [Echinacea](#)
 - 2.8.1 [Using Echinacea](#)

- [2.8.2 Echinacea - poaching and extinction](#)
- [2.9 Feverfew and migraine](#)
- [2.10 Kava kava](#)
- [2.11 Pau d'arco](#)
- [2.12 Wild yam and contraception](#)
 - [2.12.1 Edible vs. true yam](#)
 - [2.12.2 Wild yam cream and natural progesterone](#)
- [2.13 Red raspberry and pregnancy](#)
- [2.14 Green tea and caffeine](#)
- [2.15 Comfrey hepatotoxicity](#)
 - [2.15.1 Hepatotoxicity update](#)
- [2.16 Pennyroyal](#)
- [2.17 Cat's Claw](#)
- [2.18 Golden Seal appeal - and Goldthread too](#)
- [2.19 Ma Huang or Ephedra sinensis](#)
- [2.20 Skullcap and Teucrium adulteration](#)
- [2.21 Mellow mallows](#)
- [2.22 Not an herb, but: Melatonin](#)

[Home](#) - [Herb FAQs](#) - [Articles](#) - [Classic texts](#) - [Archives](#) - [Links I like](#) - [Pictures](#) - [Plant names](#)





[Home](#) > [Herb FAQs](#) > [Medicinal herb FAQ](#) >

[Medicinal herb FAQ: Intro](#) - [Single herbs](#) - [Herbs for specific things](#) - [Processing herbs](#) - [General info](#) - [Information sources](#) - [Schools](#) - [Related forums](#)

The Medicinal HerbFAQ

3 Herbs for specific things

3 Herbs for specific things

- 3.1 [Herbs for mosquitoes and other bothersome bugs](#)
 - 3.1.1 [Repelling them](#)
 - 3.1.2 [And now you're bitten...](#)
- 3.2 [Herbs for migraines](#)
- 3.3 [Herbs for vivid dreams](#)
- 3.4 [Herbs and weight loss](#)
- 3.5 [Herbs to make you sleep](#)
 - 3.5.1 [Insomnia therapeutics](#)
- 3.6 [Aphrodisiacs](#)
- 3.7 [Herbal Abortives and Birth Control](#)
 - 3.7.1 [Herbal Abortives and Common Sense](#)
- 3.8 [Herbs and female infertility](#)
- 3.9 [Herbs, ADD, and replacing Ritalin](#)
- 3.10 [Herbs for Sunburn](#)
- 3.11 [The gall bladder flush](#)
- 3.12 [Herbs for cough](#)
- 3.13 [Herbs for constipation](#)

[Home](#) - [Herb FAQs](#) - [Articles](#) - [Classic texts](#) - [Archives](#) - [Links I like](#) - [Pictures](#) - [Plant names](#)





Henriette's Herbal Homepage

[Home](#) > [Herb FAQs](#) > [Medicinal herb FAQ](#) >

[Medicinal herb FAQ: Intro](#) - [Single herbs](#) - [Herbs for specific things](#) - [Processing herbs](#) - [General info](#) - [Information sources](#) - [Schools](#) - [Related forums](#)

The Medicinal HerbFAQ

4 Processing herbs

4 Processing herbs

- 4.1 [Making essential oil](#)
- 4.2 [Pointer to the How-to of Tinctures](#)
- 4.3 [Herbal oils](#)
- 4.4 [Balms and liniments](#)

[Home](#) - [Herb FAQs](#) - [Articles](#) - [Classic texts](#) - [Archives](#) - [Links I like](#) - [Pictures](#) - [Plant names](#)



Henriette's Herbal Homepage



[Home](#) > [Herb FAQs](#) > [Medicinal herb FAQ](#) >

[Medicinal herb FAQ: Intro](#) - [Single herbs](#) - [Herbs for specific things](#) - [Processing herbs](#) - [General info](#) - [Information sources](#) - [Schools](#) - [Related forums](#)

The Medicinal HerbFAQ

5 General info

5 General info

- 5.1 [Introduction to side effects, safety and toxicity of medicinal herbs](#)
 - 5.1.1 [Medicinal plant actions cannot be reduced to the effects of their isolated 'active constituents'](#)
 - 5.1.2 [Medicinal herbs act 'multi-systemically'](#)
 - 5.1.3 [Herbs act on the healing processes in the body](#)
 - 5.1.4 [Herbs act multi-dimensionally](#)
 - 5.1.5 [Side effects vs. contraindications](#)
 - 5.1.6 [Safety and toxicity of herbal medicines](#)
 - 5.1.7 [Pregnancy](#)
 - 5.1.8 [Understanding toxicity research - politics and ideology](#)
 - 5.1.9 [Further reading](#)
- 5.2 [Wildcrafting Ethics and similar things](#)
 - 5.2.1 [Wildcrafting checklist](#)
 - 5.2.2 [How do I find out about endangered plants \(in the USA\)?](#)
 - 5.2.3 [What plants shouldn't I pick?](#)
 - 5.2.4 [United Plant Savers](#)
- 5.3 [Different schools of Herbal Healing](#)
 - 5.3.1 [Traditions in Western Herbal Medicine](#)
 - 5.3.2 [Ayurveda - an introduction](#)
 - 5.3.3 [Pointers to homeopathy sites etc.](#)
 - 5.3.4 [What is Traditional Chinese Medicine?](#)
 - 5.3.5 [Flower essences](#)

- 5.3.6 [Aromatherapy intro](#)
- 5.4 [The Ames Test](#)
- 5.5 [Trying out the placebo effect](#)
- 5.6 [How to find an herbalist / ND](#)
- 5.7 [Politics and herbal medicine](#)

[Home](#) - [Herb FAQs](#) - [Articles](#) - [Classic texts](#) - [Archives](#) - [Links I like](#) - [Pictures](#) - [Plant names](#)





[Home](#) > [Herb FAQs](#) > [Medicinal herb FAQ](#) >

[Medicinal herb FAQ: Intro](#) - [Single herbs](#) - [Herbs for specific things](#) - [Processing herbs](#) - [General info](#) -
Information sources - [Schools](#) - [Related forums](#)

The Medicinal HerbFAQ

6 Information sources

6 Information Sources

- 6.1 [Good books on herbal medicine](#)
 - 6.1.1 [Good books to get started with](#)
 - 6.1.2 [Specialty books: women's herbals, men's herbals etc.](#)
 - 6.1.2.1 [Going for broke \(and I wish you luck\)](#)
 - 6.1.3 [In-depth books, by organ system](#)
 - 6.1.4 [Chinese herbs, or TCM \(Traditional Chinese Medicine\)](#)
- 6.2 [Good books for further studies](#)
- 6.3 [Good periodicals](#)
 - 6.3.1 [For enthusiasts \(emphasis on color pictures\)](#)
 - 6.3.2 [For professional herbalists \(emphasis on case studies\)](#)
 - 6.3.3 [For universities \(emphasis on scientific studies\)](#)
- 6.4 [Online commercial databases](#)
 - 6.4.1 [Napralert](#)
 - 6.4.2 [Medline](#)
 - 6.4.3 [Ingenta](#)
 - 6.4.4 [IBIDS](#)
- 6.5 [Herb programs](#)
 - 6.5.3 [Demo or shareware herb programs](#)
 - 6.5.4 [Commercial herb programs](#)
- 6.6 [Other online information sources](#)
 - 6.6.1 [FTP](#)
 - 6.6.2 [WWW](#)

- [6.7 Pointers to related documents](#)
 - [6.7.1 Plants by Mail FAQ pointer](#)
 - [6.7.2 Carpal Tunnel Syndrome WWW page pointer](#)
 - [6.7.3 Hint for Kombucha posters](#)
 - [6.7.4 Hint for Essiac posters](#)
 - [6.7.5 Thinking of growing herbs for sale?](#)
 - [6.7.6 Saw Palmetto and Prostate problems: Newsgroup/FAQ pointer](#)
 - [6.7.7 Natural high FAQ pointer](#)
 - [6.7.8 Natural vision FAQ pointer](#)
 - [6.7.9 Smoking herbs document pointer](#)
 - [6.7.10 Pointer to herbal-medical glossary](#)
 - [6.7.11 Menopausal discomforts](#)

[Home](#) - [Herb FAQs](#) - [Articles](#) - [Classic texts](#) - [Archives](#) - [Links I like](#) - [Pictures](#) - [Plant names](#)





[Home](#) > [Herb FAQs](#) > [Medicinal herb FAQ](#) >

[Medicinal herb FAQ: Intro](#) - [Single herbs](#) - [Herbs for specific things](#) - [Processing herbs](#) - [General info](#) - [Information sources](#) - [Schools](#) - [Related forums](#)

The Medicinal HerbFAQ

7 Schools etc.

7 Schools etc.

- 7.1 [Some hands-on schools I know of in the US](#)
 - 7.2 [Some hands-on schools in Canada](#)
 - 7.3 [Some correspondence courses I know of in the US](#)
 - 7.4 [Some schools and correspondence courses elsewhere](#)
 - 7.5 [About correspondence schools, and licensing of herbalists](#)
 - 7.6 [Accreditation of ND schools and ND licensing in the US](#)
-

So you want to to to a herb school? There's lots. Which are the good ones? Which will give you value for your money and which will hand you fancy gold-plated diplomas instead of the knowledge you went there for? Which are the ones where you'll have to arrive with a chastity belt firmly locked in order to avoid the teachers' amorous advances? Where will you learn all about goats and rather less about herbs?

The best way to find out juicy bits like that is to attend a herbal conference or two, and *_gossip_*. I can recommend the Southwest conference for that myself, as I've been to that one (watch me listen to horror stories with my chin on my collarbone...), but I expect others will be equally enlightening.

Note, the herb school I attended gave excellent value for the money; the diploma is factual and not that fancy; I didn't learn squat about goats; and I didn't have to fend off any of the teachers, either. All this before I attended even one conference... lucky me, eh?

There is no really comprehensive up-to-date list of herbal schools anywhere. I've put some schools into my list; there are other lists elsewhere. Here's a few:

- The Natural Healers site lists a few (American) herb schools - sort them by specialty and/or location: <http://www.naturalhealers.com>
- The American Herbalists guild has put parts of their (US) Herbal Education Directory online: http://www.americanherbalistsguild.com/school_search.htm - the \$12 version of the

same includes descriptions etc., at least according to their site:

<http://www.americanherbalistsguild.com>

- The American Herb Association also has compiled a list of (US) schools: <http://www.ahaherb.com> - theirs costs \$3.50.
- Herbnets also lists schools: http://www.herbnets.com/university_p1.htm

Whichever school you choose, do read the accreditation notes on this page - otherwise you might end up taking a correspondence course at Clayton.

(Why do I dislike Clayton? A real ND degree means that you can get a license to legally practise as an ND a few states in the US. The real thing also took about four years of hands-on training. In comparison, Clayton's mail order ND degree isn't worth the paper it's printed on. As long as Clayton hands out ND degrees without having the real ND degree backing they're a diploma mill in my eyes - and I have a *real* dislike for diploma mills. Let them call it something else, something with no real significance (which is what correspondence school diplomas *should* be), and I'll withdraw all my objections to their operations. Until then, pffshaw.)

7.1 Some hands-on schools I know of in the US

ND degrees:

These schools give you -real- ND degrees, with the possibility to get a ND license in one of the licensing states. There are also fake ND schools - read about those here: [7.6, Accreditation](#).

- Southwest College of Naturopathic Medicine & Health Sciences. Tempe, Arizona. <http://www.scnm.edu/>
- Bastyr University. Kenmore, WA. <http://www.bastyr.edu/>
- University of Bridgeport, College of Naturopathic Medicine. Bridgeport, CT. <http://www.bridgeport.edu/naturopathy/>
- National College of Naturopathic Medicine. Portland, OR. <http://www.ncnm.edu/> (Needs flash, which I abhor.)

Other herbal hands-on schools:

Full-time:

- Southwest School of Botanical Medicine, Michael Moore. Bisbee, Arizona. <http://www.swsbm.com/>
- The Rocky Mountain Herbal Institute, Hot Springs, MT. Mainly Chinese herbology. <http://www.rmhiherbal.org>
- California School of Herbal Studies, Forestville, CA. <http://www.cshs.com/>
- The North American College of Botanical Medicine (formerly the National College of Phytotherapy), Albuquerque, NM. <http://www.swcp.com/botanicalmedicine>
- Desert Woman Botanicals, Monica Rude, Gila, NM. Several 3-month apprenticeships in

medicinal herb growing, harvesting, drying, marketing, shipping, use in products. Enthusiastic, hard working workers interested in herb growing should apply.

<http://www.desertwoman.net/>

- NorthEast School of Botanical Medicine, 7Song. Ithaca, NY. A six-month, three days a week school: <http://www.ph.utexas.edu/~wolfe/NSBM/NSBMcur.html>

Part-time:

- Howie Brounstein, Columbines and Wizardry Herbs, Inc., Eugene, Oregon. A wildcrafting class. <http://www.teleport.com/~howieb/howie.html>
- Pacific School of Herbal Medicine, Adam Seller. Oakland, California. Classes range from a couple of hours (for beginners) through 650 hours (to become a professional herbalist). Adam also has clinical case studies for the practising herbalist. <http://www.pshm.org>
- Christopher Hobbs, Williams, OR. 8 month apprenticeship program, one weekend a month. <http://www.christopherhobbs.com>
- Herbal Therapeutics, David Winston. Broadway, NJ. A two-year school with classes one evening a week. <http://www.herbaltherapeutics.net>
- Rosemary Gladstar, Vermont. 12 month apprenticeship program, one weekend a month. <http://www.sagemountain.com>
- Althea Northage-Orr, Chicago, IL. Evening classes. <http://www.chicagocollegeofhealingarts.com>

I don't know if these are full- or part time:

- Susun Weed has intensives and correspondence courses: <http://www.susunweed.com>

7.2 Some hands-on schools in Canada

ND degree:

This school gives you a -real- ND degree, with the possibility to get a ND license in one of the licensing states. There are also fake ND schools - read about those here: [7.6, Accreditation](#)

- The Canadian College of Naturopathic Medicine, Toronto, Ontario. <http://www.ccnm.edu>

Other herbal hands-on schools:

- Dominion Herbal College, Burnaby, B.C. <http://www.dominionherbal.com>
 - Mohawk College of Applied Arts & Technology, Hamilton, Ontario. This is phytotherapy, not herbalism, but then I'm a snob. <http://www.mohawkc.on.ca/dept/cehs/phytotherapy.html>
 - Wild Rose College of Natural Healing, Terry Willard. Calgary, Alberta. <http://www.wrc.net/>
-

7.3 Some correspondence courses I know of in the US

It's rather difficult to judge these from their ads. I've added "good" to those which I've only heard good things about.

- Rosemary Gladstar has a correspondence course. <http://www.sagemountain.com>
"good"
 - The Australasian College of Herbal Studies. <http://www.herbed.com>
"good"
 - David Hoffmann, Therapeutic Herbalism. If you would like more information, his address is:
2068 Ludwig Avenue, Santa Rosa, CA 95407. 707/544-7210. Stuck in the stoneage, eh, David, with no URL yet? I'll drop this one in my next update, because addresses and phone numbers change, and I can't check them from here.
 - Christopher Hobbs Home study course. <http://www.christopherhobbs.com>
 - Jeanne Rose has a correspondence course. <http://www.jeannerose.net>
 - The School of Natural Healing, founded by Dr. John R. Christopher. They have an Herbalist course and a Master Herbalist course, among others. <http://schoolofnaturalhealing.com>
 - The East-West Herb Course, Michael Tierra. This is TCM, not western herbalism. <http://www.planetherbs.com>
-

7.4 Some schools and correspondence courses elsewhere

- The School of Natural Health Sciences, London, UK. <http://www.learnbymail.com/courses/herbalism.htm>
- The Waikato Centre for Herbal Medicine is in New Zealand. Graduates are able to become full Professional Members of the NZ Association of Medical Herbalists. The course is 4 year, three years at college (one day a week) and the 4th year is working alongside a Registered Medical Herbalist in Clinical Training. There is also a correspondence programme. <http://www.herbalcentre.co.nz>
- The International College of Herbal Medicine, in New Zealand. <http://www.HerbCollege.com>

The UK Herb Society has a Herbs educational resources page with more UK schools: <http://www.herbsociety.org.uk/education.htm>

The NIMH (the National Institute of Medical Herbalists, UK) also lists some schools; unfortunately, their list is rather out of date: <http://www.nimh.org.uk>

7.5 About correspondence schools, and licensing of herbalists

From: tim.thorne.thorne.com (Tim Birdsall, ND)

I have absolutely no quarrel with distance learning. However there is a substantive difference between getting an MBA by home study and getting a health care degree! How can you learn physical diagnosis without someone standing over your shoulder saying "No, the spleen is here." or "Yes, this person's liver feels enlarged." To the best of my knowledge, no other health care profession has any legitimate degrees offered exclusively via home study.

7.6 Accreditation of ND schools and ND licensing in the US

From: Paul Bergner <bergner.concentric.net>
Subject: Clayton School

Someone recently posted that the Clayton School had obtained "accreditation". By what body, may I ask? Is it something recognized by the Department of Education, or is it some form of gratuitous self-accreditation? The test of legitimacy is whether students are eligible for government student loans.

From Henriette:

Clayton's "ND" degree won't get you a ND license in the states where ND licensing is possible. If you want a real ND degree you need to attend one of the real ND schools mentioned above.

The accrediting agency for naturopathic schools is the Council on Naturopathic Medical Education (CNME), Eugene OR. <http://www.cnme.org>

The CNME is accredited by the US Department of Education and is the only recognized licensing agency for naturopathic medical schools in the US.

States in which you can get licensed as an ND:

If you're an ND who has graduated from one of the eligible ND schools you can get licensed in these states:

Alaska, Arizona, Connecticut, Hawaii, New Hampshire, Montana, Oregon, Vermont, Washington, Utah,

after passing the Naturopathic Physicians Licensing Exam (NPLEx).

There are additional recognized ND licenses in Florida. No new licenses are being granted there, however.

British Columbia and Ontario currently license NDs who pass licensing exams and who have graduated from any of the legitimate naturopathic medical schools with an ND.

Other resources:

Federation of Naturopathic Medical Licensing Boards, Inc., 5002 W Glendale Ave, Ste 101, Glendale, AZ 85301, USA, phone 602-937-4756.

American Association of Naturopathic Physicians (AANP), Seattle, WA.

<http://www.naturopathic.org/>

[Home](#) - [Herb FAQs](#) - [Articles](#) - [Classic texts](#) - [Archives](#) - [Links I like](#) - [Pictures](#) - [Plant names](#)





Henriette's Herbal Homepage

[Home](#) > [Herb FAQs](#) > [Medicinal herb FAQ](#) >

[Medicinal herb FAQ: Intro](#) - [Single herbs](#) - [Herbs for specific things](#) - [Processing herbs](#) - [General info](#) - [Information sources](#) - [Schools](#) - Related forums

The Medicinal HerbFAQ

8 Related forums

8 Related forums

- 8.1 [Mailing lists \(= email\)](#)
 - 8.1.1 [The Medicinal Herblast](#)
 - 8.1.2 [The Aromatherapy List](#)
 - 8.1.3 [The Kombucha List](#)
 - 8.1.4 [The Paracelsus List](#)
 - 8.1.5 [The Homeopathy List](#)
 - 8.1.7 [The Culinary Herblast](#)
 - 8.1.9 [The Wellpet List](#)
 - 8.1.10 [The Holisticat List](#)
 - 8.1.12 [The Apothecary List](#)
 - 8.1.13 [The HolisticBird List](#)
 - 8.1.14 [The Toiletries List](#)
 - 8.1.16 [The Aboutherbs List](#)
 - 8.1.17 [The UK Herbal List](#)
 - 8.1.18 [The Herbgardening List](#)
 - 8.1.19 [The Forageahead List](#)
 - 8.1.20 [The HolisticPet List](#)
- 8.2 [Newsgroups](#)
- 8.4 [Newsgroup \(and mailing list\) netiquette](#)
- 8.5 [Dealing with spam and trolls](#)

[Home](#) - [Herb FAQs](#) - [Articles](#) - [Classic texts](#) - [Archives](#) - [Links I like](#) - [Pictures](#) - [Plant names](#)





Email a comment to Henriette

Use this form to send me your comments. I get *lots* of email, so I might not have time to send you a reply. But I do love to see new things in my [guestbook](#), which is a very good place for your public comments.

Your Name:

Your Email Address:

Subject:

Your Message:

I do not answer herbal or health queries over private email. For those I can recommend the [medicinal herblist](#).





[Home](#) > [Herb FAQs](#) > [Medicinal herb FAQ](#) > [Single herbs](#) >

[Medicinal herb FAQ: Intro](#) - [Single herbs](#) - [Herbs for specific things](#) - [Processing herbs](#) - [General info](#) - [Information sources](#) - [Schools](#) - [Related forums](#)

The Medicinal HerbFAQ

2.1 Valeriana

Also see [3.5, Herbs to make you sleep](#).



> [Valeriana - uses? pros? cons? safety? dosage?](#)

From Todd Caldecott (toddius.netidea.com):

Valerian is an excellent herb to use, in combination with other herbs, or used alone. The active constituents are the volatile oil (isovalerianic/enic acid) and valepotriates. Valerian depresses the central nervous system, similar to GABA (which occurs naturally in the brain and inhibits nerve impulse transmission.) There are no cons to taking valerian other than if you use it other than in a capsule it can smell up your house as a tea. Or if you have cats they may rub up and down your leg (they like it, similar to catnip) while you are drinking you tea, causing you to stumble and fall, spilling hot liquid all over yourself. For Valerian to be effective you must take it in sufficient quantities to work e.g. 1-2 tsp. of the tincture (alcohol extract) before bed, or 6-10 capsules of the dried plant. Onset is typically 1 hour. You may awaken a little muddleheaded, which is quickly relieved as soon as you move about. For a daily dose, 5 ml (1 tsp.) of the tincture 3 times a day between meals is the standard dose.

About 20% of the population respond to Valerian as a stimulant, so if you take it and have insomnia or buzzed out, try hops, chamomile, passionflower, skullcap or *Avena*, which are all excellent herbs to relieve stress, anxiety and insomnia.

2.1.1 Valium is not derived from Valerian

>Valerian is the parent of Valium isn't it?

From Michael Moore (hrbmoore.rt66.com):

There is absolutely NO connection between Valerian and Valium...believe me...just an accident of circumstance...*Valeriana* is a classic Roman Latin reference...Valium is an invented trade name...a copycat name from a pharmaceutical manufacturer to aid in making a conscious or unconscious connection with "Librium", a successful tranq whose market Valium was originally aimed at.

Valerian HAS had some anecdotal use for ADD...the only problem is that extended use of enough Valerian to have value has ALSO brought about emotional lability in some folks. Using herbs as drug substitutes has value, but with Valerian having SO many different physiologic effects (depressant for CNS, stimulant to gastric, pulmonary and cardiovascular functions) it is a botanical that is best used within a constitutional framework...i.e. evaluating the PERSON metabolically to find out if the profile of effects from Valerian is complementary or antagonistic.

From Colette Gardiner coletteg.efn.org:

Re the name Valium and its relation to the name Librium. For some weird reason I actually remember reading an article in the newspaper on the new drug Valium. There was a quote from the inventor basically saying he had been trying to invent something similar to Librium only better. He went on for a paragraph or so about comparing the various sensations and effects, and concluded that yes Valium was "nicer".

[Home](#) - [Herb FAQs](#) - [Articles](#) - [Classic texts](#) - [Archives](#) - [Links I like](#) - [Pictures](#) - [Plant names](#)





[Home](#) > [Herb FAQs](#) > [Medicinal herb FAQ](#) > [Single herbs](#) >

[Medicinal herb FAQ: Intro](#) - [Single herbs](#) - [Herbs for specific things](#) - [Processing herbs](#) - [General info](#) - [Information sources](#) - [Schools](#) - [Related forums](#)

The Medicinal HerbFAQ

2.2 Yohimbe

From [_urban shaman_](#), reached over [Carras.aol.com](#):

If people wanted to obtain a legal hyperalert sexually aroused state, they might find some yohimbe (*Corynanthe yohimbe*, *Pausinystalia yohimbe*) and brew it up by simmering a quart of water with 1 gm of ascorbic acid to 5 gm yohimbe until there's only 50% of the original water volume left. Add a lot of sugar afterward. Mixes synergistically with sassafras and Pau d'arco if you're adventurous and would like to cure your ills and get a hard-on at the same time. However, most people who have tried yohimbe have been disappointed. They didn't know you need to brew it 20 to 30 minutes at approx. 200x with an organic acid to release the alkaloid components.

The active alkaloid, yohimbine bitartrate, is the component of the only allopathic medicines known to cause erection in impotent males and approaches the concept of an aphrodisiac. Yohimbine bitartrate particularly affects nerves and changes blood flow regulators in the genital area. The medical texts never mention that it does the same thing to women, showing a typical disregard for female erection.

In the best case scenario this decoction will cause many users to get a melting spinal sensation and extreme epidermal sensitivity with high interpersonal perception and melding. It can be extremely sexually arousing...or at least all the signs and signals are there...

And the worst case scenario for yohimbe? - well, you have to remember ethnographic reports documenting cases of some African tribes drinking it in copious quantities in pre-raid rituals to suppress fear and jack up physical aggressiveness. After getting to the point where they were bouncing up and down so much they looked like a mosh pit full of spears, they'd run 10 miles over to the next village and kill off most of the neighboring tribe, stopping only to rape the dogs, cattle, women, children, surviving males, dead bodies, water jugs and tree holes before running back home. I'm not sure this is something we need downtown on Friday night.

Yohimbe Caution: it will keep both partners up all night. In the male of the species this becomes really inconvenient and irritating as after a few hours an erection becomes more of a liability than an asset - especially as this aspect continues long past the point - as long as 8 hours - where you'd like to go to sleep and there's this turgid log attached to you that won't go away and is just beginning to ache.

Note on the Caution: A warm bath can help with the log-on problem, as can gentle massage. However this should be avoided for at least four hours after ingestion because of the effect of raised body temperature on metabolism of the alkaloid - i.e., heat could intensify the stimulant effects.

Females are not exempt from this - it has the same effect on them, although it is easier to sleep on.

A possible downside of this erectile effect in high doses is the danger of blood vessel damage and gangrene in the penis resulting from the localized poor circulation condition known as penile erection.

More from _urban shaman_ on the subject:

There are a number of caveats re yohimbe - it shouldn't be taken with MAO inhibitors or by persons with high blood pressure, diabetes, glaucoma, or a history of mental disturbance, especially including bipolar disorder.

A good dose prepared using methods as I described can have profound psychological effects - enough so that 'set' and 'setting' can become issues if the concentration/quantity is sufficient. This condition can easily be entered into by simply acquiring relatively recently gathered/dried/imported specimens of the herb and using enough of it. Botanicals are very wiggly in the potency dept. - a primary breakdown in the process occurs when practitioners have never seen a 'good' specimen of the herb in question. There are no low cost analytical methods for determining the active compound density of herbal materials gathered in the wild. It totally depends on recognition by experts - and sometimes even the best of them may have to compromise, as there just may not be any high quality material to be had.

Still more from _urban shaman_ on the subject:

The "approved" alkaloid is yohimbine hydrochloride. Herbal Yohimbe extracts are sold by a number of health food companies including I believe Michaels and Herb Pharm. Yohimbe bark and powder may be available from "...of the Jungle" in Sebastopol CA. Please remember, if you're considering making extracts - Yohimbe is strongly synergized by alcohol. It is also easily extracted in alcohol/water - but the alcohol should be evaporated off after extraction unless you're looking for a real wow-wow effect. There could be high blood pressure complications from ingesting strong concentrations of Yohimbe. Dayton Laboratories sells the prescription preparation Dayto Himbin in tablet and liquid form. The tablets contain about 5.5 mg hydrochloride. The liquid contains phenylalanine as well and should be used with caution. Total daily doses run on average between 20-30 mg of the hydrochloride.

The medical action is to increase penile blood inflow and decrease penile blood outflow. The action is cited as having an erectile function without increase in libido. I have not taken the hydrochloride so don't speak from direct experience.

Although the caveats state that Yohimbine exerts no cardiac stimulation, it is later noted that Yohimbine is an unpredictable CNS stimulant and may cause elevated blood pressure and cardiac rates.

From this information I hazard we are to take it that in the same manner that yohimbine causes erections without raising libido, it also causes cardiac rate increase without stimulating the heart? (I love the guys who write this hype - they're so wise)

Buried deep in the caveats for the Dayto Himbin product is language saying you should not give this to people with a history of mental instability, and that it causes recipients to express a range of curious behaviors at doses lower than those required to cause erection - among which are tremors, irritation, dizziness, flushing (note that niacin causes a body flush at sites almost identical to those of a sexual flush).

Horse breeders administer large doses of niacin to both parties of a horse breeding "to get them in the mood". I would not suggest, however, that taking niacin along with yohimbe would have a parallel effect. If you don't know what a "sexual flush" is - take 200 mg of niacin and stand naked in front of a 3 panel mirror and watch your face, neck, "loins", and chest.

From Henriette:

If you have problems keeping it up, or are too dry, you might want to start with these:

- reduce your stress
- sleep enough and regularly
- change your contraceptive pills (if applicable)
- check your medication(s) for side effects (there's often surprises in the fine print)
- eat your vitamins
- if your partner's idea of foreplay is "Brace yerself, Sheila!" then you might benefit from some helpful books, imaginative games, or even from some softporn magazines.

If all that is OK, there are some herbs which remedy imbalances or work as aphrodisiacs, that aren't as quirky as yohimbe:

Try muira puama (*Ptychopetalum*), cotton root bark (*Gossypium*), or damiana (*Turnera*). A nice wine will relax both partners - after you've tried and had problems there's psychological barriers, too, so you do need to relax. A romantic circumstance usually helps, too.

2.2.1 Yohimbe is a MAO inhibitor, yohimbine isn't

From Michael Moore:

The alkaloid yohimbine is NOT an MAO inhibitor. The herb yohimbe IS.

The whole plant is potentially so evil and insidious BECAUSE it's complex chemistry contains both adrenergics AND cholinergics...with effects that substantially mimic both sympathetic adrenergic, sympathetic cholinergic AND parasympathetic neuroreceptors all at the same time. It contains both yohimbine alkaloid groups (stimulating and hypertensive) and several potent

reserpinoid (Rauwolfia) alkaloids (tranquilizing and hypotensive) ...a warlock's brew.

Consistent use will, because of it's wildly opposite effects, find and widen metabolic chinks in almost ANYBODY.

[Home](#) - [Herb FAQs](#) - [Articles](#) - [Classic texts](#) - [Archives](#) - [Links I like](#) - [Pictures](#) - [Plant names](#)





[Home](#) > [Herb FAQs](#) > [Medicinal herb FAQ](#) > [Single herbs](#) >

[Medicinal herb FAQ: Intro](#) - [Single herbs](#) - [Herbs for specific things](#) - [Processing herbs](#) - [General info](#) - [Information sources](#) - [Schools](#) - [Related forums](#)

The Medicinal HerbFAQ

2.3 Absinthe FAQ pointer



If you really are serious about absinthe go get the FAQ from http://www.erowid.org/chemicals/absinthe/absinthe_faq.shtml

I put this on top of the absinthe entry of this FAQ long ago: "Be warned - thujone IS dangerous, no matter what that FAQ says."

This sparked some debate, which follows.

But first, the La Fee Verte folks have made a very good absinthe FAQ: <http://www.feeverte.net/faq.html> - they also debunk the thujone danger.

2.3.1 More on Absinthe

Dale Kemery wrote

>I've been puzzled by absinthe for a long time. My recent reading has only intensified my curiosity. Is/was absinthe a true psychedelic beverage? Or what were/are its effects? For a long time I relied on the traditional reports about absinthe turning the brain to mush.

>However, considering the hysterical disinformation campaign of Howard Anslinger aimed against marijuana, I've become very suspicious of any official strictures. What *is* the story about wormwood/absinthe?

>Where can I learn more?

From christopher.gn.apc.org (Christopher Hedley):

This is from R.F.Weiss, Herbal Medicine. Weiss was an MD who taught herbal medicine in medical schools in Germany, so I suppose he counts as fairly impartial and reliable:

"The plant contains 0.25-0.5% of a volatile oil the main constituent of which is thujone as well as bitters. The bitter action predominates. Wormwood is a typical aromatic bitter. The volatile oil is remarkably effective against worms. It is however toxic, whilst the bitter principle is largely non-toxic. Absinthe is made with wormwood oil, but in Germany its manufacture has been banned since 1923. The usual wormwood preparations contain so little of the oil that there is no risk of toxic effect. In some Mediterranean countries, where absinthe is consumed in large quantities, the seriously damaging effects on the central nervous system which have given the plant its bad name may develop and even lead to seizures. This shows that wormwood also has central stimulant properties that are no doubt of benefit in the small quantities normally used.

Wormwood herb, for tea, 1 teaspoon to a glass of boiling water, leave to infuse for 10 minutes.

Wormwood tincture. 10-20-30 drops three times daily in water."

Comment; so the story is the same one as coffee, i.e. abuse/overuse of a perfectly good and useful herb.

Wormwood is *Artemisia absinthium*, it is used a lot in aperitif wines and spirits in Europe, but only in small amounts or it dominates the taste.

It is mostly used for intestinal parasites, 'weak digestion', liver and gall bladder troubles and as an emmenagogue. I always recommend it as a prophylactic for folk traveling to hot countries, 15 drops of tincture three times daily usually does the trick. The American spp of *Artemisia*, incl. sagebrush and mugwort, have pretty much the same properties.

- No *Artemisias* should be taken during pregnancy.

I trust this is useful info. Christopher Hedley

From Howie Brounstein <howieb.teleport.com>:

>>Be warned - thujone IS dangerous, no matter what that FAQ says.

The reason this line is attached to the Absinthe Pointer is because the Absinthe FAQ is slanted.

Most sources say that long term use of Absinthe is dangerous and debilitating. I was under the impression that many people became addicted to it and suffered mental and physical deterioration, thus it became outlawed. I would stress that this is long term use. Wormwood, *Artemisia absinthium* is pretty nasty stuff, you would have to drink a lot of tea to feel its narcotic like effects, but by then you'd be retching from its foul taste. Of course, you could try to hide the flavor with other stuff ... thus Absinthe.

Personally, I don't like it, don't feel its worth the havoc on your body for the effect. I like the smell of it, and would keep it around for that. The Absinthe FAQ, however, takes the point that it may be harmless, that the debility was caused by alcohol addiction, or Absinthe impurities, and a marihuana - like political scare tactics. I am not sure what to make of it, but the warning does remain that thujone is dangerous when taken in large enough quantities, and that the Absinthe of history did hurt a generation of people no matter what the specifics.

>If thujone is so dangerous, what are we to make of it as the primary constituent of *Artemisia*? Are we endangering ourselves whenever we inhale it?

Firstly, the chemistries of *Artemisia absinthium* and Mugwort, *Artemisia vulgaris* or *douglasiana* are different. Some of the contraindications are different; the uses are different; their histories are different. Also, it may be a bit premature to say that one chemical, thujone, is THE active ingredient in either. That would be a bit too reductionist for my tastes. We can't even assume that because a plant contains some small amount of a poison, that the plant is poisonous, or we'd have to give up onions, spinach, mustard. The difference between food and poison is often dosage; the difference between poison and medicine is dosage. So let's focus on thujone. A brief list of plants containing thujone includes:

Salvia officinalis L. - Sage (Leaf)
Salvia triloba L. - Greek Sage (Plant)
Artemisia dracuncululus L. - Tarragon (Shoot)
Mentha x rotundifolia (L.) HUDSON - Applemint (Leaf)
Pycnanthemum tenuifolium SCHRAD. - Slenderleaf Mountain Mint (Shoot)
Mentha pulegium L. - European Pennyroyal (Plant)
Thymus orospedanus H. del VILLAR - Orosped Thyme (Plant)
Achillea millefolium L. - Yarrow (Plant)
Capsicum frutescens L. - Cayenne (Fruit)
Carum carvi L. - Caraway (Fruit)
Glycyrrhiza glabra L. - Licorice (Root)
Juniperus sabina L. - Sabine (Plant)
Matricaria recutita L. - Annual Chamomile (Plant)
Mentha arvensis L. - Cornmint (Plant)
Sassafras albidum (NUTT.) NEES - Sassafras (Root)
Satureja hortensis L. - Summer Savory (Plant)

This list, and others like it is available free from the Phytochemical databases - <http://www.ars-grin.gov/duke/> .

So as you can see, many plants that are very safe (in normal dosages) contain this chemical. So smell your Mugwort, drink Mugwort tea, smoke it, smear the juice all over your body on a vision-dream quest, just don't extract pure thujone from it and snort it.

>Someone on another list suggested smoking *Artemisia* because there's a strong connection with marijuana --both affect the same (or similar) receptors in the brain, and are apparently similar botanically (I don't know what that means technically). Additionally, a book called *Absinthe, History in a Bottle* by Barnaby Conrad III mentions thujone-enol's structural similarity to THC.

Smoking *Artemisia*? Hmm, for me Mugwort is a flavor, used in small amounts as not to be too overwhelming. Kind of mentholly. Or perhaps for it's dreaming effects. But once again folks are implying a generalization: This one constituent (or group of constituents) is shaped like THC, and perhaps affects the same receptor sites as THC, so it must make you feel like you smoked THC. Oops, flawed logic again. Just because the shape of two molecules are similar doesn't mean that they have similar biological effects.

They might, but its not guaranteed. My take on this: Ingesting Mugwort, or any *Artemisia* I've tasted, does not make you feel like you've ingested Marihuana.

So enjoy the smells, drown your concerns, and a happy, aromatic holiday season to all you netters out there.

Howie Brounstein

From Dale Kemery, DalePK.aol.com, to above:

I thought you might be interested in more complete information about absinthe, wormwood and thujone, after our recent exchange on the subject. I've come across a comprehensive summary about it in Jonathan Ott's superb "Pharmactheon." (Although using his name with any glowing adjective is redundant because everything I've seen of his is so complete, exhaustive and thoroughly researched and studied.)

"Absinthe was prepared by distilling alcohol over mashed leaves of wormwood, and other common ingredients were *Angelica* root, *Acorus calamus* rhizome (which may contain the psychoactive asarones; ...), cinnamon, fennel seed, star anise (both of which contain anethole, another potentially psychoactive compound...) and other plants. The characteristic and much-desired green color of the liqueur, which was supposed to whiten when mixed with water, was sometimes artificially enhanced by addition of indigo and other plants, or toxic metal salts like copper sulfate and antimony chloride...

He chronicles the history of the banning of absinthe and a recent renewal of interest in absinthe, then says:

"It is commonly assumed that the thujones were the neurotoxic principles of absinthe, although alcohol also is a potent neurotoxin (absinthe contained from 68-85% alcohol) and significant quantities of copper and antimony salts used as adulterants (particularly in cheap imitation absinthe for the poorer classes) may have been present and responsible for the neurotoxicity...While large doses of injected thujones are unquestionably toxic, modern toxicological studies of thujones, in the quantities present in absinthe, without the copper and antimony adulterants, are needed before concluding that the neurotoxicity associated with absinthism was a consequence of thujone content. I suspect the copper and antimony salts, as well as the unusually high alcohol content had more to do with absinthe toxicity than the thujone content. Non-thujone essential oils commonly present in absinthe have also been shown to have convulsant properties and are probably neurotoxic."

The obvious inference is that thujone is unlikely the culprit in "absinthism." And even though he acknowledges the toxicity of "large doses of injected thujones," the operative words are "large"

and "injected." It may be assumed (without any evidence to support this statement) that swallowing thujone in some form (tea, for example) would subject it to the chemical rigors of digestion, a pathway that is much different from intravenous or even intramuscular injection. Whether the same can be said for, say, smoking a thujone-containing plant is another matter since inhalation effectuates a much more direct transfer into the blood without the intervention of hydrochloric acid, pepsin and other digestive enzymes.

From christopher.gn.apc.org (Christopher Hedley):

A note.. Sage (*Salvia officinalis*) essential oil is 30% thujone and good sage has up to 2.5% essential oil. Wormwood contains 1% essential oil, I don't have a figure on the % of thujone but if we assume it to be less than half then it is possible to consume more thujone in Sage tea than in Wormwood tea and no one has suggested that long term use of sage is toxic.

Distilling alcohol over Wormwood would extract mostly the volatile oil. Weiss says that the pure volatile oil was also used in the making of absinthe - this is still an ingrained habit in food and drink manufacture and one that should be condemned. Flavouring with volatile oils is NOT the same as flavouring with plants.

Thujone has been given bad press but I still don't think that consuming large amounts of volatile oil for long periods has anything to recommend it. Also the thujone has strong stimulating effects, noticeable when smoking wormwood - which as Howie says is nothing like smoking Mugwort. Presumably absinthe had the same degree of stimulation and thus people were encouraged to drink more and abuse it.

The comparison between thujone and THC is an interesting example of just how far theory can lead people astray. Always try for yourself I say.

From Howie Brounstein <howieb.teleport.com>:

> Also the thujone has strong stimulating effects, noticeable when smoking wormwood- which as Howie says is nothing like smoking Mugwort. Presumably absinthe had the same degree of stimulation and thus people were encouraged to drink more and abuse it.

Hmmm. Did I say that. Oh yes, so I did. It is hard to put into words. Mugwort can be used like Wormwood for worms, warming, female reproductive system effects, and it has similar contra-indications. Yet wormwood has something else, a more overtly drugged feeling it produces that I have never experienced with other *Artemisias*. I don't know what chemical is responsible for it, it may be thujone unrelated, for all I know. But I know the feeling.

From: "Rob Miedema" <8rm1.qlink.queensu.ca>

Thujone does not in fact act like THC at all. That belief was founded on the observation that they have similar chemical structures, but was proven incorrect (Hold et al., 2000). Actually, it seems that thujone exerts its effects on GABA-A receptors in the brain. This is the same receptor that alcohol acts on, but the two chemicals have opposite effects. Therefore the balance between thujone and ethanol in the absinthe is critical. Thujone, or rather it's active metabolites

(7-hydroxy-alpha-thujone, alpha-thujone), and other products in wormwood that steep into absinthe (e.g. camphor) are actually convulsants. They inhibit the brains inhibitory system causing overexcitation. Death in animals as large as cats and rabbits results from moderate doses and there are documented cases of death in humans (Burkhard et al., 1999). One person's statement that oral ingestion is not injection so it is probably fine is false, the thujone actually needs to be metabolized by the liver to break it down into its active components.

If you still want to try it here's one how-to, and a vivid description of the experience:

>Making Absinthe is extremely easy, as long as you don't require the full alcoholic content. Just take Pernod, pour off about an ounce and cram wormwood herb in the top. Let it set for a week or two. That's it. Pernod is Absinthe without the wormwood and about half the alcohol.

From ix.io.com (Lupo LeBoucher):

This is unlikely to absorb much thujone; for a really horrible and ridiculously potent absinthe, buy a fifth of 100 proof vodka, pour it over an ounce of wormwood, and a quarter ounce of anise seeds, and let it steep for a month or two. After straining the liquid, the resulting decoction will be a horrible looking liquid with approximately the color and psychoactivity of 1970s gasoline, though gasoline tastes better (long story).

To ingest (one cannot drink it), pour over a lump of sugar into a strong mixture of water & lemon juice, hold nose, and swallow before you taste the bitter horror. Be sure to do this in the vicinity of a sink with running water; one may need to wash the awful stuff down or provide your absinthe with a convenient place to rest should it decide to come up for a breather.

Effects reportedly include, audio-visual hallucinations similar to the opiates, with a bit o nitrous; numb mucus membranes; dizziness, nausea, picking up the ugliest member of the opposite sex one has ever encountered and vomiting green bile over oneself while asleep (experts disagree whether or not the latter was an effect of the previous, rather than an effect of the thujone - ask Heysoos, I didn't do it).

The above recipe was taken from a book called "The Magical and Ritual Uses of Herbs" (by Richard Allen Miller) which described Absinthe as "an excellent after-dinner liqueur" which makes one wonder what types of dinners Mr. Miller has at his place.

From ix.io.com (Lupo LeBoucher):

>Anise has no effect; the active ingredients in absinthe are just wormwood and alcohol.

The anise went in the mix in a misguided attempt to kill some of the bitter flavor (since it was what the standard recipes used). All I succeeded in doing was killing some of the wormwood "flavor" *retch* upon burping.

>The plain wormwood probably could be swallowed as a tea followed by the booze as a chaser.

The plain infusion used to be prescribed as a "tonic".

I don't know if it would have the same effect; the essential oils in the wormwood, which contain the active ingredients, are not likely to be water soluble.

From stygianv.shadow.net (Coyote Osborne):

> Anise has no effect; the active ingredients in absinthe are just wormwood and alcohol.

Ah, but anise does have an important effect here. It keeps the wormwood/absinthe from irritating your stomach so much. I would recommend fennel and perhaps peppermint or basil for this also.

> The plain wormwood probably could be swallowed as a tea followed by the booze as a chaser. The plain infusion used to be pre-scribed as a "tonic".

Actually, most of the things in wormwood are damaged or destroyed if added to hot water. Warming it gently (like brandy) works, but not making an infusion with water that is boiling. I suspect that a good rule of thumb is that if it is hot enough to destroy alcohol, it is also hot enough to make the wormwood lose it's efficacy.

>From reading that book or other, somehow I got the idea to make absinthe by mixing a whole ounce of wormwood in a half fifth of whiskey and forgetting about it for a few months. That shit is impossibly bitter. It's one of the most bitter herbal substances you know.

Yes. Not even the worms like it. :)

It does have some interesting properties, though, and prepared properly can even taste... well I won't say nice... but it will taste such a way that it is desirable.

Acquired taste perhaps? Good for the sensually indulgent? Weird?

From Stuart Cullen <stuartcullen@hotmail.com>

Just a little extra info from an experienced Absinthe drinker. I have drunk three different types of absinthe (two Portugese [50% and 58% alcohol by volume] and One Czech [55% by volume]) on innumerable occasions -- usually 4+ European shots a night.

In Portugal, to get its most extreme effect I was told to add sugar to the shot, light the absinthe, blow it out, drink it through a straw, cup my hand over the glass and inhale as much of the fumes as I could. I am sure this would be potent with any alcoholic drink. I have drunk stronger vodka [63% by volume] yet it has never had the effect of absinthe.

I have experienced one 'hallucination' -- I was once positively sure that a girl was dancing beside me for several minutes when there was no-one there. I have experienced numerous total blackouts from its usage. I am not an expert on herbs or a student of any related subject but absinth/e is a drug NOT an alcoholic drink (believe me).

An endnote from Henriette:

I'm told the "absinthe" recipes given above are completely off the wall. I'll believe that, because nobody in their right mind would ever call tincture, tea or even leaf of wormwood straight off the plant palatable.

Some say that wormwood has a nice "floral" scent. Yech, says I, because to me that "floral scent" is a thoroughly nauseating smell, which carries over into the taste if ingested. Urgh.

Wormwood is intensely bitter. Couple that bitterness with the revolting taste and you're set for something fit to give to your worst enemies, but not fit to serve at table.

On that note, I made about half a liter of wormwood tincture (1:5 45 %) years ago. Anybody over 18 (can't have kids getting drunk on this stuff) who drinks 1/2 dl (2 ounces) of that tincture in front of me (outdoors, please, with convenient bushes nearby) can have the whole bottle -- if they still want it after ingesting their half deciliter.

[Home](#) - [Herb FAQs](#) - [Articles](#) - [Classic texts](#) - [Archives](#) - [Links I like](#) - [Pictures](#) - [Plant names](#)





[Home](#) > [Herb FAQs](#) > [Medicinal herb FAQ](#) > [Single herbs](#) >

[Medicinal herb FAQ: Intro](#) - [Single herbs](#) - [Herbs for specific things](#) - [Processing herbs](#) - [General info](#) - [Information sources](#) - [Schools](#) - [Related forums](#)

The Medicinal HerbFAQ

2.4 St. John's Wort (*Hypericum*) (SJW)

[photosensitivity](#) - [maoi](#) - [standardized extracts](#)

Also see <http://www.hypericum.com>.



2.4.1 St. John's Wort (*Hypericum*) and photosensitivity

Here's the question (on the herblist (see [8.1.1](#) below) in November 1994):

>As to *Hypericum perforatum* (St. John's Wort) causing photosensitivity in humans, I have been unable to find a single study that verifies this in vivo. Lots of research on the effects of hypericin on cattle and insects, but humans? This may be an example of assumptive jumping from mammalian lab results to humans. Anyone know a study that indicates photosensitivity in humans due to *Hypericum*?

The discussion can be found here:

<http://www.ibiblio.org/herbmed/archives/Best/1994/sjw-photosens.html>

Two years after above was included in the FAQ:

In recent discussions on a high-quality herbal mailing list the conclusion was that yes, some very few people can have problems with photosensitivity and *Hypericum*; that it might manifest a tad more often with topical application of oil on skin which is exposed to sunlight; but that actually, in very sensitive people, it might be enough to just take sensible amounts of tincture internally for photosensitivity to appear (even without synergy with meds).

2.4.2 St. John's Wort (*Hypericum*) and MAO inhibition

>>St John's Wort does in fact work like an MAO inhibitor and likewise causes the same dangerous side-effects.

>That's the wrong term. They're not "side effects"; they're food or drug interactions. But if SJW is an MAO-inhibitor then they're certainly "dangerous".

From smisch.tiac.net (Samson):

Yes, they would be if SJW really were a MAOI. But it's not. That was a theory that was floating around for a while without much support, and it has since been disproven.

See eg.

- Thiede HM; Walper A: Inhibition of MAO and COMT by *Hypericum* extracts and hypericin. J Geriatr Psychiatry Neurol, 7 Suppl 1:1994 Oct, S54-6
- Bladt S; Wagner H: Inhibition of MAO by fractions and constituents of *Hypericum* extract. J Geriatr Psychiatry Neurol, 7 Suppl 1:1994 Oct, S57-9

"Using pure hypericin as well as in all ex vivo experiments, no relevant inhibiting effects could be shown. From the results it can be concluded that the clinically proven anti-depressive effect of *Hypericum* extract cannot be explained in terms of MAO inhibition."

Hypericin does show some MAO-inhibition in vitro at very high concentrations. At regular human doses, though, virtually nil.

2.4.3 About standardized hypericin content in St. John's Wort (*Hypericum*)

On alt.folklore.herbs in Oct 97:

>(somebody) wrote:

>>I gathered my own SJW when it was flowering, (snip)

(somebody else) replied:

>You don't know how strong a dose you are receiving in your homemade tincture. St. John's Wort

keeps the serotonin in your brain from breaking down so rapidly. This is called a selective serotonin re-uptake inhibitor (SSRI) and the level of serotonin in your brain goes up. This may be good for people who have low levels of serotonin such as depressives but it is not good for people with normal serotonin levels. I would stick to the companies who standardize their dose for 0.3% hypericin and only take the recommended dose.

Then jmt... (J. Mark Taylor) stepped in and replied to the recommendation to "stick to the companies who standardize their dose for 0.3% hypericin":

... I would ignore this advice. We don't buy carrots by beta-carotene content and we don't buy potatoes by carbohydrate ratings. Although nutraceutical interests may soon begin marketing things that way, they only take away from the fundamental nature of wholistic health.

Comment from Henriette:

This 'standardization' is just yet another marketing trick to me. Get suppliers you trust, know your tinctures, and don't fall for scams, not even 'scientifically proven' ones.

Pure hypericin -has- been shown to produce side effects in almost all laboratory tests, while side effects with the whole plant extract (*Hypericum* tincture, made solely with *Hypericum* flowering tops and alcohol) are exceedingly rare.

However, after the herb made it big in the US (in 1996? 1997 ?), tens of thousands of people have been taking it, daily, in larger or smaller quantities (they don't always remember or even know that more is not always better); as tinctures, "standardized extracts", capsules, and you-name-its. If -you- experience side effects, you're just one of the unhappy few "exceedingly rare" cases. If that's the case use your common sense and stop taking it.

[Home](#) - [Herb FAQs](#) - [Articles](#) - [Classic texts](#) - [Archives](#) - [Links I like](#) - [Pictures](#) - [Plant names](#)





[Home](#) > [Herb FAQs](#) > [Medicinal herb FAQ](#) > [Single herbs](#) >

[Medicinal herb FAQ: Intro](#) - [Single herbs](#) - [Herbs for specific things](#) - [Processing herbs](#) - [General info](#) - [Information sources](#) - [Schools](#) - [Related forums](#)

The Medicinal HerbFAQ

2.5 Ginseng

There are a number of plants called ginseng; a websearch (I don't recommend it, you'll get from 16000 to 90000 pages to wade through) will turn up a lot of different plants, not always correctly named:

- Ginseng, Asian (*Panax ginseng*)
 - also including Korean Red Ginseng, which is processed, making the root red and giving it a bit differing properties from the unprocessed yellowish-white ginseng root
- Ginseng, American (*Panax quinquefolius*)



- Ginseng, "Siberian" (*Eleutherococcus senticosus*) - better to call this Eleuthero, as it isn't a true ginseng.



- Ginseng, "Brazilian" (*Pfaffia paniculata*) - better to call this Suma, as it isn't a true ginseng.
- Ginseng, "Indian" (*Withania somnifera*) - better called Ashwagandha, as it isn't a true ginseng

While not all of these are ginsengs, they are all adaptogens. Adaptogens help you with your general stress response. The definition of an adaptogen is that it lets mice swim for longer in their bucket of water before they drown; it will also give you more stamina.

Further adaptogens are for example:

- Reishi mushroom (*Ganoderma lucidum*)
- Gotu kola (*Centella asiatica*)
- Rose root, gold root (*Rhodiola rosea* or *Sedum roseum*)



- Maral root (*Leuzea rhaponticum* or *L. carthamoides*, or *Rhaponticum carthamoides*), a Russian plant - you use the root and/or seeds.



This is only a partial list. In any list of adaptogens you will find at least one plant that isn't found in any other adaptogen list.

A couple of good webpages on ginsengs and adaptogens can be found here:

- <http://www.healthy.net/search/content/art/articles603.htm>
- <http://www.healthy.net/search/content/art/articles628.htm>

There are some practical considerations:

On the herblist Aug. 1994:

>Could someone be kind enough to summarize the possible adverse effects of ginseng? I've been taking a popular brand for a month now and am generally happy with the effect on a chronic sinus problem and energy levels, but beginning to feel kind of strung out ... I am drinking caffeine and wonder if this could be a problem. Also need to know about possible adverse interactions with prescription drugs such as blood pressure medications.

From Jonathan Treasure <jonno.teleport.com>:

Woah.... "Ginseng Abuse Syndrome" is even recognised by the AMA. You do not mention what kind of Ginseng or how much. I will defer to the TCM people on this list to give wither you from the Chinese view but ... surely you're not really doing coffee and ginseng? Oh dear oh dear ... tut tut.

1. It is nonsensical to take caffeine and ginseng together regularly. You will stress your adrenals (*get strung out*) and possibly raise your *stress threshold* to a danger point.

2. Ginseng should be used with extreme caution in hypertensive situations especially if under medication.
3. Sinusitis? Not the *usual* prescription. Pass.
4. Toxic signs - not uniformly predictable but can include hypertension, euphoria, nervousness, skin eruptions, morning diarrhea.
5. Contraindications - nervous anxiety, nervous tension, hypertension, disturbed menstruation, stimulant or rec. drug abuse, good vitality in younger persons.

Most recommend taking as a tonic for a period then alternating without e.g. 3 weeks on 2 weeks off.

> the Peterson guide I have on edible wild plants recommends wild American ginseng as a trail nibble...

If you did happen to find a Wild American ginseng, you should leave it right where it is! Shame on Peterson. The plant is rare, and probably endangered throughout its range.

Paul Iannone

On alt.folklore.herbs June 1995:

> I've heard the ads for ginseng pills - are they worth the money? If so, are all brands the same?

You definitely want to buy from a reputable company. According to Professor Wang at the University of Alberta, researchers found that many prepackaged ginseng products had a major shortcoming designed to fool the consumer. You guessed it ... no ginseng.

Elizabeth Toews

The UP side of poison ivy

Rarely mentioned but soon enough found out, ginseng and poison ivy are childhood sweethearts: they grow up in the same neck of the woods. If you go digging ginseng in the Cumberlands of Tennessee, you will get poison ivy -- all over your fingers. With common roots in the forest loam, the one looks out for the other.

But if that's not sufficient protection, the 'sang has yet another look-out in the plant kingdom: Virginia creeper. A master of disguise, ginseng sets up housekeeping in the thick of creeper beds. Takes a covite to tell them apart; the untutored need not apply.

Cumberland ginseng endangered? Don't think so. Most of the knowledgeable diggers have sense enough to harvest after the seeds have matured, and don't have to be told to replant from what they've dug. If there's to be "more where that came from" (talking car payments), they know they have to replant. It's city slickers, out for a test drive of their bean boots, we got to look out for. For their advancement, thank we heavens, there is poison ivy.

Alex Standefer (astandef.seraph1.sewanee.edu)

> I had read somewhere that women should not take ginseng on a regular basis (I'm cutting back from six capsules to two per day), but was told by a friend that Siberian ginseng is suitable for women to take.

Ginseng shouldn't be used as a stimulant, but where needed it can be taken for comparatively long periods by children, women, old people, anyone.

I have many female clients who take ginseng on a regular basis, in formulas appropriate to their health pattern.

As a general rule Chinese herbalists don't use ginseng by itself.

--Paul Iannone

[Home](#) - [Herb FAQs](#) - [Articles](#) - [Classic texts](#) - [Archives](#) - [Links I like](#) - [Pictures](#) - [Plant names](#)





[Home](#) > [Herb FAQs](#) > [Medicinal herb FAQ](#) > [Single herbs](#) >

[Medicinal herb FAQ: Intro](#) - [Single herbs](#) - [Herbs for specific things](#) - [Processing herbs](#) - [General info](#) - [Information sources](#) - [Schools](#) - [Related forums](#)

The Medicinal HerbFAQ

2.6 Stevia Leaf - Too Good To Be Legal?

by Rob McCaleb, Herb Research Foundation

For hundreds of years, people in Paraguay and Brazil have used a sweet leaf to sweeten bitter herbal teas including mate. For nearly 20 years, Japanese consumers by the millions have used extracts of the same plant as a safe, natural, non-caloric sweetener. The plant is stevia, formally known as *Stevia rebaudiana*, and today it is under wholesale attack by the U.S. Food and Drug Administration.

Stevia is a fairly unassuming perennial shrub of the aster family (Asteraceae), native to the northern regions of South America. It has now been grown commercially in Brazil, Paraguay, Uruguay, Central America, the United States, Israel, Thailand and China. The leaves contain several chemicals called glycosides, which taste sweet, but do not provide calories. The major glycoside is called stevioside, and is one of the major sweeteners in use in Japan and Korea. Stevia and its extracts have captured over 40% of the Japanese market. Major multinational food companies like Coca Cola and Beatrice foods, convinced of its safety, use stevia extracts to sweeten foods for sale in Japan, Brazil, and other countries where it is approved. Europeans first learned of stevia when the Spanish Conquistadors of the Sixteenth Century sent word to Spain that the natives of South America had used the plant to sweeten herbal tea since "ancient times".

The saga of American interest in stevia began around the turn of the Twentieth Century when researchers in Brazil started hearing about "a plant with leaves so sweet that a part of one would sweeten a whole gourd full of mate." The plant had been described in 1899 by Dr. M. S. Bertoni. In 1921 the American Trade Commissioner to Paraguay commented in a letter "Although known to science for thirty years and used by the Indians for a much longer period nothing has been done commercially with the plant. This has been due to a lack of interest on the part of capital and to the difficulty of cultivation."

Dr. Bertoni wrote some of the earliest articles on the plant in 1905 and 1918. In the latter article he notes:

"The principal importance of Ka he'e (stevia) is due to the possibility of substituting it for saccharine. It presents these great advantages over saccharine:

1. It is not toxic but, on the contrary, it is healthful, as shown by long experience and according

to the studies of Dr. Rebaudi.

2. It is a sweetening agent of great power.
3. It can be employed directly in its natural state, (pulverized leaves).
4. It is much cheaper than saccharine."

Unfortunately, this last point may have been the undoing of stevia. Noncaloric sweeteners are a big business in the U.S., as are caloric sweeteners like sugar and the sugar-alcohols, sorbitol, mannitol and xylitol. It is small wonder that the powerful sweetener interests here, do not want the natural, inexpensive, and non-patentable stevia approved in the U.S.

In the 1970s, the Japanese government approved the plant, and food manufacturers began using stevia extracts to sweeten everything from sweet soy sauce and pickles to diet Coke. Researchers found the extract interesting, resulting in dozens of well-designed studies of its safety, chemistry and stability for use in different food products.

Various writers have praised the taste of the extracts, which has much less of the bitter aftertaste prevalent in most noncaloric sweeteners. In addition to Japan, other governments have approved stevia and stevioside, including those of Brazil, China and South Korea, among others. Unfortunately, the US was destined to be a different story. Stevia has been safely used in this country for over ten years, but a few years ago, the trouble began.

FDA ATTACK ON STEVIA

Around 1987, FDA inspectors began visiting herb companies who were selling stevia, telling them to stop using it because it is an "unapproved food additive". By mid 1990 several companies had been visited. In one case FDA's inspector reportedly told a company president they were trying to get people to stop using stevia "because Nutra Sweet complained to FDA." The Herb Research Foundation(HRF), which has extensive scientific files on stevia, became concerned and filed a Freedom of Information Act request with FDA for information about contacts between Nutra Sweet and FDA about stevia. It took over a year to get any information from the FDA, but the identity of the company who prompted the FDA action was masked by the agency.

In May, 1991 FDA acted by imposing an import alert on stevia to prevent it from being imported into the US. They also began formally warning companies to stop using the "illegal" herb. By the beginning of 1991, the American Herbal Products Association (AHPA) was working to defend stevia. At their general meeting at Natural Products Expo West, members of the industry pledged most of the needed funds to support work to convince FDA of the safety of stevia. AHPA contracted HRF to produce a professional review of the stevia literature. The review was conducted by Doug Kinghorn, Ph.D., one of the world's leading authorities on stevia and other natural non-nutritive sweeteners. Dr. Kinghorn's report was peer-reviewed by several other plant safety experts and concluded that historical and current common use of stevia, and the scientific evidence all support the safety of this plant for use in foods. Based on this report, and other evidence, AHPA filed a petition with FDA in late October asking FDA's "acquiescence and concurrence" that stevia leaf is exempt from food additive regulations and can be used in foods.

FDA, apparently attempting to regulate this herb as they would a new food additive, contends that there is inadequate evidence to approve stevia. However, because of its use in Japan, there is much

more scientific evidence of stevia's safety than for most foods and additives. The extent of evidence FDA is demanding for the approval of stevia, far exceeds that which has been required to approve even new synthetic food chemicals like aspartame (Nutra Sweet).

AHPA's petition points out that FDA's food additive laws were meant to protect consumers from synthetic chemicals added to food. FDA is trying, in the case of stevia to claim that stevia is the same as a chemical food additive. But as the AHPA petition points out, Congress did not intend food additive legislation to regulate natural constituents of food itself. In fact, Congressman Delaney said in 1956, "There is hardly a food sold in the market today which has not had some chemicals used on or in it at some stage in its production, processing, packaging, transportation or storage." He stressed that his proposed bill was to assure the safety of "new chemicals that are being used in our daily food supply," and when asked if the regulations would apply to whole foods, he replied "No, to food chemicals only." AHPA contends that stevia is a food, which is already recognized as safe because of its long history of food use. Foods which have a long history of safe use are exempted by law from the extensive laboratory tests required of new food chemicals. The AHPA petition, however, supports the safe use of stevia with both the historical record, and references to the numerous toxicology studies conducted during the approval process in Japan, and studies by interested researchers in other countries.

To date, the FDA still refuses to allow stevia to be sold in the U.S. but the recently-enacted Dietary Supplement Health and Education Act of 1994 may prevent the FDA from treating stevia and other natural herbs as "food additives."

rmccaleb.herbs.org -- [also herbal.netcom.com]

2.6.1 Changed legal status of Stevia Leaf

> [Where do you get your stevia? No one here in RI will sell it.](#)

From: Mark D. Gold (mgold.holisticmed.com):

You should suggest to your local natural food stores and herb stores in RI that the legal status of stevia has changed recently. While importation of stevia was banned to protect Monsanto's NutraSweet sales and the future sales of other artificial sweeteners a few years ago, stevia can now be sold as a "dietary supplement." I have a copy of the FDA's new "Import Alert" on my Web page (or I can email it to you). Stevia products can and have been sold over the last few years as skin treatment products. Therefore, your local natural foods store should be able to get stevia skin treatment products and supplements from their distributor (or they should find a distributor who does sell it).

Stevia still cannot be legally sold as a "sweetener" by itself or in another product. This will help protect companies such as Monsanto (selling a dangerous artificial sweetener - aspartame) from having to compete against a safe, natural sweetener on a large-scale basis. But at least individuals can now use stevia as a supplement.

I have a list of stevia resources on my web page which you can use and give to your local natural

foods store. Hope this helps.

<http://www.holisticmed.com/sweet/>

[Home](#) - [Herb FAQs](#) - [Articles](#) - [Classic texts](#) - [Archives](#) - [Links I like](#) - [Pictures](#) - [Plant names](#)





[Home](#) > [Herb FAQs](#) > [Medicinal herb FAQ](#) > [Single herbs](#) >

[Medicinal herb FAQ: Intro](#) - [Single herbs](#) - [Herbs for specific things](#) - [Processing herbs](#) - [General info](#) - [Information sources](#) - [Schools](#) - [Related forums](#)

The Medicinal HerbFAQ

2.7 Poison Ivy / Oak / Sumac

[recognize it](#) - [avoid the rash](#) - [why the rash?](#) - [what helps](#) - [Jewelweed, *Impatiens*](#) - [get rid of poison ivy](#)

We're lucky in Finland in that we don't have any of these problem plants. But since it's asked every week in season it has to be in the FAQ, so what's in here is mostly pulled from rec.gardens archives 1992 - 1994, or from alt.folklore.herbs archives 1993 -, or taken off bionet.plants June 1995. If you wrote some text I've included here but you aren't mentioned please email - I'll be happy to mention you in the next posting.

2.7.1 How to recognize PI/PS/PO

From Kay Klier (klier.fern.com):

POISON IVY (*Toxicodendron radicans* = *Rhus radicans* = *Rhus toxicodendron*)

Found in a wide range of habitats, but in the midwest often seen in disturbed woods, roadsides, and flood plains. Most widespread of PI, PS, and PO.

Small, slightly woody plant, or shrubby, or vining. LEAVES ALTERNATE (= 1 leaf per node), TRIFOLIATE (= 3 leaflets), with pedicel (leafstalk) and the CENTRAL LEAFLET WITH PETIOLULE (= leaflet stalk). The lateral two leaflets are not distinctly stalked. Leaflets are a variety of shapes, but generally ovate or obovate (roughly apple-leaf shaped). Leaflets may be smooth-edged (entire), irregularly toothed, or shallowly lobed. Leaves of one variant look like small oak-leaves (but look again!).

Leaves apple-green and shiny in the spring, deep green and often dusty in the summer, turning a glorious reddish orange in the fall. Flowers tiny, whitish, in clusters; fruits white berries in late summer or fall.

Closest look-alike: Box-elder seedlings (*Acer negundo*), which has OPPOSITE, trifoliolate leaves; the lateral two leaflets are often slightly stalked. Older box-elders generally have 5 leaflets per leaf.

POISON SUMAC (*Toxicodendron vernix* = *Rhus vernix*)

Shrub, to perhaps 15-20 ft tall, often branched from the base. LEAVES ALTERNATE WITH 7-13 LEAFLETS, lateral leaflets without a petiolule (leaflet stalk), TERMINAL LEAFLET WITH A STALK. MIDRIB OF THE LEAF WITHOUT A PAIR OF WINGS OF TISSUE THAT RUN BETWEEN LEAFLET PAIRS. More small, whitish berries in a long cluster. Usually in wetlands, Maine to Minnesota, south to Texas and Florida.

Closest look-alikes: Staghorn sumac, *Rhus typhina*, which has clusters of fuzzy, red fruits and toothed leaflets, and likes dry soils; Smooth sumac, *Rhus glabra*, with bright red fruits and slightly toothed leaves; much drier soil than PS.

POISON OAK (*Toxicodendron diversiloba* = *Rhus diversiloba*).



Reputedly the worst of the bunch. Erect shrub, usually about 3-6 ft tall (to 12 ft!), bushy, with ALTERNATE LEAVES OF THREE LEAFLETS, the LEAFLETS generally lobed slightly or as much as an oak leaf; CENTRAL LEAFLET STALKED. Leaves generally bright, shiny green above, paler below. Fruits are small whitish berries. Common on the west coast, esp. low places, thickets and wooded slopes. Occasionally a 5-leafleted form is found.

Steve Hix (fiddler.concertina.Eng.Sun.COM), in response to above:

>POISON OAK description...

If it were only that simple! In addition to that form, you can find poison oak growing as a vine (very like wild grape, but with smooth bark) up to six inches in diameter disappearing up into the tree tops near streams, or in thickets that look a *lot* like blackberry without spines, or sometimes as collections of leafless single branches (later the leaves appear, shiny and red, changing to oily green, and so on).

Fortunately, it doesn't seem to grow much above 5000' elevation.

2.7.2 How to avoid the rash

Difficult if you live near PO/PI/PS...

... the best way not to get the rash is to learn to recognize the plant(s) and avoid it (them) after that.

But:

- You can even get a dose if a bunch of the leaves get dumped into a stream or pond ... the oil ends up floating on the surface of the water.
- Dogs / cats / horses can get it on their coats and you'll get it from them when you pet them

barehanded.

- If you burn these plants and inhale the smoke you'll get a bad case of internal PI.

2.7.3 Why does it give you a rash? / Spreading the oil about

From Ron Rushing (f_rushingrg.ccsvox.sfasu.edu):

The irritant in poison ivy, poison sumac, and poison oak is urushiol. The rash you get is an allergic reaction. Everything I say below about poison ivy should also apply to poison oak and sumac. If you brush up against a healthy undamaged plant, you won't usually get urushiol on you. You usually have to come in contact with a damaged leaf. Almost all plants have damaged leaves - either from insects, weather, or from your stepping on them.

The oil is easily transferred from one place to another. For example, I got some on my shoelaces once, and I kept getting poison ivy on my hands for a couple of months. Once it is on your hands, it can, and will, end up anywhere on your body.

The rash from poison ivy can take up to 72 hours to appear after exposure, and is often spread on the body by taking showers while the oils are still on the skin.

Once you get the oil on clothing, it can sit for months and still cause a rash upon contact with your skin. For example, lets say you get some poison ivy oil on your boots, then put the boots away for the winter. Next spring you get out the boots and go for a walk - but not in the woods. A few days later, voila - your hands are breaking out from putting on your boots and tying the laces. As long as you've washed the original oil off your skin, the exudate from the blisters should not re-infect your skin. It's just exudate, and does not contain urushiol.

From krrbert.uiuc.edu (K. R. Robertson):

Washing with strong soap merely removes excess poison from the skin, but will not remove any which has already reacted, because the poison is believed to form a complex with skin proteins and therefore is not removable short of removing the skin! Even so, it is difficult to wash off this insoluble poison completely.

Eating a leaf of poison-ivy may have disastrous results. One may surpass the normal level of immunity by the first bite; in this case one is in for an internal case of poison-ivy, occasionally known to be fatal.

The mechanism of sensitivity is not thoroughly understood. It does not behave like protein sensitivities such as hay fever. It is a hypersensitivity of the delayed type, whose mechanism is related to that of organ transplant rejection.

(Originally prepared by William T. Gillis, 1973, Revised by Kenneth R. Robertson, 1993, Illinois Natural History)

Poison Ivy, oak, sumac: Clothes contamination

From: Gerry Creager <n5jxs.tamu.edu>

One thing a lot of folks don't seem to understand, especially now that a lot of laundry detergents are available for cold water use, is that HOT water is a good element for elimination of the oily residue that causes the allergic reaction. I noted several anecdotal comments about reinnoculation that could have been prevented if the contaminated clothes were washed in hot water (not warm, not warm/cold, HOT!) and alone so as to avoid cross contamination to other clothing. I've had good result with this in our family as well as in the folks I have advised with the problem. Me? I'm one of those who so far has not manifested an allergy despite a lot fo time in the woods!

From ab282.detroit.freenet.org (Robert Gault):

The active ingredient in poison ivy and other plants in the same family is 3-n-Pentadecylcatechol, common name urushiol, which is a chemical in the phenol family.

Dermatitis (skin inflammation and blistering) is spread by the act of scratching which redistributes the urushiol over the body. While the normal treatment for poison ivy does not include the suggestion below, a reasonable approach would be to convert the urushiol into a water soluble material. Phenols are acids so washing with a weak base like diluted house hold ammonia or a paste of baking soda should do the trick.

From Kay Klier (klier.fern.com):

People who react to any of the species of PI/PO/PS will undoubtedly react to the others; further, they may cross-react with mango (*Mangifera indica*), cashew (*Anacardium occidentale*), and Chinese or Japanese Lacquer (*Rhus verniciflua*). (the cellulose-based spray paint that is called lacquer is not involved in this... just "real" lacquer, like carved lacquer boxes, etc.). Generally speaking, it's not a good idea to sit under any member of the Anacardiaceae in the rain... they all tend to have a leaf toxin that falls on innocent bystanders below.



Most people are NOT sensitive to PI/PO/PS at birth, but become sensitized through repeated exposures. Some people are apparently immune throughout their lives, but I really don't know how to test that claim... ;-)

There is a barrier cream and a cleanup wash called Technu commonly used by those who are sensitized to PI/PO/PS. Works quite well.

2.7.4 What helps

First a word of caution:

The recommendations listed here are without medical foundation and, if actually used, are at the sole risk of the reader.

- **Jewelweed**, *Impatiens pallida*, *I. capensis*, *I. biflora*, or similar species. AKA Touch-me-not, silverweed.

The plant produces both cleitogamous (self-fertilized), and chasmogamous (cross-fertilized) flowers. Mature seed pods will build tension as they dry, and can "shoot" seeds 5 feet away when activated by a slight disturbance.

- **Jewelweed, fresh:** crush some leaves and a bit of the stem and rub the resulting juice on the rashy area. Repeat frequently.
- **Jewelweed decoction:** take one part Jewelweed (or stronger as needed), and twenty parts water. Boil water in non-metallic container, add jewelweed, boil for fifteen minutes, strain and store in jar in fridge or freeze as ice cubes. Apply frequently.
- **Jewelweed juice:**
From YE71.MUSIC.FERRIS.EDU (Robert King):

- Gather the entire plant, leaves, stems, and all; the plant is very succulent and juicy... I have never had a need to add extra water, but if you do, use distilled. Don't be greedy, either trim tops & outer branches, or selectively take entire plants from the center of a crowded stand. One large (4-foot) plant should be adequate for the largest rash on one person. Plants will lose turgor and wilt quickly after cutting, this is OK, just makes it easier to emulsify.
- Liquefy the plants in a blender at the highest speed possible. Then extract the juice by filtering thru cloth, common strainer, or fruit press... a little pulp in the mix won't hurt, this will settle out after a couple hours, anyway. Use immediately, or refrigerate... this stuff spoils rapidly at room temperature..!!
- Apply the juice to the infected area with a common paint brush... I've found 1 to 2" size works best. Blow-dry the area as you apply it with a hair dryer on low heat... after several coats of 'paint,' an orange-colored "skin" will develop. This "skin" will protect uninfected areas against the poison ivy allergen.
- Repeat this procedure as needed, especially first thing in the morning, and before bedtime. Be sure to use common sense in keeping any fluid that happens to come from blisters away from unprotected areas... yourself AND others. Keeping the infected area as dry as possible will hasten the healing; continue application until no more blisters are present... usually about 3 days.
- Ironically, jewelweed favors growing in areas of similar habitat as poison ivy, therefore it can often be found nearby, preferring moist ground, near water, or often, even in shallow water. It grows rapidly in ideal environs, but usually doesn't reach significant size until mid-summer; therefore, it might pay to keep a bit frozen in the fridge from the previous year for early-season use. The

extract tends to spoil rapidly, even at cooler temperatures, so I wouldn't recommend keeping it for much more than a week without freezing... the fresh solution works best, anyway.

- **Catnip:** rub fresh catnip leaves on the affected area.
- **Mugwort** (Jilara [jane.swdc.stratus.com])
Pick two large handfuls of fresh mugwort (*Artemisia vulgaris*) and let infuse in 1 cup alcohol for overnight. Apply to affected area with a clean sponge/washcloth/q-tips/whatever every four hours. Dries it up quickly.
Robert Gault reminded me that mugwort is a strong allergen (have I told you they keep track of mugwort pollen in the air over here?). To quote Robert Gault: 'Can you imagine the result if the poison ivy sufferer is also allergic to Mugwort?!' Ouch - yes, I can.
- **Aloe vera** (Jilara [jane.swdc.stratus.com])
Take a large leaf from the aloe vera plant you keep on your windowsill for burns. (If you don't have one, get one!) (NOTE: "aloe vera gel" sold commercially does NOT work!) Slice lengthwise to expose the juicy interior of the leaf. (This will give you an upper and lower leaf, with a juicy side to each.) Trim off leaf edges. Apply directly to affected area, juicy side against the sores. Bandage in place. Apply a new leaf every day until healed. This works phenomenally well, but you have to put up with bulky slabs of aloe vera leaf against the area. Which would you rather have: oozing sores or a succulent slab of leaf? Thought so. ;-) I can't laude this one enough! It works faster than any other remedy! And relieves the dreadful *itching*, too!
- **Gumweed Plant** (*Grindelia*)
Native Americans used the resin from the gumweed plant to treat poison ivy.
- **Baking Soda**
I swear by baking soda paste for poison oak. It not only soaks up the oozing mess, it completely stops the itching throughout the day.
- **Mixed alcohol liniment**
Take sweetfern, jewelweed, witch hazel, rubbing alcohol... Zip it all up in a blender until it's green and mashed, let it sit for two weeks (ouch! I know...not for THIS outbreak, sorry), strain it and voila, a marvy liniment.
- **Poison Ivy leaf**
From: bear.helium.Gas.UUG.Arizona.EDU (Soaring Bear), May 1994:
Actually, this is just the time of the year to build up your immunity by nipping off a very tiny piece of poison ivy leaf (size of a head of a pin) and put in a capsule and swallow. Do 1-2 times a week. Stop if you start breaking out.
Caution from krrobert.uiuc.edu (K. R. Robertson):
Eating a leaf of poison ivy may have disastrous results. One may surpass his normal level of immunity by the first bite; in this case he is in for an internal case of poison-ivy, occasionally known to be fatal.
- **Salt** (from bss8n.galen.med.virginia.edu)
For the little initial blisters, I rub salt and burst them and leave the salt on to dry. They're history. Also salt worked on the moist areas of my face and under my nose where lye soap lather couldn't stay dried out long enough to dry out the rash. Works well on large surface rashes in case the blister stage grew untreated (but it didn't work on the "mini-mountain"

reaction to p.i. that my mom got). MOST essential, leave the salt on to dry, adding more salt moistened with water to help create a paste that will stick as it dries, thus drying out that nasty, annoying p.i. The worse the spread, the longer the duration of salt/soap treatment alternated 12 hours to 1) dry out the present fresh redness, and 2) dry out *new* fresh red. Yep, you guessed it... the salt falls off everywhere. That's one reason I used the lye soap during bed hours. The other reason was that neither treatment, in a prolonged battle (1 1/2 wks) stayed effective by itself, i.e. continuous dry-out, but alternating them did it. I've wondered why?

- **Lye soap** (bss8n.galen.med.virginia.edu)
 - initially from a pioneer reenactment lady. The older/yellower the bar got, the less effective it seemed. Now, I've found it at the grungiest grocery store in town, a soap called Oxygen. Wet the bar and lather it up on the rash into a paste and let dry. Easier than the salt but since discovering salt, I tend to believe salt is more effective for me, at least with my initial tiny blisters, which is all I ever have to deal with now.

2.7.5 Jewelweed, *Impatiens*



From Elizabeth Perdomo, ElizPer.aol.com:

Jewelweed is a plant I wouldn't be without here in the South, any time of the year! It works so remarkably well for Poison Ivy, Oak and Sumac, and for Fungal Infections, as well (try it on athlete's feet!). People are always getting inspired to rake up leaves in the middle of winter, and get into the roots or old leaves, producing the nasty itch. However, since the plant only grows in mid-late summer, this is what I do to keep a supply around...

Harvesting: Jewelweed is an annual, which means it flowers, produces seeds and then dies all in one year. Thus, I try to harvest Jewelweed well before flowering time, so it has a chance to regroup, flower and seed before frosts. To do so, I cut off (with knife or pruner) the top 1/3 of some of the plants, leaving many untouched. I don't pull or pinch the tops, as this often dislodges or pulls up the plant. If you take more than about the top 1/3, the plant may not have enough time to sprout side shoots and go to seed, thus diminishing future supply for you, others & the earth...

Preparing: Jewelweed is one of those plants which just doesn't dry well. It's too fleshy and juicy, and loses its good qualities when dried. I make a strong infusion, by adding LOTS of the plant to a pot (non-aluminium) of boiling water. Then, I cover the pot, and allow it to simmer for at least 30 minutes. After simmering, covered, I put it into a blender or food processor and blend. Then, I

cover the mixture again and allow it to cool to room temp. After cooling, I strain the mixture through a stainless steel strainer and/or cheesecloth. Then, if needed right away, I label and store part of the mixture in a jar in the refrigerator. The remainder, I freeze in ice cube trays. After frozen, pop the cubes into a zip lock bag and LABEL WELL with herb name/date before returning to freezer. Then, I have a winter's supply. The cubes also feel really good on especially sensitive areas, like on the face, between fingers, under arms and in private parts... I also use the fresh Jewelweed and make it into a tincture by filling a jar with the plant, and then covering it with 100 proof vodka. If you are going to use it exclusively for EXTERNAL use, it could be "tinctured" in rubbing alcohol.

Administering: Whether fresh, infused, tinctured or in ice cube form, apply Frequently!!! Cotton balls work well to apply the infusion or tincture. Yes, the tincture burns some, so I dampen the cotton ball 1st with water, then add the tincture. The alcohol also helps to dry out the ooze... If someone has a really bad, "systemic" case (not just a few bumps on their ankles or hands), I recommend that folks take the (vodka) tincture INTERNALLY, about 1/2 dropper 2-4 x Daily, in liquid, But for only 2-3 Days! (I don't recommend using this orally if pregnant or nursing.) It seems that the oral use in conjunction with frequent, liberal external use, can really turn a bad case of poison ivy around fast! Also, for "oozy" spots, cosmetic grade (French) clay can be sprinkled on as often as desired to help dry the spots out. Sometimes, I mix the clay with powdered oatmeal, and apply the mixture to absorb and sooth.

Elizabeth Perdomo

From: Peter Gail <PETERGAIL.AOL.COM>

Re: the post about jewelweed tincture: Be extremely careful in applying an alcohol extract of jewelweed on anybody. Over the past 8 years Steven Foster has reported one and I have observed 3 extremely severe skin reactions from such applications, in each case landing the person in hospital. Euell Gibbons also referred to the possiblity of allergic reactions to jewelweed tinctures.

Comment from Henriette: the frozen cubes don't have these risks.

2.7.6 How to get rid of poison ivy in your yard

Suggestions from rec.gardens/alt.folklore.herbs:

1. Planting catnip should get rid of poison ivy.
2. Goats. They are very effective, but in the end will be a bigger bother than the poison ivy. (Be suspicious if someone offers you free goats!)
3. Poison ivy again: buy the super concentrated form of Round-Up and dilute to 3 times the recommended strength. (Well, hot damn! It killed off nearly every piece of PI in one application and only a few (about a dozen) plants returned a year later.)
4. Pull it, but protect yourself (big plastic bag, disposable suit...) Immediately wash all clothes you used two-three times. Do not touch the plastic bag / disposable suit from the outside. Do

not touch your clothes / boots / whatever from the outside before washing.

[Home](#) - [Herb FAQs](#) - [Articles](#) - [Classic texts](#) - [Archives](#) - [Links I like](#) - [Pictures](#) - [Plant names](#)





[Home](#) > [Herb FAQs](#) > [Medicinal herb FAQ](#) > [Single herbs](#) >

[Medicinal herb FAQ: Intro](#) - [Single herbs](#) - [Herbs for specific things](#) - [Processing herbs](#) - [General info](#) - [Information sources](#) - [Schools](#) - [Related forums](#)

The Medicinal HerbFAQ

2.8 Echinacea



[uses](#) - [poaching](#)

2.8.1 Using Echinacea

(also see King's dispensatory, here: <http://www.ibiblio.org/herbmed/eclectic/kings/echinacea.html>)

From Todd Caldecott (toddius.netidea.com):

In my training with NA's I learned that *Echinacea* (blood purifier and antibiotic) can be used as long as two weeks. The German research branch of their equivalent of FDA (called Kommission E) Drs. Wagoner and Bauer demonstrated this fact. Their studies also showed that tinctured extract of this plant could be chemically potent or not depending on how it was grown, harvested and extracted. In their studies, the extracts available on the commercial market were far less potent than their own prepared version. So their conclusion was 2 weeks on then off for a week, then one could use it for another two weeks at diminished activity. Also the plant varieties of *Echinacea angustifolia*, *E. purpurea* and to a lesser extent *E. pallida* all had medicinal chemical activity. The whole plant is medicinal but needs to be at least 3 years old before you should harvest.

There is no evidence to suggest that *Echinacea* cannot be used longer than 2 weeks. In the original study (and please be patient I'm doing this from memory) *Echinacea* was found to be increasingly effective for 5 days, after which the study ceased. This paper, originally written in German, was mistranslated, leading one to believe that *Echinacea's* effects plateaued after five days. *Echinacea* is being used by several professionals long term. Typically though, it is used as a surface immune tonic, useful in chronically immunodepressed patients who suffer from chronic colds etc. (although its use in AIDS is still a matter of some controversy). For most of us who take it seasonally for colds etc. it is most effective when taken in combination with other herbs i.e. garlic,

Baptisia, Thymus, Astragalus etc.

2.8.2 Echinacea - poaching and extinction



Thread on the phytopharmacognosy list:

> Over 90% of all *Echinacea* material in the U.S. and Europe comes from cultivated species. There is very little wild harvested ech. on the market. The claim that the use of ech. preparations contributes to the extinction of this plant species is nonsense. Such claims may apply to other medicinal plants but not to the easy to cultivate Ech. spp..

From P. Mick Richardson <richards.mobot.org>, to above:

Disappearance of the plant in the wild may be nonsense to you but it is reality to those of us who live in areas where the plant is native. Several points. The plant is easy to grow in cultivation but if you have no land on which to grow it you can get ready cash by collecting it in the wild. Even if 90% comes from cultivated sources, the remaining 10% is still a massive amount in relation to the ever decreasing number of plants in the wild, especially when consumption rises each year and the 10% translates into an ever increasing number of plants to be sought.

After receiving your message, I sought out a local person who collects seeds of *Echinacea* from wild plants in Missouri for cultivation of the plant. He confirmed my suspicions that the plant is becoming non-existent in many parts of Missouri as local populations are exterminated. So the nonsense is in fact reality to the people who see the plants. I suggest greater cultivation of the plant would decrease the demand for wild-harvested material. After all, no-one would be killing rhinos and elephants for sale if there was not a market for them. Let's stop before *Echinacea* becomes a great auk or a passenger pigeon example for textbooks. Sorry to ramble on, but extinction is for ever and it would be shameful for herbalists to contribute to it.

... and more in the same thread:

From: P. Mick Richardson <richards.mobot.org>:

It is illegal to collect *Echinacea* unless it is on your own property in Missouri. However, if someone offers cash for echinacea plants, then the demand will be met by poaching. Although on a lesser scale, it is no different to the situation with rhino horn and elephant ivory. If there is a cash

market, people will provide the product. I could give descriptions of the nationalities of the buyers but this is probably unnecessary. The plants end up in Europe, presumably the site of greatest demand.

Hopefully, there will soon be enough *Echinacea* in cultivation that the price will fall and this may remove the demand for wild-collected plants. Until then, if you encourage the use of *Echinacea*, you endanger the plants growing wild in Missouri. Admittedly *Echinacea* is being poached on a lesser scale than *Panax* or *Hydrastis*, but it is still disappearing. Let's aim for complete domestication. It works for *Ginkgo*, which is a cultivated cash crop in the U.S.A. now.

[Home](#) - [Herb FAQs](#) - [Articles](#) - [Classic texts](#) - [Archives](#) - [Links I like](#) - [Pictures](#) - [Plant names](#)





[Home](#) > [Herb FAQs](#) > [Medicinal herb FAQ](#) > [Single herbs](#) >

[Medicinal herb FAQ: Intro](#) - [Single herbs](#) - [Herbs for specific things](#) - [Processing herbs](#) - [General info](#) - [Information sources](#) - [Schools](#) - [Related forums](#)

The Medicinal HerbFAQ

2.9 Feverfew and migraine



by Eugenia Provence, Eprovidence.aol.com

It's not at all unusual for people interested in using herbs to replace over the counter medications with simple herbal counterparts. What has been unusual enough to generate headlines, though, is the conventional medical community's research and acceptance of a traditional European folk remedy, Feverfew, in preventing migraine headaches.

Migraines are believed to be caused by an upset in serotonin metabolism, causing spasms of intracranial blood vessels, which then causes dilation of extracranial blood vessels.

In the 1970s an English research group sought volunteers already using Feverfew before beginning a study of its efficacy. Their advertisement in a London newspaper brought more than 20,000 responses. Since then, several well-documented double-blind, placebo studies in England confirm its value.

An interesting one reported in *The Lancet* (July 23, 1988; 2(8604):189- 192) followed 72 volunteers. After a one-month trial using only a placebo, half of the group received either one capsule of dried Feverfew leaves a day (or a matching placebo) for four months. Neither the group nor the researchers knew which group was receiving the Feverfew. The group kept diary cards of their migraine frequency and severity. After four months, the groups switched medications, and the trial continued for an additional four months. 60 patients completed the study, and full information was available on all but one.

The study found Feverfew to be associated with reducing the number and severity of attacks (including vomiting), with the researchers concluding that there had been a significant

improvement when the patients were taking Feverfew. There were no serious side effects. Feverfew is currently classified as *Tanacetum parthenium*, a member of the Asteracea (or Compositae) family, and was formerly named *Chrysanthemum parthenium*, where you'll still find it listed in some references. Feverfew is a corruption of Febrifuge, based on its tonic and fever-dispelling properties. It's been called Maid's Weed, referring to its emmenagogue qualities, which are also reflected in its Greek name, Parthenion ("girl").

Its primary actions are anti-inflammatory, bitter, emmenagogue and a vasodilator. Aside from migraine relief, long-term users report relief from depression, nausea and inflammatory arthritic pain. Drunk in cold infusion, it can relieve the cold, clammy sweats associated with migraine. Additionally, it's been used externally as an insect repellent, and topically for insect bites. Perhaps the insect-repelling quality accounts for the tradition of planting it around the house to ward off illnesses and to purify the air.

The tea, drunk cold, has been used for sensitivity to pain, and for relief of face-ache or ear ache (all migraine-like symptoms). The Eclectic physicians of the 19th century called it one of the pleasantest of the tonics, influencing the whole intestinal tract, increasing the appetite, improving digestion, promoting secretion, with a decided action on kidney and skin.

John Gerard's Herbal in 1663, said it to be "...good against summer headaches to inhale crushed Feverfew blossoms. Dried and taken with honey or sweet wine good for those as be melancholic, sad, pensive or without speech." Culpepper used in it poultice form for head ache.

Feverfew in blossom is easily identified by its flat or convex yellow disk and numerous short, broad 2-ribbed white rays. The leaves are alternate, petiolate, flat, bi or tripinnate with ovate, dentate segments. It quickly escapes cultivation, and has become naturalized in many areas of the U.S. and Europe, in some places regarded as a nuisance weed.

Among its constituents are a volatile oil, containing pinene and several pinene derivatives, bornyl acetate and angelate, costic acid, B-farnesine and spiroketal enol ethers; Sesquiterpene lactones, the major one being parthenolide); and Acetylene derivatives.

Pharmacologists say it is likely that the sesquiterpene lactones in Feverfew inhibit prostaglandin and histimine released during the inflammatory process, preventing the vascular spasms that cause migraines. It appears to regulate the serotonin mechanism.

To attain the maximum benefit from Feverfew, it should be taken daily as a preventive. For migraine prevention, parthenolide plays an important role. The parthenolide content in Feverfew is highly variable in different populations grown in different locations or harvested at different times of the year.

Recent Canadian tests of U.S. Feverfew products found all of them to be low in parthenolide. Canada, which has recently recognized Feverfew products as official, over the counter drugs for migraine prevention and relief, will require that they contain a minimum of 0.2% parthenolide. So, this is one of the few cases where a standardized extract may be more desirable than the whole plant, with a lot to be said for fresh or freeze-dried preparations. If you want to use the fresh plant, the flowers have a higher parthenolide content than do the leaves. If you are picking the leaves, they are best just before flowering.

In one of those magical bits of synergy that herbalists love, the isolated parthenolides used alone don't work on migraines, nor does the whole plant with the parthenolides removed. The parthenolide is bioavailable only in the whole plant.

PRECAUTIONS: I know of nothing, whether allopathic or herbal medicine, that I would feel free in saying to have absolutely no unpleasant side effects. We're all unique individuals when it comes to body chemistry. Some unfortunate people are allergic to chamomile. They may also be allergic to Feverfew.

A few recent studies of parthenolide in vitro point to toxicity involving smooth muscle tissue. However, no side effect resembling this has ever been reported in human use. Feverfew's safety and usefulness are historic.

Pregnant women should never take Feverfew. Its traditional use as an emmenagogue underlines the risk here.

The bitter tonic qualities, so useful for indigestion, can cause gastric pain in people with gall stones or gall-bladder problems, by making the gall bladder try to empty. Likewise, the increased production of stomach acid would make it highly aggravating to anyone with a gastric ulcer or esophageal reflux.

Some people have developed mouth ulcers from eating the fresh leaves.

DOSAGE: Feverfew is most effective fresh or freeze dried. Take the equivalent of 1 fresh leaf or 125 mg. freeze-dried herb once a day (0.2% parthenolides) 1-3 times daily (don't chew the leaf). In addition to Feverfew on its own as preventive herbal therapy, one would want to look at one's individual migraine triggers or pattern and add herbs whose actions complement Feverfew's anti-inflammatory, bitter and vasodilator actions to support the affected body systems.

Please also check entry [3.2, Herbs for migraine](#).

From Rene Burrough <rburrough.dial.pipex.com>:

Eating feverfew leaves I learned this from a nursery woman here who grows herbs commercially & was a nurse during WW2, and has suffered from migraines from years, and it extremely sympathetic to herbal medicine. She swears that the GREEN leaf is far more efficacious than the yellow or golden version. And she takes one leaf a day for months at a time to keep the migraine at bay. What she does is to make a <bread pill> with the feverfew leaf inside and squished into a tiny ball with a doughy bit of bread around it as a casing. Then the pill can be swallowed without the leaf coming into contact with the lining of the digestive tract.

Feverfew dangers, in the best of the herbal forums:

<http://www.ibiblio.org/herbmed/archives/Best/1995/feverfew-3.html>

<http://www.ibiblio.org/herbmed/archives/Best/1995/feverfew-se.html>

[Home](#) - [Herb FAQs](#) - [Articles](#) - [Classic texts](#) - [Archives](#) - [Links I like](#) - [Pictures](#) - [Plant names](#)





[Home](#) > [Herb FAQs](#) > [Medicinal herb FAQ](#) > [Single herbs](#) >

[Medicinal herb FAQ: Intro](#) - [Single herbs](#) - [Herbs for specific things](#) - [Processing herbs](#) - [General info](#) - [Information sources](#) - [Schools](#) - [Related forums](#)

The Medicinal HerbFAQ

2.10 Kava kava

by Dennis McClain-Furmanski (dynasor.infi.net)

Kava-kava (*Piper methysticum*) is a plant native to the Pacific Islands, originally from the island of Vanuatu. Following the influx of missionaries over the last century, its cultivation and use has decreased but not disappeared. Several botanical houses in the US and elsewhere have begun regular cultivation. The supply remains low, as the harvest rotation period is from 1.5 to 5 years. Restrictions on import have been considered and may be imminent, meaning only locally grown supplies will be available. Indigenous growths are now being protected as endangered in some areas, but this does not preclude cultivation.

Kava is more of a social and ceremonial preparation than it is medicinal. Its primary action is as a relaxant, and at high levels an intoxicant and divinatory preparation. In normal use, the kava drinker becomes relaxed and sociable, and may later drift off into reverie. Large doses, as used by village chieftains and seers, induces a trance-like state with vivid dreaming. It is still used in some areas as a medicinal liniment, being prepared there as a tincture. Modern use of kava has included a preparation given to electroshock therapy patients as a muscle relaxant.

The active constituents of the plant, such as the lactone resins yangonine and kawaine, are found primarily in the root rhizomes, although some preparations such as the Hawaiian liniment make use of the fresh stem. Most preparations use chopped root material. There are some commercial products in the form of tablets made from a powder, but these tend to suffer in strength, apparently due to excessive drying.

Use of kava requires bringing the insoluble resins into emulsion. Traditional preparation is done by chewing the stems and spitting them with copious saliva into a bowl, to which water and coconut juice is added. The mixture is then kneaded and strained through fiber and drunk immediately.

A more palatable preparation is to wrap about an ounce in a single layer of plain cotton cloth or a few layers of cheese cloth, and tied off to form a ball. This is dunked in a quart or so of water, lifted and squeezed out, repeating this until the bubbles forming from the dripping water tend to remain on the surface of the water -- about 10 to 15 minutes. As with the traditional preparation, this tastes strongly musty and not particularly pleasant. It is drunk immediately in gulps. A tablespoon of sugar helps, and my favorite additive is a tablespoon of Ovaltine or other malted

mixture. Most non-traditional preparations such as herb teas and other mixtures are either too low a dosage or improperly prepared and so are ineffective, most probably due to the bad taste of effective dosages.

A tincture is made by soaking the chopped root material in 3 times its volume of alcoholic liquor such as brandy or gin. This is shaken daily over 2 or 3 weeks and then strained. Internal use is 1 to 2 ounces, and external use is an ounce rubbed into sore muscles or soaked into a cloth which is laid over the affected area.

Some reports have been made regarding chewing and swallowing fresh root. All the same effects are noted, with the addition of a decongestant-like opening of breathing passages. This is only in healthy individuals; there is no true decongestant effect in congested individuals.

Heavy daily use of kava for years has been reported to cause dry, flaking skin, yellowing of the eyes and persistent lethargy. The doses involved are those used by local chiefs and visionaries, and normal recreational or medicinal use will not cause this. When this syndrome does appear, 2 to 3 weeks of abstinence cures it. Reports of lowered peripheral blood flow seem to be anecdotal only.

The plant itself is available from some ethnobotanical houses, and seems to thrive even in non-tropical conditions, though it still requires indoor cultivation.

[Home](#) - [Herb FAQs](#) - [Articles](#) - [Classic texts](#) - [Archives](#) - [Links I like](#) - [Pictures](#) - [Plant names](#)





[Home](#) > [Herb FAQs](#) > [Medicinal herb FAQ](#) > [Single herbs](#) >

[Medicinal herb FAQ: Intro](#) - [Single herbs](#) - [Herbs for specific things](#) - [Processing herbs](#) - [General info](#) - [Information sources](#) - [Schools](#) - [Related forums](#)

The Medicinal HerbFAQ

2.11 Pau D'Arco

by Dennis McClain-Furmanski (dynasor.infi.net)

Pau D'Arco (*Tabebuia impetiginosa*), also known as Taheebo and Lapacho colorado, is a tree native to the Andes and nearby rain forests. The bark, and in particular the inner bark lining, is scraped and turned into a tea. It has been used for centuries by the indigenous peoples as an immunofortifier.

Recent pharmacologic studies have uncovered the anti-tumor agent lapachol, as well as the anti-candidas agent xylidione, and the consistent effects of both have gathered the interest of the global pharmacological community. Claims that the tea contains a large proportion of oxygen in solution have peaked the interest of the oxygen-therapy movement, and it is being considered for anti-AIDS/HIV testing.

The normal preparation is a small amount of scraped bark prepared as a normal tea. The taste is reported to be heady and pleasant.

From hrbmoore.rt66.com (Michael Moore), as a sidenote in a post on herbs and fibroids: I, frankly, have no idea why you would want to use Pau D'Arco (*Tabebuia* spp.). It is a useful anti-oxidant and anti-fungal. I fail to see its implication with fibroids. Besides, it is a pocket-change byproduct of rain-forest timbering...don't let anyone fool you otherwise.

From Susan Marynowski (sumar.mail.ifas.ufl.edu):

Pau d'arco is a common street and park tree of central and southern Florida. It can easily be grown in a Florida backyard where it would be protected from freezing. Because of the value of this tree, I often encourage people to grow or collect their own in Florida instead of purchasing rainforest product.

[Home](#) - [Herb FAQs](#) - [Articles](#) - [Classic texts](#) - [Archives](#) - [Links I like](#) - [Pictures](#) - [Plant names](#)





[Home](#) > [Herb FAQs](#) > [Medicinal herb FAQ](#) > [Single herbs](#) >

[Medicinal herb FAQ: Intro](#) - [Single herbs](#) - [Herbs for specific things](#) - [Processing herbs](#) - [General info](#) - [Information sources](#) - [Schools](#) - [Related forums](#)

The Medicinal HerbFAQ

2.12 Wild yam and contraception

This one is from Henriette, with help from unca Mike and unca Jonno.

A stubborn question, coming up on the newsgroups and mailing lists again and again: "How do you use wild yam for herbal birth control?"

Wild yam (*Dioscorea villosa*) does not work as a herbal birth control. People who try it invariably end up being called "Mom", unless they're naturally infertile.

So why is this myth still going strong?

Back in the early 40's the only hormones available were very expensive, injectable slaughterhouse hormones. An American, Dr. Russell Marker, had this great idea on making oral hormones from saponins (actually they're not really hormones, just hormone look-alikes - but that's another topic), and tried to get backing for research on this from the pharmaceutical companies of the time. None of these thought this worth pursuing ("we -have- hormones, enough for our needs, why would anybody want cheap oral hormones?") (which goes to show just how short-sighted people can be). Dr. Marker then went abroad, and the Mexican ministry of health said yep, sounds like a good idea. So he went to Mexico and started to look for plants with lots of saponins. Both Yucca and Agave roots contain enough saponins, and both were abundant, but neither was acceptable to the Mexican government as they were needed in the Tequila industry. So Dr. Marker settled for a plant that was abundant and easy to grow: *Dioscorea mexicana*, Mexican yam. It took him a couple of years to get the "Marker Degradation Process" going, and he proceeded to make progesterone, in a lab, from the saponin diosgenin found in said Mexican yam. At first the process was not economically feasible (at something like 37 steps), but when he got it down to something like 6 steps, industrial production of oral hormone look-alikes took off. And so did contraceptive pills.

A decade or three later: officials in strategic places in Mexico are looking at OPEC, thinking, "Hmmm, those guys have a monopoly -and- money, we can do that too." So they doubled the prices of the output of their oral hormone precursor factories, and whammy, next thing you see is Japanese looking around for cheap raw material - aha, soybeans. So the Japanese put up a couple of factories of their own, undercut the Mexican prices, and diosgenin the oral hormone raw material was no more. It's all soybeans now, folks.

Back then you also saw lots and lots of semi-scientific herbalists latch on to the sentence

"*Dioscorea* is a hormone precursor". These guys and gals were totally disregarding the fact that a lab is needed between raw root and hormone precursor. People use cholesterols as steroid hormone precursors. The only time you're short of cholesterols is when you're reduced to skin and bones and one big belly - and if so, you've got far worse problems to worry about than an upset hormone cycle.

Now why did the name "Mexican yam" morph into things like "Mexican wild yam", "wild Mexican yam", and later on even into "wild yam" (which properly is another species altogether, *Dioscorea villosa*)? In the 50's and 60's Mexico fell out of fashion and, in the minds of norteamericanos, got an image as a poor country. In a stroke of genius some semi-scientific herbalists, this time exclusively from North America (at least at first), thought "we don't want any of that there imported stuff, we've got wild yam (*Dioscorea villosa*), let's use that". Now, if you know your plants, you know that *Dioscorea villosa* is a North American plant that's been widely used as an antispasmodic (it's also called "colic root"). It has -never- been used for diosgenin extraction, nor has it therefore ever seen the inside of an oral hormone factory. It probably won't ever be used that way, either, as a) it doesn't contain enough saponins to make industrial hormone precursor manufacture worthwhile, and b) it's really not all that abundant, nor all that easy to gather in quantity.

However, thus was born the name and concept of wild yam cream. Both are completely off the wall, if you ask me. Be honest about it and call it progesterone cream, and tell folks just how much natural progesterone you added to that there cream, so they know in advance just how well the cream will work.

2.12.1 Edible vs. true yam

From Michael Moore:

Edible yams and sweet potatoes are simply different strains of the same plant...edible tubers of several varieties of *Ipomoea batatas*. NO "true yam" (*Dioscorea* spp.) is used in North America for food. Most *Dioscoreas* are about as edible as pencil shavings, with less taste.

From Thomas Mueller:

I can't recall ever tasting pencil shavings, but true yams, *Dioscorea* genus, are cultivated and eaten in tropical countries, and some are available in some ethnic markets in the USA. In my experience, these yams are starchy, not sweet, more like potato than sweet potato, but lower water content than potato.

From bogus.purr.demon.co.uk (Jack Campin):

And they are widely available in the UK, anywhere there's a sizable Asian or Afro-Caribbean population, i.e. pretty much any city. The smaller variety are usually called "eddoes", the large variety just "yams". Nobody calls sweet potatoes yams here any more (they probably did after WW2; that was what my father learned to call them when in the army in India and North Africa, but he unlearned it fast enough in New Zealand).

From Henriette:

Edible yams roots are enormous. Peel, cut into chunks, boil with a bit of oil and salt. They take longer than your usual starchy vegetable to boil. They don't get all that soft. The cooking water transforms into an unappetizing whitish jelly overnight. Not really all that tasty.

Sweet potatoes, batatas, are smaller (in fact, somebody told me, long ago, the smaller the better). Peel, cut into bits, boil. Add a dash of butter - yum, *tasty*! The ones I've tried have all been more or less yellowish internally, with a whitish sap (sticky when dry) that turns gray on exposure to air. They're done about as fast as potatoes, and go about as soft as potatoes, too.

I expect Michael means that the North American species of *Dioscorea* do not sport edible roots.

2.12.2 Wild yam cream and natural progesterone

Wild yam (*Dioscorea villosa*) as such does not contain progesterone nor anything else that would act like progesterone. It's a good antispasmodic, and that's it. So, unless your menopausal symptoms include lots of cramps wild yam won't do squat for them.

The "wild yam" creams that work for menopausal symptoms (like hot flashes) contain synthetic natural progesterone. Natural progesterone is a pharmaceutical term. It doesn't mean that the progesterone is plant-derived, nor that the plants it possibly is derived from are organically grown - it means that the progesterone is identical to the human hormone progesterone. Natural progesterone is all synthetic, i.e. you need a lab to manufacture it from your raw materials. Unless, of course, it's extracted from animal glands, in which case it's *not* identical to our own progesterone (vide the allergic reactions from animal-derived conjugated hormones), and should be called something else.

How come these creams can contain synthetic progesterone without that being stated on the label? Natural progesterone is considered a cosmetic in the USA, because the FDA doesn't recognize that topical progesterone works ("just look at those women, they'll believe *-anything-*..."). Labeling of cosmetics is rather loose, and if you squint hard enough the legislation gets blurred, too. So you end up with creams labeled "wild yam extract" or something equally unlikely. This might be bordering on the illegal, particularly considering that you won't find any progesterone derived from wild yam (*Dioscorea villosa*) on the market.

Like I said, be honest about it and call it progesterone cream, -and- add amounts to your labels.

For further reading you can try John Lee's book "Natural progesterone, the many roles of a wonderful hormone". He's also written "What your doctor may not tell you about menopause". I don't have either so can't say how good they are.

[Home](#) - [Herb FAQs](#) - [Articles](#) - [Classic texts](#) - [Archives](#) - [Links I like](#) - [Pictures](#) - [Plant names](#)





[Home](#) > [Herb FAQs](#) > [Medicinal herb FAQ](#) > [Single herbs](#) >

[Medicinal herb FAQ: Intro](#) - [Single herbs](#) - [Herbs for specific things](#) - [Processing herbs](#) - [General info](#) - [Information sources](#) - [Schools](#) - [Related forums](#)

The Medicinal HerbFAQ

2.13 Red raspberry and pregnancy



You use an infusion of the leaf of *Rubus idaeus* to ease pregnancy and/or childbirth. The controversy is when to use it - throughout the pregnancy or just the last trimester. One piece of advice on the paracelsus list:

From: herbal.got.net (Roy Upton)

Almost all popular texts state that red raspberry is good to use throughout pregnancy. On several occasions I have seen first trimester women experience spotting each time they drank moderate amounts of the tea. When they discontinued the tea, spotting stopped. Four tried the tea again and spotting began again. I asked a few midwives about their experience and found that they too had experienced the same thing, so did not generally recommend it in the first trimester. I do not feel that red raspberry is inherently problematic, but also feel that is not necessarily inherently benign.

[Home](#) - [Herb FAQs](#) - [Articles](#) - [Classic texts](#) - [Archives](#) - [Links I like](#) - [Pictures](#) - [Plant names](#)





[Home](#) > [Herb FAQs](#) > [Medicinal herb FAQ](#) > [Single herbs](#) >

[Medicinal herb FAQ: Intro](#) - [Single herbs](#) - [Herbs for specific things](#) - [Processing herbs](#) - [General info](#) - [Information sources](#) - [Schools](#) - [Related forums](#)

The Medicinal HerbFAQ

2.14 Green tea and caffeine

The usual question is: does green tea contain caffeine? The answer is yes, if it hasn't been decaffeinated. So does black tea, and oolong. A good post on teas in general and green tea in particular:

From alczap.thorne.com (Al Czap):

It is thought that the traditional use of tea (*Camellia sinensis*) began in China about 4700 years ago. Europeans were introduced to the beverage in the 1500's, and by the second half of the 17th century it was being widely consumed throughout Europe. Today, tea is the second most consumed beverage in the world (water is #1) with 2.5 million tons of tea leaves produced annually.

The Chinese produce over 300 varieties of tea, which can be separated into three basic categories; black tea, oolong tea, and green tea.

These three types of tea can actually be derived from the exact same plant. The difference between them is how the leaves are handled after harvesting. Black tea is allowed to ferment, and is then dried. Oolong tea is partially fermented. Green tea is dried without fermenting. Allowing the tea to ferment oxidizes naturally-occurring catechins, transforming them into theaflavins and thearubigin, chemicals responsible for the color and flavor of black tea. An increase in theaflavins increases the commercial value of black tea, but decreases the catechin content.

Green tea infusion contains intact catechin polyphenols, which give rise to its bitterness and astringency. Six catechin polyphenols have been isolated from green tea; (-)-epigallocatechin, (-)-epicatechin, (-)-epigallocatechin-3-O-gallate (EGCG), gallocatechin-3-O-gallate (GCG), methyl-epigallocatechin-3-O-gallate, and (-)-epicatechin-3-O-gallate (ECG). These substances were tested for their antioxidant activity, and the gallic acid esters EGCG and EGC were found to be the strongest antioxidants, with EGCG being over 200 times more active than Vitamin E in an in vitro model. In another test, EGCG was more active against fat rancidity (lipid peroxidation) than Vitamin C or Vitamin E, and also exhibited synergistic action with those vitamins.

Many nutritive and protective qualities have been associated with green tea, both in infusion and extract form. A Japanese epidemiological study of 9500 non-drinkers/non-smokers age 40 and above showed a decreased incidence of stroke (CVA) in those consuming green tea, with a direct correlation between increased consumption and decreased incidence, so that at 3-4 cups a day the

overall incidence of CVA was 17 percent that of people drinking no tea. Other epidemiological studies show a decreased risk of esophageal, gastric, and colon neoplasms with tea consumption.

Numerous studies have shown that standardized green tea extracts or components of the extract exhibit antioxidant activity, stimulation of glutathione peroxidase and catalase, induction of phase II enzymes, and inhibition of cyclooxygenase, lipoxygenase, and angiotensin converting enzyme. Green tea extract also has anti-platelet-aggregation activity, and inhibits delta-amylase and sucrase, in addition to the known effects of catechin: collagen stabilization, histidine decarboxylase inhibition, and hepatic support.

Green tea extracts can contain a substantial amount of caffeine, and may be standardized to low levels of polyphenols. HPLC isolation and identification reveals that the main constituent of our extract is EGCG (epigallocatechin gallate), the most active compound in the extract.

[Home](#) - [Herb FAQs](#) - [Articles](#) - [Classic texts](#) - [Archives](#) - [Links I like](#) - [Pictures](#) - [Plant names](#)





[Home](#) > [Herb FAQs](#) > [Medicinal herb FAQ](#) > [Single herbs](#) >

[Medicinal herb FAQ: Intro](#) - [Single herbs](#) - [Herbs for specific things](#) - [Processing herbs](#) - [General info](#) - [Information sources](#) - [Schools](#) - [Related forums](#)

The Medicinal HerbFAQ

2.15 Comfrey hepatotoxicity



From: Rene Burrough <rburrough.dial.pipex.com>

Comfrey is the victim of a bad press, inaccurate reports, and four true cases of toxicity which in themselves are not straightforward, but suggest overdosing on comfrey. Governments in the UK & Australia have restricted the uses of comfrey root or banned the plant respectively.

The problem is two-fold: firstly there are two "comfrees" and reference to them is often casual. Regular, common, medicinal comfrey is *Symphytum officinale*. Russian comfrey, the great compost heap maker, is *Symphytum x uplandicum*. Medical herbalists in the UK, from whose written reports I am extrapolating, point out that Russian comfrey was probably the herb used in the toxicity trials yet regular comfrey is also restricted or banned.

Secondly, when the toxicity tests were done in the late 70s, a chemical constituent called pyrrolizidine alkaloid was isolated, extracted from <comfrey> leaves & injected into baby rats at what many medical herbalists consider an "unrealistic level". In other words far more comfrey than a human would eat to get such a toxic level of <PAs>. Also baby rats are smaller than humans; they do not have the same metabolism as humans; and an isolated chemical injected outside the rat's stomach wall is not the same as a human eating leaves with many chemical constituents and digesting them normally. A chemical in isolation will cause different reactions from a group of chemical constituents containing that one as well.

To digress, but to explain, I hope. Aspirin is a synthesized chemical, acetylsalicylic acid, based on a real life plant constituent found in meadowsweet & willow. Aspirin can cause ulcerations of the stomach lining; meadowsweet has a soothing, gummy constituent called mucilage which lines the

stomach, preventing erosion of the stomach wall but allowing the anti inflammatory properties of the salicylates of the herb to be utilized. OK?

So -- the bad guys in <comfrey>, the <PAs> were isolated & did bad things. But that too must be qualified.

The early research, late 70s, concluded that these <PAs> do indeed cause liver damage in humans. Medical herbalists would point out that Pyrrolizidine alkaloids can cause obstructions of the veins in the human liver, known as hepatic veno-occlusion, but <were not shown to cause liver cell abnormalities> and that the level of alkaloids in comfrey was too low to <cause specific damage to liver circulation> in any case.

And finally, is comfrey carcinogenic? The carcinogenic alkaloid has been identified as symphytine which apparently is about 5% of the total alkaloids in comfrey.

The original, often cited report was written by Culver et al in 1980. There have been many criticisms since of the research itself; how the scientific testing was conducted, which comfrey was really used, etc. What I found most interesting was the tumors in all but three of the rats were benign -- out of three groups of 19-28 rats and 3 groups of 15-24 rats. <And the three malignant tumors were of low malignancy>. There were clear cut cases of liver damage. That's in rats.

There are four cases involving humans which do implicate comfrey. One involved a woman who was finally diagnosed as having veno-occlusive disease & did consume a quart of herbal tea/per day that contained comfrey. A second case involved a boy with Crohns disease who was treated with conventional medicine for some time before going over to comfrey root & acupuncture. The long running malnutrition may have weakened the liver predisposing it to the venal obstruction problem. Comfrey root was blamed. The drugs were not considered as possibilities. The third case involves a woman who overdosed: 10 cups of comfrey tea a day & handfuls of comfrey pills. After 9 years, she had serious liver problems. The fourth case became a fatality. A vegetarian, given to specific food binges for weeks, took an unknown amount of comfrey for flu like symptoms possibly over a period of four months. The particulars of his case are blurred. All cases involve comfrey; in at least three, there are suggestions of overdose or abuse of the plant. WHICH plant, I don't know.

There are also disagreements about the efficacy & safety of leaves vs. root. Some studies show the leaf to be almost alkaloid free -- thus safe. The UK finally restricted the internal use of comfrey root... saying that there are still too many unanswered questions. Most medical herbalists I know will politely to vigorously disagree, but the law restricts the root. At least externally the root's OK here & the leaves can still be used as tea or poultice.

I'm sorry this is so long, but bear with me one more paragraph, please. I must credit Penelope Ody, MNIMH, former Editor, writing in Herbs, the British Herb Society magazine & Margaret Whitelegg, MNIMH, whose paper for the National Institute of Medical herbalists to the UK government in <Defence of Comfrey> was later published in the European Journal of Herbal Medicine. Both were published in 1993. I cannot do justice to their articles so briefly, but I do hope I have fairly summarized their writings. Any misstatements, confusion of explanations here are mine.

2.15.1 Hepatotoxicity update

Comment from Henriette:

Yes, the pyrrolizidine alkaloids (PAs) in comfrey do hurt your liver. Yes, you have to take lots of the herb in order to get veno-occlusive liver disease. No, you can't blame that disease on pharmaceuticals taken at the same time - they'd hurt the liver in other ways. So don't take lots of comfrey every day for weeks at a time; if you do believe that you need it (and not, say, *Calendula*, which works much the same in wounds, or *Plantago*, which works much the same way both in wounds and in coughs; neither of these are problematic), take it in small amounts.

Know that if your liver is healthy it'll get hit worse than if it's already compromised. That is because the hepatotoxic PAs are catalysts, much like freons in the ozone layer - each cell tries its best to detoxify this molecule, can't do it, dies, and the next one tries, until the PA is passed out unchanged.

And know, too, that PAs are absorbed through the skin. That means that it's a really bad idea to use comfrey long-term for wounds.

Some comfrees are more toxic than others. Russian comfrey (*Symphytum x uplandicum*) is one of the worst. And there's more hepatotoxic PAs in comfrees that are grown without a real winter, eg. in California.

Other plants contain the same kinds of hepatotoxic PAs. Among these are, for instance, borage (not in the seeds, not much in the flower), some of the senecios, germander (*Teucrium chamaedrys*), and lungwort (*Pulmonaria* sp.). The most toxic ones of the lot are the *Lithospermums*.

[Home](#) - [Herb FAQs](#) - [Articles](#) - [Classic texts](#) - [Archives](#) - [Links I like](#) - [Pictures](#) - [Plant names](#)





[Home](#) > [Herb FAQs](#) > [Medicinal herb FAQ](#) > [Single herbs](#) >

[Medicinal herb FAQ: Intro](#) - [Single herbs](#) - [Herbs for specific things](#) - [Processing herbs](#) - [General info](#) - [Information sources](#) - [Schools](#) - [Related forums](#)

The Medicinal HerbFAQ

2.16 Pennyroyal

by Rene Burrough <rburrough.dial.pipex.com>

In answer to your question...how deadly & which one. The very brief answer is both IF you're talking about ingesting the isolated, essential oil. So, here's a longer answer.

Pennyroyal, European Pennyroyal (*Mentha pulegium*). Labiatae.

American Pennyroyal, Mock Pennyroyal (*Hedeoma pulegioides*). Labiatae.

Other synonyms for American Pennyroyal: Pudding grass, Lurk-in-the-ditch, Squaw mint, Mosquito plant.

I knew very little about pennyroyal, except that it seems to keep the ant population down in a large stone planter I have. Six feet long by 2 feet wide & 3 feet deep to ground level, it has been a hotbed of ant breeding for 15 years or so. Anything that grew there was by courtesy of millions of ants. I put two creeping pennyroyals in...and for the last two years there have been considerably fewer massive colonies of ants. Some have moved underground and over to the veggie patch, but that's beside the point. Ants don't like pennyroyal, so that's my starting point.

Certainly the essential oil used topically or the fresh leaves crushed and rubbed onto the skin will ward off mosquitoes and fleas (see section IX). Philbrick & Gregg, in their ancient & treasured Companion Plants agree. They also state that the American pennyroyal yields a commercial oil which can repel gnats & mosquitoes. Soak a dog collar in an infusion of pennyroyal or add a strong decoction into the floor washing water are well regarded folklore remedies by Adele Dawson. Richard Mabey claims pennyroyal is also good with bites of all kinds, repelling ticks as well as the above. Tierra suggests using citronella oil with pennyroyal oil for external application against mosquitoes.

Topically, it is a refrigerant, antiseptic, insect repellent, and thus good for skin eruptions, itching, formication [the sensation of small insects crawling all over the skin] & gout [presumably for its cooling property applied to the affected, <burning> joint in an acute attack]. Parenthetically, it is only the British Herbal Pharmacopoeia that includes gout in the pennyroyal portfolio.

I HISTORY OF THE NAME

from Malcolm Stuart's Encyclopedia of Herbs & Herbalism

Pennyroyal was held in very high repute for many centuries throughout Europe & was the most popular member of the mint family. Pliny is regarded as the originator of its name "pulegium" ...derived from "pulex" meaning flea...since both the fresh herb & the smoke from the burning leaves (smudging) were used to eradicate the insects. Linnaeus retained the association with fleas when he gave the plant its botanical name. Prior to that scientific classification, the unusual aroma led some to consider it a thyme.

"Puliot" was an old French name for thyme, & this plant was designated the royal thyme or "puliot royale" which was corrupted into pennyroyal. In modern French, the herb is called "la menthe Pouliot".

Herb books written in the US tend to list American Pennyroyal (*Hedeoma pulegioides*) first, and medical herbals written in the UK & Europe prefer Pennyroyal (*Mentha pulegium*). All agree the <other> pennyroyal has the same or similar properties. Where the real differences lie are in the appearance & life cycle of the two herbs.

II DESCRIPTION OF PENNYROYAL

Pennyroyal (*Mentha pulegium*) is an aromatic Perennial and is common wild or garden plant in the UK, France & Germany; found in wet grounds around the Med & in Western Asia. Mrs. Grieve says the more common, at least in the UK, is the creeping or <decumbens> pennyroyal. With weak, prostrate stems, though quadrangular -- as all mints have square stems -- it roots easily where ever the leaf nodes touch the ground. H 10-15cm or 4-6in. S indefinite. <Erecta> the upright or sub-erect has stouter stems, & obviously there's no rooting at leaf nodes. It is less common in the UK but better for cultivation according to Mrs. G.. H 20-30cm or 8-12in. S indefinite. A planting will last 4-5 years, though Mrs. G says frost may kill it, & a new planting should be made each year. Deni Brown lists pennyroyal as fully hardy [minimum -5C or 5F). Ethne Clarke's Herb Garden Design shows pennyroyal appropriate for Zones 5-9.

The leaves of Pennyroyal are generally small, ovate, slightly serrate, slightly hairy, and opposite. For the record, the leaf of the non-creeping pennyroyal can be up to 3cm or 1.5in long and may be entire rather than slightly toothed. The color depends on the variety and whether wild or cultivar. Greyish-green to light green. The IMPRESSION of the appearance of the leaves is similar to that of wild oregano (*Origanum vulgare*), marjoram (*O. majorana*, *O. onites*) & thymes...that is... tiny & crowded together on thin stems but with more rounded leaves. Not surprisingly Mrs. G described pennyroyal as <the smallest of the mints & very different in habit>.

The small flowers are produced in distinctive, dense whorls (similar to corn or fieldmint & gingermint in bloom.) The tight, axillary clusters appear in July-August with colors ranging from reddish -purple to lilac. There are few flowering stems on the prostrate form; they lie on top of what appears to be "a dense green turf". Seed is light brown, very small & oval.

To harvest: for drying, the stems should be gathered just before flowering in July. Pungently aromatic, it can be added to potpourris & insect sachets. The dried herb can also be made into infusions, liquid extract, tinctures for medicinal uses. (see section X)

III DESCRIPTION OF AMERICAN PENNYROYAL

According to Deni Brown, there are 39 species of annuals & perennials in the NAmerican genus, *Hedeoma*. They have no great merit as garden plants, but are often seen in herb gardens. Its neat habit & aromatic foliage makes it especially suitable for containers & planting near seats & entrances, or between paving stones.

American pennyroyal is an Annual, found in dry fields & open woods from the East coast to Minnesota/Nebraska. It is bushy plant with erect, square stems. H 10-40cm (4-16in) S 7-24 cm (3-10in) it bears small, opposite, thin ovate leaves sparingly toothed. Axillary clusters of small, tubular lavender or purplish flowers appear from June-October. The whole plant has a pleasant, aromatic, mint-like smell. The name *Hedeoma* comes from the Greek <hedys> for sweet and <osme> for scent. It has also been described as having an acrid taste and aroma; none-the-less it is used as the basic flavoring herb of North Carolina black pudding... hence the local name of Pudding Grass.

A culinary aside: In the north of England, Pennyroyal (*Mentha pulegium*) is also used in black pudding, and in Spain it is added to sausages.

To harvest: plants should be cut when in flower for drying. The fresh herb can be gathered and used almost as a "strewing herb" for deterring fleas.

IV THERAPEUTICS OF *MENTHA PULEGIUM*

For the basic framework, I am using the information from the *British Herbal Pharmacopoeia, 1983* supplemented by Potter's, Culpepper's Colour, David Hoffmann, Deni Brown, & Simon Mills.

Actions: Carminative, Spasmolytic = arresting or checking spasm especially of smooth muscle. [Antispasmodic means preventing or relieving.] Diaphoretic. Uterine stimulant/ Emmenagogue... principally used for delayed menses. (see section VIII)

Topically: Refrigerant. Antiseptic. Insect repellent.

Indications: Flatulent dyspepsia. Intestinal colic. The common cold. Delayed menstruation.

Topically: Cutaneous [skin] eruptions. Formication. Gout.

Specific indications: Delayed menstruation owing to chill or nervous shock.

Contraindication: Inadvisable in pregnancy. (see section VIII)

In small doses & as an infusion, pennyroyal is used for colds (as it promotes sweating), With its richly aromatic volatile oil, pennyroyal will ease indigestion, wind, nausea, colic, dyspepsia, and painful menstruation. It is considered a warming & stimulant herb by Culpepper, while Adele Dawson also suggests its use in cases of stomach spasm & hysteria. Hoffmann explains that the volatile oil will relax spasmodic pain & ease anxiety. NB: This should NOT be construed as ingesting the isolated, essential oil which could be fatal. (see section IX) The volatile oil is a constituent of the plant & will be released in the preparation of the infusion.

Pennyroyal is given to children with stomach & bowel upsets & also to ease feverish symptoms in measles & whooping cough. Taken by infusion according to Culpepper.

BHP suggested dose: for an infusion: 1- 4gm of dried herb in 1C ** boiling water; steeped for 10-15 minutes. 3 times a day.

Or 1-4ml of liquid extract (1:1 in 45% alcohol). 3 times a day.

Other herbals consulted tend to suggest smaller doses: up to 2 or 3gm dried herb; up to 2ml tincture...though Potter's range is from 0.5ml - 5ml of the liquid extract.

**NB: the general proportions for infusions are: 30gm dried herb or 75gm fresh herb to 500ml boiling water. So "one cup" is the proverbial length of a piece of string.

Pennyroyal is available on the General Sales List in the UK. [In itself, that is an indication of its considered safety.]

The BHP suggests the following combinations: for acute amenorrhea - may be combined with Chamaelirium (False Unicorn Root), Achillea millefolium (Yarrow), & Picrasma (Quassia, Quassia Wood, Jamaica Quassia); for flatulent dyspepsia - may be combined with Filipendula (Meadowsweet), Althaea Root (Marshmallow root) & Melissa (Lemon Balm); in the common cold - may be combined with Sambucus (Elderflower) & Achillea millefolium (Yarrow)

V THERAPEUTICS OF *HEDEOMA PULEGIOIDES*

The basis of this information came from Lust's *_Herb Book_*, Deni Brown's *_Encyclopedia of Herbs_*, Tierra's *Plant Herbology*, & Earl Mindell's *_Herb Bible_*

Properties & uses: carminative, diaphoretic, emmenagogue, sedative, expectorant. The Amerindian tradition shows use of pennyroyal for headaches, feverish colds, & menstrual cramps & pain. It was also used as a digestive herbal tea. It was listed in the *_US Pharmacopoeia_* (1831-1916).

It is still used internally for colds, whooping cough(the expressed juice can be made into a lozenge/sucking candy). In childbirth, the PLANT is used.

NB: the essential oil taken internally could be fatal. (see section IX). It should be used by qualified practitioners only.

Topically: as a wash for skin eruptions, rashes, and itching.

Suggested dose: 1 tsp. herb/1C water. 1-2 cups/day. Tinctures 20-60 drops at a time, as needed. For children, small, frequent doses.

VI CONSTITUENTS OF *MENTHA PULEGIUM*

(The American pennyroyal has similar constituents.) Sources: Potter's, Malcolm Stuart, Tierra, & David Hoffmann.

Volatile oil (0.5-1%) of which approx. 85% is a ketone, pulegone; also isopulegone, menthol, isomethone, limone, piperitone, neomenthol. There are also misc. bitters, tannins, & flavone

glycosides.

Pulegone is described as a toxic compound, "notorious for causing abortions". It is present in both *Mentha pulegium* & *Hedeoma pulegioides*.

VII ADDITIONAL MEDICAL INTERPRETATIONS

Tierra in *_Planetary Herbology_* collectively describes *Hedeoma pulegioides* & *Mentha pulegium* ...in much the same way as mentioned above. He does add the following: The Energetics are spicy, bitter, warm . The Meridians/organs affected are liver & lungs.

In David Bellamy's & Andrea Pfister's *_World Medicine_* they have a large section called The Families of Healing Plants. *Mentha pulegium* is listed with two sources of information: The 1907 British Pharmaceutical Codex and Book I of Avicenna's *_Canon_*. The BPC states that Oil of Pennyroyal (Ol. Pulegii) is given as an emmenagogue. During excretion, it mildly irritates the kidneys & bladder, and reflexly excites uterine contractions. Avicenna lists the herb as Mint (Podina in Urdu). The leaves are the part used. The herb's Temperament is described as Hot & Dry in the 2nd Degree.

VIII HOW DEADLY IS DEADLY...AND WHICH PENNYROYAL ARE WE TALKING ABOUT?

Simon Mills in *_Out of the Earth_* issued the strongest warning that I found in my trawl of herbals. There are a number of herbs which should be avoided altogether because they can damage the fetus or provoke a miscarriage. In many popular herb books the term emmenagogue is found, widely but erroneously, having come to refer to a gynecological remedy. In fact, the effect of an emmenagogue is to bring on a delayed menstruation: it takes little imagination to realize that the most common reason for a delayed menstruation is pregnancy and that emmenagogues are thus abortifacients. Pennyroyal (*Mentha pulegium*) is among 21 herbs Simon Mills lists. This information was part of a short section of herbs in pregnancy..those quite safe, and those not so.

In his first book, *_The Dictionary of Modern Herbalism_* written 6 years earlier, Mills quite carefully does NOT list emmenagogue among the actions. He does include uterine stimulant with this caution: <pennyroyal should not be used in pregnancy or when any delayed menstruation might denote pregnancy; it is as likely to damage the fetus as procure the abortion.>

The second most complete, cautionary listing was found in Earl Mindell's *_Herb Bible_*. He is talking about American pennyroyal (*Hedeoma pulegioides*).

<Back in the days when abortion was illegal, this herb was used to induce abortion. In some cases, it resulted in hemorrhaging & serious complication for the mother. Therefore, it should never be used for this purpose. Today, pennyroyal is one of the herbs used by herbalists to facilitate labor & delivery. It should be used only under the supervision of a knowledgeable practitioner. If you do use this herb, do not exceed the recommended dose & do not take for more than a week at a time.>

Richard Mabey in *_The Complete New Herbal_* warns <...the oil taken internally can be highly toxic and there are a number of cases of the deaths of women who tried to procure abortions by

taking the oil.>

Tierra in Planetary Herbology goes further in his explanation. <To take the oil internally to terminate an unwanted pregnancy is very dangerous, and in a few cases has resulted in death. All essential oils are life-threatening if taken internally. There is a possibility of fetal damage from the use of pennyroyal (*Hedeoma pulegioides* or *Mentha pulegium*) to induce abortion, but this may be true only of the undiluted oil and not the infusion.>

Malcolm Stuart raises an important, tangential danger. <Although long considered an abortifacient, it has been found that this effect is usually only possible with a dose of the oil which is highly toxic and leads to irreversible kidney damage.>

He then goes on to state:

<The plant oil can therefore be used as a flavoring agent, but only when the concentration of pulegone does not exceed 20mg parts per 1kg of the final product being flavored.>

IX PS ON PESTS

And just to round things out, he adds that the plant may cause contact dermatitis which is certainly worth noting before rubbing crushed, fresh leaves on your skin to avoid mosquito bites. He adds that the pennyroyal leaves are also good for insect bites after-the-fact. They act as a rubefacient...that is drawing more blood to the area which improves its cleansing action on the affected tissue.

X ODDS AND SODS

While some herbalists maintain that a fresh herb/plant is medically more efficacious, I have not seen any preferences specified for either Pennyroyal or American Pennyroyal. Most herbals referred to the dried herb...so by omission one can assume dried is the preferred state. Why? I don't know.

Forms of internal dosage:

The British Herbal Pharmacopoeia, Mrs. Grieve, & Potter's call for a liquid extract to be taken. Hoffmann & de Bairacli Levy use infusions. Lust calls for a tincture to be used.

As a reminder, the differences are:

Tincture: solution of substances (both active & inactive therapeutically) extracted from medicinal plants by the maceration or percolation of the plant with alcohol or alcohol-water solutions.

Liquid extract: product obtained by treating plant material with a solvent or mixture of solvents designed to extract the desired constituents.

Infusion: made by pouring a given volume of boiling or just boiled water over a given quantity weight of herb and letting it steep/infuse for a given time.

Always cover to keep the volatile oils in the infusion...otherwise they'll escape...evaporating into the air.

[Home](#) - [Herb FAQs](#) - [Articles](#) - [Classic texts](#) - [Archives](#) - [Links I like](#) - [Pictures](#) - [Plant names](#)





[Home](#) > [Herb FAQs](#) > [Medicinal herb FAQ](#) > [Single herbs](#) >

[Medicinal herb FAQ: Intro](#) - [Single herbs](#) - [Herbs for specific things](#) - [Processing herbs](#) - [General info](#) - [Information sources](#) - [Schools](#) - [Related forums](#)

The Medicinal HerbFAQ

2.17 Cat's Claw

From Kris Gammon <ancientone.gnn.com>

Latin name: *Uncaria tomentosa*. Peruvian name: una de gato.

Cat's Claw is a thick, long, slow growing woody vine that grows between 400 and 800 meters above sea level in the Amazon jungle. This vine gets its name from the small, sharp thorns, two at the base of each pair of leaves, which looks like a cat's claw. These claws enable the vine to attach itself around trees climbing to a height of 100 feet or higher.

In 1959, Nicole Maxwell made a journey to the Rio Putumayo. She painstakingly began her collection of specimens and data of medicinal plants in the Amazon. This was her first long jungle trip although she had made previous excursions. Her findings are well written in "Witch-Doctor's Apprentice: Hunting for Medicinal Plants in the Amazon". She describes a number of plants and their applications, among which is una de gato.

Research began on Cat's Claw in the early 1970's. Mr. Klaus Keplinger filed the first patent in the US on *Uncaria tomentosa* in 1989 when the plant's alkaloids were isolated and tested. There are mainly six oxindole alkaloids most prevalent in the Cat's Claw bark, known as: isopteropodine, pteropodine, mitraphylline, isomitraphylline, ryncophylline, and isorynchophylline. Three of these have been proven to be effective immuno-stimulants. Ryncophylline has been shown in laboratory testing to display an ability to inhibit platelet aggregation and thrombosis. This means this alkaloid may be useful in the prevention of stroke and reducing the risk of heart attack by lowering blood pressure, increasing circulation, and inhibiting both the formation of plaque on the arterial walls and formation of blood clots in the vessels of the brain, heart and arteries.

As well as these alkaloids, Peruvian and Italian researchers have discovered other beneficial phytochemicals inherent in the plant, including proanthocyanidins, polyphenols, triterpines, and the plant sterols: beta-sitosterol, stigmasterol and campesterol. These might explain the antioxidant, anti-microbial, anti-tumor and anti-inflammatory properties attributed to this plant.

In 1991 there was a new study to isolate the chemical compounds found naturally within the plant that would be responsible for anti-inflammatory principles. This led to "the isolation and characterization of a new quinovic acid glycoside called glycoside 7 as one of the most active anti-inflammatory principles to be uncovered."

Many species of the genus *Uncaria* exist in nature...more than 30. It is the *U. tomentosa* species that offers the most promise as a therapeutic agent. *Uncaria guianensis* is frequently confused with *Uncaria tomentosa*. Consumers should check the Cat's Claw bottles they buy for "*Uncaria tomentosa*" and choose from a reputable company. Cat's Claw is available in capsules, extract and the raw bark for brewing tea.

Cat's Claw is used for: Crohn's disease, diverticulitis, leaky bowel syndrome, colitis, hemorrhoids, fistulas, gastritis, ulcers, parasites, intestinal flora imbalance, cancer, arthritis, diabetes, chronic fatigue syndrome, environmental toxic poisoning, organic depression and those infected with the HIV virus.

Most of the clinical research which show these alkaloids to be antiviral, anti-inflammatory, immunostimulating, antimutagenic, antioxidant, etc., are tests done "in-vitro" (proven in the test tube) not "in-vivo" (proven in the human body).

Cat's Claw root should never be used as the medicinal qualities are most prevalent in the inner bark and harvesting the root kills the plant. Consumers should refuse to buy any Cat's Claw root products in order to ensure the plant is not destroyed. Peruvian law is now in place to help protect *Uncaria tomentosa*.

[Home](#) - [Herb FAQs](#) - [Articles](#) - [Classic texts](#) - [Archives](#) - [Links I like](#) - [Pictures](#) - [Plant names](#)





Henriette's Herbal Homepage

[Home](#) > [Herb FAQs](#) > [Medicinal herb FAQ](#) > [Single herbs](#) >

[Medicinal herb FAQ: Intro](#) - [Single herbs](#) - [Herbs for specific things](#) - [Processing herbs](#) - [General info](#) - [Information sources](#) - [Schools](#) - [Related forums](#)

The Medicinal HerbFAQ

2.18 Golden Seal appeal - and Goldthread too

Please use alternatives to Goldenseal (*Hydrastis canadensis*) whenever possible. If you have to use Goldenseal please grow your own.

Here's why: <http://www.ibiblio.org/herbmed/archives/Best/1996/goldenseal.html>

- There were some quality articles on goldenseal in *Medical Herbalism*, Vol.8, Nr. 4, online at: <http://www.medherb.com/84.HTM>
-

[Home](#) - [Herb FAQs](#) - [Articles](#) - [Classic texts](#) - [Archives](#) - [Links I like](#) - [Pictures](#) - [Plant names](#)



Henriette's Herbal Homepage



[Home](#) > [Herb FAQs](#) > [Medicinal herb FAQ](#) > [Single herbs](#) >

[Medicinal herb FAQ: Intro](#) - [Single herbs](#) - [Herbs for specific things](#) - [Processing herbs](#) - [General info](#) - [Information sources](#) - [Schools](#) - [Related forums](#)

The Medicinal HerbFAQ

2.19 Ma Huang or Ephedra sinica



From T. R. Hastrup:

Ephedra contains ephedrine which is a drug very similar to adrenaline but with a longer half-life. It acts on exactly the same receptors as adrenaline does and has exactly the same side effects and dangers. It does not induce hallucinations and its stimulative effect is not very far from caffeine. Even when taken in extreme doses with constant use, it is questionable if ephedrine can cause a psychosis. It has nowhere the power to push the body to the limits. I know some people out there love to spread scare but ephedrine is a very safe and natural drug. The only dangers from ephedrine is because it can cause high blood pressure and vaso-constriction, exactly like adrenaline. People with high blood pressure or heart problems should naturally be careful with this herb.

Also, ephedrine is chemically related to the amphetamines but everybody should know that similarity in molecular structures does not mean the action of the drugs are similar. Ephedrine acts purely on adrenergic receptors, unlike the amphetamines which have powerful CNS stimulative effects.

From Henriette:

The problem with *Ephedra sinica* (and other Eurasian species of Ephedra - there is no ephedrine to speak of in the American species) is that we as a culture are -used- to 4- or 5-hour drugs. Take coffee, or aspirin, and it'll be out of your system in 4-5 hours. Ephedrine will let you stay jittery for 8 hours - but because you're used to dosing yourself every 3-4 hours you overdose -very- easily on

ephedrine. Especially if you abuse the plant (ie. you use it to keep awake), or worse, mix it with things like caffeine and aspirin to -really- get that weight down.

That way lays your first (and perhaps last) heart attack, a -lot- of jittery nervous overstrung adrenergic problems, and that way lays madness.

Chinese Ephedra (Ma Huang) is not -used- by the great unwashed masses in the US, it's -abused-. That's a big difference, even if it only looks like two letters.

As an herb Ma Huang has its uses in TCM, and in western herbalism it's used in small discrete doses for things like bronchial spasms. NOT long-term, nor for frivolous things like "but I have to keep awake". Herbalists try to keep you -in- balance, not get you -out- of balance. If you value your health you should do the same.

On Ma Huang and drug tests:

From "Michael M. Zanoni" <zanoni.netcom.com>:

Ma Huang (the Chinese variety *Ephedra sinensis*, not the American *Ephedra* plant) can produce a positive urine test for amphetamine metabolites that will also be read by the mass spec as being meth metabolites. It is because of the combination of both l- and d- forms of ephedrine. Things such as *Ephedra nevadensis* have only the non-psychoactive form of ephedra.

If someone were to take a moderate amount of Ma Huang for a few days it is possible that the serum titer could go high enough to be beyond the threshold level of detection used by most labs for gas chromatograph screening.

Pseudophedrine found in OTC drugs will not test as a meth metabolite.

[Home](#) - [Herb FAQs](#) - [Articles](#) - [Classic texts](#) - [Archives](#) - [Links I like](#) - [Pictures](#) - [Plant names](#)





[Home](#) > [Herb FAQs](#) > [Medicinal herb FAQ](#) > [Single herbs](#) >

[Medicinal herb FAQ: Intro](#) - [Single herbs](#) - [Herbs for specific things](#) - [Processing herbs](#) - [General info](#) - [Information sources](#) - [Schools](#) - [Related forums](#)

The Medicinal HerbFAQ

2.20 Skullcap and *Teucrium* adulteration



The question, on the herbinfo -list in July 1998:

>I remember reading somewhere about the possibility of liver toxicity from pyrrolizidine alkaloids or adulteration of skullcap. A web search didn't turn up anything useful. (Would you believe you can type "skullcap" and "liver" into a search engine and bring up x-rated sites?)

I found plenty of information about comfrey and PAs but that's not really what I needed.

My reply (thanks for all those tidbits, Uncle Mike):

Scutellaria, aka Skullcap is not dangerous.

However, it has been adulterated with Germander (*Teucrium* sp.) for decades, if not centuries; though that matters a great deal qualitywise it has no implications on toxicity as long as only the 'mercans did it, as the 'mercan species of *Teucrium* do not contain toxic pyrrolizidine alkaloids.

Again HOWEVER, then the Europeans thought "Hmmm, that's a great idea, money for nothing, chicks for free", (sorry, got carried away). So they imported *Scutellaria* from America and added their local -European- *Teucrium* species to it. Then they re-exported the mix to the folks on the other side of the pond... there is a very big problem with quality here, AND in this case there is a problem with toxicity. The European species of *Teucrium* do contain toxic pyrrolizidine alkaloids. So it's not good for your liver to buy your skullcap from sources you do not trust, like the -really-large herbal houses; THEY ALL DO IT.

To get them to stop it you'll have to ask your suppliers where they got their skullcap from. If they bought it, ask them where from; ask them to ask -their- supplier(s) where from... if it's one of the big houses ask them to PROVE that there is no *Teucrium* in that there *Scutellaria*.

Perhaps, if enough of us do this, we'll have unadulterated *Scutellaria* in another couple of decades.





[Home](#) > [Herb FAQs](#) > [Medicinal herb FAQ](#) > [Single herbs](#) >

[Medicinal herb FAQ: Intro](#) - [Single herbs](#) - [Herbs for specific things](#) - [Processing herbs](#) - [General info](#) - [Information sources](#) - [Schools](#) - [Related forums](#)

The Medicinal HerbFAQ

2.21 Mellow mallows



Malva sylvestris

By Miriam Kresh, Tsfat, Israel

Some weeds grow just anywhere, pervasive green presences of which you don't take much notice as you hike along. The common mallow is one, and I welcome it whenever I see it, for it is a friendly and useful plant. From it's roots to it's edible seed pods, mallow's nutritious and medicinal properties have been known since Pharaonic times, and probably before.

Here in Israel, mallow starts putting forth tiny, heart-shaped leaves everywhere at the beginning of the winter rains in October. By December the leaves are shapely and large, looking something like the geranium; in some parts of the country they grow as big as soup plates. Throughout the winter and spring, the stands will grow up to four feet high, given the right conditions of moisture. In the meadows, on the roadsides, in any vacant lot, competing with cultivated vegetables in the fields, invading your garden - there seems to be no end to that green Nosey Parker. And pollution seems to bother it not at all: sometimes the most beautiful stands will be seen flourishing next to a crowded parking lot.

The roots of mallow are rich in beneficial mucilage. Boiled, they make a drink which is diuretic and soothing to the urinary tract at the same time. This is good wherever there is painful urination. A painful chest, as in bronchitis or flu, can obtain relief from this drink too.

The leaves, dark-green and coarse, are a powerhouse of minerals and vitamins (calcium, iron, vitamin C, copper traces and more) and an abundant, free source of organic nutrition. They also release soothing mucilage. I decoct mallow leaves for my cough or iron tonic syrups, slice it into

soup for a cold or flu patient, add them to the infusion for moisturizers.

As a poultice, mallow leaves will draw out boils and pus from old infections. Put a few large leaves in your blender with some mineral water, and apply the green, goopy mask to your teenager's acne for cleansing and healing. If he or she objects, add a drop of essential oil of lavender to make it smell good. Allow it to dry, then rinse off. The skin will look brighter and feel silky.

Rashes and burns can be successfully treated with mallow leaves, crushed or blended. When gathering nettles, I look for a nice big mallow leaf to wrap around the hairy, stinging stalks so I can cut them easily. If I do get stung, a poultice of crushed mallow will take away the irritation quickly.

During the siege of Jerusalem during the War of Independence in 1948, food supplies to the city were cut off and near-famine conditions prevailed in the city. Mallow was an important source of nutrition to the imprisoned population then: the leaves were gathered, chopped fine and fried as patties or eaten raw. The seed pods were collected to eat raw or cooked. (They're not bad raw; I often stop to nibble a few. This I learned from the children, who call them "arab bread", and forage for them all the spring.) Folks who lived in Jerusalem then will serve mallow patties, or stuff the leaves like cabbage rolls on Israeli Independence Day, to commemorate that time.

The pink or purplish, flowers can (and should) be added to any formula for cystitis, coughs, and inflammation in the digestive tract. Again, the abundant mucilage, easily released from the flowers, benefits all irritable, painful conditions in these areas.

Mallow has only a neutral, greenish taste, so you can add it to almost any dish at all. Following are some ideas for using mallow to boost the nutritional content of your family fare; you'll get the idea as you read along.

- Wash your mallow carefully, and check for bugs, as you would any other edible leaf. Don't be put off by a few holes: birds peck at mallow, so the holes don't mean that the leaf is infested. Little yellow bumps imbedded in the underside do, however.
- Add whole small leaves to your salad greens: make sure the dressing is a little stronger-tasting than usual, since the taste of raw mallow is sort of uninteresting.
- Almost any soup you cook will accept a handful of chopped leaves, added the last 15 minutes of cooking. Allow the soup to sit a further 10 minutes before serving, to allow the beneficial mucilage (or goop) to be extracted out of the leaves.
- Further tip: soup made for invalids, i.e., cold or flu sufferers, or someone needing a Strengthening Tonic as for after surgery, a bout of illness, etc., can be enriched with the scrubbed, chopped roots of mallow, as well as the leaves. The roots are especially rich in minerals and mucilage, and so especially benefit a patient with a cough.
- Saute your chopped mallow leaves; add to an omelet.
- Stuff and roll the leaves as you would cabbage leaves.
- Stir-fry mallow chopped into ribbons as part of your vegetable stir-fry medley.

Mallow Soup (serves 6 - 8)

- 1 large onion
- 1 large tomato
- 2 bell peppers, preferable of different colors
- ½ bunch of celery
- 4 carrots
- 3 large potatoes
- 3 garlic cloves
- olive oil to cover the bottom of your soup kettle
- 6 cups of water, enriched with 2 Tblsp. of good-quality soy sauce or the same quantity of chicken broth
- 2 tsp. salt plus black pepper to taste.
- 2 large handfuls of clean mallow leaves and/or roots

1. Dice the onion; chop tomato, peppers, celery, carrots and potatoes.
2. Sauté the onions, adding the other vegetables as the onions start to wilt
3. Chop the garlic finely; add to the sautéed vegetables when they are looking golden and start smelling cooked.
4. Add water and seasonings; simmer for 15-20 minutes. A nice touch at this point is to blend the cooked vegetables, with some of the soup, and return the blended mass to the pot. Children especially appreciate blended soups.
5. Chop the Mallow into narrow ribbons: if using roots, slice finely. Add to the pot and cook a further 10 minutes.

Serve with croutons, or chopped parsley, or simply on its own.

Henriette's comments:

You can use most any Malvaceae in the same way as you can use *Malva sylvestris*. So you've got *Althaea* sp., *Alcea* sp., *Malva* sp., *Lavatera* sp., *Hibiscus* sp., *Sphaeralcea* sp., *Sidalcea* sp. etc. etc. growing in your garden or in that nearby wild spot? Pick the leaves and (where applicable) roots, and use them. Some species (for instance, most species in the genus *Sphaeralcea*) have itchy hairs, so don't use the leaves of these as wild food, and use a coffee filter before you ingest teas made from them. Other species (like *Hibiscus sabdariffa*) have a very sour tang to the flowers, so don't use them in quite as large quantities. But they all contain loads of mucilage in all parts, and they all help your mucous membranes.

[Home](#) - [Herb FAQs](#) - [Articles](#) - [Classic texts](#) - [Archives](#) - [Links I like](#) - [Pictures](#) - [Plant names](#)





[Home](#) > [Herb FAQs](#) > [Medicinal herb FAQ](#) > [Single herbs](#) >

[Medicinal herb FAQ: Intro](#) - [Single herbs](#) - [Herbs for specific things](#) - [Processing herbs](#) - [General info](#) - [Information sources](#) - [Schools](#) - [Related forums](#)

The Medicinal HerbFAQ

2.22 Melatonin

from Paul Bergner (bergner.concentric.net), Editor, Medical Herbalism (<http://medherb.com>):

I'm not surprised that melatonin is gone in Canada, and I predict that it will go the way of DHEA here in the U.S. -- meaning that it will be a prescription-only controlled item, treated like opiates.

I've just researched and written a lengthy article about melatonin, and frankly I am shocked that natural healers would use this substance casually like a sleeping pill. Melatonin is a powerful hormone that affects the entire metabolic cycle, not just the sleep- wake cycle. We rail against hormone-replacement therapy with estrogen- progesterone, and then casually offer patients enough melatonin to raise blood levels 10-20 times their normal levels. This is bound to be a Devil's bargain, and it is only a matter of time till regulatory agencies throughout the world discover this and rightfully take measures to protect the public.

For instance: melatonin production by the pineal gland appears to be an important part of the aging clock. The pineal glands of young mice, transplanted to old mice, make the old mice "younger" and they live about 1/3 longer. On the other hand, the pineal glands of older mice, transplanted into younger mice, immediately makes them "older" and they live about 1/3 shorter lives.

So what happens when some guy named Joe in Iowa takes ten mg of melatonin (about twenty times what you need to achieve normal blood level peaks) to sleep most nights for three years (this is actually happening all over the place today) and then can't get the melatonin? Will his pineal have lost its ability to produce the same levels as previously? Most hormones have a negative feedback loop of one sort or another -- would levels that high reduce endogenous production over time? Will poor Joe then age ten years over the next few months?

I think melatonin has a proper place in natural medicine, in the treatment or palliation of cancer, used for brief periods for jet lag, and possible for the elderly, and may be a few more uses. But IMO over-the-counter status is inviting health disaster.

[Home](#) - [Herb FAQs](#) - [Articles](#) - [Classic texts](#) - [Archives](#) - [Links I like](#) - [Pictures](#) - [Plant names](#)





[Home](#) > [Herb FAQs](#) > [Medicinal herb FAQ](#) > [Herbs for specific things](#) >

[Medicinal herb FAQ: Intro](#) - [Single herbs](#) - [Herbs for specific things](#) - [Processing herbs](#) - [General info](#) - [Information sources](#) - [Schools](#) - [Related forums](#)

The Medicinal HerbFAQ

3.1 Herbs for mosquitoes and other bothersome bugs

[repelling](#) - [bites](#)

Actually this isn't medicinal - if you don't count doing something for the bites. But it's asked every year come bug time, so I'm including it anyway.

3.1.1 Repelling them

>I'd heard rumors of vitamins and herbs that naturally repel insects, though I'm not sure which ones.. any help is greatly appreciated

From Aine Maclir (amaclir.unibase.unibase.com):

There are a couple of things that I know of.

1. Wear Citronella essential oil (which isn't the greatest smelling stuff around, but I guess it beats Off).
2. Take the equivalent of 1500 mg of fresh garlic clove (a 15 mg capsule of garlic powder or 3 x 5 mg capsules) orally every day. Taking garlic will cause your skin to secrete a natural insect repellent.

For best results, do both. Don't wear perfumes or scented deodorants and wear light-coloured clothing as darker colours attract bugs...this is particularly true of blue denim jeans. To make sleeping more comfortable, burn either an insect coil or a couple of sticks of citronella incense in your cabin before going to bed, making sure that all the doors and unscreened windows are closed, so no more of them get in.

If you do get bitten, applying a small dab of ammonia to the bite immediately after being bitten can help ease the itching. And there's always the old favorite...calamine lotion...if you're not going to be anywhere that being coated in pink polka dots will be unfashionable (g). Aloe vera and witch hazel will also soothe insect bites.

If you are going to be in an area that's also known for tics, just be on the lookout for them whenever you've been in a wooded area and if you find one stuck to you, use rubbing alcohol to make it let go and carefully remove it with a pair of tweezers. Salt applied to a leech will get rid of it (in case you're around water that has any of those "suckers" (g)).

I think that should about cover every blood-thirsty creature you're likely to run into at a summer camp, recalling my own experiences. I've been on canoe trips through Algonquin Park, Ontario (known for having some of the biggest and thirstiest mosquitos, blackflies and leeches in Canada) and I live in Saskatchewan, where we could make mosquitos our provincial bird!

From "Peter & Janine" pjerlandsen.cox.net:

> 1. [Wear Citronella essential oil \(which isn't the greatest smelling](#)

I would not wear Citronella when out camping where there is bears. They have found that the female black bear love the smell of Citronella. It does not attract the male bear.

From sfrye.interaccess.com (amethyst):

I've had good results taking B-complex supplements daily. Seems the bugs like the odor of B-1 about as much as I like the taste of it. ;P

From starla lacy (lacys.cadvision.com):

Here in Canada, we struggle with flies the size of horses! This essential oil mix has always worked great for me:

3 parts lemongrass (or citronella)

1 part thyme

2 parts lavender

1 part peppermint (or eucalyptus)

Mix together in a new plant sprayer (you may dilute with springwater if desired). This mix also has the advantage of smelling pleasant and is safe for use around kids and pets.

Shake the mixture well before using if you decide to dilute it with water.

From Henriette to above:

Remember to dilute essential oils in carrier oils (like almond, jojoba, olive ...). As a general rule you should not ingest essential oils.

From Mateo Rutherford (mcrutherford.lbl.gov):

I have used tobacco tea to kill lice and gnats. It is easy to prepare. Buy a cigar or some rolling tobacco and boil the hell out of it in a liter or so of water. When cool shlop it on your hair and cover your hair with a plastic shower cap or something like that for 20 minutes then shampoo. One application should be enough, but I would often do a follow up about three or four days after the first application.

From fukada.uhunix.uhcc.hawaii.edu (Mach T. Fukada)

However, keep in mind that nicotine that is extracted from the tobacco is also toxic to humans (people don't get too much of it when the smoke it because it burns up). It should be used with care if there are cuts on the scalp which may increase the rate that it is absorbed into the bloodstream

> I was wondering if there are any herbals that can be taken to reduce the attack of mosquitos. I happen to live in an area where they are abundant.

From amy.winans.psl-online.com (Amy Winans) to above:

I do well know what you mean! Here's what I've gathered on that subject, and keep (all) on hand as needed:

1. You can join the rest of America and buy a caseload of Avon's Skin So Soft. I have about a dozen friends who worship it religiously.
2. You can stock up on anything containing Citronella, although I fear it may still be too new to really know if there is Life for it after the Candles. I'm seeing a lot of oils and lotions saying it's in there, though.
3. Continue to use the old standby's with DEET in them, like Off's Offtastic, or whatever, or Cutter's. Have heard personal testimonials on Cutter's.
4. Investigate local ancient customs; as I discovered when I read the area's native Indians, the Karankawas, employed an effective remedy to a problem which was (unbelievably) much more horrid than it presently is; that is, they killed them an alligator, skinned him, liquified the fat and slathered it on! Kept quite a few things away, one of which WAS mosquitos!

Seriously, though, there is probably something in that we could replicate today with something similar but more sweet-smelling. So, if anyone has any ideas, as well as things to ingest that might make your "scent" less attractive to mosquitos, please post!

3.1.2 And now you're bitten...

From EderChiro.aol.com:

Use lavender oil (small drop) applied directly on mosquito bites.

From Henriette:

Lush Stellaria media does the trick, too - just roll into a ball and let the juice drop onto your bite(s).

From Noel Gilmore (ngilmore.gate.net):

Allow me to pass on my husband's rather simplistic (and annoying) remedy to keep mosquito bites from itching and swelling...DON'T SCRATCH 'EM. For years I suffered all summer while he did not and he would always tell me it was because he disciplined himself not to scratch. Last year we went to the Yucatan jungle for vacation and I couldn't bear to cover myself from head to toe each day with repellent, so I asked him to help me remember not to scratch, and I have to admit it worked!

From Tim Keenan (tkeenan.uoguelph.ca) to above:

As someone who has lived and worked on the arctic tundra and in the boreal forest for decades, I have to agree...I never use DEET or any other repellent. If the bugs are so thick I can't breath

without inhaling them, I use a "SkeeterGuard" fine-mesh net jacket, with a net hood that zips across the throat. Otherwise, I hit 'em if I feel 'em. If I don't feel 'em, I hardly ever develop any reaction. If I have a reaction, usually if I get bit somewhere where the skin is thin (over a wrist bone, etc.) I generally ignore it and it goes away. I never get a bump _unless_ I scratch. This goes for black flies, too. I think the best answer is to get bit early and often, and you will become acclimatized to it. Rubbing and scratching causes all sorts of local histamine response, which really aggravates the situation.

From Lane.monty.rand.org (Janis Lane) to above:

I have been getting TERRIBLE spider bites. The doctor told me that I was having a chemical reaction (arm was burning hot and swollen). He told me the SAME thing..."do NOT scratch". I stopped scratching and it seems that the bites are not swelling but are just turning to bruises. Any suggestions for THIS?

From Sharon Rust (ntlor.primenet.com) to above:

For spider bites I have used fresh papaya and when I haven't had the fresh stuff papaya - pineapple enzymes, these work for bee and wasp and scorpion stings as well. I chew up the enzyme tablet to make a paste and stick it on the bite , the papaya I just stick a chunk on . When I use to live where plantain (*Plantago rotundifolia*, or *lanceolata*) grew I used it for bites, it seemed to work on bee, spider and mosquito bites. To use plantain I would get a fresh leaf and chew it up with my front teeth, taking care not to swallow the juices and then stick this wad of chewed up plant on the bite(s). When my daughter and niece stepped into a swarm of yellow jackets luckily it was in a field filled with plantain, I started chewing up and applying the plantain to my daughter and my sister-in-law did the same for her daughter, the bites on my daughter were disappearing but my niece was getting no relief, so when I was finished with my daughter's bites, I started applying plantain to my nieces, the ones that I worked on were also disappearing , the key was that my sister-in-law was swallowing the juices released from the plant and I was not. I suppose you could use a blender or something but most of the time I feel that this is the fastest and simplest way to treat a bite.

[Home](#) - [Herb FAQs](#) - [Articles](#) - [Classic texts](#) - [Archives](#) - [Links I like](#) - [Pictures](#) - [Plant names](#)





[Home](#) > [Herb FAQs](#) > [Medicinal herb FAQ](#) > [Herbs for specific things](#) >

[Medicinal herb FAQ: Intro](#) - [Single herbs](#) - [Herbs for specific things](#) - [Processing herbs](#) - [General info](#) - [Information sources](#) - [Schools](#) - [Related forums](#)

The Medicinal HerbFAQ

3.2 Herbs for migraines

by Eugenia Provence, Eprovence.aol.com

What are migraines? A whole variety of headaches associated with vascular constriction and dilation make up the unpleasant world of migraines. The two most common are classic migraine and common migraine. They may first appear in childhood, but usually in the late teens or early twenties. More women than men are subject to them, and they frequently end after menopause.

Classic migraines start with warning signs (called the aura by medical folks). Before the headache begins, you may temporarily lose some of your vision, see flashing lights and feel very strange altogether, maybe even feeling a burning sensation or muscle weakness.

The pain usually begins on one side of the head, but can spread. The headache may take hours to develop and several days before it goes, leaving a desire to sleep (replacing the desire to die!). You may experience nausea and sensitivity to light and noise.

I've had only one of this kind and never want another. I thought I was losing my vision (along with my wits and my lunch). Other symptoms may include muscle numbness, tingling, scalp tenderness, dizziness, dry mouth, tremors, sweating and chilliness.

Common migraines don't begin so dramatically, but a few hours or days before onset, you may feel tired, depressed (or paradoxically) have a burst of energy, be anxious or feel hyper. The common migraine may begin more slowly and last longer than the classic type. Except for the aura, the symptoms are the same.

What causes migraines? The exact range of mechanisms producing migraines isn't well understood, but is believed to be an upset in serotonin metabolism that causes dilation of cerebral arteries, followed by vascular spasm in extra-cranial blood vessels.

Migraine triggers are as varied as the individuals afflicted by them. About 70% of sufferers have family histories of migraine.

Food triggers are common, and can be nearly anything. Some of the most frequent food triggers are anything aged, canned, cured, pickled or processed or that contain tyramine or nitrites. Aged cheese, bananas, caffeine, chicken livers, MSG, alcohol (especially red wine,) yeast products (including bread), chocolate, red meat, shellfish are common, but the list is extensive and

individual. Try eliminating these first. If that doesn't work, see if you are sensitive to citrus, lentils, nuts, any kind of green beans or peas, vinegar or yogurt.

Stress, strong emotional reactions and fatigue may be triggers, in addition to compounding the symptoms. Weather or altitude changes may contribute to them. There's a hormonal trigger for some women, causing migraines prior to or during menstruation or when using birth control pills or estrogen replacement therapy. There seems to be an association with sluggish liver function from eating too much fatty food or heavy drinking.

How can they be prevented or treated? If you can categorize your migraines as being related to physical stress or emotional upheaval, stress reduction techniques, meditation and biofeedback have been found to be helpful, as have acupuncture and bodywork. Chiropractic or Osteopathic treatment may help if there is a structural problem in the neck. Again, it's very individual and complex issue, and you may need the assistance of a professional conventional or complementary practitioner.

HERBAL THERAPIES:

- To ease pain, David Hoffmann suggests that at the first sign of attack equal parts of Black Willow, Meadowsweet, Passion Flower, Valerian and Wood Betony may be helpful.
- For migraine associated with stress, use equal parts of Hawthorne berries, Lime Flowers, Wood Betony, Skullcap and Crampbark.
- Nervine tonics, such as Oats and Skullcap are appropriate long-term therapy, accompanied by Siberian Ginseng as an adaptogen.
- Massage Lavender oil into the temples at first sign of an attack.
- If the migraine is accompanied by nausea or vomiting, Chamomile, Meadowsweet or Peppermint may help.
- If migraine is associated with hormonal problems, long-term treatment should include herbs to try to balance the hormonal system. Vitex, Black Cohosh, or Wild Yam may be useful.
- European herbalists emphasize the importance of liver support in migraine treatment. Herbs like Burdock, Dandelion root or Milk Thistle would be ideal.

The following delicious Migraine Tea from Ana Nez Heatherly of Gatesville, Texas, appears in the July 1995 Mother Earth News. She prepares a cold infusion of:

6 parts Rosemary leaves 4 parts Peppermint leaves
4 parts Lemon Balm leaves 4 parts Sweet Violet
3 parts Feverfew 1/2 part sweet Violet Flowers

Please also check the entry [2.9, Feverfew and migraine](#); and then you could search the net for the Natural Migraine Treatment FAQ by Catherine Woodgold <an588.freenet.carleton.ca> - archive name: medicine/migraine/natural-cures.

[Home](#) - [Herb FAQs](#) - [Articles](#) - [Classic texts](#) - [Archives](#) - [Links I like](#) - [Pictures](#) - [Plant names](#)





[Home](#) > [Herb FAQs](#) > [Medicinal herb FAQ](#) > [Herbs for specific things](#) >

[Medicinal herb FAQ: Intro](#) - [Single herbs](#) - [Herbs for specific things](#) - [Processing herbs](#) - [General info](#) - [Information sources](#) - [Schools](#) - [Related forums](#)

The Medicinal HerbFAQ

3.3 Herbs for vivid dreams



From Colette Gardiner, on mugwort (*Artemisia vulgaris*) as a dream enhancer:

There's quite a bit of info out there about this topic, probably recently discussed on this list as well. I've used it to induce more vivid dreaming for years and have seen strong effects in many people. Some people have been known to wake up in the night cursing loudly and toss the pillow across the room, they were dreaming so vividly. A bundle of it hanging near your head at night works as well as a pillow of the cut and sifted stuff available in stores. It's also useful as an incense or in incense blends before any divinatory work such as tarot, rune reading etc. Just take a small amount of the dried herb and toss it on top of a wood stove or on a small charcoal disc that's been lit (available in magic stores or sometimes in catholic supply stores). Mostly I'd recommend simply getting some and trying it out for yourself. I've heard a lot of stories over the years from students who've used it.

Other herbs for vivid dreams:

Plantain- *Plantago majus* or *P. lanceolata* - tea in evening.

Watercress - Ingested at daybreak to increase dreams that evening.

Peppermint - *Mentha* spp. burned as an incense at sunset and thru the evening for visionary dreams.

From Dennis McClain-Furmanski (dynasor.infi.net):

Calea zacatechichi (Dream Herb) is a shrub from the Chiapas region of Mexico, related to the mint family. It has been used by the Chontal people as a divinatory for many years. Traditional use as a

tea brings about a drowsy dream state, in which answers to questions are revealed and lost objects are located.

Clinical testing in double blind studies have been shown to induce sleep and vivid dreaming, with the subjects reporting profound meaning in the dreams.

Preparation is almost invariably as a tea. However, zacatechichi is intensely bitter and soapy tasting and little can be done to mask the taste (though mixture with the sweetener herb Stevia or preparation by taking Miracle Berry which makes everything taste sweet sound like reasonable suggestions). My experience has been to mix a rounded teaspoon of zacatechichi with an ounce of kava kava and preparing it as normal kava. The berries/seeds seem to have more effect, though the leaf material itself is potent.

Little empirical or pharmacologic data exists so far, one notable study being Lilian Mayagoitia's (1986) "Calea Zacatechichi: Psychopharmacologic Analysis of an Alleged Oneirogenic Plant" in vol. 18 of the Journal of Ethnopharmacology.

Please also see entry [2.10, Kava kava](#).

[Home](#) - [Herb FAQs](#) - [Articles](#) - [Classic texts](#) - [Archives](#) - [Links I like](#) - [Pictures](#) - [Plant names](#)





[Home](#) > [Herb FAQs](#) > [Medicinal herb FAQ](#) > [Herbs for specific things](#) >

[Medicinal herb FAQ: Intro](#) - [Single herbs](#) - [Herbs for specific things](#) - [Processing herbs](#) - [General info](#) - [Information sources](#) - [Schools](#) - [Related forums](#)

The Medicinal HerbFAQ

3.4 Herbs and weight loss

From Patricia Harper <harperp.aol.com>:

Many herbs are used for temporary weight loss, including some that you can buy at an herb store. However, there are many herbalists who consider weight loss formulas to be harmful, and will not make them for their clients. Typically, herbal diet pills use herbs with the following properties to cause weight loss:

1. Stimulants: encourage the body to burn more calories.
2. Diuretics: cause the body to excrete water through excess urine.
3. Cathartics: cause evacuation of the bowels, reduce calorie consumption by impeding full digestion.
4. Appetite suppressants: reduce hunger by expanding in the stomach, altering mood, or satisfying taste.

They may also use herbs to increase perspiration, (more "water weight" loss), and kill pain, or balance nerves.

Some formulas are definitely going to be better balanced than others, but in general, we are not talking here about gentle herbs that nourish and support you, as you bring your habits into balance. Herbal weight loss formulas may have drastic physical effects on your body. "Effective" diet pills --herbal or not-- are potent, depleting, and temporary, if effective. They do not cure overweight conditions.

There are herbs which can be used as supplements while you diet, but weight loss involves your whole lifestyle. Why not consider using herbs to change your lifestyle?

Instead of just using dried, capsulated, herbal products, start including *whole* herbs in your life. Eat them everyday, as fresh as possible, (e.g. take walks, check out the vegetable stand, or tend a garden), everyday. Instead of taking a capsule, eat a handful of fresh parsley. Experiment with tasting each of your favorite culinary herbs made up as "diet" tea. Collect dandelion leaves, plantain, mints, lettuce, whatever, and whip it up in your blender as special diet "green drink." Almost no calories in most herbs.

Also, get to know specific weeds and plants in your neighborhood. Learn their names and uses;

look at them. Watch how they grow, Think about their growing condition and responses to it. You can even keep a journal noting everything you learn about each plant. Spring is the perfect time to bring herbs into your lifestyle.

Eating and living with herbs can bring you a lifestyle which may be more conducive to weight loss.

Best of the Herbal Forums: <http://www.ibiblio.org/herbmed/archives/Best/2000/weightloss.html>

[Home](#) - [Herb FAQs](#) - [Articles](#) - [Classic texts](#) - [Archives](#) - [Links I like](#) - [Pictures](#) - [Plant names](#)





[Home](#) > [Herb FAQs](#) > [Medicinal herb FAQ](#) > [Herbs for specific things](#) >

[Medicinal herb FAQ: Intro](#) - [Single herbs](#) - [Herbs for specific things](#) - [Processing herbs](#) - [General info](#) - [Information sources](#) - [Schools](#) - [Related forums](#)

The Medicinal HerbFAQ

3.5 Insomnia

Also see entry [2.1, Valeriana](#).

> I REALLY need some herbs to take for insomnia. My doctor says I am in excellent health, and I am not depressed, but insomnia has been a terrible problem for me since I was a child. Can anyone recommend some herbs to me that either taste good-ok (not valerian--it smells so bad to me :() OR tell me how to make a herbal sleep pillow?

From trowan.ivory.trentu.ca (The Literate Tomboy):

Rub a little lavender oil under your nose and breathe deep as you lie in bed...

From burleigh.tcg.anl.gov (darin)

Organic chemistry textbooks. It was a surefire thing in college.

From dsm2.ix.netcom.com (sherree moore)

Okay, I've been lurking around reading the herbal newsgroup and I JUST have to give my remedy for insomnia. When I can't sleep I make a tea from chamomile (of course), valerian, hops, and a smidge of passion flower. Works every time. Of course, this combination might become a bit too much every single night! Therefore, a hops pillow might help. Make a small pillow and fill it with hops. Really doesn't smell bad at all. Oh yes, the tea is an acquired taste, but honey helps.



From carl.mork.nwcs.org (Carl Mork):

The various mints are good in tea for making you relax. I make a nice mix of peppermint, cat mint and apple mint to brew up the tea. A pillow is simple to make. Use the same mints plus lavender. There are other herbs that are used for sleep, but those are the ones I know from practical

experience.

The mix for tea and pillows should be to your taste. Oh and I suggest honey in the tea.

3.5.1 Insomnia therapeutics

From Henriette:

Insomnia. The first thing to do is to cut out all caffeine. That means coffee, tea, cocoa, cola drinks, guarana, mate, etc.

Do you exercise? You might not be tired if you don't move during the day. 30 minutes daily walking is good, but more is better (up to a limit).

Don't eat too heavily before bedtime.

Do you have problems with depression? SJW (*Hypericum*, St. John's wort) helps with mild to moderate depression, and one of the signs of depression is that you wake up early in the morning and can't go back to sleep. Simple insomnia is another sign. SJW needs to be taken regularly for a few weeks before you notice a difference.

Is your room dark enough? Before you shop for dark dark drapes for your windows you can test by investing in a set of those thick cloth goggles to put over your eyes. You know, the type that makes it easier to sleep when you travel by plane.

If all that is OK here's a herbal blend that has worked nicely for all people I have given it to:

1 part *Hypericum* tincture (fresh flowering tops, 1:2 95 %)

1 part *Eschscholtzia* tincture (fresh herb, 1:2 95 %)

Mix, take 30 drops as needed. Keep the bottle near your bed, or make a tea of the recently dried herbs and keep the tea ready on your bedside table.

Another blend would be

1 part *Hypericum* tincture (fresh flowering tops, 1:2 95 %)

1 part *Avena* tincture (fresh milky seed, 1:2 95 %)

Mix, take 30 drops as needed. This can't be substituted with a tea, as *Avena* milky seed has to be used fresh.

Or you could try some of the herbal suggestions given above. Whatever you do, don't put lavender essential oil (EO) on your upper lip - that smell will keep you awake. If you want to use lavender EO, put it on a tissue and keep that under your pillow. That way, when you get tired of the smell, you can remove the tissue.

[Home](#) - [Herb FAQs](#) - [Articles](#) - [Classic texts](#) - [Archives](#) - [Links I like](#) - [Pictures](#) - [Plant names](#)





[Home](#) > [Herb FAQs](#) > [Medicinal herb FAQ](#) > [Herbs for specific things](#) >

[Medicinal herb FAQ: Intro](#) - [Single herbs](#) - [Herbs for specific things](#) - [Processing herbs](#) - [General info](#) - [Information sources](#) - [Schools](#) - [Related forums](#)

The Medicinal HerbFAQ

3.6 Aphrodisiacs

From Peter L. Schuerman <plschuerman.ucdavis.edu>:

Try this:

2 parts safflower (or 1 part saffron)

2 parts hibiscus flower

2 parts rose flower

in tea (1 tsp. per cup) or capsules (1-2 OO caps).

According to Ayurvedic philosophy, the floral structures of plants have their medicinal effects on the reproductive system. This formula is made of three flowers; the first is an aphrodisiac, the second exerts an influence on the sexual chakra and the third exerts an influence on the heart chakra and acts to harmonize the blend.

From Back in Black <skeevers.netcom.com>, to above:

If you find the effect of this mixture too overwhelming (depending on your constitution, it might be) you can also add 1 part myrrh to soften the effect. Without the myrrh, it has quite a punch, with the myrrh, it has a much more diffuse effect, spread throughout the entire body rather than being so focused on the lower two chakras (or at least, those are the effects it had on me).

Personally, I couldn't stomach this mixture as tea -- capsules are preferable -- but it's also not bad in vanilla yogurt, if you don't have capsules.

From Henriette:

Germans use celeriac root as an aphrodisiac. It works because it enhances blood flow to the pelvic area; but any aphrodisiac will work better if both partners know about it.

So here's a recipe for a **Waldorf salad for two**:

1,5 dl grated raw celeriac

1 apple, grated or cut into pieces

1-2 tblspoons walnuts

dressing: 1 dl sourcream, 1/4 teaspoon mustard, herbsalt.

Mix and enjoy.



Henriette's Herbal Homepage



[Home](#) > [Herb FAQs](#) > [Medicinal herb FAQ](#) > [Herbs for specific things](#) >

[Medicinal herb FAQ: Intro](#) - [Single herbs](#) - [Herbs for specific things](#) - [Processing herbs](#) - [General info](#) - [Information sources](#) - [Schools](#) - [Related forums](#)

The Medicinal HerbFAQ

3.7 Herbal Abortives and Birth Control

[common sense](#)

Disclaimer: This is not anything you should try at home without supervision from a knowledgeable herb person.

From Colette Gardiner <coletteg.efn.org>:

Current and reliable information on herbal birth control is rare. In the Western tradition much information on birth control as well as safe birthing techniques was destroyed during the European Witch hunts circa 1450-1700. Having such knowledge was proof positive that you were a witch. Other historical information is often incomplete, with only a local common name, or no exact dosages. Researchers often discard supportive techniques such as fasting or ritual as mere superstition. Current studies tend to be anecdotal rather than strictly lab controlled data. This does not mean they are not of value, but again pertinent info may be missing. Such as was the woman pregnant in the first place? Anecdotal info can give us ideas on where to start and what the possibilities are. They have also shown us that herbal abortives are not themselves without side effects, often severe. All herbal info on abortives should be thoroughly researched before use. Some herbalists feel that herbal abortions are more dangerous than clinical abortions. Abortive herbs are toxic and do have side effects. They are not safer because they are natural. Clinical abortions are certainly more effective. Most importantly an herbal abortion should never be undertaken unless a women is willing to follow up with a clinical abortion if the herbs fail.

EFFECTIVENESS

Varying success rates have been claimed for herbal birth control. Estimates vary from 20%-80%. It is important to remember that most of these rates are based on the incidence of successfully bringing on a delayed period, not in aborting a definite pregnancy. Since many herbs seem to work the best close to the time of the first missed menstrual period, many women have not had a pregnancy test at the time they took herbal abortives. Studies on the success rate of herbal abortives in non-confirmed pregnancies is quite high (70%-80%). Success rates with confirmed pregnancies is substantially lower, 20% or less. Also there's not as much research on herbal

abortives with confirmed pregnancy.

SPECIFICS

Rina Nissim, founder of the Dispensaire des Femmes in Switzerland claims a success rate of 60%-80% in women who believed they were pregnant (non-tested). Their method involved the use of at least two herbs at a time. Generally one emmenagogue (bleeding stimulator) with an oxytocic (uterine contraction stimulator) for no more than six days starting as soon as a woman's period is late. They have found that starting the herbal regimen later than six days overdue drops the success rate to 20%.

In a survey I conducted (appendix A) with a small group of women there appeared to be a high success rate (about 75%). However only one of the women had a positive pregnancy test, so actual success rates were certainly much lower. My experience with women where there has been more complete information, such as positive pregnancy tests and follow up leads me to guess at a realistic success rate of 20% at this time. In a highly quoted New Mexico study, Cotton root bark had a very high success rate, with a fairly low toxicity. However it appears that very few of the women were actually pregnant based on blood tests and screening.

Less info is available on prevention of pregnancy with herbs. In an informal study (appendix B) by Robin Bennett with Wild Carrot Seed used on a semi- regular basis as an implantation preventer she had a 98% success rate with few side effects. There is also a much quoted seven year study involving one hundred women in Alaska that also claimed high success rates for wild carrot seed. But no one seems to have any specifics on it.

SAFETY

In general many herbal abortives are mildly poisonous to potentially fatal in large doses. Almost all women report at least one of the following side effects:

- Increased bleeding
- Dizziness and nausea sometimes extreme enough to cause fear.
- Visual disturbances
- Sweats or chills
- Diarrhea

Less commonly reported side effects:

- Incomplete abortion
- Irregular cycles for 1-3 months

The above can also occur in clinical abortions.

- Kidney irritation
- Breast Lumps (Tansy)

Almost all women reported heavier bleeding and clotting than normal and felt that this was an indication of an aborted pregnancy. While this is indeed a sign of aborted pregnancy it's also common with use of emmenagogues. Common sense would indicate that when using emmenagogues there would be the chance of hemorrhage, but it appears to be a not very common side effect compared to the other effects. Most side effects appear to be of short duration. I do know of one case where a women experienced severe long term endocrine imbalance after using herbal abortives.

SERIOUS SIDE EFFECTS

The most serious side effects seem to occur when women use herbal abortives, remain pregnant and attempt to carry to term. There is a high enough rate of reported instances to call for extreme caution.

- Incomplete or low implantation of the placenta (reported frequently by many practitioners)
- Premature detachment of the placenta before or during birth

Consequences of these side effects can be severe and potentially fatal. Severe hemorrhage can and does occur under these circumstances. In one case a women lost 1/3 of her blood volume before bleeding could be stopped. Treatment consists of total bed rest and staying close to a hospital. The risks to both mother and fetus are extreme.

- A few isolated reports of toxemia possibly related to herbal abortives.

ONE FINAL VERY SUBJECTIVE NOTE

Clinic workers who see many clinical abortions note that women who used herbal abortives on their current pregnancy seem to have darker, thicker blood with more clotting.

USE OF HERBAL ABORTIVES AS A LABOR FACILITATOR

A few of the herbs that are used as herbal abortives maybe safely used in the last trimester of pregnancy under specific conditions to help facilitate healthy labor. While safe if properly used they should not be used unless a problem exists and only with the help of a practitioner.

HERBAL SPECIFICS

There are two main types of herbs used as abortives. Emmenagogues and oxytocins.

EMMENAGOGUES

Emmenagogues stimulate blood circulation to the pelvic area and uterus and help to stimulate menstruation.

- Vitamin C - no buffers or fillers. Dose: 500 mg every hour for 12 hours up to 5 days.
Toxicity: possible kidney irritation, loose bowels.
- Ginger - *Zingiber officinale*, Dose: 1 oz. fresh or dry root to pint of water.
Toxicity: possible light-headedness.
- Pennyroyal - *Mentha pulegium* & *Hedeoma pulegiodes*, Dose: 1/4 cup of herb to 1 quart water once a day for no more than 6 days.
Toxicity: nausea, numbness in hand and legs, liver irritation, kidney and bladder irritation, diarrhea, The essential oil is fatal internally. Contraindications: kidney conditions.
- Angelica root - *Angelica archangelica*, Dosage: 1/4 cup herb to 1 quart water as tea.
Tincture - 10-20 drops every two hours. Dried root less toxic than fresh.
Toxicity: irritant to kidney and liver, not studied as much as pennyroyal. Contraindicated in diabetes as it raises blood sugar levels.
- Mugwort Leaf - *Artemisia vulgaris*, Dosage: 3 teaspoon per cup tea, 3 cups per day, for no more than six days.
Toxicity: higher doses can cause liver damage and convulsions. Nausea. Contraindications: Uterine inflammation or recent pelvic infection.
- Black Cohosh Root - *Cimicifuga racemosa*, Dosage: 3 teaspoons per cup, 4 times a day.
Tincture 20 drops every 6 hours.
Toxicity: Diarrhea, dizziness, headache, decreased pulse rate, tremors, fatalities can occur in large enough doses.
- Tansy - *Tanacetum vulgare*. Note: Do not confuse with tansy ragwort, *Senecio jacobaea*, which is a poisonous plant known to cause death in cattle thru liver failure. Dosage: Tea, 4-8 teaspoons per qt. sipped throughout day. 10 drops tincture in warm water every two hours til bleeding commences, for no more than 5 days.
Toxicity: breast lumps, possible hemorrhage, liver irritant. Essential oil is fatal - do not ingest.

OXYTOCIC HERBS

They imitate oxytocin in the body to stimulate uterine contractions and release prostaglandin hormones. All oxytocic herbs are toxic to some degree. Women can experience very painful contractions. They are generally hard on the liver. Women with a history of liver disease such as hepatitis may wish to avoid them all together.

- Blue Cohosh root - *Caulophyllum thalictroides*, Dosage: Tea - 3 teaspoons herb per cup, 3 cups per day, tincture - 20 drops every 4 hours, for six days or til bleeding commences.
Toxicity: nausea, vomiting, headaches, convulsions in large doses, kidney and liver irritant, Contraindications: low blood pressure. Some of the constituents of Cohosh are more soluble as tincture.
- Angelica - see emmenagogues.
- Cotton root bark - *Gossypium herbacetum*, Dosage: 12 teaspoons per quart, 1/2 - 1 quart thru day. Tincture 10 drops every few hours til bleeding commences, for no more than 6 days.
Toxicity : seemingly low based on the New Mexico study. Cotton is a heavily sprayed crop with pesticides that are only used on non food crops. Those pesticides can cause liver

irritation, and other problems. Organic cotton root bark may be difficult to find.

OTHER HERBS USED

- Wild Carrot Seed - *Daucus carota*, used as a preventative. Dosage: 1 teaspoon a day chewed and washed down with fluid. Believed to work as an implantation preventor by making the uterine lining unsuitable. See appendix B.
Toxicity: So far appears to be low toxicity, long term effects unknown. Identification must be absolute as many wild members of this family look similar and can be fatal.
- Trillium root - *Trillium* spp. Dosage: tincture 30 drops 3-4 times a day. Tea 3 teaspoons per cup, 1 quart per day. Trillium root is used by midwives to facilitate softening of the cervix and is often used as a labor adjunct in the case of rigid os or as a preparatory agent before trying to induce labor with stronger herbs. It occasionally will start labor on it's own. As an abortive there is not a lot of current use info on effectiveness and side effects. Trillium root should only be harvested from garden grown plants as it is rare in the wild due to habitat destruction by logging and urban growth.
- Parsley - *Petroselinum* spp. Used as a fresh plant vaginal insert for 24 hours. Personally I have heard of no cases of even bringing on a delayed period with this method.
Toxicity: low.

Misc. Herbs listed as abortives: Agave, Osha, Mistletoe, Rue, Peyote, Sweet flag, Papaya seed, Feverfew, Motherwort, Wood Sorrel, Damiana.

The above is by no means an exhaustive list, many mild emmenagogues are listed as abortives in literature both scientific and folkloric: Marjoram, Oregano, Beet, Celery, Papaya fruit, Peppermint, Valerian, etc. While they may help facilitate onset of a slow period, such as the type where there's cramping and pelvic heaviness but bleeding has not yet commenced, it's doubtful they would act as abortives.

Dosages mentioned above may be on the conservative side in many cases. However, since the serious side effects show up at higher doses it's best to be cautious. I've seen better results with tea than with tincture and with mixing 2 -3 herbs together in a blend. Herbal abortives effects may be enhanced by a day of fasting, working with ritual, and massage of the uterine acupuncture points along the ankles several times a day for at least ten minutes at a time. Again the success rate is very low for actual pregnancies.

Ideally if a woman wished to use herbal abortives I would recommend finding a clinic that does early pregnancy testing of the type that can detect pregnancy within a few days of conception, preferably one that can see women on a walk in basis so you don't have to wait for an appointment. Then if you are not pregnant you can use a mild emmenagogue such as marjoram, without stressing your body. Since early testing is not 100% accurate and if you are fairly sure you are pregnant, you may wish to use one of the less toxic abortives such as Vitamin C. Since most of the abortives are so hard on the body they should only be used in cases of confirmed pregnancy. Why put your liver thru more stress than it already gets in today's world?

APPENDIX A

SURVEY ON HERBAL BIRTH CONTROL AND ABORTIVES

Colette Gardiner

Of the 10 women in the study:

None had used herbs preventatively as contraception

6 had previously been pregnant

8 could tell very accurately when they ovulated

8 of the women had used herbal abortives

1 women had delayed ovulation time with herbs use

1 women was a practitioner who counseled about herbal abortives

6 of the women had side effects

6 of the 8 women who used herbal abortives brought on a delayed period with herbs. Only one of these women had a confirmed pregnancy, but all the women felt they were pregnant. Two of these women were a few weeks late. A few of these women had unsuccessful herbal abortive attempts at other times.

Time Frame Abortives Used:

Brought on period with herbs at:

Three weeks overdue - 1 women

Two weeks overdue - 1 women

When period was due - 4 women

Many of the women reported friends who used herbal abortives successfully, but I did not use those accounts in my survey. In general the second hand reports were very similar to the survey results.

A practitioner reported that several women in her area were drinking sassafras tea as a contraceptive. She didn't give details on safety or effectiveness.

One women reported that either Vitamin A or Goldenseal seemed to delay ovulation. I've heard no other instances of this.

My next project is to do a larger survey on herbal abortives with women who have had a positive early pregnancy test. For info or to participate contact me at:

coletteg.efn.org

or

P.O Box 10914

Eugene,Or.

U.S.A. 97440

APPENDIX B

Wild Carrot Seed as an Herbal Contraceptive

Survey conducted by Robin Bennett

In Robin's info she stresses that it was a small study, and that she did not use scientific, double blind methods etc.

In her survey there were three dosage regimes

- 1) Every day
- 2) Daily for 7 -8 days surrounding ovulation
- 3) For 7 days following intercourse

The dosage for all women was one teaspoon daily chewed and washed down with fluids. Half of the women in the study used it as their only form of birth control. The study lasted for one year. Out of the ten women in the study: one became pregnant and had a clinical abortion. She became pregnant when she used the seeds for only three days around ovulation instead of the recommended 7-8. She had a clinical abortion. Two other women suspected they were pregnant and used herbal emmenagogues to bring on their period. One of these women was using the seeds daily. The other woman was using them for 7-8 days surrounding ovulation. One of the women discontinued seed use in order to become pregnant and did. There were some mild side effects such as gas and slightly earlier periods. Some women felt that anything less than the full dose actually enhanced fertility. None of the women reported any symptoms of uterine irritation and subsequent exams showed no signs of it. In her handout Robin mentions some lab studies using WCS as an implantation preventor in mice, but did not give details.

Her address:

Robin Bennett
R.R. 2 - Box 301
Garrison, N.Y.
U.S.A. 10524

From allissa.foxcomm.net (Allissa Gaul): the lab studies are:

- Comparative Physiology and Ecology, 9:70-74, "Abortifacient effect of carrotseed extract and its reversal by progesterone in albino rats", by Kaliwal, BB, first author.
 - Journal of Advanced Zoology 7:36-41, "The estrogenic efficacy of carrot seeds" by Kant, A., et al.
-

3.7.1 Herbal Abortives and Common Sense

Somebody wrote:

>> **A friend of mine does not use birth control. Is there an natural form for the abortion process?**

Somebody else tried to be helpful:

- > **Here is a formula that is intended to induce a miscarriage:**
- > 20 drops blue cohosh
- > 20 drops black cohosh

- > 20 drops pennyroyal
- > Measure the tinctures into a cup of warm water ...

And finally some Common Sense; Jonathan Treasure <jonno.teleport.com> replied to above:

It is debatable whether using herbal medicine to cause uterine rejection of a conceptus is any more "natural" than an a D&C. Herbs can be potent and potentially dangerous - just because they grew out of the ground doesn't confer the status "natural" on anything they may be used for especially when the only alternative is orthodox procedural medicine. However the answer is YES, herbal abortion is possible, in certain circumstances.

It would however be quite insane to take a recommendation from an internet list and simply believe that is the end of it...we are not talking about a common cold here. The reply giving cohosh/pennyroyal recipes was just plain daft - how late is she, how old is she, what is her general health, nutritional status, psychological state, emotional strength, domestic situation, support network etc etc etc etc etc. All these questions come before some generic formula can be given. Then the formula given was not related to strength of tincture, dried or fresh plant used, etc. The dose pattern given was potentially excessive. It might harm or her or it may not work at all. Would you then write to this list again? Grow up! I would urge your friend to consult someone who is experienced in the herbal management of ob/gyn if there is a real need (e.g. legality/finance) to go this route.

[Home](#) - [Herb FAQs](#) - [Articles](#) - [Classic texts](#) - [Archives](#) - [Links I like](#) - [Pictures](#) - [Plant names](#)





Henriette's Herbal Homepage

[Home](#) > [Herb FAQs](#) > [Medicinal herb FAQ](#) > [Herbs for specific things](#) >

[Medicinal herb FAQ: Intro](#) - [Single herbs](#) - [Herbs for specific things](#) - [Processing herbs](#) - [General info](#) - [Information sources](#) - [Schools](#) - [Related forums](#)

The Medicinal HerbFAQ

3.8 Herbs and female infertility

By Roy Upton (herbal.got.net).

There are a number of options to try for <this person>. I have worked with infertility for many years with a decent degree of success. As I do not know what is specifically the cause of <this person's> infertility; i.e. inability to conceive, incompatibility with sperm, low level infection, inability to maintain the pregnancy due to insufficient progesterone levels, etc. I will provide some general rules of thumb. Most of what I will outline is based on traditional Chinese medicine.

Gynecological imbalances are considered to be associated with poor pelvic circulation which prevents the gynecological system from being as healthy as it can be. Most botanical formulas are geared to promoting pelvic circulation. The most commonly used are formulas that include at least four herbs; Dang Gui (*Angelica sinensis*), Ligusticum, Rehmannia, and White Peony. This is a classic Chinese formula known as Dang Gui Four and can be found in any Chinatown and some health food stores. There are many variations of this formula. Another is called Women's Precious, or Eight Precious Pills. Either would be a good general formula to try. They should not be used during bleeding, menses, and generally not during pregnancy.

Another botanical to use in conjunction with any Dang Gui-based formula is Chaste berry (*Vitex agnus-castus*). Vitex is a progesterone agonist which can help to minimize the risk of miscarriage. In addition, it can also stimulate ovulation. It works specifically by enhancing pituitary function, thus improving ovarian function. A few other herbs that I add either to the Dang Gui formula or to the Chaste Berry are False unicorn, Partridge Berry and Cramp Bark. I sometimes recommend a thyroid glandular as well, and insure the woman is not anemic or borderline anemic.

The basic protocol is to utilize the Dang Gui Four formula in conjunction with Chaste Berry throughout the month except during menses. We could get fancy and give one formula during the estrogenic phase of the cycle, and the Chaste Berry for the progesteronic phase, but this is seldom necessary. I use custom-blended teas or ready made commercial formulas. My suggestion would be to go to a health food store, TCM practitioner or naturopathic physician and ask which are the best Dang Gui/Chaste Berry products available. You have to be diligent in getting a decent product. There are many Dang Gui products consisting of only Dang Gui, or which are not put together that well. There is also a lot of bogus chaste berry floating around on the market, especially that available from Chinatown. One of the more popular capsuled products is 85%

millet, and is largely ineffective.

Lastly, it is important to encourage those trying to conceive to look at conception just as you would look at a garden. Before you ever plant a seed you cultivate the soil. In this case, you do not want to attempt conception for at least three cycles, ideally six cycles. Both the man and women should be brought into this process by recommending the man use herbs that increase sperm count and motility (Ashwagandha, Astragalus, Kidney tonics, avoiding excessive sexual activity and hot tubs, etc.). The woman should also be exercising regularly, focusing on improving abdominal tonicity. Kegels are excellent exercises to try. This is to insure adequate tonicity of tissue internally so implantation can hold.

Focusing on nutritional well-being is very important for obvious reason, even if the women is not anemic. This basic protocol has worked in dozens of women that I have worked with, with conception taking place anywhere from 3 weeks to four months. I do not know of anyone specifically that it has not worked for, but this may be due to the fact that if it didn't work they may not have come back to me, or went on to try something else. I have had several women who continued to use the Dang Gui formula even after conception, one for up to six months because she forgot that I told her not to use it during pregnancy. The reason it is generally contraindicated is because it increases blood flow, something you do not want to do in pregnancy. However, once the system is healthy and conception takes place, nothing short of a strong abortive is going to dislodge the fetus. She had a normal pregnancy, and the baby was apparently healthy and happy.

I hope this helps. Best of luck.

[Home](#) - [Herb FAQs](#) - [Articles](#) - [Classic texts](#) - [Archives](#) - [Links I like](#) - [Pictures](#) - [Plant names](#)





[Home](#) > [Herb FAQs](#) > [Medicinal herb FAQ](#) > [Herbs for specific things](#) >

[Medicinal herb FAQ: Intro](#) - [Single herbs](#) - [Herbs for specific things](#) - [Processing herbs](#) - [General info](#) - [Information sources](#) - [Schools](#) - [Related forums](#)

The Medicinal HerbFAQ

3.9 Herbs, ADD, and replacing Ritalin

>Does anyone know of any viable substitutes for Ritalin for ADD? I have heard of a substance called Pycnogenol. Are there any other substitutes for taking Ritalin? How long does a person need to take Pycnogenol in order for it to take effect?

From herbal.got.net (Roy Upton):

I have seen at least 70 children weaned of Ritalin. I usually recommend weaning off of Ritalin for a 2-3 week period, while administering the herbs. Usually, the program consists of dietary modification, exercise, and nutritional and herbal supplementation. Though treatment is similar, differentiate between ADD and ADHD. ADD might be a direct result of under/poor nourishment. The brain is the most energy intensive organ of the body. If the body is deprived of energy, the brain is first to suffer. In ADHD there is often a rapid heart beat that may have varying underlying causes such as specific allergies.

DIETARY

- Elimination of most simple sugars including fruit juices, foods with colors and preservatives. Concentrate on a whole foods diet.
- Magnesium supplementation. Dosage based on weight, age of child.
- I have used a combination of the following herbs with significant success (according to parents and teachers): Chinese zizyphus, chamomile, lemon balm, catnip, hawthorn berry, and gotu kola flavored with cinnamon, anise, and a touch of cloves. Usually this is prepared as a glycerite extract (approx. 1:3-1:5 concentration). 20 drops 2-3 daily. I alternate this with Hawthorn berry syrup, 1 tsp 2 x daily.
- Exercise is a must for ADHD.

In Germany, Chamomile tea, and small doses of valerian root are utilized.

I think it is important to note that ADD and ADHD is one of the most frequently diagnosed conditions in children, and that is rising dramatically, much to the concern of many practitioners who feel that the diagnosis is handed out much too casually. I believe the makers of Ritalin have done an excellent job of marketing. There have been a series of articles (and a few books) I have seen over the past number of years on the need to provide a "proper diagnosis" of these children

rather than labeling them as "bad". Teachers have become the prime target for providing the initial grounds for diagnosis. Oftentimes, a child will be diagnosed in kindergarten or early grade school and not adequately reassessed for a number of years. The inherent problem in both of these is obvious. I also do not believe the diagnosis should be made until all lifestyle protocols (including supplementation, diet, exercise, etc.) have been attempted and failed.

I am of the firm belief, from many of the parents that I have seen, that it is often the parents that primarily require the help, the children secondarily. This is especially true of ADHD. Relative to the energy levels of the majority of exhausted, "burned-out at the end of the work day" parents, the majority of children are "hyperactive". We try to force them to be little adults before they have developed the coping mechanisms or social skills we design to stifle their natural impulses. We expect them to sit still when they have boundless physical energy. We ask (tell) them to pay attention to educational materials that mean little to them. This is an indictment of our education system as well.

Also, the typical American child is raised on nutritionless foods, challenged with numerous stresses, and spends an average of six hours a day in front of the television, when they should be expending the physical energy. While I believe that medicating, especially with amphetamines, is beneficial for some, by-and-large, it should be a last resort.

I hope this is of some help.

[Home](#) - [Herb FAQs](#) - [Articles](#) - [Classic texts](#) - [Archives](#) - [Links I like](#) - [Pictures](#) - [Plant names](#)





[Home](#) > [Herb FAQs](#) > [Medicinal herb FAQ](#) > [Herbs for specific things](#) >

[Medicinal herb FAQ: Intro](#) - [Single herbs](#) - [Herbs for specific things](#) - [Processing herbs](#) - [General info](#) - [Information sources](#) - [Schools](#) - [Related forums](#)

The Medicinal HerbFAQ

3.10 Herbs for sunburn

From Howie Brounstein <howieb.TELEPORT.COM>:

I have found plant tannins to be the best sunburn treatment. Tannins are found in most plants, and are particularly high in many plants. They bind with alkaloids and proteins. This is helpful in the case of burnt skin --- broken proteins. The tannins bind with the broken skin proteins to form a layer of tannoproteins, or was that proteotannins (it's a little late). This layer is protective and soothing.

I generally throw some Manzanita leaves into water and boil. If you're preparing a wash for sunburn and are primarily concerned with extracting tannins, you can just boil it, no matter what the herb. You can wash the sunburn with the tea when it cools.

Some astringents with tannins (to name a few):

- Manzanita
- Uva ursi (kinnikkinik)
- *Polygonum* roots (bistort)
- *Heuchera* (alum root)
- Currant and Gooseberry Bark (*Ribes*)
- *Geum*
- *Potentilla*
- *Rosa's* Bark and roots
- *Rubus* (blackberry root)
- *Ceanothus* bark and root
- *Cornus* Dogwood Bark
- *Chimaphila* Prince's Pine pipsissewa
- *Pyrola*
- Black Tea

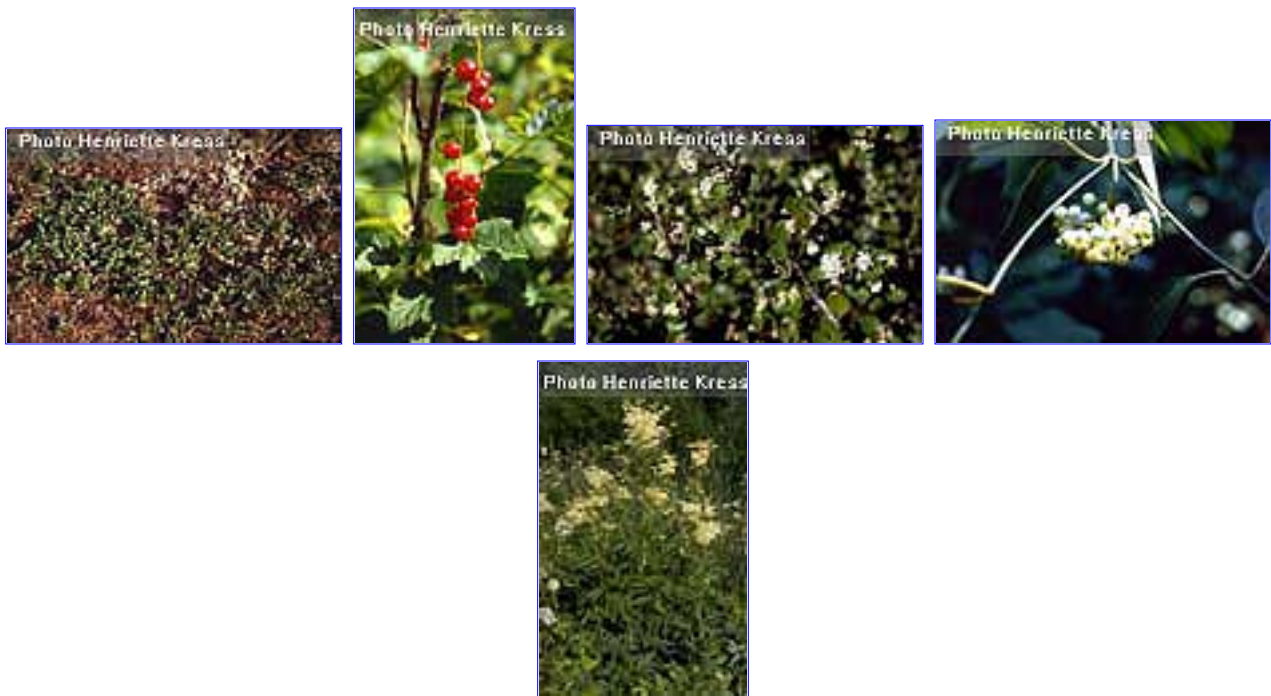

These contain salicylates which may have some topical analgesic effects:

- Willow Bark
- Oak Bark
- Poplar Bark
- Meadowsweet (*Filipendula*)

From Satin <satin.TOPAZ.USAF.AF.MIL>:

I use an aloe and comfrey lotion on sunburn. I am a strawberry blonde with my red-headed Mom's complexion - I don't tan. It's either burn or nothing. So I wear sunscreen and keep the aloe/comfrey lotion on hand.

From Craig Roberts <croberts.MAGNUS.ACS.OHIO-STATE.EDU>:

For some reason, aloe vera hasn't proven to be the miracle for my skin that it is for some people's.

One of the best burn treatments I know of is lavender essential oil, applied neat. The aromatherapy literature is full of references and documentation of its use in this connection and the impressive results. Since lavender e.o. is quite benign and doesn't sting, this would be quite good for a child. In my experience, the burning and redness begin to subside quite soon after application. In contrast, the aloe takes much longer and at least initially the relief seems to be due more to the cooling effect of its evaporation.

Another therapy that has been used for burns, as well as infected wounds, for thousands of years is human urine, or its derivative, urea. There are a number of articles on this and other medicinal uses of human urine and its derivatives in the contemporary establishment medical literature, such as *The Lancet* and *JAMA*, for those who find this reassuring. (As usual, a simple, inexpensive remedy doesn't receive the press or research money that patentable, synthetic drugs do.) I haven't

tried this myself on burns yet, but apparently one applies urine or urea-soaked compresses to the affected area, keeping them wet with fresh applications of urine. Though urea is said to sting a bit, straight urine supposedly does not.

From Mary Jo Gilsdorf <viomist.CASTLE.NET>:

For burns, I find oatmeal poultices and cold tea bags works best to take out the sting and stop the rash like effect. Also know some who swear by taking two to three regular aspirins.

From JunieWrite.aol.com:

Mary Jo writes that she knows some people who swear by two or three aspirin: may I point out that taking aspirin even in small quantities (less than 300mg) may be positively dangerous to hypertensive BP sufferers. OTOH, aspirin is proving to be invaluable in the prevention of coronary occlusion and CVA in normotensives; especially in diabetics and those suffering from lipid dysfunction.

All burns are less painful and less damaging if the 'heat' is countered asap, preferably by immersing the affected part in cold water and keeping it there until help arrives.

N.B. It may be supposed that Heatstroke victims (who are often also suffering from sunburn) would also respond to cold water; but that is not so; heatstroke victims should be placed in tepid water as a first-aid measure to reduce body-core temp until medical help arrives.

BTW, severe sunburn occurs to people with my skin type even when the sky is overcast as I discovered after falling asleep on a Moroccan beach (January) on a very overcast day. Standing under a cold shower made me yelp and shriek like a banshee; but later, the only 'peeling' was to nape of neck and backs of knees.

[Home](#) - [Herb FAQs](#) - [Articles](#) - [Classic texts](#) - [Archives](#) - [Links I like](#) - [Pictures](#) - [Plant names](#)





[Home](#) > [Herb FAQs](#) > [Medicinal herb FAQ](#) > [Herbs for specific things](#) >

[Medicinal herb FAQ: Intro](#) - [Single herbs](#) - [Herbs for specific things](#) - [Processing herbs](#) - [General info](#) - [Information sources](#) - [Schools](#) - [Related forums](#)

The Medicinal HerbFAQ

3.11 The gall bladder flush

From: James Mally, N.D. <jmally.usa.net>:

I am suspicious of gallstones that dissolve or that liquefy when passing. I have done several gall bladder flushes myself using a formula from a book titled "Encyclopedia of Digestive Disorders" by ? Roberts, of Roberts formula fame. The flush involved taking divided doses of olive oil and lemon juice every fifteen minutes over a two hour period to stimulate the gall bladder to contract and release stones. The effects were very dramatic - one time causing drastic elimination out both ends simultaneously. It also made me lose my taste for olive oil for many years.

I also worked as a massage therapist in a clinic where a similar flush was used for detox and cleansing. The "stones" people would pass needed to be kept in the freezer or they would melt. I then read in a book the suggestion that these "stones" were a product of saponification, the olive oil mixing with the alkaline bile salts creating a soap (similar to mixing lye and fat).

At naturopathic college I obtained a real gallstone from the gall bladder of the cadaver we worked on in anatomy lab. It was as hard as a rock and it would not dissolve in olive oil and lemon juice, even after several months. I didn't try dissolving it in coke or ortho-phosphoric acid.

I believe it's possible that a gall bladder flush may cause stones to be eliminated, but these stones will sink to the bottom of the toilet. The "stones" that float and that are easily squashed are most likely soap. I have heard of people passing hundreds of such "stones" which would imply that they must have a huge gall bladder.

I still think there may be some benefit in the flush as it will thin the bile by removing some of the bile salts so they won't be recycled.

Several areas for conjecture: I wonder if such a loss of bile salts would cause any mineral deficiencies? Also has anyone done any blood tests for direct and indirect bilirubin and/or any lipid panels before and after a gall bladder flush? How about X-ray or diagnostic ultrasound of the gall bladder before and after?

Maybe you could get harder "gallstones" to pass by doing a flush using a more saturated oil such as coconut oil. :) Do not try this at home.

From: Sara Klein Ridgley, PhD SaraKlein.aol.com

I tend to agree with you somewhat on the nature of the soluble stones. However, when I did the cleanse both for myself and with clients, what I found was both kinds were there. In several cases where the people were scheduled for gallbladder surgery and we did the cleanse beforehand, there was no sign of the stones upon ultrasound scan. One woman, who was 86 at the time (11 years ago), collected the stones (that were rock hard) and put them in a jar, and took them to her physician. She announced that "this doctor from America (I was visiting another country when this happened...) took my stones out". The doctor first thought that she was nuts, but when she showed him the jar, he went white in the face. Then he ordered another ultrasound and found the gallstones that were there the week before were gone. This woman is still alive and kicking happily and in good health!

Regarding your second, very valid question regarding mineral depletion following the cleanse, I have found that it CAN be the case, but not always. I have noticed, for example, that many, many people who undergo gallbladder removal surgically, become depressed shortly thereafter. I also have thoughts and "speculations" regarding the energy/spiritual factors behind gallbladder problems, but that's another story..

I have used another flush, which is very simple, very safe, yet very dramatic, and even old people with various ailments can do it safely. However, I always like to observe, assist and take care that nothing strange goes on (My control issues? maybe, or just caution...). This one involves 5 days of preparation with eliminating all fat from the diet, and it includes epsom salts, olive oil and freshly squeezed grapefruit juice. I usually do a kidney cleanse prior to the liver/gallbladder flush, which dramatically improves the body's ability to handle the flush.

From: Michael Moore <hrbmoore.primenet.com>

In the early 1980s, after recommending and teaching Robert's protocol, a PhD physiologist **STRONGLY** suggested that these "stones" were probably artifacts of the therapy. The next time someone passed some, I took them in a cooler to a local Santa Fe medical lab I had a working relationship with. They showed only traces of chenicholic and cholic bile salts, and had no discernable cholesterol content. Their educated guess was that they were saponified fatty acids...probably linoleic or oleic acid salts. They were **DEFINITELY** not "gallstones". I have not recommended this grim regimen since.

One of the great scams amongst 19th century medicine shows was this **HUGE** capsule, made out of a colored and sealed gelatin capsule. It cost \$1, and was **GUARANTEED** to pass a tapeworm. Indeed, everyone who took one raved about this long "worm" they passed.

The capsule contained a long coiled spiral of a thin strand of gutta percha (crude rubber), dusted in Lycopodium. This was the "worm".

Robert's protocol, similarly, seems to result in the consistent passing of "stones" consisting of saponified olive oil, acted on as well as possible by the stressed digestive apparatus.

That doesn't mean that the shocked pancreas and gall bladder don't, on occasion, vomit out a small cholesterol stone. But, as anyone who has worked with cholelithiasis will vouch, this is risky stuff,

since an obstruction by a REAL stone of the biliary duct or common duct from the gall bladder spasms may be just as likely. Most gallstones exist WITHOUT symptoms. Most obstructions require surgery.

I find the tapeworm "pill" a safer phenomena-inducing placebo.

[Home](#) - [Herb FAQs](#) - [Articles](#) - [Classic texts](#) - [Archives](#) - [Links I like](#) - [Pictures](#) - [Plant names](#)





[Home](#) > [Herb FAQs](#) > [Medicinal herb FAQ](#) > [Herbs for specific things](#) >

[Medicinal herb FAQ: Intro](#) - [Single herbs](#) - [Herbs for specific things](#) - [Processing herbs](#) - [General info](#) - [Information sources](#) - [Schools](#) - [Related forums](#)

The Medicinal HerbFAQ

3.12 Herbs for cough

By Barbara Heller (BHpurple.aol.com) and Carolyn Mohney (Ccmoherb.aol.com)

Coughs are one of the main signs of a respiratory tract disease and also a very common symptom associated with a variety of physical problems. For example, a cough may be the result of an infection, or a defensive response to inhaled irritants like cigarette smoke, or an allergy symptom. Coughs may also signify a more serious illness like chest tumors or lung congestion from heart insufficiency. Chronic coughs, like any chronic symptom, should be evaluated by a healthcare professional.

(For an in-depth discussion of the various types of coughs, see Treatment of Coughs with Herbal Remedies at Healthy Net; <http://www.healthy.net/>)

In this article we will discuss the herbal treatment of "ordinary, common" coughs. Coughing, itself, may be beneficial since it helps clear the airways for us to breathe better. We generally treat the cough symptoms when the cough is unproductive or it becomes irritating to the throat or chest. We are partial to herbal treatments which are easily available and have few cautions associated with them.

Herbal treatment will include teas and tinctures, steams, and cough drops and syrups. The latter have more direct contact with the throat and are locally soothing. Some are store-bought; others can be made at home from garden or wildcrafted plants.

Common-sense aids for coughs include reducing ones exposure to irritants like smoke, drinking more fluids and increasing moisture throughout the household. Individual **steam inhalation** can be very helpful too:

- Fill a basin with hot water and a handful of fresh or dried herbs (or 3 drops of an appropriate essential oil). "Tent" a towel over your head and the basin so you can carefully breathe in the healing warmth and aroma. Suggested herbs include sage, eucalyptus, peppermint, or hyssop.

Some of the medicinal properties we look for in cough remedies include the following: anti-tussives, which prevent coughing; suppressants, which limit the coughing reflex; expectorants, which help remove excess mucous from the respiratory system; and demulcents, which heal inflamed tissue. Herbal antihistamines are helpful in the treatment of postnasal-drip coughs due to

allergies. Immunostimulants and antibiotics may be used to build up the system and fight infection.

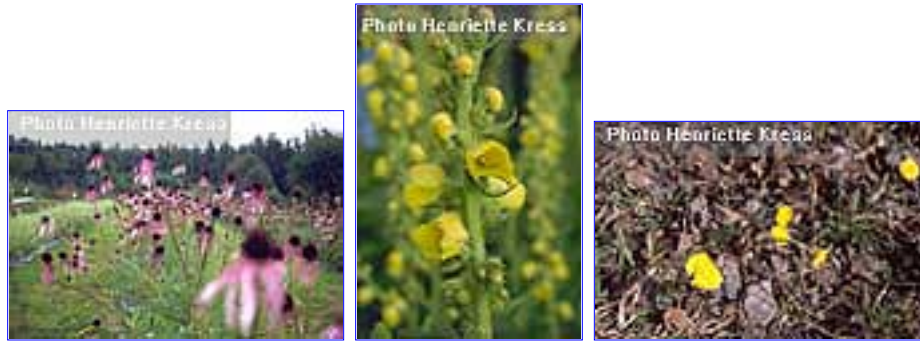

Echinacea (*angustifolia* or *purpurea*), primarily in tincture form, is highly recommended at the first sign of a cold, flu, or cough. Considered "the herbalists herb" it receives high praises as an immunostimulant and antibiotic. Revered by Native Americans, it is easy to grow in the garden where its common name is the purple coneflower. (Note: wild echinacea is being overharvested; consideration to its source is important.)

Mullein (*Verbascum thapsus*) is my specific favorite for coughs. Dr Weil, in *Natural Health, Natural Medicine*, recommends tincture of mullein to relieve chest congestion and dry, bronchial coughs. He also states that the plant has no known toxicity. So it is a remedy I feel confident using with my family. Whenever my adolescent daughter gets a cold or flu, it seems to settle in her chest as a cough. This year we have treated the coughs with mullein tincture and the symptoms diminished quickly. Mullein is a beautiful biennial plant that grows wild in the Eastern US. In present-day herbal medicine its primary form is as a tincture. Historically, Native Americans smoked dried mullein and coltsfoot cigarettes as a remedy for asthma and bronchitis. If used as a tea, it should be well-strained because the small hairs of this fuzzy plant can be irritating.

Coltsfoot (*Tussilago farfara*), whose botanical name *Tussilago* means "cough dispeller", is not surprisingly another very popular cough remedy. A nice image of the flower is evoked by Grieve in her statement that it was painted on the doorpost of the apothecarie's shop. This is the first blooming wildflower in our area of upstate NY; it flowers before its leaves appear. The flowers and leaves are used medicinally for their demulcent and expectorant properties. Coltsfoot has traditionally been used to treat coughs, whooping cough, asthma, excess mucous, bronchitis, and laryngitis. Because of its low-level of pyrrolizidine alkaloids (the same controversial substance found in comfrey), coltsfoot is recommended for only short-term use. Use as a tea or a tincture.

Herbalist David Hoffmann (in his book *The Complete Illustrated Holistic Herbal*) recommends a **cough tea** made of equal parts of mullein, coltsfoot, and licorice:

- An infusion of 1 tablespoon of the mixed herbs is steeped in one cup of water. Sip 3 cups of this brew throughout the day.



Licorice (*Glycyrrhiza glabra*) and marshmallow (*Althea officinalis*) are included in cough remedy recipes for their demulcent qualities. They are soothing herbs that reduce inflammation and add flavor. In addition, licorice itself may have an anti-tussive effect similar to codeine for cough suppression, without the side-effects of codeine. A reminder here to be aware of the cautions of the various herbs added to a mix - in this case, licorice may have its own side-effects. Specifically, it is not recommended for continued use by people with high blood pressure.

Thyme (*Thymus vulgaris*), a very common culinary herb also has medicinal properties qualifying it as a wonderful cough remedy. Thymol, thyme's volatile oil with antiseptic, antibiotic, and expectorant properties, is used in commercial cough syrups. At home, one can benefit from these properties by drinking a hot tea of thyme or a mixture of thyme and plantain; or by drinking a small amount of water with a few drops of thyme tincture. Do not use thyme oil as a home remedy. Even a few teaspoonfuls can be toxic. In Germany, thyme is used to treat coughs, whooping cough, and emphysema.

"German medical herbalist Rudolph Fritz Weiss, M.D. writes: "Thyme is to the trachea (windpipe) and the bronchia what peppermint is to the stomach and the intestines."" (Quoted in M Castleman, The Healing Herbs).

Elecampane (*Inula helenium*) is also considered an important resource as an expectorant and anti-tussive. It can be taken on a long-term basis and is helpful for healing the irritating bronchial cough as well as for asthma. Elecampane is a wonderful garden plant of tall stature that bears bright yellow, sunflower-like flowers (one of its "nicknames" is wild sunflower); it can also be harvested wild. A tea or tincture is made from the dried root gathered in the fall.



Most contemporary herbalists recommend horehound (*Marrubium vulgare*) and hyssop (*Hyssopus officinalis*) for treating minor respiratory problems - coughs, colds, and bronchitis. In addition to horehound's expectorant and demulcent qualities, as an antispasmodic it helps to relax the coughing spasms so common with bronchitis. The added sweetness of horehound candy/coughdrops that are available commercially make the very bitter herb more accessible. Or

one can obtain horehound's healing qualities with a tea, tincture, or syrup. Hyssop is similar in chemical makeup and function to horehound but is much less bitter. Both of these herbs mix well with peppermint. Tea formulas for colds might also combine them with yarrow and elder.

Some other herbs that can be helpful in treating coughs are: wild cherry bark, violets, osha, bee balm, slippery elm, nasturtium, red clover and plantain.

Wild cherry bark (*Prunus serotina*) continues to be a favorite ingredient in cough and cold remedies, primarily due to its sedative effect on the respiratory system. Susun Weed suggests a homemade violet flower syrup for cough treatment which turns a beautiful lavender shade but is a very labor-intensive remedy to make. Bee balm was another Native American remedy for coughs and headcolds, drunk as a tea three times a day. The Peruvian Indians utilized the natural antibiotic qualities of nasturtium leaves to treat coughs. The leaves were eaten fresh daily or drunk as a tea. And last, Native Americans also used slippery elm bark as a tea, gargle, or by chewing on small pieces of the bark to soothe the annoying symptoms of a cough.



Red clover (*Trifolium pratense*) and plantain (*Plantago major* and *lanceolata*) are two very common wildplants in the area we live and write, the Northeastern US. Red clover is an expectorant and anti-spasmodic especially good for children (over the age of 2) with whooping cough. A tea of the dried flower tops is the most convenient; a tincture may also be used. The expectorant and demulcent qualities of plantain are often used in teas for bronchitis and whooping cough.

One cough syrup you can make at home is **Kathy Kevilles Homemade Honey Cough Syrup:**

- 1 tablespoon licorice root
- 1 tablespoon marshmallow root
- 1 tablespoon plantain leaf
- 1 teaspoon thyme leaf
- 1 pint water
- 4 tablespoons honey
- 4 ounces glycerin
- 1/8 teaspoon anise essential oil (optional)

Prepare a triple-strength tea by simmering the herbs in water for 10 minutes, then steeping for 20 minutes. Strain the tea, then stir in honey and glycerin while the tea is still warm. Add optional essential oil. Take 1 tablespoon at a time. Stored in a cool place, this syrup will keep for 2 weeks. In the refrigerator, it will keep for several months.

This recipe is suitable for children, but not for infants, who should not have honey.

[Home](#) - [Herb FAQs](#) - [Articles](#) - [Classic texts](#) - [Archives](#) - [Links I like](#) - [Pictures](#) - [Plant names](#)





[Home](#) > [Herb FAQs](#) > [Medicinal herb FAQ](#) > [Herbs for specific things](#) >

[Medicinal herb FAQ: Intro](#) - [Single herbs](#) - [Herbs for specific things](#) - [Processing herbs](#) - [General info](#) - [Information sources](#) - [Schools](#) - [Related forums](#)

The Medicinal HerbFAQ

3.13 Herbs for constipation

Barbara Heller - BHpurple.aol.com

WHAT IS CONSTIPATION

Constipation, the "difficult, incomplete, or infrequent evacuation of dry hardened feces from the bowels" (The American Heritage Dictionary) can be an occasional, acute, or chronic problem. It can be caused by many factors including lack of fluids, poor diet, sedentary lifestyle, emotional state, or as a side-effect of specific medications. Be aware of the constipating effect of other drugs or supplements you may be taking, like iron tablets, opiates, antidepressants, and antihistamines. Constipation is almost always a nuisance; it can also be a sign of a more serious condition. Chronic constipation should be evaluated in conjunction with a healthcare professional.

NATURAL REMEDIES TO TREAT CONSTIPATION

Laxatives, even herbal laxatives, should be used with caution. Other natural remedies should be tried first. The gentlest remedies for constipation include increased movement and exercise, certain yoga postures, increase of fluid intake, and dietary changes including increased fiber and fruit. Acidophilus liquid or powder relieves chronic constipation (says herbalist Susun Weed in her Wise Woman Ways for the Menopausal Years). And prune juice may be the most effective and gentlest remedy for constipation.

Dr. James Duke, a scientist who worked for the USDA, recommended in his typical iconoclastic fashion, that Dan Rather ask the commissioner of the Food and Drug Administration (FDA) if he considered prune juice a safe and effective laxative. "If he answered no, I suggested that Rather request that Dr. Kessler (the commissioner) drink some and experience the results for himself. If he answered yes, I suggested that Rather ask why FDA labeling regulations prohibit prune juice marketers from stating that prune juice is a safe, effective, gentle laxative." "...(It) is probably the cheapest, least unpleasant laxative now available." (The Green Pharmacy, p140)

Apple-pear juice is also highly recommended; and stewed fruits like prunes, figs, or dates especially when mixed in licorice tea makes a tasty laxative snack

SOME OTHER OPTIONS

Not a usual topic of discussion, at least here in middle-class America, is the position in which one attempts a bowel movement. Squatting can really help alleviate mild constipation - but may be

awkward on traditional toilets. Some families find that using a small footstool to raise and open the legs helps to facilitate an easier evacuation. Massaging the abdomen with essential oils with laxative properties (in a carrier oil base) like chamomile, marjoram, or peppermint can also be helpful.

HERBAL LAXATIVES

There are three classes of herbal laxatives - bulk, mild (but not bulk) and purgative.

Whichever category you use, remember that it takes time for laxatives to work. The bulk herbs may need 12 to 24 hours to encourage a bowel movement, and irritating herbs somewhat less time, perhaps 6 to 12 hours. So be patient, and do not take another dose prematurely.

BULK LAXATIVES

Bulk laxatives are the gentlest for occasional constipation. Flaxseed (also known as linseed), psyllium, and fenugreek are three well-known herbal bulk laxatives. In *The Family Herbal*, the authors recommend flaxseed as a "laxative without side effects". You can take one tablespoon of whole seeds two to three times a day, followed by two cups of liquid. To help bulk laxatives do their job properly, one must drink a lot of water, otherwise gastrointestinal obstructions can occur.

Psyllium, another bulk laxative, is more well-known to most consumers as the main ingredient in Metamucil. A combination of psyllium seeds and a large glass of water can help lubricate the bowels and ease the passage of dry stools. In addition, this seed may also help cut cholesterol. It is quite popular in Germany to take 3 to 10 tablespoons a day for chronic constipation. The seeds swell; they also need plenty of water to motivate their transit through the digestive tract. Caution - asthmatics shouldn't take this herb; if you generally have allergies, take only with caution. ("There have been several reports of allergic reactions to psyllium, including a few serious asthma attacks from inhaled seed dust." - reported by James Duke in *The Green Pharmacy*)

MILD (NOT BULK) HERBAL LAXATIVES

Dandelion root is a mild laxative often recommended by practicing herbalists. Susun Weed says it is especially helpful for bed-ridden elders and others with chronic constipation. "The root in tea will have little effect on constipation due to nervousness, diet, fevers, and such occasional causes, but acts reliably when it is chronic, related to age, long-term illness, or general intestinal blahs; a teaspoon of the root boiled in water three or four times a day." Use dandelion leaves in salad, or 1-2 teaspoons of dandelion vinegar or 10 - 20 drops of tincture taken with meals.

Chickweed as a laxative is controversial but not seemingly harmful. It would seem from the debate surrounding it that the worse that can happen while using chickweed for constipation is - more of the same. Varro Tyler heavily disparages its medicinal use "...there is no indication (in the "extensive scientific literature devoted to chickweed") that any of the plant's constituents possess pronounced therapeutic value; ... most writings concern various methods of controlling this pesky weed. (HeK comment: check this to see why Tyler isn't very respected as a herbal authority: <http://www.herbological.com/deconstructing.html>) " This is in sharp comparison to how Susun Weed sings this herb/weeds virtues:

"Those with digestive system problems crave plates of chickweed salad, for mineral-rich bulk and soothing, cooling energies to nourish their weak stomachs and bowels. Chickweed eases and helps those with yeast overgrowth, constipation, hard stools, hemorrhoids, stomach ulcers, intestinal

ulcers, colitis, internal inflammation, stomach cancer, and those healing after treatment for appendicitis, peritonitis, or the like." (Healing Wise, p 121).

Both Susun Weed and Deb Soule also recommend yellow dock root tincture as a remedy for constipation.

CONSTIPATION AS A MENOPAUSAL SYMPTOM

In *Wise Women's Ways for the Menopausal Years*, herbalist Susun Weed explains that "Menopausal constipation and indigestion are generally due to the slowing of the gastrointestinal tract (estrogen is a gastrointestinal stimulant) and heavy demands on the liver." Again yellow dock root, as vinegar or tincture, and dandelion are highly recommended. "Menopausal women will want to avoid the use of bran as a laxative in deference to building strong bones." Instead try prunes, figs, or rhubarb with maple syrup. Daily doses of 1 teaspoonful vinegar or 5 - 10 drops tincture of yellow dock eliminate constipation, indigestion, and gas. "Yellow dock is especially recommended for the woman who finds her early menopausal menses getting heavier."

PURGATIVE OR CATHARTIC LAXATIVES

Purgative laxatives is the category most utilized; and purgative herbs are used in healthfood store formulations and in many commercial over-the-counter laxatives. This group includes aloe, buckthorn, cascara sagrada, rhubarb, and senna. All the herbs in this category contain anthraquinones, strong and irritating chemical compounds that force the bowels to evacuate. They should be used only as a last resort.

Pregnant or nursing mothers should not use these irritants, nor should people with gastrointestinal problems including ulcers, ulcerative colitis, irritable bowel syndrome, and hemorrhoids.

Avoid the prolonged use of purgative laxatives. The continual use can cause lazy bowel syndrome. When this negative cycle develops the result is a sluggish digestive system unable to evacuate without the use of more laxatives. Studies also show that chronic over-use of constipation relieving drugs can lead to disturbances of the bodies electrolyte equilibrium. In turn this can result in potassium deficiency and a concomitant problem for those who are taking heart medications. ("In Germany, the law requires that the labels on all anthraquinone preparations must bear the warning that possible potassium deficiency can intensify the effect of chemical heart drugs -cardiac glycosides"; *The Family Herbal*, p.188)

The gentlest of this class of cathartic laxative herbs is cascara sagrada, known as "sacred bark" from a native American tree (*Rhamnus purshiana*). Michael Castleman says cascara sagrada is the "World's most popular laxative". Many herbalists claim that in addition to its laxative quality it also tones the intestinal tract and colon. It can be purchased in over-the-counter preparations or taken as a tincture (1/2 teaspoon at bed). Although a decoction (tea) is sometimes recommended, it is very bitter. It should never be used for more than 2 weeks, and a reputable source is important because unless the cascara is prepared correctly it can have negative side-effects. (Fresh bark cannot be used; the bark needs to be dried and stored for at least a year).

Dr. Weil, the well-known physician/author and lecturer, says "If you must use an irritant laxative, try rhubarb root (*Rheum officinale*). It is one of the safest and least violent, but it should be reserved for occasional use only. You can get preparations of rhubarb root in health food stores. (*Natural Health, Natural Medicine*, p 274)

Senna (*Cassia acutifolia*) is a bit stronger and also quite popular. It, too, is a main ingredient of many over-the-counter laxatives. Kathi Keville states that it is the most often purchased laxative herb in North America. And my perusal of over-the-counter laxatives supports this. In fact, the company that manufactures Ex-Lax recently updated its formula. Senna has replaced the key ingredient, the chemical phenolphthalein, which proved to have carcinogenic tendencies. Again, taste is a reason that herbalists might not recommend this remedy in its natural state. "The taste of senna is nauseating... herbalists generally discourage using the plant material and instead recommend over-the-counter products containing it."

Some herbalists recommend blends that pair the strongly bitter herbs with others that are better tasting and more easily tolerated. Kathi Kevilles approach is to combine the irritant herbs with tasty ones like peppermint, ginger, and fennel, that also relax the intestines and prevent cramping.

A commercial example of such a mixture is the blend Smooth Move sold by Traditional Medicinals. The main ingredient is senna, combined with licorice, and cinnamon, ginger, orange peel, fennel and coriander seed.

Another herb in this category, aloe, is even more problematic. Its popularity has recently increased and it is a wonderful herb to use externally for skin care. But because of its use, its name is becoming more known, and some people assume that because it is safe for one purpose, that it is ok to try for another reason. But this is not so!

A recent magazine article suggested drinking aloe vera juice on a daily basis. But many western herbalists do not recommend aloe as a laxative because it is too strong, although it has a history of use in Ayurvedic medicine. Michael Castleman in his popular book *The Healing Herbs*, has a headline under aloe, "Never a laxative". He says it is the "most drastic" of the cathartics and that it is least recommended "because it often causes severe intestinal cramps and diarrhea."

AYURVEDIC HERB MIXTURE

Dr. Andrew Weil suggests using Triphala, an herbal mixture from the Ayurvedic tradition. He says this mixture of three herbs is a "superior bowel regulator rather than a laxative,...take it regularly, it's benefits accumulate the longeryou stay on it." Available in health food-stores in capsule form, follow the directions on the label.

RECIPES FOR RELIEVING CONSTIPATION, compiled from some popular herbal guides

Constipation tea/tincture (Deb Soule, *The Roots of Healing*, p92)

Dandelion root 2 parts

Yellow dock root 1 part

Angelica root 2 parts

Burdock root 1 part

Ginger root 1 part

Licorice root 1/2 part

Place 7 to 8 tablespoons of herbs in 1 quart of water and simmer, covered for 30 minutes. Drink warm as needed. As a tincture, take 25-50 drops as needed. For chronic constipation, take 3x a week for 1 to 3 weeks.

Laxative Tea (Michael Moore, *Herb Formulas for Clinic and Home*)

3 parts Psyllium seed
3 parts Licorice root
2 parts Rhubarb root (*Rheum officinale*)
2 parts Senna pods, crushed
2 parts Angelica root
Drink as a simple tea/infusion in the evening.

Herbal Laxative Syrup - for adults (Kathi Keville, *Herbs for Health and Healing*, p 84)

1 teaspoon honey (or barley syrup or some other natural liquid sweetener)
2 teaspoons cascara sagrada bark tincture
1 teaspoon licorice root tincture
1/2 teaspoon tincture of fennel, ginger, or peppermint
Warm honey enough to make it liquid. Combine it with the remaining ingredients and stir well.
Take 1 teaspoon.

CHILDREN'S CONSTIPATION - Keville suggests tea (recipe below); elderberry jam; catnip enema; ground psyllium seed in juice; and slippery elm gruel. For children's constipation, Susun Weed suggests violet flower syrup.

Slippery Elm gruel - for children (Kathi Keville, *Herbs for Health and Healing*, p 221)

1 tablespoon slippery elm powder
3/4 cup water
1 teaspoon lemon juice (optional)
Combine powder and water in saucepan and heat until warm, stirring the mixture to prevent clumping. Add optional lemon juice for flavor. Can also sweeten the gruel with child's favorite herbal or fruit based sweetener. Child can drink entire amount (for every 50 lbs of body weight).
Drink before it cools - as gruel cools down, it thickens and the thicker it gets, the more likely your child will push it away.

Constipation Tea - for children (Kathi Keville, *Herbs for Health and Healing*, p.220)

1 cup boiling water
1/2 teaspoon licorice root
1/4 teaspoon ginger root (or fennel seeds)
1/4 cup apple juice (optional)
1/4 cup prune juice (optional)
Steep first 3 ingredients; strain; add juices. Recommended - 50 lb child, 1/4 cup every 2 hours "until a change for the better becomes apparent".

[Home](#) - [Herb FAQs](#) - [Articles](#) - [Classic texts](#) - [Archives](#) - [Links I like](#) - [Pictures](#) - [Plant names](#)





[Home](#) > [Herb FAQs](#) > [Medicinal herb FAQ](#) > [Processing herbs](#) >

[Medicinal herb FAQ: Intro](#) - [Single herbs](#) - [Herbs for specific things](#) - [Processing herbs](#) - [General info](#) - [Information sources](#) - [Schools](#) - [Related forums](#)

The Medicinal HerbFAQ

4.1 Making essential oil

This info is copyright by the Australasian College of Herbal Studies, Aromatherapy Certificate Home Study Course. Posted with permission.

>I would really be interested in finding out how to make essential oils.

From Dorene Petersen <dorenep.EUROPA.COM>:

The most important production method for Essential oils is distillation. The basic principle of distillation is the same but it is carried out in different ways depending on the botanical material and the condition of the material.

Three types of distillation are used:

1. Water
2. Water and steam
3. Direct steam

Distillation is basically, producing steam. The steam is passed through the herbal material. The steam carries the Essential oil from the plant in suspension which means the droplets of Essential oils are not dissolved in the steam but remain separate as droplets of oil. When the steam is cooled it reverts to the liquid state which is water and in most cases the oil floats on the surface of the water. The oil is then separated from the water by dripping or pouring.

1. Water distillation is used when the plant material has been dried and will not be damaged by boiling. It is also used for powdered materials such as powdered almond, and flowers, such as orange and rose, that need to float freely as they tend to lump together when just steam is passed through them. The material comes into direct contact with the boiling water and much care needs to be taken that the water does not boil away and cause the plant material to burn. Another example of an oil prepared by this method is turpentine gum. Turpentine gum is collected from a species of Pine (*Pinus palustris*) and the gum, wood chips and pine needles are placed in the distilling chamber with rain water. This mixture is heated until the plant and oil are condensed in the condensing chamber. Turpentine oil is not affected by very excessive heat.
2. The second method of distillation is water and steam. This is used for either fresh or dried

plant material that would be damaged by boiling. The plant material is supported on a perforated grid. The water level is below the grid and low pressure, wet steam passes through the plant material. The most important aspect of this method is that the steam is never really hot and always at low pressure. Cinnamon and clove oils are prepared by this method.

3. Direct steam distillation is similar to the second method but the steam is hotter and passed through the plant material at a higher pressure. This method is used for fresh plant material that has a high boiling point such as seeds, roots and wood. It is also used for fresh plant material such as peppermint and spearmint. The crop is cut and placed in a metal distilling tank on a truck. It is then taken to the distilling tank on the truck. Steam is forced through the fresh herbs and the oil droplets are carried by the steam through a vapor pipe at the top of the tank onto a cool condensing chamber.

Cold Pressing or Expression:

This method is mainly used to prepare citrus oils such as orange, lemon and tangerine. One method involves puncturing the oil glands by rolling the fruit over sharp projections that actually pierce the oil glands. The fruit is then pressed which removes the oil from the glands. It is then washed off with a fine spray of water.

The juice is extracted by another tube. The oil is then separated from the water by rotating it at a very high speed. Another method involves separating the peel from the fruits and then cold pressing them. The Essential oil is collected along with small amounts of juice, which is separated.

Enfleurage:

This is an old method which was used in the production of perfumes and pomade extracts for perfumery. Flower petals such as rose or jasmine are layered onto warm oils, cold fat or wax. This process is repeated each day until the base is saturated with the Essential oil. The resulting waxes or pastes contain up to 1 percent of Essential oil. The Essential oil is then extracted from the wax with a volatile liquid such as ethyl alcohol. In the final step the ethyl alcohol is evaporated at low temperatures and reduced pressure so that the pure Essential oil remains as a fairly thick liquid. Cold enfleurage has the advantage that even the most delicate components of the flower oils are preserved. The disadvantages are that it is not very effective and it is very expensive. Flower oils prepared with this method do not contain terpene-hydrocarbons, which indicates that these compounds are not present as such in the flower, but form during distillation.

Solvent Extraction

This is the most widely used modern method to prepare oils from flowers. The petals are mixed into a volatile solvent such as petroleum, ether or benzene, until the Essential oil is completely dissolved in the solvent. The solution is then filtered and the solvent is evaporated at reduced pressure. The result of solvent extraction is a concrete. The solvent is removed from the concrete by vacuum pressure without the use of heat to avoid any harmful effect to the oil. The concentrated essence that results is called an absolute. Absolutes are highly concentrated flower products without the natural waxes.

The main advantage of extraction over distillation is that uniform temperatures are maintained throughout the process. High temperatures during the distillation process can produce altered chemical composition of the oil which alters the natural odor. However, this method is expensive

compared to distillation, and chemicals or solvents used in the process may still be present after evaporation.

I know this is kind of lengthy but it is not a quick topic. Hope this helps.

Dorene Petersen

Australasian College of Herbal Studies 1(800)48-STUDY

[Home](#) - [Herb FAQs](#) - [Articles](#) - [Classic texts](#) - [Archives](#) - [Links I like](#) - [Pictures](#) - [Plant names](#)





Henriette's Herbal Homepage

[Home](#) > [Herb FAQs](#) > [Medicinal herb FAQ](#) > [Processing herbs](#) >

[Medicinal herb FAQ: Intro](#) - [Single herbs](#) - [Herbs for specific things](#) - [Processing herbs](#) - [General info](#) - [Information sources](#) - [Schools](#) - [Related forums](#)

The Medicinal HerbFAQ

4.2 Pointer to the How-to of Tinctures

Go get the latest edition of Michael Moore's Materia Medica from his WWW site:
<http://www.swsbm.com> .

If you wish to use anonymous FTP go to ibiblio.org or to sunsite.sut.ac.jp and cd to
[/pub/academic/medicine/alternative-healthcare/herbal-medicine/SWSBM/](ftp://pub/academic/medicine/alternative-healthcare/herbal-medicine/SWSBM/)

Go for the manuals.

A question on the herblist in November 97:

>Hi All, when it says on a bottle of tincture that the herb to menstruum ratio is (say) 1:5, is this by weight? volume? and then if it is (say) 60% alcohol, 40% water, does this mean that the 5 in the ratio is made up of 60% alcohol and 40% water?

>Also, how do you personally decide how much dried herb to put in that canning jar before you add the vodka? I've recently been thinking that I have probably been putting too much dried herb in, since in most jars it doesn't have an easy time sloshing around.

From Henriette:

A specification of 1:5 60% is most probably for **dried** herb. Weight the herb - let's say it's 100 g. The menstruum is by volume; metric is easier (for me)(1 g water = 1 ml), so to get 5 parts of menstruum you add 500 ml (= 1/2 liter) 60 % alcohol to the 100 g of herb. With dried herb you can either macerate or percolate. Maceration is the normal 'put herb in a jar, pour menstruum over, put lid on, leave 2-4 weeks, shake every day or two'. Percolation is faster, and actually quite easy, but the description of it is lengthy...

You'll want a reliable materia medica to get ratios and percentages for different herbs - a good one is available on Michael Moore's website at <http://www.swsbm.com> (go for the Manuals, go for the Materia Medica).

Fresh herbs are usually done at a ratio of 1:2 and 95 % alcohol - unless you use the 'simplers' -approach, which is to jam as much shredded herb as you can fit into a jar, cover it with 95 % alcohol, close the lid, wait a day, and top it up. Fresh herb is usually macerated.

The simplers approach doesn't give you very consistent quality from batch to batch, so most more

professional herbalists stick to given ratios and menstruum strengths.

[Home](#) - [Herb FAQs](#) - [Articles](#) - [Classic texts](#) - [Archives](#) - [Links I like](#) - [Pictures](#) - [Plant names](#)





[Home](#) > [Herb FAQs](#) > [Medicinal herb FAQ](#) > [Processing herbs](#) >

[Medicinal herb FAQ: Intro](#) - [Single herbs](#) - [Herbs for specific things](#) - [Processing herbs](#) - [General info](#) - [Information sources](#) - [Schools](#) - [Related forums](#)

The Medicinal HerbFAQ

4.3 Herbal Oils

From Dorene Petersen <dorenep.EUROPA.COM>:

I have made quite a lot of infused oils and the following is from the Aromatherapy Certificate Correspondence Course offered by the Australasian College of Herbal Studies.

It's not that technical but hope its helpful:

HOW TO PREPARE YOUR OWN INFUSED OILS AT HOME

There is nothing more satisfying than gathering a basket of fresh jasmine, honeysuckle or rose blossoms on a warm summers day and then preparing your own infused oil. There are three methods for preparing an infused herbal oil. You can use fresh or dried herbs. Flowers are best fresh, although the perfume of some flowers intensifies with drying such as gardenia, daphne and boronia. If using fresh, double the quantity as all recipes given are for dried herbs. If using fresh herbs for any of these methods leave the herbs to wilt for six hours to reduce their water content which will spoil the final product.

WATERBATH METHOD

15 gm (1/2 oz) dried or if fresh use 30 gm (1 oz) herb (this is the total amount so if you are using a blend make sure you do not have more than this)

1 cup of oil

Measure the herbs and oil and mix the oil to the herbs in a stainless steel bowl. Heat over water bath (a saucepan 1/4 filled with water) also known as a double boiler, which should be simmering. Make sure the bowl is not sitting on the bottom of the pot but is floating in the water. Keep the lid on the oil. Stir occasionally and simmer for 30 minutes. Watch the oil does not get too hot. It should not smoke or bubble. It can burn easily and will develop an acrid smell if it overheats, which is very difficult to disguise. Strain through four layers of butter muslin or some other very fine non-metal strainer. Strain twice if necessary as it is important to get all herbs out of the oil to prevent the herbal oil from going rancid or moldy. Essential oils can be added at this stage for perfume and added therapeutic benefits.

SOLAR METHOD

Use the same quantities of herbs and oil as for the waterbath method or approximately 3 tablespoons of finely cut herbs to 300ml (10 oz) of oil. The quantity of herb can be increased to produce a stronger oil. Put the herbs in a jar with a tight fitting lid and pour over the oil. Make sure the herbs are completely covered with oil. Add one tablespoon of apple cider vinegar or white wine to help break down the plant material. Leave the jar to sit in the sun all day and in a warm cupboard at night for two weeks. Strain through four layers of muslin. This process can be repeated two to three times to give a stronger oil. The final product should be strong enough to leave an aroma when massaged on the skin. Always test infused oils on the skin. Don't rely on just your nose.

CROCKPOT METHOD

Use the same quantities of herbs and oil as for Waterbath method. Place the herbs and oil in a crockpot and leave on a low heat for two hours. Follow the recipe above for straining.

TO PRESERVE OILS

This is only necessary if you are preparing large quantities that you intend to store.

1. Add 1/4 tsp. simple tincture of Benzoin to 1 cup vegetable oil. Tincture of Benzoin is prepared from the gum of an Indonesian tree, Styrax Benzoin. Make sure it is simple tincture of Benzoin. Compound tincture of Benzoin, also known as Friars Balsam, is not suitable.
2. Add 500 I.U. of natural mixed Tocopherols or Vitamin E to 1 cup of vegetable oil.

Dorene Petersen <dorenep.EUROPA.COM>

[Home](#) - [Herb FAQs](#) - [Articles](#) - [Classic texts](#) - [Archives](#) - [Links I like](#) - [Pictures](#) - [Plant names](#)





Henriette's Herbal Homepage

[Home](#) > [Herb FAQs](#) > [Medicinal herb FAQ](#) > [Processing herbs](#) >

[Medicinal herb FAQ: Intro](#) - [Single herbs](#) - [Herbs for specific things](#) - [Processing herbs](#) - [General info](#) - [Information sources](#) - [Schools](#) - [Related forums](#)

The Medicinal HerbFAQ

4.4 Balms and liniments

> Hi,I just wonder if anyone has any info about how to make your own balms and liniments.

From: Shannon Brophy <shannon.yoga.com>:

To make a liniment:

First infuse the plant in oil. Do this by baking at low heat (120-170 degrees) in a glass pan with herb and oil together, stir occasionally.

Then strain with cheesecloth and a funnel to separate plant material from the oil. Squeeze out the cheesecloth. Then grate beeswax and add to hot oil, maybe heating again over a double boiler on the stove. Pour the viscous green stuff into jars and allow to cool. Can keep in the fridge for a longer shelf life. Also, adding vitamin E oil to the mixture helps preserve it.

Shannon Brophy, Midwife

visit the Roots & Wings Website at <http://www.yoga.com>

From: Andy & Sharon <email.naturesway.ukonline.co.uk>:

One of the most popular liniments for muscle-, head- and backache is Tigerbalm.

Tradition will have it that the Mongolian Horsemen from Genghis Khan, roaming the plains of central Europe, had a very effective ointment against saddle and back ache. Part of this ointment came from the Siberian Birch Tree. A mixture was made out of lard, camphor and birch tree oil. For ages this ointment was in use and got quite famous.

At the end of the last century many products were replaced by synthetic components. The useful part of the birch oil (methyl salicylate) and the camphor oil (the crystals) were available in synthetic form. This made the ointment cheap and within reach for everyone.

A Chinese merchant composed a mixture of methyl salicylate, camphor crystals and petroleum jelly, which he called Tigerbalm. It became famous throughout the Orient and parts of Europe under this name.

How to make it: First you have to blend the oils. You can use the mix pure or add it to petroleum jelly (vaseline) later on to make a balm.

Tigerbalm Oil - Natural - Recipe 1

Wintergreen oil	45 ml
Camphor oil	15 ml
Eucalyptus oil	7 ml
Lavender oil	5 ml
Peppermint oil	8 ml
Almond oil	20 ml

Tigerbalm Oil - Natural - Recipe 2

Peppermint oil	25 ml
Camphor oil	15 ml
Wintergreen oil	20 ml
Lavender oil	15 ml
Eucalyptus oil	15 ml
Jojoba oil	10 ml

Tigerbalm Oil - Partly natural

Methyl salicylate	25 ml
Menthol crystals	5 g
Camphor crystals	10 g
Eucalyptus oil	10 ml
Lavender oil	5 g
Paraffin oil	45 ml

Tigerbalm

To make tigerbalm take 100 gram petroleum jelly (vaseline) (acid-free) and melt this by placing, for instance, a glass with vaseline in a pan of hot water. The vaseline will melt quickly.

Once melted place the glass in a pan of cold water, and as soon as the vaseline hardens again on the side of the glass, add 20 ml of your Tigerbalm oil mix. Stir until cool. If you prefer the balm to have a colour, add a drop of chlorophyll.

Apply a little bit to the forehead for headaches, or use it for muscle pains and insect bites.

>I find tiger balm/vaseline, to be too greasy for me. I created a simple rub for my lower back pain (due to herniated disk) that provides some relief. It consists of essential oil of Wintergreen and oil of St. John's Wort, added to a base of Aloe Vera gel.

>The Aloe Vera gel is non-greasy and absorbs completely (to the touch). This mixture also feels like it absorbs completely, and no staining of my clothes as of yet.

>Can I make the above "Tigerbalm", but use the aloe vera gel? As well, my herb book indicated that oil of wintergreen is good for pain and inflammation. Could you also post what the other herbs are targeted for?

From: email.naturesway.ukonline.co.uk to above:

I cannot see any reason why you should not use your gel; the vaseline is used to hold the oils together.

Here are some ways the oils react with your skin; as you can see lavender detoxifies, while eucalyptus vitalizes, peppermint refreshes etc.

Essential oils and how they affect your skin

1. GREASY SKIN

Sage : relaxes, improves blood circulation
Peppermint: refreshes, cools
Valerian : calms
Clove : disinfects
Camphor : Disinfects, sedating
Cypress : Refreshing, relaxing

2. UNCLEAN SKIN

Cajeput : Improves perspiration
Rosemary : Improves blood circulation
Valerian : Calming
Camphor : Disinfects, sedates

3. THICK, PALE AND WEAK SKIN

Oregano : Widens the blood vessels
Melissa : Refreshes, tonic
Geranium : Refreshing
Linden blossom : Soothing

4. INFECTED SKIN

Juniper : Disinfects
Lavender : Healing
Cajeput : Improves perspiration
Fir : Refreshes, regulates

5. SENSITIVE, THIN, QUICKLY IRRITATED SKIN

Cypress : Relaxes, refreshes
Pine : Balances, refreshes
Melissa : Against cramps
Chamomile : Sedating
Therebinth : Softening

6. TIRED SKIN

Lavender : Detoxifying
Eucalyptus : Vitalizing
Cajeput : Improves perspiration
Verbena : Calming
Lemongrass : Improves blood circulation

7. BODY CARE (GENERAL)

Oregano : Strengthening
Thyme : Disinfecting
Mint : Tonic

Geranium : Refreshing

[Home](#) - [Herb FAQs](#) - [Articles](#) - [Classic texts](#) - [Archives](#) - [Links I like](#) - [Pictures](#) - [Plant names](#)





The Medicinal HerbFAQ

5.1 Introduction to side effects, safety and toxicity of medicinal herbs

5.1 Introduction to side effects, safety and toxicity of medicinal herbs

- 5.1.1 [Medicinal plant actions cannot be reduced to the effects of their isolated 'active constituents'](#)
- 5.1.2 [Medicinal herbs act 'multi-systemically'](#)
- 5.1.3 [Herbs act on the healing processes in the body](#)
- 5.1.4 [Herbs act multi-dimensionally](#)
- 5.1.5 [Side effects vs. contraindications](#)
- 5.1.6 [Safety and toxicity of herbal medicines](#)
- 5.1.7 [Pregnancy](#)
- 5.1.8 [Understanding toxicity research - politics and ideology](#)
- 5.1.9 [Further reading](#)

by Jonathan Treasure <http://www.herbological.com>

This introduction concerns WESTERN medical herbs and their clinical use. Some herbal agents are common to different traditions but the indications and methods of use may vary between e.g. TCM, Ayurvedic and Western practices.

The purpose of these notes is to provide a general understanding of the actions of herbal medicines, and hence a background for understanding questions of safety and toxicity - NOT to provide a list of problematic herbs. A brief bibliography gives sources of reliable information on the safety of herbal medicine and further reading.

Conventional medicine considers that if a drug is to be effective, it will inevitably have side effects. The medical establishment considers herbal medicines as drugs, and as such, they must either have side effects - or ergo be ineffective.

Paradoxically tens of thousands of people every year turn to herbal medicine because they regard plant remedies as being free from undesirable side effects. Herbal medicines are considered to be generally safe AND effective agents.

Although there is a spectrum of viewpoints in western herbal medicine, most herbalists reject the view that plant medicines are naturally occurring analogues of the pharmaceuticals used in orthodox clinical medicine i.e. drugs.

This is ultimately a rejection of the dominant paradigm of orthodox clinical science. It is necessary to outline the elements of the alternative paradigm shared by most herbalists, before questions of toxicity and safety can be discussed in context of clinical herbal therapeutics, rather than of orthodox medical science

5.1.1 Medicinal plant actions cannot be reduced to the effects of their isolated 'active constituents'

There ARE a few plants that are almost "drug like" and whose action approaches that of pharmaceuticals. Digitalis is the classic example. Herbalists use these plants in near allopathic treatment strategies if at all, and in some countries e.g. UK, their availability is restricted by law. The number of herbs in this category is relatively few.

The vast majority of medicinal herbs contain dozens of different compounds, often of great complexity, mucilages, tannins, polysaccharides etc. that buffer, modulate and modify the effects of any "active principles". Study after study has shown that effects produced by extracts of whole plants cannot be mimicked by administering isolated purified constituents of the plant.

(It is ironic this proposition even has to be asserted given that biological sciences have for some time used a systems theory model in which the whole being greater than the sum of the parts is axiomatic - this simply reflects the inherent conservatism of the medical establishment. However for most herbalists the view of the whole being greater than the parts is derived from vitalism, not systems theory!)

5.1.2 Medicinal herbs act 'multi-systemically'

Pharmaceutical drugs are designed to elicit very specific reactions. Their associated "side effects" are undesired actions, usually traded as a "risk" against the "benefit" of the primary effect. Herbs tend to have several broad actions on a number of whole physiological systems at the same time. These actions are usually oriented in the same general therapeutic direction, and are usually complementary or synergistic, often non-specific, and very rarely adverse. Herb actions cannot be adequately described using the vocabulary of "drug" action terms, e.g. diuretic etc. - they are too

complex. The clearest example of this is the coining of the term "adaptogenic " used to describe the multiple non-specific effects of herbs such as Ginseng.

5.1.3 Herbs act on the healing processes in the body

A pharmaceutical drug addresses symptoms caused by specific disease mechanisms as understood by scientific pathology. Herbal medicines are directed towards aiding the body's own healing processes. These approaches are diametrically opposed. Herbal medicines act gently, usually attempting to "nudge" or "support" systems and processes that have become deficient or help remove excesses that have become preponderant. Symptom relief is only a component of herbal therapeutic strategy.

This is a crucial difference. For example, serum arthritic conditions are conventionally treated with steroid anti-inflammatory drugs. These have widespread and disturbing side effects, which at sustained high doses become intolerable and potentially dangerous if not lethal. The herbal approach to these conditions uses dietary modification of metabolism; facilitation of elimination via kidneys and hepatic/ biliary routes; stimulation of circulation in the affected regions, moistening of dry synovia, etc. Topical treatments for acute joint pain or systemic anti-inflammatory herbs that help joint pain are used as required, but this is not the thrust of the treatment strategy. Lay persons often make the related mistake of seeking a "natural alternative" to a pharmaceutical they have been prescribed rather than challenging the diagnosis and therapeutic strategy.

5.1.4 Herbs act multi-dimensionally

Herbal medicine is a wholistic therapy, it integrates mental, emotional and spiritual levels seamlessly into its understanding of both human function and of the plant remedy, while respecting the planetary and ecological dimensions of natural medicine provided by plants. Although subject to differing interpretations this view is held in one form or another by most herbalists .

Life style, mental, emotional and spiritual considerations are part of any naturopathic approach, herbalism included. Flower essences, homeopathic preparations and drop doses of standard herb extracts all demonstrate that herbal agents can produce consistent and powerful effects at subtle levels in ways quite inexplicable by the pharmacokinetic model underlying orthodox pharmacology.

Centuries of medicinal plant usage overarch even the Graeco - Roman heritage of medical thought, itself already forgotten by its amnesiac infant technological medicine, extending into magical, esoteric and religious domains of prehistory. The great Asian systems of medicine have continued

uninterrupted for thousands of years to today, integrated into profound cosmological and philosophical systems. From any serious study of the application of herbs to healing a perspective emerges that reveals modern doctors to be tragically "like educated peasants running around pretending to be chiefs" (Grossinger).

5.1.5 Side effects vs. contraindications

Many herbalists would tend toward the radical homeopathic view that the "side effects" of orthodox medicine are in fact iatrogenic developments of the very disease for which the pharmacological intervention was intended. The symptoms simply change, and the real underlying dysfunction is further obscured - or driven further into the interior to manifest in deeper and more intractable ways.

Notwithstanding this iatrogenic view of side effects, we have seen that the use of herbs anyway does not generally involve "drug" actions or adverse effects. Of course, if the body processes are nudged in the wrong direction for long enough, then imbalances can worsen rather than improve. Hence the need for informed knowledge of the effects of herbs as well as a clinical training to understand their appropriate medical application. Herbalists learn about the **CONTRAINDICATIONS** as well as the indications for using a herb. This term is more useful and appropriate than "side effects".

CONTRAINDICATIONS are incongruences between the metabolic/systemic predisposition (constitution) of the individual - and the spectrum of multi-systemic actions of a given herb agent or class of agents. Essentially, herbalists use their in depth knowledge to devise a mix'n'match prescription tailored precisely to fit an individual's unique profile. This approach is most sophisticated in the tonic energetics of the Oriental medical traditions, but is empirically applied by most herbalists.

Contraindicated remedies can account for apparently idiosyncratic "bad reactions" to a herb. Valerian is a classic example, its powerful autonomic effects can make it "disagree" with stressed adrenergically hyperactive individuals, who paradoxically are often those seeking sedative treatment for insomnia. Anyone experiencing such reactions to a herb for more than a couple of days should stop taking it and seek further advice. However a second and vital aspect of contraindications especially today is the question of **DRUG INTERACTIONS**.

Many people seeking herbal medical treatment are already involved in pharmaceutical therapies. Herbal remedies may act either as agonists or potentiate some drug therapies, and an understanding of conventional drugs is an essential prerequisite for effective herbal therapeutics. In many cases, herbalists would not treat the primary presenting symptom undergoing drug treatment - be it ulcers treated with Zantac or cardiac arrhythmia treated with Digoxin - but rather concentrate on supporting other systems and functions stressed by the primary symptom. This allows the body to recover its strength and healing potential so it can then direct these capabilities toward repairing the presenting condition. In other cases, it can be a priority to wean someone off drugs, e.g. steroids, in which case supportive therapy to restore adrenal function is vital.

5.1.6 Safety and toxicity of herbal medicines

The definition of *toxic* is ultimately a matter of viewpoint. Many ordinary foods contain constituents that could be regarded as poisonous, such as the alpha gliadin produced by gluten in wheat oats and rye, the cyanogenic glycosides in many fruit seeds, the thiocyanates of the brassica vegetables, alkaloids of the Solanaceae and lectins of many pulses including soya and red kidney beans. Nonetheless these foods are generally regarded as safe. Similarly, both water and oxygen - can kill in excessive amounts, so quantity is often an important consideration. In practice however, three groups of herbs can be identified from a safety point of view.

Firstly there are a handful of herbs that contain near pharmaceutical concentrations of poisonous constituents which should on no account be taken internally by unqualified persons except in homeopathic potencies. Examples are *Atropa belladonna*, *Arnica* spp, *Aconitum* spp, *Digitalis* spp. In many countries availability of these herbs is limited by law. Regulations vary from country to country and the appropriate regulatory authorities or Herb Organisations can be consulted for details. Wildcrafters should be unshakably confident in their identification of the local variants of these species, and children warned to avoid them. Fortunately this is a numerically tiny category.

Secondly, are herbs with powerful actions, often causing nausea or vomiting, (that usually were traditionally prized for this action). They are perfectly safe used under appropriate conditions. Some of these herbs are restricted in some countries but freely available in others. *Lobelia* and *Eonymus* spp are examples. There is some inconsistency here, for example *Ephedra* is restricted, perhaps with justification, in the UK, but is freely available in the US.

Finally, there is an idiosyncratic grouping of herbs which have been alleged, with some scientific support, to exhibit specific kinds of toxicity. The best known is the hepatotoxicity of pyrrolizidine-alkaloid-containing plants such as *Comfrey* (*Symphytum*). Other examples are *Dryopteris* (Male Fern), *Viscum* (Mistletoe) and *Corynanthe* (*Yohimbe*). Although much of the evidence is contentious (see below), lay users would be advised to avoid internal consumption of these herbs.

The vast majority of medical herbs are safe for consumption, but for those without specialised knowledge, it would be prudent to follow simple but sensible guidelines in self treatment:

- Use only herbs recommended in respected herb books, especially in countries like the US where there are few restrictions on availability.
- Avoid new or unproven *wonder remedies*.
- Do not persist with a remedy if no benefit or result obtains after a moderate period, and if adverse reactions take place, stop the treatment and seek experienced advice.
- Do not persist with a treatment that has brought improvement without testing to see if continued further consumption is necessary to maintain improvement.
- Do not engage in self treatment for complex conditions without experienced advice. Drug interactions and contraindications must be considered on an individual basis and herbal treatment strategies are often involved and multifaceted.

Unfortunately, training and licensing of herbalists is not internationally consistent. In the US the situation is especially complex - no recognised herbal licensing exists. ND's are licensed in a few states, but their herbal training could theoretically be less than that of an unlicensed but experienced herbal practitioner. In the UK, the NIMH accredits herbalists who have trained at approved courses: practitioners are recognised by MNIMH or FNIMH qualifications.

5.1.7 Pregnancy

It is axiomatic that pregnancy should be a time of minimal medical intervention, and herbalists in particular regard pregnancy as a "contraindication" to taking herbal medicines. Nutritive "food herbs" such as nettle, and uterine tonics such as raspberry leaf are encouraged, and perhaps gentle treatments against typical symptoms such as constipation or morning sickness are in order. There is NO evidence of teratogenicity in humans arising from herbal remedies, but since such evidence would be hard to come by, erring on the side of caution is regarded as prudent.

5.1.8 Understanding toxicity research - politics and ideology

Medical orthodoxy at best does not understand herbal medicine, and at worst, sees it as a threat which it attempts to rubbish, regulate or ridicule. Quackery has a fascinating role in the history of medicine and its institutions, but much of the hostility towards herbal medicine comes from its apparently greater proximity to orthodoxy than say acupuncture or homeopathy. This is the unfortunate political context in which toxicity and safety of herbal medicines are debated.

Additionally, both professional herbalists and regulatory authorities exhibit differing degrees of education, organisation and aptitude in different countries. In the United States, the situation is particularly lamentable, with scare mongering stories regularly aired in medical, scientific and popular press, whilst the lack of accredited professional herbalist training means that well intentioned self-appointed spokespersons for herbalism can cause more harm than good, and the quixotic federal regulatory stance on herbs as foodstuffs means that the potential of lay self-iatrogenesis with freely available OTC herbal products is a serious possibility.

Toxicity of herbal medicines needs to be seen in context however. As Paul Bergner, Editor of the journal *Medical Herbalism* and author of several articles on herbal toxicity recently pointed out:

*Approximately 8% of all hospital admissions in the U.S. are due to adverse reactions to synthetic drugs. That's a minimum of 2,000,000. At least 100,000 people a year die from them. That's just in the U.S., and that's a conservative estimate. That means at least three times as many people are killed in the U.S. by pharmaceutical drugs as are killed by drunken drivers. Thousands die each year from supposedly "safe" over-the-counter remedies. Deaths or hospitalizations due to herbs are so rare that they're hard to find. The U.S. National Poison Control Centers does not even have a

category in their database for adverse reactions to herbs.*

Similar figures apply in the United Kingdom, and even hepatotoxicity, where perhaps the strongest case against some herbs lies, the statistics are horrendously clear - over 80% of cases of fulminant hepatic failure presenting for liver transplant (or death) over ten years in the UK were due to poisoning by freely available OTC non-prescription NSAID's, such as paracetamol and aspirin. Not one case was due to ingestion of medicinal herbs.

For the lay person, analysis of so called "scientific evidence" about toxicity is clearly problematic. Some of the most useful sources of information are to be found in review presentations made by representatives of the herbalist community to regulatory authorities such as the FDA or MCA. Informative reviews of the literature in defence of Comfrey and Mistletoe have been made in this way.

Herbalists justifiably point out that scientific studies with isolated compounds, on non human or even non mammalian organisms, or in vitro, with doses tens or even hundreds of times the equivalent medicinal dose, simply have no arguable extrapolation to the clinical situation using whole herb at appropriate medicinal doses.

Lack of herbal knowledge by some scientific investigators (let alone journalists or self appointed defenders of the public) leads to often ludicrously misleading results - one of the commonest mistakes being the failure to verify the actual identity of plant material used in their experiments, let alone the detection of contaminants!

These points beg the question of what paradigm can be used for research into the safety and efficacy of herbal therapies. That shibboleth of orthodoxy - the double blind placebo controlled clinical trial is open to a range of criticisms from the paradigm employed by herbalists - but that, as they say, is another story.

5.1.9 Further reading

HERBAL /MEDICAL CONTRAINDICATIONS:

Synergistic and Iatrogenic Potentials when some herbs are used concurrent with Medical Treatment or Medical Health Care by Michael Moore, 1995, on line at <http://www.swsbm.com>

HERB INFORMATION RESOURCE:

The Information Source book of Herbal Medicine: David Hoffmann, Crossing Press 1994.

TOXICOLOGY:

Brinker F : An Introduction to the Toxicology of Common Botanical Medicines, NCNM 1983
AMA Handbook of Poisonous and Injurious Plants AMA, Chicago 1985
NAPRALERT database at UIC.

Example REVIEWS OF PROBLEMATIC HERBS:

In Defence of Comfrey: EJHM1.1 1994 11-17
The Case For Mistletoe: EJHM1.1 1994 17-22

EJHM = European Journal of Herbal Medicine (see the entry on periodicals, [6.3.2](#))

HISTORY:

Planet Medicine - Richard Grossinger, North Atlantic Books 1990

The Magical Staff, Matthew Wood North Atlantic Books, Berkely 1992

GENERAL HERB BOOKS:

(as in [6.1](#)):

J.A. Duke, CRC Handbook of Medicinal Herbs.

C. Hobbs, many booklets.

D. Hoffmann, The Herbal Handbook.

S. Mills, Out of the Earth: The Essential Book of Herbalism.

M. Moore, Medicinal Plants of the Mountain West.

M. Moore, Medicinal Plants of the Desert and Canyon West.

M. Moore, Medicinal Plants of the Pacific West.

R.F. Weiss, Herbal Medicine.

[Home](#) - [Herb FAQs](#) - [Articles](#) - [Classic texts](#) - [Archives](#) - [Links I like](#) - [Pictures](#) - [Plant names](#)





Henriette's Herbal Homepage

[Home](#) > [Herb FAQs](#) > [Medicinal herb FAQ](#) > [General info](#) >

[Medicinal herb FAQ: Intro](#) - [Single herbs](#) - [Herbs for specific things](#) - [Processing herbs](#) - [General info](#) - [Information sources](#) - [Schools](#) - [Related forums](#)

The Medicinal HerbFAQ

5.2 Wildcrafting Ethics

5.2 Wildcrafting Ethics and similar things

- 5.2.1 [Wildcrafting checklist](#)
- 5.2.2 [How do I find out about endangered plants \(in the USA\)?](#)
- 5.2.3 [What plants shouldn't I pick?](#)
- 5.2.4 [United Plant Savers](#)

by Howie Brounstein (<http://www.teleport.com/~howieb>) (posted with permission)

This are the guidelines I teach to my students. It is copyrighted material that took me years to develop. Please respect this copyright. I ask you not to publish it without permission. Happy Herbing.

5.2.1 Wildcrafting checklist

- Do you have the permission or the permits for collecting at the site?
- Do you have a positive identification?
- Are there better stands nearby? Is the stand big enough?
- Are you at the proper elevation?
- Is the stand away from roads and trails?
- Is the stand healthy?
- Is there any chemical contamination?
- Is there any natural contamination?
- Are you in a fragile environment?
- Are there rare, threatened, endangered, or sensitive plants growing nearby at any time of the year?
- Is wildlife foraging the stand?

- Is the stand growing, shrinking, or staying the same size?
- Is the plant an annual or a perennial?
- Is tending necessary and what kind?
- How much to pick?
- Time of day? Time of year?
- What effect will your harvest have on the stand?
- Do you have the proper emotional state?
- Move around during harvesting.
- Look around after harvesting. Any holes or cleanup needed?
- Are you picking herbs in the proper order for a long trip?
- Are you cleaning herbs in the field? Do you have the proper equipment for in-field processing?
- **Wildcrafting is stewardship**

c1993hb

5.2.2 How do I find out about endangered plants (in the USA)?

Check your local Heritage Program Database, call the Dept. of AG or a local Native plant society chapter to find its address. This will connect you to experts on particular plants and current lists.

The endangered species act has many flaws, I personally believe there should be an endangered ecosystems act instead but it's all we've got and better than nothing.

Some listed plants are truly rare, once numerous but destroyed by loss of habitat through man or nature.

Many listed plants are endemics, located in a specific area. These may be geographically isolated islands of flora as are often found in the intermountain west, or they can be found at the border of major plant systems. Many endemics are found in southern Oregon, where the Northern California system blends with the Pacific Northwest system, with a spattering of Great Basin plants. This does not mean these plants are sensitive, just unique. The threatened *Penstemon peckii* grows only within twenty miles of my house, and nowhere else on earth.

It can withstand trampling, wildlife grazing, and disturbance. In fact, now that the forest service has realized that this species thrives with moderate disturbance (partial cuts), it has become a reason to log, i.e. increased health of the population of this plant.

Plants become listed due to political boundaries. *Gentiana newberryi* grows nearby, and is threatened in Oregon. It's northernmost sighting is within a half hours drive. There you can see people play football on it, run horses on it, pick its beautiful flowers only to find they wilt

immediately, and then the flowers end up on the ground.

Sometimes hundreds of them. Elk graze it heavily. It isn't a sensitive plant, and it's population is healthy and stable in California, but the population happens to cross over to Oregon where there isn't that many stands. Thus it receives the same protection as the truly rare plant. Southern Oregon has many of these kinds of listed plants.

There has to be a perceivable threat to the plant population in order for it to be listed. Sometimes the threat is obvious, and sometimes the threat is obscure.

What about an introduced plant that has become a pest, or a native out of control in a system out of balance. When the St. John's Wort, *Hypericum perforatum*, is down to a handful of populations, it will fit the definition of threatened, even though humans intentionally eradicated it!!

5.2.3 What plants shouldn't I pick?

Some plants are not damaged easily. Blackberry (*Rubus* sp.), and Dandelion (*Taraxacum officinale*), are two that are nearly impossible to eliminate, even if you dig their roots. If a piece of root stays in the ground, it will grow back. Yarrow (*Achillea millefolium*), can be cut with a lawnmower and still flourish regularly. Nettles (*Urtica dioica*), when grown for fiber can have 3-4 aboveground harvest in a growing season. Plants that fit into this category are generally perennials. You can pick them and not threaten their survival.

Rare, Threatened and Endangered Plants

Endangered plants are species in danger of becoming extinct in the foreseeable future. Threatened plants are likely to become endangered in the foreseeable future. A species can be threatened or endangered throughout its range, which means if it goes extinct we will lose its hidden secrets forever.

Many of these plants only grow in one special area (endemic). The Columbia Gorge on the border of Oregon and Washington hosts many endemic species. Peck's Penstemon, *Penstemon peckii*, grows only in the Ponderosa Pine Forest in Deschutes and Jefferson Counties. A species can also receive protection for part of its range. Newberry's Gentian, *Gentiana newberryi*, has stable populations in California, but is listed as threatened in Oregon. Deschutes County is at the end of its range, and there are less of them. Rare plants have small, localized populations. They may not be listed as threatened or endangered if the populations are both stable and numerous.

The US. Fish and Wildlife Service determines which plants receive federal protection. Unfortunately, they are very slow in reviewing candidate species.

Many have become extinct while waiting to be listed. The Department of Agriculture and the Department of Fish and Wildlife of each state is responsible for determining state protection. We also have the Oregon Natural Heritage Program. This program has its own list of plants that deserve protection, but haven't made it into the clogged federal and state lists. They also have a list of plants to watch and monitor. A copy of Rare, Threatened and Endangered Plants and Animals

of Oregon is available from:

The Oregon Natural Heritage Program
1025 NW 25th Avenue
Portland, Oregon 97210
(503)-229-5078

Do not pick these plants. Unfortunately, they are not always easy for an amateur to identify. They are not always showy. There may be large amounts of them in one spot, so that they appear plentiful.

There are some good picture books available. All folks who pick plants from the wild should try to familiarize themselves with the local protected plants. When in doubt, don't pick it.

Sensitive Plants

Some plants are sensitive to disturbance. Please do not pick them even if they aren't protected. The Calypso Orchid, *Calypso bulbosa*, is a fragile plant that lives partially off leaf mold. Its little root is close to the surface, and easy prey to slugs and others. Minor disturbances can easily dislodge the root from the mold. If someone picks its flower, it can ooze fluid and essentially "bleed" to death. Even disturbing the area around it during flowering could kill it. The law does not protect this plant because it is too numerous.

It is our responsibility to help sensitive plants survive.

How can you tell if a plant is sensitive? Most plants that are not green (contain no chlorophyll) are "no picks." These weird species are white, brown, red, or purple and just plain eerie. Botanists call them parasites or saprophytes. They are particularly fascinating. These include Broomrape, *Orobanche* sp., Coral Roots, *Corallorhiza* sp., and Indian Pipe, *Monotropa uniflora*. Other "no picks" include the Orchid Family (Orchidaceae) and almost all the Lily Family (Liliaceae). The Orchid Family includes Calypso Orchid, *Calypso bulbosa*, and the Rein Orchids, *Habenaria* sp. The Lily Family includes Trillium, *Trillium ovatum*, and Mariposa Lilies, *Calochortus* sp. These families are easy to recognize with a little practice. Not every Lily and Orchid is sensitive, but it's a good place to start.

Most (but not all) of the unusual or showy plants are no picks. If you are not sure, don't harvest it.

Howie B
Columbines and Wizardry Herbs
Eugene, Or USA

5.2.4 United Plant Savers

From Gregg Pond <gpond.integ.micrognosis.COM>:

United Plant Savers - Statement of Purpose

These are exciting times for herbalists. The current "herbal renaissance" in American health care is accompanied by an ever growing demand by the American public for herbs and herbal products. While positive on one hand, this situation has endangered a unique new set of problems for the wild plant world and for herbalists who love plants.

The pressure on our wild medicinal plant communities is growing yearly. Vast numbers of plants have been and continue to be taken, and indiscriminate wild harvesting has devastated many areas of former abundance. Perhaps even more disturbing, native North American medicinal plants are being exported to meet the demand in other countries, where wild plant populations have already been gravely depleted.

United Plant Savers was formed in a spirit of hope, as a group of herbalists committed to protecting and re-planting threatened species and to raising public awareness of the plight of our wild medicinal plants. Our membership reflects the great diversity of American herbalism and includes wildcrafters, seed collectors, manufacturers, growers, botanists, practitioners, medicine-makers, educators, and plant lovers from all walks of life.

Our Goals

- Identify and compile information on threatened medicinal plants in each state and/or bioregion.
- Make this information accessible to herbal organizations, communities and individuals.
- Provide resources for obtaining seeds, roots, and plants for replanting and restoration.
- Secure land trusts for the preservation of diversity and seed stock for future propagation efforts.
- Raise public awareness about the tragedy of over-harvesting and the current plight of native wild herbs.
- Identify and disseminate information on the therapeutic alternatives to threatened species.
- Encourage more widespread cultivation of endangered medicinal plants and greater use of cultivated plants.
- Develop programs for school systems and communities to re-plant threatened plant species back into their native habitats.

For more information see this: <http://www.unitedplantsavers.org>

[Home](#) - [Herb FAQs](#) - [Articles](#) - [Classic texts](#) - [Archives](#) - [Links I like](#) - [Pictures](#) - [Plant names](#)





[Home](#) > [Herb FAQs](#) > [Medicinal herb FAQ](#) > [General info](#) >

[Medicinal herb FAQ: Intro](#) - [Single herbs](#) - [Herbs for specific things](#) - [Processing herbs](#) - [General info](#) - [Information sources](#) - [Schools](#) - [Related forums](#)

The Medicinal HerbFAQ

5.3 Different schools of Herbal Healing

5.3 Different schools of Herbal Healing

- 5.3.1 [Traditions in Western Herbal Medicine](#)
 - 5.3.2 [Ayurveda - an introduction](#)
 - 5.3.3 [Pointers to homeopathy sites etc.](#)
 - 5.3.4 [What is Traditional Chinese Medicine?](#)
 - 5.3.5 [Flower essences](#)
 - 5.3.6 [Aromatherapy intro](#)
-

5.3.3 Homeopathy sites:

Check these sites:

The Homeopathy Homepage: <http://www.homeopathyhome.com>

<ftp://ftp.ibiblio.org/pub/academic/medicine/alternative-healthcare/> faqs/homeopathy (an olde document from the stoneage - 1993 or so...)

The homeoinfo -pages: <http://www.homeoinfo.com/> pretty good. Check, for instance, the Materia Medica section on Common questions: "Contaminating pills by touching them".

Homeopathy online is good, too: <http://www.lyghtforce.com/HomeopathyOnLine/index.html>

[Home](#) - [Herb FAQs](#) - [Articles](#) - [Classic texts](#) - [Archives](#) - [Links I like](#) - [Pictures](#) - [Plant names](#)





The Medicinal HerbFAQ

5.3.1 Traditions in Western Herbal Medicine

by Peter Cook, DBTh, FETC

This Article is taken from The Herbalist, newsletter of the Canadian Herbal Research Society. COPYRIGHT June 1989.

Thanks to Jonathan Treasure for sending this one over.

The Development of Theory in North America

Introduction: To one trained as a medical herbalist in Britain, it is a curious fact that herbal medicine, as it seems to be most widely known in Canada and the U.S., has been so little influenced by the great systems of herbal thought which once flourished here. Only remnants of these systems can now be found in the writings of Kloss, Christopher, Shook and others whose primary sources appear to be the European and native North American folk traditions.

These folk traditions are very valuable medical resources in their own right; a fact which has been recognized and supported by the World Health Organization (1978). It has also been recognized and increasingly exploited by the pharmaceutical industry. Folk medicine however, is also important as a rich source for the periodic historical development of major systems of traditional medicine. Examples of the development of two such systems in North America will be discussed here, together with some of the more important theoretical and practical contributions to herbal medicine which these systems generated.

Early American Folk Medicine: Eleanor Sinclair Rohdes (1922) has written very eloquently of the hardships faced by early American settlers in their efforts to cultivate the familiar medicinal plants of England and Europe. In many cases it seems these efforts failed completely and the pioneers were forced to supplement their folk medicine traditions with lore relating to indigenous plants obtained from the native people. To the extent that any special knowledge would have been likely, then as now, to remain a closely kept secret by the native medicine societies, it is probable that the native plant-lore passed onto these settlers was a matter of common knowledge amongst the native people. In fact, it may be said that a distinguishing feature of any folk tradition is that the lore contained in that tradition is, or has once been, common knowledge.

Another distinguishing feature of folk medicine, regardless of its historical or ethnic origin, is that the indications for the use of individual remedies are always given in terms which refer to specific

symptoms or illnesses. Thus, comfrey (*Symphytum officinale*) is said to be useful in healing fractures, while white horehound (*Marrubium vulgare*) is recommended for cough. Typically, such lore has been handed down from generation to generation, often for hundreds if not thousands of years. Each new generation learns at first hand the look and 'feel' of particular symptoms and illnesses. They learn which plants may be used to treat these illnesses, and the best methods for collecting, preserving and administering them. Such a tradition is entirely dependant upon repeated experience and observation; usually only minor changes can be detected in these traditions over relatively long periods of time.

Thomsonianism: The popular medicine of all peoples however, has always given rise to, and been counterbalanced by a more specialized type of knowledge, acquired by individuals who have devoted their entire lives to the study and practice of healing. As resource persons, these individuals have served their communities by providing access to that specialized knowledge in circumstances where the more common folklore was insufficient to meet the needs of the moment.

A very popular figure in early American medicine, who managed to combine native and settler folklore with a more specialized approach, was Samuel Thomson (1769-1843). Thomson came from a farming family and evidently learned some of the 'root and herb' practice at an early age. Later, he seems to have become an avid reader of medical literature and was particularly impressed with the Hippocratic writings.

Probably as a consequence of his regard for Hippocrates, Thomson believed that medicine should be based exclusively upon observation. The formulation of theories, he felt, prevented ordinary people from taking responsibility for the care of their own health, and that theories obscured the simplicity and made a needless mystery of medicine.

Thomson himself however, after 'long observation and practical results', borrowed theory from Hippocrates and used it as a basis to explain the 'why and how' of his own medical system. According to this theory, disease was the result of a decrease or derangement of the vital fluids, brought about by a loss of animal heat. The resulting symptoms were interpreted as efforts of the Vital Force to rid itself of the toxic encumbrances thus generated. Essentially, treatment was aimed at restoring vital energy and removing disease-generated obstructions. In specific terms, Thomson believed that in restoring vital heat by means of steam baths and cayenne (*Capsicum annum*), toxins which obstructed health would be thrown into the stomach where they could be eliminated by emetics such as *Lobelia inflata* (Griggs, 1981).

This simple theory constituted a dramatic departure from pure folk medicine in that it recognized and sought to treat an underlying, fundamental cause of illness. Moreover, in perceiving symptoms as an expression of the organism's defensive efforts, this theory implied that the treatment of symptoms and illnesses, per se, might actually hinder the healing process. It is interesting to note that Thomson believed this theory was quite complete and needed no further refinement or extension. Nevertheless, despite his vehement opposition, Thomsonianism became a potent influence on the development to two major streams of thought within American herbalism.

Eclecticism: The earliest of these was 'Eclecticism', founded by a man who had originally apprenticed to an old German non-Thomsonian herbalist, and who later qualified as a 'regular' medical doctor. Although the founder of this system, Wooster Beach (1794-1868), had been horrified by the 'regular' medicine of his day, and fervently wished for radical reform,

Thomsonianism had impressed him negatively in two ways. First, Beach was keenly aware of the bitter antagonism which Thomson had roused in the regular medical profession. As a result he decided to attempt reform (unsuccessfully as it turned out) from within, rather than as another medical 'outsider'. Secondly, Beach was disgusted by Thomson's evident arrogance in thinking that no further learning could possibly enhance the practice of herbal medicine.

Beach was well acquainted with the developments then taking place in such fields as chemistry, physiology, pathology and even botany. He was also quick to realize that this new thinking might have a valuable role to play in botanic practice, and began to move in this direction with the creation, in 1829, of his own school of 'Reformed Medicine'.

In terms of the study of medicinal plants, Beach's orientation resulted in the development and proliferation of an entirely new style. Eclectic monographs on individual herbs became more formal and typically included notes on the plant's chemistry, toxicology, physiological and therapeutic actions, as well as appropriate forms of preparation and dosage (e.g. King, 1900). Later Eclectic physicians became increasingly interested in obtaining preparations which represented the entire chemistry of the original plant as closely as possible. Although this preoccupation had near-disastrous consequences in at least one instance (Griggs 1981a), in general their research supported and developed the fundamental position of the value of using whole plant preparations rather than isolated extracts of a particular plant constituent (Lloyd, 1910).

Eclecticism was also a major contributor to herbal medicine in other areas. Beach himself, for instance, realized the fundamental importance of the blood and circulatory system in maintaining health, and began to develop herbal methods for 'equalizing the circulation'. Several valuable techniques used in the modern herbal treatment of fevers are probable directly attributable to Beach's work.

A later physician by the name of W.H. Cook (1879) expanded on this work in his correlation of the functions of the nervous and circulatory systems. Cook also developed a concept which related illness to deviations in trophic (i.e. structural) and/or functional tone. According to this view, disease consisted of excessive or diminished tone in organs, or in the functions of those organs. Corresponding herbal approaches to the correction of these kinds of imbalance were also eventually developed (Priest & Priest, 1982).

Another major development fostered by Eclecticism, was the clinical emphasis placed on treating a group or pattern of symptoms, usually with small doses of only one so-called 'specific' remedy. As the pattern of symptoms changed with the progress of disease, a new and more currently appropriate remedy would be indicated (Felter, 1922; Lloyd 1927).

Perhaps significantly, this approach was and is still fundamental to the practice of homeopathic medicine, which was rapidly becoming the most popular of all medical systems in the U.S. during the mid-19th century (Coulter, 1973). In fact Hahnemann (1810), the founder of homeopathy, had already written at some length concerning the relative merits of prescribing for what he called the 'Totality of symptoms', versus the treatment of individual symptoms or named diseases. The use of small doses of a single remedy was also an established fundamental tenet of homeopathy (e.g. Kent 1900).

Prescribing for patterns of symptoms had also been typical in traditional Chinese medicine for

many generations. Clear examples of the fluidity of prescribing in accord with changes in symptom patterns may be found in the Chinese classic, 'Shang Han Lun' (Hsu & Peacher, 1981). However, although the use of a single remedy is an established technique within Chinese medicine under certain circumstances, Chinese herbal prescribing more often involves the use of formulae (e.g. Bensky & Gamble, 1986).

Physiomedicalism: The second major stream of thought in American herbal medicine, which arose directly out of the Thomsonian movement, was 'Physiomedicalism'. Although not so heavily influenced by the developing sciences as Eclecticism, the originator of this 'neo-Thomsonian' movement, Alva Curtis, felt, like Beach, that Thomson's resistance to theoretical development was a mistake.

Above all, Curtis wanted to open a school based upon Thomsonian principles, but encouraging a freer atmosphere for broader intellectual enquiry and learning. In 1835, despite Thomson's opposition, Curtis realized his ambition and opened the 'Botanico-medical School and Infirmary' at Columbus, Ohio. As evidence that he was not alone in his thinking, during that same year, a colleague opened the 'Southern Botanico-Medical School' in Georgia (Griggs 1981b).

Ultimately this new system of herbal medicine retained much of what had been accepted as fundamental in the Thomsonian theory. Thus, organic function was thought of as the aggregate expression of Vital Force, acting through cellular metabolism to maintain the functional integrity of the entire organism. Illness was seen as a disordered response at the cellular level, brought about by internally or externally generated toxic obstructions. Essentially, treatment remained a matter of supporting the efforts of the Vital Force, and of eliminating the toxic encumbrances which hindered those efforts.

A significant departure from Thomsonian thinking however, came with the recognition that some symptoms represented positive, eliminate and reconstructive efforts of the Vital Force, while others resulted from physical impediments to those efforts. If treatment was to be directed to the underlying cause of illness, therefore, symptoms which expressed a purely functional disorder had to be distinguished clinically from those produced by organic changes in cells and tissues.

Eventually it was also realized that the organism was capable of establishing a compensatory equilibrium in which toxic encumbrance would be tolerated to a degree, in order to maintain a relative functional integrity. This was a major step forward in understanding and had important implications for herbal therapeutics. Certain symptomatic crises which had been observed, particularly in the context of treatment with herbal alteratives and eliminatives, could now be explained and avoided.

Another significant development in Physiomedical thinking was stimulated through the work of W.H. Cook (see above). If health could be understood as the unimpeded and balanced function of all cells and tissues, then it was clear that the blood and circulatory system played a vital role in maintaining health, both in terms of nutrient delivery, and of waste and toxin transport to eliminative organs.

Cook had shown that, in addition to the quality of the blood itself, the chronic relative contraction or relaxation of tissues and particularly arterioles and capillary beds could also have serious consequences. Cellular function, and eventually cellular structure, could be strongly influenced by

a relative excess or deficiency of blood and tissue fluid. Further, as understanding of human physiology increased it became obvious that hyperaemia in one part of the body would necessarily imply a relative ischaemia elsewhere.

The implications of this thinking for herbal medicine were threefold. Firstly, herbs which acted to increase or decrease tone in the three primary divisions of the circulatory system (arterial, capillary and venous) had to be distinguished. Secondly, the general, portal and pulmonary aspects of circulation had to be considered in treatment, as did the distinction between visceral and somatic components. Thirdly, the circulation to particular organs and tissues had to be taken into account, not only to support or modify the related functions, but also to restore normal trophic conditions, where possible.

The achievement of these goals became much more accessible following the work of J.M. Thurston (1900), which stressed the regulatory importance of the autonomic nervous system. Thurston made many important contributions to Physiomedical thought in the areas of diagnosis, prognosis, treatment and, perhaps especially, in the area of herbal pharmacy. A number of aspects of his work, and of Physiomedicalism in general, have been described by Priest & Priest (1982a).

Even by the close of the 19th century, Physiomedicalism could be described as a system which emphasized the role of herbal remedies in supporting Vital Force, balancing the circulation to various tissues, modifying and enhancing body functions, restoring optimum trophic or structural conditions, and in eliminating toxic encumbrances (Mills, 1985).

Unfortunately, the publication of the Flexnor report in 1910 and the subsequent forced closure of the 'irregular' medical schools put an end to any further developments of the kind described here in American herbal medicine (Cody, 1985; Gort, 1986).

Conclusion: Curiously, despite the slightly more open attitudes which prevailed in Canada (e.g. the government regulation of naturopathy on Ontario, 1925; Govt., 1986), neither the Eclectics nor the Physiomedicalists seem to have moved north across the border. In fact both systems, together with a version of Thomsonianism, had been taken to England where they were eventually integrated into one system of professional herbal medicine, regulated by law and still taught in the U.K.

In Canada and the U.S. however, only traces remain of these once influential and effective systems. The Dominion Herbal College in British Columbia for instance, has referred in its course notes to the need for 'equalizing the circulation' (1969). References can also be found in these notes and elsewhere to 'relaxing' or 'stimulating' herbs (i.e. plants capable of increasing or decreasing functional tone). The importance of supporting vital force and of eliminating accumulated toxins is also still widely recognized and practised. Nevertheless, there are probably few today however, who can apply physiomedical principles in distinguishing for instance, those lung, bowel and kidney conditions respectively requiring relaxing or stimulating expectorants, laxatives and diuretics.

Due principally to repressive legislation, herbalists in North America must once again rely heavily on folk traditions as their major source of learning and inspiration. It should be noted here that much of the valuable herbal lore once utilized widely by native North Americans is now known by only a small

handful of native elders (PC. 1988). It is very fortunate therefore, that Canadian and American herbalists have preserved some of this knowledge in their own practices.

Folk medicine traditions are virtually impossible to legislate against directly, and even in the recent Ontario government recommendations, treatment of oneself and one's family had been specifically exempted from prosecution under the proposed legislation (HPLR, 1989). Direct legislation however, was not the only factor contributing to the decimation of native culture and the virtual loss of their traditional healing knowledge.

The proposals tabled in the Ontario legislature will almost certainly impose or support severe restrictions on the cultivation and/or sale of medicinal plants, should they be passed into law. Furthermore, such legislation will definitely prevent or seriously delay the free development and re-emergence of a professionally oriented system of herbal medicine in Ontario.

Consequently, those who choose to make use of this 'valuable medical resource' (W.H.O., 1975a), will be forced to rely on their own experience and to gather and use only wild plants. This assumes however, that environmental policies in Ontario and the rest of North America will not poison even this source in the very near future.

References

- Bensky, D., Gamble, A. (Compl. & Ed.) Chinese Herbal Medicine Materia Medica; Eastland Press; Seattle, 1986.
- Cody, G. 'History of Naturopathic Medicine', in A Textbook of Naturopathic Medicine, Pizzorno, J.E.; Murray, M.J.; John Bastyr College Pulos, Seattle, 1985.
- Cook, W.H. The Science and Practice of Medicine; 1879 - quoted in Priest & Priest, *ibid.*
- Coulter, H. Divided Legacy: a history of the schism in medical thought Vol. 111. McGrath Pub. Co., Washington, D.C., 1973.
- Dominion Herbal College, Home Study Notes, 1969.
- Felter, H.W. The Eclectic Materia Medica, Pharmacology and Therapeutics, Scudder, Cincinnati, 1922.
- Gort, E.H. A Social History of Naturopathy in Ontario: the formation of an occupation; M.Sc. Thesis; Univ. Toronto, 1986.
- Griggs, B. Green Pharmacy, a history of herbal medicine; J.Norman & Hobhouse Ltd.; London, 1981.
- Hahnemann, S. Organon of Medicine. 1810; 6th Ed. Trans. Hahnemann Foundation; Victor Gollancz Ltd.; London, 1983.
- HPLR, Striking a New Balance: a Blueprint for the Regulation of Ontario's Health Professions', Government of Ontario. 1989.
- Hsu, H.; Peacher W.G.(D) (Trans. & Ed.) Shang Han Lun; Oriental Healing Arts Institute; Los Angeles, 1981.
- Kent, J.T. Lectures on Homoeopathic Philosophy: 4th Indian Reprint, B. Jain Publishers; New Delhi, 1977.
- Kings's American Dispensatory; Felter & Lloyd, 1900; Reprinted by National College of Naturopathic Medicine; Portland (undated).

- Lloyd, J.U. Fragments from an Autobiography, a paper read at the 63rd meeting of the Ohio Eclectic Medical Assoc., Arkon, May, 1927; Eclectic Medical Journal, 1927.
- The Eclectic Alkoloids. LLB no. 12, Pharmacy Series 2, P41; 1910.
- Mills, S. The Dictionary of Modern Herbalism; Thorsons Pub. Gp.; Wellingborough, New York, 1985.
- Personal Communication, Art Solomon and other Ojibwa Elders; Native Elders Conference, Trent Univ., Peterborough, 1988.
- Priest, A.W.; Priest, L.R. Herbal Medication, a clinical and dispensary handbook; Fowler & Co. Ltd.; London, 1982.
- Rohde, A.C. The Old English Herbals, 1922; 3rd Ed. Rohde, E.S.; Minerva Press Ltd; London, 1974.
- World Health Organization The Promotion of Traditional Medicine; Technical Report Series No. 622; Geneva, 1978.
- W.H.O. Document EB/57/21, Training and Utilization of Traditional Healers and Their Collaboration with Health Care Delivery Systems; Nov. 1975.

[Home](#) - [Herb FAQs](#) - [Articles](#) - [Classic texts](#) - [Archives](#) - [Links I like](#) - [Pictures](#) - [Plant names](#)





The Medicinal HerbFAQ

5.3.2 Ayurvedic Medicine - an introduction

by Dr. Duane Weed, D.C. (drweed.delphi.com)

The Ayurvedic system traces its roots to the Himalayan Mountains of India over five thousand years ago. According to legend, a conference was held in a Himalayan cave in which the greatest sages of India--some after having traveled thousands of miles--met to discuss their knowledge of their healing arts. These scholars and teachers possessed traditional knowledge about the medicinal plants of India that had been handed down orally by the tribes of the Indian forests since the beginning of history. At this conference, these sages compared and combined their knowledge into one body which they called the Ayurveda, from two Sanskrit words; Ayus, or "life", and Veda, or "knowledge". "Ayurveda" has been translated as "the knowledge of life", and as "the science of life". It has been suggested that a more appropriate translation would be "the knowledge of life span".

After this historic conference, the Ayurvedic knowledge was passed orally from teacher to student for over a thousand years, continuously growing as each Ayurvedic physician added his insights and experiences. It was finally written down in the first century A.D. by the Ayurvedic physician, Charaka.

By that time--and hundreds of years before the birth of European medicine--Ayurveda had specialists in psychiatry, pediatrics, gynecology, ear nose and throat, ophthalmology, surgery, toxicology, virility, and fertility.

Ayurvedic medicine probably predates any other healing tradition in existence today--even Chinese medicine. Even before the Ayurvedic conference, knowledge of the medicinal plants of India had spread to other continents. Seeds from plants indigenous to India have been found in the tombs of the Egyptian pharaohs. Travelers had carried information about Indian plants through Tibet into China, and Arabs had traded for Indian herbs before the birth of Islam.

At the time of King Solomon, the Queen of Sheba traded herbs and spices of India to the Israelites. Ayurvedic medicine began to be studied by Arab physicians and knowledge of the plants of India was passed on to the Greeks and Romans. By the first century A.D., when Charaka was writing Ayurveda's first written records, Pliny was already describing the plants of India to the Roman Empire in his NATURAL HISTORY. And much more recently, as any American school child can tell you, a Portuguese sailor by the name of Christopher Columbus discovered America in 1492, while searching for a trade route to India to acquire her herbs and spices.

According to Ayurvedic philosophy, health is dependent upon one's ability to live in harmony with one's self and with the external universe. As much attention was given to illnesses of the mind as to illnesses of the body.

The Ayurvedic physician taught that in order to avoid illness and pain, the patient must control the destructive (and self-destructive) nature. Living in harmony with the environment was recognized as essential to one's mental, physical, and spiritual well-being.

Ayurvedic physicians taught that prevention was more desirable than a cure. Their ideal was to develop an individual's natural resistance to disease to the point where one's immune system could function as one's best medicine.

Their goal was to maintain an individual in his or her optimal health throughout life, so that the ultimate goal of life--the awareness of his or her connection with the life principle--could be pursued.

Today's Ayurvedic physicians, like their predecessors, recognize three major body (or physiology) types which they refer to as the three DOSHAS: VATA, PITTA, and KAPHA. One's body type is also referred to as one's PRAKRITI, and is determined by heredity. Most people are actually a combination of types; a VATA/PITTA type for example. Ayurvedic physicians evaluate their patients using such techniques as observation, interview, and pulse diagnosis to determine the patient's body (or physiology) type. They then determine the imbalances that are present in the body and make recommendations according to the patient's body type. Dietary and herbal recommendations make up a large part of their treatments; but many other techniques such as meditation, hatha yoga, aroma therapy, and music therapy are also employed.

Thanks to the Ayurvedic tradition, many herbal combinations based on centuries of accumulated knowledge are available to today's eclectic herbalists and natural health enthusiasts. Ayurvedic herbal formulations, like Chinese herbal formulations, are combinations of many different herbs that work synergistically. Single herbs are rarely if ever employed. Even though there are competent Ayurvedic physicians in practice today, one does not have to see an Ayurvedic physician to use an Ayurvedic herbal combination, as long as the recipe of an Ayurvedic master is carefully followed.

Some of the most common herbs currently used in Ayurvedic formulations are:

Acacia catechu, *Adhatoda vasica* (Vasaka), *Andrographis paniculata*, *Aegle marmelos* (Bel), *Alpina galanga*, *Alstonia scholaris*, *Apium graveolens*, Ashwagandha root, *Azadirachta indica* (Margosa), *Boerhaavia diffusa* (Hogweed), *Boswellia serrata*, *Caesaipinia crista*, *Clerodendrum indicum*, *Commiphora mukul* (Indian Bedellium), *Curcuma longa* (Turmeric), *Cyperus rotundus*, *Enicostemma littorale*, *Fumaria parviflora*, *Glycyrrhiza glabra* (Liquorice), *Gymnema sylvestre*, *Hedychium spicatum*, *Hemidesmus indicus* (Ind. Sarsaparilla), *Holarrbena antidysenterica*, *Inula racemosa*, *Momordica charantia* (Bitter Gourd), *Myrica nagi*, *Ocimum sanctum* (Holy Basil), *Paederia foetida*, *Phyllanthus emblica*, *Picrorhiza kurroa*, *Pimpinella anisum*, *Pistacia integerrima*, *Pterocarpus marsupium*, *Rubia cordifolia* (Indian Madder), *Sida cordifolia*, *Smilax china*, *Swertia chirata*, *Syzygium cumini* (Jamun), *Terminalia belerica*, *Terminalia chebula* (Chebulic Myrobalan), *Tinospora cordifolia*, *Trachyspermum ammi*, *Tribulus terrestris*, *Trigonella foenum-graeceum*, *Vitex negundo*, *Withania somnifera* (Winter Cherry), *Zingiber officinale* (Ginger)

REFERENCES AND ADDITIONAL READINGS:

- THE GARDEN OF LIFE, AN INTRODUCTION TO THE HEALING PLANTS OF INDIA by Naveen Patnaik, Doubleday, New York, 1993.
 - PERFECT HEALTH, THE COMPLETE MIND/BODY GUIDE by Deepak Chopra, M.D., Harmony Books, New York, 1991.
 - PERFECT WEIGHT, THE COMPLETE MIND/BODY PROGRAM FOR ACHIEVING AND MAINTAINING YOUR IDEAL WEIGHT by Deepak Chopra, M.D., Harmony Books, New York, 1994.
 - RESTFUL SLEEP, THE COMPLETE MIND/BODY PROGRAM FOR OVERCOMING INSOMNIA by Deepak Chopra, M.D., Harmony Books, New York, 1991.
 - RETURN OF THE RISHI by Deepak Chopra, M.D., Houghton Mifflin Company, Boston, 1988.
-

From Robert Hensley (Hensleys.aol.com):

Ayurveda is the world's oldest science of health care. The written tradition dates back around 5,000 years, but the oral tradition in India is timeless.

The basic principles of Ayurveda include:

1. Mind, body, emotions, and spirit are more than connected, they are one.
2. There are 3 fundamental principles of nature: called Vata, Pitta and Kapha, which govern all processes in all levels of our life.
3. Vata governs all movement, Pitta all heat and transformation, and Kapha all growth, structure and lubrication.
4. Everything we experience influences these governing principles.
5. If these principles that guide the processes of our body, mind, etc get "out of balance" due to poor diet, activity, etc. they can become overactive, and disease results.
6. If vata gets out of balance, for instance, it leads to overactive mind, poor circulation, poor nerve conduction, loss of memory, irregular elimination, uncomfortable menses, etc. - all things related to movement.
7. If pitta is out of balance, we can get excessive digestive fire, resulting in heartburn, excess stomach acid, a hot temper, inflammations, etc. -all things related to heat and digestion.
8. If kapha gets out of balance, it can lead to chronic congestion, weight gain, cellulite, cholesterol buildup, acne, oily skin, etc. - all things related to structure and lubrication.
9. Herbs in synergistic combination, diet, routine, meditation, etc are used to restore balance to restore proper operation of the various systems. Balance restores health.
10. Ayurveda does not focus on decreasing symptoms, it focuses on increasing health. Where there is health, there is no room for disease.
11. Symptoms are only used as one of eight ways to determine the underlying imbalance or weakness that has allowed the disease to occur.

Due to foreign intervention in India for hundreds of years, Ayurveda became fragmented, and it

has been revived over the past 35 years by Maharishi Mahesh Yogi. As a result of growing scientific verification at major research institutions, it is the worlds' fastest growing health care system.

[Home](#) - [Herb FAQs](#) - [Articles](#) - [Classic texts](#) - [Archives](#) - [Links I like](#) - [Pictures](#) - [Plant names](#)





[Home](#) > [Herb FAQs](#) > [Medicinal herb FAQ](#) > [General info](#) >

[Medicinal herb FAQ: Intro](#) - [Single herbs](#) - [Herbs for specific things](#) - [Processing herbs](#) - [General info](#) - [Information sources](#) - [Schools](#) - [Related forums](#)

The Medicinal HerbFAQ

5.3.4 What is Traditional Chinese Medicine?

From Suzanne E. Sky, L.Ac. (avena.aloha.net)

Traditional Chinese Medicine is a phrase used to describe a complex system of medicine developed in China that has now spread around the world in its various forms. This system is over 3,500 years old. Its fundamental basis is a philosophy which views humans as a microcosm of the universe and inherently connected to it, to Nature and to all Life.

Chinese Medicine is actually a part of what is called Oriental Medicine, because there are many different styles practiced, with the same origins and medical foundation, in China, Japan, Korea and other Asian countries. This medicine spread to America and Europe as practitioners migrated and settled in different countries. Now Oriental Medicine is practiced and taught all around the world.

I. HISTORY & CURRENT USE

The history of Chinese Medicine is very long, complicated, and fascinating. There have always been many different styles of practice and theories of medicine in China. The early Communist leaders destroyed much of the old information but finally decided that Chinese Medicine was a valuable method. The principles were simplified and began to be taught in colleges. Before this, Chinese Medicine was passed down through generations of families, through apprenticeship and training that began at a young age. Now there are several well established Colleges in China that train Chinese Medicine practitioners. Westerners can study there as well. In Chinese hospitals, Chinese Medicine is practiced alongside modern Western Medicine. For example, cancer patients in China receive radiation treatment or chemotherapy, and they also receive Chinese herbal medicine to ameliorate the side effects.

II. WHAT MODALITIES DO CHINESE MEDICINE PRACTITIONERS USE?

Chinese Medicine is a large area of study and practice. Some of the modalities it includes are:

- Herbal Medicine: An advanced and effective system of herbal medicine.
- Acupuncture & Acupressure: Use finger pressure or special fine needles to harmonize and activate the body's own healing ability.
- Moxibustion (moxa): Special therapeutic warming techniques.

- Diet & Nutrition: A unique and effective system which teaches the energetic qualities of food and how it effects us.
- Chi Kung and Tai Chi: Systems of movement and breathing that promotes health. Chi Kung is also an ancient healing method.
- Tui Na: Chinese medical massage

Practitioners are trained in several or many of these modalities and specialize in one to a few areas of expertise.

III. SCHOOLING AND PRACTICE

Many schools in America and Europe are fully accredited and confer Master's Degrees in Oriental Medicine. Schooling takes 4 to 6 years. The requirements include Western science and medical courses along with about 2,000 hours in Chinese Medical Theory, techniques and practice. This includes in-depth study of Acupuncture, Chinese Herbal Medicine, and other modalities. In addition, anywhere from 800 to 1,200 hours of clinical observation and internship are required in an acupuncture clinic. The traditional way of learning, apprenticeship, is still in existence, but is less common today. In America about 20 states certify or license Acupuncturists for practice, through an examination process. There are over 30 schools in America and many schools and practitioners in Europe.

IV. ACUPUNCTURE IS RECOGNIZED BY THE WORLD HEALTH ORGANIZATION

The World Health Organization (WHO) recognizes over 250 illnesses successfully treated by acupuncture and the list continues to grow. Among these are included: PMS (pre-menstrual syndrome), gynecological disorders, anxiety, depression, arthritis and joint problems, colds, flus, sinusitis, cough, bronchitis, headaches, numbness and poor circulation, stress, fatigue, recovery from injuries.

V. QUESTIONS TO ASK YOUR ACUPUNCTURIST

- How and where (or with whom) did they study? (School or apprenticeship)
- How long was their training? Currently some health professionals can attend what amounts to a weekend class and then practice acupuncture under their medical license. They may know where to stick a few needles, but they are not trained in Oriental Medicine.
- What modalities do they use?
- How long have they been practicing?

VI. INTERNET RESOURCES

A great Acupuncture page with lots of resources: <http://www.acupuncture.com/>

Foundation for Traditional Chinese Medicine: <http://www.ftcm.org.uk/>

[Home](#) - [Herb FAQs](#) - [Articles](#) - [Classic texts](#) - [Archives](#) - [Links I like](#) - [Pictures](#) - [Plant names](#)





Henriette's Herbal Homepage

[Home](#) > [Herb FAQs](#) > [Medicinal herb FAQ](#) > [General info](#) >

[Medicinal herb FAQ: Intro](#) - [Single herbs](#) - [Herbs for specific things](#) - [Processing herbs](#) - [General info](#) - [Information sources](#) - [Schools](#) - [Related forums](#)

The Medicinal HerbFAQ

5.3.5 Flower essences

From Suzanne E. Sky, L.Ac. (avena.wave.net)

Flower essences are liquid preparations, containing only minute traces of actual flowers, which convey the vibrational pattern and essence of specific flowers. Because of this, their action is subtle and extends beyond the physiological. Their action is not biochemical, but is vibrational. These gentle essences enjoy a reputation of being very safe. They have no side-effects and are non-toxic. Some people state they don't 'feel' any change or effect from using flower essences. However, many people find the flowers provide an essential factor in their healing process. Each person responds to flower essences according to their inner rhythm and needs.

Research in the modern field of psychoneuroimmunology shows a clear interrelationship between physical illness, stress and emotional/mental outlook. Flower essences help address issues which often underlay stress and health problems, helping to 'untie' or release these mental/emotional energetic knots. Flower essences can help transform emotions, attitudes or patterns of behavior to enhance one's development, growth and awareness. Flower essences expand our understanding of health care, recognizing the interweaving of spiritual, mental, emotional and physical aspects of wellness. The name most closely associated with flower essences is that of Dr. Edward Bach, the English physician who first discovered them. In the 1930's, he introduced his set of 39 Flower Essences that changed the world of natural medicine forever.

Dr. Bach's Life and Discovery of Flower Essences

Dr. Edward Bach was a remarkable man. He was an early pioneer of natural medicine who discovered results when he treated the person rather than the disease. Born in 1886, Bach entered the medical profession from a sincere desire to help others. Early on in his practice he noticed that the patients personality or temperament was more helpful in deciding which medicine would be most effective than any other factor.

Early in his career, Bach studied bacteriology and became fascinated by the connection between a person's colon flora and their health. He discovered that a vaccine made from the patient's intestinal bacteria, and injected into their blood stream, gave excellent results, especially in chronic diseases. When Bach discovered homeopathy, he modified his method and made homeopathic preparations known as nosodes (remedies made from pathological tissues). He classified the

intestinal bacteria into seven main groups and made preparations still known today as Bach's Seven Nosodes. Soon, he found that when a patient entered his office, he could immediately tell which type of flora would be predominant in that person, and which nosode they would need. From this Bach correlated seven main personality types and began prescribing the Nosodes solely on the basis of the patients personality, rather than laboratory tests. The results were even greater than he expected, and he saw clearly the importance of treating the person rather than their disease.

While Bach had great respect for homeopathy and its founder, Dr. Hahnemann, he refuted the basic premise of homeopathy, that like cures like. Bach states "It is obviously fundamentally wrong to say that 'like cures like'. ...Like may strengthen like, like may repel like, but in the true healing sense like cannot cure like.And so in true healing, and so in spiritual advancement, we must always seek good to drive out evil, love to conquer hate, and light to dispel darkness. Thus must we avoid all poisons, all harmful things, and use only the beneficent and beautiful."

(Collected Writings, page 113)

Bach became dissatisfied with using the intestinal Nosodes, desiring to find a natural method which would not require using pathological material. He felt herbs would provide the most suitable material and began investigating the plant world. As Bach continued to work with and observe people, he became even more convinced that a person's temperament and personality were the factors that determined what illnesses they were prone to and what medicines would help them.

The first two plants he discovered and used in his practice, that are still flower essences today, were Impatiens and Mimulus. The third one was Clematis. This was in 1930. Bach was so pleased with the results, he decided to give up his use of nosodes altogether and seek out other herbal remedies to add to his repertory. Dr. Bach gave up his successful, lucrative and prestigious Harley Street office and set out for Wales to discover new healing plants. Little did he know he was about to discover a whole new form of natural medicine and herbal preparation.

Tromping around Wales for many years led him to discover the remaining 36 flower remedies. Bach was very particular in his selection of flowers and where he found them. Each of his remedies is a specific botanical entity, and substitutions are not equally effective. Bach was a sensitive as well as a medical researcher and physician. This blend made him search out only non-toxic plants that offered the highest vibratory patterns. Of the 39 essences we attribute to Bach, 37 are from plants, trees and bushes. One remedy, Rock Water, is from a special spring. The 39th, is a combination of several remedies, used for acute and emergency situations.

Bach found great results using the flower essences with people who came to him from all over. No matter what illness the person had, he only gave remedies in accord with their mental/emotional state of being. Bach himself became ill several times and only recovered after discovering and using the appropriate flower essence. He discovered several essences in this way.

Dr. Bach died in his sleep in 1936, feeling his life work was complete. He stated that the 38 flower essences he discovered would cover every possible area of need. His goal was to discover a safe, effective system of medicine that even the simplest person could use to help themselves, without a doctor. He felt he achieved this goal with his system of the Flower Remedies, which anyone can learn and apply with a little study.

IMPORTANT NOTE

Flower essences work most beneficially as part of a wholistic program of health care, including exercise, nourishing diet, stress reduction, inner work, play, and rest. They are not a substitute for medical attention or professional psychological counseling. If you are ill, please consult a qualified physician.

This entry was much longer - but this is the medicinal herbFAQ, not the flower essence FAQ, so for the full entry go to this page: <http://ibiblio.org/herbmed/neat-stuff/bachflow.html>

[Home](#) - [Herb FAQs](#) - [Articles](#) - [Classic texts](#) - [Archives](#) - [Links I like](#) - [Pictures](#) - [Plant names](#)





[Home](#) > [Herb FAQs](#) > [Medicinal herb FAQ](#) > [General info](#) >

[Medicinal herb FAQ: Intro](#) - [Single herbs](#) - [Herbs for specific things](#) - [Processing herbs](#) - [General info](#) - [Information sources](#) - [Schools](#) - [Related forums](#)

The Medicinal HerbFAQ

5.3.6 Aromatherapy intro

From: Marcia Elston <samara.wingedseed.com> - <http://www.wingedseed.com>

What is Aromatherapy? Aromatherapy is a true medical science and is the skilled use of specific essential plant distillates (essential oils), singularly or in combination, for health and well being.

How Does Aromatherapy Work? The essential plant distillates (essential oils) interrelate with the human body within four distinct modes of action, pharmacological (as phytopharmaceuticals), physiological (physically and chemically), psychological (affecting mental states and processes) and incorporeal (spiritual). Our body uses the aromatic molecules (essential oils) both (1.) through our olfactory system which is connected to the limbic system in the brain where our most primal feelings, urges and emotions reside, (2.) and by inhalation and skin absorption of the low weight molecular structure of essential oils. Aromatherapy works best within a holistic approach to wellness.

Is Aromatherapy New? We know from the study of ancient manuscripts that priests in India some 4,000 years ago practiced aromatherapy very much like it is practiced today. Modern Ayurvedic medicine includes an aromatic component that has evolved from this ancient practice. Scent was very important to ancient Egyptians who used plant-oil infusions, gums and resins, as well as aromatic herbs and flowers in rituals, relaxation and skin care extensively in their culture. Modern aromatherapy, as we know it today, was revived in 1910 by the French chemist, Gattefosse, after having been badly burned in a laboratory explosion and plunging his arm into a nearby vat of lavender essential oil. The amazing speed of recovery and lack of scarring led him into a lifetime study of essential oils and their medicinal uses for skincare.

Can I Do This Myself? Most essential oils have been approved as G.R.A.S. (generally regarded as safe when used by various trades at their normal levels of use). However, these standards were developed by the food and perfume industries and were not developed specifically for the use of essential oils in aromatherapy. Aromatherapy, as a medical healing modality, has been in existence in England and parts of Europe for quite some time, and the United States is fast developing a similar model, however there is at present no FDA approval for the use of essential oils medicinally. An individual can use essential oils themselves (self medication) provided they are thoroughly familiar with the uses, safety precautions and contraindications and have available thorough and accurately referenced information on the potential hazards associated with using

essential oils.

SAFETY FIRST! Essential oils are very potent and strong concentrated plant constituents (chemicals). Always keep essential oils out of reach of children and pets. Do not apply undiluted essential oils directly to the skin. Avoid contact with eyes and mouth and other tender mucous membranes. Essential oils should never be taken orally. Essential oils are flammable and should be kept away from fire or flames. Some essential oils can cause dermatitis; always do a skin test with 2% dilution before applying to large area. Some oils are not recommended by use in infants and very young children, pregnant women, persons with epilepsy, hypersensitive individuals, just to name a few. Some essential oils can cause photosensitivity. Some essential oils may not work well when taking prescription drugs. Be well informed before you use any essential oil. The best manual on the market for the safety data of essential oils is *The Aromatherapy Practitioner Manual* by Sylla Sheppard-Hanger. This reference of over 350 plant extracts, in two volumes, includes an index of biologically active phytochemicals, clinical index and taxonomical index and is a must for anyone seriously considering using aromatherapy intelligently and effectively. When not used properly, essential oils can be harmful and they should never be used indiscriminately.

Where Can I Learn More? There are numerous and rapidly emerging educational programs and home study courses being offered throughout the United States and Canada. Here is a short list.

Valerie Cooksley, Principal Instructor

The Institute of Integrative Aromatherapy <http://www.aroma-rn.com>

Issaquah, WA

Dr. Kurt Schnaubelt, Principal Instructor

Pacific Institute of Aromatherapy <http://www.pacificinstituteofaromatherapy.com>

San Rafael, CA

Sylla Sheppard-Hanger, Principal Instructor

The Atlantic Institute of Aromatherapy <http://www.AtlanticInstitute.com>

Tampa, FL

Michael Scholes, Principal Instructor

Michael Scholes School of Aromatic Studies <http://www.michaelscholes.com>

Los Angeles, CA

Laraine Kyle, Principal Instructor

The Institute of Integrative Aromatherapy <http://www.aroma-rn.com>

Boulder, CO

Jade Shutes, Principal Instructor

The Institute of Dynamic Aromatherapy <http://www.theida.com>

Seattle, WA

Dorene Petersen, Principal

The Australasian College of Herbal Studies <http://www.herbed.com>

Portland, OR



Henriette's Herbal Homepage



[Home](#) > [Herb FAQs](#) > [Medicinal herb FAQ](#) > [General info](#) >

[Medicinal herb FAQ: Intro](#) - [Single herbs](#) - [Herbs for specific things](#) - [Processing herbs](#) - [General info](#) - [Information sources](#) - [Schools](#) - [Related forums](#)

The Medicinal HerbFAQ

5.4 The Ames Test

>[Does anyone know more about this Ames test?](#)

The Ames test cultures mutations of bugs (usually *Salmonella* spp) that are unable to grow without the amino acid histidine and adds suspected mutagens to the culture medium (after incubating them with liver extract to expose them to lysosomal activity). If the bugs then grow, the mutation is deemed to have reversed (ie they now synthesise histidine) and the test substance is regarded as (ultimately) mutagenic. It is the case that the majority of known chemical carcinogens are also mutagens according to the Ames Test.

The problem is that also according to the Ames Test the prevalence of environmental mutagens is so high that the human population should long ago have been wiped out by cancer if the extrapolations were correct. (The extrapolations being histidine gene mutagenicity equals ultimate carcinogenic action, and salmonella bugs equals people.) This is of course acknowledged by pathologists - but seems not to be understood by the rank and file scare mongers who like to appear to be *scientific* in their attacks on herbalism.

jonno.teleport.com (Jonathan Treasure)

From: Kevin Jones <100621.17.CompuServe.COM>

There are several drawbacks to the Ames test which basically make it worthless on its own.

Firstly carcinogens are divided into those which require to be metabolised in a cell (activated) and those which don't. Obviously the metabolism of a bacterial cell is going to differ from that of a mammalian cell. Compounds which are activated in a bacterial cell may therefore show no activity in a mammalian cell and vice versa.

Secondly carcinogens act by reacting with genetic material. The type which are metabolically activated generally form free radicals which then react with DNA. Many carcinogens have an affinity for a specific sequence of nucleotides. Obviously the number of sequences that are shared between mammals and bacteria are going to be very small! There may well be many chemicals which cause mutations in bacteria but which have absolutely no effect on mammals.

In short, all the Ames test does is show that a chemical produces a mutation in *Salmonella*

bacteria. It might possibly indicate the potential for being carcinogenic in higher organisms - and then again it might not. It also is quite possible that the Ames test could declare a chemical safe which is quite powerfully carcinogenic in mammals simply because it does not affect bacteria.

In any case, relying on the Ames test shows a distinct lack of understanding of the nature of cancer and cell growth. Mammalian cells are programmed to die. Only chemical messages keep them alive and keep a particular gene turned off. It's like a dead man's handle. The moment a genetic error is detected the cell is told to stop dividing. If the error is serious, this gene is turned on and the cell destroys itself. This gene and its backup copy have to fail before a cancer can develop _or_ the chemical messenger system has to become defective and keep it turned off _or_ the self-checking mechanism has to become defective. Many cancers have genetic defects in one or more of these command chains. Presumably it is also possible for an error to develop in the signalling system between the self-destruct gene and the lysosome - the dead man's handle is released but the grenade doesn't go off.

Another gene which codes for ras protein is part of the cell division mechanism. If it is defective the cell goes on dividing. Similarly other parts of the cell division command chain (growth hormone receptor, cytokines etc) can have errors. Some viruses (eg: Epstein-Barr in some circumstances) cause a proliferation of growth hormone receptor on the cell's surface which keeps the cell dividing. The more a cell divides, the more the chance of a mistake and therefore the higher the risk of a cancer developing.

Now the likelihood of being able to show that these specific genetic defects are going to be caused in humans from a bacterial model is laughable. A bacterium is a single-celled organism. It has no use for programmed cell-death!

The Ames test may have some value as an initial screening test, but only as long as its limitations are acknowledged. To rely entirely on it as definite proof that a compound is carcinogenic is not only laughable - it is also bad science!

[Home](#) - [Herb FAQs](#) - [Articles](#) - [Classic texts](#) - [Archives](#) - [Links I like](#) - [Pictures](#) - [Plant names](#)





[Home](#) > [Herb FAQs](#) > [Medicinal herb FAQ](#) > [General info](#) >

[Medicinal herb FAQ: Intro](#) - [Single herbs](#) - [Herbs for specific things](#) - [Processing herbs](#) - [General info](#) - [Information sources](#) - [Schools](#) - [Related forums](#)

The Medicinal HerbFAQ

5.5 Trying out the placebo effect

> It's really hard to judge whether the effects were the result of the ..herb.., or whether I just thought these effects were occurring because I was seeking for them to happen (constantly checking myself to see if I notice any change - a bit like the placebo effect I guess).

It's nice to see someone wondering whether they were subject to the placebo effect! Too many people seem to be a bit too convinced by their own personal experiences.

If you are concerned about a placebo effect you might want to try your own little experiment. Get some large empty gelatin capsules from a health food store. Put sugar in half of them and your ginkgo capsule (which should be small enough to fit) in the other (with sugar to fill up the rest of the space. Have a friend label some bottles with numbers (the more bottles your use, the more likely it will be that you aren't just guessing right). The numbers will correspond with whether the bottle contains the sugar or the ginkgo but only your friend will know which is which. Then have your friend put the capsules in the bottles. Complete one bottle and then go on to the next. Don't look at the capsules as you take them and be aware of any subtle ways that you might be discerning the difference (e.g. weight, aftertaste etc.) You might want to use a rating scale of your alertness. Be aware that if you choose the ginkgo, it might simply be a coincidence, so make sure that the difference in ratings is big.

MORAVCSIK.clipr.colorado.edu (Julia Moravcsik)

[Home](#) - [Herb FAQs](#) - [Articles](#) - [Classic texts](#) - [Archives](#) - [Links I like](#) - [Pictures](#) - [Plant names](#)





[Home](#) > [Herb FAQs](#) > [Medicinal herb FAQ](#) > [General info](#) >

[Medicinal herb FAQ: Intro](#) - [Single herbs](#) - [Herbs for specific things](#) - [Processing herbs](#) - [General info](#) - [Information sources](#) - [Schools](#) - [Related forums](#)

The Medicinal HerbFAQ

5.6 How to find an herbalist / ND

I get a lot of emails saying, eg, "I have Hep C and my dad has Lupus and Crohn's, and my mon's hypothyroidal, what herbs can you recommend for that?" - I don't recommend herbs for that at all, I give a list of referral sites and addresses for alternative healthcare associations. Here it is, gathered over a couple of years:

Try the American Association of Naturopathic Physicians (AANP):

<http://www.naturopathic.org>

Or the American Herbalists Guild (AHG): <http://www.americanherbalistsguild.com>

Canadians can check the Canadian Naturopathic Association (NDA):

<http://www.naturopathicassoc.ca>

Then there's the Ontario Herbalists Association (OHA): <http://www.herbalists.on.ca>

Brits can look for member of the National Institute of Herbal Medicine (NIMH):

<http://www.nimh.org.uk>

Australians have the National Herbalists Association of Australia (NHAA):

<http://www.nhaa.org.au>

If you're in New Zealand check the New Zealand Association of Medical Herbalists (NZAMH):

<http://nzamh.org.nz>

If you still can't find a practitioner near you, you can try the bulletin boards at your local coop / health food store / vegetarian restaurant / other similar place.

[Home](#) - [Herb FAQs](#) - [Articles](#) - [Classic texts](#) - [Archives](#) - [Links I like](#) - [Pictures](#) - [Plant names](#)





Henriette's Herbal Homepage

[Home](#) > [Herb FAQs](#) > [Medicinal herb FAQ](#) > [General info](#) >

[Medicinal herb FAQ: Intro](#) - [Single herbs](#) - [Herbs for specific things](#) - [Processing herbs](#) - [General info](#) - [Information sources](#) - [Schools](#) - [Related forums](#)

The Medicinal HerbFAQ

5.7 Politics and herbal medicine

The growing awareness of herbs is nothing but growing competition to profitable product lines - at least if you're a pharmaceutical company. Which is why pharmacogiants do their very best to spread FUD (Fear Uncertainty Doubt) about herbs and herbal medicine.

A case in point: the German kava debacle, leading to its banning in many countries *without any published details on the adverse effect cases whatsoever*. In fact, these oh-so-dangerous adverse effects were mostly due to meds taken together with or even instead of kava, or due to pharmaceutical-type kava products (50+ % kavalactones, extracted with acetone? That's not a herb, that's a med!).

Adverse effects from kava, the herb, extracted at 1:2 in 95 % ethanol are very rare. In fact, I'd suggest the use of education (don't extract insanely high amounts of "active constituents", and don't use toxic solvents) and common sense (*stop* using kava if you get the telltale scaly skin) instead of legislation, to help clear up the rather few (and quite benign) adverse effects from kava, the herb.

Kava, *Piper methysticum*, is a direct competitor to Paxil and other anti-anxiety agents. It's cheap, can't be patented, and has next to no side effects. Oops.

Another case in point: headlines (and study conclusions) like "<herb> does not work" hide the fact that the med compared in the same trial was way below placebo, too:

<http://jama.ama-assn.org/cgi/content/abstract/287/14/1807> - a better headline would have been "<placebo> better than <herb> *and* <med>!" And this is but a single example of the multitude of skewed research headlines that have been shouted over the rooftops over the last 6 years - ever since St. John's wort made it big on 20/20, back in 1997. FUD. Fight it.

St. John's wort, *Hypericum perforatum*, is a direct competitor to Zoloft and other antidepressants. In addition it's cheap (or even free - pick your own!), can't be patented, and has next to no side effects. Oops.

How to know who's right and who's wrong, then? There's two types of medical journals, the biased ones and the unbiased ones. This is my take on two of the big ones - the ones that get quoted in headlines:

- if the BMJ publishes something on alternative healthcare it's unbiased unless proven biased.
- if JAMA publishes something on alternative healthcare it's biased against unless proven

unbiased.

I'm not saying there aren't quacks in herbal medicine - there are, foremost among them those that take advantage of the desperate (like selling essiac to terminal cancer patients at exorbitant rates) (those people are *despicable*), and the multitude of MLM'ers (multi level marketing biz people) (these people are just clueless and annoying). And don't let me get started on the supplement business ...

However, mainstream medicine and pharmaceutical companies aren't any angels either. Perhaps they believe in what they are doing to alternative healthcare in general and herbal medicine in particular, but that doesn't make them right.

So herbal medicine is under siege. And you generally see only the anti-herbal headlines, because the ones critical to meds and MDs are hidden away as well as they ever can be. How then do you find balancing information? Here's a few links. I hope they are as enlightening to you as they were to me:

- Oops - there goes unbiased medical research: <http://bmj.com/cgi/content/full/326/7400/1167>
- How to make new diseases for fun and profit. Nicholas Regush has collected some very interesting links on his page: http://www.redflagsweekly.com/special_edition.html . Among them these gems:
 - Drug companies and Female Sexual Dysfunction: <http://bmj.com/cgi/content/full/326/7379/45>
 - Ritalin and ADD/ADHD: http://www.house.gov/ed_workforce/hearings/106th/oi/ritalin92900/baughman.htm
 - Paxil and Social Anxiety Disorder (what used to be called shyness): <http://www.policyalternatives.ca/publications/articles/article315.html>
 - Paxil and Generalized Anxiety Disorder: <http://www.guardian.co.uk/Archive/Article/0,4273,4471963,00.html>
- A summary of the tactics pharmacogiants use to discredit herbal medicine: <http://www.rmhiherbal.org/review/2003-2.html>
- Too many doctors prescribe based on favors received from pharmaceutical companies: <http://bmj.com/cgi/content/full/326/7400/1189>
- You've heard of the quackwatch site. Here's something to put quackwatch into perspective: <http://www.quackpotwatch.org/opinionpieces/aaaaaaa.htm>
- The morbidity and mortality site is downright scary, and *very* hard to find: <http://webmm.ahrq.gov>

[Home](#) - [Herb FAQs](#) - [Articles](#) - [Classic texts](#) - [Archives](#) - [Links I like](#) - [Pictures](#) - [Plant names](#)





Henriette's Herbal Homepage

[Home](#) > [Herb FAQs](#) > [Medicinal herb FAQ](#) > [Information sources](#) >

[Medicinal herb FAQ: Intro](#) - [Single herbs](#) - [Herbs for specific things](#) - [Processing herbs](#) - [General info](#) - [Information sources](#) - [Schools](#) - [Related forums](#)

The Medicinal HerbFAQ

6.1 Good Books on Herbs and Herbal Medicine

6.1 Good books on herbal medicine

- 6.1.1 [Good books to get started with](#)
- 6.1.2 [Specialty books: women's herbals, men's herbals etc.](#)
 - 6.1.2.1 [Going for broke \(and I wish you luck\)](#)
- 6.1.3 [In-depth books, by organ system](#)
- 6.1.4 [Chinese herbs, or TCM \(Traditional Chinese Medicine\)](#)

Please also check Jonno's Herbal Bookworm page: <http://www.herbological.com> .

And let me know if I've left out -your- favorite book. Be aware, however, that I won't even consider stinkers such as Tyler or Hutchens.

6.1.1 Good books to get started with

Real basics

- **Lesley Bremness: *The Complete Book of Herbs*** - a practical guide to growing and using herbs.
288 pages, paperback, 11.60 x 7.66". Penguin Studio, Sep 1994. ISBN 0140238026.
Listprice USD 22.
A good allround book for the beginner, it includes one-page articles on 100+ herbs, and a wide variety of uses for them (culinary and medicinal uses, cleaning, beauty, etc.). There's also a section on how to grow herbs. Lots of clear plant and how-to color pictures.
- **Richard Mabey: *The New Age Herbalist - How to use herbs for healing, nutrition, body care, and relaxation.***
288 pages, 9.71 x 7.69". Fireside, Nov 1988. ISBN 068481577X. Listprice USD 22.
A beginner's herbal, lots of pictures, not as practical as the others, but still worthwhile.
- **Andrew Chevallier: *The Encyclopedia of Medicinal Plants.***
336 pages, 11.25 x 9". DK Publishing, Dec 2000. ISBN 0789467836. Listprice USD 40.

Like all Dorling Kindersley books it's big on pictures, so it's good for beginners. This one contains one-page articles on 100 plants (lots of pictures for each of these) and very short paragraphs on 450 more (with pictures for about a third of them), in addition to the obligatory history and making remedies bits. If you're out where there's no herb stores you won't like it too much - there's far too many plants from TCM.

- **David Hoffmann: *The Holistic Herbal - A Safe and Practical Guide to Making and Using Herbal Remedies***
288 pages, 9.66 x 7.44". Thorsons Pub, 4th ed., Jan 2003. ISBN 0007145411. Listprice USD 17.
The 1996 edition had 256 pages, of which 200+ half-page articles on single herbs and a section on problems and herbal remedies by organ system. Also includes the usual how-tos - teas, ointments, lozenges, etc. Very visual.
- **John Lust: *The Herb Book*.**
700 pages, 6.84 x 4.2". Benedict Lust Publ., Jun 2001. ISBN 0879040556. Listprice USD 9.
Short notes on the medicinal use of a lot of herbs. Also tables you can look up things in. Some black-and-white plant drawings.
- **Susun Weed: *Healing Wise - Wise Woman Herbal*.**
312 pages, 8.44 x 5.52". Ash Tree Pub., Jul 1989. ISBN 0961462027, listprice USD 13.
In-depth information on seven very common herbs. Some black-and-white plant drawings.
- **Michael Tierra: *The Way of Herbs*.**
416 pages, 9.31 x 6.19". Pocket Books, Aug 1998. ISBN 0671023276, listprice USD 17.00.
A beginner's herbal. No pictures.
Michael Tierra is online at: <http://www.planetherbs.com/>
- **James Green: *The Herbal Medicine Maker's Handbook - A Home Manual*.**
384 pages, 10.62 x 8.48". Crossing Press, Dec 2000. ISBN 0895949903. Listprice 23 USD.
(I have his 40-page booklet on the theme, and find that the allround beginner's herbals cover the topic distinctly better. This almost 400 page treatise might cover ground not found elsewhere, though.)
- **Igor Vilevich Zevin: *A Russian Herbal*.**
250 pages, 8.97 x 6.06". Inner Traditions Intl Ltd., Feb 1997. ISBN 0892815493. listprice USD 15.
For a different view on how to use herbs (still beginner's level) get this book. Some black-and-white plant drawings.
- *No longer in print (my but time flies!):*
 - **Penelope Ody: *The Complete Medicinal Herbal*.**
192 pages, hardcover, 11.75 x 8". Dorling Kindersley Publishing, Jun 1993. ISBN 1-56458-187X. Listprice USD 30.
A good allround book for the beginner, with one-page articles on 120 plants, charts that tell you which herbs to use for which problems, and the obligatory history and making your own remedies bits. A very visual book.
 - **Penelope Ody: *Home Herbal* - a practical family guide to making herbal remedies for common ailments.**
144 pages, hardcover or paperback, 9.75 x 7.75". Dorling Kindersley Publishing, Jun

1995. ISBN 1564588637. listprice USD 20.

A short introduction to making your own herbal remedies, and the ailments to use them for. Lots of clear plant and how-to color pictures.

- **Christopher Hedley and Non Shaw: *Herbal Remedies - A beginner's guide to making effective remedies in the kitchen.***
96 pages, 12.25 x 9.5". Parragon Jan 1999. ISBN 075252416X. Listprice GBP 7 or so.

Very good recipes. It's down to earth and well-written, and you'll get to know (and probably expand) your spice rack in ways you didn't expect when you bought your spices. Lots of clear plant and how-to color pictures. I have both the original hardcover and a later smaller paperback; the content is identical.

Often mentioned, but perhaps not really worth it:

(If you feel I'm wrong in my assessment of these books let me know why you disagree - my email address is hetta@spamcop.net.fix (no fix)).

- **James A Duke: *The Green Pharmacy Herbal Handbook - Your Everyday Reference to the Best Herbs for Healing.***
352 pages, 6.74 x 4.16". St. Martin's Press, Jun 2002. ISBN 0312981511. Listprice USD 7. I have the 1997 edition of this. It's a book written by a researcher, not by a practitioner, and it shows in some of the herbal recommendations. Don't trust it, get one of the books written by a practitioner instead.
- **David Hoffmann: *Medical Herbalism - The Science and Practice of Herbal Medicine.***
672 pages, 10.9 x 8.68". Inner Traditions Intl Ltd., Aug 2003. ISBN 0892817496. Listprice USD 60.
I'm told (I don't have this book) that this is a reprint of the usual Hoffmann database with scientific research thrown in. If that is indeed the case it's not all that much use to the practising herbalist (scientific research on herbs being mostly theoretical), at least if you already have a couple of Hoffmann's works. Add to that that it's very expensive - well, it's not on my list of books to buy anytime soon. If you have this book, are a herbalist, see clients, *and* disagree with this assessment, let me know.
- **Varro Tyler.** Read Jonno's review of Tyler's "*Honest herbal*" and "*Herbs of choice*" to see why Tyler's writings aren't respected by professional herbalists:
<http://www.herbological.com/deconstructing.html> .
If you want a good scientific book on herbs try **Rudolf Fritz Weiss, MD, *Herbal Medicine*** (don't buy the "updated" version, stay with the original from 1988) (listed in entry [6.1.3](#), In-depth books, by organ system)
- ***The Complete German Commission E Monographs - Therapeutic Guide to Herbal Medicines***
This is a very expensive set of committee summaries (380 monographs, Listprice USD 189). Jonno has reviewed the monographs; find his comments here:
<http://www.herbological.com/understanding.html>
- **Simon Mills, Kerry Bone: *Principles and Practice of Phytotherapy - Modern Herbal Medicine.***

448 pages, 9.96 x 7.75". Churchill Livingstone, Nov 1999. ISBN 0443060169. Listprice USD 83.

I'm told this book constantly praises the use of 1:1 extracts as made by Kerry Bone's company MediHerb. If that's indeed the case it should be given away for free, not sold for rather too much money.

Whatever, you're probably distinctly better off buying Simon Mill's earlier work, "Out of the Earth" (also called "The Dictionary of Modern Herbalism"). And stay away from other books by Kerry Bone, unless he's writing with co-authors who have the guts to put their foote down about hidden marketing.

- **Volker Fintelmann, Rudolf Fritz Weiss: *Herbal Medicine - second edition, revised and expanded.***

448 pages, 9.25 x 6.75". Thieme Medical Publ, 2nd ed., Aug 2000. ISBN 0865779708. Listprice USD 59.

Stay FAR away from this rewrite.

Read Jonno's review if you want to know why: <http://www.herbological.com/weiss.html>

Field guides

- **Steven Foster, James A. Duke: *A Field Guide to Medicinal Plants and Herbs of Eastern and Central North America. (A Peterson guide).***

424 pages, 7.22 x 4.48". Houghton Mifflin Co, 2nd revised ed., Dec 1999. ISBN 0395988144, listprice USD 19.

I have the 1990 edition, and it really has very little in the way of text. It's possible that the 1999 edition is distinctly better.

- **Jim Pojar, Andrew MacKinnon: *Plants of the Pacific Northwest Coast.***

528 pages, 8.53 x 5.57". Lone Pine Publishing, Dec 1994. ISBN 1551050404. Listprice USD 20.

You'll find the most common plants of the PNW USA, including photos, drawings, maps, and short paragraphs on usage. It's an excellent field guide - we need more of this caliber. One peeve: botanical works should always mention *Genus species* auct.; there's no auct in this book.

Diving deeper

- **Michael Moore: *Medicinal Plants of the Mountain West.***

351 pages, 9.30 x 6.14". Museum of NM Press, Aug 2003. ISBN 0890134545. Listprice USD 25.

Michael has rewritten the 1979 *Mountain West* book; it's now in the same format, with the same depth of detail and with as many funnies as his extraordinary *Pacific West* book. Go buy it.

- **Michael Moore: *Medicinal Plants of the Pacific West.***

359 pages, 9.23 x 6.14". Red Crane Books, 1993. ISBN 1878610317, listprice USD 22.5. The single best book on medicinal plants I have seen to date. Don't let the title throw you, it's got universal appeal. I use it, and I'm rather far away from the Pacific west.

- **Michael Moore: *Medicinal Plants of the Desert and Canyon West.***

200 pages, 8.48 x 5.48". Museum of NM Press, Apr 1990. ISBN 0890131821. Listprice USD 15.

A good book on the medicinal uses of some southwestern herbs.

Michael Moore's books on medicinal herbs are very good and fun to read, too. You're in for a treat if you haven't visited his homepage yet - he's got some good practitioner-level booklets online, free for downloading: <http://www.swsbm.com>

● **Michael Moore: *Los Remedios - Traditional Herbal Remedies of the Southwest.***

108 pages, 8.47 x 5.48". Red Crane Books, Oct. 1990. ISBN 1878610066. Listprice USD 10.

If you ever decide to do a book on traditional medicinal uses of your local flora, check this book to see how it's done. It's the only work in this genre (that I've seen) that includes a paragraph labelled "usefulness" with the usual traditional uses.

● **Matthew Wood: *The Book of Herbal Wisdom***

250 pages, 9.05 x 6.05". North Atlantic Books, Sep 1997. ISBN 1556432321, listprice USD 19.

Well worth the price, as Matthew Wood opens a rather different point of view on plants. His tales are sprinkled with personal experience and herbal wisdom. Very very good.

● **Gazmend Skenderi: *Herbal Vade Mecum - 800 Herbs, Spices, Essential Oils, Lipids, Etc. Constituents, Properties, Uses, and Caution.***

496 pages, 8.86 x 6". Herbacy Press, Jun 2003. ISBN 0971320926. Listprice USD 25 plus shipping. Available directly from the publisher: herbacy@aol.com . (better buy it there - Amazon wants USD 50 for it - plus shipping, too, of course.)

Uses are given, dosages aren't - you need to know your plants before you use this book. It's a very good materia medica for practitioners, focusing on the essential; beginners might not do all that much with it, except they'd get solid, practical, sensible cautions for the listed plants, instead of the usual overblown and overly theoretical ones. No pictures.

● **Janice Schofield: *Discovering Wild Plants - Alaska, Western Canada, The Northwest.***

355 pages, 10.9 x 8.45". Alaska Northwest Books, 1998. ISBN 0882403699. Listprice USD 40.

A delightful book, it includes information on a lot of plants found up here in Finland, too. Great pictures, lots of tried and true recipes, sensible medicinal uses - you need this book if you live up north.

● **Janice Schofield: *Alaska's Wild Plants.***

95 pages, 8.02 x 4.55". Alaska Northwest Books, 1995. ISBN 0882404334. Listprice USD 13.

Compared to her excellent *Discovering Wild Plants*: this one is a tenth (or less) of the scope and a third of the price. You makes your choice and you pays your price.

● **Thomas Bartram: *Bartram's Encyclopedia of Herbal Medicine - The Definitive Guide to the Herbal Treatments of Diseases.***

496 pages, 9.10 x 6.12". Marlowe & Company, Sep 2002. ISBN 1569245509. Listprice USD 18.

A lot, and I do mean a LOT, of short notes on herbs, supplements, and diseases, listed alphabetically. Very good as a repertory - a work which gives you treatment options for diverse ailments. No pictures.

- **Maud Grieve: *A Modern Herbal - Vol. 1, A-H, and Vol. 2, I-Z.***
443 + 476 pages, 2 x 9.17 x 6.49". Dover Publ. 1971 reprint of the 1931 original. ISBN 0486227987 (I), 0486227995 (II), listprice USD 13 each.
A fairly good materia medica, especially for its history value. It's online too, scanned and OCR'd in full by Ed Greenwood: <http://www.botanical.com/botanical/mgmh/mgmh.html>

Thorough but easy to understand descriptions of some plants and/or some organ systems

- **Janice Schofield: *Nettles.*** (A Keats good herb guide).
96 pages, 6.77 x 4.18". McGraw-Hill, Jan 1998. ISBN 087983840X, listprice USD 5.
Despite the small format you'll get real in-depth information about that nicest of plants, the stinging nettle. I can personally vouch for Henriette's Potato Mash, with nettles of course. Excellent work!
- **Michael Moore: *Herbs for the Urinary Tract.*** (A Keats good herb guide).
96 pages, 6.77 x 4.18". McGraw-Hill, Jan 1999. ISBN 0879838159, listprice USD 5.
A short but thorough introduction to the urinary tract and what gets it out of and back into kilter.
- **Aviva Romm: *ADHD Alternatives - A Natural Approach to Treating Attention Deficit Hyperactivity Disorder.***
128 pages, 8.49 x 5.54". Storey Books, Jul 2000. ISBN 1580172482. Listprice USD 13.
- **Christopher Hobbs: *Medicinal Mushrooms - An Exploration of Tradition, Healing & Culture.***
264 pages, 9.38 x 6.66". Book Pub Co, 2003. ISBN 1570671435, listprice 19 USD.
It's the book on medicinal mushrooms. Go get it, it's good.
- **Christopher Hobbs: *Natural Therapy for your Liver: Herbs and Other Natural Remedies for a Healthy Liver.*** 128 pages, 2002, ISBN1583331328, listprice USD 10.
- **Christopher Hobbs: *Vitex, the Women's Herb.*** 95 pages, 2003, ISBN 1570671575, listprice USD 8.
Accurate and balanced booklets.
He's online here: <http://christopherhobbs.com>
- **Steven Foster's botanical booklets.** Web site here: <http://www.stevenfoster.com>
- *No longer in print - a shame really:*
 - **Paul Bergner: *The Healing Power of Garlic***
304 pages, 8.25 x 5.50". Prima Publishing, Oct 1995. ISBN 0761500987, listprice USD 16.
 - **Paul Bergner: *The Healing Power of Ginseng and the Tonic Herbs***
288 pages, 8.75 x 5.25". Prima Publishing, May 1996. ISBN 0761504729. Listprice USD 15.
 - **Paul Bergner: *The Healing Power of Echinacea, Goldenseal and other Immune system herbs***
336 pages, 8.75 x 5.50". Prima Publishing, Feb 1997. ISBN 0761508090, listprice USD 15.
 - **Paul Bergner: *The Healing Power of Minerals, Special Nutrients, and Trace***

Elements.

320 pages, 8.50 x 5.75". Prima Publishing, Jul 1997. ISBN 0761510214, listprice USD 15.

These are very good in-depth books both about the herbs and the organ systems involved. Get them if you can.

Paul Bergner is the editor of Medical Herbalism (see the professional level journal list, [ch.6.3.2](#)). He has a website at <http://www.medherb.com>.

6.1.2 Specialty books: women's herbals, men's herbals etc.

Let's get gender-specific:

- **Rosemary Gladstar: *Herbal Healing for Women*** - simple home remedies for women of all ages.
304 pages, 9.17 x 7.35". Fireside Books, Nov 1993. ISBN 0671767674, listprice USD 14.
A very good book on herbs and women's health - and at that price it's a steal.
Rosemary Gladstar's website is at <http://www.sagemountain.com>
- **Amanda McQuade Crawford: *Herbal Remedies for Women***.
304 pages, 9.23 x 7.41. Prima Health, 1997. ISBN 0761509801. Listprice USD 20.
A very good book on herbs and women's health.
- **Ruth Trickey: *Women, Hormones & The Menstrual Cycle - Herbal & Medical Solutions from Adolescence to Menopause***.
680 pages, 9.22 x 6.68". Allen & Unwin, 2nd ed., Apr 2004. ISBN 186508980X. Listprice USD 30.
A good book about the hormonal system and what gets it out of and back into balance. Learn how to remedy, for instance, endometriosis, fibroids, or painful menses with diet, herbs and supplements.
My copy of this book (1st ed.) is misbound (parts are upside down and, obviously, back-to-front), and the publisher promised me a new copy over a year ago. Haven't seen it yet. Tut tut, *bad* publisher.
- **Amanda McQuade Crawford: *The Herbal Menopause Book***.
224 pages, 9.10 x 7.08". Crossing Press, Oct 1996. ISBN 0895947994, listprice USD 17.
Great notes on menopausal discomforts, and how to remedy them.
- **Susun Weed: *New Menopausal Years, the Wise Woman Way***.
304 pages, 8.42 x 5.52". Ash Tree Pub., rev. ed., Nov 2001. ISBN 1888123036. Listprice USD 13.
- **Susun Weed: *Wise Woman Herbal for the Childbearing Year***.
196 pages, 8.42 x 5.52". Ash Tree Pub., Jun 1985. ISBN 0961462000. Listprice USD 10.
- **Susun Weed: *Breast Cancer, Breast Health, the Wise Woman Way***.
380 pages, 8.42 x 5.52". Ash Tree Pub., Mar 1997. ISBN 0961462078. Listprice USD 15.
Susun has her own very wise way of looking at things. You buy one first, and then you go

out of your way to get the others when you or somebody close to you needs them.

Susun is online here: <http://www.susunweed.com>

- *No longer in print:*
 - **Anne McIntyre: *The Complete Women's Herbal*** - a manual of healing herbs and nutrition for personal well-being and family care
287 pages, 10 x 7.75". Henry Holt & Co., Jan 1995. ISBN 0805035370, listprice USD 25.
A very good book on herbs and women's health.
 - **James Green: *The Male Herbal*** - health care for men and boys
278 pages, 9 x 6". Crossing Press, Apr 1991. ISBN 0895944588, listprice USD 15.
The only book about herbs for men that I've seen so far.

Kids

- **Aviva Romm: *Naturally Healthy Babies and Children*** - a Commonsense Guide to Herbal Remedies, Nutrition, and Health.
2000, Storey Books, Pownal, Vermont, USA. ISBN 1-58017-285-7, listprice USD 17.
A good, practical, all-round book for parents.
- **Linda B. White, MD, and Sunny Mavor: *Kids, Herbs and Health*** - practical solutions for your child's health, from birth to puberty.
1998, Interweave Press, Loveland, CO, USA. ISBN 1-883010-53-5, listprice USD 22.
Another look at herbs for kids, this combines the conventional approach with the herbal one.

Pets

- **Mary L. Wulff-Tilford and Gregory L. Tilford: *Herbs for Pets***.
1999, BowTie Press, Irvine, CA, USA. ISBN 1-889540-64-1, list price USD 30.
A blockbuster of a book, this really is worth getting. It includes, among other things, 200 pages of herbal materia medica for pets with glorious pictures, and notes on diet for dogs and cats.

Cancer

There are three books on cancer and herbal medicine for the serious herbalist. These will help you understand the research. They also make it easy to see what's real and what's hype around herbs for cancer:

- **Donald Yance: *Herbal Medicine, Healing & Cancer***.
1999, Keats Publishing, Lincolnwood, Ill, USA. ISBN 0-87983-968-6, listprice USD 22.
- **John Boik: *Cancer & Natural Medicine - A Textbook of Basic Science and Clinical Research***.
1995, Oregon Medical Press, Princeton, Minnesota, US. ISBN 0-9648280-0-6.
- **John Boik: *Natural Compounds in Cancer Therapy***.
2001, Oregon Medical Press, Minnesota, USA, <http://www.ompress.com> . ISBN 0-9648280-1-4.

If you want to get some knowledge about TCM, but keep your western herbalist bias:

- **Steven Foster + Yue Chongxi: *Herbal Emissaries*** - bringing Chinese Herbs to the West.

1992, Healing Arts Press, Vermont, USA. ISBN 0-89281-349-0, listprice USD 17.
Very thorough description of Chinese plants (with growing instructions) for us Westerners.
(I LIKE books with more than 2 pages per plant. These guys use about 6 pages per...)

... or the other way around:

- **Michael Tierra:** *Planetary Herbology - An Integration of Western Herbs into the Traditional Chinese and Ayurvedic Systems.*
Lotus Press, Santa Fe, NM, USA. ISBN 0-941524-27-2, listprice USD 18.

6.1.2.1 Going for broke (and I wish you luck)

There's a very good series of books on how to turn a herb enthusiast into a cottage industry: the bootstrap guides(at www.bootstraps.com). They're practical, down to earth, and they tell you not only what plants will sell but also what kind of American bureaucracies you need to look out for. They are:

- **Lee Sturdivant:** *Profits from your backyard herb garden*
1995, San Juan Naturals, PO Box 642, Friday Harbor, WA 98250, USA. ISBN 0-9621635-3-8, listprice USD 11.
Starting with a smallish herb garden, this book tells you what you need to know in order to sell fresh herbs to local restaurants and markets.
- **Lee Sturdivant and Tim Blakley:** *Medicinal Herbs in the Garden, Field and Marketplace*
1999, San Juan Naturals, PO Box 642, Friday Harbor, WA 98250, USA. ISBN 0-9621635-7-0, listprice USD 25.
The first half of the book gives a view into successful herb businesses, the second part tells you how to grow herbs for the bulk trade - machinery, techniques, hints and tips, and growing and picking specific plants. At the very end of the book you'll find contact information of some American tincture and tea makers, including what plants they need and how to approach them.
- **Lee Sturdivant:** *Herbs for sale*
1994, San Juan Naturals, PO Box 642, Friday Harbor, WA 98250, USA. ISBN 0-9621635-2-X, listprice USD 15.
Interesting views into diverse successful herb businesses.

Not in the same series, this one comes from the other side of the world:

- **Greg Whitten:** *Herbal Harvest*
Bloomings Books, The Stables, 21 Isabella Grove, Hawthorn Victoria, Australia 3122.
ISBN 1876473045.
(review by [Rosemary Jones](#);) Just got a copy from the publisher and it seems to answer most questions on the bulk processing of herbs for commercial use. How to build drying sheds and so on. The farming advice is geared towards Australia but could work elsewhere with some modification.
If you're in the US you can order it from Rosemary (healingpgs.aol.com or Healing Pages 1-800-561-2909) and save on freight. Or order it straight from the publisher.

6.1.3 In-depth books, by organ system

- **Simon Y. Mills:** *The Essential Book of Herbal Medicine*.
1993, Arkana, Penguin Books, London, UK. First published under the title "Out of the Earth", by Viking Arkana 1991. ISBN 014-019309X. Listprice GBP 15.00, USD 17.
Excellent in-depth information for the practitioner.
- **Daniel B. Mowrey:** *Herbal Tonic Therapies*.
1993, Keats Publishing Inc., New Canaan, Connecticut, USA. ISBN 0-87983-565-6, listprice USD 15.
Good information on the use of mild tonic herbs, organized by organ system.
- **David Hoffmann:** *The New Holistic Herbal*
1991 (3rd edition), Element Books Ltd, UK. ISBN 1-85230-193-7, listprice 17 USD.
- **David Hoffmann:** *An Elders' Herbal - Natural Techniques for Promoting Health and Vitality*
1993, Healing Arts Press, Vermont. ISBN 0-89281-396-2, listprice USD 18.
- **David Hoffmann:** *The Herbal Handbook: A user's guide to medical herbalism*.
1988, Healing Arts Press. ISBN 0-89281-782-8, listprice 15 USD.
I don't think it really matters which of David's books you get - they seem quite similar, one and all. So go for the newest, or the cheapest, or the prettiest cover picture - but don't go out and buy them all.
An online Materia Medica, by Hoffmann:
<http://www.healthy.net/clinic/therapy/herbal/herbic/herbs/index.html> . Therapeutics to go with that: <http://www.healthy.net/clinic/therapy/herbal/prevent/body/index.html> . - *The healthy.net site is spamming everybody and their uncle. Whatever you do, don't give them your email address; if you do, they'll spam you forever and ever.*
He's also made a good herbal CD-ROM. Review here: section [6.5.4](#).
- **Priest & Priest:** *Herbal Medication, A Clinical and Dispensary Handbook*.
1982, L.N.Fowler & Co. Ltd., Essex, UK. ISBN 01-85243-368-9.
Great notes for the herbal practitioner.

So you're a mainstream medical professional with an interest in herbs? Try these:

- **Rudolf Fritz Weiss, MD:** *Herbal Medicine*.
1988. AB Arcanum, Gothenburg, Sweden / Beaconsfield Publishers, Beaconsfield, UK.
ISBN 0-906584-19-1. Expensive!
Translated from the sixth German edition of Lehrbuch der Phytotherapie. Written by one of -the- experts on herbal medicine in Germany, it's a gem for practising herbalists and MDs interested in herbs. Don't buy the "updated" version, stay with the original from 1988.
- **Francis Brinker:** *Herb Contraindications and Drug Interactions*. 2. edition.
1998. Eclectic Medical Publications. ISBN 1888483067, USD 19.95.
It's just what it says on the title, and it's written by a ND who works with herbs. What more can I say? Buy it.

- **Steven G. Ottariano:** *Medicinal Herbal Therapy*. 1999, Nicolin Fields Publishing, Portsmouth, NH, USA. ISBN 0-9637077-6-0, listprice USD 14.95
A pretty good summary for the MD or pharmacist who wants to know more about herbs.
-

6.1.4 Chinese herbs, or TCM (Traditional Chinese Medicine)

- **Dan Bensky, Andrew Amble, Ted Kaptchuk:** *Chinese Herbal Medicine Materia Medica*, 2nd. edition. 1993, Eastland Press, Inc., Seattle, WA. ISBN 0939616157.
The standard Materia Medica for western-trained TCM practitioners.
- **Dan Bensky, Andall Barolet:** *Chinese Herbal Medicine Formulas & Strategies*, 1st. edition. 1990, Eastland Press, Inc., Seattle, WA. ISBN 0939616106.
The companion Formulary.
- Roger Wicke: TCHS vol. 1, The Language and Patterns of Life, USD 55
- Roger Wicke: TCHS vol. 2, Herbs, Strategies and Case Studies, USD 55
These are the two major textbooks for the Rocky Mountain Herbal Institute's Chinese herbology course. Description, table of contents and brief excerpts at:
<http://www.rmhiherbal.org/a/c.publ.rmhi.html>
While Roger, in these books, tries to integrate western physiological understanding of TCM theory where possible, the major focus is on using Chinese herbs according to the traditional TCM clinical rules (any other way simply doesn't work as well, as verified by clinical studies in several countries).

> starting a course of acupuncture and Chinese herbology -- does anyone know any good books on this subject?

- From healingpgs.aol.com (HealingPgs):
Read **Ted Kaptchuk's** *The Web That Has No Weaver*. Most of the Seattle acupuncture schools use this as a first year text and it's a lovely, intelligent explanation of the basics of TCM. The herb book that is most popular with our local acupuncturists is **Dagmar Ehling's** *Chinese Herbalist Handbook*. It's laid out in a very user-friendly fashion. The big herbal reference works for most Western trained acupuncturists are the Eastland Press books by Dan Bensky -- they are probably available through your school bookstore.

[Home](#) - [Herb FAQs](#) - [Articles](#) - [Classic texts](#) - [Archives](#) - [Links I like](#) - [Pictures](#) - [Plant names](#)





Henriette's Herbal Homepage

[Home](#) > [Herb FAQs](#) > [Medicinal herb FAQ](#) > [Information sources](#) >

[Medicinal herb FAQ: Intro](#) - [Single herbs](#) - [Herbs for specific things](#) - [Processing herbs](#) - [General info](#) - [Information sources](#) - [Schools](#) - [Related forums](#)

The Medicinal HerbFAQ

6.2 Good Books for further studies

So now you feel you've read enough books, but you're still glassy-eyed from reading the 'constituents' -part of the books (or the various ailment descriptions) - time to go shopping for some (literally) (pun intended) heavier stuff:

If you're a practising herbalist:

- Harvey Wickes Felter, John Uri Lloyd: *King's American Dispensatory*, in two volumes. 1898, 18th edition, 3rd revision. Reprinted 1993, Eclectic Medical Publications, OR, USA. Phone 1-800-332-4372. No ISBN number.

<http://www.eclecticherb.com/emp/historicalresearch.html> Listprice USD 285.

This one lists everything they knew about plants (and chemicals used in medicine) back then, and does it exhaustively. It is REALLY good.

It's online here: <http://ibiblio.org/herbmed/eclectic/kings/intro.html> - that's *all* plant-related entries.

If you're a pharmacognosist or pharmacist with an interest in herbs:

- **Norman Grainger Bisset (Ed.):** *Herbal Drugs and Phytopharmaceuticals, A Handbook for Practice on a Scientific Basis.*

Translation of Max Wichtl (Ed.): Teedrogen (see next entry).

1994, CRC Press. Very expensive.

This book has 181 monographs on European herbs with descriptions and photographs of the herbs, with lists of constituents, indications, side-effects, delivery system, method for authenticating the herb (usually a TLC), and the quantitative standards of the European pharmacopoeias where it is listed as official. Although it does not explain mode of action, this is a technical, and scientific book of excellent quality and a must for serious herbal students. It is also expensive as are all CRC books. (kathjokl.aol.com)

- Max Wichtl (Hrsg.): *Teedrogen, ein Handbuch fuer die Praxis auf wissenschaftlicher Grundlage. 2., erweiterte, ueberarbeitete Auflage*

1989, Wissensch.VG., Stuttgart, Germany. ISBN 3-8047-1009-3, listprice DEM 198.

It's expensive in the original, too, but still a good reference for pharmacognosists and pharmacists.

- **Trease + Evans:** *Pharmacognosy*, 13th edition.
1989, Bailliere Tindall, London.

There is a great deal of chemistry involved in this book but again it is an excellent reference if this is the type of information you want. (kathjokl.aol.com)

Then you might want:

- A basic chemistry textbook.
- A good biochemistry textbook.
- A good anatomy/physiology textbook (good to put you to sleep, too).
- The Anatomy Coloring Book.
- The Physiology Coloring Book.
- The latest Merck Manual, which lists main illnesses plaguing mankind - not for us hypochondriacs. You might need a Medicinese - English dictionary to understand it. The Merck Manual (17th edition) is now on the web:

<http://www.merck.com/pubs/mmanual/sections.htm>

[Home](#) - [Herb FAQs](#) - [Articles](#) - [Classic texts](#) - [Archives](#) - [Links I like](#) - [Pictures](#) - [Plant names](#)





Henriette's Herbal Homepage

[Home](#) > [Herb FAQs](#) > [Medicinal herb FAQ](#) > [Information sources](#) >

[Medicinal herb FAQ: Intro](#) - [Single herbs](#) - [Herbs for specific things](#) - [Processing herbs](#) - [General info](#) - [Information sources](#) - [Schools](#) - [Related forums](#)

The Medicinal HerbFAQ

6.3 Good Periodicals

Also check FTP <ftp://ftp.ibiblio.org>

[/pub/academic/medicine/alternative-healthcare/herbal-references/literature/herb-journals](#) .

Robyn has a list of journals on her page, too: www.rreading.com

You'll find a list of alternative healthcare journals (only one on herbs) here:

<http://www.healthwwweb.com/journals.html>

6.3.1 For enthusiasts (emphasis on color pictures)

- The Herb Companion
The Herb Companion, KS, USA. <http://www.herbcompanion.com>
Bimonthly, USD 20/year or USD 39/2 years (foreign USD 30/year or USD 59/2 years).
Mainly herb gardening and culinary uses of herbs.
- HerbalGram (Journal of the American Botanical Council and the Herb Research Foundation)
American Botanical Council, TX, USA <http://www.herbalgram.org>
Quarterly, USD 50/yr. (Foreign USD 70/yr).
Technical and scientific, ethnobotany, latest medical research.
Do check Jonathan Treasure's in-depth reviews of Tyler's books and the Comm. E. monographs before you let this journal talk you into buying them:
<http://www.herbological.com/>
- Herbs for Health.
Herbs for Health, KS, USA. <http://www.herbsforhealth.com>
Bimonthly, USD 20/year or USD 39/2 years (foreign USD 30/year or USD 59/2 years).
- The American Herb Association Quarterly Newsletter
American Herb Association, CA, USA. <http://www.ahaherb.com>
Subscriptions: USD 35/supporting, USD 20/regular membership per year.
- North East Herb Association Newsletter.
email: [northeastherbal . hotmail.com](mailto:northeastherbal@hotmail.com)

Subscriptions: USD 30-USD 100/yr depending on what you can afford.

- The United Plant Savers newsletter
United Plant Savers, VT, USA. <http://unitedplantsavers.org>
USD 35 - USD 100 sliding scale.
 - The Herb Quarterly
San Anselmo, CA, USA. <http://www.herbquarterly.com/>
Quarterly, ISSN 0163-9900, USD 19.95/year (internet price). (Canada and Mexico add USD 5, other foreign add USD 7).
 - Herbs at Home Magazine,
Ontario, Canada. <http://www.herbsathomemagazine.com/> - (link dead 12Apr04, perhaps the whole mag is gone? -Henriette)
Quarterly, USD/CAD 15/year, USD/CAD 27/2 years.
-

6.3.2 For professional herbalists (emphasis on case studies)

These lead the field:

- Medical Herbalism
Bergner Communications, Boulder, CO, USA. <http://www.medherb.com> - back issues available as single issues, as a bound volume, by online subscription, or on CD.
Subscription by year; 4 issues per; USD 36 (US), 39 (Canada), 45 (overseas). Credit cards accepted.
- The European Journal of Herbal Medicine.
National Institute of Medical Herbalists (NIMH), Exeter, UK, Europe.
Their website <http://www.ejhm.co.uk/> includes full articles of issues 1-3, and TOC of later issues.
Subscription by volume; 3 issues per; GBP 19.50 (UK), 24.50 (EC), 29.50 (overseas). They don't take Visa, but check or money-order is OK.
- Journal of the American Herbalists Guild
<http://www.americanherbalistsguild.com/>
Subscription by year; 2 issues per; USD 45 (US), 60 (foreign).
- The Modern Phytotherapist.
MediHerb Pty Ltd., Qld., Australia. <http://www.mediherb.com.au/>
Subscription by year; 2-3 issues per; AUD 33 (straya), 40 (overseas).
- Australian Journal of Medical Herbalism
National Herbalists Association of Australia (NHAA), NSW, Australia.
<http://www.nhaa.org.au>
Subscription by year; 4 issues per; AUD 220 (full members (practitioners)) + AUD 30 joining fee; AUD 55 (students) + AUD 10 joining fee; AUD 110.50 (supporting members) + AUD 20 joining fee. Overseas + AUD 15 (rates per 0700)

- The British Journal of Phytotherapy - sorry, no info - I'll add an URL if and when they get around to getting one.

This one I don't know:

- The Canadian Journal of Herbalism
Ontario Herbalists Association, Ontario, Canada. <http://www.herbalists.on.ca/journal/>
Subscription CAD 40.00; I don't know how many issues a year or a volume.

Auf Deutsch:

- Zeitschrift der Phytotherapie
Stuttgart, Germany. <http://www.phytotherapy.org/presse/zeitschr.htm> - einige Volltext Artikel, a few full-text articles even in English. The publisher's page is here: <http://www.thieme.de/phyto/index.html>
Not really worth it; unless you're interested in phytotherapy as opposed to herbal therapy, ie. scientific studies as opposed to hands-on experience.
6 issues per year, EUR 62 + Versandkosten.

These are secondary in importance to the practitioner:

- The Protocol Journal of Botanical Medicine - this journal is no more. Do buy used journals, if you can find them.
- The Eclectic Medical Journals
P.O. Box 936, Sandy, OR 97055 USA.
Subscriptions: USD 84/yr for 6 issues.
Comment stolen from an article by Jonathan Treasure: '... the articles in The Eclectic Medical Journals, while giving a useful insight into the grass-roots of the Eclectic movement, hardly justify their annual cost of USD 84 subscription to the average practitioner.'

6.3.3 For universities (emphasis on scientific studies)

- Planta Medica http://www.thieme.de/plantamedica/fr_inhalt.html
- Fitoterapia http://www.indena.com/fitoterapia_profile.asp and http://www.elsevier.com/wps/find/journaldescription.cws_home/620051/description
- Economic Botany <http://www.econbot.org/home.html>

And any other journals which consistently pop up when you do a medline or napralert search (see next section). They should be available at your local university. Subscription rates for these journals run into hundreds, if not thousands of dollars a year, so they are rather out of reach for people, institutions and companies without a sizeable literature budget.

[Home](#) - [Herb FAQs](#) - [Articles](#) - [Classic texts](#) - [Archives](#) - [Links I like](#) - [Pictures](#) - [Plant names](#)





Henriette's Herbal Homepage

[Home](#) > [Herb FAQs](#) > [Medicinal herb FAQ](#) > [Information sources](#) >

[Medicinal herb FAQ: Intro](#) - [Single herbs](#) - [Herbs for specific things](#) - [Processing herbs](#) - [General info](#) - [Information sources](#) - [Schools](#) - [Related forums](#)

The Medicinal HerbFAQ

6.4 Online commercial databases

6.4.1 Napralert

There's an introduction to NAPRALERT on this www page:

<http://info.cas.org/ONLINE/DBSS/napralertss.html>

Mary Lou Quinn, Managing Director, NAPRALERT, states the difference between Medline and Napralert as follows:

"NAPRALERT is and always has been restricted to world literature regarding natural products. Medline is not restricted. Just as one example, if you query NAPRALERT on the key word AMYGDALIN, you will get only that literature pertaining to the compound AMYGDALIN (otherwise known as LAETRILE).

If you query Medline, not only will you get the above, but you will also get lots of articles dealing with the Amygdala of the brain, anatomy, physiology, etc. It has never been NAPRALERT'S goal to be all inclusive regarding medical science. However, if you want the most comprehensive database on Medicinal plants and Natural products, then NAPRALERT is the way to go."

Quoted from the NAPRALERT information package:

"Napralert (NATURAL PRoducts ALERT) is a relational database of world literature on the chemical constituents and pharmacology of plant, microbial and animal (primarily marine) extracts.

It's housed and maintained by the Program for Collaborative Research in the Pharmaceutical Sciences, within the Department of Medicinal Chemistry and Pharmacognosy, in the College of Pharmacy of the University of Illinois at Chicago, 833 South Wood Street (M/C 877), Chicago, IL 60612, U.S.A.

Phone (312)-996-2246, Fax (312)-996-7107."

And here is what it'll cost you:

You can access Napralert by paying bulk rate (subscribing) or by paying per question. Annual

subscription fee for individual user with no ties to government agencies, small or large businesses, research institutes or libraries: USD 100, of which half gets you manuals, a user ID/password, and limited disk storage space, and the other half gets you answers (at USD 0.75 per reference obtained).

Per question rate: USD 25 + USD 0.75 per reference obtained.

Off-line (snailmail rate): USD 25 + USD 0.75 per reference obtained.

NAPRALERT is also available on-line through STN in the US, Europe and Asia.

6.4.2 Medline

You can get free Medline access here http://www4.infotrieve.com/newmedline/adv_search.asp or here: <http://www.ncbi.nlm.nih.gov/PubMed/>

One has the niftier search engine, while the other will tell you right away if it was 'in vitro' or 'in vivo'. (Why is that important? Section [5.1.8](#) in this FAQ has a nice introduction to the ins and outs of herbal research.)

There is, of course, a caveat with depending on a (a bit skewed) database like Medline: you won't get much outside of the 'white' world; you won't get much outside of English language, you won't get much of the multitude of (occasionally very useful) far-out research. And it helps to add a keyword like 'herb' or 'plant' to your search. Medline is not made for herbalists, it's made for MDs. Live with it, but learn where to get hands-on information, as well. Like the practitioner-level journals I mention in the 'Good Periodicals' -part of this FAQ (section [6.3.2](#)).

Comment by Mark D. Gold (mgold.holisticmed.com):

"I find it (Medline) a very useful tool. But it is important to realize that there are several articles which warn about the "dangers" of herbs (particularly in JAMA) which are little more than inaccurate hatchet jobs."

6.4.3 Ingenta

Another commercial database of scientific journals; it's Carl Uncover in new clothes (well, they merged). Good selection of herbal articles. Enable javascript for the search engine.

<http://www.ingenta.com>

6.4.4 IBIDS

IBIDS is a database where you can search for scientific articles on herbs and supplement. From the NIH (National Institute of Health), Office of Dietary Supplements:

<http://www.nal.usda.gov/fnic/IBIDS/index.html>

[Home](#) - [Herb FAQs](#) - [Articles](#) - [Classic texts](#) - [Archives](#) - [Links I like](#) - [Pictures](#) - [Plant names](#)





Henriette's Herbal Homepage

[Home](#) > [Herb FAQs](#) > [Medicinal herb FAQ](#) > [Information sources](#) >

[Medicinal herb FAQ: Intro](#) - [Single herbs](#) - [Herbs for specific things](#) - [Processing herbs](#) - [General info](#) - [Information sources](#) - [Schools](#) - [Related forums](#)

The Medicinal HerbFAQ

6.5 Herb programs

6.5.1 Demo or shareware herb programs

In my www space (here: <http://www.ibiblio.org/herbmed/programs/>) and my FTP space (FTP to ibiblio.org, cd to </pub/academic/medicine/alternative-healthcare/herbal-medicine/programs/>) you'll find olde DOS programs, made before even Win3.1 really took off (Herb power, v.2.1; Herb Power, v.3.0; Dr. Weed's E-herbal guide v. 3.0; Healing power of herbs, v.2.0; The Herbal Browser, v.1.0; Herbage, v.1.0; Health, v.5.2). They're all shareware or demoversions which have bigger brothers you can buy. Now, five to six years later (06Jun01), they're really pathetic.

For more recent herbal programs try a search for 'herb', 'plant' or 'botanical' on one of the larger shareware sites, like <http://www.shareware.com/>, <http://itprodownloads.com/>, <http://www.winsite.com/search/> or <http://www.download.com/>

A few links to get you started:

Get the demo of HerbBase, an empty database structure ready for you to fill up:
<http://www.DynamicArray.com.au>

Zentrum Publishing has a few programs, here:
http://www.self-realization.com/alternative_medicine_software.htm (Wellness, v.1.84, Naturheilkunde, v.1.8, Herbs v.1.2, Side Effects v.1.0).

Vitamaster, v.?, is found here: <http://www.vita-master.com/software.html>

6.5.1 Commercial Herbprograms

From Paul Bergner <bergner.concentric.net> 29Jun96:

- Christopher Hobbs' **Herbal Prescriber**. Info: Botanica Press, 10226 Empire Grade, Santa Cruz, CA 95060 (408) 457 9095
- It comes on 5 diskettes, for Windows 3.1 only. About 36.95 USD.
It's the best software yet on medical herbalism. It's thorough, clinically based, and inexpensive. It has therapeutic information from the Eclectic works, and also from German texts that have not been translated into English.

Comment from Henriette: the information certainly is reliable. However, the interface isn't all that good - there is no 'automatic' closing of the current window, so if you want to look at something else, and neglect to click the various 'ok' buttons, you get a 'beep' and nothing else. Frustrating.

CD-ROMs:

- **The Herbalist**, ver.2.0, by David L. Hoffmann, CD-Rom database, listprice USD 54.95, DOS, Windows31, Mac.
Available from Hopkins Technology, 421 Hazel Lane, Hopkins, MN 55343-7116. Phone 612-931-9376 or 800-397-9211.
More info found at <http://www.hoptechno.com/herbmm.htm>.
"The Herbalist" was made before crosslinking really took off, but it has a nice index/search engine. It gives you fast access to thorough plant / ailment information. As a bonus there's pronounciations of some plant Latin - the British way. *HeK evaluation: Excellent*.
This is the best herbal therapeutics program on the market.
- **Traditional Chinese Medicine & Pharmacology**. Hopkins Technology (as above).
Listprice USD 54.95.
More info found at <http://www.hoptechno.com/cherbal.htm>.
Well worth the price, if you do have some basic knowledge about Traditional Chinese Medicine. I can't say how good it is if you really know your Chinese herbs, but for my knowledge of TCM (basic) it's perfect.
- **The Herbal Pharmacy**, ver. 1.2, with Brigitte Mars; CD-Rom database, listprice USD 43, Win95. (*no longer offered on brigitemars.com - 22Dec03*)
Available from Hale Enterprises, 2507 North Broadway, Boulder, Colorado 80304. Phone (303)-938-0840, fax (303) 938-0839.
More info found at <http://www.brigitemars.com>
"The Herbal Pharmacy" consists of a Materia medica (300 herbs) and a Formulary (100 formulas). It is extensively crosslinked, well organized, and includes a score of ways to search for information. There's goodies all over the program: for example, if you add your own notes these will be crosslinked, too. The information is quite reliable - Brigitte Mars has been a practitioner for 16 years. *HeK evaluation: Excellent*.
This is the best herbal materia medica / formulary program on the market.
- **The Interactive Herbal**, with Dr. Terri Willard; CD-Rom database, published by The Follgard Group Inc. The CD is available on the web at <http://www.cdromshop.com/cdshop/desc/p.779810113001.html>
At first glance "The Interactive Herbal" is a nicely done CD-Rom, with some multimedia

and a medium-sized database. However, a closer look is disappointing:

- The "Formulas" section (54 so-called formulas) is severely lacking (there are no amounts given), and not too homogenous (one aromatherapy entry, three homeopathy, 8 TCM, 9 vitamin/nutrient...). *HeK evaluation: Don't bother.*
- The "Diet" section (57 regimens) compounds the frustration by telling you to use these formulas, in almost every single diet regimen. How -can- you, if you cannot make them? It made me wonder who the CD was made for, and what the purpose of it really is - to sell preparations? *HeK evaluation: Don't bother.*
- The "Herb" section gives details on 141 herbs, including herbs both from the western tradition and from TCM; here you'll even find some working formulas. *HeK evaluation: So-so.*
- The "Ailment" section gives thumbnail sketches of 124 ailments or disorders, outlines therapeutic approaches, and recommends herbs, vitamins/nutrients, and formulas. This is the most useful part of the CD. *HeK evaluation: So-so.*

There is no search capability at all. Also, the index of herbs is by common name only, and if you cannot guess that you're out of luck.

The Interactive Herbal needs -extensive- changes before it's as good as its introduction screen promises.

- The **Herbal Remedies** CD-ROM, v.2.1, published by PhytoPharm Consulting GmbH. A German CD-ROM, seen from a phytopharmaceutical viewpoint. USD 99 / DEM 149. The database is divided into two main parts:
 - a Materia medica (which lists, in addition to basic plant information, latin name synonyms -and- variations - quite smart, that.). *HeK evaluation: Good.*
 - a drug information sheet - instead of "Aesculus hippocastanum" we get "Hippocastani semen", with preparations, constituents, and indications. *HeK evaluation: Good.*

In addition to above, the "indications" search page needs mentioning. This contains five alphabetical lists of ailments, with links to above drug sheets. If you wish to see what "BfArM", "ICD10", "Homeopathic", "Asian" or "Other" (no "all" possible, sorry) recommends for, say, "migraine", you'll get a choice of drug information sheets for each. I have not been able to find an explanation for the terms "BfArM" or "ICD10" in the database. If you, once you've selected a drug sheet, click on ICD10, you'll be baffled with further unexplained remarks, like "170", or "N 41". These need to be explained somewhere as they are not self-evident (unless you're a German physician?).

MD's and ND's take note - this one is for you.

- **IBIS 99**, CD-ROM, published by Integral Medicinal Arts Group Inc. (IMA). A program for the practitioner, it's divided into four major parts:
 - Therapeutics - subdivided by modality; among others diagnosis, herbs, nutrition, TCM (herbs and needles), and homeopathics. *HeK evaluation: Excellent.*
 - Materia Medica - the same subdivision as for Therapeutics. In addition to the expected information sheets there's also patient handouts. The herbal information is a weird concoction - some (of the about 300) entries have nothing but the name, others have name, dosage, and cautions, still others have full

information including what to use it for, which part to use, how much of it, etc. If you still need to look up herbs this one won't help too much - except on the interactions, cautions and contraindications side. *HeK evaluation: So-so.*

I can't say how good the TCM, homeopathy or flower remedy parts of the Materia medica are; they're not in my area of expertise.

- Notes - the same subdivision as for Therapeutics. Enter your own notes here; it's easiest to import information from .html files as the editing functions are quite modest. *HeK evaluation: So-so.*
- Patients - keep your patients' visits straight. *HeK evaluation: Excellent.*

Do remember to make backups of the files the program generates for you when you add things to the notes or to the patient info. Otherwise a fatal disk crash (not generated by IBIS - that's a very stable program; but I use Win98...) might mean that you have to re-enter everything from scratch.

All in, I think this is a pretty good package for the practitioner - at least, if you're a herbalist and already know your herbs. At the current price of USD 200 (previously USD 700) it's now affordable. (USD 700 for clinics (3+ workstations); USD 150 for students.)

More info here: <http://www.ibismedical.com/>

- **Interactions 1.01**, CD-ROM, published by Integral Medicinal Arts Group Inc. (IMA). Besides containing good in-depth information about the interactions of some 3-400 drugs, a respectable amount of nutrients, and about 20 of the most talked about herbs, it also includes a short section on herbal pharmacodynamics. *HeK evaluation: Pretty good.*
A pretty good package for the price (USD 100).
More info here: <http://www.ibismedical.com/>
- **Medical Herbalism Resource Disc**, CD-ROM.
Paul Bergner's excellent journal Medical Herbalism is now available on a CD-ROM, as .html and .pdf -files. Both contain the complete set of back issues. While the links in the html part aren't always correct (the files are there, but the links don't always point to them), the pdf files work very nicely indeed. *HeK evaluation: Pretty good.*
Price USD 59.
Considering that the back issues on paper are priced at USD 99/149, and that the information in this format is searchable and well indexed, it's a bargain.
Also included on this CD-ROM, in the same .pdf and .html formats, are King's American Dispensatory (from my site, here: <http://www.ibiblio.org/herbmed/eclectic/kings/intro.html> (used with my permission)) and William Cook's Physiomedical Dispensatory (available on the Medical Herbalism site, see below).
More info here: <http://www.medherb.com/MHHOME.SHTML>

[Home](#) - [Herb FAQs](#) - [Articles](#) - [Classic texts](#) - [Archives](#) - [Links I like](#) - [Pictures](#) - [Plant names](#)





Henriette's Herbal Homepage

[Home](#) > [Herb FAQs](#) > [Medicinal herb FAQ](#) > [Information sources](#) >

[Medicinal herb FAQ: Intro](#) - [Single herbs](#) - [Herbs for specific things](#) - [Processing herbs](#) - [General info](#) - [Information sources](#) - [Schools](#) - [Related forums](#)

The Medicinal HerbFAQ

6.6 Other online information sources

Among the goodies you'll find herbal mailing list and newsgroup archives, Michael Moore's files, and some nice WWW pages.

6.6.1 FTP sites with info on medicinal herbs: ibiblio herb archives

Try this: <ftp://ibiblio.org/pub/academic/medicine/alternative-healthcare/herbal-medicine/> or <ftp://sunSITE.sut.ac.jp/pub/academic/medicine/alternative-healthcare/herbal-medicine/>.

More here: ftp://ibiblio.org/pub/academic/agriculture/sustainable_agriculture/gardening/ or here: ftp://sunsite.sut.ac.jp/pub/academic/agriculture/sustainable_agriculture/gardening/.

Still more: ftp://ibiblio.org/pub/academic/agriculture/sustainable_agriculture/gardening/gardening-faqs/ or ftp://sunsite.sut.ac.jp/pub/academic/agriculture/sustainable_agriculture/gardening/gardening-faqs/

And you'll find a wealth of herbal information here - unfortunately not very well organized, but if you do have the time to browse you'll find it is a treasuretrove: <ftp://ibiblio.org/pub/academic/medicine/alternative-healthcare/herbal-references/> or <ftp://sunSITE.sut.ac.jp/pub/academic/medicine/alternative-healthcare/herbal-references/>

6.6.2 Interesting WWW pages

I'll only list the most important herbal WWW pages here. You'll find the rest of the good sites from links on Howie's and my pages. And you should use a search engine to look for information on specific plants.

- Michael Moore's homepage: <http://www.swsbm.com> , the Southwest School of Botanical Medicine.
Have a good look at all the goodies; if you are not a beginner, get the big textfiles - Herbal Materia Medica, Herbal Repertory, Herbal/Medical Dictionary, Herbal-Medical Contraindications, Specific Indications, Herbal Tinctures, Herbal Energetics, Plant Folders, Classic Texts, and anything else that might have been added. There's also a -lot- of pictures on site.
Do download the Herbal Energetics - these are summaries of how to prepare and use plants you already know in ways you already know (even though you didn't necessarily know that you can use THAT plant in THIS way before reading the booklet).
- Howie Brounstein's homepage: <http://www.teleport.com/~howieb/howie.html>
Columbine and Wizardry Herbs, wildcrafting school and herb catalog.
Go get a laugh at the Fad herbs, or read up on smoking herbs, or mugwort. Have fun.
- Jonathan Treasure's Herbal Bookworm page: <http://www.herbological.com>
All you need to know about herb books: excellent in-depth reviews, a list of must-read books, a list of stinkers, and a Reality Check.
- The Health World Online site. - *The healthy.net site is spamming everybody and their uncle. Don't go there, and whatever you do, don't email them using a real account; if you do, they'll spam you forever and ever amen.*
- Henriette's Herbal Homepage: <http://www.ibiblio.org/herbmed>
Home of the herbfaqs (you're reading part of one right now), you'll also find plant pictures, classic texts, plant names in several languages, archives, links - it's an extensive site.
(Me? Biased? Naah.)

[Home](#) - [Herb FAQs](#) - [Articles](#) - [Classic texts](#) - [Archives](#) - [Links I like](#) - [Pictures](#) - [Plant names](#)





Henriette's Herbal Homepage

[Home](#) > [Herb FAQs](#) > [Medicinal herb FAQ](#) > [Information sources](#) >

[Medicinal herb FAQ: Intro](#) - [Single herbs](#) - [Herbs for specific things](#) - [Processing herbs](#) - [General info](#) - [Information sources](#) - [Schools](#) - [Related forums](#)

The Medicinal HerbFAQ

6.7 Pointers to related documents

6.7 Pointers to related documents

- 6.7.1 [Plants by Mail FAQ pointer](#)
 - 6.7.2 [Carpal Tunnel Syndrome WWW page pointer](#)
 - 6.7.3 [Hint for Kombucha posters](#)
 - 6.7.4 [Hint for Essiac posters](#)
 - 6.7.5 [Thinking of growing herbs for sale?](#)
 - 6.7.6 [Saw Palmetto and Prostata problems: Newsgroup/FAQ pointer](#)
 - 6.7.7 [Natural high FAQ pointer](#)
 - 6.7.8 [Natural vision FAQ pointer](#)
 - 6.7.9 [Smoking herbs document pointer](#)
 - 6.7.10 [Pointer to herbal-medical glossary](#)
 - 6.7.11 [Menopausal discomforts](#)
-

6.7.1 Plants by Mail FAQ pointer

Here you'll find lots and lots of catalogs to get living plants, and some seeds, too:
<http://gardenwatchdog.com>

6.7.2 Carpal Tunnel Syndrome WWW page pointer

Take a look at the Carpal Tunnel Syndrome Home Page at <http://www.ctsplace.com/> and specifically, at <http://www.ctsplace.com/preventative.php>

6.7.3 Hint for Kombucha posters

Please subscribe to the Kombucha list (see [8.1.4](#)). Do not post on alt.folklore.herbs about Kombucha.

You could go visit the Kombucha Homepage, which should answer anyone's questions about the subject: <http://w3.trib.com/~kombu/>

6.7.4 Hint for Essiac posters

You can find a wealth of info on Essiac at this web location: <http://essiac-info.org/>

6.7.5 Thinking of growing herbs for sale?

Visit this site first: <http://www.hort.purdue.edu/newcrop/>

It's the Gateway to the NewCrop Resource Online Program at the Indiana Center for New Crops and Plant Products at Purdue University; it has lots of information about different plants.

Next go for Richters' FAQ pages: <http://www.richters.com/QandA.html>

Then go get the 'herb-growing.faq' at metalab (see [6.6](#)).

6.7.6 Saw Palmetto and Prostate Problems: Newsgroup/FAQ pointer

Try news:alt.support.prostate.prostatitis, where they also have an excellent FAQ posted periodically.

6.7.7 Natural High FAQ pointer

The hyperreal archive is gone - try the erowid vault:

http://www.erowid.org/psychoactives/faqs/natural_highs_faq.shtml

6.7.8 Natural vision FAQ pointer

This interesting document can be found here: <http://www.cia.com.au/vic/faq.html>

6.7.9 Smoking herbs document pointer

THE document on herbal smokes, which also tells you how to stop smoking, is Howie Brounstein's Herbal Smoking Mixtures -booklet. You'll find it here:

<http://www.teleport.com/~howieb/howie.html> .

6.7.10 Pointer to herbal-medical glossary

I got email 'yes but what does MAO inhibitor and adrenergics and cholinergics mean?' ... so here's a pointer to Michael Moore's medicines - English dictionary:

<http://www.swsbm.com/ManualsMM/MedHerbGloss2.txt>

you get there from Michael Moore's Clinical Herb Manuals page:

<http://www.swsbm.com/ManualsMM/MansMM.html>

6.7.11 Menopausal discomforts

A very good place to start is the alt.support.menopause newsgroup. Next, check this page:

<http://www.geocities.com/menobeyond/> . Also see the entry on [wild yam, 2.12](#)

[Home](#) - [Herb FAQs](#) - [Articles](#) - [Classic texts](#) - [Archives](#) - [Links I like](#) - [Pictures](#) - [Plant names](#)





Henriette's Herbal Homepage

[Home](#) > [Herb FAQs](#) > [Medicinal herb FAQ](#) > [Related forums](#) >

[Medicinal herb FAQ: Intro](#) - [Single herbs](#) - [Herbs for specific things](#) - [Processing herbs](#) - [General info](#) - [Information sources](#) - [Schools](#) - [Related forums](#)

The Medicinal HerbFAQ

8.1 Mailing lists

Mailing lists have a distinct advantage over the online WWW chat pages: you don't have to be online. Just pull down your email from the server, and read and reply at leisure. It's lots cheaper for those of us who pay phone and/or ISP by the minute (this includes most Europeans).

In addition the lists mentioned below there's [Herbal Hall](#), a low-volume, high-quality list for professional herbalists, but that's by invitation only.

Any other lists you think should be here? Any changes in the lists listed?

You can try a search on "herb" on these list listers: <http://groups.yahoo.com/> , <http://www.topica.com> , <http://www.tile.net> and <http://www.lsoft.com> .

8.1.1 The Herblist

(Alive and well. Oct03)

A high-volume list for discussions about herbal medicine and medicinal herbs.

To subscribe: go to the mailman site: <http://lists.ibiblio.org/mailman/listinfo/herb> or write to herb-request@lists.ibiblio.org with only the following text:
subscribe

Be sure to read the Rules before posting: <http://ibiblio.org/herbmed/archives/herblist/rules.html>
Archives found here: <http://www.ibiblio.org/herbmed/archives.html>

8.1.2 The Aromatherapy List

(Alive and well. Mar02)

To subscribe, write to list@idma.com with the following text: join aromatherapy

The problem with this list, as per several emails in December 00 from former aromatherapy listmembers, is that it's become extremely chatty, with next to no aromatherapy posts. If that changes I'd appreciate an update.

Two less contentious and slightly slower lists with aromatherapy:

The Essentials List:

to subscribe: write to essentials@naturesgift.com with just SUBSCRIBE in the subject line, and no text.

8.1.3 The Kombucha List

(Alive and well. Dec00)

To subscribe: write to kombucha-subscribe@topica.com

Website here: <http://lists.topica.com/lists/kombucha/> and here: <http://w3.trib.com/~kombu/>

Pretty good for newbies but mostly the same stuff over and over and over. Good FAQ.

8.1.4 The Paracelsus List

(Alive and well. Oct03)

Subscription is limited to practitioners, educators, researchers and students in alternative and conventional medical fields.

To subscribe: visit this site: <http://lists.ibiblio.org/mailman/listinfo/paracelsus> and follow the instructions, or write to paracelsus-request@lists.ibiblio.org with the following text: subscribe

As part of the subscription approval process, send a biographical note indicating training, practice and interests to the list at paracelsus@lists.ibiblio.org.

8.1.5 The Homeopathy List

(Alive and well. High volume, no chat. Dec00)

To subscribe: write to homeopathy-request@lyghtforce.com with the subject: subscribe

The archives for this list and a FAQ on homeopathy are kept on

<http://www.homeopathyhome.com/web/descriptions/homlist.shtml>

8.1.7 The Culinary Herblist

(Briefly alive in season. Oct03)

This is the list for the gardening and use of culinary herbs:

To subscribe: write to: Majordomo@oregonvos.net with the text: subscribe herbs-l

Archives found here: <http://www.ibiblio.org/herbmed/archives.html>

8.1.9 The Wellpet List

(Alive and well. Dec00)

A list for a holistic approach to animal health.

To subscribe: write to: majordomo@imagicomm.com with the text: sub wellpet

Webpage: <http://www.listservice.net/wellpet/>

8.1.10 The Holisticat List

(Alive and well. Chatty. Oct03).

A chatty list for the use of nutrition, herbs, homeopathy, acupuncture etc. as it relates to cats.

To subscribe: write to: majordomo@vlists.net with the text: subscribe holisticat

OR the text: subscribe holisticat-digest

The list FAQs, archived old posts, articles etc. are available here: <http://www.holisticat.com>

8.1.12 The Apothecary List

(Almost dead. Mar02)

A list for preparing oils, ointments and suchlike. I'm told that the chatters have moved on.

To subscribe: write to: apothecary-request@kjsl.com with the text: subscribe

8.1.13 The HolisticBird List

(alive and well. Oct03)

The HolisticBird list focuses on natural health for birds. Most of the discussions are around bird diseases, nutrition, and herbs, but there is occasional contributions about homeopathy and other modalities.

To subscribe: write to HolisticBird-subscribe@yahoogroups.com, URL:
<http://groups.yahoo.com/group/HolisticBird/>
HolisticBird Newsletter <http://www.holisticbirds.com>
HolisticBird Website <http://www.holisticbird.org>

8.1.14 The Toiletries List

(Alive and well. Many many ads. Oct03)

A list for various aspects of making your own lotions, cremes, soaps, personal care products, and related subjects.

To subscribe: write to: 1Toiletries-subscribe@yahoogroups.com , URL:
<http://health.groups.yahoo.com/group/1Toiletries/>

8.1.16 The Aboutherbs List

(Almost dead. Oct03)

A list focused more on growing and preserving herbs. Animal health and natural beauty are ontopic, as are herbs for health.

To subscribe: write to aboutherbs-subscribe@yahoogroups.com
Website found here: <http://health.groups.yahoo.com/group/aboutherbs/>

8.1.17 The UK Herbal List

(Alive and well. Oct03)

The ukherbal -list for practitioners in Europe is closed, low on volume and high on quality. If you wish to join, and are a practitioner in Europe, send an email with your resume to gcwhite.ntlworld.comx (no x).

8.1.18 The Herbgardening List

(Alive and well. Oct03)

To subscribe: write to herbgardening-subscribe@yahoogroups.com , URL:
<http://groups.yahoo.com/group/herbgardening>

8.1.19 The Forageahead List

(Alive and well. Oct03)

To subscribe: write to forageahead-subscribe@yahoogroups.com

Website found here: <http://groups.yahoo.com/group/forageahead/>

8.1.20 The HolisticPet List

(Alive and well. Oct03)

To subscribe: write to holisticpet-subscribe@yahoogroups.com

Website found here: <http://groups.yahoo.com/group/HolisticPet/>

[Home](#) - [Herb FAQs](#) - [Articles](#) - [Classic texts](#) - [Archives](#) - [Links I like](#) - [Pictures](#) - [Plant names](#)





[Home](#) > [Herb FAQs](#) > [Medicinal herb FAQ](#) > [Related forums](#) >

[Medicinal herb FAQ: Intro](#) - [Single herbs](#) - [Herbs for specific things](#) - [Processing herbs](#) - [General info](#) - [Information sources](#) - [Schools](#) - [Related forums](#)

The Medicinal HerbFAQ

8.2 Related newsgroups

You might want too check

- alt.folklore.herbs (archives found here: <http://ibiblio.org/herbmed/archives.html>)
- misc.health.alternative
- rec.gardens
- rec.gardens.edible
- rec.food.preserving
- bionet.plants
- sci.med.*
- alt.healing.flower-essence
- alt.support.cancer.prostate
- alt.support.sinusitis
- alt.support.prostate.prostatitis
- alt.support.*
- alt.aromatherapy (comes complete with the usual complaint: 'my site doesn't carry this one' - well, mine doesn't, so I can't say what they talk about over there)

[Home](#) - [Herb FAQs](#) - [Articles](#) - [Classic texts](#) - [Archives](#) - [Links I like](#) - [Pictures](#) - [Plant names](#)





[Home](#) > [Herb FAQs](#) > [Medicinal herb FAQ](#) > [Related forums](#) >

[Medicinal herb FAQ: Intro](#) - [Single herbs](#) - [Herbs for specific things](#) - [Processing herbs](#) - [General info](#) - [Information sources](#) - [Schools](#) - [Related forums](#)

The Medicinal HerbFAQ

8.4 Newsgroup (and mailing list) netiquette

Here's a good page on snipping as you go: <http://learn.to/quote> .

Another good page is among the FAQs found in <news:news.announce.newusers> , a resource all usenet (= newsgroup) newbies should make themselves familiar with:

<http://www.faqs.org/faqs/usenet/posting-rules/part1/>

The main rule is, contributors to these forums are real live people - so don't be a jerk. And remember, Things get Archived.

All of usenet (except binary groups, but read their FAQs), and most mailing lists are plain text. Email, too, is plain text. That means you should not use any kind of html nor any kind of graphics in your posts and/or emails. Also please note that most people who've been around for a while use email and/or usenet programs that don't even see your nicely formatted text - they see the html code instead. `<ht ml><body bgcolor="#FFFFFF">It's gibberish. Take my word for it.</body></h tml>`

Also, a lot of people (including most Europeans) still pay for their online time and/or their phone by the minute. Yes, European phone companies charge for local calls, too. Some Europeans even pay their ISP (internet service provider) by the byte. Html code and graphics in your posts and emails make for longer downloads, and thus, for higher cost.

So change your habits -- and your email program settings. People on slow lines, people who pay by the minute or by the byte, and usenet and email "oldbies" will thank you for your consideration.

[Home](#) - [Herb FAQs](#) - [Articles](#) - [Classic texts](#) - [Archives](#) - [Links I like](#) - [Pictures](#) - [Plant names](#)





Henriette's Herbal Homepage

[Home](#) > [Herb FAQs](#) > [Medicinal herb FAQ](#) > [Related forums](#) >

[Medicinal herb FAQ: Intro](#) - [Single herbs](#) - [Herbs for specific things](#) - [Processing herbs](#) - [General info](#) - [Information sources](#) - [Schools](#) - [Related forums](#)

The Medicinal HerbFAQ

8.5 Dealing with spam and trolls

Instead of fretting over commercial posts, we all should take a cool approach to the problem. Whenever I see a message like "Make quick cash!", "Great Anti-Cellulite Cream!", "Don't be Lonely!", "Earn \$50,000 a week!" or something along those lines, I forward the message to the postmaster where the message originated from, explaining why I find the post inappropriate or offensive. Chances are that the postmaster will look into the issue and have a talk with the abuser, if not go ahead and cancel his/her account altogether (has been known to happen).

If the offensive message originated at an academic institution, then I know I am going to get the sucker in a lot of trouble. Universities have strong policies about the misuse of their computer resources. It is likely that after receiving complaints, the offenders will lose their accounts, and in addition experience the wrath of some disciplinary committee.

So, for the good sake of the net, if you see a commercial message posted by idiot.morons.are.us, forward the message with a piece of your mind to postmaster.morons.are.us. You will be doing everyone a favor.

Gloria Mercado-Martin
desidia.community.net

The same goes for trolls. Also, the right thing to do about trolls is to report, killfile, and forget. If you react to a troll on a newsgroup you are feeding it. If you ignore the troll it'll go back under its bridge sooner or later. Trolling: sending off-topic and/or inflammable messages to newsgroups and/or mailing lists. For example, posting anti-herbal messages to a herbal newsgroup.

A note on finding correct abuse addresses: I quite like <http://www.spamcop.net>

You'll find more hints on news:news.admin.net-abuse.* - these newsgroups are very flammable because they attract the wrath of the spammers they fight, but you will find information on how to fight spam, unwanted ads, unwanted binaries in non-binary newsgroups, and UCE (unsolicited commercial email). Have fun!

[Home](#) - [Herb FAQs](#) - [Articles](#) - [Classic texts](#) - [Archives](#) - [Links I like](#) - [Pictures](#) - [Plant names](#)





Herbal articles

Last updated 15Sep03 - Have a comment? [Tell me](#).

I'm moving these, slowly but surely, to the [Best of the Herbal Forums](#) -section of this site.

[Suomeksi](#) - [På svenska](#)

Papers

- [Medicinal plants in Europe containing pyrrolizidine alkaloids](#): Prof. Dr. E. Röder. Pharmazie 50 (1995), pages 83-98
- An interesting view on the possible why of liver toxicity in acetone extracts of kava, received with thanks from Peter A. Whitton: [Kava lactones and the kava-kava controversy](#): Peter A. Whitton, Andrew Lau, Alicia Sainsbury, Julie Whitehouse, Christine S. Evans. Phytochemistry 64 (2003), pages 673-679. (232 kB) - added 15Sep03

Picking plants: hints and tips

- Todd had a question about bark medicines: [barkmedi.html](#)
- A meditation on picking figs: [figs.html](#) (Miriam Kresh)
- Picking burdock: [burdock.html](#) (Henriette)

Some medicinal plants

- *Avena sativa* (oats) [avena2.html](#) (Karen Vaughan)
- *Cimicifuga*, Black Cohosh: a monograph - [cohosh.html](#) (Andrew Pengelly)
- How to make a dandelion (*Taraxacum*) syrup: [dandsyru.html](#) (Henriette)
- Fruit leather out of cranberry (and other berries): [vaccleat.html](#) (Henriette)
- Uses for *Vaccinium myrtillus*, aka blueberry: [vaccinium.html](#) (Henriette)
- Thoughts on *Valeriana*: [valeriana.html](#) (Howie Brounstein)
- A nice writeup on *Viola* sp.: [viola.html](#) (Karen Vaughan)
- How to candy violet flowers: [violcand.html](#) (Mary Emme)
- Using mullein: [mullein.html](#) (Henriette)

Some disorders

- A summary of gut hormones: [brain-gut.html](#) (Michael Moore)
- Herbal treatments for hepatitis [hepatit.html](#) (Andrew Pengelly)
- A good post on juvenile diabetes and how to live with it: [juvediab.html](#) (Alan Tillotson)
- Good advice about mononucleosis: [mononucl.html](#) (Howie Brounstein)
- General info on allergies: [allergies.html](#) (Henriette)
- What are pinworms? [pinworms.html](#) (Henriette)

Miscellaneous

- Making tinctures: [tincture.html](#) (Henriette)
 - A tincture is not an essence: [tincture1.html](#) (Henriette)
 - Getting the most out of your herb: [usage.html](#) (Henriette)
 - Flower Remedies [bachflow.html](#) (Suzanne Sky)
 - A list of books you might wish to read: [culibook.html](#) (Chris Reeve)
 - Making herb butter: [butter.html](#) (Henriette)
 - Making an herbal gift basket: [basket.html](#) (Henriette)
 - Making salves: [salves.html](#) (Henriette)
 - Every now and then I get a question on a project for schoolkids. Here's a small selection of them: [herbproj.html](#) (Henriette)
 - Jerusalem artichoke: [helianthus.html](#) (Henriette)
 - Alcohol, vodka, proof and percentages - some definitions and pet peeves: [etoh.html](#) (Henriette)
-

Lots of fun

- The alternative herbFAQ: [funstuff.html](#)
- Then there was a nice silly thread on rec.food.preserving, deserving a wider audience: [vowels.html](#)
- Timid about asking something on the newsgroups? You're not alone: [query.html](#)
- Fun with twining plants: [climber.html](#)

Poking fun at advertisers and hustlers

- Got tired of all the scams? Here's the one to top them all; it'll cure dandruff, death and taxes (among other things), and make you irresistible to the opposite sex: [sbganoni.html](#) (Alan Tillotson)





[Home](#) > Classic Texts

Classic texts: [King's](#) - [USDisp](#) - [Ellingwood](#) - [Felter](#) - [Petersen](#) - [BPC](#) - [DMNA](#) - [Thomas](#) - [Sayre](#) - [Cook](#) - [Potter](#) - [HistVD](#) - [Journals](#)

Classic Herbal Texts

Last updated 03May04 - Have a comment? [Tell me](#).

All scanned works on this site are [copyright](#) © 2000-2004 Henriette Kress - unless otherwise specified.

[Index of plants in the classic texts on this site](#)

Books

- [King's American Dispensatory](#), ([intro page](#)) ([preparations page](#)) ([cool tidbits](#)), by Harvey Wickes Felter, M.D., and John Uri Lloyd, Phr.M., Ph.D., 1898.
- [*The American Materia Medica, Therapeutics and Pharmacognosy](#) ([intro page](#)) ([plant page](#)), by Finley Ellingwood, M.D., 1919.
- [*The Eclectic Materia Medica, Pharmacology and Therapeutics](#) ([intro page](#)), by Harvey Wickes Felter, M.D., 1922.
- [*Materia Medica and Clinical Therapeutics](#) ([intro page](#)) ([part II](#)), by Fred J. Petersen, M.D., 1905.
- [The British Pharmaceutical Codex](#) ([intro page](#)) ([preparations page](#)), 1911. - *added more 03May04*
- [*The US Dispensatory](#) ([intro page](#)) ([preparations page](#)), edited by Joseph P. Remington and Horatio C. Wood, 1918.
- [Drugs And Medicines of North America](#) ([intro page](#)), Vol. I-II, by J. U. & C. G. Lloyd, 1884-1887. (*not yet done*)
- [*The Eclectic Practice of Medicine](#), by Rolla L. Thomas, M. D., 1907.
- [*A Manual of Organic Materia Medica and Pharmacognosy](#) ([intro page](#)), by Lucius E. Sayre, 1917.
- [*The Physiomedical Dispensatory](#) ([intro page](#)), by William Cook, M.D., 1869.
- [*History of the Vegetable Drugs of the Pharmacopoeia of the United States](#), by John Uri Lloyd, 1911.
- [A Compend of Materia Medica, Therapeutics and Prescription Writing](#) ([intro page](#)), by Samuel

O. L. Potter, M.D., 1902.

- [Specific Medication and Specific Medicines](#) by John M. Scudder, M.D., 1870.
- *[Ginseng and Other Medicinal Plants](#) - a grower's and collector's guide. A. R. Harding, 1936.
- *[Tea leaves](#) by Francis H. Leggett & Co, 1900.
- [Flora Fennica - Suomen Kasvio \(johdanto\) \(parhaat palat\)](#), by Elias Lönnrot, 1866.
- [Aus Wald und Feld den Tisch bestellt](#), by Walther Schoenichen, 1947.

And this is helpful if you want to read the numbers:

- "Appendix: II: [Tables of Weights and Measures](#)" (the first part), from The Dispensatory of the United States of America, by George B. Wood and Franklin Bache, 1876.

Journals and Periodicals

Ephemera

- John Uri Lloyd: [Alcohol Adversely Criticised](#). OCR'd from a 1922 reprint of articles from 1875 and 1889.
- John Uri Lloyd: [Licorice](#) (picking and processing it in Turkey). OCR'd from a reprint from The Eclectic Medical Journal, 1929.
- *John Uri Lloyd: [The Eclectic Alkaloids](#), 1910.
- *Harvey Wickes Felter: [Biographies](#) of King, Howe, and Scudder, 1912.
- Alexander L. Blackwood: [Observations with Medicago Sativa](#). Lloyd Brothers Leaflet, 1915.
- Elias Lönnrot: [Afhandling om Finnarnes magiska medicin](#). Helsinki, 1832.

*: .html versions of works which are found as .pdf files on [Michael Moore's site](#).

*: cleaned-up and crosslinked .html version of a scan from [Paul Bergner's site](#).

*: .html version of a textfile + images as rec'd from Richard and Margie Druery

Wow, that's a *lot* of text. (59.3+ MB (on ReiserFS), 74.2+ MB (on ibiblio), 7280+ files, and counting.). And there's never enough time, is there? So where should you concentrate your efforts?

- *The later the better* (up to a point) - but however you look at it, King's is still the best, because of the sheer amount of detail. Also, I've linked the journals (and ephemera and such) to and from King's only.
- *Eclectic (and physiomedical) MDs are better than pharmacists* - at least if you're a practising herbalist. But King's was written by an eclectic MD and was extensively revised by both an eclectic MD *and* an eclectic pharmacist - it's not considered the best classic herbal work there is for nothing.

The best recent herbal work? Forget MDs there, they concentrate on more or less irrelevant single constituents (that being what they're used to). Go for books written by herbalists, by people who work with whole plants and with whole people. The ones I've found worthwhile are listed in the

[medicinal herbfaq.](#)

The Fine Print: scanned texts

Yes, it *is* possible to copyright scanned texts, even where copyright for the printed version has expired. If it were not, *nobody* would bother to scan any of these olde ones. Because in that world, the minute you'd put your hundreds of hours worth of scanning, OCR'ing and html'ing online, some busybody would copy it over to his/her site. And/or flog a CD of it. Without even so much as a by your leave. Because they'd be legally entitled to, right? Funny how *right* and *wrong* never seems to enter into it.

Talking of legally entitled: Paul Bergner has the full text of *King's American Dispensatory* (from this site) on his MH Resource CD. That CD also features the full text of Paul Bergner's excellent journal *Medical Herbalism*, and his scan of *Cook's Physiomedical Dispensatory*: http://www.medherb.com/full_text.htm. It's excellent value for your money.

Back to those entrepreneurs. I haven't scanned these works for busybodies to make money off them; I've scanned them because I want to, and because I like the full-text searchability of them. If *you* want the full text of one or the other classic text on your site, why, scan one. Locke's Syllabus Materia Medica might be good; or try anything by the Lloyd brothers, or by Ellingwood. Or Hager's Handbuch, if you can find it in English. Or any of the journals that are repeatedly mentioned in King's. The best years are from 1880 through to 1930 or so. Really, there's lots of good herbal books at your local antiquarian's, or over at <http://abebooks.com> or <http://bibliofind.com>. Send me the URL after you've gotten a good start (say, 100 pages or so online), and I'll link to you. If that's not feasible, well, you *may* copy a few pages (less than ten) of the larger works to your site, but if you do, you *have* to link back to this page from every page you've taken. The URL to link to is <http://www.ibiblio.org/herbmed/eclectic/main.html>.

Classic herbal texts on other sites

- For some historical perspective read this article by Francis Brinker: <http://www.eclecticherb.com/periscop.htm>
- Michael Moore has lots of olde works on his [SWSBM](#) site. (You'll find the ones marked * as .html-files in the upper regions of this page.)
 - Books: *[Felter](#), *[Ellingwood](#), *[Petersen](#), [Fyfe](#), [Culbreth](#), and *[Sayre](#),
 - Periodicals: (*)[Ellingwood's therapist](#), (*)[American Journal of Pharmacy](#), *[Transactions of the Nat'l Eclectic Medical Assoc.](#),
 - *and* others: [Other Manuals](#), [SWSBM](#)
- David Winston has some old works on his site, including [Felter's Syllabus](#) and excerpts from Locke's Materia Medica: http://www.herbaltherapeutics.net/herbal_therapeutics_library.htm
- There's a new trend out there: scan enormous old encyclopaediae and have people spellcheck them online. I've seen two such efforts so far - kudos to both projects:
 - in German: **Meyers Konversations-Lexikon**. 1888-1889. 16 Bände, 16000 Seiten. Hier: <http://susi.e-technik.uni-ulm.de:8080/meyers/servlet/index>
 - in Swedish: **Nordisk familjebok**, Konversationslexikon och realencycopedi. 1876-1899, 20 band; 1904-1926, 38 band; totalt 45000 sidor. Här: <http://www.lysator.liu.se/runeberg/nf/>

- Maude Grieve's Modern Herbal from 1931 should be mentioned here, even if it's almost a modern work: <http://www.botanical.com/botanical/mgmh/mgmh.html>
- Michael Tierra's [Planetherbs](#) site currently boasts one classic work of interest: Eli Jones' "[Cancer - Its causes, symptoms and treatment](#)".
- Culpeper's "The English Physitian" from 1652 is online: <http://www.med.yale.edu/library/historical/culpeper/culpeper.htm>
- Paul Bergner's Culpeper-to-modern Plant Names page: http://medherb.com/culpeper_names.html
- Dioskorides' Materia Medica
 - Julius Berendes' 1902 German translation: <http://www.tiscalinet.ch/materiamedica/>
 - The very first pages of John Goodyer's 1655 middle English translation, from the 1933 Gunther edition: <http://heronbotanicals.com/links/hblinks.html>
- You'll find a library of online Homeopathic works here: http://www.homeopathyhome.com/reference/books_online.shtml - NOTE: homeopathy is not herbalism.
- Resources of the Southern Fields and Forests, being alsoa Medical Botany of the Confederate States by Francis Peyre Porcher, 1833: <http://docsouth.unc.edu/imls/porcher/porcher.html>
- Kräuterbuch von Jacobus Theodorus "Tabernaemontanus" anno 1625 - 1600 pages, 3000 plants (they're still working on it - typing by hand, this kind of text can't be scanned), in German: <http://www.kraeuter.ch/>
- Part of Purdue's Newcrop site: [The Herb Hunters Guide](#) by A.F. Sievers, 1930.
- Köhler's is a good picture book:
 - one version: <http://ridgwaydb.mobot.org/mobot/rarebooks/title.asp?relation=QK99A1K6318831914> (287 images) - and they have the full text of Köhler's online, too.
 - another: <http://pharm1.pharmazie.uni-greifswald.de/allgemei/koehler/koeh-sta.htm> (282 images)
 - another: <http://www.biologie.uni-hamburg.de/b-online/koehler/koeh-sta.htm> (146 images)
- Ooooh. Shiny! Kurt Stüber's pages include *lots* of German botanical works von anno dazumal: http://www.mpiz-koeln.mpg.de/~stueber/stueber_library.html
 - among them a very good German picture book, Otto Wilhelm Thomé, 1885-1905: <http://www.mpiz-koeln.mpg.de/~stueber/thome/index.html>
 - and yet another version of Köhler's (124 images, at 1-2 MB per image): <http://www.mpiz-koeln.mpg.de/~stueber/koehler/index.html>
 - and Siebold's Flora Japonica, 1870: <http://www.mpiz-koeln.mpg.de/~stueber/siebold/flora3/index.html>
- Another German picture book, Fuchs Botanical, 1545: <http://www.med.yale.edu/library/historical/fuchs>

- Paintings from Curtis' Botanical Magazine, running from 1787 to 1807:
<http://www.nalusda.gov/curtis/>
- The Indian Household Medicine Guide, by J. I. Lighthall, 1883:
<http://www.meridianinstitute.com/echerb/Files/classics/lighthall/contents.html>
- There are lots of old (and new) pharmaceutical and botanical texts at the University of Braunschweig; unfortunately, they are scanned .gifs, not OCR'd .html files, which makes downloads expensive and reading cumbersome - unless you have broadband, of course. For pharmaceutical texts, try <http://sun250.biblio.etc.tu-bs.de/pharma.htm>; for botanical ones go for <http://sun250.biblio.etc.tu-bs.de/botanik.htm>.

Among the pharmaceutical works these are worth mentioning:

- Baillièrre et Fils, 1866: Codex medicamentarius - Pharmacopée française.
<http://www.digibib.tu-bs.de/2676-9024/start.htm>
- Friedrich A. Flückiger: Lehrbuch der Pharmakognosie des Pflanzenreichs: 1867. <http://www.digibib.tu-bs.de/2231-2886/start.htm>
1883, 2. Aufl. <http://www.digibib.tu-bs.de/Ab-175/start.htm>
- Wilibald Artus, 1876: Hand-Atlas sämtlicher medicinisch-pharmaceutischer Gewächse, 5. Aufl. 1. Band. <http://www.digibib.tu-bs.de/1425-1298/start.htm>
2. Band. <http://www.digibib.tu-bs.de/1425-1308/start.htm>
- Hermann Hager, Handbuch der Pharmaceutischen Praxis:
1. Theil, 1876. [http://www.digibib.tu-bs.de/Aa-5226-a\(1\)/start.htm](http://www.digibib.tu-bs.de/Aa-5226-a(1)/start.htm)
2. Theil, 1878. [http://www.digibib.tu-bs.de/Aa-5226-a\(2\)/start.htm](http://www.digibib.tu-bs.de/Aa-5226-a(2)/start.htm)
Technik der Pharmaceutischen Receptur, 5. Aufl., 1890:
<http://www.digibib.tu-bs.de/Ab-220/start.htm>
- G. Pabst: Köhler's Medizinal-Pflanzen, 1887, also with the complete text:
Band 1. <http://www.digibib.tu-bs.de/3202-0935/start.htm>
Band 2. <http://www.digibib.tu-bs.de/3202-0948/start.htm>
Band 3 (Ergänzungsband). <http://www.digibib.tu-bs.de/3202-0951/start.htm>
- O. Schlickum, 1886: Kommentar zur 2. Auf. der Pharmacopoea Germanica.
<http://www.digibib.tu-bs.de/2231-3995/start.htm>
- Julius Berendes, 1902: Des Pandanios Dioskurides aus Anazarbos Arzneimittellehre aus fünf Büchern. <http://www.digibib.tu-bs.de/2700-1943/start.htm>
- Edmund White, John Humphrey, 1904: Pharmacopodia - A Commentary on the British Pharmacopodia 1898: <http://www.digibib.tu-bs.de/2708-3026/start.htm>
- Scans of ancient works, for instance a 1585 Italian translation of an even earlier Portuguese history of medicinal plants: <http://www.abocamuseum.it/bibliothecaantiqua/prodotti.asp>
- Earthly Pursuits: a few old gardening books:
<http://www.earthlypursuits.com/Books/OldBooklibrary.htm>
- More scans of ancient works, these at the Bodleian Library:
<http://www.bodley.ox.ac.uk/dept/scwmss/wmss/medieval/browse.htm>

I've seen parts of Gerard's Herball online, but that's mainly been some [culinary bits](#) (Cindy has *lots* of other older culinary texts online, and links to even more).

[Home](#) - [Herb FAQs](#) - [Articles](#) - [Classic texts](#) - [Archives](#) - [Links I like](#) - [Pictures](#) - [Plant names](#)





Mailing list / Newsgroup archives

Last updated 22Dec03 - Have a comment? [Tell me](#).

Rainy day, with 56 channels and nothing on? Get a couple herbal mailing list or newsgroup archives here and start reading. If you download them all you'll even make it through a month or four of being snowed in, in that mountain cabin.

You'll find a list of all the public herbal forums I'm aware of in the medicinal herbfaq, [part 8.1](#). Have fun! The archive files are also available in my [FTP](#) space, and on the mirror in [Japan](#).

Henriette

The Best of the Herbal Forums

I've long been thinking about making these archives actually useful, as opposed to just archiving it all blindly. So here they are: [the Best of the Herbal Forums](#) -files. That is, the best as I perceive them. You might still want to plod through the complete archives.

There's currently only a few monthly sets online. I'll add more of the older ones as I find time; and I don't expect it'll be all that much work to add new archive files as they accrue, so to speak. After all, I've been doing the [BoRHOD](#) files for - is it three years already? Four, you say? My, doesn't time fly.

Enjoy!

The medicinal herblist (The Medicinal and Aromatic Plants Discussion List) archives

(Formerly the herb@franklin.oit.unc.edu -list. Before that it was the herb@mylist.net -list and the list at herb@vm.ege.edu.tr)

Please read this before posting: [Rules of the Game](#)

Latest archive file available: [log0307.zip](#). Have a look at the other medicinal herblist logs in [WWW](#) space.

You can subscribe, unsubscribe, and set list options on the web. The URL is: <http://lists.ibiblio.org/mailman/listinfo/herb>

Or write to herb-request@lists.ibiblio.org with only the following text:
subscribe

The herb-2 -list

is found here: <http://lists.ibiblio.org/mailman/listinfo/herb-2>

Or write to herb-2-request@lists.ibiblio.org with only the following text:
subscribe

This list has fewer members than the main herblist, but posting rules (like "no html" and "don't quote the full text of the message you're replying to") are practically non-existent.

Alt.folklore.herbs archives

You can subscribe to newsgroups if

- your ISP (Internet service provider) carries them and
- you have a newsreader.

If both are true for you, and your browser is configured as your newsreader, you can see what's generally posted in this newsgroup by clicking here: <news:alt.folklore.herbs>.

The name might throw you - nothing to do with folklore, it's *the* newsgroup for medicinal herbs, even if there's a culinary herb thrown in every now and then. In this [WWW](#) -space you'll find the monthly zipfiles from 1993 to 2001.

This group is **no longer archived**, because 1) there is overmuch quoted text 2) I no longer read afh, and 3) it's all on [googlegroups](#), anyway.

The HerblInfo -list archives

A now defunct list. List archives from 1997 through 2000 here: [WWW](#).

Archives slow: The culinary herblist

A currently very dormant list. List archives from 1996 to 2001 here: [WWW](#). No longer archived.

To subscribe: write to herbs-l-request@orednet.org with only the following text: subscribe

[Home](#) - [Herb FAQs](#) - [Articles](#) - [Classic texts](#) - [Archives](#) - [Links I like](#) - [Pictures](#) - [Plant names](#)





Links I like.

Last updated 25Apr04 - links last checked 22Dec03 - Have a comment? [Tell me](#).

Feel free to link to my site if you like it -- the URL is <http://www.ibiblio.org/herbmed> .

Feel free to send me URLs to check out for inclusion on this page. Note, however, that I don't do reciprocal links.

That means that you'll *really* only find links to sites I like on this page. Note also that I only link to commercial sites if they have no blinking or moving text, no moving pictures, and *lots* of information.

Herbal medicine - [Good Materia Medicas](#) - [Botany](#) - [Culinary herbs](#) - [Other fun things](#)

Herbal medicine, mostly

Herbalists

- Michael Moore - quality information on herbal medicine, including manuals, classic texts, and images: <http://www.swsbm.com>
- Jonathan Treasure's Herbal Bookworm includes critical in-depth reviews of major herbal sellers and herb-drug interaction info, among other things: <http://www.herbological.com>
- Paul Bergner's Medical Herbalism (see medicinal herbfaq [part 6.3](#)):
<http://www.medherb.com> - quality articles and links, geared towards the herbal practitioner
- David Winston's site: <http://www.herbaltherapeutics.net/> - *added 25Apr04*
- I like Charlie Kane's site: <http://tcbmed.com/> - it's got good info on herbs around Tucson, AZ, and nice pictures that remind me of the time I spent in the area. Cool!
- Christopher Hobbs: <http://www.christopherhobbs.com>
- Michael Tierra: <http://www.planetherbs.com> - mostly TCM -style herbal articles
- Howie Brounstein has articles on herbal smokes, fad herbs and wildcrafting:
<http://www.teleport.com/~howieb/howie.html>
- Robyn Klein's recommended reading site: <http://www.rrreading.com>
- Chanchal Cabrera: www.gaiagarden.com
- Rosemary Gladstar's Sagemountain site: <http://www.sagemountain.com>
- Brigitte Mars: <http://www.brigittemars.com>
- Tieraona Low Dog: <http://www.fihm.com>
- Susun Weed: <http://www.susunweed.com>

- Alan Tillotson: <http://www.oneearthherbs.com> - Ayurvedic herbal medicine, with an emphasis on herbs for the eye.
- Jaime De La Barrera: <http://www.infoherb.com>
- Todd Caldecott: <http://www.wrc.net/phyto/>
- Joshua Muscat's SanFran BotMed Clinic site: <http://www.sfbmc.org/>
- Hall Newbegin is cool, and he sells herbs'n'soaps'n'stuff: <http://www.juniperridge.com>
- J Mark Taylor: http://www.arcadyholistic.ca/yhnc_m.htm
- Graham White: <http://www.gcwhite.co.uk/herbs.htm>
- Jeanne Rose: <http://www.jeannerose.net>

Herbalist organizations:

- The National Institute of Medical Herbalists (NIMH) is online: <http://www.nimh.org.uk/>
- The European Herbal Practitioners Association (EHPA): <http://www.users.globalnet.co.uk/~ehpa>
- The National Herbalists Association of Australia (NHAA): <http://www.nhaa.org.au>
- The American Herbalists Guild (AHG) is found here, these days: <http://www.americanherbalistsguild.com/>
- The Ontario Herbalists Association (OHA): <http://www.herbalists.on.ca/>
- The International Register of Consultant Herbalists and Homoeopaths: <http://www.irch.org>
- New Zealand Association of Medical Herbalists (NZAMH): <http://nzamh.org.nz/>

Databases

- Go for Jim Duke's Phytochemical and Ethnobotanical Databases: <http://www.ars-grin.gov/duke>
- Or try Dan Moerman's Native American Ethnobotany Database: <http://herb.umd.umich.edu>
- The [herbmed database](#) used to be useful, but now it says "licensed content" for most entries, and "database error" for the rest. Sad, that - but it's simply not worth a visit anymore.

Other

- Try the Herb Research Foundation, with their slant towards scientific phytotherapy: <http://www.herbs.org> - *you need to read Jonno's review of [the Honest Herbal](#) before you decide to buy any of Tyler's work, and read Jonno's review of the [Comm. E Monographs](#) before deciding to buy that exceedingly expensive set of committee compromises.*
- The Herb Society of America has nice pages: <http://www.herbsociety.org>
- The Present Moment site has some good herbal articles:

http://www.presentmoment.com/article/toc_health..html - check, for example, the horehound article. Heh.

- The Merck Manual, 17th edition, is online at:
<http://www.merck.com/mrkshared/mmanual/sections.jsp>
- A comprehensive glyceic index page is found here:
<http://diabetes.about.com/library/mendosagi/nmendosagi.htm> - you need this if you have blood sugar problems.
- A site with tapes of conferences: <http://www.botanicalmedicine.org/> and a conference calendar: <http://www.botanicalmedicine.org/conferences/index.htm>
- The herbalchem site dives into the chemistry of herbs: <http://www.herbalchem.net/>
- Most of the Suite101 article collections are worthwhile, especially if you're new to herbs. Check, for instance, these: [historical plants](#) - [herbal medicine](#) - [herbalism](#) - [herbal healing](#) (Susun Weed) - [botanical](#) - or just do a search for "botanical medicine" here:
<http://www.suite101.com>

[Herbal medicine](#) - [Good Materia Medicas](#) - [Botany](#) - [Culinary herbs](#) - [Other fun things](#)

Good Materia Medicas

- In addition to Michael Moore's own Materia Medica (manuals) you'll find olde Eclectic tomes (other manuals, Felter, Ellingwood, Fyfe, Culbreth ...) on his site:
<http://www.swsbm.com>
- A nice materia medica with accompanying therapeutics: <http://www.herbs2000.com>
- Nope. Healthy.net is *still* spamming.
- David Hoffmann's Materia Medica is found here:
<http://www.npicenter.com/library/herbal/materiamedica>
- All herb-related bits of King's American Dispensatory (1898) are here:
<http://www.ibiblio.org/herbmed/eclectic/kings/intro.html> (yes, it's part of this site.)
- A Himalayan herb site: <http://www.himalayahealthcare.com/herbfinder/english.htm>
- A Modern Herbal (1931): <http://www.botanical.com/botanical/mgmh/mgmh.html>
- The Raintree Tropical Plant Database includes information on about 100 plants:
<http://www.rain-tree.com/plants.htm>
- The TCM Herbal Database from The Rocky Mountain Herbal Institute has info on about 220 commonly used Chinese herbs: <http://www.rmhiherbal.org/ai/pharintro.html>
- Healthnotes, widely available on the web; try
<http://www.pccnaturalmarkets.com/health/Index/Herb.htm>,
http://www.gnc.com/health_notes/Index/Herb.htm, or any of the other clones. Note that the Healthnote Files are slanted towards a "scientifically correct" way of thinking, ie. pharmaceutical industry; therefore the herbal files are overcautious and more or less

theoretical.

- Holisticonline has a rather comprehensive database here:
http://www.holisticonline.com/Herbal-Med/Hol_Herb_Directory_Index.htm
- Christine Haughton's files have been moving around a lot; let's hope they'll stay here for at least a little while: <http://www.purplesage.org.uk/>
- Phytotherapy: the herbal monographs of the Australian Naturopathic Network,
<http://www.ann.com.au/herbs/herbal.htm>
- More phytotherapy: practitioner-level information at <http://www.phytotherapies.org> (if you're a practitioner you can register and gain access to the info.)
- Mary O'Connell has compiled information on some Southwest Medicinal Plants:
<http://medplant.nmsu.edu/plantindex.htm>

Auf Deutsch

- Thomas Schoepke hat eine Botanische Datenbank inkl. den Anwendungsmöglichkeiten von Nutzpflanzen: http://www.pharmakobotanik.de/systematik/1_ti_reg/reg-arzn.htm
- Die Heilpflanzen-Suchmaschine: <http://www.heilpflanzen-suchmaschine.de>
- Die Bad Heilbrunner Selbstmedikationsdatenbank, highly technical, with about 150 plants and some vitamins: <http://tee.org>
- Das kleine Heilpflanzen-Brevier, about 50 plants, by Klaus Zoellner:
<http://www.rga-net.de/~zoellner> - *enable JavaScript if you want see the info. German language only.*
- Die kleine Kräuterhexe, eine recht sympatische Seite die Du auch herunterladen kannst:
<http://www.folk.de/kraeuterhexe>
- Heilpflanzenlexikon, Natur & Gesundheit: <http://www.natur-und-gesundheit.de/lexikon.htm>
- Das Kräuterlexikon bei Heilkräuter.de: <http://www.heilkraeuter.de/lexikon/index.htm>
- Materialien zum Thema Phytotherapie:
http://www.naturheilkunde-online.de/naturheilkunde/fachartikel/phyto_index.html

Other languages (fi - sv)

- 1001 solutions alternatives à des problèmes de santé:
<http://www.reseaproteus.net/fr/Solutions/PlantesSupplements/Index.aspx> - cool!
- Skyttaputtens urtesidor: <http://home.online.no/~gjessin/krydder.html>
- A Spanish site: Vademecum de Prescripción. Plantas Medicinales.
<http://www.fitoterapia.net/vademecum/index.html>
- An Italian site: Erboristeria Dulcamara: <http://www.erboristeriadulcamara.com/>

[Herbal medicine](#) - [Good Materia Medicas](#) - [Botany](#) - [Culinary herbs](#) - [Other fun things](#)

Botanical things

- Need to find a new scientific name from an old book, or see which plants are actually identical nowadays?
 - The GRIN taxonomy database is very good indeed, even if it does have a few interesting gaps here and there:
<http://www.ars-grin.gov/cgi-bin/npgs/html/taxgenform.pl>
 - If you're looking for plants found wild *somewhere* in the US, your best bet is the plants database at <http://plants.usda.gov/> - they're lumpers (yay!), but a tad too keen on adding the newest botanical binominals ASAP. Europeans are generally splitters (boo hiss!) but usually we wait a bit before introducing shiny new latin names, which often means we don't have to introduce them at all -- because botanists just can't make up their minds.
 - Here's an excellent site for algae: <http://www.algaebase.org/SpeciesSearch.lasso>
 - For the *Fabaceae*, the best database is Ildis: <http://www.ildis.org/LegumeWeb/>
 - Then there's tropicos: <http://mobot.mobot.org/W3T/Search/vast.html> - do pay attention to the "Author" part of the botanical name. While it does give a lot of synonyms it's not always clear on *which* of the results given is the currently correct botanical binominal. They also have way too many circular references (plant a? Nah, that's b these days. Nah, that's c these days. Nah, that's a these days. *Argh*, says I.)
 - The IPNI database can be helpful: http://www.ipni.org/ipni/query_ipni.html - current botanical binominals are given in comments only, which of course means that a lot of the entries don't have them.
 - The best Swedish botanical database is of course Den Virtuella Floran; if you're even close to being able to understand Swedish go have a look:
<http://linnaeus.nrm.se/flora/welcome.html>
 - CNIP is a good botanical database for Brazil:
http://150.161.125.13/db/pne_acc/st_geog.shtml
 - Lichens. The Index Fungorum also covers lichens - yay! Still no data on *Variolaria dealbata*, though. <http://www.indexfungorum.org/Names/NAMES.ASP> - *added 25Apr04*
 - Scott's botanical links: <http://www.ou.edu/cas/botany-micro/bot-linx/>
 - Russian wild nature (plants, fungi, animals); pages in Russian and English:
<http://rwn.boom.ru>
 - DELTA Descriptions of flowering plants, a treasuretrove for botanists:
<http://biodiversity.uno.edu/delta/angio/index.htm>
 - Flora Celtica, folkloric use of a lot of plants:
<http://rbg-web2.rbge.org.uk/celtica/dbase/genera/GENERA.HTM>
 - Some nice pictures by botanical family: <http://www.keiriosity.com/>
-

Culinary and gardening sites, mostly

- The Gardening Launch Pad: <http://gardeninglaunchpad.com>
- The GardenGuide pages: <http://www.gardenguides.com>
- The Weekend Gardener / The Official Seed Starting Homepage / Herb Seeds: <http://www.chestnut-sw.com/seeds/herbseed.htm>
- Here's an extensive site with a lot of information on culinary herbs and spices - just browse around: <http://www-ang.kfunigraz.ac.at/~katzer/engl/index.html>
- The Sustainable Farming Connection, a nice site for farmers: <http://ibiblio.org/farming-connection>
- Here's a very good site on soap-making: <http://www.millersoap.com>
- And here's a good selection of info on natural health and beauty: <http://www.geocities.com/HotSprings/Spa/3893/>

Not plants at all, but still fun

- Missing your daily dose of Calvin and Hobbes? At the official site they have reruns, from 10 years ago: <http://www.ucomics.com/calvinandhobbes/>
- Frazz rocks. It's the new Calvin and Hobbes. I'm itching to see it in print though: <http://www.comics.com/comics/frazz/>
- Schlock is extraordinary. It includes one of the best strip gags in any comic ever: <http://www.schlockmercenary.com/d/20010813.html> - but read it from the first strip to the current one, it's great.
- I spend some of my copious free time on <news:rec.humor.oracle.d>. Here's some gems from that ng: <http://ibiblio.org/herbmed/rhod/main.html>
- Recent columns by Dave Barry, at the Miami Herald: http://www.miami.com/mld/miamiherald/living/columnists/dave_barry/
- One of the greatest rants of all time (you *go*, Russ!): <http://www.eyrie.org/~eagle/writing/rant.html>
- Great site for website design: [Sarah's Kinda Helpful Web Site](#)

I've been entertained by the unitedHeroes folks for years, or at least it seems so. They do wacky or mysterious web serials (as in, written adventures). It's all free of charge, and it's also all great fun. Here's their tidbot:

No javascript? Oh well, here's the plain URL then: <http://www.unitedheroes.net>

Lovely Linux links

- Geek news:

- <http://slashdot.org/> - news for nerds.
- <http://www.theregister.co.uk/> - The Register: "biting the hand that feeds IT".
- Linux specific:
 - <http://www.suse.de/de/index.html> - SuSE.
 - newsgroup: <news:alt.os.linux.suse> - very helpful.
 - <http://www.kde.org/> - one of the desktop environments of linux distros - ooh, shiny! I *love* the file preview in the file manager.
- MySQL:
 - <http://dev.mysql.com/doc/mysql/en/index.html> - the online version of the manual is much better than the one included in your linux distribution, because it includes reader comments - examples, caveats, etc. Very helpful.
 - newsgroup (in German): <news:de.comp.datenbanken.mysql> + FAQ: <http://mysql-faq.sourceforge.net>
- PHP:
 - <http://www.php.net/manual/en/> - this manual, too, includes reader comments in the online version. Extremely good.
 - <http://pear.php.net/> - what CPAN is for perl, PEAR is for PHP - even if it's still young. Start with the manual.
 - newsgroup (in German): <news:de.comp.lang.php.datenbanken> + FAQ: <http://www.dclp-faq.de>

[Home](#) - [Herb FAQs](#) - [Articles](#) - [Classic texts](#) - [Archives](#) - [Links I like](#) - [Pictures](#) - [Plant names](#)





Henriette's Herbal Homepage

[Home](#) > Pictures

Pictures: [P01 \(a-anem\)](#) - [P02 \(anem-az\)](#) - [P03 \(b-ce\)](#) - [P04 \(cf-cyn\)](#) - [P05 \(cyp-eru\)](#) - [P06 \(erv-go\)](#) - [P07 \(gr-lar\)](#) - [P08 \(las-malv\)](#) - [P09 \(malv-ni\)](#) - [P10 \(nj-phys\)](#) - [P11 \(phyt-rho\)](#) - [P12 \(rhp-sco\)](#) - [P13 \(scp-thym\)](#) - [P14 \(thyn-z\)](#) - [Unknown](#) - [Misc](#) - [People](#) - [Fungi](#)

Henriette's plant photos

Last updated 17Jan04 - Have a comment? [Tell me](#).

26Nov03, major site update: I've added authors to the botanical binominals (prompted among other things by the [Illicium anisatum](#) confusion), added common names in languages other than English (mainly Finnish, Swedish and German, but there's some French and Italian, too), updated outdated latin names, put both names and image info into a MySQL database, and added a few PHP scripts which pull info from said database. The single picture pages don't take info from the database yet - that's an upcoming project. My heartfelt thanks to David Robley and [JR Conlin](#) for their help with PHP and MySQL.

[The plant name search](#)

which also includes links to URLs across this site,
and links to all the plant pics on this site.

Index pages: [pics.php](#)

- plants (sorted botanically): [P01 \(a-anem\)](#) - [P02 \(anem-az\)](#) - [P03 \(b-ce\)](#) - [P04 \(cf-cyn\)](#) - [P05 \(cyp-eru\)](#) - [P06 \(erv-go\)](#) - [P07 \(gr-lar\)](#) - [P08 \(las-malv\)](#) - [P09 \(malv-ni\)](#) - [P10 \(nj-phys\)](#) - [P11 \(phyt-rho\)](#) - [P12 \(rhp-sco\)](#) - [P13 \(scp-thym\)](#) - [P14 \(thyn-z\)](#)
 - some plants which I haven't been able to identify: [The Unidentifieds](#)
 - treasures, landscapes, fauna, etc.: [Misc](#)
 - Special Report: There's [baby greenfinches in my Clematis](#)
 - herbalists and people working with herbs: [People](#)
 - fungi: [Fungi](#)
-

Thumbnails: [thumbs.php](#)



A [abronia-actaea](#) - [actaea-ajuga](#) - [ajuga-aloyisia](#) - [alpinia-anemone](#) -
[anemone-araucaria](#) - [arcium-aronia](#) - [artemisia-asplenium](#) -
[asplenium-azadirachta](#) B [bacopa-brassica](#) C [brassica-calluna](#) - [calluna-carnegia](#)
- [carnegia-cetraria](#) - [chaenactis-cinnamomum](#) - [cinnamomum-codonopsis](#) -
[codonopsis-corydalis](#) - [corydalis-cynoglossum](#) D [cyperus-dicentra](#) E
[dichelostemma-echinacea](#) - [echinacea-epilobium](#) - [epilobium-eruca](#) F
[eryngium-fagonia](#) - [fagonia-fraxinus](#) G [fraxinus-gentiana](#) - [gentiana-gossypium](#)
H [gratiola-hibiscus](#) - [hibiscus-hyssopus](#) I [hyssopus-isatis](#) JKL [isatis-larrea](#) -
[lathyrus-levisticum](#) - [levisticum-lonicera](#) M [lonicera-magnolia](#) -



[magnolia-malva](#) - [malvaviscus-mentha](#) - [mentha-monarda](#) N [monarda-nepeta](#) - [nepeta-nigella](#) O
[nolina-orychophragmus](#) P [oryza-pedicularis](#) - [pediomelum-peucedanum](#) -



[peucedanum-physostegia](#) - [phyteuma-platanthera](#) -
[platycerium-prosopis](#) - [prostanthera-punica](#) QR
[pycnanthemum-rhododendron](#) - [rhus-rosa](#) - [rosa-rubus](#) S
[rubus-salvia](#) - [salvia-saponaria](#) - [saponaria-scorzonera](#) -
[scrophularia-solanum](#) - [solanum-stevia](#) T [stevia-tanacetum](#) -
[tanacetum-thymus](#) - [thysanocarpus-tropaeolum](#) UV [tropaeolum-vaccinium](#) -



[valeriana-viburnum](#) WXYZ [viburnum-zinnia](#)

Copyright © 1995-2004 Henriette Kress.

None of these pictures are public domain. None of these pictures are free.
 Personal use? Non-commercial use? Commercial use? Read the [fine print](#).

Thank you for your help with the IDs, *John on Vashon Island (WA, USA)*, [Howie Brounstein](#),
Akemi Yoko, *Leslie Ann Rose*, [John Goude](#), *Antti Hovi*, *Dr Gábor Turcsányi*, *Jack Belmont*, *Sally
 Perkins*, [Michael Moore](#), *Pier Jones*, *John F. Sorenson*, *Iris from Texas*, *Natalie Schutz*, [David
 Epple](#), "fellow plant lover", *Ricki Todd*, "sister Zeus", *Richard R. Old*, *Manfred Tillian*, *Pierre
 Mercan*, [Bartosz Pacula](#), *Martin Reith*, *Sirpa Nousiainen*, *Mark Richards*, *Esa Kalska*, *Petr Sutka*,
Arne Anderberg, *Jan De Langhe*.

The Fine Print: my photos

Henriette's plant photos are licensed under a [Creative Commons License](#),
 with the addendum that **German-language sites need to ask first**, as a
 German company holds exclusive German language-area internet rights to a
 lot of my pictures.



Personal use

You may copy pics for your own personal use, but you may not change them in any way. Note, personal use is just that. It does not include posting these photos to your favorite mailing list, webforum, or similar - that's republishing them, which is anything but personal. So you like these pics, and want others to see them, too? Post the URL, not the photo. Or, if you *have* to post the photo, non-commercially, of course, you *must* include this: "Photo copyright Henriette Kress, <http://www.ibiblio.org/herbmed>" with every posted image.

Non-commercial website use

Link and/or copy away. Two Three Four things to remember:

1. The pics may not be changed in any way. Three reasons for that: they contain embedded info (you can see it if your photo editing program can read IPTC), I want my name and URL to be legible, and I've made artistic decisions along the way, which changes would, umm, change. So don't. Thanks.
2. Do put this: "Photo copyright Henriette Kress, <http://www.ibiblio.org/herbmed>" right next to every picture you've used. Note, that should be a working link, not just text.
3. If you deeplink please link to the single picture .html pages instead of the images. Thanks.
4. German-language sites should ask first - a German company has exclusive German-area internet rights to a lot of my pics. Don't be in a tearing hurry, though, I'm not always in town.

That goes for *non*-commercial website use only. Commercial use, see below.

Other non-commercial use

Feel free to use my pics in your school homework projects and such. But don't change the pics in any way, and remember to put

"Photo copyright Henriette Kress, <http://www.ibiblio.org/herbmed>"

right next to every picture you've used. If it's show-and-tell type use like teaching and such, remember to add that same line to your handouts.

Commercial use

Rights to use pictures in online and print publications are one of the ways I put butter on my bread. [So ask me -- or make me an offer.](#)

Use in journals

If it's a journal for professional herbalists (EJHM, Medical Herbalism, and the like), use away. If you need larger pics just ask me - for those, I request a copy or two of the journal in return (unless I subscribe, in which case I expect the subscription be extended a tad). I'll also require photographer credits. Don't be in a tearing hurry, though - I'm not always in town.

Others? See commercial use. Yes, I do favor professional herbalists. I am one.

Technical details:

All photos here are taken with my Canon AE1 Program -camera, with a 35-70 mm zoom lens. I usually do slides, as I do [herb talks](#) (and herb walks, but I don't need slides for that). The oldest pics were copied to Kodak Photo-CD's, a couple of negatives in between were scanned with a negative scanner, older pics were scanned with a Polaroid SprintScan 35/LE, and newer pics are scanned with a Nikon LS-1000, using vuescan under Linux.

Pictures: [P01 \(a-anem\)](#) - [P02 \(anem-az\)](#) - [P03 \(b-ce\)](#) - [P04 \(cf-cyn\)](#) - [P05 \(cyp-eru\)](#) - [P06 \(erv-go\)](#) - [P07 \(gr-lar\)](#) - [P08 \(las-malv\)](#) - [P09 \(malv-ni\)](#) - [P10 \(nj-phys\)](#) - [P11 \(phyt-rho\)](#) - [P12 \(rhp-sco\)](#) - [P13 \(scp-thym\)](#) - [P14 \(thyn-z\)](#) - [Unknown](#) - [Misc](#) - [People](#) - [Fungi](#)

[Home](#) - [Herb FAQs](#) - [Articles](#) - [Classic texts](#) - [Archives](#) - [Links I like](#) - [Pictures](#) - [Plant names](#)





Plant name database

Data last updated 23Apr04 - Have a comment? [Tell me](#).

The plant names - you always did want to know what *Achillea millefolium* is called in Finnish, didn't you? Here's your chance ...

A bit of background on the Jan04 update: from Jun03 through Nov03 I went through all my pictures and gave them the currently correct botanical binominals, complete with genus, species and author, adding common names in any of a number of languages I speak, and a few that I don't. That exercise brought home to me just how many errors the old dinosaur of a plant name database contained, so I decided to do something about it. Here it is:

[The all shiny and new plant name search](#)

which also includes links to URLs across this site (not all that many yet, but that's changing),
and links to all the plant pics on this site.

That means that the delimited textfiles, uploadable into any good spreadsheet or database program, are no more.

Those of you who actually asked instead of just copying things wholesale from this site, do ask again; the lot is in MySQL now, which probably is what you use anyway. It's currently 9440 latin names (including 2368 synonyms) and 28266 common names.



Channels

- [Arts & Entertainment](#)
- [Automotive](#)
- [Cities & Towns](#)
- [Computing & Technology](#)
- [Education](#)
- [Food & Drink](#)
- [Health & Fitness](#)
- [History](#)
- [Hobbies & Games](#)
- [Home & Garden](#)
- [Homework Help](#)
- [Industry & Business](#)
- [Jobs & Careers](#)
- [Money](#)
- [News & Issues](#)
- [Parenting & Family](#)
- [People & Relationships](#)
- [Religion & Spirituality](#)
- [Shopping & Style](#)
- [Small Business](#)
- [Sports & Recreation](#)
- [Teens](#)
- [Travel](#)
- [About Japan](#)

Stay up to Date!

Subscribe to the **About Today newsletter** to get the latest tips, advice, and news delivered to your inbox every

day.



Search

[Home & Garden](#)



[Change is good, whether you're buying a new home or renovating your current space](#)

[10 Things to Avoid When Buying a Home](#) [First Steps to Renovating Your Kitchen](#) [How to Have a Garage Sale](#)

[Autos](#)

[Make the right decisions before you buy a new car or truck](#)



[Which SUV gets the Best Gas Mileage? How to Decide Which Car is Right For You](#) [Test Drive: 2004 Chrysler Crossfire](#)

[Jobs & Careers](#)

[Find the tips and advice you need to land your dream job](#)



[Is it Time to Quit Your Job? How to Write an Effective Resume](#) [How to Ace the Interview](#)

[Money](#)

[How to make the most of your financial situation](#)



[Financial Planning by Age](#) [How to Get Your Credit Report](#) [21 Ways to Save Money on Your Home](#)

[Arts & Entertainment](#)

[Get the inside scoop on what's hot in theaters and DVD this week](#)



[Interviews With the Cast of "Van Helsing"](#) [Should You Buy the "Kill Bill Vol. 1" DVD? Is "Mean Girls" Worth the Price of Admission?](#)

[Our Story](#) | [Be a Guide](#) | [Advertising Info](#) | [Investor Relations](#) | [Work at About](#) | [Help](#)

©2004 About, Inc. All rights reserved. A PRIMEDIA Company.

[User Agreement](#) | [Privacy Policy](#) | [Kids' Privacy Policy](#)

You are here: [About](#)>[Health & Fitness](#)



[Health & Fitness](#)

[Alternative /](#)

[Complementary Medicine](#)

[Alternative Medicine](#)

[Healthy Herbs](#) [Holistic](#)

[Healing](#)

[Disabilities](#)

[Back and Neck Injury /](#)

[Chronic Pain](#) [Deafness /](#)

[Hard of Hearing](#)

[Diseases / Conditions](#)

[AIDS / HIV](#) [Allergies](#)

[Alzheimer's Disease](#)

[Arthritis](#) [Asthma](#) [Attention](#)

[Deficit Disorder](#) [Autism /](#)

[Pervasive Developmental](#)

[Disorders](#) [Cancer](#)

[Cholesterol](#) [Chronic](#)

[Fatigue Syndrome /](#)

[Fibromyalgia](#) [Colon Cancer](#)

[Death and Dying](#) [Diabetes](#)

[Headaches / Migraine](#)

[Heart Disease / Cardiology](#)

[Heartburn](#) [Hepatitis](#)

[Infertility](#) [Irritable Bowel /](#)

[Crohn's Disease](#) [Multiple](#)

[Sclerosis](#) [Rare / Orphan](#)

[Diseases](#) [Sleep Disorders](#)

[Thyroid Disease](#)

[Fitness / Wellness](#)

[Bicycling](#) [Bodybuilding](#)

[Exercise](#) [Low Carb Diets](#)

[Low Fat Cooking](#) [Martial](#)

[Arts](#) [Men's Health](#)

[Nutrition](#) [Running /](#)

[Jogging](#) [Senior Health](#)

[Sexuality](#) [Spas](#) [Stress](#)

[Management](#) [Swimming](#)

[Tennis](#) [Vegetarian Cuisine](#)

[Walking](#) [Weight Loss](#)

[Medicine / Allied Health](#)

[Dentistry](#) [Dermatology](#)

[Nursing](#) [Orthopedics](#)

[Pediatrics](#) [Physical Therapy](#)

[Sports Medicine](#) [Veterinary](#)

[Medicine](#)

[Mental Health](#)

[Bipolar Disorder](#)

[Depression](#) [Divorce](#)

Search

[Health & Fitness](#)



Could You Be Diabetic?

Diabetes is a manageable disease, but only after you've been properly diagnosed and educated about appropriate treatment methods. First separate truth from myth, and then learn about how to take action.

[Ten Misconceptions About Diabetes](#) [Do You Have Low Blood Sugar?](#) [Recommended Tests for Type 1 and 2 Diabetes](#)

Health Resources

Healthy Living

[Diagnose Your Allergy Symptoms](#) [How to Prevent Heartburn](#) [Do You Think You Have Arthritis?](#)

Which Diet is Right for You?

[How to Choose a Diet That's Right for You](#) [How Many Calories is Too Many?](#) [8 Keys to Choosing a Low Carb Diet](#)

Women's Health

[6 Signs of Early Pregnancy](#) [20 Tips for Preventing Medical Errors](#) [Is a Hysterectomy the Only Option?](#)

What Our Readers Think

Most Popular Articles

[The Pregnancy Calendar](#) [Depression Screening Quiz](#) [Girl Baby Names - Find a Name](#) [The South Beach Diet](#) [Women's Health Symptoms Guide - What do my symptoms mean?](#)

What's Hot Now

[Herbal Encyclopedia A to Z](#) [Eye Strengthening Exercises -- Part 2](#) [Antidepressant Medications for Children: Information for Par...](#) [Mothers Day](#)

[Support Mental Health Resources](#) [Panic / Anxiety Disorders](#)

[Email Greeting Cards](#) [Ultrasound Pictures](#)

[Recovery / Addiction](#)

[Abuse / Incest Support](#)

[Alcoholism / Substance](#)

[Abuse Smoking Cessation](#)

[Special Partners](#)

[PMDD](#)

[Women's Health](#)

[Breast Cancer Pregnancy /](#)

[Birth Women's Health](#)

[Topic Index](#) |



[email to a friend](#)



font size



[back to top](#)

[Our Story](#) | [Be a Guide](#) | [Advertising Info](#) | [Investor Relations](#) | [Work at About](#) | [Help](#)

©2004 About, Inc. All rights reserved. A PRIMEDIA Company.

[User Agreement](#) | [Privacy Policy](#) | [Kids' Privacy Policy](#)

You are here: [About](#)>[Health & Fitness](#)>[Healthy Herbs](#)>[Herb Profiles / Monographs](#)



[Home](#)

[Essentials](#)

[A - Z Encyclopedia](#)[Submit A Feature](#)

[Article](#)[Aromatherapy](#) [Free Herb Graphics](#)[Submit a Recipe!](#)

[Browse Categories](#)

[Basics For Beginners](#)[Find A Condition Or Symptom](#)[Herb Profiles / Monographs](#)[Consumer Safety / Toxicolog](#)[Aromatherapy](#)[Preparations And Recipes](#)[Herbal Schools](#)[Homeopathy](#)[Home And Garden](#)[Flower Essences](#)[Research](#)[Family And Pets](#)[Wild Herbs](#)[Traditional Ethnic](#)[Popular Herbs](#)

[Buyer's Guide](#)

[Before You Buy](#)[Top Picks](#)[Top 3 Essential Oil Brands](#)[Topical Pain Relief Products](#)[Product Reviews](#)

[Articles](#)

[Forums](#)

[Help](#)

Stay Current

Subscribe to the **About** Healthy Herbs newsletter.

[Topic Index](#) |

[email to a friend](#) [font size](#)

[Our Story](#) | [Be a Guide](#) | [Advertising Info](#) | [Investor Relations](#) | [Work at About](#) | [Help](#)

©2004 About, Inc. All rights reserved. A PRIMEDIA Company.

[User Agreement](#) | [Privacy Policy](#) | [Kids' Privacy Policy](#)

Search

[Healthy Herbs](#)

A - Z Encyclopedia



Image Copyright © Juli Kight 2003

[Herbs](#)

[Essential Oils](#)

[Chinese Patent Medicines](#)

[Phytochemicals](#)



From [Juli Kight](#),
Your Guide to [Healthy Herbs](#).

RATE THIS ARTICLE

Would you recommend this article?

Not at all Definitely

1 2 3 4 5

Most Popular Articles

[Spring Cleansing Herbal Encyclopedia A to Z](#)[Herb Encyclopedia A to Z](#)[Horny Goat Weed - Epimedium sagittatum](#)[Itchy Skin - Dermatitis](#)

What's Hot Now

[Herbal Encyclopedia A to Z](#)[Spring Cleansing](#)



Search
[Healthy Herbs](#)



Contribute An Article!



Submit and share your expertise and experience on herbs, aromatherapy, flower essences and homeopathy. All submissions will be subject to approval. Advertisements, product promotions and business opportunity solicitations of any kind will not be accepted. Be sure to read the [agreement at the bottom of this page](#).

First Name:

Last Name:

Email Address:
Would you like your E-mail address displayed?

Yes
No

Would you like your URL displayed?

Yes
No

Website URL:

How would you like your byline to read?

Display My Full Name
First Name Only
Use Nickname:

Enter your article here. (200 line limit)



About

- [Home](#)
- [Essentials](#)
- [A - Z Encyclopedia](#)[Submit A Feature Article](#)[Aromatherapy](#)[Free Herb Graphics](#)[Submit a Recipe!](#)
- [Browse Categories](#)
- [Basics For Beginners](#)[Find A Condition Or Symptom](#)[Herb Profiles / Monographs](#)[Consumer Safety / Toxicology](#)[Aromatherapy Preparations](#)[And Recipes](#)[Herbal Schools](#)[Homeopathy](#)[Home And Garden](#)[Flower Essences](#)[Research](#)[Family And Pets](#)[Wild Herbs](#)[Traditional Ethnic](#)[Popular Herbs](#)
- [Buyer's Guide](#)
- [Before You Buy](#)[Top Picks](#)[Top 3 Essential Oil Brands](#)[Topical Pain Relief Products](#)[Product Reviews](#)
- [Articles](#)
- [Forums](#)
- [Help](#)

Most Popular Articles

- [Spring Cleansing Herbal Encyclopedia](#)
- [A to Z Herb Encyclopedia](#)
- [A to Z Horny Goat Weed - Epimedium sagittatum](#)[Ichthy](#)
- [Skin - Dermatitis](#)

What's Hot Now

- [Herbal Encyclopedia](#)
- [A to Z](#)[Spring Cleansing](#)

Stay Current

Subscribe to the [About Healthy Herbs](#) newsletter.

I certify that I am the author or sole owner of the material I am submitting to About.com. About.com and its licensees may reproduce, distribute, publish, display, edit, modify, create derivative works and otherwise use the material for any purpose in any form and on any media. I agree to indemnify About.com for all damages and expenses that may be incurred in connection with the material. For more information, please see our [user agreement](#).



From [Juli Kight](#),
Your Guide to [Healthy Herbs](#).

RATE THIS ARTICLE

Would you recommend this article?

Not at all 1 2 3 4 5 Definitely

[Topic Index](#) |

[email to a friend](#)

font size



[back to top](#)

[Our Story](#) | [Be a Guide](#) | [Advertising Info](#) | [Investor Relations](#) | [Work at About](#) | [Help](#)

©2004 About, Inc. All rights reserved. A PRIMEDIA Company.

[User Agreement](#) | [Privacy Policy](#) | [Kids' Privacy Policy](#)

[Search](#)

[Healthy Herbs](#)

[Email to a friend](#)[Print this page](#)

[Newsletters](#)

Most Popular Articles

[Spring Cleansing Herbal Encyclopedia A to Z](#)[Herb Encyclopedia A to Z](#)[Horny Goat Weed - Epimedium sagittatum](#)[Itchy Skin - Dermatitis](#)

What's Hot Now

[Herbal Encyclopedia A to Z](#)[Spring Cleansing](#)



[Home](#)

[Essentials](#)

[A - Z Encyclopedia](#)[Submit A Feature Article](#)[Aromatherapy Free Herb Graphics](#)[Submit a Recipe!](#)

[Browse Categories](#)

[Basics For Beginners](#)[Find A Condition Or Symptom](#)[Herb Profiles / Monographs](#)[Consumer Safety /](#)

[Toxicology](#)[Aromatherapy Preparations And Recipes](#)[Herbal Schools](#)[Homeopathy](#)[Home And Garden](#)[Flower Essences](#)[Research](#)[Family And Pets](#)[Wild Herbs](#)[Traditional Ethnic](#)[Popular Herbs](#)

[Buyer's Guide](#)

[Before You Buy](#)[Top Picks](#)[Top 3 Essential Oil Brands](#)[Topical Pain Relief Products](#)[Product Reviews](#)

[Articles](#)

[Forums](#)

[Help](#)

Stay Current

Subscribe to the **About** Healthy Herbs newsletter.

Aromatherapy Center



From [Juli Kight](#),
Your Guide to [Healthy Herbs](#).

[General Information - Page 1](#)

[Articles - Page 2](#)

[Essential Oil Use Charts And Profiles - Page 3](#)

[Book Reviews - Page 4](#)

[Herbs and Oils - Oil Basics](#)

[Herbs And Oils - A Closer Look At Carrier Oils](#)

[How To Test Essential Oil Purity](#)

[Essential Oil Applications](#)

[Useful Measurements](#)

[About "Notes"](#)

[Essential Oil Applications](#)

- [1](#)
- [2](#)
- [3](#)
- [4](#)
- [Next](#)

RATE THIS ARTICLE

Would you recommend this article?

Not at all Definitely

1 2 3 4 5

[Topic Index](#) |

[email to a friend](#) font size

[Our Story](#) | [Be a Guide](#) | [Advertising Info](#) | [Investor Relations](#) | [Work at About](#) | [Help](#)

©2004 About, Inc. All rights reserved. A PRIMEDIA Company.

[User Agreement](#) | [Privacy Policy](#) | [Kids' Privacy Policy](#)



Search

[Healthy Herbs](#)



Free bars and dividers for your personal use.
Julie Kight



Free bars and dividers for your personal use.
Julie Kight

[Email to a friend](#)[Print this page](#)

[Newsletters](#)

Most Popular Articles

[Spring Cleansing Herbal Encyclopedia A to Z](#)[Herb Encyclopedia A to Z](#)[Horny Goat Weed - Epimedium sagittatum](#)[Itchy Skin - Dermatitis](#)

What's Hot Now

[Herb Encyclopedia A to Z](#)[Spring Cleansing](#)

Q. Where Can I Find Free Herb Graphics?



From [Juli Kight](#),
Your Guide to [Healthy Herbs](#).

A.

I have created free graphics for your personal use only.

[Hand Drawn Herbs](#)

[Unique Mouse Drawn Herbs, Bars and Buttons](#)

[Scanned Images](#)



[Home](#)

[Essentials](#)

[A - Z Encyclopedia](#)[Submit A Feature Article](#)[Aromatherapy](#) [Free Herb Graphics](#)[Submit a Recipe!](#)

[Browse Categories](#)

[Basics For Beginners](#)[Find A Condition Or Symptom](#)[Herb Profiles / Monographs](#)[Consumer Safety /](#)

[Toxicology](#)[Aromatherapy](#)[Preparations And Recipes](#)[Herbal Schools](#)[Homeopathy](#)[Home And Garden](#)[Flower](#)

[Essences](#)[Research](#)[Family And Pets](#)[Wild Herbs](#)[Traditional Ethnic](#)[Popular Herbs](#)

[Buyer's Guide](#)

[Before You Buy](#)[Top Picks](#)[Top 3 Essential Oil Brands](#)[Topical Pain Relief Products](#)[Product Reviews](#)

[Articles](#)

[Forums](#)

[Help](#)

Stay Current

Subscribe to the **About** Healthy Herbs

newsletter.

[Free Herbal Gift Tags](#)

[Newer Gift Tags](#)

[FAQ Index](#)

RATE THIS ARTICLE

Would you recommend this article?

Not at all

Definitely

1 2 3 4 5

[Topic Index](#) |



[email to a friend](#)



font size



[back to top](#)

[Our Story](#) | [Be a Guide](#) | [Advertising Info](#) | [Investor Relations](#) | [Work at About](#) | [Help](#)

©2004 About, Inc. All rights reserved. A PRIMEDIA Company.

[User Agreement](#) | [Privacy Policy](#) | [Kids' Privacy Policy](#)

You are here: [About](#)>[Health & Fitness](#)>[Healthy Herbs](#)>[Preparations And Recipes](#)>[Preparation Methods](#)

Search
[Healthy Herbs](#)



All graphics created and Copyright © 1999-2003 Juli Kight



[Home](#)

[Essentials](#)

[A - Z Encyclopedia](#)[Submit A Feature](#)

[Article](#)[Aromatherapy Free Herb Graphics](#)[Submit a Recipe!](#)

[Browse Categories](#)

[Basics For Beginners](#)[Find A Condition Or Symptom](#)[Herb Profiles / Monographs](#)[Consumer Safety / Toxicolog](#)[Aromatherapy](#)[Preparations And Recipes](#)[Herbal Schools](#)[Homeopathy](#)[Home And Garden](#)[Flower Essences](#)[Research](#)[Family And Pets](#)[Wild Herbs](#)[Traditional Ethnic](#)[Popular Herbs](#)

[Reader Recipe Submissions](#)

Add your own recipe to share.



[Teas & Tinctures](#)

[Essential Oils](#) [Body and Bath](#)

[Healthy Eating](#)

[Preparations Measurements](#)

Most Popular Articles

[Spring Cleansing Herbal Encyclopedia A to Z](#)
[Herb Encyclopedia A to Z](#)
[Horny Goat Weed - Epimedium](#)

[Buyer's Guide](#)

[Before You Buy](#) [Top Picks](#) [Top 3 Essential Oil](#)

[Brands](#) [Topical Pain Relief](#) [Products](#) [Product](#)

[Reviews](#)

[Articles](#)

[Forums](#)

[Help](#)

Stay Current

Subscribe to the **About** Healthy Herbs
newsletter.



Honeysuckle / Sinus
Chrysanthemum Help
Tea

Digestion Tea

Echinacea
Tincture

Hack Away

Rest Easy
Tincture

Calendula Ghee
Oil

Herbal Shampoo
Base

Lip Balm Base -
Green Drink

Salt Glow Body
Scrub

Skin Toner Base -
Using cider vinegar.

Soap (dry skin
bars)

Ghee (Clarified
Butter)

How To Calculate
Dosage Amounts

How To Prepare
Harvested Herbs

How To Make
Tinctures

Measurements /
Conversions

[sagittatum](#) [Itchy
Skin -
Dermatitis](#)

**What's Hot
Now**

[Herbal
Encyclopedia](#)
[A to Z](#) [Spring
Cleansing](#)



From [Juli Kight](#),
Your Guide to [Healthy Herbs](#).

RATE THIS ARTICLE

Would you recommend this article?

Not at all

Definitely

1 2 3 4 5

[Topic Index](#) |



[email to a friend](#)



font size



[back to top](#)

[Our Story](#) | [Be a Guide](#) | [Advertising Info](#) | [Investor Relations](#) | [Work at About](#) | [Help](#)

©2004 About, Inc. All rights reserved. A PRIMEDIA Company.

[User Agreement](#) | [Privacy Policy](#) | [Kids' Privacy Policy](#)

You are here: [About](#)>[Health & Fitness](#)>[Healthy Herbs](#)



[Home](#)

[Essentials](#)

[A - Z Encyclopedia](#)[Submit A Feature Article](#)[Aromatherapy](#)[Free Herb Graphics](#)[Submit a Recipe!](#)

[Browse Categories](#)

[Basics For Beginners](#)[Find A Condition Or Symptom](#)[Herb Profiles / Monographs](#)[Consumer Safety / Toxicolog](#)[Aromatherapy](#)[Preparations And Recipes](#)[Herbal Schools](#)[Homeopathy](#)[Home And Garden](#)[Flower Essences](#)[Research](#)[Family And Pets](#)[Wild Herbs](#)[Traditional Ethnic](#)[Popular Herbs](#)

[Buyer's Guide](#)

[Before You Buy](#)[Top Picks](#)[Top 3 Essential Oil Brands](#)[Topical Pain Relief Products](#)[Product Reviews](#)

[Articles](#)

[Forums](#)

[Help](#)

Stay Current

Subscribe to the **About** Healthy Herbs newsletter.

[Topic Index](#) |

 [email to a friend](#)  font size

[Our Story](#) | [Be a Guide](#) | [Advertising Info](#) | [Investor Relations](#) | [Work at About](#) | [Help](#)

©2004 About, Inc. All rights reserved. A PRIMEDIA Company.

[User Agreement](#) | [Privacy Policy](#) | [Kids' Privacy Policy](#)

Search

[Healthy Herbs](#)

Basics For Beginners

Resources and information for beginning herbalists.

Articles & Resources

Sort By : [Guide Picks](#) |

[Alphabetical](#) | [Recent](#)

[Medicinal Plant and Flower](#)

[Image Gallery](#) A collection of herb images from the wild and garden.

[What's In Your](#)

[Backyard?](#) Many weeds are herbs. This is a collection of what I have been finding in my backyard. You may also send me images of what's in your backyard.

More Categories

[Herbal Preparations / Recipes @](#)

[Top Herbalists \(8\)](#)

[back to top](#)

Search

[Healthy Herbs](#)

Find A Condition Or Symptom

Find A Condition Or Symptom

Articles & Resources

Sort By : Guide Picks |

[Alphabetical](#) | [Recent](#)

[Fending Off The Fleas](#) Overview of the flea problem, how to check for them and safety of natural products.

[Rescue Remedy](#) The original rescue remedy and using it with pets.

[Stress-Relieving Holistic Blends for Dogs](#) Contributed by Francoise Rapp, Internationally renowned aromatherapist and alchemist.

[Alliums \(Onions and Garlic\) Cause Anemia](#) Onions and garlic are actually toxic to dogs and cats by causing anemia.

[Alternative, Complementary and Holistic Veterinary Medicine \(AltVetMed\)](#) Holistic Veterinary Medicine—Acupuncture, Chiropractic, Herbal Medicine, Homeopathy, Nutritional Therapy & Other Alternative Modalities.

[18 more Articles & Resources below](#)

Related Categories

[Aromatherapy and Pets](#)

Articles & Resources

more from your guide

[Alternative/Holistic Medicine](#) Net link resources from About.com's veterinarian medicine guide.

[Basics of Natural Flea Control](#) Addressing the use of "natural" insecticides and other natural alternatives.

[European Herbs For Animals](#) The U.K.'s view and usage of herbal

More Categories

[Depression \(8\)](#)

[Digestive Conditions \(4\)](#)

[Reproductive Conditions \(13\)](#)

[Respiratory Conditions \(9\)](#)

[Skin Conditions \(16\)](#)



[Home](#)

[Essentials](#)

[A - Z Encyclopedia](#)[Submit A Feature Article](#)[Aromatherapy Free Herb Graphics](#)[Submit a Recipe!](#)

[Browse Categories](#)

[Basics For Beginners](#)[Find A Condition Or Symptom](#)[Herb Profiles / Monographs](#)[Consumer Safety / Toxicolog](#)[Aromatherapy Preparations And Recipes](#)[Herbal Schools](#)[Homeopathy](#)[Home And Garden](#)[Flower Essences](#)[Research](#)[Family And Pets](#)[Wild Herbs](#)[Traditional Ethnic](#)[Popular Herbs](#)

[Buyer's Guide](#)

[Before You Buy](#)[Top Picks](#)[Top 3 Essential Oil Brands](#)[Topical Pain Relief Products](#)[Product Reviews](#)

[Articles](#)

[Forums](#)

[Help](#)

Stay Current

Subscribe to the **About** Healthy Herbs newsletter.

medicine with canines and horses.

[Herbal Article - Herbs and Your Pets](#) Ever seen the movie "Homeward Bound"? Well...Chance, Sassy and Shadow can all benefit from herbs too. Here are some of the ways:by Viable Herbal Solutions of Jacksonville, Florida.

[Herbs in Veterinary Medicine](#)By by Susan Gayle Wynn.

[Home Made Cat Food](#)Something to really to think about if you want your cat to go vegetarian. From About.com's cat guide.

[Kava Kava Veterinary Monograph](#)For dogs, cats and horses from the Veterinary Botanical Medical Association.

[Milk Thistle Veterinary Monograph](#)For dogs, cats and horses from the Veterinary Botanical Medical Association.

[Onion Salt and Powder in Pet Food](#)Questions and answers from IAMS.

[Owners turn to alternative treatments such as herbs, acupuncture for pets](#)Though some vets - like conventional physicians - are skeptical of alternative medicine, believers say the proof is in the prognosis.

[Pet Sage](#)Products, toys, books, nutrition and news.

[The Herbs Place Pet News](#)The Herbs Place PET NEWS is a short weekly newsletter with natural health solutions, tips for emotional issues, success stories, pet web links and more. Subscribe with a blank email using link above.

[The Medicine Garden](#) Great information on various pet ailments and treatments.

[Use of Herbal Remedies to Control Pet Behavior](#) As the movement moves into the pet world, so do the same concerns of research, safety and usage.

[Using Herbs To Treat Liver Disease For Dogs](#)As dogs age, we start to see an increased frequency of organ problems.

[Vaccines, Friend or Foe](#)Recently, annual vaccinations have come under suspicion for causing a usually fatal form of cancer seen in cats.

[Vegetarian Pet](#)Net link resources from About.com's vegetarian guide.

[Veterinary Botanical Medical Association](#)

[Application](#)Membership in the VBMA is open to all veterinarians with an interest in practicing safe, effective herbal medicine. Non-veterinarians with experience in herbal medicine may join as associate members. Professional certification by VBMA will be granted to members who qualify.

[Topic Index](#) |

 [email to a friend](#)  font size

[back to top](#)

[Our Story](#) | [Be a Guide](#) | [Advertising Info](#) | [Investor Relations](#) | [Work at About](#) | [Help](#)

©2004 About, Inc. All rights reserved. A PRIMEDIA Company.

[User Agreement](#) | [Privacy Policy](#) | [Kids' Privacy Policy](#)

Search

[Healthy Herbs](#)

Herb Profiles / Monographs

Monograph publications and some on-line published monographs of selected herbs.

Articles & Resources

Sort By : Guide Picks | [Alphabetical](#) | [Recent](#)

[A - Z Encyclopedia](#) Monographs and profiles of herbs, essential oils, phytochemicals and Chinese Patents.

[American Herbal Pharmacopoeia™](#) The primary goal of the AHP is to produce authoritative herbal monographs containing accurate, critically reviewed information on botanicals which can provide guidance in the appropriate use of herbal therapeutics.

[Essential Oils Monographs](#) Monographs on 57 common essential oils includes documented info on their historical uses, medicinal activity, safety information and suggested uses for fragrance, inhalation, baths and massage.

[European Scientific Coop on Phytomed.\(ESCOP\)](#) European Monographs summarizing the medicinal uses of plant drugs (including their safety) - an area which ESCOP considers to be of prime importance for scientific harmonization.

[German E Commission Monographs](#) They represent the most accurate information available in the entire world on the safety and efficacy of herbs and phytomedicines.

[10 more Articles & Resources below](#)

Articles & Resources

more from your guide

[The Hermits Grove](#) Offering over 150 monographs for .75 each.

[Comfrey](#) From InteliHealth.

[Fenugreek](#) From the Hermits Grove.

[Feverfew](#) From InteliHealth.

[Flax Seed](#) From the Hermits Grove.

[Ginkgo](#) From the Hermits Grove.

[Ginger](#) From InteliHealth.

[Kava Kava](#) From Thorne Research.

[Valerian](#) From InteliHealth.

[St. Johns Wort](#) From InteliHealth.



[Home](#)

[Essentials](#)

[A - Z Encyclopedia](#)[Submit A Feature Article](#)[Aromatherapy](#)[Free Herb Graphics](#)[Submit a Recipe!](#)

[Browse Categories](#)

[Basics For Beginners](#)[Find A Condition Or Symptom](#)[Herb Profiles / Monographs](#)[Consumer Safety / Toxicolog](#)[Aromatherapy](#)[Preparations And Recipes](#)[Herbal Schools](#)[Homeopathy](#)[Home And Garden](#)[Flower Essences](#)[Research](#)[Family And Pets](#)[Wild Herbs](#)[Traditional Ethnic](#)[Popular Herbs](#)

[Buyer's Guide](#)

[Before You Buy](#)[Top Picks](#)[Top 3 Essential Oil Brands](#)[Topical Pain Relief Products](#)[Product Reviews](#)

[Articles](#)

[Forums](#)

[Help](#)

Stay Current

Subscribe to the **About** Healthy Herbs newsletter.

[Topic Index](#) |



[email to a friend](#)



font size

About
[back to top](#)

[Our Story](#) | [Be a Guide](#) | [Advertising Info](#) | [Investor Relations](#) | [Work at About](#) | [Help](#)

©2004 About, Inc. All rights reserved. A PRIMEDIA Company.

[User Agreement](#) | [Privacy Policy](#) | [Kids' Privacy Policy](#)



[Home](#)

[Essentials](#)

[A - Z Encyclopedia](#)[Submit A Feature Article](#)[Aromatherapy Free Herb Graphics](#)[Submit a Recipe!](#)

[Browse Categories](#)

[Basics For Beginners](#)[Find A Condition Or Symptom](#)[Herb Profiles / Monographs](#)[Consumer Safety / Toxicolog](#)[Aromatherapy](#)[Preparations And Recipes](#)[Herbal Schools](#)[Homeopathy](#)[Home And Garden](#)[Flower Essences](#)[Research](#)[Family And Pets](#)[Wild Herbs](#)[Traditional Ethnic](#)[Popular Herbs](#)

[Buyer's Guide](#)

[Before You Buy](#)[Top Picks](#)[Top 3 Essential Oil Brands](#)[Topical Pain Relief Products](#)[Product Reviews](#)

[Articles](#)

[Forums](#)

[Help](#)

Stay Current

Subscribe to the **About** Healthy Herbs newsletter.

Search

[Healthy Herbs](#)

Consumer Safety / Toxicology

Consumer Safety / Toxicology

Articles & Resources

Sort By : [Guide Picks](#) | [Alphabetical](#) | [Recent](#)

[Nicotinic Toxic Syndrome](#) Definition, characteristics and plants causing nicotinic toxidrome.

[Natural Fatality](#) Beautiful but toxic beauties which may be in your yard or garden.

[Essential Oil Safety](#) Safety terms and definitions associated with essential oils.

[Herbs And Liver Damage](#) Sometimes when we feel safe taking an herb, it seems we get bombarded with warnings of liver damage. What does it all mean and is it warranted?

[Anti-depressant With Sun and Alcohol?](#) Are they safe?

[2 more Articles & Resources below](#)

Articles & Resources

more from your guide

[Alkaloids](#) Alkaloids in herbs and plants are nitrogen containing substances which are typically bitter in taste and in most cases toxic.

[Natural Born Killers - Wildcrafting](#) If you plan on wildcrafting, be aware that there are many poisonous plants all around us. Some have the same appearance as safe herbs.

More Categories

[Specific Herbs Of Concern \(3\)](#)

[Topic Index](#) |

[email to a friend](#) font size

[Our Story](#) | [Be a Guide](#) | [Advertising Info](#) | [Investor Relations](#) | [Work at About](#) | [Help](#)

©2004 About, Inc. All rights reserved. A PRIMEDIA Company.



You are here: [About](#)>[Health & Fitness](#)>[Healthy Herbs](#)



[Home](#)

[Essentials](#)

[A - Z Encyclopedia](#)[Submit A Feature Article](#)[Aromatherapy Free Herb Graphics](#)[Submit a Recipe!](#)

[Browse Categories](#)

[Basics For Beginners](#)[Find A Condition Or Symptom](#)[Herb Profiles / Monographs](#)[Consumer Safety / Toxicolog](#)[Aromatherapy Preparations And Recipes](#)[Herbal Schools](#)[Homeopathy](#)[Home And Garden](#)[Flower Essences](#)[Research](#)[Family And Pets](#)[Wild Herbs](#)[Traditional Ethnic](#)[Popular Herbs](#)

[Buyer's Guide](#)

[Before You Buy](#)[Top Picks](#)[Top 3 Essential Oil Brands](#)[Topical Pain Relief Products](#)[Product Reviews](#)

[Articles](#)

[Forums](#)

[Help](#)

Stay Current

Subscribe to the **About** Healthy Herbs newsletter.

[Topic Index](#) |

 [email to a friend](#)  font size

[Our Story](#) | [Be a Guide](#) | [Advertising Info](#) | [Investor Relations](#) | [Work at About](#) | [Help](#)

©2004 About, Inc. All rights reserved. A PRIMEDIA Company.

[User Agreement](#) | [Privacy Policy](#) | [Kids' Privacy Policy](#)

Search

[Healthy Herbs](#)

Aromatherapy

Aromatherapy

Articles & Resources

Sort By : [Guide Picks](#) | [Alphabetical](#) | [Recent](#)

[Aromatherapy Center](#) Basics, useful measurements, therapeutic articles and essential oil applications.

[Essential Oil Profiles](#) Profiles and monographs of essential and carrier oils.

More Categories

[Aromatherapy Schools / Education @](#)

[back to top](#)

You are here: [About](#)>[Health & Fitness](#)>[Healthy Herbs](#)



[Home](#)

[Essentials](#)

[A - Z Encyclopedia](#)[Submit A Feature Article](#)[Aromatherapy](#) [Free Herb Graphics](#)[Submit a Recipe!](#)

[Browse Categories](#)

[Basics For Beginners](#)[Find A Condition Or Symptom](#)[Herb Profiles / Monographs](#)[Consumer Safety / Toxicolog](#)[Aromatherapy](#)[Preparations And Recipes](#)[Herbal Schools](#)[Homeopathy](#)[Home And Garden](#)[Flower Essences](#)[Research](#)[Family And Pets](#)[Wild Herbs](#)[Traditional Ethnic](#)[Popular Herbs](#)

[Buyer's Guide](#)

[Before You Buy](#)[Top Picks](#)[Top 3 Essential Oil Brands](#)[Topical Pain Relief Products](#)[Product Reviews](#)

[Articles](#)

[Forums](#)

[Help](#)

Search

[Healthy Herbs](#)

Herbal Preparations / Recipes

Herbal Preparations / Recipes

More Categories

[Preparation Methods \(8\)](#)

Stay Current

Subscribe to the **About** Healthy Herbs

newsletter.

[Topic Index](#) |



[email to a friend](#)



[font size](#)

[Our Story](#) | [Be a Guide](#) | [Advertising Info](#) | [Investor Relations](#) | [Work at About](#) | [Help](#)

©2004 About, Inc. All rights reserved. A PRIMEDIA Company.

[User Agreement](#) | [Privacy Policy](#) | [Kids' Privacy Policy](#)

[back to top](#)

You are here: [About](#)>[Health & Fitness](#)>[Healthy Herbs](#)



[Home](#)

[Essentials](#)

[A - Z Encyclopedia](#)[Submit A Feature Article](#)[Aromatherapy](#)[Free Herb Graphics](#)[Submit a Recipe!](#)

[Browse Categories](#)

[Basics For Beginners](#)[Find A Condition Or Symptom](#)[Herb Profiles / Monographs](#)[Consumer Safety / Toxicolog](#)[Aromatherapy](#)[Preparations And Recipes](#)[Herbal Schools](#)[Homeopathy](#)[Home And Garden](#)[Flower Essences](#)[Research](#)[Family And Pets](#)[Wild Herbs](#)[Traditional Ethnic](#)[Popular Herbs](#)

[Buyer's Guide](#)

[Before You Buy](#)[Top Picks](#)[Top 3 Essential Oil Brands](#)[Topical Pain Relief Products](#)[Product Reviews](#)

[Articles](#)

[Forums](#)

[Help](#)

Stay Current

Subscribe to the **About** Healthy Herbs newsletter.

[Topic Index](#) |

 [email to a friend](#)  font size

[Our Story](#) | [Be a Guide](#) | [Advertising Info](#) | [Investor Relations](#) | [Work at About](#) | [Help](#)

©2004 About, Inc. All rights reserved. A PRIMEDIA Company.

[User Agreement](#) | [Privacy Policy](#) | [Kids' Privacy Policy](#)

Search

[Healthy Herbs](#)

Herbal Schools / Education

Herbal Schools / Education

More Categories

[Aromatherapy Education \(8\)](#)

[ayurvedicschools \(6\)](#)

[Educational Materials \(3\)](#)

[flowessenceschools \(4\)](#)

[tradchinmedschools \(8\)](#)

[Traditional Herbal Schools \(12\)](#)



You are here: [About](#)>[Health & Fitness](#)>[Healthy Herbs](#)



[Home](#)

[Essentials](#)

[A - Z Encyclopedia](#)[Submit A Feature Article](#)[Aromatherapy](#) [Free Herb Graphics](#)[Submit a Recipe!](#)

[Browse Categories](#)

[Basics For Beginners](#)[Find A Condition Or Symptom](#)[Herb Profiles / Monographs](#)[Consumer Safety / Toxicolog](#)[Aromatherapy](#)[Preparations And Recipes](#)[Herbal Schools](#)[Homeopathy](#)[Home And Garden](#)[Flower Essences](#)[Research](#)[Family And Pets](#)[Wild Herbs](#)[Traditional Ethnic](#)[Popular Herbs](#)

[Buyer's Guide](#)

[Before You Buy](#)[Top Picks](#)[Top 3 Essential Oil Brands](#)[Topical Pain Relief Products](#)[Product Reviews](#)

[Articles](#)

[Forums](#)

[Help](#)

Search

[Healthy Herbs](#)

Homeopathy

Homeopathy

Articles & Resources

Sort By : Guide Picks | [Alphabetical](#) | [Recent](#)

[About Homeopathy](#)A general overview of homeopathy.

Stay Current

Subscribe to the **About** Healthy Herbs newsletter.

[Topic Index](#) |

 [email to a friend](#)  font size

[Our Story](#) | [Be a Guide](#) | [Advertising Info](#) | [Investor Relations](#) | [Work at About](#) | [Help](#)

©2004 About, Inc. All rights reserved. A PRIMEDIA Company.

[User Agreement](#) | [Privacy Policy](#) | [Kids' Privacy Policy](#)



You are here: [About](#)>[Health & Fitness](#)>[Healthy Herbs](#)



[Home](#)

[Essentials](#)

[A - Z Encyclopedia](#)[Submit A Feature Article](#)[Aromatherapy Free Herb Graphics](#)[Submit a Recipe!](#)

[Browse Categories](#)

[Basics For Beginners](#)[Find A Condition Or Symptom](#)[Herb Profiles / Monographs](#)[Consumer Safety / Toxicolog](#)[Aromatherapy](#)[Preparations And Recipes](#)[Herbal Schools](#)[Homeopathy](#)[Home And Garden](#)[Flower Essences](#)[Research](#)[Family And Pets](#)[Wild Herbs](#)[Traditional Ethnic](#)[Popular Herbs](#)

[Buyer's Guide](#)

[Before You Buy](#)[Top Picks](#)[Top 3 Essential Oil Brands](#)[Topical Pain Relief Products](#)[Product Reviews](#)

[Articles](#)

[Forums](#)

[Help](#)

Search

[Healthy Herbs](#)

Home And Garden

Home And Garden

More Categories

[Growing Herbs \(12\)](#)

Stay Current

Subscribe to the **About** Healthy Herbs newsletter.

[Topic Index](#) |

 [email to a friend](#)  font size

[Our Story](#) | [Be a Guide](#) | [Advertising Info](#) | [Investor Relations](#) | [Work at About](#) | [Help](#)

©2004 About, Inc. All rights reserved. A PRIMEDIA Company.

[User Agreement](#) | [Privacy Policy](#) | [Kids' Privacy Policy](#)



[back to top](#)

Search
[Healthy Herbs](#)

Flower Essences

Flower Essences

Articles & Resources

Sort By : Guide Picks | [Alphabetical](#) | [Recent](#)

[Alaskan Flower Essence Project](#)The Alaskan Flower Essence Project is dedicated to providing vibrational essences of the highest quality that are relevant to the life issues and health care challenges currently facing sentient beings in all countries of the world.

[A Modern History of Flower Essences](#)By Bobbi Gay.

[Bach Flower Remedy Categories](#)Within these general categories you will find listed a number of flower essences, each with their particular attribute.

[Bach Flower Remedy Descriptions](#)A list of flowers and their properties.

[The Flower Essence Society](#)The Society conducts seminars and certification programs for active flower essence practitioners and the general public throughout the world.

[5 more Articles & Resources below](#)

Articles & Resources

more from your guide

[Getting The Most Out Of Your Flower Essences](#)By Bobbi Gay.

[Making Flower Essences](#)How they are created by Bobbi Gay.

[New Bach Flower Remedies](#)About Dr. Edward Bach, papers and information.

[Self Mastery Through Flower Essences](#)If you want to improve your life physically, mentally, emotionally, or spiritually, consider flower essences: an extraordinary healing method both time-tested and dynamic.

[Questionnaire](#)Instructions and questionnaire to help you decide which remedies you should use.



[Home](#)

[Essentials](#)

[A - Z Encyclopedia](#)[Submit A Feature Article](#)[Aromatherapy Free Herb Graphics](#)[Submit a Recipe!](#)

[Browse Categories](#)

[Basics For Beginners](#)[Find A Condition Or Symptom](#)[Herb Profiles / Monographs](#)[Consumer Safety / Toxicolog](#)[Aromatherapy](#)[Preparations And Recipes](#)[Herbal Schools](#)[Homeopathy](#)[Home And Garden](#)[Flower Essences](#)[Research](#)[Family And Pets](#)[Wild Herbs](#)[Traditional Ethnic](#)[Popular Herbs](#)

[Buyer's Guide](#)

[Before You Buy](#)[Top Picks](#)[Top 3 Essential Oil Brands](#)[Topical Pain Relief](#)[Products](#)[Product Reviews](#)

[Articles](#)

[Forums](#)

[Help](#)

Stay Current

Subscribe to the **About** Healthy Herbs newsletter.

[Topic Index](#) |

 [email to a friend](#)  font size

[Our Story](#) | [Be a Guide](#) | [Advertising Info](#) | [Investor Relations](#) | [Work at About](#) | [Help](#)

©2004 About, Inc. All rights reserved. A PRIMEDIA Company.

[User Agreement](#) | [Privacy Policy](#) | [Kids' Privacy Policy](#)



You are here: [About](#)>[Health & Fitness](#)>[Healthy Herbs](#)



[Home](#)

[Essentials](#)

[A - Z Encyclopedia](#)[Submit A Feature](#)

[Article](#)[Aromatherapy](#) [Free Herb Graphics](#)[Submit a Recipe!](#)

[Browse Categories](#)

[Basics For Beginners](#)[Find A Condition Or Symptom](#)[Herb Profiles / Monographs](#)[Consumer Safety /](#)

[Toxicolog](#)[Aromatherapy](#)[Preparations And Recipes](#)[Herbal Schools](#)[Homeopathy](#)[Home And Garden](#)[Flower](#)

[Essences](#)[Research](#)[Family And Pets](#)[Wild Herbs](#)[Traditional Ethnic](#)[Popular Herbs](#)

[Buyer's Guide](#)

[Before You Buy](#)[Top Picks](#)[Top 3 Essential Oil](#)

[Brands](#)[Topical Pain Relief Products](#)[Product Reviews](#)

[Articles](#)

[Forums](#)

[Help](#)

Stay Current

Subscribe to the **About** Healthy Herbs newsletter.

[Topic Index](#) |

[email to a friend](#) font size

[Our Story](#) | [Be a Guide](#) | [Advertising Info](#) | [Investor Relations](#) | [Work at About](#) | [Help](#)

©2004 About, Inc. All rights reserved. A PRIMEDIA Company.

[User Agreement](#) | [Privacy Policy](#) | [Kids' Privacy Policy](#)

Search

[Healthy Herbs](#)

Juli Kight

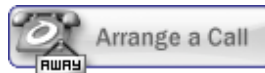

herbsforhealth.guide@about.com

Juli Kight is dedicated to introducing others to the diverse world of using herbs and plants to enhance, protect, and maintain health and well being.

Professional Experience: Juli is a member of the [Herb Research Foundation](#), the [Flower Essence Society](#), the American Herbalists Guild and a student of the [Michael Tierra's East West Planetary Herbalism](#). She has been working with herbs for about 15 years.

From Juli Kight: "This site features herbs with information on practical methods to use them, where to purchase herbs and extracts, what herbs you can find along the road, natural born killers (herbs to stay away from), plant based eating habits, projects you can do with your plants, and controversial herbs. We will explore all facets of medicinal plant use from traditional Western and Eastern uses to flower essences and homeopathy."



From [Juli Kight](#),
Your Guide to [Healthy Herbs](#).

RATE THIS ARTICLE

Would you recommend this article?

Not at all Definitely

1 2 3 4 5

Most Popular Articles

[Spring Cleansing Herbal](#)

[Encyclopedia A to Z](#)[Herb](#)

[Encyclopedia A to Z](#)[Horny Goat](#)

[Weed -](#)

[Epimedium sagittatum](#)[Itchy](#)

[Skin - Dermatitis](#)

What's Hot Now

[Herbal](#)

[Encyclopedia A to Z](#)[Spring](#)

[Cleansing](#)



[back to top](#)

You are here: [About](#)>[Health & Fitness](#)>[Healthy Herbs](#)



[Home](#)

[Essentials](#)

[A - Z Encyclopedia](#)[Submit A Feature Article](#)[Aromatherapy](#)[Free Herb Graphics](#)[Submit a Recipe!](#)

[Browse Categories](#)

[Basics For Beginners](#)[Find A Condition Or Symptom](#)[Herb Profiles / Monographs](#)[Consumer Safety / Toxicolog](#)[Aromatherapy](#)[Preparations And Recipes](#)[Herbal Schools](#)[Homeopathy](#)[Home And Garden](#)[Flower Essences](#)[Research](#)[Family And Pets](#)[Wild Herbs](#)[Traditional Ethnic](#)[Popular Herbs](#)

[Buyer's Guide](#)

[Before You Buy](#)[Top Picks](#)[Top 3 Essential Oil Brands](#)[Topical Pain Relief Products](#)[Product Reviews](#)

[Articles](#)

[Forums](#)

[Help](#)

Stay Current

Subscribe to the **About** Healthy Herbs

newsletter.

[Topic Index](#) |

 [email to a friend](#)  font size

[Our Story](#) | [Be a Guide](#) | [Advertising Info](#) | [Investor Relations](#) | [Work at About](#) | [Help](#)

©2004 About, Inc. All rights reserved. A PRIMEDIA Company.

[User Agreement](#) | [Privacy Policy](#) | [Kids' Privacy Policy](#)

Search

[Healthy Herbs](#)

May 07, 2004

Herbs for Health Blog Archives

« [April 28, 2004](#) | [Main](#)

Most Popular Articles



From [Juli Kight](#),
Your Guide to [Healthy Herbs](#).

[Spring Cleansing Herbal Encyclopedia A to Z](#)
[Herb Encyclopedia A to Z](#)
[Horny Goat Weed - Epimedium sagittatum](#)
[Itchy Skin - Dermatitis](#)

Summers Top Ten

These are my picks for ten herbs you should have available for summer activities and travel.

[06:13 AM](#) #

What's Hot Now

[Herbal Encyclopedia A to Z](#)
[Spring Cleansing](#)

[Display Latest Headlines](#) 



[Read Archives](#)

[back to top](#)

You are here: [About](#)>[Health & Fitness](#)>[Healthy Herbs](#)



- [Home](#)
- [Essentials](#)
- [A - Z Encyclopedia](#)[Submit A Feature Article](#)[Aromatherapy](#) [Free Herb Graphics](#)[Submit a Recipe!](#)
- [Browse Categories](#)
- [Basics For Beginners](#)[Find A Condition Or Symptom](#)[Herb Profiles / Monographs](#)[Consumer Safety / Toxicolog](#)[Aromatherapy](#)[Preparations And Recipes](#)[Herbal Schools](#)[Homeopathy](#)[Home And Garden](#)[Flower Essences](#)[Research](#)[Family And Pets](#)[Wild Herbs](#)[Traditional Ethnic](#)[Popular Herbs](#)
- [Buyer's Guide](#)
- [Before You Buy](#)[Top Picks](#)[Top 3 Essential Oil Brands](#)[Topical Pain Relief Products](#)[Product Reviews](#)
- [Articles](#)
- [Forums](#)
- [Help](#)

Stay Current

Subscribe to the **About** Healthy Herbs newsletter.

[Topic Index](#) |

 [email to a friend](#)  font size

[Our Story](#) | [Be a Guide](#) | [Advertising Info](#) | [Investor Relations](#) | [Work at About](#) | [Help](#)

©2004 About, Inc. All rights reserved. A PRIMEDIA Company.
[User Agreement](#) | [Privacy Policy](#) | [Kids' Privacy Policy](#)

Search
[Healthy Herbs](#)

Summers Top Ten

Herbs for Health Blog
« [Spring Tonic Herbs](#) | [Main](#)

May 07, 2004

Summers Top Ten

These are my picks for ten herbs you should have available for summer activities and travel.

[Email a Friend](#)
[Display Latest Headlines](#) 
 [Read Archives](#)

Most Popular Articles

[Spring Cleansing Herbal Encyclopedia A to Z](#)
[Herb Encyclopedia A to Z](#)
[Horny Goat Weed - Epimedium sagittatum](#)
[Itchy Skin - Dermatitis](#)

What's Hot Now

[Herbal Encyclopedia A to Z](#)
[Spring Cleansing](#)

[back to top](#)

Search

[Healthy Herbs](#)**Tonic Herbs**

Gifs by Juli

Dateline: 12/05/98

[Overview](#)[More Information/Links](#)[Books on the Subject](#)**Overview**

Tonic herbs strengthen and improve specific organs, systems, weaknesses or the body as a whole. They are generally gentle herbs that can be gently stimulating.

There is a difference between tonics and stimulants. Stimulants tend to stimulate an organ or system eventually ending up in depletion, thus "coming down", "crashing" or exhaustion you experience after using them for a period of time. Tonics, gently build and do not exhibit the instant effects of stimulants. You will not experience the "crash" when you stop using them. Tonics like American ginseng will gently build your energy and at the same time help you remain calm and focused during stress, also allowing for better sleep.

Tonic herbs can be described as "normalizers" which nurture and nourish. As Paul Bergner quotes "Taking a tonic is like putting money (chi) in the bank. Taking a stimulant is like withdrawing the money, at some point, your account becomes over-drawn." Lesley Tierra states that tonics "strengthen and promote the overall body processes or particular organs to function better; use to improve any organ or system function and to strengthen and build blood or energy."

If you ever get that feeling that you're not feeling your best, but then you're not feeling sick, perhaps a tonic is all you need.

More Information and References

[1] Bergner, Paul; The Healing Power of Ginseng and the Tonic Herbs; 1996

[2] Tierra, Lesley; The Herbs of Life; 1992

[3] Hoffmann, David; The New Holistic Herbal; 1990

[NFM: Debating Chronic Tonic Use](#)

[Tonics for the Upper Respiratory System](#)

[Christopher Hobbs: Deficiency Syndromes Herbs and Herbal Tonic Formulas](#)

[Uterine Tonics- HealthWorld Online](#)

[Specific and Tonic Immune Herbs](#)

[Spring Tonic](#)

[NativeTech: Spring \(amiskowehekuska\) or Mint Tonic](#)

Most Popular Articles

[Spring Cleansing](#)

[Herbal](#)

[Encyclopedia A to Z Herb](#)

[Encyclopedia A to Z Horny Goat](#)

[Weed -](#)

[Epimedium](#)

[sagittatum Itchy](#)

[Skin - Dermatitis](#)

What's Hot Now

[Herbal](#)

[Encyclopedia A](#)

[Home](#)[Essentials](#)[A - Z Encyclopedia Submit A Feature](#)[Article Aromatherapy Free Herb Graphics Submit a Recipe!](#)[Browse Categories](#)[Basics For Beginners Find A Condition Or Symptom Herb Profiles / Monographs Consumer Safety /](#)[Toxicology Aromatherapy Preparations And Recipes Herbal Schools Homeopathy Home And Garden Flower](#)[Essences Research Family And Pets Wild Herbs Traditional Ethnic Popular Herbs](#)[Buyer's Guide](#)[Before You Buy Top Picks Top 3 Essential Oil](#)[Brands Topical Pain Relief Products Product Reviews](#)[Articles](#)[Forums](#)

[Help](#)

Stay Current

Subscribe to the **About** Healthy Herbs newsletter.

[Beyond Mu Tea - Chinese Tonic Herbs](#) - By Ron Teeguarden who is an author, educator and master herbalist in Chinese Tonic Herbalism. See books below!
[Oregon Raspberry and Blackberry Media Kits](#)
[7 Tonic Herbs For Muscles & Bones](#)
[Chinese Tonic Herbs](#)

Books On The Subject

[Herbs To Boost Immunity: Herbal Tonics to Keep You Healthy and Strong](#)

by Gail Ulrich
No review available at this time. Paperback

[Chinese Tonic Herbs](#)

by Ron Teeguarden
Follow link to read readers comments. Paperback

[The Healing Power of Ginseng and the Tonic Herbs](#)

by Paul Bergner
This book shows readers how to use ginseng and the tonic herbs safely and effectively. Paperback

BE SURE TO CHECK BACK LATER FOR MORE UPDATES!

Got a question to ask? [GO TO THE BOARDS!](#)

Please feel free to contact me if you have any suggestions, questions or comments. You are also invited to fill out the site survey under the "Feedback" link.

Your feedback is important!

herbsforhealth.guide@miningco.com

[Previous Features](#)



From [Juli Kight](#),
Your Guide to [Healthy Herbs](#).

RATE THIS ARTICLE

Would you recommend this article?

Not at all Definitely

1 2 3 4 5

[Topic Index](#) |

[email to a friend](#) font size

[back to top](#)

[Our Story](#) | [Be a Guide](#) | [Advertising Info](#) | [Investor Relations](#) | [Work at About](#) | [Help](#)

©2004 About, Inc. All rights reserved. A PRIMEDIA Company.

[User Agreement](#) | [Privacy Policy](#) | [Kids' Privacy Policy](#)

Search

[Healthy Herbs](#)



Chickweed
Juli Kight



Chickweed
Juli Kight

[Email to a friend](#)[Print this page](#)

[Newsletters](#)

Most Popular Articles

[Spring Cleansing Herbal Encyclopedia A to Z](#)[Herb Encyclopedia A to Z](#)[Horny Goat Weed - Epimedium sagittatum](#)[Itchy Skin - Dermatitis](#)

What's Hot Now

[Herbal Encyclopedia A to Z](#)[Spring Cleansing](#)

Chickweed - Stellaria media

Herb



From [Juli Kight](#),
Your Guide to [Healthy Herbs](#).

Overview: Revered as a nuisance to most gardeners, this inconspicuous little plant grows world wide and in abundance. It is usually one of the first plants in spring and in the heat of summer it can be found in cooler, damp shady areas. It makes a wonderful addition to fresh spring salads.

Actions And Properties:
Topical anti-pruritic (itch)
Anti-rheumatic
Astringent
Emollient



[Home](#)

[Essentials](#)

[A - Z Encyclopedia](#)[Submit A Feature Article](#)[Aromatherapy Free](#)
[Herb Graphics](#)[Submit a Recipe!](#)

[Browse Categories](#)

[Basics For Beginners](#)[Find A Condition Or Symptom](#)[Herb Profiles /](#)

[Monographs](#)[Consumer Safety /](#)

[Toxicology](#)[Aromatherapy](#)[Preparations And Recipes](#)[Herbal](#)

[Schools](#)[Homeopathy](#)[Home And Garden](#)[Flower](#)

[Essences](#)[Research](#)[Family And Pets](#)[Wild Herbs](#)[Traditional](#)

[Ethnic](#)[Popular Herbs](#)

[Buyer's Guide](#)

[Before You Buy](#)[Top Picks](#)[Top 3 Essential Oil Brands](#)[Topical Pain](#)
[Relief Products](#)[Product Reviews](#)

[Articles](#)

[Forums](#)

[Help](#)

Stay Current

Subscribe to the **About** Healthy Herbs
newsletter.

Hypotensive
Vulnerary
Constituents:
Mucilage
Saponin glycosides
Coumarins and hydroxycoumarins
Flavonoids
Triterpenoids
Carboxylic acids
Vitamin C

Uses:

Chickweeds best uses are for skin issues and as a tonic. Topically, chickweed addresses skin ailments from minor rashes and itching to eczema and psoriasis. It is also effective against relieving pain from bug bites. Young green tops in spring are excellent in salads and used like spinach for tonic purposes.

Warnings:

None found at this time.

References:

[Chickweed](#) - By David L. Hoffmann B.Sc. (Hons), M.N.I.M.H.

RATE THIS ARTICLE

Would you recommend this article?

Not at all Definitely

1 2 3 4 5

[Topic Index](#) |



[email to a friend](#)



font size



[back to top](#)

[Our Story](#) | [Be a Guide](#) | [Advertising Info](#) | [Investor Relations](#) | [Work at About](#) | [Help](#)

©2004 About, Inc. All rights reserved. A PRIMEDIA Company.

[User Agreement](#) | [Privacy Policy](#) | [Kids' Privacy Policy](#)

Search

[Healthy Herbs](#)

Healthy Salads

Add healing potential to your salads my making a few adjustments with your greens.

We are half way through the summer and I'll bet you are tired of salads based on [iceberg lettuce](#).

Not only is iceberg lettuce lower on the nutritional value scale than other lettuces or salad greens, commercial heads may contain sulfites to prevent it from turning brown.[1] You can increase the healing potential of your salads by adding a variety of fresh herbs and greens.

Changing your salad from plain iceberg lettuce to a variety of vegetable and herbal greens not only awakens your taste buds, but also serves as a healthy tonic as well as supplying more nutritional values. It completely changes the flavor profile leaving your salad choices less boring, and less susceptible to loading them with all the wrong fixings. You will also feel more satisfied and nourished instead of hungry an hour later, leading to snacking.

It is easy to make the change by purchasing specialized salad mixes available in the produce section at your grocery store. My favorites are the spring or field herb blends. This allows you to try a little at a time to see what you do or don't like. Try mixing some new greens in with your basic iceberg until you find a taste you like. I still use iceberg myself because I like the added crunch and there are some nutritional values to it.

Below are some herbs to ideas to add to your salads. Be sure to check out the links below for even more unusual ideas and recipes.

- [Borage](#) - Several ways to use. Rich in minerals and an adrenal tonic.
- [Chervil](#) - Rejuvenation.
- [Chicory](#) (French Endive).
- [Dandelion](#) - Cleansing, diuretic.
- [Lavender](#) - Ways to use, good with fruit salads.
- [Lemon balm](#) - Nice aroma, add to salads to cut down on vinegar or lemon juice.
- [Monarda](#) - Add flowers for a unique flavor and look.
- [Mustard Greens](#) - Add sparingly for congestion, aches, digestion and circulation to mention a few. Plus it adds some spunk to your salad.
- [Parsley](#) - Chop a little fresh parsley for flavor, digestion and inflammatory conditions.
- [Raspberry](#) - Internal astringent. If you don't like berries on your salad, raspberry walnut dressing is a good alternative.
- [Salad burnet](#) - For a fresh spicy taste. Internal astringent.
- [Sorrel](#) - Folk cancer remedy. Adds a lemony taste.

Resources and Salad Greens Information

Recipes

Salad Greens Information

- [1] [Nutriquest](#) - Scroll down to msg Q08

Related Resources

- [Dandelion](#)

From Other Guides

- [Salad Greens Jigsaw Puzzle](#)
- [Guide to Salad Greens](#)

Elsewhere on the Web

- [Herbs as Food CD](#)

[Home](#)[Essentials](#)[A - Z Encyclopedia](#)[Submit A Feature](#)[Article](#)[Aromatherapy](#) [Free Herb Graphics](#)[Submit a Recipe!](#)[Browse Categories](#)[Basics For Beginners](#)[Find A Condition Or Symptom](#)[Herb](#)[Profiles / Monographs](#)[Consumer Safety /](#)[Toxicolog](#)[Aromatherapy](#)[Preparations And Recipes](#)[Herbal](#)[Schools](#)[Homeopathy](#)[Home And Garden](#)[Flower](#)[Essences](#)[Research](#)[Family And Pets](#)[Wild Herbs](#)[Traditional](#)[Ethnic](#)[Popular Herbs](#)[Buyer's Guide](#)[Before You Buy](#)[Top Picks](#)[Top 3 Essential Oil](#)[Brands](#)[Topical Pain Relief Products](#)[Product Reviews](#)[Articles](#)[Forums](#)

Most Popular Articles

[Spring Cleansing Herbal](#)[Encyclopedia A to Z](#)[Herb](#)[Encyclopedia A to Z](#)[Horny Goat](#)[Weed -](#)[Epimedium](#)[sagittatum](#)[Itchy](#)[Skin - Dermatitis](#)

What's Hot Now

[Herbal](#)[Encyclopedia A](#)

[Help](#)

[to ZSpring
Cleansing](#)

Stay Current

Subscribe to the **About** Healthy Herbs
newsletter.

- [Greens for Salads](#)
- [Nutritional Values of Fruits and Vegetables](#)
- [Chinese Herb Seeds](#) for salad use
Holy basil, Oriental garlic, sanguisoba minor, perilla,
foeniculum vulgare.
- [Corn Salad](#)
- [Salad Burnet](#)

Recipes

- [Borage Cucumber Salad](#)
- [Dandelion Salad](#)
Dandelion dressing etc.
- [Dandelion and Cheese Salad](#)
- [Chicory and Endive Salad](#)
- [Nasturtium, Lemon Balm Salad](#)
- [Raspberry walnut dressing](#)
- [Warm Mushroom Salad](#)
With mixed mushrooms and leaves.
- [Sorrel Salad](#) - As well as some other herb recipes.

Subscribe to The Herbs For Health Newsletter

Name

Email

[Previous Features](#)



From [Juli Kight](#),
Your Guide to [Healthy Herbs](#).

RATE THIS ARTICLE

Would you recommend this article?

Not at all

Definitely

1 2 3 4 5

[Topic Index](#) |



[email to a friend](#)



font size



[back to top](#)

[Our Story](#) | [Be a Guide](#) | [Advertising Info](#) | [Investor Relations](#) | [Work at About](#) | [Help](#)

©2004 About, Inc. All rights reserved. A PRIMEDIA Company.

[User Agreement](#) | [Privacy Policy](#) | [Kids' Privacy Policy](#)

Search

[Healthy Herbs](#)

[Email to a friend](#)[Print this page](#)

[Newsletters](#)

Most Popular Articles

[Spring Cleansing Herbal Encyclopedia A to Z](#)[Herb Encyclopedia A to Z](#)[Horny Goat Weed - Epimedium sagittatum](#)[Itchy Skin - Dermatitis](#)

What's Hot Now

[Herbal Encyclopedia A to Z](#)[Spring Cleansing](#)

Spring Cleansing



From [Juli Kight](#),
Your Guide to [Healthy Herbs](#).

As we spring clean our homes, so should we spring clean our bodies.

If there is any best season to rejuvenate and cleanse your body, spring is it. Over the fall and winter months you have probably increased your intake of fats, holiday sweets and processed foods while fresh organic produce plummeted. Toxins have built up from being held up indoors most of the time, air has been filled with garbage from home heating systems and fireplaces and you've definitely had a lack of sunshine. You are probably feeling sluggish or a little "off" and your skin is dull. It's time to shake the cob webs out and turn on the lights.

I am not a fan of drastic cleansing and detox programs so they will not be addressed in this feature. If you are considering this route I recommend doing it gradually and under supervision of a specialist as it can be harsh and result in unpleasant side effects or even increase illness. Cleansing should never be done when you are weak or ill. You can get great results by changing your diet and taking spring tonic and cleansing herbs over the next couple of weeks which will make you look and feel like a million bucks. Some detoxification programs target specific areas such as excess phlegm, inflammation or nerves.

The liver is the major organ for detoxification. It's role is to remove toxins and chemicals from our system. It is also a key player in fat metabolism. Excess weight, digestive problems and general poor health can be caused by liver dysfunctions. Heavy "sticky" foods eaten in excess will increase impurity and toxin levels. Most of us increase these foods during the colder months leaving us sluggish and unhealthy by the end of winter. A simple liver flush done twice per year is easy without ill side effects.

Your herbal arsenal for liver cleansing is simple. They can be



[Home](#)

[Essentials](#)

[A - Z Encyclopedia](#)[Submit A Feature Article](#)[Aromatherapy Free Herb Graphics](#)[Submit a Recipe!](#)

[Browse Categories](#)

[Basics For Beginners](#)[Find A Condition Or Symptom](#)[Herb Profiles / Monographs](#)[Consumer Safety /](#)

[Toxicolog](#)[Aromatherapy](#)[Preparations And Recipes](#)[Herbal](#)

[Schools](#)[Homeopathy](#)[Home And Garden](#)[Flower](#)

[Essences](#)[Research](#)[Family And Pets](#)[Wild Herbs](#)[Traditional](#)

[Ethnic](#)[Popular Herbs](#)

[Buyer's Guide](#)

[Before You Buy](#)[Top Picks](#)[Top 3 Essential Oil Brands](#)[Topical Pain Relief Products](#)[Product Reviews](#)

[Articles](#)

[Forums](#)

[Help](#)

Stay Current

Subscribe to the **About** Healthy Herbs
newsletter.

purchased if not wildcrafted just about anywhere. They can be found and used in combination as well.

Herbal Suggestions:

[Milk Thistle](#) - inhibits liver damaging factors. Also has the ability to rebuild new liver cells for all ready damaged livers. Can also build a protective layer of cells so toxins can not enter.

[Dandelion](#) - Helps clear obstructions and stimulates the liver. Assists with toxin elimination through urine.

[Turmeric](#) - Cleanses and regenerates liver cells.

[Bupleurum](#) - Increases circulation to the liver.

[Burdock Root](#) - Stimulates liver and bile.

Red Clover - Blood purifier.

RATE THIS ARTICLE

Would you recommend this article?

Not at all Definitely

1 2 3 4 5

[Topic Index](#) |



[email to a friend](#)



font size



[back to top](#)

[Our Story](#) | [Be a Guide](#) | [Advertising Info](#) | [Investor Relations](#) | [Work at About](#) | [Help](#)

©2004 About, Inc. All rights reserved. A PRIMEDIA Company.

[User Agreement](#) | [Privacy Policy](#) | [Kids' Privacy Policy](#)



[Home](#)

[Essentials](#)

[A - Z Encyclopedia](#)[Submit A Feature Article](#)[Aromatherapy](#) [Free Herb Graphics](#)[Submit a Recipe!](#)

[Browse Categories](#)

[Basics For Beginners](#)[Find A Condition Or Symptom](#)[Herb Profiles / Monographs](#)[Consumer Safety / Toxicolog](#)[Aromatherapy](#)[Preparations And Recipes](#)[Herbal Schools](#)[Homeopathy](#)[Home And Garden](#)[Flower Essences](#)[Research](#)[Family And Pets](#)[Wild Herbs](#)[Traditional Ethnic](#)[Popular Herbs](#)

[Buyer's Guide](#)

[Before You Buy](#)[Top Picks](#)[Top 3 Essential Oil Brands](#)[Topical Pain Relief Products](#)[Product Reviews](#)

[Articles](#)

[Forums](#)

[Help](#)

Stay Current

Subscribe to the **About** Healthy Herbs newsletter.

[Topic Index](#) |

 [email to a friend](#)  font size

[Our Story](#) | [Be a Guide](#) | [Advertising Info](#) | [Investor Relations](#) | [Work at About](#) | [Help](#)

©2004 About, Inc. All rights reserved. A PRIMEDIA Company.

[User Agreement](#) | [Privacy Policy](#) | [Kids' Privacy Policy](#)

Search

[Healthy Herbs](#)

Psyllium And Cleansing Herbs

Herbs for Health Blog

[« Hormones And HRT](#) | [Main](#) | [South American Libido Enhancers](#) »

February 14, 2004

Psyllium And Cleansing Herbs

[Psyllium](#) not only helps you stay regular but helps lower cholesterol, assists with appetite control and neutralizes and removes toxins in the colon.

Other herbs and information to help you cleanse your system are:

[Cleavers](#) - **New!**

[Milk Thistle](#)

[Honeysuckle](#)

[Burdock Root](#)

[Curly Dock](#)

[Dandelion](#)

[Cranberry](#)

[Cleansing](#)

[Spring Cleansing](#)

[Email a Friend](#)

[Display Latest Headlines](#) 



[Read Archives](#)

Most Popular Articles

[Spring Cleansing Herbal Encyclopedia A to Z](#)[Herb Encyclopedia A to Z](#)[Horny Goat Weed - Epimedium sagittatum](#)[Itchy Skin - Dermatitis](#)

What's Hot Now

[Herbal Encyclopedia A to Z](#)[Spring Cleansing](#)

[back to top](#)



[Home](#)

[Essentials](#)

[A - Z Encyclopedia](#)[Submit A Feature Article](#)[Aromatherapy](#)[Free Herb Graphics](#)[Submit a Recipe!](#)

[Browse Categories](#)

[Basics For Beginners](#)[Find A Condition Or Symptom](#)[Herb Profiles / Monographs](#)[Consumer Safety / Toxicolog](#)[Aromatherapy](#)[Preparations And Recipes](#)[Herbal Schools](#)[Homeopathy](#)[Home And Garden](#)[Flower Essences](#)[Research](#)[Family And Pets](#)[Wild Herbs](#)[Traditional Ethnic](#)[Popular Herbs](#)

[Buyer's Guide](#)

[Before You Buy](#)[Top Picks](#)[Top 3 Essential Oil Brands](#)[Topical Pain Relief Products](#)[Product Reviews](#)

[Articles](#)

[Forums](#)

[Help](#)

Stay Current

Subscribe to the **About** Healthy Herbs newsletter.

[Topic Index](#) |

 [email to a friend](#)  font size

[Our Story](#) | [Be a Guide](#) | [Advertising Info](#) | [Investor Relations](#) | [Work at About](#) | [Help](#)

©2004 About, Inc. All rights reserved. A PRIMEDIA Company.

[User Agreement](#) | [Privacy Policy](#) | [Kids' Privacy Policy](#)

Search

[Healthy Herbs](#)

April 28, 2004

Herbs for Health Blog Archives

[« April 19, 2004](#) | [Main](#) | [May 07, 2004](#) »



From [Juli Kight](#),
Your Guide to [Healthy Herbs](#).

Most Popular Articles

[Spring Cleansing Herbal Encyclopedia A to Z](#)[Herb Encyclopedia A to Z](#)[Horny Goat Weed - Epimedium sagittatum](#)[Itchy Skin - Dermatitis](#)

What's Hot Now

[Tonic Herbs](#) - What do they do?
[Chickweed](#) - This abundant and pesky little weed can be added to your salads and used topically for many skin conditions.
[Healthy Salads](#) - Add healing greens to your plain lettuce salads for added benefits.
[Spring Cleansing](#) - Gently renew your body with these gentle system cleansers.
[Psyllium And Cleansing Herbs](#)
03:38 PM #

[Display Latest Headlines](#) 



[Read Archives](#)

[back to top](#)



[Home](#)

[Essentials](#)

[A - Z Encyclopedia](#)[Submit A Feature Article](#)[Aromatherapy](#)[Free Herb Graphics](#)[Submit a Recipe!](#)

[Browse Categories](#)

[Basics For Beginners](#)[Find A Condition Or Symptom](#)[Herb Profiles / Monographs](#)[Consumer Safety / Toxicolog](#)[Aromatherapy](#)[Preparations And Recipes](#)[Herbal Schools](#)[Homeopathy](#)[Home And Garden](#)[Flower Essences](#)[Research](#)[Family And Pets](#)[Wild Herbs](#)[Traditional Ethnic](#)[Popular Herbs](#)

[Buyer's Guide](#)

[Before You Buy](#)[Top Picks](#)[Top 3 Essential Oil Brands](#)[Topical Pain Relief Products](#)[Product Reviews](#)

[Articles](#)

[Forums](#)

[Help](#)

Stay Current

Subscribe to the **About** Healthy Herbs newsletter.

[Topic Index](#) |

 [email to a friend](#)  font size

[Our Story](#) | [Be a Guide](#) | [Advertising Info](#) | [Investor Relations](#) | [Work at About](#) | [Help](#)

©2004 About, Inc. All rights reserved. A PRIMEDIA Company.

[User Agreement](#) | [Privacy Policy](#) | [Kids' Privacy Policy](#)

Search

[Healthy Herbs](#)

Spring Tonic Herbs

Herbs for Health Blog

[« Recipes](#) | [Main](#) | [Summers Top Ten](#) »

April 28, 2004

Spring Tonic Herbs

Spring is the perfect time to renew your system with tonic herbs!

[Tonic Herbs](#) - What do they do?

[Chickweed](#) - This abundant and pesky little weed can be added to your salads and used topically for many skin conditions.

[Healthy Salads](#) - Add healing greens to your plain lettuce salads for added benefits.

[Spring Cleansing](#) - Gently renew your body with these gentle system cleansers.

[Psyllium And Cleansing Herbs](#)

[Email a Friend](#)

[Display Latest Headlines](#) 



[Read Archives](#)

Most Popular Articles

[Spring Cleansing Herbal Encyclopedia A to Z](#)[Herb Encyclopedia A to Z](#)[Horny Goat Weed - Epimedium sagittatum](#)[Itchy Skin - Dermatitis](#)

What's Hot Now

[Herbal Encyclopedia A to Z](#)[Spring Cleansing](#)

[back to top](#)

[Search](#)

[Healthy Herbs](#)

[Email to a friend](#)[Print this page](#)

[Newsletters](#)

Most Popular Articles

[Spring Cleansing Herbal Encyclopedia A to Z](#)[Herb Encyclopedia A to Z](#)[Horny Goat Weed - Epimedium sagittatum](#)[Itchy Skin - Dermatitis](#)

What's Hot Now

[Herbal Encyclopedia A to Z](#)[Spring Cleansing](#)



[Home](#)

[Essentials](#)

[A - Z Encyclopedia](#)[Submit A Feature Article](#)[Aromatherapy Free Herb Graphics](#)[Submit a Recipe!](#)

[Browse Categories](#)

[Basics For Beginners](#)[Find A Condition Or Symptom](#)[Herb Profiles / Monographs](#)[Consumer Safety /](#)

[Toxicology](#)[Aromatherapy Preparations And Recipes](#)[Herbal Schools](#)[Homeopathy](#)[Home And Garden](#)[Flower](#)

[Essences](#)[Research](#)[Family And Pets](#)[Wild Herbs](#)[Traditional Ethnic](#)[Popular Herbs](#)

[Buyer's Guide](#)

[Before You Buy](#)[Top Picks](#)[Top 3 Essential Oil Brands](#)[Topical Pain Relief Products](#)[Product Reviews](#)

[Articles](#)

[Forums](#)

[Help](#)

Stay Current

Subscribe to the **About** Healthy Herbs newsletter.

How To Make Flax / Peanut Butter Cookies



From [Juli Kight](#),
Your Guide to [Healthy Herbs](#).

Contributed by Lisa Kiefer. An easy to make peanut butter cookie using flax as it's base.

Difficulty: Easy

Time Required: 2 hrs.

Here's How:

1. Mix until ingredients are mixed well.
2. Spoon onto a greased cookie sheet.
3. Bake at 350 until brown (approx 15-20 min.).

What You Need:

- 2 cups ground flax
- 1 Egg
- 2 Sticks of butter
- 1 C. sugar
- 1 C. chunky peanut butter
- 1 tsp. vanilla extract

[More How To's from your Guide To Herbs for Health](#)

RATE THIS ARTICLE

Would you recommend this article?

Not at all Definitely

1 2 3 4 5



[email to a friend](#)



font size

[back to top](#)

[Our Story](#) | [Be a Guide](#) | [Advertising Info](#) | [Investor Relations](#) | [Work at About](#) | [Help](#)

©2004 About, Inc. All rights reserved. A PRIMEDIA Company.

[User Agreement](#) | [Privacy Policy](#) | [Kids' Privacy Policy](#)

[Search](#)

[Healthy Herbs](#)

[Email to a friend](#)[Print this page](#)

[Newsletters](#)

Most Popular Articles

[Spring Cleansing Herbal Encyclopedia A to Z](#)[Herb Encyclopedia A to Z](#)[Horny Goat Weed - Epimedium sagittatum](#)[Itchy Skin - Dermatitis](#)

What's Hot Now

[Herbal Encyclopedia A to Z](#)[Spring Cleansing](#)

How To Make Super Sea Glow Recipe

from Shannon Winczura

A salt glow recipe contributed by reader Shannon Winczura.

Difficulty: Easy

Time Required: 40 - 60 min.

Here's How:

1. Arrange blankets on massage table with the electric blanket between the two flannel sheets.
2. Turn on the electric blanket to heat.
3. Mix the salt, vegetable oil and rose oil together.
4. Have the person lay on the blankets.
5. Apply the salt mixture to the skin.
6. Wrap the blankets around the individual and have them rest for 15 minutes.
7. After 15 minutes, have the individual shower to remove the salt and dead skin cells. Pat dry.
8. While the individual is in the shower, apply a clean sheet to the table and prepare the moisturizer.
9. Lightly massage a light moisturizer into the skin

Tips:

1. The skin will absorb moisture in the delicate state that it is in after all the skin will be very thirsty.

What You Need:

- 2 c. Sea / Mineral Salt



[Home](#)

[Essentials](#)

[A - Z Encyclopedia](#)[Submit A Feature Article](#)[Aromatherapy Free Herb Graphics](#)[Submit a Recipe!](#)

[Browse Categories](#)

[Basics For Beginners](#)[Find A Condition Or Symptom](#)[Herb Profiles /](#)

[Monographs](#)[Consumer Safety /](#)

[Toxicology](#)[Aromatherapy](#)[Preparations And Recipes](#)[Herbal](#)

[Schools](#)[Homeopathy](#)[Home And Garden](#)[Flower](#)

[Essences](#)[Research](#)[Family And Pets](#)[Wild Herbs](#)[Traditional](#)

[Ethnic](#)[Popular Herbs](#)

[Buyer's Guide](#)

[Before You Buy](#)[Top Picks](#)[Top 3 Essential Oil Brands](#)[Topical Pain](#)

[Relief Products](#)[Product Reviews](#)

[Articles](#)

[Forums](#)

[Help](#)

Stay Current

Subscribe to the **About** Healthy Herbs newsletter.

- 1 c. Vegetable Oil
- 7 drops rose oil
- 2 flannel blankets or sheets
- 1 electric blanket
- 2 oz. moisturizer
- 1 clean sheet

[More How To's from your Guide To Herbs for Health](#)

RATE THIS ARTICLE

Would you recommend this article?

Not at all Definitely
1 2 3 4 5

[Topic Index](#) |



[email to a friend](#)



font size

[back to top](#)

[Our Story](#) | [Be a Guide](#) | [Advertising Info](#) | [Investor Relations](#) | [Work at About](#) | [Help](#)

©2004 About, Inc. All rights reserved. A PRIMEDIA Company.

[User Agreement](#) | [Privacy Policy](#) | [Kids' Privacy Policy](#)

[Search](#)

[Healthy Herbs](#)

[Email to a friend](#)[Print this page](#)

[Newsletters](#)

Most Popular Articles

[Spring Cleansing Herbal Encyclopedia A to Z](#)[Herb Encyclopedia A to Z](#)[Horny Goat Weed - Epimedium sagittatum](#)[Itchy Skin - Dermatitis](#)

What's Hot Now

[Herbal Encyclopedia A to Z](#)[Spring Cleansing](#)



[Home](#)

[Essentials](#)

[A - Z Encyclopedia](#)[Submit A Feature Article](#)[Aromatherapy Free Herb Graphics](#)[Submit a Recipe!](#)

[Browse Categories](#)

[Basics For Beginners](#)[Find A Condition Or Symptom](#)[Herb Profiles / Monographs](#)[Consumer Safety /](#)

[Toxicology](#)[Aromatherapy Preparations And Recipes](#)[Herbal Schools](#)[Homeopathy](#)[Home And Garden](#)[Flower](#)

[Essences](#)[Research](#)[Family And Pets](#)[Wild Herbs](#)[Traditional Ethnic](#)[Popular Herbs](#)

[Buyer's Guide](#)

[Before You Buy](#)[Top Picks](#)[Top 3 Essential Oil Brands](#)[Topical Pain Relief Products](#)[Product Reviews](#)

[Articles](#)

[Forums](#)

[Help](#)

Stay Current

Subscribe to the **About** Healthy Herbs

newsletter.

How To Make Indulging Sugar Scrub



From [Juli Kight](#),
Your Guide to [Healthy Herbs](#).

Forum Post by LINZEE1522. I just created this recipe for sugar scrub. Everyone who tried it loves it! You can use it at the sink or shower, for your hands or as a body exfoliator.

Difficulty: Easy

Time Required: 20 min.

Here's How:

1. Add dry ingredients and mix well.
2. Add oil and glycerin
3. Mix until wet, and ingredients stick together.
4. If its to crumbly, add a little more glycerin and fragrance.
5. Put in jar or plastic container. Enjoy!

Tips:

1. I like to add some yummy scented body cream, about 1/4 tsp.
2. I recommend that you apply some lotion after using this it will make you feel even more velvety!

What You Need:

- 3 T. Raw Sugar
- 2 T. White Sugar
- 2 T. Brown Sugar
- 3 T. Epsom Salt
- 1 T. Kosher (sea) Salt

[More How To's from your Guide To Herbs for Health](#)

RATE THIS ARTICLE

Would you recommend this article?

Not at all Definitely
1 2 3 4 5

[Topic Index](#) |



[email to a friend](#)



font size



[back to top](#)

[Our Story](#) | [Be a Guide](#) | [Advertising Info](#) | [Investor Relations](#) | [Work at About](#) | [Help](#)

©2004 About, Inc. All rights reserved. A PRIMEDIA Company.

[User Agreement](#) | [Privacy Policy](#) | [Kids' Privacy Policy](#)

Search

[Healthy Herbs](#)

[Email to a friend](#)[Print this page](#)

[Newsletters](#)

Suggested Reading

[Recipe Collection](#)[Essential Oil Charts](#)

Most Popular Articles

[Spring Cleansing Herbal Encyclopedia A to Z](#)[Herb Encyclopedia A to Z](#)[Horny Goat Weed - Epimedium sagittatum](#)[Itchy Skin - Dermatitis](#)

What's Hot Now

[Herbal Encyclopedia A to Z](#)[Spring Cleansing](#)



[Home](#)

[Essentials](#)

[A - Z Encyclopedia](#)[Submit A Feature Article](#)[Aromatherapy Free Herb Graphics](#)[Submit a Recipe!](#)

[Browse Categories](#)

[Basics For Beginners](#)[Find A Condition Or Symptom](#)[Herb Profiles / Monographs](#)[Consumer Safety /](#)

[Toxicolog](#)[Aromatherapy](#)[Preparations And Recipes](#)[Herbal Schools](#)[Homeopathy](#)[Home And Garden](#)[Flower](#)

[Essences](#)[Research](#)[Family And Pets](#)[Wild Herbs](#)[Traditional Ethnic](#)[Popular Herbs](#)

[Buyer's Guide](#)

[Before You Buy](#)[Top Picks](#)[Top 3 Essential Oil Brands](#)[Topical Pain Relief Products](#)[Product Reviews](#)

[Articles](#)

[Forums](#)

[Help](#)

Stay Current

Subscribe to the **About** Healthy Herbs newsletter.

How To Make Salt Glow Scrub



From [Juli Kight](#),
Your Guide to [Healthy Herbs](#).

A wonderful blend of sea salt and oils to exfoliate and smooth skin.

Difficulty: Easy

Time Required: 15 Min.

Here's How:

1. Mix all ingredients in a jar.
2. Seal jar when not in use.
3. Stir mixture well before applying.
4. Massage in circular motions towards the heart.
5. Leave on for a few minutes then rinse off.

Tips:

1. Do not use on face.
2. You can also use it with a body shampoo more for exfoliation.
3. Choose base oils such as sweet almond, kukuki nut, hazelnut etc. according to skin type.
4. Choose essential oils appropriate for intended purpose.
5. Do not rub over irritated or broken areas of the skin.

What You Need:

- 2 c. sea or mineral salt

- 1 c. vegetable oil/blend
- 15 drops essen. oil/blend

[More How To's from your Guide To Herbs for Health](#)

RATE THIS ARTICLE

Would you recommend this article?

Not at all Definitely
1 2 3 4 5

[Topic Index](#) |



[email to a friend](#)



font size



[back to top](#)

[Our Story](#) | [Be a Guide](#) | [Advertising Info](#) | [Investor Relations](#) | [Work at About](#) | [Help](#)

©2004 About, Inc. All rights reserved. A PRIMEDIA Company.

[User Agreement](#) | [Privacy Policy](#) | [Kids' Privacy Policy](#)

You are here: [About](#)>[Health & Fitness](#)>[Healthy Herbs](#)



[Home](#)

[Essentials](#)

[A - Z Encyclopedia](#)[Submit A Feature Article](#)[Aromatherapy](#) [Free Herb Graphics](#)[Submit a Recipe!](#)

[Browse Categories](#)

[Basics For Beginners](#)[Find A Condition Or Symptom](#)[Herb Profiles / Monographs](#)[Consumer Safety / Toxicolog](#)[Aromatherapy](#)[Preparations And Recipes](#)[Herbal Schools](#)[Homeopathy](#)[Home And Garden](#)[Flower Essences](#)[Research](#)[Family And Pets](#)[Wild Herbs](#)[Traditional Ethnic](#)[Popular Herbs](#)

[Buyer's Guide](#)

[Before You Buy](#)[Top Picks](#)[Top 3 Essential Oil Brands](#)[Topical Pain Relief Products](#)[Product Reviews](#)

[Articles](#)

[Forums](#)

[Help](#)

Stay Current

Subscribe to the **About** Healthy Herbs newsletter.

[Topic Index](#) |

 [email to a friend](#)  font size

[Our Story](#) | [Be a Guide](#) | [Advertising Info](#) | [Investor Relations](#) | [Work at About](#) | [Help](#)

©2004 About, Inc. All rights reserved. A PRIMEDIA Company.

[User Agreement](#) | [Privacy Policy](#) | [Kids' Privacy Policy](#)

Search

[Healthy Herbs](#)

April 19, 2004

Herbs for Health Blog Archives **Most Popular Articles**

« [April 08, 2004](#) | [Main](#) | [April 28, 2004](#) » [Spring Cleansing Herbal](#)

[Encyclopedia A to Z](#)[Herb Encyclopedia A to Z](#)[Horny Goat Weed - Epimedium sagittatum](#)[Itchy Skin - Dermatitis](#)

Recipes

Here are two new recipes for you to add to your recipe boxes.

[Flax / Peanut Butter Cookies](#)

[Super Sea Glow For Skin](#)

Related:

[Indulging Sugar Scrub](#)

[Salt Glow Scrub](#)

What's Hot Now

[Herbal Encyclopedia A to Z](#)[Spring Cleansing](#)

[06:58 AM](#) #

[Display Latest Headlines](#) 



[Read Archives](#)

[back to top](#)

You are here: [About](#)>[Health & Fitness](#)>[Healthy Herbs](#)



[Home](#)

[Essentials](#)

[A - Z Encyclopedia](#)[Submit A Feature Article](#)[Aromatherapy](#) [Free Herb Graphics](#)[Submit a Recipe!](#)

[Browse Categories](#)

[Basics For Beginners](#)[Find A Condition Or Symptom](#)[Herb Profiles / Monographs](#)[Consumer Safety / Toxicolog](#)[Aromatherapy](#)[Preparations And Recipes](#)[Herbal Schools](#)[Homeopathy](#)[Home And Garden](#)[Flower Essences](#)[Research](#)[Family And Pets](#)[Wild Herbs](#)[Traditional Ethnic](#)[Popular Herbs](#)

[Buyer's Guide](#)

[Before You Buy](#)[Top Picks](#)[Top 3 Essential Oil Brands](#)[Topical Pain Relief Products](#)[Product Reviews](#)

[Articles](#)

[Forums](#)

[Help](#)

Stay Current

Subscribe to the **About** Healthy Herbs newsletter.

[Topic Index](#) |

 [email to a friend](#)  font size

[Our Story](#) | [Be a Guide](#) | [Advertising Info](#) | [Investor Relations](#) | [Work at About](#) | [Help](#)

©2004 About, Inc. All rights reserved. A PRIMEDIA Company.
[User Agreement](#) | [Privacy Policy](#) | [Kids' Privacy Policy](#)

Search

[Healthy Herbs](#)

Recipes

Herbs for Health Blog
[« Healing Spaces With Herbs | Main | Spring Tonic Herbs »](#)

April 19, 2004

Recipes

Here are two new recipes for you to add to your recipe boxes.

[Flax / Peanut Butter Cookies](#)

[Super Sea Glow For Skin](#)

Related:

[Indulging Sugar Scrub](#)

[Salt Glow Scrub](#)

[Email a Friend](#)

[Display Latest Headlines](#) 



[Read Archives](#)

Most Popular Articles

[Spring Cleansing Herbal Encyclopedia A to Z](#)

[Herb Encyclopedia A to Z](#)

[Horny Goat Weed -](#)

[Epimedium](#)

[sagittatum](#)

[Itchy Skin -](#)

[Dermatitis](#)

What's Hot Now

[Herbal Encyclopedia A to Z](#)

[Spring Cleansing](#)

[back to top](#)

[Search](#)

[Healthy Herbs](#)

[Email to a friend](#)[Print this page](#)

[Newsletters](#)

Suggested Reading

[Starting Herb Seeds Indoors](#)[Budget Seed Starting Tips](#)

Grow Sheets

[How I Grew My Catnip](#)[Echinacea Grow Sheet](#)[Ginger Grow Sheet](#)

Most Popular Articles

[Spring Cleansing Herbal Encyclopedia A to Z](#)[Herb Encyclopedia A to Z](#)[Horny Goat Weed - Epimedium sagittatum](#)[Itchy Skin - Dermatitis](#)

What's Hot Now

[Herbal Encyclopedia A to Z](#)[Spring Cleansing](#)

Grow Medicinal Herbs In Containers



From [Juli Kight](#),
Your Guide to [Healthy Herbs](#).

[Page 1 - Pro's and Con's of Container Gardens](#)

[Page 2 - Selecting Herbs](#)

[Page 3 - Planting Guide](#)

I like growing herbs in containers for several reasons.

You create changeable groupings.
Smaller plants are more visible and can compliment each other.
Growing conditions and exposure to pests can be more easily controlled.

They are closer to you where you can really appreciate them instead of being buried in the garden away from the living areas.
You can be quite creative and have beautiful miniature living gardens full of color.

There are only a few disadvantages to having a container garden however, once it's growing it is well worth the effort. They are:

They need to be watered more as they dry out very fast.
May require additional feeding.
Large pots are heavy and require a dolly or two people to move.
You may be limited in what you can grow in reference to size, however, I like to push the limits and try many in containers.
If you are planning a roof-top, deck or porch garden, make sure you know your weight limitations. Containers full of wet soil



[Home](#)

[Essentials](#)

[A - Z Encyclopedia](#)[Submit A Feature Article](#)[Aromatherapy Free Herb Graphics](#)[Submit a Recipe!](#)

[Browse Categories](#)

[Basics For Beginners](#)[Find A Condition Or Symptom](#)[Herb Profiles /](#)

[Monographs](#)[Consumer Safety /](#)

[Toxicolog](#)[Aromatherapy](#)[Preparations And Recipes](#)[Herbal](#)

[Schools](#)[Homeopathy](#)[Home And Garden](#)[Flower](#)

[Essences](#)[Research](#)[Family And Pets](#)[Wild Herbs](#)[Traditional](#)

[Ethnic](#)[Popular Herbs](#)

[Buyer's Guide](#)

[Before You Buy](#)[Top Picks](#)[Top 3 Essential Oil Brands](#)[Topical Pain](#)

[Relief Products](#)[Product Reviews](#)

[Articles](#)

[Forums](#)

[Help](#)

Stay Current

Subscribe to the **About** Healthy Herbs
newsletter.

and plants can get extremely heavy. One gallon of water weighs 8.34 pounds.

The containers can be just about anything as long as they have a drain hole. Keep in mind that the more porous the container material is, the faster it will dry out. If it is moisture retentive or does not have adequate drainage, the roots will most likely rot. Interesting containers I have used where metal baskets and even plastic milk crates. I just simply lined them with plastic, filled it with potting soil then punched holes in it for drainage and the plant plugs. My favorites are ceramic and clay pots however they get very heavy to move so I use primarily light weight imitation clay pots for the large ones.

- [1](#)
- [2](#)
- [3](#)
- [Next](#)

RATE THIS ARTICLE

Would you recommend this article?

Not at all Definitely

1 2 3 4 5

[Topic Index](#) |



[email to a friend](#)



font size



[back to top](#)

[Our Story](#) | [Be a Guide](#) | [Advertising Info](#) | [Investor Relations](#) | [Work at About](#) | [Help](#)

©2004 About, Inc. All rights reserved. A PRIMEDIA Company.

[User Agreement](#) | [Privacy Policy](#) | [Kids' Privacy Policy](#)

[Search](#)

[Healthy Herbs](#)

[Email to a friend](#)[Print this page](#)

[Newsletters](#)

Most Popular Articles

[Spring Cleansing Herbal Encyclopedia A to Z](#)[Herb Encyclopedia A to Z](#)[Horny Goat Weed - Epimedium sagittatum](#)[Itchy Skin - Dermatitis](#)

What's Hot Now

[Herbal Encyclopedia A to Z](#)[Spring Cleansing](#)

Butterfly And Hummingbird Herbs



From [Juli Kight](#),
Your Guide to [Healthy Herbs](#).

Create a healing space using herbs which attract butterflies and hummingbirds. This can be a space in your garden or a space created by a container herb garden. A few years ago while living in Minnesota I had been planting various and unusual herbs, roses and growing geraniums into standards. We had two warm seasons and had been seeing a lot of unusual life in the garden that I normally had not seen including hummingbirds. One early morning after putting the dog out, I stood on the porch among the plants and saw what I thought was a really unusual hummingbird. Then I noticed the antenna, and really had to look closer to make sure that is what I was seeing, and was captivated. Apparently we were being visited by some sort of hummingbird or Sphinx Moth and I have not seen one since. Now that I live in Central Texas and still very much a novice at this, I have noticed huge amounts of butterflies and moths as well as hummingbirds and have decided to add more plants to attract them.

Butterfly plants provide nectar for adult butterflies and food for the offspring. It is important to learn how to garden organically to make it a safe haven and supporting area for these little life forms. Many nectar plants are shared by both the butterfly and hummingbird. According to [Hummingbirds.net](#), hummingbirds lack the sense of smell and go by "visibility and nectar production". I had noticed they seem attracted to reds especially.

Find out which butterflies and moths are native to your area. You can do this by going to the [Butterflies Of North America](#) web site. This site offers distribution maps, butterfly and moth identification by region and information on the species. For hummingbirds visit [Hummingbirds.net](#) [Species list](#) by state.

For selecting plants for butterflies, visit the [Butterfly Website](#) which offers a list by species, then gives both nectar and host plant suggestions. Some easy herb selections include: Lavenders



[Home](#)

[Essentials](#)

[A - Z Encyclopedia](#)[Submit A Feature Article](#)[Aromatherapy Free Herb Graphics](#)[Submit a Recipe!](#)

[Browse Categories](#)

[Basics For Beginners](#)[Find A Condition Or Symptom](#)[Herb Profiles /](#)

[Monographs](#)[Consumer Safety /](#)

[Toxicology](#)[Aromatherapy](#)[Preparations And Recipes](#)[Herbal](#)

[Schools](#)[Homeopathy](#)[Home And Garden](#)[Flower](#)

[Essences](#)[Research](#)[Family And Pets](#)[Wild Herbs](#)[Traditional](#)

[Ethnic](#)[Popular Herbs](#)

[Buyer's Guide](#)

[Before You Buy](#)[Top Picks](#)[Top 3 Essential Oil Brands](#)[Topical Pain](#)

[Relief Products](#)[Product Reviews](#)

[Articles](#)

[Forums](#)

[Help](#)

Stay Current

Subscribe to the **About** Healthy Herbs
newsletter.

Thyme
Sassafrass
Savory
Yarrow
Nasturtiums
Catmint
Sages
Oregano
Echinacea
Hyacinth Bean Vine
Beebalm
Joe Pye Weed
Goldenrod
Nettle
Fennel
Parsley

Hummingbirds:
Bee Balm
Nasturtiums
Salvias
Digitalis
Yucca
Mimosa

RATE THIS ARTICLE

Would you recommend this article?

Not at all 1 2 3 4 5 Definitely

[Topic Index](#) |



[email to a friend](#)



font size



[back to top](#)

[Our Story](#) | [Be a Guide](#) | [Advertising Info](#) | [Investor Relations](#) | [Work at About](#) | [Help](#)

©2004 About, Inc. All rights reserved. A PRIMEDIA Company.

[User Agreement](#) | [Privacy Policy](#) | [Kids' Privacy Policy](#)

Search

[Healthy Herbs](#)

The Fragrant Garden

A fragrant healing garden can do more for you than you think.

Many of us lead busy and complicated lives, forgetting the beauty of simplicities in life. A fragrant herb garden can calm, stimulate, heighten the senses, heal and add beauty and life to even the smallest of garden spaces. Fragrant herbs combined with other garden and wildflowers create what is sometimes referred to as a [sensory garden](#).

What is an aromatic herb? One which possesses a strong and usually pleasant odor. Not all will agree that all plant aroma's are pleasant, and one plant may not smell the same to different people. Some aromatic herbs will exude a heavy scent on their own, some are more mild and are activated by brushing by or running your hand lightly through it. Scents range from mild to pungent floral, citrus, spicy, fruity and blends. Let's not discount fragrant bedding plants, perennials, shrubs and trees either for this purpose. I believe any plant that is aromatic and pleasing to you has emotional and psychological healing properties.

Aromatic gardens are personal [healing spaces](#). The plants you select are pleasing to you whether it be for the scent, texture or visual effects. For example, I have just started my aromatic healing space for a small patio. Along with a varied fern selection to soften the area, I have added scented geraniums (rose and old spice), [rosemary](#) and various patio roses, all in containers. My plans are to add some basil and thyme, nutmeg and ginger scented geraniums, lavender and some [fragrant vines](#).

The more open your fragrance garden is, the lighter the scent will be if any especially on breezy days. Partially enclosed areas or areas behind wind breaks work well. You can create areas of quiet air using vines, trellises, shrubs and small trees. Add comfortable seating or a hammock, a wind chime, small fountain and you have a wonderful place to relax, rejuvenate and focus.

I personally like to purchase my plants first hand instead of on-line. Its fun to take a few hours and just smell the different varieties and see how they effect your mood, emotions etc. Only you know if you like the scent of that particular plant. If you purchase your chosen scent online, make sure you are getting the same plant variety you tested in person. For example, southernwood can smell like tangerines, or camphor depending on the variety. There are several types of rose geraniums such as Attar of Roses, Gray Lady Rose or Snowflake Rose, each with their own subtle differences which you may or may not like.

Below are links to help guide you in creating your fragrant healing garden with ideas, plants to use and plans.

[Plant Some Aromatic Herbs To Attract Butterflies!](#)

[How your garden can keep you well](#)

[The Fragrant Garden-Fragrant Plants](#)

[The Fragrant Herbs](#)

[Lesser Known Australian Aromatic Herbs](#)

Most Popular Articles

[Spring Cleansing](#)

[Herbal](#)

[Encyclopedia A to Z](#)

[Encyclopedia A to Z](#)

[Horny Goat Weed -](#)

[Epimedium](#)

[sagittatum](#)

[Itchy Skin - Dermatitis](#)

What's Hot Now

[Herbal](#)

[Encyclopedia A to Z](#)

[Spring](#)

[Cleansing](#)



[Home](#)

[Essentials](#)

[A - Z Encyclopedia](#)

[Submit A Feature Article](#)

[Aromatherapy Free Herb Graphics](#)

[Submit a Recipe!](#)

[Browse Categories](#)

[Basics For Beginners](#)

[Find A Condition Or Symptom](#)

[Herb Profiles / Monographs](#)

[Consumer Safety /](#)

[Toxicology](#)

[Aromatherapy Preparations And Recipes](#)

[Herbal](#)

[Schools](#)

[Homeopathy](#)

[Home And Garden](#)

[Flower](#)

[Essences](#)

[Research](#)

[Family And Pets](#)

[Wild Herbs](#)

[Traditional](#)

[Ethnic](#)

[Popular Herbs](#)

[Buyer's Guide](#)

[Before You Buy](#)

[Top Picks](#)

[Top 3 Essential Oil](#)

[Brands](#)

[Topical Pain Relief Products](#)

[Product Reviews](#)

[Articles](#)

[Forums](#)

[Help](#)

Stay Current

Subscribe to the **About** Healthy Herbs
newsletter.

[Helen's Garden of Fragrant Plants](#)

[The Gardeningguru's Scented Geranium Page!](#)

[Aromatic Plants of Province](#)

[Sycamore Farms Natural Herb Farms Planting Guide for
Theme Herb Gardens](#)

[Culinary And Fragrant Herbs Of Religious Symbolism](#)

[Themes: Fragrance Gardens](#)

[Richters Herb Catalogue](#)

[Garden Plans Online](#)

Recent Discussions

[energy herbs St. Johns Wort what to take for depression
and IBS?](#)

Subscribe to The Herbs For Health Newsletter

Name

Email

Previous Features



From [Juli Kight](#),
Your Guide to [Healthy Herbs](#).

RATE THIS ARTICLE

Would you recommend this article?

Not at all

Definitely

1 2 3 4 5

[Topic Index](#) |



[email to a friend](#)



font size

About

[back to top](#)

[Our Story](#) | [Be a Guide](#) | [Advertising Info](#) | [Investor Relations](#) | [Work at About](#) | [Help](#)

©2004 About, Inc. All rights reserved. A PRIMEDIA Company.

[User Agreement](#) | [Privacy Policy](#) | [Kids' Privacy Policy](#)

You are here: [About](#)>[Health & Fitness](#)>[Healthy Herbs](#)



[Home](#)

[Essentials](#)

[A - Z Encyclopedia](#)[Submit A Feature Article](#)[Aromatherapy](#) [Free Herb Graphics](#)[Submit a Recipe!](#)

[Browse Categories](#)

[Basics For Beginners](#)[Find A Condition Or Symptom](#)[Herb Profiles / Monographs](#)[Consumer Safety / Toxicolog](#)[Aromatherapy](#)[Preparations And Recipes](#)[Herbal Schools](#)[Homeopathy](#)[Home And Garden](#)[Flower Essences](#)[Research](#)[Family And Pets](#)[Wild Herbs](#)[Traditional Ethnic](#)[Popular Herbs](#)

[Buyer's Guide](#)

[Before You Buy](#)[Top Picks](#)[Top 3 Essential Oil Brands](#)[Topical Pain Relief Products](#)[Product Reviews](#)

[Articles](#)

[Forums](#)

[Help](#)

Stay Current

Subscribe to the **About** Healthy Herbs newsletter.

[Topic Index](#) |

 [email to a friend](#)   font size

[Our Story](#) | [Be a Guide](#) | [Advertising Info](#) | [Investor Relations](#) | [Work at About](#) | [Help](#)

©2004 About, Inc. All rights reserved. A PRIMEDIA Company.

[User Agreement](#) | [Privacy Policy](#) | [Kids' Privacy Policy](#)

Search

[Healthy Herbs](#)

April 08, 2004

Herbs for Health Blog Archives

« [April 06, 2004](#) | [Main](#) | [April](#)

[19, 2004](#) »

Most Popular Articles

[Spring Cleansing Herbal Encyclopedia A to Z](#)[Herb Encyclopedia A to Z](#)[Horny Goat Weed - Epimedium sagittatum](#)[Itchy Skin - Dermatitis](#)

Healing Spaces With Herbs

Start creating your healing spaces for the gardening season with:

[Herbal Container Gardens](#)
[Butterfly And Hummingbird Herbs](#)

[The Fragrant Garden](#)

[07:32 AM](#) #

What's Hot Now

[Herbal Encyclopedia A to Z](#)[Spring Cleansing](#)

[Display Latest Headlines](#) 



[Read Archives](#)

[back to top](#)

You are here: [About](#)>[Health & Fitness](#)>[Healthy Herbs](#)



[Home](#)

[Essentials](#)

[A - Z Encyclopedia](#)[Submit A Feature Article](#)[Aromatherapy](#)[Free Herb Graphics](#)[Submit a Recipe!](#)

[Browse Categories](#)

[Basics For Beginners](#)[Find A Condition Or Symptom](#)[Herb Profiles / Monographs](#)[Consumer Safety / Toxicolog](#)[Aromatherapy](#)[Preparations And Recipes](#)[Herbal Schools](#)[Homeopathy](#)[Home And Garden](#)[Flower Essences](#)[Research](#)[Family And Pets](#)[Wild Herbs](#)[Traditional Ethnic](#)[Popular Herbs](#)

[Buyer's Guide](#)

[Before You Buy](#)[Top Picks](#)[Top 3 Essential Oil Brands](#)[Topical Pain Relief Products](#)[Product Reviews](#)

[Articles](#)

[Forums](#)

[Help](#)

Stay Current

Subscribe to the **About** Healthy Herbs newsletter.

[Topic Index](#) |

 [email to a friend](#)  font size

[Our Story](#) | [Be a Guide](#) | [Advertising Info](#) | [Investor Relations](#) | [Work at About](#) | [Help](#)

©2004 About, Inc. All rights reserved. A PRIMEDIA Company.

[User Agreement](#) | [Privacy Policy](#) | [Kids' Privacy Policy](#)

Search

[Healthy Herbs](#)

Healing Spaces With Herbs

Most Popular Articles

[Herbs for Health Blog](#)

[« EPHEDRA BANNED TODAY](#) | [Main](#) | [Recipes](#) »

[Spring Cleansing Herbal](#)

[Encyclopedia A to Z](#)

[Herb Encyclopedia A to Z](#)

[Horny Goat Weed - Epimedium](#)

[sagittatum](#)

[Itchy Skin - Dermatitis](#)

April 08, 2004

Healing Spaces With Herbs

Start creating your healing spaces for the gardening season with:

[Herbal Container Gardens](#)

[Butterfly And Hummingbird](#)

[Herbs](#)

[The Fragrant Garden](#)

What's Hot Now

[Herbal Encyclopedia A to Z](#)

[Spring Cleansing](#)

[Email a Friend](#)

[Display Latest Headlines](#) 



[Read Archives](#)

[back to top](#)



U.S. Food and Drug Administration



Department of
Health and
Human Services

[FDA Home Page](#) | [CFSAN Home](#) | [Search/Subject Index](#) | [Q & A](#) | [Help](#)

FDA News

FOR IMMEDIATE RELEASE

P04-17

February 6, 2004

Media Inquiries: 301-827-6242

Consumer Inquiries:

888-INFO-FDA

FDA Issues Regulation Prohibiting Sale of Dietary Supplements Containing Ephedrine Alkaloids and Reiterates Its Advice That Consumers Stop Using These Products

The Food and Drug Administration (FDA) today issued a final rule prohibiting the sale of dietary supplements containing ephedrine alkaloids (ephedra) because such supplements present an unreasonable risk of illness or injury. The rule will become effective 60 days from the date of publication.

"This FDA rule reflects what the scientific evidence shows - that ephedra poses an unreasonable risk to those who use it," Health and Human Services Tommy G. Thompson said. "The regulations prohibit the sale of dietary supplements containing ephedra, and we intend to take swift action against anyone who puts consumers at risk by continuing to sell such products after the prohibition takes effect."

"In December, we advised consumers to stop using ephedra products, and we asked responsible companies to stop selling them," said FDA Commissioner Mark B. McClellan, M.D., Ph.D. "We intend to use this regulation to make sure consumers are protected by removing these risky products from the market."

Under the Dietary Supplement Health and Education Act (DSHEA) of 1994, FDA may remove a dietary supplement from the market if it presents a significant or unreasonable risk of illness or injury when used

according to its labeling or under ordinary conditions of use. FDA's final regulation presents a framework for applying this unique statutory standard.

To meet the standard required by the dietary supplement law, the FDA gathered and thoroughly reviewed evidence about ephedra's pharmacology; peer-reviewed scientific literature on ephedra's safety and effectiveness; adverse event reports; and a seminal report by the RAND Corporation, an independent scientific institute. The FDA also reviewed tens of thousands of public comments on the agency's request in March 2003 for information about ephedra-associated health risks.

In recent years, dietary supplements containing ephedrine alkaloids have been extensively promoted for aiding weight control and boosting sports performance and energy. The totality of the available data showed little evidence of ephedra's effectiveness except for modest, short-term weight loss without any clear health benefit, while confirming that the substance raises blood pressure and otherwise stresses the circulatory system. These effects are linked to significant adverse health outcomes, including heart attack and stroke. "Until the final rule prohibiting the sale of ephedra-containing dietary supplements takes effect, FDA reiterates its warning to consumers: 'Do not take these products. They are simply too risky,'" said Dr. McClellan.

Ephedra, also called Ma huang, is one of the plants that are a source of ephedrine alkaloids, including ephedrine and pseudoephedrine. When chemically synthesized, ephedrine and pseudoephedrine are regulated under the Federal Food, Drug, and Cosmetic Act as drugs. In contrast to the DSHEA-regulated dietary supplements that contain ephedrine alkaloids, the safety and effectiveness of drug products containing ephedrine alkaloids in drug products have to be proven by the manufacturer.

The issuance of this final rule continues a process that started in June, 1997 when FDA first issued a proposal that required a statement on dietary supplements containing ephedrine alkaloids warning that they are hazardous and should not be used for more than seven days. FDA also proposed to restrict the amount of ephedrine alkaloids in dietary supplements and to prevent combining ephedra with other ingredients that have a known stimulant effect.

FDA modified this proposed rule in 2000, and in February 2003 it announced a series of measures that included taking enforcement actions against firms making unsubstantiated claims regarding enhanced athletic performance for their ephedra-containing products. FDA also issued warning letters to firms promoting these products as alternatives to illicit street drugs. Many firms have complied with FDA's warning against making such claims. FDA has also followed up with seizures and injunctions and joint enforcement actions with the Federal Trade Commission and the Department of Justice. (More detail on these actions can be found at <http://www.fda.gov/ola/2003/dietarysupplements1028.html>.) As a result, most ephedra-containing dietary supplements advertised for enhanced sport performance have been removed from the market.

Additional information relating to ephedra is available online at www.cfsan.fda.gov/~dms/ds-ephed.html.

#####

[Questions and Answers about FDA's Actions on Dietary Supplements Containing Ephedrine Alkaloids](#)

[Federal Register - Final Rule](#)

[Final Rule Summary](#)

[Background Information](#)

This is a mirror of the page at <http://www.fda.gov/bbs/topics/NEWS/2004/NEW01021.html>

[Food Press Releases and Fact Sheets](#)

[CFSAN Home](#) | [CFSAN Search/Subject Index](#) | [CFSAN Disclaimers & Privacy Policy](#) | [CFSAN Accessibility/Help](#)

[FDA Home Page](#) | [Search FDA Site](#) | [FDA A-Z Index](#) | [Contact FDA](#)

Search
[Healthy Herbs](#)

Herb Index A - Z

A - G	H - Z
Alfalfa (Medicago sativa)	Hawthorn (Crataegus oxyacantha & C. monogyna)
Aloe Vera (Aloe barbadensis)	Honeysuckle (Lonicera japonica)
Angelica , Dong Quai Root (Angelica sinensis)	Horny Goat Weed (Epimedium sagittatum)
Arnica (Arnica montana)	Jamaican Dogwood (Piscidia erythrina)
Asafoetida (Ferula assa-foetida)	Kava (Piper methysticum)
Ashwagandha (Withania somnifera)	Kombucha
Astragalus (Astragalus membranaceus)	Licorice (Glycyrrhiza glabra)
Barley (Herb/Plant Food)	Lavender (Lavandula sp.)
Bee Balm (Monarda)	Lobelia (Lobelia inflata)
Bilberry (Vaccinium spp.)	Maca (Lepidium meyenii)
Birch (Betula sp.)	Marijuana
Black Cohosh (Cimicifuga racemosa)	Milk Thistle (Silybum marianum)
Blue Cohosh (Caulophyllum thalictroides)	Mimosa - (Albizia)
Blue Vervain (Verbena hastata)	Mistletoe - (Viscum album)
Black Elder (Sambucus nigra)	Muiru Puama
Bupleurium (Bupleurium falcatum) Chai hu	Mushrooms
Burdock (Arctium Lappa)	Noni (Morinda citrifolia)
Calendula (Calendula officinalis)	Opium Lettuce (Lactuca virosa)
Catnips (Nepeta spp.)	Passionflower (Passiflora incarnata)
Catuaba - Erythroxylum catuaba	Pau De Arco (Tabebuia impetiginosa)
Chamomile	Peppermint (Mentha peperita)
Cherry (Wild/Choke) (Prunus sp.)	Poppy (Papaver somniferum)
Chia (Salvia Columbariae and Salvia hispanica)	Psyllium - Plantago psyllium and P. ovata
Cinnamon (Cinnamomum sp.)	Quinoa
Cleavers - Galium aparine	Raspberry Rubus idaeus
Cnidium Monnieri	Rose Hips
Comfey (Symphytum officinale)	Rosemary (Rosmarinus spp.)
Cranberry (Vaccinium macrocarpon)	Salvias
Curly Dock (Rumex crispus)	Salvia Divinorum
	Saw Palmetto
	Schisandra - Wu Wei Zi (Schisandra chinensis)



[Home](#)

[Essentials](#)

[A - Z Encyclopedia](#)[Submit A Feature](#)

[Article](#)[Aromatherapy](#) [Free Herb Graphics](#)[Submit a Recipe!](#)

[Browse Categories](#)

[Basics For Beginners](#)[Find A Condition Or Symptom](#)[Herb Profiles / Monographs](#)[Consumer Safety / Toxicolog](#)[Aromatherapy](#)[Preparations And Recipes](#)[Herbal Schools](#)[Homeopathy](#)[Home And Garden](#)[Flower Essences](#)[Research](#)[Family And Pets](#)[Wild Herbs](#)[Traditional Ethnic](#)[Popular Herbs](#)

[Buyer's Guide](#)

[Before You Buy](#)[Top Picks](#)[Top 3 Essential Oil Brands](#)[Topical Pain Relief Products](#)[Product Reviews](#)

Most Popular Articles

[Spring](#)

[Cleansing](#)

[Herbal](#)

[Encyclopedia](#)

[A to Z](#)

[Herb Encyclopedia](#)

[A to Z](#)

[Horny](#)

[Goat Weed -](#)

[Epimedium](#)

[sagittatum](#)

[Itchy](#)

[Skin -](#)

[Dermatitis](#)

What's Hot

[Articles](#)

[Forums](#)

[Help](#)

Stay Current

Subscribe to the **About** Healthy Herbs newsletter.

Damiana (Turnera aphrodisiaca)	Scullycap (Scutellaria lateriflora)
Dandelion (Taraxacum officinale)	Seaweeds
Echinacea	She Chuang Zi
Ephedra (Ma Huang)	Soy
Eucalyptus (Eucalyptus globulus)	St. John's Wort
Eurycoma Longifolia Jack (Tonghat Ali)	Stevia (Stevia rebaudiana)
Feverfew Tanacetum parthenium	Stinging Nettle (Urtica dioica)
Fo-ti (Polygonum multiflorum) He shou wu	Tonghat Ali (Eurycoma Longifolia Jack)
Foxglove (Digitalis sp.)	Tribulus Terrestris - Puncture Vine
Garlic	Tumeric (Curcuma longa)
Ginger (Zingiber officinale)	Usnea
Ginkgo	Valerian (Valeriana officinalis)
Ginseng	Violet, Heartsease (Viola tri color)
Goldenseal (Hydrastis canadensis)	Violet, Sweet (Viola odorata)
Gotu Kola (Centella asiatica)	Wild Yam (Dioscorea villosa)
Green Tea (Camellia sinensis)	Willow (Salix spp.)
Gymnema sylvestris	Witch Hazel (Hamamelis virginiana)
	Yarrow (Achillea spp.)
	Yohimbe (Corynanthe yohimbe)

Now
[Herbal Encyclopedia A to Z](#)
[Spring Cleansing](#)

[Encyclopedia Index](#)



Image Copyright © Juli Kight 2003



From [Juli Kight](#),
Your Guide to [Healthy Herbs](#).

RATE THIS ARTICLE

Would you recommend this article?

Not at all Definitely

1 2 3 4 5

[Topic Index](#) |

[email to a friend](#) font size

[back to top](#)

[Our Story](#) | [Be a Guide](#) | [Advertising Info](#) | [Investor Relations](#) | [Work at About](#) | [Help](#)

©2004 About, Inc. All rights reserved. A PRIMEDIA Company.

[User Agreement](#) | [Privacy Policy](#) | [Kids' Privacy Policy](#)

You are here: [About](#)>[Health & Fitness](#)>[Healthy Herbs](#)



[Home](#)

[Essentials](#)

[A - Z Encyclopedia](#)[Submit A Feature Article](#)[Aromatherapy](#) [Free Herb Graphics](#)[Submit a Recipe!](#)

[Browse Categories](#)

[Basics For Beginners](#)[Find A Condition Or Symptom](#)[Herb Profiles / Monographs](#)[Consumer Safety / Toxicolog](#)[Aromatherapy](#)[Preparations And Recipes](#)[Herbal Schools](#)[Homeopathy](#)[Home And Garden](#)[Flower Essences](#)[Research](#)[Family And Pets](#)[Wild Herbs](#)[Traditional Ethnic](#)[Popular Herbs](#)

[Buyer's Guide](#)

[Before You Buy](#)[Top Picks](#)[Top 3 Essential Oil Brands](#)[Topical Pain Relief Products](#)[Product Reviews](#)

[Articles](#)

[Forums](#)

[Help](#)

Search

[Healthy Herbs](#)

Science And Research

Research Herbs

More Categories

[Databases \(7\)](#)

[Phytochemicals \(18\)](#)

[Research Methods \(9\)](#)

Stay Current

Subscribe to the **About** Healthy Herbs newsletter.

[Topic Index](#) |

 [email to a friend](#)  font size

[Our Story](#) | [Be a Guide](#) | [Advertising Info](#) | [Investor Relations](#) | [Work at About](#) | [Help](#)

©2004 About, Inc. All rights reserved. A PRIMEDIA Company.

[User Agreement](#) | [Privacy Policy](#) | [Kids' Privacy Policy](#)

[back to top](#)

You are here: [About](#)>[Health & Fitness](#)>[Healthy Herbs](#)



[Home](#)

[Essentials](#)

[A - Z Encyclopedia](#)[Submit A Feature Article](#)[Aromatherapy Free Herb Graphics](#)[Submit a Recipe!](#)

[Browse Categories](#)

[Basics For Beginners](#)[Find A Condition Or Symptom](#)[Herb Profiles / Monographs](#)[Consumer Safety / Toxicolog](#)[Aromatherapy](#)[Preparations And Recipes](#)[Herbal Schools](#)[Homeopathy](#)[Home And Garden](#)[Flower Essences](#)[Research](#)[Family And Pets](#)[Wild Herbs](#)[Traditional Ethnic](#)[Popular Herbs](#)

[Buyer's Guide](#)

[Before You Buy](#)[Top Picks](#)[Top 3 Essential Oil Brands](#)[Topical Pain Relief Products](#)[Product Reviews](#)

[Articles](#)

[Forums](#)

[Help](#)

Stay Current

Subscribe to the **About** Healthy Herbs newsletter.

[Topic Index](#) |

 [email to a friend](#)  font size

[Our Story](#) | [Be a Guide](#) | [Advertising Info](#) | [Investor Relations](#) | [Work at About](#) | [Help](#)

©2004 About, Inc. All rights reserved. A PRIMEDIA Company.

[User Agreement](#) | [Privacy Policy](#) | [Kids' Privacy Policy](#)

Search

[Healthy Herbs](#)

Family And Pets

Family And Pets

More Categories

[Herbs And Pets \(25\)](#)

[Herbs For Children \(13\)](#)

[back to top](#)

You are here: [About](#)>[Health & Fitness](#)>[Healthy Herbs](#)



[Home](#)

[Essentials](#)

[A - Z Encyclopedia](#)[Submit A Feature Article](#)[Aromatherapy](#) [Free Herb Graphics](#)[Submit a Recipe!](#)

[Browse Categories](#)

[Basics For Beginners](#)[Find A Condition Or Symptom](#)[Herb Profiles / Monographs](#)[Consumer Safety / Toxicolog](#)[Aromatherapy](#)[Preparations And Recipes](#)[Herbal Schools](#)[Homeopathy](#)[Home And Garden](#)[Flower Essences](#)[Research](#)[Family And Pets](#)[Wild Herbs](#)[Traditional Ethnic](#)[Popular Herbs](#)

[Buyer's Guide](#)

[Before You Buy](#)[Top Picks](#)[Top 3 Essential Oil Brands](#)[Topical Pain Relief Products](#)[Product Reviews](#)

[Articles](#)

[Forums](#)

[Help](#)

Search

[Healthy Herbs](#)

Wild Herbs

Wild Herbs

More Categories

[Food Plants \(15\)](#)

[Identification And Images \(2\)](#)

[wildcrafting](#)

[wildcrafting](#)

Stay Current

Subscribe to the **About** Healthy Herbs newsletter.

[Topic Index](#) |

 [email to a friend](#)  font size

[Our Story](#) | [Be a Guide](#) | [Advertising Info](#) | [Investor Relations](#) | [Work at About](#) | [Help](#)

©2004 About, Inc. All rights reserved. A PRIMEDIA Company.

[User Agreement](#) | [Privacy Policy](#) | [Kids' Privacy Policy](#)



[back to top](#)

You are here: [About](#)>[Health & Fitness](#)>[Healthy Herbs](#)



[Home](#)

[Essentials](#)

[A - Z Encyclopedia](#)[Submit A Feature Article](#)[Aromatherapy](#) [Free Herb Graphics](#)[Submit a Recipe!](#)

[Browse Categories](#)

[Basics For Beginners](#)[Find A Condition Or Symptom](#)[Herb Profiles / Monographs](#)[Consumer Safety / Toxicolog](#)[Aromatherapy](#)[Preparations And Recipes](#)[Herbal Schools](#)[Homeopathy](#)[Home And Garden](#)[Flower Essences](#)[Research](#)[Family And Pets](#)[Wild Herbs](#)[Traditional Ethnic](#)[Popular Herbs](#)

[Buyer's Guide](#)

[Before You Buy](#)[Top Picks](#)[Top 3 Essential Oil Brands](#)[Topical Pain Relief Products](#)[Product Reviews](#)

[Articles](#)

[Forums](#)

[Help](#)

Stay Current

Subscribe to the **About** Healthy Herbs

newsletter.

[Topic Index](#) |



[email to a friend](#)



font size

[Our Story](#) | [Be a Guide](#) | [Advertising Info](#) | [Investor Relations](#) | [Work at About](#) | [Help](#)

©2004 About, Inc. All rights reserved. A PRIMEDIA Company.

[User Agreement](#) | [Privacy Policy](#) | [Kids' Privacy Policy](#)

Search

[Healthy Herbs](#)

Traditional Ethnic Herbal Practices

Traditional Ethnic Herbal Practices

More Categories

[Amer Indian Herbs \(24\)](#)

[Ayurvedic Herbalism \(3\)](#)

[chinese \(22\)](#)

[Shamanism \(9\)](#)

[back to top](#)

You are here: [About](#)>[Health & Fitness](#)>[Healthy Herbs](#)



[Home](#)

[Essentials](#)

[A - Z Encyclopedia](#)[Submit A Feature Article](#)[Aromatherapy](#) [Free Herb Graphics](#)[Submit a Recipe!](#)

[Browse Categories](#)

[Basics For Beginners](#)[Find A Condition Or Symptom](#)[Herb Profiles / Monographs](#)[Consumer Safety / Toxicolog](#)[Aromatherapy](#)[Preparations And Recipes](#)[Herbal Schools](#)[Homeopathy](#)[Home And Garden](#)[Flower Essences](#)[Research](#)[Family And Pets](#)[Wild Herbs](#)[Traditional Ethnic](#)[Popular Herbs](#)

[Buyer's Guide](#)

[Before You Buy](#)[Top Picks](#)[Top 3 Essential Oil Brands](#)[Topical Pain Relief Products](#)[Product Reviews](#)

[Articles](#)

[Forums](#)

[Help](#)

Search

[Healthy Herbs](#)

Popular Herbs

Popular Herbs

More Categories

[Garlic \(2\)](#)

[Ginkgo \(2\)](#)

[Ginseng \(2\)](#)

[St. John's Wort \(3\)](#)

Stay Current

Subscribe to the **About** Healthy Herbs newsletter.

[Topic Index](#) |

 [email to a friend](#)  font size

[Our Story](#) | [Be a Guide](#) | [Advertising Info](#) | [Investor Relations](#) | [Work at About](#) | [Help](#)

©2004 About, Inc. All rights reserved. A PRIMEDIA Company.

[User Agreement](#) | [Privacy Policy](#) | [Kids' Privacy Policy](#)



[back to top](#)

You are here: [About](#)>[Health & Fitness](#)>[Healthy Herbs](#)



[Home](#)

[Essentials](#)

[A - Z Encyclopedia](#)[Submit A Feature Article](#)[Aromatherapy Free Herb Graphics](#)[Submit a Recipe!](#)

[Browse Categories](#)

[Basics For Beginners](#)[Find A Condition Or Symptom](#)[Herb Profiles / Monographs](#)[Consumer Safety / Toxicolog](#)[Aromatherapy](#)[Preparations And Recipes](#)[Herbal Schools](#)[Homeopathy](#)[Home And Garden](#)[Flower Essences](#)[Research](#)[Family And Pets](#)[Wild Herbs](#)[Traditional Ethnic](#)[Popular Herbs](#)

[Buyer's Guide](#)

[Before You Buy](#)[Top Picks](#)[Top 3 Essential Oil Brands](#)[Topical Pain Relief Products](#)[Product Reviews](#)

[Articles](#)

[Forums](#)

[Help](#)

Search

[Healthy Herbs](#)

Before You Buy
Guide picks

Your guide to shopping for herb and essential oil products.

[Essential Oils](#)

Essential oils can vary greatly in quality and in price. Information and tips on what to look for.

[Pain Relief Products](#)

Natural pain relief products from topical analgesics to teas and capsules.

Stay Current

Subscribe to the **About** Healthy Herbs

newsletter.

[Topic Index](#) |



[email to a friend](#)



[font size](#)

[Our Story](#) | [Be a Guide](#) | [Advertising Info](#) | [Investor Relations](#) | [Work at About](#) | [Help](#)

©2004 About, Inc. All rights reserved. A PRIMEDIA Company.

[User Agreement](#) | [Privacy Policy](#) | [Kids' Privacy Policy](#)

[back to top](#)

Search
[Healthy Herbs](#)

TopPicks Index

[Top 10 Herbs For Summer](#)

Herbs For Summer

[Top 7 Books](#)

Books On Natural Menopause

[Top 10 Marijuana Books](#)

Books on medicinal marijuana and more.

[Top 7 Natural Weight Loss Books](#)

Natural Weight Loss Books

[Top 10 Native American Indian Herbalism Books](#)

Books on Native American Indian Herbs and Healing

[Top 9 Books for Immune System Alternatives](#)

Books for Immune System Alternatives

[Top 10 Software For Herbalists](#)

Software For Herbalists handy tools for a variety of tasks.

[Top 8 Books on Entheogens](#)

Books on entheogens used for visions and ceremonies.

[Top 9 Books About Basic Herb Gardening For Beginners](#)

Books and resources for basic herb gardening for beginners.

[Top 10 Conventional and Holistic Lice Products](#)

Conventional and Natural lice products.

[Top 7 Ready Made Massage Oils / Lotions](#)

Convenient all ready blended massage oils and lotions for those who do not have the time to make their own.

[Top 7 Common and Exotic Base Oils for Massage](#)

Find common and exotic base oils to create the ultimate home massage oil or lotion.

Most Popular Articles

[Spring Cleansing Herbal Encyclopedia A to Z](#)
[Herb Encyclopedia A to Z](#)
[Horny Goat Weed - Epimedium sagittatum](#)
[Itchy Skin - Dermatitis](#)

What's Hot Now

[Herbal Encyclopedia A to Z](#)
[Spring Cleansing](#)



[Home](#)

[Essentials](#)

[A - Z Encyclopedia](#)[Submit A Feature Article](#)[Aromatherapy](#) [Free Herb Graphics](#)[Submit a Recipe!](#)

[Browse Categories](#)

[Basics For Beginners](#)[Find A Condition Or Symptom](#)[Herb Profiles / Monographs](#)[Consumer Safety / Toxicolog](#)[Aromatherapy](#)[Preparations And Recipes](#)[Herbal Schools](#)[Homeopathy](#)[Home And Garden](#)[Flower Essences](#)[Research](#)[Family And Pets](#)[Wild Herbs](#)[Traditional Ethnic](#)[Popular Herbs](#)

[Buyer's Guide](#)

[Before You Buy](#)[Top Picks](#)[Top 3 Essential Oil Brands](#)[Topical Pain Relief Products](#)[Product Reviews](#)

[Articles](#)

[Forums](#)

[Help](#)

Stay Current

Subscribe to the **About** Healthy Herbs

newsletter.

[Top 7 Massage Mood Enhancers](#)

Great accessories to enhance your home herbal massage.

[Top 6 Books For Women](#)

Herbal and aromatherapy books which target or have significant womens sections.

[Top 9 Summer Foot Care](#)

[Ingredients / Gadgets](#)

Top ingredients and gadgets for making your own refreshing foot care products.

[Top 5 Rejuvenating Products for Summer Feet](#)

Refreshing help for those hot, tired, sticky, over dry summer beaten feet.

[Top 6 Essential Carrier Oils](#)

Carrier oil is the foundation of most aromatherapy uses from massage to cosmetics. These are the top picks for which I use and have replaced all commercial cosmetics with.

[Top 10 Echinacea with Astragalus and Reishi](#)

Top ten herbs everyone should have in their medicine cabinets.

[Top 3 Essential Oil](#)

Essential oil top picks for aromatherapy and therapeutic uses.

[Topic Index](#) |



[email to a friend](#)



font size



[back to top](#)

[Our Story](#) | [Be a Guide](#) | [Advertising Info](#) | [Investor Relations](#) | [Work at About](#) | [Help](#)

©2004 About, Inc. All rights reserved. A PRIMEDIA Company.

[User Agreement](#) | [Privacy Policy](#) | [Kids' Privacy Policy](#)

You are here: [About](#)>[Health & Fitness](#)>[Healthy Herbs](#)



[Home](#)

[Essentials](#)

[A - Z Encyclopedia](#)[Submit A Feature Article](#)[Aromatherapy Free Herb Graphics](#)[Submit a Recipe!](#)

[Browse Categories](#)

[Basics For Beginners](#)[Find A Condition Or Symptom](#)[Herb Profiles / Monographs](#)[Consumer Safety / Toxicolog](#)[Aromatherapy Preparations And Recipes](#)[Herbal Schools](#)[Homeopathy](#)[Home And Garden](#)[Flower Essences](#)[Research](#)[Family And Pets](#)[Wild Herbs](#)[Traditional Ethnic](#)[Popular Herbs](#)

[Buyer's Guide](#)

[Before You Buy](#)[Top Picks](#)[Top 3 Essential Oil Brands](#)[Topical Pain Relief Products](#)[Product Reviews](#)

[Articles](#)

[Forums](#)

[Help](#)

Stay Current

Subscribe to the **About** Healthy Herbs newsletter.

Search

[Healthy Herbs](#)

Guide Picks - Top 3 Essential Oils

If you are going to pay top dollar for essential oils, why not get the best? Here are my top picks for quality.

1) [Oshadhi Essential Oils](#)



By far my favorite oil for quality. I like the care and hand crafting from farm to store shelf that is practiced.

[Read Review](#)

[COMPARE PRICES](#)

2) [Aroma Terra Essential Oils](#)



My second favorite brand of essential oils. It is a top quality product using CO2 extraction. Cost is comparative to Oshadhi. Aroma Vera does not have the history or hand crafted quality that Oshadhi has. They do offer custom blending and a wonderful selection of personal products.

[Read Review](#)

[Manufacturer's Page](#)

3) [Frontier Natural Products Co-op](#)

Frontier does not manufacture their oil. They are a co-op so they purchase it from other oil producers and require quality standards. They also offer certified organic oils. The benefit of this is price. Oil prices are a little easier on the pocket book. Frontier oils are easily found in many health food stores. They also offer Aura Cacia brand essential oils.



[Read Review](#)

Most Popular Articles

[Spring Cleansing Herbal Encyclopedia A to Z](#)
[Herb Encyclopedia A to Z](#)
[Horny Goat Weed - Epimedium sagittatum](#)
[Itchy Skin - Dermatitis](#)

What's Hot Now

[Herbal Encyclopedia A to Z](#)
[Spring Cleansing](#)

[Important product disclaimer information about this About site.](#)



From [Juli Kight](#),
Your Guide to [Healthy Herbs](#).

RATE THIS ARTICLE

Would you recommend this article?

Not at all

Definitely

1 2 3 4 5

[Topic Index](#) |



[email to a friend](#)



font size



[back to top](#)

[Our Story](#) | [Be a Guide](#) | [Advertising Info](#) | [Investor Relations](#) | [Work at About](#) | [Help](#)

©2004 About, Inc. All rights reserved. A PRIMEDIA Company.

[User Agreement](#) | [Privacy Policy](#) | [Kids' Privacy Policy](#)

You are here: [About](#)>[Health & Fitness](#)>[Healthy Herbs](#)



[Home](#)

[Essentials](#)

[A - Z Encyclopedia](#)[Submit A Feature](#)

[Article](#)[Aromatherapy](#) [Free Herb Graphics](#)[Submit a Recipe!](#)

[Browse Categories](#)

[Basics For Beginners](#)[Find A Condition Or Symptom](#)[Herb Profiles / Monographs](#)[Consumer Safety /](#)

[Toxicolog](#)[Aromatherapy](#)[Preparations And Recipes](#)[Herbal Schools](#)[Homeopathy](#)[Home And Garden](#)[Flower](#)

[Essences](#)[Research](#)[Family And Pets](#)[Wild Herbs](#)[Traditional Ethnic](#)[Popular Herbs](#)

[Buyer's Guide](#)

[Before You Buy](#)[Top Picks](#)[Top 3 Essential Oil](#)

[Brands](#)[Topical Pain Relief Products](#)[Product Reviews](#)

[Articles](#)

[Forums](#)

[Help](#)

Stay Current

Subscribe to the **About** Healthy Herbs newsletter.

[Topic Index](#) |

[email to a friend](#) font size

[Our Story](#) | [Be a Guide](#) | [Advertising Info](#) | [Investor Relations](#) | [Work at About](#) | [Help](#)

©2004 About, Inc. All rights reserved. A PRIMEDIA Company.

[User Agreement](#) | [Privacy Policy](#) | [Kids' Privacy Policy](#)

Search

[Healthy Herbs](#)

Guide Picks - Top 3 Topical Pain Relief Products

My favorite topical pain relief products to use either alone or in an alternating therapy with each other.

1) [Acupress™](#)

Unique and extremely effective product using acupressure points for and application guide.

[Read Review](#) [Manufacturer's Page](#)

2) [BIOFREEZE®](#)

A holly based product delivering effective cryogenic therapy to painful muscles and joints.

[Read Review](#) [Manufacturer's Page](#)

3) [Narayan Oil](#)

Mildly heating Ayurvedic oil therapy for pain from arthritis, muscle and joint stress and injuries, sinus and headache discomfort.

[Read Review](#)

[Important product disclaimer information about this About site.](#)



From [Juli Kight](#),
Your Guide to [Healthy Herbs](#).

RATE THIS ARTICLE

Would you recommend this article?

Not at all Definitely

1 2 3 4 5

Most Popular Articles

[Spring Cleansing Herbal](#)

[Encyclopedia A to Z](#)[Herb](#)

[Encyclopedia A to Z](#)[Horny Goat](#)

[Weed -](#)

[Epimedium](#)

[sagittatum](#)[Itchy](#)

[Skin - Dermatitis](#)

What's Hot Now

[Herbal](#)

[Encyclopedia A](#)

[to Z](#)[Spring](#)

[Cleansing](#)



You are here: [About](#)>[Health & Fitness](#)>[Healthy Herbs](#)



[Home](#)

[Essentials](#)

[A - Z Encyclopedia](#)[Submit A Feature Article](#)[Aromatherapy Free Herb Graphics](#)[Submit a Recipe!](#)

[Browse Categories](#)

[Basics For Beginners](#)[Find A Condition Or Symptom](#)[Herb Profiles / Monographs](#)[Consumer Safety /](#)

[Toxicolog](#)[Aromatherapy](#)[Preparations And Recipes](#)[Herbal Schools](#)[Homeopathy](#)[Home And Garden](#)[Flower](#)

[Essences](#)[Research](#)[Family And Pets](#)[Wild Herbs](#)[Traditional Ethnic](#)[Popular Herbs](#)

[Buyer's Guide](#)

[Before You Buy](#)[Top Picks](#)[Top 3 Essential Oil Brands](#)[Topical Pain Relief Products](#)[Product Reviews](#)

[Articles](#)

[Forums](#)

[Help](#)

Stay Current

Subscribe to the **About** Healthy Herbs newsletter.

[Topic Index](#) |

 [email to a friend](#)   font size

[Our Story](#) | [Be a Guide](#) | [Advertising Info](#) | [Investor Relations](#) | [Work at About](#) | [Help](#)

©2004 About, Inc. All rights reserved. A PRIMEDIA Company.

[User Agreement](#) | [Privacy Policy](#) | [Kids' Privacy Policy](#)

Search

[Healthy Herbs](#)

GuideReviews Index

[The Way of Herbs by Michael Tierra L.Ac., O.M.D.](#)

The Way of Herbs by Michael Tierra L.Ac., O.M.D.

Most Popular Articles

[Spring Cleansing Herbal Encyclopedia A to Z](#)[Herb Encyclopedia A to Z](#)[Horny Goat Weed - Epimedium sagittatum](#)[Itchy Skin - Dermatitis](#)

What's Hot Now

[Herbal Encyclopedia A to Z](#)[Spring Cleansing](#)

[back to top](#)

[Search](#)
[Healthy Herbs](#)

Articles Index

[Butterfly And Hummingbird Herbs](#)

Butterfly And Hummingbird Herbs

[Grow Medicinal Herbs In Containers](#)

Grow Medicinal Herbs In Containers

[Selecting Herbs For Itchy Skin](#)

Selecting Herbs For Itchy Skin

[Hayfever](#)

Hayfever

[Stinging Nettle \(Urtica dioica\)](#)

Stinging Nettle (Urtica dioica)

[Itchy Skin](#)

Types of dermatitis, causes and remedies.

[Maca \(Lepidium meyenii\)](#)

Maca (Lepidium meyenii)

[Reproductive Hormones And HRT](#)

Reproductive Hormones And HRT

[Soy](#)

Soy

[Black Cohosh \(Cimicifuga racemosa\)](#)

Black Cohosh (Cimicifuga racemosa)

[Planning Your Medicinal Herb Garden Part 1](#)

Planning Your Medicinal Herb Garden Part 1

[First Year Medicinal Garden](#)

First Year Medicinal Garden

[Wildcrafting](#)

Wildcrafting

[Parsley Water](#)

Parsley water for pets and humans for cleansing and stimulating kidney function.

Most Popular Articles

[Spring Cleansing Herbal Encyclopedia A to Z](#)
[Herb Encyclopedia A to Z](#)
[Horny Goat Weed - Epimedium sagittatum](#)
[Itchy Skin - Dermatitis](#)

What's Hot Now

[Herbal Encyclopedia A to Z](#)
[Spring Cleansing](#)



[Home](#)

[Essentials](#)

[A - Z Encyclopedia](#)[Submit A Feature Article](#)[Aromatherapy](#)[Free Herb Graphics](#)[Submit a Recipe!](#)

[Browse Categories](#)

[Basics For Beginners](#)[Find A Condition Or Symptom](#)[Herb Profiles / Monographs](#)[Consumer Safety / Toxicolog](#)[Aromatherapy](#)[Preparations And Recipes](#)[Herbal Schools](#)[Homeopathy](#)[Home And Garden](#)[Flower Essences](#)[Research](#)[Family And Pets](#)[Wild Herbs](#)[Traditional Ethnic](#)[Popular Herbs](#)

[Buyer's Guide](#)

[Before You Buy](#)[Top Picks](#)[Top 3 Essential Oil Brands](#)[Topical Pain Relief Products](#)[Product Reviews](#)

[Articles](#)

[Forums](#)

[Help](#)

Stay Current

Subscribe to the **About** Healthy Herbs

newsletter.

[Heartworms](#)

Heartworms

[Saw Palmetto \(Serenoa repens\)](#)

Saw Palmetto (Serenoa repens)

[Women's Herbs Part 5 -
Pregnancy / Childbirth](#)

Women's Herbs Part 5 -
Pregnancy / Childbirth

[Fending Off The Fleas](#)

Fending Off The Fleas

[Depression Part 1](#)

Depression Part 1

[Making Herbal Soap on a
Budget](#)

Making Herbal Soap on a Budget

[Ephedra - The Final Days](#)

Ephedra - The Final Days

[GINKGO \(Ginkgo biloba\)](#)

GINKGO (Ginkgo biloba)

[Aromatherapy Center](#)

Aromatherapy Center

[Insomnia](#)

Insomnia - Natural remedies to
help you sleep.

[Herbs, Oils and Sun Sensitivity](#)

Herbs, Oils and Sun Sensitivity

[Topic Index](#) |



[email to a friend](#)



font size



[back to top](#)

[Our Story](#) | [Be a Guide](#) | [Advertising Info](#) | [Investor Relations](#) | [Work at About](#) | [Help](#)

©2004 About, Inc. All rights reserved. A PRIMEDIA Company.

[User Agreement](#) | [Privacy Policy](#) | [Kids' Privacy Policy](#)

You are here: [About](#)>[Health & Fitness](#)>[Healthy Herbs](#)



[Home](#)

[Essentials](#)

[A - Z Encyclopedia](#)[Submit A Feature](#)

[Article](#)[Aromatherapy](#) [Free Herb Graphics](#)[Submit a Recipe!](#)

[Browse Categories](#)

[Basics For Beginners](#)[Find A Condition Or Symptom](#)[Herb](#)

[Profiles / Monographs](#)[Consumer Safety /](#)

[Toxicolog](#)[Aromatherapy](#)[Preparations And Recipes](#)[Herbal](#)

[Schools](#)[Homeopathy](#)[Home And Garden](#)[Flower](#)

[Essences](#)[Research](#)[Family And Pets](#)[Wild Herbs](#)[Traditional](#)

[Ethnic](#)[Popular Herbs](#)

[Buyer's Guide](#)

[Before You Buy](#)[Top Picks](#)[Top 3 Essential Oil](#)

[Brands](#)[Topical Pain Relief Products](#)[Product Reviews](#)

[Articles](#)

[Forums](#)

[Help](#)

Stay Current

Subscribe to the **About** Healthy Herbs

newsletter.

[Topic Index](#) |

 [email to a friend](#)  font size

[Our Story](#) | [Be a Guide](#) | [Advertising Info](#) | [Investor Relations](#) | [Work at About](#) | [Help](#)

©2004 About, Inc. All rights reserved. A PRIMEDIA Company.

[User Agreement](#) | [Privacy Policy](#) | [Kids' Privacy Policy](#)

Search

[Healthy Herbs](#)

[Forum](#) [How To's](#) | [F.A.Q.](#) | [User Agreement](#) | [Guidelines](#) | [Support](#)

Member Name: Password:

Please remember my member name and password.

Forgot Password? [Get a hint](#)

Just looking? Click [here](#) for Guest Access.

Not Registered? [Register for FREE!](#)

Welcome to the Herbs For Health Bulletin Board!

Please feel free to post any ideas, interests, projects, experiences or questions you may have related to herbs. Be sure to check out the FAQ's page.

Most Popular Articles

[Spring Cleansing](#)

[Herbal](#)

[Encyclopedia A to Z](#)[Herb](#)

[Encyclopedia A to Z](#)[Horny Goat](#)

[Weed -](#)

[Epimedium](#)

[sagittatum](#)[Itchy](#)

[Skin - Dermatitis](#)

What's Hot Now

[Herbal](#)

[Encyclopedia A to Z](#)[Spring](#)

[Cleansing](#)



[back to top](#)

You are here: [About](#)>[Health & Fitness](#)>[Healthy Herbs](#)

Search

[Healthy Herbs](#)

- [How do I contact the Guide of a site?](#)
- [How do I unsubscribe from newsletters?](#)
- [How do I update my e-mail address on newsletters?](#)
- [How do I submit my website to About.com search?](#)
- [How can I get permission to reprint information/graphics from About.com?](#)
- [How do I change my membername?](#)
- **Q. How do I contact the Guide of a site?**

A. To contact any Guide on our site, click on the Guide's name located on the top left corner of the particular site. You will then be brought to a page containing their e-mail address or other information that you can use for contact purposes.

[back to top](#)

- **Q. How do I unsubscribe from newsletters?**

A. To unsubscribe from any newsletter, a link is provided at the bottom of the newsletter itself, including instructions on how to be removed. You can also remove yourself from newsletters by visiting: <http://talk.about.com>

[back to top](#)

- **Q. How do I update my e-mail address on newsletters?**

A. To update your e-mail address on any About newsletter, you will need to unsubscribe the old address first, then resubscribe with the new address you wish to use. This can be done by following the instructions at the bottom of the last copy of the newsletter you received or directly from the GuideSite by clicking on Newsletter. You can also remove yourself from newsletters by visiting: <http://talk.about.com>

[back to top](#)

- **Q. How do I submit my website to About.com search?**

A. If you are interested in placing a link on our site, please e-mail the Guide directly. The Guide will then consider your link for inclusion. Please note that requesting a link does not guarantee a listing on any About site. For a complete listing of About Guide Sites, please visit: <http://a-zlist.about.com>.

[back to top](#)

- **Q. How can I get permission to reprint information/graphics from About.com?**

A. In order to get permission, you will need to contact the Guide of the particular site with the following information:

Name of publication or Web Site that wants to reprint.
Name of and complete contact info for individual to which license is being requested.
URL(s) of material on the Guide Site to be reprinted. (3) Max.

Please allow 3-4 business days for your information to be reviewed. Someone will then follow up with further instruction.



[Home](#)

[Essentials](#)

[A - Z Encyclopedia](#)[Submit A Feature Article](#)[Aromatherapy](#) [Free Herb Graphics](#)[Submit a Recipe!](#)

[Browse Categories](#)

[Basics For Beginners](#)[Find A Condition Or Symptom](#)[Herb Profiles / Monographs](#)[Consumer Safety / Toxicolog](#)[Aromatherapy Preparations And Recipes](#)[Herbal Schools](#)[Homeopathy](#)[Home And Garden](#)[Flower Essences](#)[Research](#)[Family And Pets](#)[Wild Herbs](#)[Traditional Ethnic](#)[Popular Herbs](#)

[Buyer's Guide](#)

[Before You Buy](#)[Top Picks](#)[Top 3 Essential Oil Brands](#)[Topical Pain Relief Products](#)[Product Reviews](#)

[Articles](#)

[Forums](#)

[Help](#)

Stay Current

Subscribe to the **About** Healthy Herbs newsletter.

Most Popular Articles

- [Spring Cleansing Herbal Encyclopedia A to Z](#)
- [Herb Encyclopedia A to Z](#)
- [Horny Goat Weed - Epimedium sagittatum](#)
- [Itchy Skin - Dermatitis](#)

What's Hot Now

- [Herbal Encyclopedia A to Z](#)
- [Spring Cleansing](#)

[back to top](#)

● **Q. How do I change my membername?**

A. Once you have created a member account on the About network, the membername assigned cannot be changed. In order to use a different membername, you will need to register again at the [Member Center](#).

[back to top](#)

Help Center

[Contact Customer Care](#)



From [Juli Kight](#),
Your Guide to [Healthy Herbs](#).

RATE THIS ARTICLE

Would you recommend this article?

Not at all Definitely

1 2 3 4 5

[Topic Index](#) |



[email to a friend](#)



font size



[back to top](#)

[Our Story](#) | [Be a Guide](#) | [Advertising Info](#) | [Investor Relations](#) | [Work at About](#) | [Help](#)

©2004 About, Inc. All rights reserved. A PRIMEDIA Company.

[User Agreement](#) | [Privacy Policy](#) | [Kids' Privacy Policy](#)

You are here: [About](#)>[Health & Fitness](#)>[Healthy Herbs](#)



[Home](#)

[Essentials](#)

[A - Z Encyclopedia](#)[Submit A Feature Article](#)[Aromatherapy](#) [Free Herb Graphics](#)[Submit a Recipe!](#)

[Browse Categories](#)

[Basics For Beginners](#)[Find A Condition Or Symptom](#)[Herb Profiles / Monographs](#)[Consumer Safety / Toxicolog](#)[Aromatherapy](#)[Preparations And Recipes](#)[Herbal Schools](#)[Homeopathy](#)[Home And Garden](#)[Flower Essences](#)[Research](#)[Family And Pets](#)[Wild Herbs](#)[Traditional Ethnic](#)[Popular Herbs](#)

[Buyer's Guide](#)

[Before You Buy](#)[Top Picks](#)[Top 3 Essential Oil Brands](#)[Topical Pain Relief Products](#)[Product Reviews](#)

[Articles](#)

[Forums](#)

[Help](#)

Stay Current

Subscribe to the **About** Healthy Herbs newsletter.

[Topic Index](#) |

[email to a friend](#) font size

[Our Story](#) | [Be a Guide](#) | [Advertising Info](#) | [Investor Relations](#) | [Work at About](#) | [Help](#)

©2004 About, Inc. All rights reserved. A PRIMEDIA Company.

[User Agreement](#) | [Privacy Policy](#) | [Kids' Privacy Policy](#)

Search

[Healthy Herbs](#)

April 06, 2004

Herbs for Health Blog Archives

« [April 02, 2004](#) | [Main](#) | [April 08, 2004](#) »

Most Popular Articles

[Spring Cleansing Herbal Encyclopedia A to Z](#)
[Herb Encyclopedia A to Z](#)
[Horny Goat Weed - Epimedium sagittatum](#)
[Itchy Skin - Dermatitis](#)

EPHEDRA BANNED TODAY

As of April 6, 2004, ephedra and supplements containing ephedrine alkaloids are banned and prohibited for sale in the United States. For more information see [FDA Issues Regulation Prohibiting Sale of Dietary Supplements Containing Ephedrine Alkaloids and Reiterates Its Advice That Consumers Stop Using These Products](#). At this time it does not

ban Chinese herbal remedies or tea which are regulated as food.

05:53 AM #

[Display Latest Headlines](#)



[Read Archives](#)

What's Hot Now

[Herbal Encyclopedia A to Z](#)
[Spring Cleansing](#)





[Home](#)

[Essentials](#)

[A - Z Encyclopedia](#)[Submit A Feature Article](#)[Aromatherapy](#) [Free Herb Graphics](#)[Submit a Recipe!](#)

[Browse Categories](#)

[Basics For Beginners](#)[Find A Condition Or Symptom](#)[Herb Profiles / Monographs](#)[Consumer Safety / Toxicolog](#)[Aromatherapy](#)[Preparations And Recipes](#)[Herbal Schools](#)[Homeopathy](#)[Home And Garden](#)[Flower Essences](#)[Research](#)[Family And Pets](#)[Wild Herbs](#)[Traditional Ethnic](#)[Popular Herbs](#)

[Buyer's Guide](#)

[Before You Buy](#)[Top Picks](#)[Top 3 Essential Oil Brands](#)[Topical Pain Relief Products](#)[Product Reviews](#)

[Articles](#)

[Forums](#)

[Help](#)

Stay Current

Subscribe to the **About** Healthy Herbs newsletter.

[Topic Index](#) |

 [email to a friend](#)  font size

[Our Story](#) | [Be a Guide](#) | [Advertising Info](#) | [Investor Relations](#) | [Work at About](#) | [Help](#)

©2004 About, Inc. All rights reserved. A PRIMEDIA Company.

[User Agreement](#) | [Privacy Policy](#) | [Kids' Privacy Policy](#)

Search

[Healthy Herbs](#)

EPHEDRA BANNED TODAY

Herbs for Health Blog
« [Hayfever](#) | [Main](#) | [Healing Spaces With Herbs](#) »

April 06, 2004

EPHEDRA BANNED TODAY

As of April 6, 2004, ephedra and supplements containing ephedrine alkaloids are banned and prohibited for sale in the United States. For more information see [FDA Issues](#)

[Regulation Prohibiting Sale of Dietary Supplements Containing Ephedrine Alkaloids and Reiterates Its Advice That Consumers Stop Using These Products](#). At this time it does not ban Chinese herbal remedies or tea which are regulated as food.

[Email a Friend](#)

[Display Latest Headlines](#) 



[Read Archives](#)

Most Popular Articles

[Spring Cleansing Herbal Encyclopedia A to Z](#)[Herb Encyclopedia A to Z](#)[Herb Encyclopedia A to Z](#)[Horny Goat Weed - Epimedium sagittatum](#)[Itchy Skin - Dermatitis](#)

What's Hot Now

[Herbal Encyclopedia A to Z](#)[Spring Cleansing](#)



[back to top](#)

Search

[Healthy Herbs](#)

[Email to a friend](#)[Print this page](#)

[Newsletters](#)

Suggested Reading

[Allergies](#)[Itchy Skin](#)[Reishi - Anti-allergenic Mushroom](#)

Most Popular Articles

[Spring Cleansing Herbal Encyclopedia A to Z](#)[Herb Encyclopedia A to Z](#)[Horny Goat Weed - Epimedium sagittatum](#)[Itchy Skin - Dermatitis](#)

What's Hot Now

[Herbal Encyclopedia A to Z](#)[Spring Cleansing](#)

Hayfever



From [Juli Kight](#),
Your Guide to [Healthy Herbs](#).

Hayfever

Definition: The acute seasonal form of allergic (pollens (weed, tree, grass etc.)) rhinitis, recognized by sneezing, nasal discharge, nasal obstruction, itching/tearing eyes, and pruritus. Can be present anytime plants are pollinating. Food sensitivities seem to be a contributing factor [1].

Most places in the United States get a break from pollen assaults during the winter months. Here in Central Texas, we are plagued with [Mountain Cedar Allergies](#) which pollinates November through March. Cedar allergies not only carry the classic hayfever symptoms, but can also manifest downright flu symptoms such as sore throat and ears, facial discomfort and lethargy.

Help For Hayfever Sufferers:

Select herbs with the following actions:

Anti-inflammatory, [anti-catarrhals](#), expectorants, anti-spasmodics, astringents, bitters, [adaptogens](#) and anti-histamines.

Herb Suggestions:

[Urtica \(Stinging nettle\)](#)

[Euphrasia officinale](#) (Eyebright)

[Plantago \(Plantain\)](#)

[Solidago virgaurea](#) (Golden rod)

Quercetin (derived from *Sophora Japonicas*) - Anti-inflammatory, inhibits histamine release.

Lemon Balm



[Home](#)

[Essentials](#)

[A - Z Encyclopedia](#)[Submit A Feature Article](#)[Aromatherapy Free Herb Graphics](#)[Submit a Recipe!](#)

[Browse Categories](#)

[Basics For Beginners](#)[Find A Condition Or Symptom](#)[Herb Profiles / Monographs](#)[Consumer Safety /](#)

[Toxicology](#)[Aromatherapy](#)[Preparations And Recipes](#)[Herbal Schools](#)[Homeopathy](#)[Home And Garden](#)[Flower](#)

[Essences](#)[Research](#)[Family And Pets](#)[Wild Herbs](#)[Traditional Ethnic](#)[Popular Herbs](#)

[Buyer's Guide](#)

[Before You Buy](#)[Top Picks](#)[Top 3 Essential Oil Brands](#)[Topical Pain Relief Products](#)[Product Reviews](#)

[Articles](#)

[Forums](#)

[Help](#)

Stay Current

Subscribe to the **About** Healthy Herbs
newsletter.

Aralia racemosa - American Spikenard
Gnaphalium uliginosum (Cudweed) - British Herbal Pharmacopoeia
Hydrastis canadensis (Goldenseal)
Ephedra

Homeopathic Suggestions:

Luffa operculata (Spurge cucumber)
Allium Cepa (red onion) - Burning of the nose, watery red eyes, throat inflammation.
Apis (honey bee) - Facial redness and swelling, burning eyelids.
Arsen Alb - Burning eyes and tears, relentless sneezing, restlessness.
Natrum Muriaticum (sodium chloride) - Dry red eyes.
Pulsatilla (wind flower) - Eye and lid inflammation, itching and burning, thick discharge
Ambrosia - Itchy eyes, sneezing, dull mind.
Nux vomica - Headache, stuffed up with nasal drip, sneezing, irritability.

Other Supporting Suggestions:

Use [essential oils for respiratory symptoms](#) in conjunction with other aids.
Vitamin C - A powerful anti-histamine, helps eliminate histamines from the body.
Zinc - Inhibits histamine activity.
Diet - Reduce dairy and meat intake.

References

[1] IBIS; Integrative Body/Mind Information System; Integrative Medical Arts Group, Inc.; 1992-1999.
[2] [Hayfever](#) - Homeopathic Medical Association.
[Allergies](#) - by Stephen Terrass.
[Hay Fever - Allergic Rhinitis](#) - David L. Hoffmann B.Sc. (Hons), M.N.I.M.H.

RATE THIS ARTICLE

Would you recommend this article?

Not at all Definitely
1 2 3 4 5

[Topic Index](#) |

 [email to a friend](#)  font size

[back to top](#)

[Our Story](#) | [Be a Guide](#) | [Advertising Info](#) | [Investor Relations](#) | [Work at About](#) | [Help](#)

©2004 About, Inc. All rights reserved. A PRIMEDIA Company.

[User Agreement](#) | [Privacy Policy](#) | [Kids' Privacy Policy](#)

You are here: [About](#) > [Health & Fitness](#) > [Healthy Herbs](#)



[Home](#)

[Essentials](#)

[A - Z Encyclopedia](#) [Submit A Feature Article](#) [Aromatherapy](#) [Free Herb Graphics](#) [Submit a Recipe!](#)

[Browse Categories](#)

[Basics For Beginners](#) [Find A Condition Or Symptom](#) [Herb Profiles / Monographs](#) [Consumer Safety / Toxicolog](#) [Aromatherapy](#) [Preparations And Recipes](#) [Herbal Schools](#) [Homeopathy](#) [Home And Garden](#) [Flower Essences](#) [Research](#) [Family And Pets](#) [Wild Herbs](#) [Traditional Ethnic](#) [Popular Herbs](#)

[Buyer's Guide](#)

[Before You Buy](#) [Top Picks](#) [Top 3 Essential Oil Brands](#) [Topical Pain Relief Products](#) [Product Reviews](#)

[Articles](#)

[Forums](#)

[Help](#)

Stay Current

Subscribe to the **About** Healthy Herbs

newsletter.

[Topic Index](#) |

 [email to a friend](#)  font size

[Our Story](#) | [Be a Guide](#) | [Advertising Info](#) | [Investor Relations](#) | [Work at About](#) | [Help](#)

©2004 About, Inc. All rights reserved. A PRIMEDIA Company.

[User Agreement](#) | [Privacy Policy](#) | [Kids' Privacy Policy](#)

Search

[Healthy Herbs](#)

April 02, 2004

Herbs for Health Blog Archives

« [March 31, 2004](#) | [Main](#) | [April 06, 2004](#) »

Most Popular Articles

[Spring Cleansing Herbal Encyclopedia A to Z](#) [Herb Encyclopedia A to Z](#) [Horny Goat Weed - Epimedium sagittatum](#) [Itchy Skin - Dermatitis](#)

What's Hot Now

[Herbal Encyclopedia A to Z](#) [Spring Cleansing](#)

Hayfever

As spring rolls in and temperatures rise, so do the pollin counts! This guide will help you select herbs and offer suggestions to help reduce the symptoms of this [seasonal attack](#).

07:59 AM #

[Display Latest Headlines](#) 



[Read Archives](#)

[back to top](#)

You are here: [About](#)>[Health & Fitness](#)>[Healthy Herbs](#)



[Home](#)

[Essentials](#)

[A - Z Encyclopedia](#)[Submit A Feature Article](#)[Aromatherapy](#)[Free Herb Graphics](#)[Submit a Recipe!](#)

[Browse Categories](#)

[Basics For Beginners](#)[Find A Condition Or Symptom](#)[Herb Profiles / Monographs](#)[Consumer Safety / Toxicolog](#)[Aromatherapy](#)[Preparations And Recipes](#)[Herbal Schools](#)[Homeopathy](#)[Home And Garden](#)[Flower Essences](#)[Research](#)[Family And Pets](#)[Wild Herbs](#)[Traditional Ethnic](#)[Popular Herbs](#)

[Buyer's Guide](#)

[Before You Buy](#)[Top Picks](#)[Top 3 Essential Oil Brands](#)[Topical Pain Relief Products](#)[Product Reviews](#)

[Articles](#)

[Forums](#)

[Help](#)

Stay Current

Subscribe to the **About** Healthy Herbs

newsletter.

[Topic Index](#) |

 [email to a friend](#)  font size

[Our Story](#) | [Be a Guide](#) | [Advertising Info](#) | [Investor Relations](#) | [Work at About](#) | [Help](#)

©2004 About, Inc. All rights reserved. A PRIMEDIA Company.

[User Agreement](#) | [Privacy Policy](#) | [Kids' Privacy Policy](#)

Search

[Healthy Herbs](#)

Hayfever

Herbs for Health Blog

[« Selecting Herbs For Itchy Skin | Main | EPHEDRA BANNED TODAY »](#)

April 02, 2004

Hayfever

As spring rolls in and temperatures rise, so do the pollin counts! This guide will help you select herbs and offer suggestions to help reduce the symptoms of this [seasonal attack](#).

[Email a Friend](#)

[Display Latest Headlines](#) 



[Read Archives](#)

Most Popular Articles

[Spring Cleansing Herbal Encyclopedia A to Z](#)[Herb Encyclopedia A to Z](#)[Horny Goat Weed - Epimedium sagittatum](#)[Itchy Skin - Dermatitis](#)

What's Hot Now

[Herbal Encyclopedia A to Z](#)[Spring Cleansing](#)

[back to top](#)

[Search](#)

[Healthy Herbs](#)

[Email to a friend](#)[Print this page](#)

[Newsletters](#)

Suggested Reading

[Itchy Skin](#)

Most Popular Articles

[Spring Cleansing Herbal Encyclopedia A to Z](#)[Herb Encyclopedia A to Z](#)[Horny Goat Weed - Epimedium sagittatum](#)[Itchy Skin - Dermatitis](#)

What's Hot Now

[Herbal Encyclopedia A to Z](#)[Spring Cleansing](#)

Selecting Herbs For Itchy Skin



From [Juli Kight](#),
Your Guide to [Healthy Herbs](#).

Selecting herbs and essential oils for itchy skin should include both external and internal approaches.

Most itchy skin is an allergic reaction to either an external contaminant or a food reaction (see [Itchy Skin](#) for types of dermatitis.)

Here are some herbs to consider taking:

Alteratives-The "blood cleansers". -

These herbs work slower by cleansing the blood of toxins and should be used long term. They work gradually to "alter" existing conditions which could be aggravating your skin conditions. (See [Alterative Herbs](#).)

Adaptogens-The "stress defenders". -

Stress can definitely aggravate skin conditions. These herbs help your body deal with on-coming environmental, emotional and physical stresses your body encounters on a daily basis. They are also used long term with gentle actions. (See [Adaptogenic Herbs](#).)

For itch relief- Use anti-itch herbs and essential oils as well as anti-inflammatories.

Aloe gel - Can be used as a base for combinations.

Witch hazel

[Carrot seed oil](#)

[Tea tree oil](#)

[Manuka oil](#)

Chickweed

[Colloidal Oats](#)



[Home](#)

[Essentials](#)

[A - Z Encyclopedia](#)[Submit A Feature Article](#)[Aromatherapy Free Herb Graphics](#)[Submit a Recipe!](#)

[Browse Categories](#)

[Basics For Beginners](#)[Find A Condition Or Symptom](#)[Herb Profiles / Monographs](#)[Consumer Safety /](#)

[Toxicolog](#)[Aromatherapy Preparations And Recipes](#)[Herbal Schools](#)[Homeopathy](#)[Home And Garden](#)[Flower](#)

[Essences](#)[Research](#)[Family And Pets](#)[Wild Herbs](#)[Traditional Ethnic](#)[Popular Herbs](#)

[Buyer's Guide](#)

[Before You Buy](#)[Top Picks](#)[Top 3 Essential Oil Brands](#)[Topical Pain Relief Products](#)[Product Reviews](#)

[Articles](#)

[Forums](#)

[Help](#)

Stay Current

Subscribe to the **About** Healthy Herbs

newsletter.

[Rose oils](#) - Itching due to dryness and aging. Evening Primrose Oil - topical/diluted

[Lavender oil](#) - topical/diluted

[Peppermint oil](#) - topical/diluted

Nettle Ointment

[Calendula](#) - [How to make calendula oil](#).

[Chamomile](#) - unless allergic to the ragweed plant family. Also see [Chamomile oils](#).

Hua She Jie Yang Wan (patent) or Tri-snake Itch-Removing Pills Tang Kuei Four C. (Si Wu Tang) plus Xiao Feng San - For chronic eczema.

Base or Carrier oils-

Sweet almond

Jojoba

Olive oil - acute dermatitis

Infused calendula oil - [How to make calendula oil](#).

[Refined coconut oil](#)

Evening primrose oil

Kikui nut oil

References

[Agora](#) - Carrier oils.

IBIS; Integrative Body/Mind Information System; Integrative Medical Arts Group Inc., 1992-1999

[Phytotherapy for atopic dermatitis](#) - Townsend Letter for Doctors and Patients, May, 2003, by Kerry Bone.

RATE THIS ARTICLE

Would you recommend this article?

Not at all

Definitely

1 2 3 4 5

[Topic Index](#) |



[email to a friend](#)



font size

[back to top](#)

[Our Story](#) | [Be a Guide](#) | [Advertising Info](#) | [Investor Relations](#) | [Work at About](#) | [Help](#)

©2004 About, Inc. All rights reserved. A PRIMEDIA Company.

[User Agreement](#) | [Privacy Policy](#) | [Kids' Privacy Policy](#)

You are here: [About](#)>[Health & Fitness](#)>[Healthy Herbs](#)



[Home](#)

[Essentials](#)

[A - Z Encyclopedia](#)[Submit A Feature Article](#)[Aromatherapy](#) [Free Herb Graphics](#)[Submit a Recipe!](#)

[Browse Categories](#)

[Basics For Beginners](#)[Find A Condition Or Symptom](#)[Herb Profiles / Monographs](#)[Consumer Safety / Toxicolog](#)[Aromatherapy](#)[Preparations And Recipes](#)[Herbal Schools](#)[Homeopathy](#)[Home And Garden](#)[Flower Essences](#)[Research](#)[Family And Pets](#)[Wild Herbs](#)[Traditional Ethnic](#)[Popular Herbs](#)

[Buyer's Guide](#)

[Before You Buy](#)[Top Picks](#)[Top 3 Essential Oil Brands](#)[Topical Pain Relief Products](#)[Product Reviews](#)

[Articles](#)

[Forums](#)

[Help](#)

Stay Current

Subscribe to the **About** Healthy Herbs newsletter.

[Topic Index](#) |

 [email to a friend](#)  font size

[Our Story](#) | [Be a Guide](#) | [Advertising Info](#) | [Investor Relations](#) | [Work at About](#) | [Help](#)

©2004 About, Inc. All rights reserved. A PRIMEDIA Company.

[User Agreement](#) | [Privacy Policy](#) | [Kids' Privacy Policy](#)

Search

[Healthy Herbs](#)

March 31, 2004

Herbs for Health Blog Archives **Most Popular Articles**

« [March 29, 2004](#) | [Main](#) | [April 02, 2004](#) »

[Spring Cleansing Herbal Encyclopedia A to Z](#)[Herb Encyclopedia A to Z](#)[Horny Goat Weed - Epimedium sagittatum](#)[Itchy Skin - Dermatitis](#)

Selecting Herbs For Itchy Skin

The best way to relieve itchy skin **What's Hot Now**

it by taking a multi-faceted approach involving long and short term remedies. [This guide](#) [Herbal Encyclopedia A to Z](#)[Spring Cleansing](#)

helps you select the herbs you need by category.

[08:24 AM](#) #

[Display Latest Headlines](#) [XML](#)

 add to 

[Read Archives](#)

[back to top](#)



[Home](#)

[Essentials](#)

[A - Z Encyclopedia](#)[Submit A Feature Article](#)[Aromatherapy](#)[Free Herb Graphics](#)[Submit a Recipe!](#)

[Browse Categories](#)

[Basics For Beginners](#)[Find A Condition Or Symptom](#)[Herb Profiles / Monographs](#)[Consumer Safety / Toxicolog](#)[Aromatherapy](#)[Preparations And Recipes](#)[Herbal Schools](#)[Homeopathy](#)[Home And Garden](#)[Flower Essences](#)[Research](#)[Family And Pets](#)[Wild Herbs](#)[Traditional Ethnic](#)[Popular Herbs](#)

[Buyer's Guide](#)

[Before You Buy](#)[Top Picks](#)[Top 3 Essential Oil Brands](#)[Topical Pain Relief Products](#)[Product Reviews](#)

[Articles](#)

[Forums](#)

[Help](#)

Stay Current

Subscribe to the **About** Healthy Herbs

newsletter.

[Topic Index](#) |

 [email to a friend](#)  font size

[Our Story](#) | [Be a Guide](#) | [Advertising Info](#) | [Investor Relations](#) | [Work at About](#) | [Help](#)

©2004 About, Inc. All rights reserved. A PRIMEDIA Company.

[User Agreement](#) | [Privacy Policy](#) | [Kids' Privacy Policy](#)

Search

[Healthy Herbs](#)

Selecting Herbs For Itchy Skin

Herbs for Health Blog

« [Alteratives And Adaptogens](#) | [Main to Z](#) [Herb Encyclopedia](#) | [Hayfever](#) »

March 31, 2004

Selecting Herbs For Itchy Skin

The best way to relieve itchy skin it by taking a multi-faceted approach involving long and short term remedies. [This guide](#) helps you select the herbs you need by category.

[Email a Friend](#)

[Display Latest Headlines](#) 



[Read Archives](#)

Most Popular Articles

[Spring Cleansing Herbal Encyclopedia A](#)
[A to Z](#)[Horny Goat Weed - Epimedium sagittatum](#)[Itchy Skin - Dermatitis](#)

What's Hot Now

[Herbal Encyclopedia A to Z](#)[Spring Cleansing](#)

[back to top](#)

You are here: [About](#)>[Health & Fitness](#)>[Healthy Herbs](#)

[Search](#)

[Healthy Herbs](#)

[Email to a friend](#)[Print this page](#)

[Newsletters](#)

Suggested Reading

[Alterative Herbs](#)

Most Popular Articles

[Spring Cleansing Herbal Encyclopedia A to Z](#)[Herb Encyclopedia A to Z](#)[Horny Goat Weed - Epimedium sagittatum](#)[Itchy Skin - Dermatitis](#)

What's Hot Now

[Herbal Encyclopedia A to Z](#)[Spring Cleansing](#)



[Home](#)

[Essentials](#)

[A - Z Encyclopedia](#)[Submit A Feature Article](#)[Aromatherapy Free Herb Graphics](#)[Submit a Recipe!](#)

[Browse Categories](#)

[Basics For Beginners](#)[Find A Condition Or Symptom](#)[Herb Profiles / Monographs](#)[Consumer Safety /](#)

[Toxicology](#)[Aromatherapy](#)[Preparations And Recipes](#)[Herbal Schools](#)[Homeopathy](#)[Home And Garden](#)[Flower](#)

[Essences](#)[Research](#)[Family And Pets](#)[Wild Herbs](#)[Traditional Ethnic](#)[Popular Herbs](#)

[Buyer's Guide](#)

[Before You Buy](#)[Top Picks](#)[Top 3 Essential Oil Brands](#)[Topical Pain Relief Products](#)[Product Reviews](#)

[Articles](#)

[Forums](#)

[Help](#)

Stay Current

Subscribe to the **About** Healthy Herbs newsletter.

Glossary



From [Juli Kight](#),
Your Guide to [Healthy Herbs](#).

Definition:

Blood purifiers.

Alteratives change or alter long term conditions through metabolic elimination of toxins.

Commonly used in detox, skin and glandular programs.

Generally used long-term.

Imparts a gradual transition towards good health.

[Alterative Herbs](#)

References

[Glossary](#) - Holistic On-line.

Also Known As: Blood purifiers.

RATE THIS ARTICLE

Would you recommend this article?

Not at all Definitely

1 2 3 4 5

[Topic Index](#) |

[email to a friend](#) font size

[Our Story](#) | [Be a Guide](#) | [Advertising Info](#) | [Investor Relations](#) | [Work at About](#) | [Help](#)

©2004 About, Inc. All rights reserved. A PRIMEDIA Company.

[User Agreement](#) | [Privacy Policy](#) | [Kids' Privacy Policy](#)



[Search](#)

[Healthy Herbs](#)

[Email to a friend](#)[Print this page](#)

[Newsletters](#)

Suggested Reading

[Adaptogenic Herbs](#)

Most Popular Articles

[Spring Cleansing Herbal Encyclopedia A to Z](#)[Herb Encyclopedia A to Z](#)[Horny Goat Weed - Epimedium sagittatum](#)[Itchy Skin - Dermatitis](#)

What's Hot Now

[Herbal Encyclopedia A to Z](#)[Spring Cleansing](#)



[Home](#)

[Essentials](#)

[A - Z Encyclopedia](#)[Submit A Feature Article](#)[Aromatherapy Free Herb Graphics](#)[Submit a Recipe!](#)

[Browse Categories](#)

[Basics For Beginners](#)[Find A Condition Or Symptom](#)[Herb Profiles / Monographs](#)[Consumer Safety /](#)

[Toxicology](#)[Aromatherapy](#)[Preparations And Recipes](#)[Herbal Schools](#)[Homeopathy](#)[Home And Garden](#)[Flower](#)

[Essences](#)[Research](#)[Family And Pets](#)[Wild Herbs](#)[Traditional Ethnic](#)[Popular Herbs](#)

[Buyer's Guide](#)

[Before You Buy](#)[Top Picks](#)[Top 3 Essential Oil Brands](#)[Topical Pain Relief Products](#)[Product Reviews](#)

[Articles](#)

[Forums](#)

[Help](#)

Stay Current

Subscribe to the **About** Healthy Herbs newsletter.

“Adaptogens”

Glossary



From [Juli Kight](#),
Your Guide to [Healthy Herbs](#).

Definition: [Adaptogenic herbs](#) help you adapt to changes in life, environment and may increase stamina and sports performance. They are gaining ground as treatments for stress and fatigue. An important mediator of the stress system.

Consist of two main chemical groups: Terpenoids and aromatic compounds.

In order for an herb to be classed as an adaptogen:

1. It must cause only minimal disorders in the body's physiological functions
2. Must increase body's resistance to adverse influences
3. Must have an overall normalizing effect, improving all kinds of conditions and aggravating none.

These originally were set during Lazarevs studies of a chemical substance called dibazole. His student I.I. Brekhman changed the focus to natural substances.

Adaptogens are split into two categories, primary and secondary. Primary are the well known most studied herbs such as eleuthero, schizandra and reishi. Secondary show some normalizing effects, but have not been studied as much or support the adrenal system.

References

[Adaptogens](#) - Earlier and more recent aspects and concepts on their mode of action (very scientific and detailed).

Also Known As: Whole body tonics

RATE THIS ARTICLE

Would you recommend this article?

Not at all Definitely

1 2 3 4 5

[Topic Index](#) |



[email to a friend](#)



font size



[back to top](#)

[Our Story](#) | [Be a Guide](#) | [Advertising Info](#) | [Investor Relations](#) | [Work at About](#) | [Help](#)

©2004 About, Inc. All rights reserved. A PRIMEDIA Company.

[User Agreement](#) | [Privacy Policy](#) | [Kids' Privacy Policy](#)

You are here: [About](#)>[Health & Fitness](#)>[Healthy Herbs](#)



[Home](#)

[Essentials](#)

[A - Z Encyclopedia](#)[Submit A Feature Article](#)[Aromatherapy](#) [Free Herb Graphics](#)[Submit a Recipe!](#)

[Browse Categories](#)

[Basics For Beginners](#)[Find A Condition Or Symptom](#)[Herb Profiles / Monographs](#)[Consumer Safety / Toxicolog](#)[Aromatherapy](#)[Preparations And Recipes](#)[Herbal Schools](#)[Homeopathy](#)[Home And Garden](#)[Flower Essences](#)[Research](#)[Family And Pets](#)[Wild Herbs](#)[Traditional Ethnic](#)[Popular Herbs](#)

[Buyer's Guide](#)

[Before You Buy](#)[Top Picks](#)[Top 3 Essential Oil Brands](#)[Topical Pain Relief Products](#)[Product Reviews](#)

[Articles](#)

[Forums](#)

[Help](#)

Stay Current

Subscribe to the **About** Healthy Herbs

newsletter.

[Topic Index](#) |

 [email to a friend](#)  font size

[Our Story](#) | [Be a Guide](#) | [Advertising Info](#) | [Investor Relations](#) | [Work at About](#) | [Help](#)

©2004 About, Inc. All rights reserved. A PRIMEDIA Company.

[User Agreement](#) | [Privacy Policy](#) | [Kids' Privacy Policy](#)

Search

[Healthy Herbs](#)

March 29, 2004

Herbs for Health Blog Archives

[« March 21, 2004](#) | [Main](#) | [March 31,](#)

[2004 »](#) [Spring Cleansing](#)

Most Popular Articles

[Herbal Encyclopedia A](#)

[to Z](#)[Herb Encyclopedia](#)

[A to Z](#)[Horny Goat](#)

[Weed - Epimedium](#)

[sagittatum](#)[Itchy Skin -](#)

[Dermatitis](#)

Alteratives And Adaptogens

I used to get these two terms and their uses mixed up. They are herbs with common end goals and can be used together for obtaining good health.

[Alterative](#)

[Adaptogen](#)

11:29 AM #

[Display Latest Headlines](#) [XML](#)



[Read Archives](#)

What's Hot Now

[Herbal Encyclopedia A](#)

[to Z](#)[Spring Cleansing](#)

[back to top](#)



[Home](#)

[Essentials](#)

[A - Z Encyclopedia](#)[Submit A Feature Article](#)[Aromatherapy](#) [Free Herb Graphics](#)[Submit a Recipe!](#)

[Browse Categories](#)

[Basics For Beginners](#)[Find A Condition Or Symptom](#)[Herb Profiles / Monographs](#)[Consumer Safety / Toxicolog](#)[Aromatherapy](#)[Preparations And Recipes](#)[Herbal Schools](#)[Homeopathy](#)[Home And Garden](#)[Flower Essences](#)[Research](#)[Family And Pets](#)[Wild Herbs](#)[Traditional Ethnic](#)[Popular Herbs](#)

[Buyer's Guide](#)

[Before You Buy](#)[Top Picks](#)[Top 3 Essential Oil Brands](#)[Topical Pain Relief Products](#)[Product Reviews](#)

[Articles](#)

[Forums](#)

[Help](#)

Stay Current

Subscribe to the **About** Healthy Herbs newsletter.

[Topic Index](#) |

 [email to a friend](#)  font size

[Our Story](#) | [Be a Guide](#) | [Advertising Info](#) | [Investor Relations](#) | [Work at About](#) | [Help](#)

©2004 About, Inc. All rights reserved. A PRIMEDIA Company.

[User Agreement](#) | [Privacy Policy](#) | [Kids' Privacy Policy](#)

Search

[Healthy Herbs](#)

Alteratives And Adaptogens

Herbs for Health Blog

[« Phytochemicals Against Cancer](#) | [Main](#) | [Selecting Herbs For Itchy Skin »](#)

March 29, 2004

Alteratives And Adaptogens

I used to get these two terms and their uses mixed up. They are herbs with common end goals and can be used together for obtaining good health.

[Alternative](#)

[Adaptogen](#)

[Email a Friend](#)

[Display Latest Headlines](#) 



[Read Archives](#)

Most Popular Articles

[Spring Cleansing Herbal Encyclopedia A to Z](#)[Herb Encyclopedia A to Z](#)[Horny Goat Weed - Epimedium sagittatum](#)[Itchy Skin - Dermatitis](#)

What's Hot Now

[Herbal Encyclopedia A to Z](#)[Spring Cleansing](#)

[back to top](#)

[Search](#)

[Healthy Herbs](#)

[Email to a friend](#)[Print this page](#)

[Newsletters](#)

Suggested Reading

[Carotenoids - Definition](#)

Most Popular Articles

[Spring Cleansing Herbal Encyclopedia A to Z](#)[Herb Encyclopedia A to Z](#)[Horny Goat Weed - Epimedium sagittatum](#)[Itchy Skin - Dermatitis](#)

What's Hot Now

[Herbal Encyclopedia A to Z](#)[Spring Cleansing](#)

Lycopene

Phytochemical



From [Juli Kight](#),
Your Guide to [Healthy Herbs](#).

Description:

Lycopene has been found to be the most powerful antioxidant of the dietary [carotenoids](#). It is basically responsible for the red coloring in some fruit such as tomatoes. It is believed to protect against several cancers, macular degeneration, heart disease and much more (see resources below).

Sources:

What are the best sources? Surprisingly, processed tomato products. Processed products provide a better availability of lycopene to the body which is increased when heated and consumed with oil. If you can not eat tomato products, lycopene can also be found naturally in pink grapefruit, guava, papaya and apricots. Lycopene supplements are also available.

Lycopenes have also been discovered in rosehips [3].

Studies:

Tomato paste has the best absorbency rate of lycopenes into the blood system, nearly four times as much as fresh tomatoes. [1]

Tomato juice contains 50 percent more lycopenes than paste in equivalent weight portions and at least three times more lycopene per gram of edible product than a slice of tomato. The juice was found to be poor in contributing to the blood concentration unless consumed with oil. [1]

Lycopene Content [2], [3] :

Tomato paste - 42.2 mg/100 g

Spaghetti Sauce - 21.9 mg/100 g

Chili Sauce - 19.5 mg/100 g

Ketchup - 15.9 mg/100 g



[Home](#)

[Essentials](#)

[A - Z Encyclopedia](#)[Submit A Feature Article](#)[Aromatherapy Free Herb Graphics](#)[Submit a Recipe!](#)

[Browse Categories](#)

[Basics For Beginners](#)[Find A Condition Or Symptom](#)[Herb Profiles / Monographs](#)[Consumer Safety /](#)

[Toxicolog](#)[Aromatherapy](#)[Preparations And Recipes](#)[Herbal Schools](#)[Homeopathy](#)[Home And Garden](#)[Flower](#)

[Essences](#)[Research](#)[Family And Pets](#)[Wild Herbs](#)[Traditional Ethnic](#)[Popular Herbs](#)

[Buyer's Guide](#)

[Before You Buy](#)[Top Picks](#)[Top 3 Essential Oil Brands](#)[Topical Pain Relief Products](#)[Product Reviews](#)

[Articles](#)

[Forums](#)

[Help](#)

Stay Current

Subscribe to the **About** Healthy Herbs

newsletter.

Tomato juice - 9.5 mg/100 g
Raw tomato - 3 mg per medium tomato

Rosehips - 12.9-35.2 mg/100 g

Research And References:

Research

- [Heart Disease](#) - Asia Pac J Clin Nutr. 2003.
- [Prostate Cancer](#) - Cancer Epidemiol Biomarkers Prev. 2004.
- [Antioxidant Activity](#) - J Eur Acad Dermatol Venereol. 2004.
- [Reduced Cancer Risk?](#) - Integr Cancer Ther. 2002. (review)
- [Prostate Cell Enlargement](#) - J Nutr. 2003.

References

- [1] [Studies](#) - From Helmut Sies and his colleagues at Heinrich Heine University.
- [2] [Lycopene Content](#)
- [3] [Rosehips](#) - New source of lycopene.

RATE THIS ARTICLE

Would you recommend this article?

Not at all Definitely
1 2 3 4 5

[Topic Index](#) |

 [email to a friend](#)  font size

[back to top](#)

[Our Story](#) | [Be a Guide](#) | [Advertising Info](#) | [Investor Relations](#) | [Work at About](#) | [Help](#)

©2004 About, Inc. All rights reserved. A PRIMEDIA Company.

[User Agreement](#) | [Privacy Policy](#) | [Kids' Privacy Policy](#)

[Search](#)

[Healthy Herbs](#)

[Email to a friend](#)[Print this page](#)

[Newsletters](#)

Most Popular Articles

[Spring Cleansing Herbal Encyclopedia A to Z](#)[Herb Encyclopedia A to Z](#)[Horny Goat Weed - Epimedium sagittatum](#)[Itchy Skin - Dermatitis](#)

What's Hot Now

[Herbal Encyclopedia A to Z](#)[Spring Cleansing](#)



[Home](#)

[Essentials](#)

[A - Z Encyclopedia](#)[Submit A Feature Article](#)[Aromatherapy Free Herb Graphics](#)[Submit a Recipe!](#)

[Browse Categories](#)

[Basics For Beginners](#)[Find A Condition Or Symptom](#)[Herb Profiles / Monographs](#)[Consumer Safety /](#)

[Toxicology](#)[Aromatherapy Preparations And Recipes](#)[Herbal Schools](#)[Homeopathy](#)[Home And Garden](#)[Flower](#)

[Essences](#)[Research](#)[Family And Pets](#)[Wild Herbs](#)[Traditional](#)

[Ethnic](#)[Popular Herbs](#)

[Buyer's Guide](#)

[Before You Buy](#)[Top Picks](#)[Top 3 Essential Oil Brands](#)[Topical Pain Relief Products](#)[Product Reviews](#)

[Articles](#)

[Forums](#)

[Help](#)

Stay Current

Subscribe to the **About** Healthy Herbs newsletter.

“Polysaccharides”

Glossary



From [Juli Kight](#),
Your Guide to [Healthy Herbs](#).

Definition: The form in which most natural carbohydrates occur. Starch, glycogen, and cellulose. Non-digestible polysaccharides - Dietary fiber. May lower risk of diseases of the colon. Attenuate blood glucose and insulin levels. Reduces the risk of Type 2 diabetes. Lowers risk of coronary heart disease.

Actions can include:

[Adaptogenic](#)
Immunomodulator
Demulcent
Emollient
Sweetener
Vulnerary
Expectorant
Hypoglycemic

It is believed that the protein bound polysaccharides are responsible for the immunomodulating and anti-cancer activities of medicinal mushrooms.

References

[Food Research Program](#)

[Polysaccharide](#) - 2004 Encyclopædia Britannica, Inc.

Also Known As: Glycans

Common Misspellings: polysaccarides

RATE THIS ARTICLE

Would you recommend this article?

Not at all

Definitely

[Topic Index](#) |



[email to a friend](#)



font size



[back to top](#)

[Our Story](#) | [Be a Guide](#) | [Advertising Info](#) | [Investor Relations](#) | [Work at About](#) | [Help](#)

©2004 About, Inc. All rights reserved. A PRIMEDIA Company.

[User Agreement](#) | [Privacy Policy](#) | [Kids' Privacy Policy](#)

You are here: [About](#)>[Health & Fitness](#)>[Healthy Herbs](#)



[Home](#)

[Essentials](#)

[A - Z Encyclopedia](#)[Submit A Feature Article](#)[Aromatherapy](#)[Free Herb Graphics](#)[Submit a Recipe!](#)

[Browse Categories](#)

[Basics For Beginners](#)[Find A Condition Or Symptom](#)[Herb Profiles / Monographs](#)[Consumer Safety / Toxicolog](#)[Aromatherapy](#)[Preparations And Recipes](#)[Herbal Schools](#)[Homeopathy](#)[Home And Garden](#)[Flower Essences](#)[Research](#)[Family And Pets](#)[Wild Herbs](#)[Traditional Ethnic](#)[Popular Herbs](#)

[Buyer's Guide](#)

[Before You Buy](#)[Top Picks](#)[Top 3 Essential Oil Brands](#)[Topical Pain Relief Products](#)[Product Reviews](#)

[Articles](#)

[Forums](#)

[Help](#)

Stay Current

Subscribe to the **About** Healthy Herbs newsletter.

[Topic Index](#) |

 [email to a friend](#)  font size

[Our Story](#) | [Be a Guide](#) | [Advertising Info](#) | [Investor Relations](#) | [Work at About](#) | [Help](#)

©2004 About, Inc. All rights reserved. A PRIMEDIA Company.

[User Agreement](#) | [Privacy Policy](#) | [Kids' Privacy Policy](#)

Search

[Healthy Herbs](#)

March 21, 2004

Herbs for Health Blog Archives

[« March 20, 2004](#) | [Main](#) | [March 29, 2004](#) »[Spring Cleansing](#)

Phytochemicals Against Cancer

Phytochemicals which are readily available and easy to consume are showing to be preventative against some cancers.

[Lycopene](#) - Updated with a new source found.

[Polysaccharides](#)

01:50 PM #

[Display Latest Headlines](#) 



[Read Archives](#)

Most Popular Articles

[Herbal Encyclopedia](#)

[A to ZHerb](#)

[Encyclopedia A to Z](#)[Horny Goat Weed -](#)

[Epimedium](#)

[sagittatum](#)[Itchy Skin](#)

[- Dermatitis](#)

What's Hot Now

[Herbal Encyclopedia](#)

[A to Z](#)[Spring](#)

[Cleansing](#)

[back to top](#)

You are here: [About](#)>[Health & Fitness](#)>[Healthy Herbs](#)



[Home](#)

[Essentials](#)

[A - Z Encyclopedia](#)[Submit A Feature Article](#)[Aromatherapy Free Herb Graphics](#)[Submit a Recipe!](#)

[Browse Categories](#)

[Basics For Beginners](#)[Find A Condition Or Symptom](#)[Herb Profiles / Monographs](#)[Consumer Safety / Toxicolog](#)[Aromatherapy Preparations And Recipes](#)[Herbal Schools](#)[Homeopathy](#)[Home And Garden](#)[Flower Essences](#)[Research](#)[Family And Pets](#)[Wild Herbs](#)[Traditional Ethnic](#)[Popular Herbs](#)

[Buyer's Guide](#)

[Before You Buy](#)[Top Picks](#)[Top 3 Essential Oil Brands](#)[Topical Pain Relief Products](#)[Product Reviews](#)

[Articles](#)

[Forums](#)

[Help](#)

Stay Current

Subscribe to the **About** Healthy Herbs newsletter.

[Topic Index](#) |

 [email to a friend](#)   font size

[Our Story](#) | [Be a Guide](#) | [Advertising Info](#) | [Investor Relations](#) | [Work at About](#) | [Help](#)

©2004 About, Inc. All rights reserved. A PRIMEDIA Company.

[User Agreement](#) | [Privacy Policy](#) | [Kids' Privacy Policy](#)

Search

[Healthy Herbs](#)

Phytochemicals Against Cancer

Herbs for Health Blog

[« Maitake Mushroom](#) | [Main](#) | [Alteratives And Adaptogens](#) »

March 21, 2004

Phytochemicals Against Cancer

Phytochemicals which are readily available and easy to consume are showing to be preventative against some cancers.

[Lycopene](#) - Updated with a new source found.

[Polysaccharides](#)

[Email a Friend](#)

[Display Latest Headlines](#) 



[Read Archives](#)

Most Popular Articles

[Spring Cleansing](#)

[Herbal](#)

[Encyclopedia A to Z](#)[Herb](#)

[Encyclopedia A to Z](#)[Horny Goat Weed](#)

[- Epimedium](#)

[sagittatum](#)[Itchy](#)

[Skin - Dermatitis](#)

What's Hot Now

[Herbal](#)

[Encyclopedia A to Z](#)

[Spring Cleansing](#)



[back to top](#)

[Search](#)

[Healthy Herbs](#)

[Email to a friend](#)[Print this page](#)

[Newsletters](#)

Most Popular Articles

[Spring Cleansing Herbal Encyclopedia A to Z](#)[Herb Encyclopedia A to Z](#)[Horny Goat Weed - Epimedium sagittatum](#)[Itchy Skin - Dermatitis](#)

What's Hot Now

[Herbal Encyclopedia A to Z](#)[Spring Cleansing](#)

Maitake (Grifola frondosa)

Herb - Mushroom



From [Juli Kight](#),
Your Guide to [Healthy Herbs](#).

Overview: The Maitake mushroom is a highly regarded Japanese mushroom in both the culinary and medicinal world. Wild Maitake have been over harvested in Japan however it can be found in Northern temperate forests of Europe, North America and parts of Asia. Maitakes [unusual appearance](#) resembles a hens tail.

Actions And Properties [1], [2], [3]:

Adaptogen

Tonic

Anti-cancer

Total cholesterol lowering

Reduces tryglyceride levels

Lowers arterial blood pressure

Immunomodulator

Anti - HIV

Anti-hypertension

Anti-obesity

Liver damage - prevention and recovery

Constituents:

Beta-glucan [polysaccharides](#) - These are the most important constituents being researched. They are unique and differ than other mushroom beta-glucans [3].

Uses:

The main focus of maitake today is on it's anti-cancer and immune system capabilities. The best results in cancer studies are shown against breast, lung and liver cancers. It is also used to balance blood cholesterol, sugars and pressure. One promising study showed maitake improved T-cell activity and killed AIDS however much more research needs to be conducted.

Warnings / Safety:

Since Maitake effects blood pressure in animals, persons using medications for diabetes and blood pressure should consult with their physician first. No other warnings have been found at the time of this



[Home](#)

[Essentials](#)

[A - Z Encyclopedia](#)[Submit A Feature Article](#)[Aromatherapy Free](#)[Herb Graphics](#)[Submit a Recipe!](#)

[Browse Categories](#)

[Basics For Beginners](#)[Find A Condition Or Symptom](#)[Herb Profiles /](#)[Monographs](#)[Consumer Safety /](#)

[Toxicolog](#)[Aromatherapy](#)[Preparations And Recipes](#)[Herbal](#)[Schools](#)[Homeopathy](#)[Home And Garden](#)[Flower](#)

[Essences](#)[Research](#)[Family And Pets](#)[Wild Herbs](#)[Traditional](#)[Ethnic](#)[Popular Herbs](#)

[Buyer's Guide](#)

[Before You Buy](#)[Top Picks](#)[Top 3 Essential Oil Brands](#)[Topical Pain](#)[Relief Products](#)[Product Reviews](#)

[Articles](#)

[Forums](#)

[Help](#)

Stay Current

Subscribe to the **About** Healthy Herbs

newsletter.

writing. Use with caution as it is still under investigation.

Research And References: **Research**

[Anti-tumor Effect](#) - Zhong Yao Cai. 2003.

[Cyclooxygenase Inhibitory and Antioxidant Compounds](#) - J Agric Food Chem. 2002.

[Can maitake MD-fraction aid cancer patients?](#) - Altern Med Rev. 2002.

[Antihypertensive and Antidiabetic](#) - Mol Cell Biochem. 2002.

[Anti-tumor Activity](#) -Cancer Lett. 2001.

[Cholesterol-lowering Effects](#) - Exp Biol Med (Maywood). 2001

References

[1] [Cancer Research UK](#) - Medicinal mushrooms and cancer.

[2] [Maitake](#) - A to Z of Health.

[3] [Maitake MD Fraction](#) - A literature review by Mark Mayell.

[Maitake](#) - Gale Encyclopedia of Alternative Medicine.

RATE THIS ARTICLE

Would you recommend this article?

Not at all

Definitely

1 2 3 4 5

[Topic Index](#) |



[email to a friend](#)



font size

About

[back to top](#)

[Our Story](#) | [Be a Guide](#) | [Advertising Info](#) | [Investor Relations](#) | [Work at About](#) | [Help](#)

©2004 About, Inc. All rights reserved. A PRIMEDIA Company.

[User Agreement](#) | [Privacy Policy](#) | [Kids' Privacy Policy](#)

You are here: [About](#)>[Health & Fitness](#)>[Healthy Herbs](#)



[Home](#)

[Essentials](#)

[A - Z Encyclopedia](#)[Submit A Feature Article](#)[Aromatherapy](#)[Free Herb Graphics](#)[Submit a Recipe!](#)

[Browse Categories](#)

[Basics For Beginners](#)[Find A Condition Or Symptom](#)[Herb Profiles / Monographs](#)[Consumer Safety / Toxicolog](#)[Aromatherapy](#)[Preparations And Recipes](#)[Herbal Schools](#)[Homeopathy](#)[Home And Garden](#)[Flower Essences](#)[Research](#)[Family And Pets](#)[Wild Herbs](#)[Traditional Ethnic](#)[Popular Herbs](#)

[Buyer's Guide](#)

[Before You Buy](#)[Top Picks](#)[Top 3 Essential Oil Brands](#)[Topical Pain Relief Products](#)[Product Reviews](#)

[Articles](#)

[Forums](#)

[Help](#)

Stay Current

Subscribe to the **About** Healthy Herbs

newsletter.

[Topic Index](#) |

 [email to a friend](#)  font size

[Our Story](#) | [Be a Guide](#) | [Advertising Info](#) | [Investor Relations](#) | [Work at About](#) | [Help](#)

©2004 About, Inc. All rights reserved. A PRIMEDIA Company.

[User Agreement](#) | [Privacy Policy](#) | [Kids' Privacy Policy](#)

Search

[Healthy Herbs](#)

March 20, 2004

Most Popular Articles

Herbs for Health Blog Archives [Spring Cleansing Herbal Encyclopedia A to Z](#)
[« March 12, 2004](#) | [Main](#) | [March 21, 2004](#) » [Encyclopedia A to Z](#)

[Horny Goat Weed - Epimedium sagittatum](#)
[Itchy Skin - Dermatitis](#)

Maitake Mushroom

[Maitake](#) may be a mushroom for you if you are worried about cancer, cholesterol, blood pressure and diabetes.

05:44 PM #

What's Hot Now

[Herbal Encyclopedia A to Z](#)
[Spring Cleansing](#)

[Display Latest Headlines](#) 



[Read Archives](#)

[back to top](#)

You are here: [About](#)>[Health & Fitness](#)>[Healthy Herbs](#)



[Home](#)

[Essentials](#)

[A - Z Encyclopedia](#)[Submit A Feature Article](#)[Aromatherapy](#) [Free Herb Graphics](#)[Submit a Recipe!](#)

[Browse Categories](#)

[Basics For Beginners](#)[Find A Condition Or Symptom](#)[Herb Profiles / Monographs](#)[Consumer Safety / Toxicolog](#)[Aromatherapy](#)[Preparations And Recipes](#)[Herbal Schools](#)[Homeopathy](#)[Home And Garden](#)[Flower Essences](#)[Research](#)[Family And Pets](#)[Wild Herbs](#)[Traditional Ethnic](#)[Popular Herbs](#)

[Buyer's Guide](#)

[Before You Buy](#)[Top Picks](#)[Top 3 Essential Oil Brands](#)[Topical Pain Relief Products](#)[Product Reviews](#)

[Articles](#)

[Forums](#)

[Help](#)

Stay Current

Subscribe to the **About** Healthy Herbs

newsletter.

[Topic Index](#) |

 [email to a friend](#)  font size

[Our Story](#) | [Be a Guide](#) | [Advertising Info](#) | [Investor Relations](#) | [Work at About](#) | [Help](#)

©2004 About, Inc. All rights reserved. A PRIMEDIA Company.

[User Agreement](#) | [Privacy Policy](#) | [Kids' Privacy Policy](#)

Search

[Healthy Herbs](#)

Maitake Mushroom

Herbs for Health Blog

« [Maca](#) | [Main](#) | [Phytochemicals Against Cancer](#) »

March 20, 2004

Maitake Mushroom

[Maitake](#) may be a mushroom for you if you are worried about cancer, cholesterol, blood pressure and diabetes.

[Email a Friend](#)

[Display Latest Headlines](#) 



[Read Archives](#)

Most Popular Articles

[Spring Cleansing Herbal Encyclopedia A to Z](#)[Herb Encyclopedia A to Z](#)[Horny Goat Weed - Epimedium sagittatum](#)[Itchy Skin - Dermatitis](#)

What's Hot Now

[Herbal Encyclopedia A to Z](#)[Spring Cleansing](#)

[back to top](#)

You are here: [About](#)>[Health & Fitness](#)>[Healthy Herbs](#)

Search

[Healthy Herbs](#)

RSS

What is RSS?

Rich Site Summary (or Really Simple Syndication) is an XML-based format for content distribution. Below, About.com is offering an RSS and JavaScript feed with headlines, descriptions and links back to this GuideSite for the full story. This allows you to easily feature or check out the latest headlines from About.

There are two main ways to take advantage of these feeds.

First, you can use them to feature the latest headlines from About on your Web site. All you have to do is paste a short snippet of JavaScript into the code of your page. Here's how:

A) Simple Version:

1. Cut and paste the following lines of JavaScript into your html page.
2. Optional: You can control the number of links that are displayed on your site by changing the number shown here:
<script>ShowHeadlines(10)</script>

```
<script language="JavaScript" src="http://z.about.com/6/js/b.txt?s=healthyherbs"></script>
<script>ShowHeadlines(10)</script>
```

B) Advanced Version:

For people who want to write their own display html using JavaScript

1. Cut and paste the following block of JavaScript into your html page.
2. Write/Modify the ShowHeadlines Function to customize your display of the data.

```
<script language="JavaScript" src="http://z.about.com/6/js/b.txt?s=healthyherbs"></script>
<script>
function Items(t,u,d){while(d.indexOf("\")!=-1){d=d.replace("\","");}
document.writeln('<a href="'+u+'" title="'+d+'>'+t+'</a><br>');
function ShowHeadlines(c){
var i=0; //counter
var l=this.zIBlgI.length-1; //length of the item array
c=(c)?(c*3)-1:29; //calculate how many links to display[default 10]
if(c&&l>c)l=c; //make sure items to display is less than number of items
var h;
h=('<a href="http://about.com">');
h=('</a><br>')
```

Most Popular Articles

- [Spring Cleansing Herbal Encyclopedia A to ZHerb Encyclopedia A to ZHorny Goat Weed - Epimedium sagittatumItchy](#)



[Home](#)

[Essentials](#)

[A - Z Encyclopedia](#)[Submit A Feature Article](#)[Aromatherapy Free Herb Graphics](#)[Submit a Recipe!](#)

[Browse Categories](#)

[Basics For Beginners](#)[Find A Condition Or Symptom](#)[Herb Profiles / Monographs](#)[Consumer Safety / Toxicology](#)[Aromatherapy Preparations And Recipes](#)[Herbal Schools](#)[Homeopathy](#)[Home And Garden](#)[Flower Essences](#)[Research](#)[Family And Pets](#)[Wild Herbs](#)[Traditional Ethnic](#)[Popular Herbs](#)

[Buyer's Guide](#)

- [Before You Buy Top Picks Top 3 Essential Oil Brands Topical Pain Relief Products Product Reviews](#)
- [Articles](#)
- [Forums](#)
- [Help](#)

Stay Current

Subscribe to the **About** Healthy Herbs newsletter.

```

h+=(' <a href="'+zIBlg[1]+'"'>'+zIBlg[0]+'</a><br>')
h+=('Read the current <a href="http://about.com">About.com</a> Headlines:<br>')
document.write(h);
while(i<l)Items(this.zIBlgI[i++],this.zIBlgI[i++],this.zIBlgI[i++]);
}

ShowHeadlines(7)
</script>

```

- [Skin - Dermatitis](#)
- [What's Hot Now](#)
- [Herbal Encyclopedia A to Z Spring Cleansing](#)

That takes care of easily displaying these feeds on your Web site.

Next, let's move onto another use of RSS, and that's news aggregation.

Using one of the many popular news aggregators (see below for links), you can have the latest headlines from this GuideSite (or any other site with an RSS feed) delivered directly to your desktop. This makes checking out your favorite sites quick and easy.

Name	RDF location	RSS location	Description
Healthy Herbs			Most recent Healthy Herbs Headlines

If you're interested in reading more on RSS, try [What is RSS and How Do You Use It?](#) or [Sharing Your Site with RSS](#) or the [RSS specification](#). About.com is currently using the RSS .91 format.

[Feedster](#) and [Syndic8.com](#) have a large directory of available feeds. There are many newsreader applications which use RSS files. Here are some popular ones:

-  My Yahoo!
- [NewsGator](#) Microsoft Outlook
- [Headline Viewer](#) Windows
- [NetNewsWire](#) MacOS X
- [Amphetadesk](#) Windows, MacOS X and earlier, Linux
- [Bloglines](#) Web-based
- [Radio Userland](#) Windows, MacOS X and earlier (newsreader is part of software)
- and [others](#)

If you decide to syndicate any About sites, we'd appreciate attribution to About.com, either as text ("from About.com") or with this [85 x 31 graphic](#). These feeds are free to use, but we ask that you do not publish the full text of our articles. Please click on the orange XML button above to get the corresponding feed.

Any questions, comments, or concerns? Contact [Customer Care](#)

[Topic Index](#) |

 [email to a friend](#)  font size



[Our Story](#) | [Be a Guide](#) | [Advertising Info](#) | [Investor Relations](#) | [Work at About](#) | [Help](#)

©2004 About, Inc. All rights reserved. A PRIMEDIA Company.

[User Agreement](#) | [Privacy Policy](#) | [Kids' Privacy Policy](#)



Add to My Yahoo!

About Herbs for Health

Herbs for Health

Add this source to the RSS Headlines (BETA) module on your page.

Learn more about: [My Yahoo!](#), [RSS on My Yahoo!](#), [Syndicating your content](#)

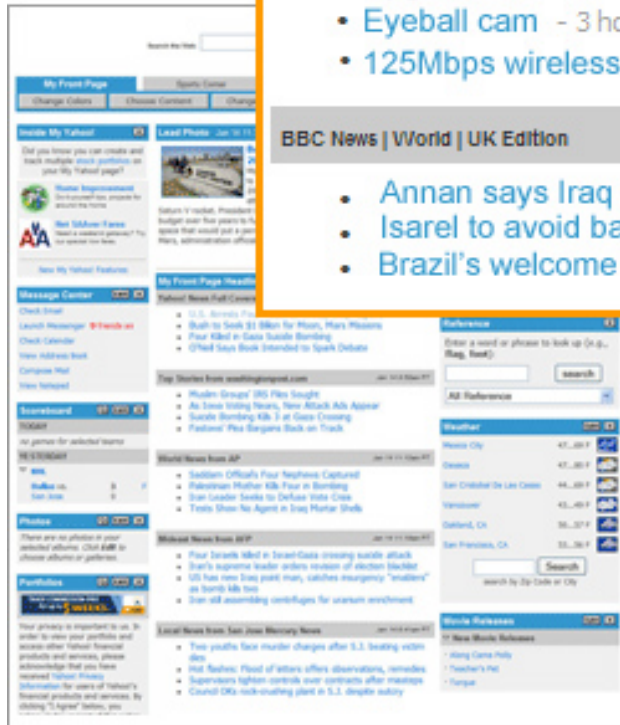

Here's what the source will look like on your My Yahoo! page

Search

[Healthy Herbs](#)

[Herbs for Health Blog](#)

Archives



From [Juli Kight](#),
Your Guide to [Healthy Herbs](#).

[Summers Top Ten](#)

These are my picks for ten herbs you should have available for summer activities and travel.

[Read more...](#) #

[Spring Tonic Herbs](#)

Spring is the perfect time to renew your system with tonic herbs! Tonic Herbs - What do they do? Chickweed - This abundant and pesky [Read](#)

[more...](#) #

[Recipes](#)

Here are two new recipes for you to add to your recipe boxes.

Flax / Peanut Butter Cookies

Super Sea Glow For Skin

Related: Indulging [Read](#)

[more...](#) #

[Healing Spaces With Herbs](#)

Start creating your healing spaces for the gardening season with: Herbal Container Gardens
Butterfly And Hummingbird
Herbs The Fragrant Garden

[Read more...](#) #

[EPHEDRA BANNED TODAY](#)

As of April 6, 2004, ephedra and supplements containing ephedrine alkaloids are banned and prohibited for sale in the United States. For more information see [Read more...](#) #

[Hayfever](#)

As spring rolls in and temperatures rise, so do the pollen counts! This guide will help you select herbs and offer suggestions to help reduce [Read](#)

[more...](#) #

[Selecting Herbs For Itchy Skin](#)

The best way to relieve itchy skin is by taking a multi-faceted approach involving long and short term remedies. This guide helps you select the [Read](#)

[more... #](#)

[Alteratives And Adaptogens](#)

I used to get these two terms and their uses mixed up. They are herbs with common end goals and can be used together for

[Read more... #](#)

[Phytochemicals Against Cancer](#)

Phytochemicals which are readily available and easy to consume are showing to be preventative against some cancers. Lycopene - Updated with a new source found. [Read](#)

[more... #](#)

[Maitake Mushroom](#)

Maitake may be a mushroom for you if you are worried about cancer, cholesterol, blood pressure and diabetes. [Read](#)

[more... #](#)

[Maca](#)

Updated from the previous version written in 1999, this "Peruvian Ginseng" shows promise for fertility and impotence as well as energy, fatigue and debility. This [Read](#)

[more... #](#)

[Healing Mushrooms](#)

Two medicinal mushrooms stand out in front as their historical uses are being proven through research. These outstanding performers may help with allergies and stress [Read](#)

[more... #](#)

[South American Libido](#)

[Enhancers](#)

From the forests of Brazil, these two trees have been used traditionally as effective libido help for both men and women. They also possess other [Read](#)

[more... #](#)

[Psyllium And Cleansing Herbs](#)

Psyllium not only helps you stay regular but helps lower cholesterol, assists with appetite control and neutralizes and removes toxins in the colon. Other herbs [Read more... #](#)

[Read more... #](#)

[Hormones And HRT](#)

Are the new HRT (hormone replacement therapy) warnings

leaving you feeling helpless?
There are alternatives! Many
herbs herbs have been
successfully used for symptoms
of [Read more...](#) #

[Recipes](#)

Two new recipes have been
submitted by readers like you. If
you have a recipe you would like
to share just use the Submit A
[Read more...](#) #

[Grow Your Own Herbs!](#)

I have noticed the new growth
starting to pop up through the
leaves and thats always a
reminder to start planning what
you are going [Read more...](#) #

[Libido Spice Ups](#)

Spice up your love life with
some herbal helps. Wether it is
of physical or emotional hurdles
one of the following suggestions
may be for [Read more...](#) #

[Wildcrafting](#)

Is wildcrafting as simple as just
going out and picking herbs? Do
you need a class or can you learn
yourself? Simple questions to
ask [Read more...](#) #

[Heartworms](#)

As the number of pets infected
with heartworms rises, so do
costs in prevention and
treatment drugs. Are there any
alternatives? What natural
programs if [Read more...](#) #

[Ephedra - The Final Days](#)

If you are counting on the
thermogenic actions of weight
loss and fat burning products,
you are going to have to change
your approach soon. [Read
more...](#) #

[Colloidal Oats](#)

What is colloidal oatmeal?
Something I swear by for itchy
dry skin. I like it so much I tried
it on my terminally itching pet.
[Read more...](#) #

[Need To Warm Up?](#)

You are cold, want something
hot to drink however you are
tired of coffee and boring tea.
Try this quick easy hot drink
right out [Read more...](#) #



[Home](#)

[Essentials](#)

[A - Z Encyclopedia](#)[Submit A Feature Article](#)[Aromatherapy Free Herb Graphics](#)[Submit a Recipe!](#)

[Browse Categories](#)

[Basics For Beginners](#)[Find A Condition Or Symptom](#)[Herb Profiles / Monographs](#)[Consumer Safety / Toxicolog](#)[Aromatherapy](#)[Preparations And Recipes](#)[Herbal Schools](#)[Homeopathy](#)[Home And Garden](#)[Flower Essences](#)[Research](#)[Family And Pets](#)[Wild Herbs](#)[Traditional Ethnic](#)[Popular Herbs](#)

[Buyer's Guide](#)

[Before You Buy](#)[Top Picks](#)[Top 3 Essential Oil Brands](#)[Topical Pain Relief Products](#)[Product Reviews](#)

[Articles](#)

[Forums](#)

[Help](#)

Stay Current

Subscribe to the **About** Healthy Herbs newsletter.

[Dry Winter Skin](#)

Cold dry wind chapping your hide? It is mine! This article features simple ways to combat dry winter skin and has been updated with what [Read more... #](#)

[Indigestion? Muscles Ache?](#)

Two more herbs which are my favorites for indigestion and that achy feeling all over are chamomile and peppermint. You can even combine them for [Read more... #](#)

[Avoid Holiday Stress](#)

Herbs can help you avoid the stress and anxiety of the holidays. Kava has been my favorite for myself and my pets. Mimosa is another [Read more... #](#)

[Holiday Spices](#)

Ancient spices and herbs we commonly use over the holidays besides imparting a wonderful aroma, have many wonderful benefits from warming and clearing to blood [Read more... #](#)

[Nuts To You!](#)

There is no need to shun those holiday nuts. New research suggests even pecans are a healthy food to include in your daily diet. This [Read more... #](#)

[Pumpkins For Health?](#)

You bet! With such a good nutritional profile, why would you want to savor pumpkin only during the holidays? Both Traditional Chinese Medicine and Ayurveda [Read more... #](#)

[Wild Cherry Bark](#)

When that nasty irritaing cough still manages to break through all your prevention efforts, Wild Cherry Bark is a good herb to have on hand. [Read more... #](#)

[Garlic](#)

Still on of the best herbs you can use for prevention (and research is pointing to cancer prevention), this profile is updated with new links [Read more... #](#)

[Ginger](#)

Ginger is one of my absolute

Most Popular Articles

[Spring Cleansing Herbal Encyclopedia A to Z](#)[Herb Encyclopedia A to Z](#)[Horny Goat Weed - Epimedium sagittatum](#)[Itchy Skin - Dermatitis](#)

What's Hot Now

[Herbal Encyclopedia A to Z](#)[Spring Cleansing](#)

favorite herbs to keep on hand during the colder months. Not only is it warming, it comforts the stomach [Read more...](#) #

[Pumpkin Seeds](#)

Don't throw out those pumpkin seeds! They are packed with nutrients and you can easily roast them for a healthy snack. [Read more...](#) #

[Herb Profile - Hyacinth Bean](#)

Even if you never use the beans, Hyacinth bean (Dolichoris Lablab (Bai Bian Dou)) is an impressive heat loving vine to add to your herb [Read more...](#) #

[Reader Q&A - Bellis Perennis](#)

A reader asks about using Daisy (Bellis perennis) for her child's croup. Find out what other ailments this commonly used herb is used for. [Read more...](#) #

[Helpful How To's For Cold Season](#)

Great recipes have been submitted for combatting the upcoming cold and flu season. Get prepared and stock up on these herbs ahead of time. Cold [Read more...](#) #

[Reader Q & A - Bitters](#)

A reader asks about bitters and digestion. Recipes on making your own have been included. [Read more...](#) #

[Acne Helps](#)

Acne can hit any one at any time whether it is due to stress, seasons changing, environmental change, cosmetics, diet or even a combination of [Read more...](#) #

[Eurycoma Longifolia](#)

Eurycoma Longifolia is yet another herb with strong traditional use as an aphrodisiac for men AND women as well as possible anti-cancer, anti-malarial and other [Read more...](#) #

[New Free Herbal Gift Tags](#)

New free gift tags have been designed for your personal use. The older tags have been updated to a newer, easy to print format. These [Read more...](#) #

[Cnidium Monnieri](#)

The Chinese herb Cnidium Monnieri traditionally used for skin ailments shows promise as an aid for male sexual dysfunction. [Read more...](#) #

[Essential Oil - Eucalyptus](#)

Stock up with eucalyptus oil and be prepared for the up-coming cold and flu season. Other helpful oils: Manuka Oil Tea Tree Oil [Read more...](#) #

[Essential Oil Profiles](#)

Understanding what the different "notes" mean and how to profile your own essential oils will help you in creating the right blend. [Read more...](#) #

[School Helps](#)

Help your kids make it through another year of school with natural solutions from dealing with head lice to clearing the mind and improving memory. [Read more...](#) #

[Back To School Prevention](#)

Protect your kids early by using herbs as a preventative against common colds and flu. Usnea is a lesser known but powerful herb you can [Read more...](#) #

[Plant / Herb Food - Quinoa](#)

If you like the healthy benefits of barley, check out the "super grain" from the Andes highlands called quinoa, complete with recipe resources and suppliers [Read more...](#) #

[Gotu Kola](#)

Gotu kola is a "brain" herb you may want to look into for mental clarity and memory as well as problems with phlebitis, varicose veins, [Read more...](#) #

[Reader Response](#)

A. Carlton responds to Fractionated Coconut Oil with her uses of solid food grade coconut oil and castor oil. [Read more...](#) #

[Smitten With Smudging](#)

I would smudge every now and then until my recent two week stay in the Colorado mountains. I made my own smudge sticks

out of [Read more... #](#)

[Remember The Simple Things](#)

Sometimes we are so focused on the new products being developed that we forget the simple herbs around us every day. For instance, I had [Read more... #](#)

[Have You Started To Harvest?](#)

In my part of the country, many herbs are ready to harvest either for fresh use for cooking or drying for processing. If my garden [Read more... #](#)

[Display Latest Headlines](#) [XML](#)



[Read Archives](#)

[Topic Index](#) |



[email to a friend](#)



font size



[back to top](#)

[Our Story](#) | [Be a Guide](#) | [Advertising Info](#) | [Investor Relations](#) | [Work at About](#) | [Help](#)

©2004 About, Inc. All rights reserved. A PRIMEDIA Company.

[User Agreement](#) | [Privacy Policy](#) | [Kids' Privacy Policy](#)

[Search](#)

[Healthy Herbs](#)

[Email to a friend](#)[Print this page](#)

[Newsletters](#)

Most Popular Articles

[Spring Cleansing Herbal Encyclopedia A to Z](#)[Herb Encyclopedia A to Z](#)[Horny Goat Weed - Epimedium sagittatum](#)[Itchy Skin - Dermatitis](#)

What's Hot Now

[Herbal Encyclopedia A to Z](#)[Spring Cleansing](#)



[Home](#)

[Essentials](#)

[A - Z Encyclopedia](#)[Submit A Feature Article](#)[Aromatherapy Free Herb Graphics](#)[Submit a Recipe!](#)

[Browse Categories](#)

[Basics For Beginners](#)[Find A Condition Or Symptom](#)[Herb Profiles / Monographs](#)[Consumer Safety / Toxicology](#)[Aromatherapy Preparations And Recipes](#)[Herbal Schools](#)[Homeopathy](#)[Home And Garden](#)[Flower Essences](#)[Research](#)[Family And Pets](#)[Wild Herbs](#)[Traditional Ethnic](#)[Popular Herbs](#)

[Buyer's Guide](#)

[Before You Buy](#)[Top Picks](#)[Top 3 Essential Oil Brands](#)[Topical Pain Relief Products](#)[Product Reviews](#)

[Articles](#)

[Forums](#)

[Help](#)

Stay Current

Subscribe to the **About** Healthy Herbs

newsletter.

Horny Goat Weed - Epimedium sagittatum



From [Juli Kight](#),
Your Guide to [Healthy Herbs](#).

The mechanism of how horny goat weed works for increasing sexual desire is still unknown at the time of this writing. It is believed that horny goat weed may be able to restore levels of testosterone and thyroid hormones. The herb has been traditionally used for liver and kidney tonification as well as sexual dysfunction. It has improved the life of chronic renal failure patients in a Chinese study. It is found in formulas for psychological and physical impotence.

Common Name - Horny Goat Weed

Scientific / Latin Name - Epimedium Sagittatum

Pin Yin Name - Yin Yang Huo

Parts Used - aerial parts harvested in spring and autumn.

Actions and Uses - Libido enhancement, anti-fatigue, adaptogen,

Thermal Qualities - Warm

Taste - Pungent, sweet

Chinese Uses - Yang tonic for yang deficiency

Resources and Information

[Supplement Watch](#) - Article stating theory and scientific support.

[Epimedium spp.](#) - Clinical trials, case studies, pharmacology.

[Horny Goat Weed \[link\]- by Ray Sahelian, M.D.,](#)

[link](#)

[url=http://www.healthlink.com.au/nat%5Flib/htm%2Ddata/htm%2Dherb/bhp931.htm](http://www.healthlink.com.au/nat%5Flib/htm%2Ddata/htm%2Dherb/bhp931.htm)Herba

[Epimedii](#) - Monograph

RATE THIS ARTICLE

Would you recommend this article?

Not at all Definitely

1 2 3 4 5

[Topic Index](#) |

[email to a friend](#) [font size](#)

[back to top](#)

[Our Story](#) | [Be a Guide](#) | [Advertising Info](#) | [Investor Relations](#) | [Work at About](#) | [Help](#)

Horny Goat Weed - Epimedium sagittatum

©2004 About, Inc. All rights reserved. A PRIMEDIA Company.

[User Agreement](#) | [Privacy Policy](#) | [Kids' Privacy Policy](#)

Search

[Healthy Herbs](#)

[Email to a friend](#)[Print this page](#)

[Newsletters](#)

Most Popular Articles

[Spring Cleansing Herbal Encyclopedia A to Z](#)[Herb Encyclopedia A to Z](#)[Horny Goat Weed - Epimedium sagittatum](#)[Itchy Skin - Dermatitis](#)

What's Hot Now

[Herbal Encyclopedia A to Z](#)[Spring Cleansing](#)



[Home](#)

[Essentials](#)

[A - Z Encyclopedia](#)[Submit A Feature Article](#)[Aromatherapy Free Herb Graphics](#)[Submit a Recipe!](#)

[Browse Categories](#)

[Basics For Beginners](#)[Find A Condition Or Symptom](#)[Herb Profiles / Monographs](#)[Consumer Safety /](#)

[Toxicolog](#)[Aromatherapy](#)[Preparations And Recipes](#)[Herbal Schools](#)[Homeopathy](#)[Home And Garden](#)[Flower](#)

[Essences](#)[Research](#)[Family And Pets](#)[Wild Herbs](#)[Traditional Ethnic](#)[Popular Herbs](#)

[Buyer's Guide](#)

[Before You Buy](#)[Top Picks](#)[Top 3 Essential Oil Brands](#)[Topical Pain Relief Products](#)[Product Reviews](#)

[Articles](#)

[Forums](#)

[Help](#)

Stay Current

Subscribe to the **About** Healthy Herbs newsletter.

Itchy Skin



From [Juli Kight](#),
Your Guide to [Healthy Herbs](#).

If you are like me, the summer season can bring out a malady of itchy skin problems ranging from contact dermatitis to allergic reactions and poison ivy. many times the heat, sun and sweat of summer can aggravate conditions. Dermatitis means skin inflammation and there are several types which encompass a wide range of ailments.

Types of Dermatitis

Contact Dermatitis - Caused by exposure to an irritant which results in mild rash which may or may not itch limited to an area of skin. The most common dermatitis which is normally a mild allergic reaction to plants, fruits, vegetables, cosmetic ingredients, detergents, fabric chemicals and some soaps.

Atopic (eczema) Dermatitis - Chronic itching, scaling, swelling or blistering of the skin. It tends to be genetic and can be caused by allergies, asthma and stress.

Nummular Dermatitis - Common in people 55 or older who live in dry environments, take very hot showers or have dry skin. Red itchy patches of weeping, scaling or encrusted skin. This condition can be aggravated by stress.

Seborrheic Dermatitis - Usually on the scalp and other hairy parts of the body as well as the face and genitals. Yellowish or reddish greasy scaling associated with over production or blockage of the oil glands. It can be aggravated by stress.

Stasis Dermatitis - Skin irritation and unhealthy growth around ankles which is caused by poor circulation.

Page 2 discusses the first step of relieving the discomfort and itching. Page 3 will be added next week focusing deeper on the root causes and prevention of reoccurrences.

- [1](#)
- [2](#)
- [3](#)

- [4](#)
- [Next](#)

RATE THIS ARTICLE

Would you recommend this article?

Not at all Definitely
1 2 3 4 5

[Topic Index](#) |



[email to a friend](#)



font size



[back to top](#)

[Our Story](#) | [Be a Guide](#) | [Advertising Info](#) | [Investor Relations](#) | [Work at About](#) | [Help](#)

©2004 About, Inc. All rights reserved. A PRIMEDIA Company.

[User Agreement](#) | [Privacy Policy](#) | [Kids' Privacy Policy](#)



[TypePad](#) is our simple weblog service based on the Movable Type engine. [Sign up](#) and start a full-featured weblog in minutes.

■ Getting Started

[Download Movable Type Version 2.661](#)

[Donate](#)

[Donor List](#)

[Request an installation](#)

[Commercial Users](#)

■ About

[Frequently Asked Questions](#)

[Features](#)

[Requirements](#)

[Legal](#)

[Screenshots](#)

[Spotlight Sites](#)

[Testimonials](#)

[About Six Apart](#)

■ For Current Users

[Documentation](#)

[Support Forum](#)

[Default Templates](#)

[Default Styles](#)

■ Resources

[TrackBack Weblog](#)

[Localization Weblog](#)

[External Resources](#)

■ Get In Touch

[Contact Us](#)

[Join Our Mailing List](#)

[Download](#)[Support](#)[Forum](#)[Donate](#)[FAQ](#)

What is Movable Type ?

Movable Type is [Six Apart's](#) powerful, customizable publishing system which installs on web servers to enable individuals or organizations to manage and update weblogs, journals, and frequently-updated website content.

[More Information...](#)

[News Archive](#)

Movable Type 3.0 Beta Testing
04.17.2004

We'll be starting the Movable Type 3.0 public beta test next week, the week of April 19. It's taken longer to get to this public beta because we made the decision to extend the alpha process to catch as many bugs as possible before introducing MT3b to the general public.

The alpha testing started about one month ago on March 17, 2004. As anticipated, the alpha uncovered a number of issues that are now fixed, and we thank our alpha testers for their hard work in testing out the software.

If you had applied to be part of the alpha and we missed you, we apologize. As a result of the kinks we encountered during the alpha tester selection process, we've made improvements to the way we'll be handling notifications and tester involvement.

We now have the opportunity to let a larger number of testers in for a beta phase of testing, to test out more platforms and configurations. In addition to the larger number of testers, for the beta we'll be removing the restriction that the software must be installed on a non-public site.

The beta will be run in phases, so as not to introduce any beta-level bugs into a wide audience of people at one time. This means that we will gradually increase the number of people participating each day. All who

Spotlight Sites

[Apartment](#)

[Therapy](#)

[Dave Barry Blog](#)

[Archive](#)

Recently Updated

[Vox](#)

[***Dave Does the Blog](#)

[e-Claire](#)

[Geekable.com](#)

[What Katie Did](#)

[Wi-Fi](#)

[Networking](#)

[News](#)

[Kristina Wright](#)

[twenty-five seconds of silence](#)

[kegz.net](#)

[Seinfeld Blog](#)

[Free Moby](#)

[David's Log](#)

[Search Engine Guide](#)

[idly.org](#)

[News Feed](#)

submit a completed survey will be allowed to participate in the survey (assuming they provide us with an valid email address). If you don't receive email inviting you to the beta right away, don't worry--you'll be included in the later phases.

Once you're introduced into the beta testing, you will receive an email message notifying you where to download the distribution of Movable Type 3.0b1.

You'll then be able to install the software, provided that you agree to the beta testing license.

We will ask that you report any bugs that you may discover to us using our bug reporting software.

The beta for Movable Type 3.0 will begin during the week of April 19, 2004.

If you'd like to participate, please [fill out this questionnaire to sign-up for beta testing](#).

Posted by Mena at 03:13 PM | [Permalink](#)

More TypeKey Information
03.19.2004

Today, [we've released more information about TypeKey](#), which should serve to answer some of the initial questions potential users may have.

While designed first with comment registration in mind, TypeKey will not be limited to usage in Six Apart products. For developers, we plan to offer documentation on integrating TypeKey authentication into your own applications shortly after the service launches.

Look for more information about TypeKey in the coming weeks at [typekey.com](#).

Posted by Mena at 04:31 PM | [Permalink](#)

Testing Begins & More Info about 3.0
03.16.2004

We're taking our first steps towards the release of Movable Type 3.0. The pre-beta version has just finished its initial two rounds of alpha testing and we're now opening the testing to a larger audience (we've picked 300 random addresses from those who

applied and will be adding more as time progresses).

The testing that we're conducting will not only help ensure a stable final release but will also give us an opportunity to receive feedback on feature implementation from both users and developers.

Starting today, we'll be giving all of our users much more information on what to expect in Movable Type 3.0.

The official 3.0 release will contain a significant change to the existing interface that embraces web standards, usability and localization. This will also be reflected in a new set of default templates that will implement more of the best practices that both Movable Type and TypePad have become known for.

With a suite of comment management features and versatile comment registration--utilizing a centralized authentication service we're calling TypeKey--Movable Type 3.0 will give you more control than ever before over the public face of your website. We've spent a lot of time planning a comment registration system that will fit the needs of different types of webloggers, and we have focused our attention on a system that will encourage registration and *open* communication.

In addition to providing authentication for comment registration, TypeKey's open nature will enable developers to build applications upon the infrastructure, utilizing its authentication hooks. Since TypeKey and comment registration are such a significant addition to Movable Type 3.0, we'll be going into more detail about these features later this week.

In addition, our support for the Atom API and syndication feeds will allow Movable Type users to utilize the richer content model offered by the new format, including the use of clients that communicate through the API.

And for developers who like to get under the hood, we've added many new hooks into the application, allowing plugins more control over data, configuration, and user interface.

COMING UP:

If you haven't been added to the testing list yet, don't worry. We've got lots of you who we want to add to the list once the initial bugs have been worked out, so we can get your valuable feedback without being distracted by minor issues. If you submitted the contact form requesting to be on the beta, keep an eye on your mailbox over the next few weeks.

And stay tuned over the coming days, as we outline some of the other major new areas of improvement in Movable Type 3.0. With the help of our dedicated testers, we're hoping to make this our best version of Movable Type ever.

Posted by Mena at 12:17 AM | [Permalink](#)

Alpha Testing to Begin Soon
01.30.2004

We're starting to coordinate our round of alpha testing for Movable Type 3.0 that will occur prior to the public beta. If you're a Movable Type authority, plugin developer, web standards advocate or just a Movable Type user with an active commenting community and want to be involved in this round, please drop us a line using the Movable Type contact form.

In this message, please let us know:

1. What version will you be upgrading from?
2. How many total comments are in your installation? (per weblog)
3. Will you enable comment registration? If no, why not?
4. The URL for your weblog(s)

If you're not comfortable installing alpha software, you may want to wait for the public beta. Our schedule calls for alpha testing to begin in the next two weeks.

Thanks as always for your interest in Movable Type!

Posted by Mena at 09:20 PM | [Permalink](#)

Version 2.66 Released
01.14.2004

In recent weeks, open comment systems, and Movable Type weblogs in particular, have become a target for comment spam and comment flooding (automated scripts that send many comments at a time to a weblog entry).

As a stopgap before we release comment registration in Movable Type 3.0, we've released version 2.66 of Movable Type, which includes some protection against comment flooding. We've included a throttling measure so that comments from the same IP address can only be posted every N seconds, where N is configurable ([documentation on the setting that controls N](#)). We've also added a measure to automatically ban an IP address based on an abnormal number of comments from the same address in a short period of time. Of course, there are no perfect defenses, and if you're truly concerned about the comments on your weblog, the best defense is prevention by closing old comment threads.

Also in 2.66, we've changed the behavior of `<$MTCCommentAuthorLink$>` to use [redirects when linking to URLs given in comments](#). The goal of this is to defeat the PageRank boost given to spammers by posting in the comments on a weblog.

You can download the 2.66 upgrade from the [download page](#) and follow the [standard upgrade instructions](#).

Update: We've released 2.661, an update to 2.66, to fix a problem with invalid XHTML in the comment redirect script, along with using comment IDs instead of URLs to fix an open redirect problem.

Posted by Ben at 01:38 PM | [Permalink](#)

Good Sites for MT Junkies
12.27.2003

Those of you who are hardcore Movable Type users and can't get enough news, tips, and tricks for your blog might want to check out the [Resources and Newsfeeds](#) page from the invaluable [Movable Type Plugin Directory](#). Listing dozens of sites that track the latest developments in the community, along with many individuals who are creating new plugins and

discovering new ideas, there's plenty of inspiration for your own experimentation with Movable Type.

Posted by anildash at 11:02 PM | [Permalink](#)

Movable Type 3.0

12.22.2003

We realize that official news has been scarce over the last 6-9 months. During this time, our company has grown from two people to seven, and we have launched [TypePad](#). Now that we have hired more engineering resources (and we are still [looking for more](#)), we are able to focus again on our Movable Type product line. As mentioned in [this post on the Six Log](#), we're focusing on releasing more personal features in the basic Movable Type package, and concentrating features for businesses, organizations, and large content-driven sites into Movable Type Pro (which, needless to say, has been delayed).

The next version of Movable Type will be version 3.0, a significant and free upgrade. Many oft-requested features will be integrated into this release, including:

- Comment registration. As a response to both comment spam and to the increased usage of Movable Type on large community sites, we'll be adding the option to restrict comments to registered users.
- Improved comment and TrackBack management features.
- New API hooks for plugin developers. Plugins will now be able to hook into many more pieces of Movable Type, including adding callbacks for saving and removing objects, building application methods with integration into the UI, and hooking into the publishing process. This opens up possibilities for plugins to add even more advanced functionality than they're able to do now.
- User interface rebuilt using CSS. We've seen with TypePad that a CSS-based interface gives users very fast application response times, and gives us a flexible interface for making application-wide changes, and we want to give

this same speed and flexibility to Movable Type users.

- Support for the Atom API. We've already added Atom syndication feed support in version 2.65 of Movable Type, and we'll be adding publishing support for the API in 3.0.

In addition to the above, we'll be integrating some features into 3.0 that we're not yet ready to announce, but which we know will be very exciting to MT users. Additionally, for those interested in posting from mobile devices, we expect this to be a welcome release.

Movable Type 3.0 will be a free download and upgrade. We have full-time engineering resources devoted to this new version, and we plan to have a beta release in early Q1 of 2004.

Posted by Ben at 12:05 AM | [Permalink](#)

[XML RSS](#)

Copyright © 2001-2004 [Six Apart](#)



Search

[Healthy Herbs](#)

[A](#) [B](#) [C](#) [D](#) [E](#) [F](#) [G](#) [H](#) [I](#) [J](#) [K](#) [L](#) [M](#) [N](#) [O](#) [P](#) [Q](#) [R](#) [S](#) [T](#) [U](#) [V](#) [W](#) [X](#) [Y](#) [Z](#)

ADD
See [Attention Deficit Disorder](#)

Aliens
See [UFOs / Aliens](#)

[Arabian Horse World Magazine](#)
Part of the About Network

[AIDS / HIV](#)
Your Guide: [Mark Cichocki](#)

[All My Children Fans](#)
Your Guide: [Gloria Dasch](#)

[Archaeology](#)
Your Guide: [K. Kris Hirst](#)

[Abuse / Incest Support](#)
Your Guide: [Douglas Larsen](#)

[Allergies](#)
Your Guide: [Judy Tidwell](#)

[Architecture](#)
Your Guide: [Jackie Craven](#)

Accessories
See [Jewelry / Accessories](#)

[Alternative Medicine](#)
Your Guide: [Cathy Wong, N.D.](#)

[Art History](#)
Your Guide: [Shelley Esaak](#)

[Action Figure Collecting](#)
Your Guide: [Bobbi Boyd](#)

[Alternative Music](#)
Your Guide: [Chad Kempfert](#)

[Arthritis](#)
Your Guide: [Carol Eustice](#)

[Action-Adventure Movies](#)
Your Guide: [Fred Topel](#)

[Alternative Religions](#)
Your Guide: [Jennifer Emick](#)

[Arts / Crafts Business](#)
Your Guide: [William T Lasley](#)

Adolescents
See [Parenting of Adolescents](#)

Alzheimer's Disease
See [Alzheimer's Disease](#)

[Asia for Visitors](#)
Your Guide: [Greg Cruicy](#)

[Adoption](#)
Your Guide: [Carrie Craft](#)

[Alzheimer's Disease](#)
Your Guide: [Christine Kennard](#)

[Asthma](#)
Your Guide: [Apply Now](#)

[Adult / Continuing Education](#)
Your Guide: [Kimeiko Hotta Dover](#)

[Amateur Erotica](#)
Part of the About Network

[Astrology](#)
Your Guide: [Anthony Peña](#)

[Adult Film](#)
Part of the About Network

[American History](#)
Your Guide: [Martin Kelly](#)

Astronomy
See [Space / Astronomy](#)

[Adult Interest](#)
Part of the About Network

Amusement Parks
See [Theme Parks](#)

Atheism
See [Agnosticism / Atheism](#)

[Adult Swinging](#)
Part of the About Network

[Ancient / Classical History](#)
Your Guide: [N.S. Gill](#)

[Atlanta, GA](#)
Your Guide: [Joy Johnston](#)

[Adventure Travel](#)
Your Guide: [Carla Land](#)

[Animals / Wildlife](#)
Your Guide: [Laura Klappenbach](#)

[Attention Deficit Disorder](#)
Your Guide: [Eileen Bailey](#)

[Advertising](#)
Your Guide: [Apryl Duncan](#)

[Animated TV](#)
Your Guide: [Nancy Basile](#)

[Audio Video Interiors Magazine](#)
Part of the About Network

[Africa for Visitors](#)
Your Guide: [Apply Now](#)

[Animation](#)
Your Guide: [Tom Franks](#)

[Austin, TX](#)
Your Guide: [Jacci Howard Bear](#)

[African History](#)
Your Guide: [Alistair Boddy-Evans](#)

[Anime](#)
Your Guide: [Katherine Luther](#)

[Australia / New Zealand for Visitors](#)
Your Guide: [Larry Rivera](#)

[African-American History](#)
Your Guide: [Jessica McElrath](#)

[Antiques](#)
Your Guide: [Pamela Wiggins](#)

[Autism / Pervasive Developmental Disorders](#)
Your Guide: [Adelle Jameson Tilton](#)

[Agnosticism / Atheism](#)
Your Guide: [Austin Cline](#)

[Antivirus Software](#)
Your Guide: [Mary Landesman](#)

[Auto Buying](#)
Your Guide: [Philip Powell](#)

[Agriculture](#)
Your Guide: [Logan Hawkes](#)

Anxiety Disorders
See [Panic / Anxiety Disorders](#)

[Auto Racing](#)
Your Guide: [James Jones](#)

[Air Travel](#)
Your Guide: [Arlene Fleming](#)

[Apartment Living / Rental](#)
Your Guide: [Sandra Clockedile](#)

[Auto Repair](#)
Your Guide: [Vincent Ciulla](#)

[Albany, NY](#)
Your Guide: [Apply Now](#)

Aquariums: Freshwater
See [Freshwater Aquariums](#)

[Auto Sound & Security Magazine](#)
Part of the About Network

[Alcoholism / Substance Abuse](#)
Your Guide: [Buddy T](#)

Aquariums: Saltwater
See [Saltwater Aquariums](#)

[Automobile Magazine](#)
Part of the About Network

[A](#) [B](#) [C](#) [D](#) [E](#) [F](#) [G](#) [H](#) [I](#) [J](#) [K](#) [L](#) [M](#) [N](#) [O](#) [P](#) [Q](#) [R](#) [S](#) [T](#) [U](#) [V](#) [W](#) [X](#) [Y](#) [Z](#)



[email to a friend](#)

font size

[back to top](#)

[Topic Index](#) | [Our Story](#) | [Be a Guide](#) | [Advertising Info](#) | [Investor Relations](#) | [Work at About](#) | [Help](#)

©2004 About, Inc. All rights reserved. A PRIMEDIA Company.

[User Agreement](#) | [Privacy Policy](#) | [Kids' Privacy Policy](#)

You are here: [About](#)>[Health & Fitness](#)>[Healthy Herbs](#)



[Home](#)

[Essentials](#)

[A - Z Encyclopedia](#)[Submit A Feature](#)

[Article](#)[Aromatherapy](#) [Free Herb Graphics](#)[Submit a Recipe!](#)

[Browse Categories](#)

[Basics For Beginners](#)[Find A Condition Or Symptom](#)[Herb Profiles / Monographs](#)[Consumer Safety / Toxicolog](#)[Aromatherapy](#)[Preparations And Recipes](#)[Herbal Schools](#)[Homeopathy](#)[Home And Garden](#)[Flower Essences](#)[Research](#)[Family And Pets](#)[Wild Herbs](#)[Traditional Ethnic](#)[Popular Herbs](#)

[Buyer's Guide](#)

[Before You Buy](#)[Top Picks](#)[Top 3 Essential Oil Brands](#)[Topical Pain Relief Products](#)[Product](#)

[Reviews](#)

[Articles](#)

[Forums](#)

[Help](#)

Search

[Healthy Herbs](#)

Share This Site

You're recommending the following page:

<http://healthyherbs.about.com/>

from Healthy Herbs, an About GuideSite™.

Separate multiple addresses with commas

Recipient's email address:
(required)

Your comments:
(optional)

Your name:
(required)

Your email address:
(required)

Most Popular Articles

- [Spring Cleansing](#)
- [Herbal Encyclopedia](#)
- [A to Z Herb Encyclopedia](#)
- [A to Z Horny Goat Weed - Epimedium sagittatum](#)
- [Itchy Skin - Dermatitis](#)

What's Hot Now

- [Herbal Encyclopedia](#)
- [A to Z Spring Cleansing](#)

Stay Current

Subscribe to the **About** Healthy Herbs newsletter.

[Topic Index](#) |

 [email to a friend](#)  font size



[back to top](#)

[Our Story](#) | [Be a Guide](#) | [Advertising Info](#) | [Investor Relations](#) | [Work at About](#) | [Help](#)

©2004 About, Inc. All rights reserved. A PRIMEDIA Company.

[User Agreement](#) | [Privacy Policy](#) | [Kids' Privacy Policy](#)



Search
[Our Story](#)

Our Story

Welcome to About, the Human Internet, where real people help you get whatever you want from the Web.

Each site in our unique network is run by a professional Guide who is carefully screened and trained by About. Guides build a comprehensive environment around each of their specific topics, including the best new content, relevant links, How-To's, Forums, and answers to just about any question.

The insight and perspective that our Guides bring to each area of interest is what makes the About experience much more enjoyable and interactive than other destinations.

The About network consists of hundreds of Guide sites neatly organized into 23 channels. The sites cover more than 50,000 subjects with over 1 million links to the best resources on the Net and the fastest-growing archive of high quality original content. Topics range from pregnancy to cars, palm pilots to painting, weight loss to video game strategies. No one has greater depth and breadth than About.

A Brief History

In February of 1997, Scott Kurnit and a dedicated team launched The Mining Company, the first information network to integrate the Internet's most productive agent - people. The company quickly grew in size and scale and in 1999 the company was renamed About, to reflect its breadth of content, services and ease of use. Today, About is visited by one in five online users each month, making it one of the most popular destinations on the Net.

Who are the About Guides?

The Guides are the heart and soul of our business.

Coming from all different backgrounds and from all over the world, our Guides know their subjects as well as anyone. Together they have gathered and created hundreds of thousands of pages of content to share with users. Whether they're providing insight and guidance, initiating discussions, moderating chats or writing articles, it is their knowledge, commitment and passion that enable About to provide our millions of regular users with the most human online experience.

About Guides live and work in over 20 countries and celebrate their interests in hundreds of topics. Guides are selected for their ability to provide the most interesting information for users, their commitment to finding the best sites, and for their passion for their subject and the Net.

For more information on becoming an About Guide, click [here](#).

More About Info

[Our Story](#)
[Investor Relations](#)
[Be A Guide](#)
[Advertise](#)
[Work at About](#)
[Contact Info](#)

[Copyright](#)
[User Agreement](#)
[Privacy Policy](#)
[Help](#)



[email to a friend](#) font size

[back to top](#)

[Topic Index](#) | [Our Story](#) | [Be a Guide](#) | [Advertising Info](#) | [Investor Relations](#) | [Work at About](#) | [Help](#)

©2004 About, Inc. All rights reserved. A PRIMEDIA Company.

[User Agreement](#) | [Privacy Policy](#) | [Kids' Privacy Policy](#)



Search
[Be a Guide](#)

Subjects

[Overview](#)
[Advantages](#)
[FAQ](#)
[Available Topics](#)
[Apply Now](#)
[Industry Sites](#)

Overview

Are you ready to become an online leader of a community of people who share your interests? Apply to become an About Guide!

About Guides are fully empowered to do all of these things. Each Guide's mission is to create an easy, intuitive and gratifying experience for people interested in their topic.

Each Guide is carefully screened and trained by About. All Guides must successfully complete the About training program and maintain our high standards in user services and community leadership. Guides write original informative articles, provide the Web's best links for their topics, and give their readers what they need to know. This relationship between Guides and users makes About a dynamic service that truly responds to the needs of anyone who visits.

We ask our Guides to be opinion leaders, sharing your perspective and insight into the topic. What do your users need to know? How can you help them avoid the pitfalls of researching information and purchasing products online?

Our Guides are real people - just like you. They include professionals, educators, students and stay-at-home moms. Our Guides are as diverse as the sites we offer. We believe that one of the key components of our success is the fact that each Guide is a person, as well as an online expert. See for yourself -- every site has a photo of the Guide and a bio.

As diverse as they are, Guides do share a few characteristics:

- A true knowledge of and a passion for their topic
- Commitment to creating informative, "what you need to know" features
- A dedication to building and updating a comprehensive links directory
- The ability to bring their site to life
- Strong writing and editing

More About Info

[Our Story](#)
[Investor Relations](#)
[Be A Guide](#)
[Advertise](#)
[Affiliate Program](#)
[International Info](#)
[Work at About](#)
[In the News](#)
[Contact Info](#)

[Copyright](#)
[User Agreement](#)
[Privacy Policy](#)
[Help](#)

skills

- Basic HTML skills
- A desire to ensure that About remains the best network on the Internet

Do you have what it takes to be a Guide? Don't wait! [Apply here.](#)



[email to a friend](#)



font size

[back to top](#)

[Topic Index](#) | [Our Story](#) | [Be a Guide](#) | [Advertising Info](#) | [Investor Relations](#) | [Work at About](#) | [Help](#)

©2004 About, Inc. All rights reserved. A PRIMEDIA Company.

[User Agreement](#) | [Privacy Policy](#) | [Kids' Privacy Policy](#)



About™ mediakit



- ABOUT²
- AUDIENCE/RESEARCH
- AD OPPORTUNITIES
- AD SPECIFICATIONS
- NEWS + EVENTS
- CONTACT

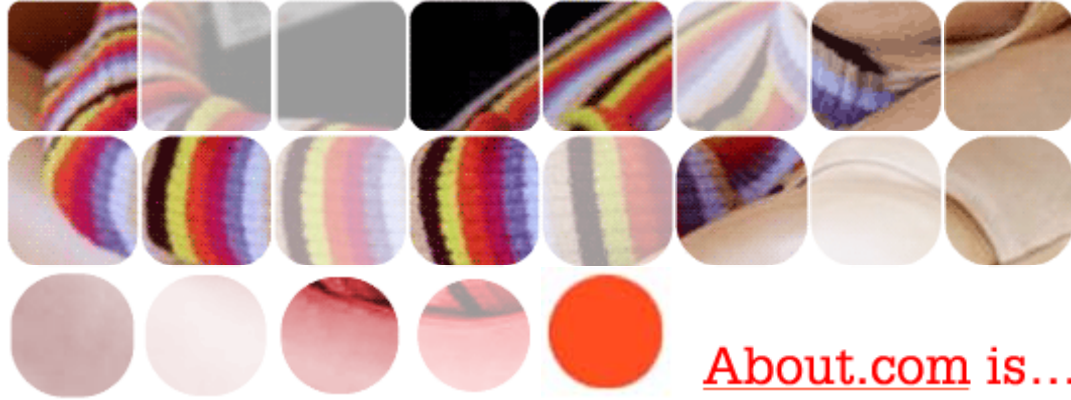

About.com is...

About Spotlight

The New About: 4.0 Relaunch
 A completely redesigned **About** launched on 04.27.04 featuring a unique architecture designed to leverage the power of its content. Check back soon to read more about this exciting advance.

The answer is... **About**

America's **single largest developer of original content** on the web – a vast and vibrant information destination that satisfies the search for **over 21 million unique visitors per month.**



Search
[Our Story](#)

PRIMEDIA/About Investor Relations

About, a PRIMEDIA company (NYSE: PRM), is the leading network where visitors find 700 comprehensive topic areas and is the Internet's most complete targeted environment for marketers. About provides users access to over 1,000,000 links, 50,000 topics and 250,000 articles making About the Internet's largest creator of original content.

For investor relations information, please visit www.primedia.com or contact Jim Magrone, Senior Vice President of Investor Relations at 212.745.0634 or jmagrone@primedia.com.

More About Info

[Our Story](#)
[Investor Relations](#)
[Be A Guide](#)
[Advertise](#)
[Work at About](#)
[Contact Info](#)

[Copyright](#)
[User Agreement](#)
[Privacy Policy](#)
[Help](#)



 [email to a friend](#)  font size

[back to top](#)

[Topic Index](#) | [Our Story](#) | [Be a Guide](#) | [Advertising Info](#) | [Investor Relations](#) | [Work at About](#) | [Help](#)

©2004 About, Inc. All rights reserved. A PRIMEDIA Company.

[User Agreement](#) | [Privacy Policy](#) | [Kids' Privacy Policy](#)



Search
[Jobs](#)

Subjects

[Careers at About](#)
[Internships at About](#)
[Why You Should Join](#)
[Our Team](#)
[Job Expos](#)
[Email Us](#)

Careers at About

At About, we're breaking new ground utilizing the skills and imagination of people like you. If you're seeking a new opportunity and want to breathe new life into your career, apply today! No recruiting agencies please.

Available Jobs

Positions are located in our New York City headquarters unless otherwise noted. We offer an exciting, start-up informal atmosphere with a competitive compensation package including full health/welfare benefits, 401(k) plan and employee stock purchase plan. We are an EEO. Please forward cover letter along with salary requirements and resume to work@about-inc.com and note the position you wish to apply to in the subject line.

[Marketing Positions](#)

[Ad Operations Positions](#)

Marketing Positions

About.com actively recruiting for a Circulation and Audience Marketing Manager to join us in our NYC headquarters. This person will have the opportunity to help drive the strategy of one of the internet's premier web sites. The right person will take charge of driving overall site traffic and audience composition on About.com. The Circulation and Audience Marketing Manager will be specifically tasked with growing the traffic on high revenue areas of About.com's network of over 450 sites, increasing the number of subscribers to About.com's newsletters and stand alone offer emails, managing About.com's email list, in addition to creating and enforcing our privacy policies.

Required qualifications:

- Minimum of 5-7 years applicable circulation experience working with consumer media, especially in an online environment
- Experience creating and implementing and audience

More About Info

[Our Story](#)
[Investor Relations](#)
[Be A Guide](#)
[Advertise](#)
[Work at About](#)
[Contact Info](#)

[Copyright](#)
[User Agreement](#)
[Privacy Policy](#)
[Help](#)

development strategy and managing the size and quality of an online audience

- Demonstrated ability to increase online traffic, along with knowledge of techniques for driving traffic to specific parts of a site
- Solid understanding of advertising and direct marketing, including Customer Relationship Management.
- Hands-on experience with direct response emails campaigns (privacy statements, email marketing campaigns, etc.)
- Ability to accurately project the cost of audience development efforts
- Excellent analytical and communication skills both verbal and written
- College degree with relevant course work

Ad Operations Positions

About.com is actively seeking an assertive self-starter who is able to handle multiple tasks to fill the position as Traffic Manager in our online advertising sales group working in our NYC headquarters. This hire will be responsible for reviewing banner ad submissions for adherence to technical specifications, booking into our Adserver and managing campaign progress.

Specific Responsibilities will include:

- Manage insertion order implementation post-sale.
- QA creative submissions.
- Insert and update creative in DART.
- Manage campaign progress.
- Assist Account Executives with traffic questions.
- Reconcile campaigns across Ad Delivery and Back Office systems.

Required qualifications:

- Minimum of two years online ad trafficking experience - knowledge of DART strongly preferred.
- Solid skills in Microsoft Excel and HTML.
- Demonstrated Customer Service experience.
- Incredible attention to detail.
- Ability and willingness to learn new skills quickly.
- Experience with most major rich media.

[back to top](#)



[email to a friend](#)



font size

[back to top](#)

[Topic Index](#) | [Our Story](#) | [Be a Guide](#) | [Advertising Info](#) | [Investor Relations](#) | [Work at About](#) | [Help](#)

©2004 About, Inc. All rights reserved. A PRIMEDIA Company.

[User Agreement](#) | [Privacy Policy](#) | [Kids' Privacy Policy](#)

Search

[Healthy Herbs](#)

User Agreement

1. About.com(TM) service (the "Service") and its affiliate sites (the "Sites") are accessible worldwide to anyone with Internet access. Access to and use of the Service and the Sites are subject to the terms and conditions of this User Agreement and Copyright Notice and all applicable laws and regulations, including laws and regulations governing copyright and trademark. BY ACCESSING THE SERVICE AND THE SITES, YOU ACCEPT, WITHOUT LIMITATION OR QUALIFICATION, ALL OF THE TERMS AND CONDITIONS IN THIS USER AGREEMENT. About.com and its affiliates reserve the right to change these terms and conditions at any time. The changes will appear on this screen. By using the Service and the Sites, you agree in advance to accept any changes.
2. The materials used and displayed on the Service and the Sites, including but not limited to text, software, photographs, graphics, illustrations and artwork, video, music and sound, and names, logos, trademarks and service marks, are the property of About.com or its affiliates or licensors and are protected by copyright, trademark and other laws. Any such content may be displayed solely for your personal, non-commercial use. You agree not to modify, reproduce, retransmit, distribute, disseminate, sell, publish, broadcast or circulate any such material without the written permission of About.com or the appropriate affiliate.
3. The Service and the Sites contain information, facts and opinions from various individuals and organizations. THE SERVICE AND THE SITES ARE PROVIDED ON AN "AS IS" BASIS WITHOUT WARRANTIES OF ANY KIND, EITHER EXPRESS OR IMPLIED, INCLUDING BUT NOT LIMITED TO WARRANTIES OF TITLE OR IMPLIED WARRANTIES OF MERCHANTABILITY OR

FITNESS FOR A PARTICULAR PURPOSE, OTHER THAN THOSE WARRANTIES WHICH ARE IMPOSED BY AND INCAPABLE OF EXCLUSION, RESTRICTION OR MODIFICATION UNDER THE LAWS APPLICABLE TO THIS AGREEMENT. NEITHER GENERAL INTERNET, INC. NOR ITS AFFILIATES ENDORSE OR ARE RESPONSIBLE FOR THE ACCURACY OR RELIABILITY OF ANY OPINION, ADVICE OR STATEMENT ON THE SERVICE OR THE SITES.

4. The Service and the Sites include bulletin boards, chat rooms and other user and member created pages which allow you and other users and members to post information, provide feedback to About.com and its affiliates, and interact in real-time. You agree not to post or transmit any unlawful, harmful, threatening, abusive, harassing, defamatory, vulgar, obscene, profane, hateful, racially, ethnically or otherwise objectionable material of any kind, including, but not limited to, any material which encourages conduct that would constitute a criminal offense, violate the rights of others, or otherwise violate any applicable local, state, national or international law. You will be responsible for, and indemnify and hold harmless About.com, its subsidiaries, divisions, affiliates, agents and representatives against, any claim arising from any material that you post or transmit. Although About.com and its affiliates may from time to time monitor or review discussions, chats, postings, transmissions, bulletin boards and other user and member generated pages on the Site, neither About.com nor its affiliates is under any obligation to do so. You acknowledge that About.com and its affiliates do not control the information available on the bulletin boards, chat rooms and other user and member generated pages and that any opinions, advice, statements, services, offers or other information or content presented or disseminated on any bulletin board, chat room or on any other user or member generated pages are those of their respective authors who are



[Home](#)

[Essentials](#)

[A - Z Encyclopedia](#)[Submit A Feature Article](#)[Aromatherapy](#) [Free Herb Graphics](#)[Submit a Recipe!](#)

[Browse Categories](#)

[Basics For Beginners](#)[Find A Condition Or Symptom](#)[Herb Profiles / Monographs](#)[Consumer Safety / Toxicolog](#)[Aromatherapy](#)[Preparations And Recipes](#)[Herbal Schools](#)[Homeopathy](#)[Home And Garden](#)[Flower Essences](#)[Research](#)[Family And Pets](#)[Wild Herbs](#)[Traditional Ethnic](#)[Popular Herbs](#)

[Buyer's Guide](#)

[Before You Buy](#)[Top Picks](#)[Top 3 Essential Oil Brands](#)[Topical Pain Relief Products](#)[Product Reviews](#)

[Articles](#)

[Forums](#)

[Help](#)

Stay Current

Subscribe to the **About** Healthy Herbs newsletter.

Most Popular Articles

[Spring Cleansing](#)
[Herbal Encyclopedia](#)
[A to Z](#)[Herb Encyclopedia](#)
[A to Z](#)[Horny Goat Weed - Epimedium sagittatum](#)
[Itchy Skin - Dermatitis](#)

What's Hot Now

[Herbal Encyclopedia](#)
[A to Z](#)[Spring Cleansing](#)

solely liable for their content. About.com and its affiliates reserve the right, in their sole discretion, to edit, refuse to post or remove any material submitted to or posted on the chat rooms, bulletin boards or on any other user or member generated pages.

5. Your use of the Service and the Sites is at your own risk. NEITHER About.com, NOR GENERAL INTERNET(TM) INC. NOR ANY OF ITS SUBSIDIARIES, DIVISIONS, AFFILIATES, AGENTS, REPRESENTATIVES OR LICENSORS SHALL BE LIABLE TO YOU OR ANYONE ELSE FOR ANY LOSS OR INJURY OR ANY DIRECT, INDIRECT, INCIDENTAL, CONSEQUENTIAL, SPECIAL, PUNITIVE OR SIMILAR DAMAGES ARISING OUT OF YOUR ACCESS OR USE OF, OR YOUR INABILITY TO ACCESS OR USE, THE SERVICE AND THE SITES AND THE INFORMATION AVAILABLE ON THE SERVICE AND THE SITES OR ARISING OUT OF ANY ACTION TAKEN IN RESPONSE TO OR AS A RESULT OF ANY INFORMATION AVAILABLE ON THE SERVICE AND THE SITES. YOU HEREBY WAIVE ANY AND ALL CLAIMS AGAINST About.com, OR GENERAL INTERNET INC. AND ITS SUBSIDIARIES, DIVISIONS, AFFILIATES, AGENTS, REPRESENTATIVES AND LICENSORS ARISING OUT OF YOUR USE OF THE SERVICE AND THE SITES AND THE INFORMATION AVAILABLE THEREON.
6. Any communication or material you post or transmit to the Service and/or the Sites is, and will be treated as, non-confidential and non-proprietary. You assume full responsibility for anything you post or transmit, and you grant About.com and its affiliates the right to edit, copy, publish and distribute any information or content you post or transmit for any purpose.
7. About.com and its affiliates do not review or monitor any web sites

linked to the Service and the Sites and are not responsible for the content of any such linked web sites. Your linking to such web sites is at your own risk.

8. You should be aware that if you voluntarily disclose personal information (e.g., user name, email address) on a bulletin board, chat room or on any other user or member generated pages, that information can be collected and used by others and may result in unsolicited messages from other parties.
9. This User Agreement and any disputes arising out of or related to the Service and the Sites shall be governed by, and construed and enforced in accordance with, the laws of the State of New York.

[Topic Index](#) |



[email to a friend](#)



font size

[back to top](#)

[Our Story](#) | [Be a Guide](#) | [Advertising Info](#) | [Investor Relations](#) | [Work at About](#) | [Help](#)

©2004 About, Inc. All rights reserved. A PRIMEDIA Company.

[User Agreement](#) | [Privacy Policy](#) | [Kids' Privacy Policy](#)

Search

[Healthy Herbs](#)

ABOUT ONLINE PRIVACY POLICY

About is strongly committed to protecting your privacy and providing a safe online experience for all our users. This Privacy Policy applies to information collected online through About's Web site, which includes all of the About.com Guide-Sites and governs online data collection and usage by About. Please read the complete About Online Privacy Policy below and contact us if you have any questions.

[What We Do with Collected Information](#)

[Use of Cookies](#)

[Use of Web Beacons](#)

[Controlling Your Personal Information](#)

[Security of Your Personal Information](#)

[Children's Privacy](#)

[Changes in Corporate Structure](#)

[Visitors Outside the United States](#)

[Changes to Our Privacy Policy](#)

[Contact Information](#)

COLLECTION AND TRACKING OF PERSONAL INFORMATION

So that we can provide you with the most efficient and enhanced service, we request information about you. We collect personally identifiable information such as names, email addresses and demographic information such as age, gender and zip code. We also may collect your [IP address](#), browser type, domain name, access times and referring Web site address. This information is collected both during registration on a site or in response to specific requests, for example when signing up for a newsletter, entering a sweepstakes or contest or answering a survey. Information collected at one About Web site will be available within the About family of Web sites.

Sometimes we will give you the opportunity to opt in to offers from third parties not affiliated with About. If you decide to accept these offers, we will provide, with your consent, your information to the third party. However, you should note that this Privacy Policy does not apply to information users consent to give to third parties not affiliated with About. Any information users give to another party is governed by the rules of that party's privacy policy, which may differ from this Privacy Policy. About is not responsible for information given to other parties. Please review their privacy policies prior to providing any information to third parties

WHAT WE DO WITH COLLECTED INFORMATION

We use personal information so that we may display custom, personalized content to our visitors and send newsletters, emails, features, promotional material, surveys and other updates to our users. A user may, at any time, opt out of receiving such information. We also use

collected information to evaluate and administer our service, respond to any problems that may arise and to gauge user trends to determine what part of our services are most popular with users.

We may extend offers to users on behalf of our partners about a particular product or service that may be of interest to you, but we will never give out your name or personal information at any time without your permission. As result, although About may receive a fee from our partners for this service, About sends all the offers so that your personal information is never shared with any outside third party.

We may, at times, produce reports for advertisers containing aggregate information about our users such as demographic, age and online usage information. This allows us to work more closely with advertisers to provide content and offers that are most relevant to our users. We will never include any personal information of our users in these reports.

We allow users of our Web site to send articles or links by email to other parties who may be interested in them. We do not retain any email addresses (unless you are a member who already has voluntarily provided your email address) of either the sender or recipient of such articles or links after they are sent.

We reserve the right to use or disclose any information without notice or consent as needed to satisfy any law, regulation or legal request; to conduct investigations of consumer complaints or possible breaches of law; to protect the integrity of our site and our property; to protect the safety of our visitors or others; to fulfill your requests; or to cooperate in any legal investigation.

You should be aware that if you voluntarily disclose information online (whether through About's services or any other service available online), personal or otherwise, that information can be collected and used by others. For example, if you use chat, forums, bulletin boards, your e-mail or if you post personal information online, you may receive unsolicited messages from others. About has no control over this use of your personal information.

USE OF COOKIES

Your browser offers so-called "cookies" which, if you allow their use, store small amounts of data on your computer when you visit a Web site. Cookies do not contain any personally identifiable information about you and therefore cannot be used to identify you personally. Cookies simply assist us in tracking which of our features you like best. Cookies also enable us to customize our content according to your preferences. You have the ability to accept or decline cookies by modifying your browser and our Web sites are viewable even if you disable the cookie function on your browser. However, if you disable cookies, some advanced and customized features of our site, as well as other Web sites, will not be available to you.

Some of the banner ads displayed in our Web sites are provided by outside companies. These ads contain cookies. While we use cookies in other parts of our Web



[Home](#)

[Essentials](#)

[A - Z Encyclopedia](#)[Submit A Feature Article](#)[Aromatherapy](#)
[Free Herb Graphics](#)[Submit a Recipe!](#)

[Browse Categories](#)

[Basics For Beginners](#)[Find A Condition Or Symptom](#)[Herb Profiles / Monographs](#)[Consumer Safety / Toxicology](#)[Aromatherapy Preparations And Recipes](#)[Herbal Schools](#)[Homeopathy](#)[Home And Garden](#)[Flower Essences](#)[Research](#)[Family And Pets](#)[Wild Herbs](#)[Traditional Ethnic](#)[Popular Herbs](#)

[Buyer's Guide](#)

[Before You Buy](#)[Top Picks](#)[Top 3 Essential Oil Brands](#)[Topical Pain Relief Products](#)[Product Reviews](#)

[Articles](#)

[Forums](#)

[Help](#)

Stay Current

Subscribe to the **About** Healthy Herbs newsletter.

sites, cookies received with banner ads are collected by our advertisers and we do not have access to this information. We use a reputable third party to serve some or all of the advertisements that are placed within our sites and they may use information (not including personally identifiable information) about your visits to our sites and other sites to assist in serving advertisements to you. If you would like to know more about the information gathering practices and 'opt-out' procedures of our third party ad server, please see <http://www.doubleclick.net/us/corporate/privacy>.

USE OF WEB BEACONS

Some of our Web pages may contain electronic images known as Web beacons, which are also called single-pixel gifs. These images allow us to count users who have visited those pages and to deliver co-branded services. We also may include Web beacons in promotional e-mail messages or newsletters in order to count how many messages have been opened and acted upon. Web beacons are not used to access your personally identifiable information but they are a technique we use to compile aggregated statistics about our Web site usage. Web beacons collect only a limited set of information including a cookie number, time and date of a page view and a description of the page on which the Web beacon resides. Some of our Web pages may also contain Web beacons placed there by our advertising partners to help us determine the effectiveness of our advertising campaigns.

CONTROLLING YOUR PERSONAL INFORMATION

A user may, at any time, change, correct, modify or delete any personal information they may have provided to About by visiting the Member Center located on the About homepage. Users can also unsubscribe from any newsletters or opt out of various promotional emailings at any time by visiting the Newsletters section in the Member Center or clicking on "unsubscribe" links in each of our newsletters or emails.

SECURITY OF YOUR PERSONAL INFORMATION

All About employees are made aware of its privacy practices through periodic communications and training. We limit access to private and confidential data only to those employees with a specific need to retrieve this information and we store data on multiple service systems, in controlled, secure environments. To maintain the highest level of security, we conduct internal reviews of our security measures on a regular basis.

CHILDREN'S PRIVACY

Some portions of the About Web site may be used by children under the age of 13. About is strongly committed to protecting the safety and privacy of children who visit our Web site.

About has a system in place to effectively screen its users to ensure compliance with this Privacy Policy and the Children's Online Privacy Protection Act of 1998 (COPPA). COPPA and its accompanying regulations establish United States federal law that protects the

Most Popular Articles

[Spring Cleansing Herbal Encyclopedia A to Z](#)
[Herb Encyclopedia A to Z](#)
[Horny Goat Weed - Epimedium sagittatum](#)
[Itchy Skin - Dermatitis](#)

What's Hot Now

[Herb Encyclopedia A to Z](#)
[Spring Cleansing](#)

privacy of children using the Internet.

Our site and services may collect information about children under 13, including e-mail forum participation and chat rooms. Use of such activities requires initial registration by the participant. Children under 13 who wish to register are asked to have a parent or legal guardian do so for them. The parent must provide a credit card number for verification that he/she is an adult. Upon verification, the parent can choose in which activities he or she would like the child to participate. Parents can change the selected activities at any time.

Only after verifying age, do we collect and maintain the name, date of birth and email address of children who register. With proper proof of identification (including name and credit card verification), parents can review their child's personal information, ask to have it deleted and refuse to allow any further collection or use of their child's information.

We use cookies to check the age of registered users who enter chat rooms. We do not permit users under 13 into chat rooms unless their parents have consented to their participation.

About.com includes many topical areas that all users may access. When a parent provides verifiable consent to allow his or her child to use chat and forums and to receive newsletters or other materials where a child may provide personally identifiable information, the child will also have access to those relevant services throughout the About site, including areas that may not be directed toward children. In particular, if you allow your child to participate in chat or forums, your child will have access to all chat and forum areas on About.com. Many chat areas are not monitored and private chat is permitted. Chat areas may contain information or language unsuitable for young children and visitors of all ages may participate. If you authorize your child to participate in these features, we encourage you to monitor their use closely. We also allow guests to participate in chat and forum areas at About.com but use techniques to prevent unregistered children under 13 from participating in areas unsuitable for them. Parents can change these options at any time.

Except as authorized under COPPA, About.com will NOT:

- collect online contact information from a user under 13 without prior verifiable parental consent, which includes an opportunity for the parent to prevent use of the information and participation in the activity. When we do not obtain prior verifiable parental consent, online contact information will be used only to directly respond to the child's request and will not be used to contact the child for other purposes.
- collect personally identifiable offline contact information from users under 13 without prior verifiable parental consent.
- distribute to third parties any personally identifiable information collected from children known to be under 13.
- give the ability to children to participate in forums

or chat rooms without prior verifiable parental consent.

- entice a child under 13 by the prospect of a special game, prize or other activity, to divulge more information than is needed to participate in such activity.

We will also place prominent notice wherever personally identifiable information is collected requesting the child to ask a parent for permission to proceed.

If you have any questions regarding the privacy and safety of children on our site, please visit us at <http://home.about.com/gi/pages/pform.htm>.

CHANGES IN CORPORATE STRUCTURE

In developing our business, we might sell certain assets or the company, or parts of it, may be sold, merged or otherwise transferred. In such transactions, user information, whether personally identifiable or otherwise, may be one of the transferred assets.

VISITORS OUTSIDE THE UNITED STATES

Our Web site and the servers that make this site available worldwide are located in the United States. All matters relating to these sites are governed by the laws of the State of New York in the United States. Any information you provide will be transferred to the United States. By visiting our sites and submitting information, you authorize this transfer.

CHANGES TO OUR PRIVACY POLICY

We will occasionally update this Privacy Policy as necessary to maintain the highest protection for our users and to comply with a changing environment. We recommend that you check the policy when you visit our site to be sure you are aware of and understand our current policy. If we make material changes to this policy or in how we will use or collect your personally identifiable information, we will prominently post such changes prior to implementing the change. We will not make changes in how we handle previously collected personal information that have retroactive effect unless legally required to do so.

CONTACT INFORMATION

If you have any questions about this Privacy Policy or our privacy practices, please visit us at <http://home.about.com/gi/pages/pform.htm>.

Or you can contact us by mail at:

*Customer Care
About, Inc.
249 West 17th Street
New York, NY 10011*

Updated April 2003

[Topic Index](#) |



[email to a friend](#)



font size



[back to top](#)

[Our Story](#) | [Be a Guide](#) | [Advertising Info](#) | [Investor Relations](#) | [Work at About](#) | [Help](#)

Plants by Their Alphabetical Listing

[Return to Cover Page](#)

[A Through G](#)

[H Through M](#)

[N Through S](#)

[T Through Z](#)

A Through G

[Alsike Clover](#)

[Azalea, Rhododendron](#)

[Star of Bethlehem](#)

[Black Locust](#)

[Black Walnut](#)

[Bouncing Bet](#)

[Brackenfern](#)

[Buckeye and Horsechestnut](#)

[Bulbs](#)

[Common Burdock](#)

[Buttercup](#)

[Castorbean](#)

[Catnip](#)

[Cherry](#)

[Christmas Plant \(Poinsettia\)](#)

[Cocklebur](#)

[Dumbcane \(Aroids\)](#)

[Dutchman's Breeches](#)

[Easter Lily](#)

[English Ivy](#)

[Ergot](#)

[Fescue](#)

[Foxtail Barley](#)

[Green False Hellebore](#)

H Through M

[Green False Hellebore](#)

[Poison Hemlock](#)

[Water Hemlock](#)

[Buckeye and Horsechestnut](#)

[Horsetail](#)

[English Ivy](#)

[Jack-in-the-Pulpit](#)

[Jimsonweed](#)

[Johnsongrass](#)

[St. Johnswort](#)

[Larkspur](#)

[Easter Lily](#)

[Black Locust](#)

[Lupine](#)

[Red Maple](#)

[Marijuana](#)

[Milkweed](#)

[Mustards](#)

N Through S

[Stinging Nettle](#)

[Nightshades](#)

[Red Oak](#)

[Oats](#)

[Oleander](#)

[Pigweed](#)

[Christmas Plant \(Poinsettia\)](#)

[Poison Hemlock](#)

[Pokeweed](#)

[Jack-in-the-Pulpit](#)

[Senecio, Ragwort](#)

[Red Maple](#)

[Azalea, Rhododendron](#)

[Rhubarb](#)

[Rosary Pea](#)

[White Snakeroot](#)

[Spurges](#)

[St. Johnswort](#)

[Star of Bethlehem](#)

[Yellow & White Sweetclover](#)

T Through Z

[Tansy](#)

[Tobacco](#)

[Black Walnut](#)

[Water Hemlock](#)

[White Snakeroot](#)

[Yellow & White Sweetclover](#)

[Yew](#)

Toxic Plants by Degree of Toxicity

[Return to Cover Page](#)

[Extremely Toxic](#)

[Moderately Toxic](#)

[Minimally Toxic](#)

Extremely Toxic

[Castorbean](#)

[White Snakeroot](#)

[Senecio, Ragwort](#)

[Water Hemlock](#)

[Poison Hemlock](#)

[Cocklebur](#)

[Pigweed](#)

[Jimsonweed](#)

[Johnsongrass](#)

[Cherry](#)

[Yew](#)

[Red Maple](#)

[Easter Lily](#)

[Oleander](#)

[Rosary Pea](#)

Moderately Toxic

[Dumbcane \(Aroid Family\)](#)

[Bulbs](#)

[Lupine](#)

[Rhubarb](#)

[Azalea, Rhododendron](#)

[Oats](#)

[Ergot](#)

[Fescue](#)

[Yellow, White Sweetclover](#)

[Tobacco](#)

[Larkspur](#)

[Brackenfern](#)

[Green False Hellebore](#)

[Milkweed](#)

[Horsetail](#)

[Mustards](#)

[Spurges](#)

[Nightshades](#)

[Buckeye, Horsechestnut](#)

[Black Walnut](#)

[Red Oak](#)

[Black Locust](#)

Minimally Toxic

[Foxtail Barley](#)

[Common Burdock](#)

[English Ivy](#)

[Catnip](#)

[Poinsettia, Christmas Plant](#)

[Tansy](#)

[Alsike Clover](#)

[Jack-in-the-Pulpit](#)

[Dutchman's Breeches](#)

[Buttercups](#)

[Stinging Nettle](#)

[Marijuana](#)

[St. Johnswort](#)

[Star of Bethlehem](#)

[Pokeweed](#)

[Bouncing Bet](#)

Plants by the Animals Affected

[Return to Cover Page](#)

[All Animals](#)

[Pets](#)

[Livestock and Horses](#)

All Animals

[Foxtail Barley](#)

[Common Burdock](#)

[Bulbs](#)

[Rhubarb](#)

[Azalea, Rhododendron](#)

[Castorbean](#)

[Tansy](#)

[Ergot](#)

[Tobacco](#)

[Jack-in-the-Pulpit](#)

[Milkweed](#)

[Water Hemlock](#)

[Poison Hemlock](#)

[Buttercup](#)

[Stinging Nettle](#)

[Cocklebur](#)

[Marijuana](#)

[Jimsonweed](#)

[Spurges](#)

[Pokeweed](#)

[Bouncing Bet](#)

[Nightshades](#)

[Buckeye and Horsechestnut](#)

[Cherry](#)

[Red Oak](#)

[Yew](#)

[Oleander](#)

[Rosary Pea](#)

Pets

[Dumbcane \(Aroids\)](#)

[English Ivy](#)

[Catnip](#)

[Christmas Plant \(Poinsettia\)](#)

[Easter Lily](#)

Livestock and Horses

[Lupine](#)

[Oats](#)

[Fescue](#)

[Yellow & White Sweetclover](#)

[Alsike Clover](#)

[Larkspur](#)

[Dutchman's Breeches](#)

[White Snakeroot](#)

[Brackenfern](#)

[Senecio, Ragwort](#)

[Green False Hellebore](#)

[Horsetail](#)

[Pigweed](#)

[Mustards](#)

[St. Johnswort](#)

[Star of Bethlehem](#)

[Johnsongrass](#)

[Black Walnut](#)

[Black Locust](#)

[Red Maple](#)

Plants by Type

[Return to Cover Page](#)

[Grasses](#)

[Houseplants](#)

[Other Non-woody Plants](#)

[Woody Bushes/Trees](#)

Grasses

[Foxtail Barley](#)

[Oats](#)

[Ergot](#)

[Fescue](#)

[Johnsongrass](#)

Houseplants

[Aroid\(Dumbcane\)](#)

[Easter Lily](#)

[Oleander](#)

Other Non-woody Plants

[Common Burdock](#)

[Bulbs](#)

[English Ivy](#)

[Lupine](#)

[Catnip](#)

[Rhubarb](#)

[Castorbean](#)

[Tansy](#)

[Sweetclover](#)

[Tobacco](#)

[Alsike Clover](#)

[Jack-in-the-pulpit](#)

[Larkspur](#)

[Dutchman's Breeches](#)

[White Snakeroot](#)

[Brackenfern](#)

[Senecio\(graound seed\)](#)

[Green Falsehellebore](#)

[Milkweed](#)

[Waterhemlock](#)

[Poison Hemlock](#)

[Horsetail](#)

[Buttercups](#)

[Stinging Nettle](#)

[Cocklebur](#)

[Pigweed](#)

[Mustards](#)

[Marijuana](#)

[Jimsonweed](#)

[Spurges](#)

[St. Johnswort](#)

[Star-of-Bethlehem](#)

[Pokeweed](#)

[Bouncingbet](#)

[Nightshade](#)

[Rosary Pea](#)

Woody Bushes/Trees

[Azalea, Rhododendron](#)

[Buckeye, etc.](#)

[Black Walnut](#)

[Black Cherry](#)

[Red Oak](#)

[Black Locust](#)

[Yew](#)

[Red Maple](#)

Picture Directory of Plants by Their Alphabetical Listing

[Return to Cover Page](#)



[Alsike Clover](#)



[Azalea, Rhododendron](#)



[Star of Bethlehem](#)



[Black Locust](#)



[Black Walnut](#)



[Bouncing Bet](#)



[Brackenfern](#)



[Buckeye and Horsechestnut](#)



[Bulbs](#)



[Common Burdock](#)



[Buttercup](#)



[Castorbean](#)



[Catnip](#)



[Cherry](#)



[Cocklebur](#)



[Dumbcane \(Aroids\)](#)



[Dutchman's Breeches](#)

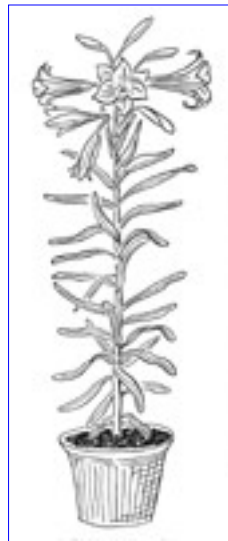

[Easter Lily](#)



[English Ivy](#)



[Ergot](#)



[Fescue](#)



[Foxtail Barley](#)



[Green False Hellebore](#)



[Poison Hemlock](#)



[Horsetail](#)



[Jack-in-the-Pulpit](#)



[Jimsonweed](#)



[Johnsongrass](#)



[St. Johnswort](#)



[Larkspur](#)



[Lupine](#)



[Marijuana](#)



[Milkweed](#)



[Mustards](#)



[Stinging Nettle](#)



[Nightshades](#)

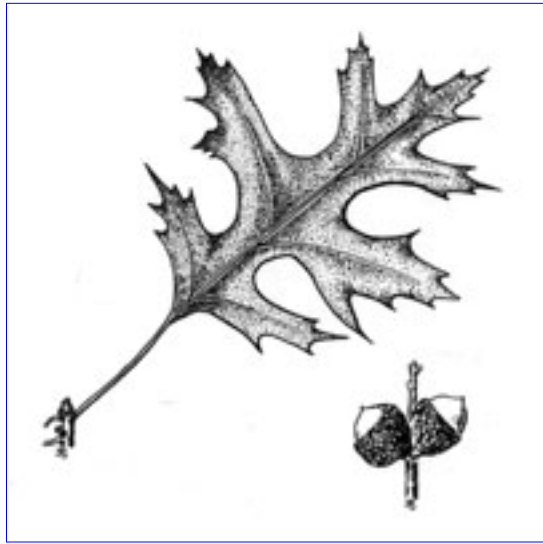

[Red Oak](#)

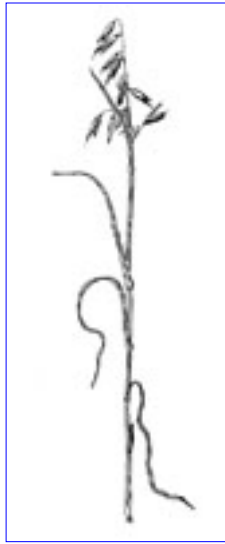

[Oats](#)



[Oleander](#)



Pigweed



Christmas Plant (Poinsettia)



Pokeweed



[Senecio, Ragwort](#)



[Red Maple](#)



[Rhubarb](#)

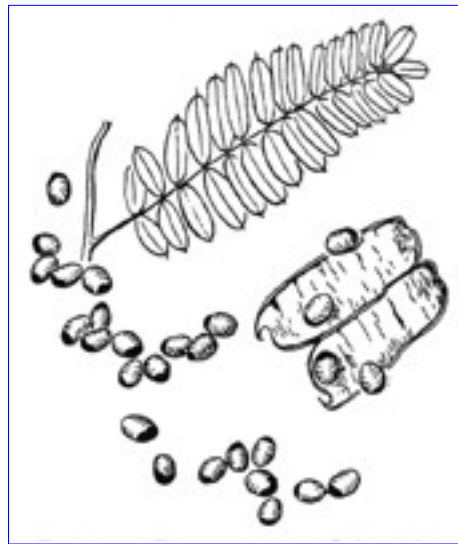

[Rosary Pea](#)



[White Snakeroot](#)



[Spurges](#)



[Yellow & White Sweetclover](#)

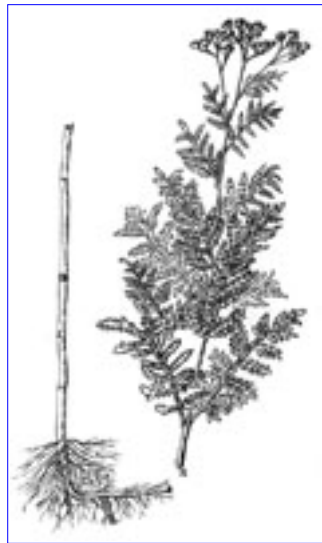

[Tansy](#)



[Tobacco](#)



[Water Hemlock](#)



[Yew](#)

INDEX



18. ALSIKE CLOVER

Trifolium hybridum

(pea family)

TOXICITY RATING: Low.

ANIMALS AFFECTED: All grazing animal may be affected.

DANGEROUS PARTS OF PLANT: All green parts (when dewy).

CLASS OF SIGNS: Gastrointestinal irritation, photodermatitis (sunburn or sunscald).

PLANT DESCRIPTION: These perennial legumes (fig. 18) are commonly grown for pasture or hay and may be found as escapes in fields, roadsides, and waste areas. They have the familiar three-parted clover leaf. The flowers are axillary, not terminal as in red clover, and are pink to white in a clover head.

SIGNS: This is not a commonly reported toxicity, and is usually not serious even if toxicity occurs. It is unknown if the wet clover causes problems by contact or ingestion. The typical signs associated with alsike clover are gastrointestinal distress, including mild colic and diarrhea. Photodermatitis ("sunburn") is also possible, especially on the parts of the body that contact the wet grass (lower legs, mouth). Liver damage has been suggested, but not well-verified. This syndrome, which can be caused by plants in addition to alsike, is sometimes called "dew poisoning" or "trifoliosis".

In rare cases, the sunburn may spread to the entire body, especially in lightly pigmented areas. Newly shorn sheep may be particularly at risk. Large amounts of alsike must be consumed before serious body-wide sunscald develops.

FIRST AID: Remove the animals from the pastures especially in the early morning when the

plants are dew-covered. Animals severely affected by sunscald need to be kept out of the sun until recovered (turn them out at night). Care for gastrointestinal and sunburned areas symptomatically. Call a veterinarian if signs are severe or if the animal does not recover in a day or two.

SAFETY IN PREPARED FEEDS: Alsike clover is safe when dry, therefore prepared feeds containing alsike is safe for consumption.

PREVENTION: Keep sensitive animals off alsike pastures in the early morning or during wet weather. Provide other feed if animals are consuming large quantities of the clover and if they are showing clinical signs. Keeping the pastures mowed will lessen the effects of the toxicity for sensitive animals.

NOTE: Red clover (*Trifolium pratense*, pea family), buckwheat (*Fagopyrum esculentum*, dock family), and alfalfa (*Medicago sativa*, pea family) can sometimes cause similar poisoning. However, white clover (*Trifolium repens*, pea family) poisoning, when it occurs, causes cyanotic or estrogenic (hormone) symptoms, especially in swine. All of these plants sometimes cause bloating, especially when the animals are put out in lush growth that they are not accustomed to eating.

INDEX



10. AZALEA, RHODODENDRON

(*Rhododendron* spp.)

(heath family)

TOXICITY RATING: Moderate. These plants grow wild in the East and cause significant problems there, the danger from these plants in Indiana is much less.

ANIMALS AFFECTED: All animals may be affected.

DANGEROUS PARTS OF PLANT: all parts, especially leaves.

CLASS OF SIGNS: Stomach irritation, abdominal pain, abnormal heart rate and rhythm, convulsions, coma, death.

PLANT DESCRIPTION: These perennial shrubs have tough, glossy, smooth-margined evergreen leaves. The large, showy flowers are in terminal clusters and have five white, pink, or red petals (fig. 10). Some horticultural varieties have yellow or orange petals. Common and local names for these plants include "lambkill" and "calckill". These plants have been used by people to commit suicide.

SIGNS: These plants, as well as mountain laurel (*Kalmia* spp.) contain grayanotoxins (glycosides) which affect the gastroenteric (stomach and intestines) and cardiovascular systems. The older name for this toxin was andromedotoxin.

In order for toxic signs to manifest, 0.2% by weight of green leaves needs to be ingested. Gastroenteric signs develop first, generally within 6 hours of ingestion, including salivating, vomiting (in capable species), diarrhea, abdominal pain, and tremors. Disturbances in cardiac rate and rhythm may then be noted. If sufficient quantities were consumed, convulsions may occur, followed by coma and death. Not all affected animals will die, and livestock may recover without treatment, depending upon amount ingested.

FIRST AID: Prevent further ingestion and provide supportive care. Veterinary attention is needed if ingestion was recent, or if clinical signs are present.

SAFETY IN PREPARED FEEDS: These plants are not safe in hay nor in any other prepared feed.

PREVENTION: Animals should not be allowed to graze these plants. Keep hungry livestock away from areas where these plants grow. Pets may nibble or taste the leaves out of curiosity or boredom, and this is not advised, but seldom leads to clinical toxicosis. Honey made from the nectar of these flowers is also toxic and should not be consumed, so exercise caution when placing beehives.

INDEX



39. STAR-OF-BETHLEHEM, SNOWDROP, NAP-AT-NOON

Ornithogalum umbellatum

(lily family)

TOXICITY RATING: Moderate to low. While very toxic, exposure is not commonly reported.

ANIMALS AFFECTED: Cattle, sheep, horses, and potentially any grazing animal.

DANGEROUS PARTS OF PLANT: All parts, especially bulbs.

CLASS OF SIGNS: Stomach and intestinal irritation, abdominal pain, irregular heart rate, death (rarely).

PLANT DESCRIPTION: This perennial (fig. 39), a close relative of wild garlic (but without the smell), reproduces mostly by clumps of bulbs. The central flower stem grows 4 to 12 inches long. The leaves are about as long as the stem and have a light green midrib. Star-shaped flowers, six white petals with green stripes on the back, appear in spring. Usually the tops die back after flowering and before the fruit, a capsule, can be produced. Originally introduced to Indiana as a garden plant, star-of-Bethlehem has now gone wild along roadsides, in fields, and in woods, especially in the southern and western parts of the state.

SIGNS: Star-of-Bethlehem contains cardiac glycosides in all parts of the plant, with the bulbs containing a higher percentage of the toxin. This is not a commonly reported toxicosis, but it can be severe if encountered and if enough of the bulbs have been consumed. The bulbs may become more readily accessible after plowing, frost heaving or other such activity, thus increasing the risk of toxicosis. The toxic component (and therefore the toxic signs) are very similar to foxglove (*Digitalis*). The first signs are stomach and intestinal irritation, which is followed by abnormalities in the heart's rate and rhythm, and this can progress to fatal cardiac arrhythmias.

FIRST AID: If animals are observed eating Star-of-Bethlehem, contact a veterinarian immediately,

since evacuation of the gastrointestinal tract may be attempted to remove the toxin. Beyond this, therapy is symptomatic and supportive, often necessitating a veterinarian's care.

SAFETY IN PREPARED FEEDS: The toxin remains after the plant has dried. Since the toxin is powerful, there is no level that can be considered safe when feeding processed feeds containing Star-of-Bethlehem.

PREVENTION: Do not let animals graze Star-of-Bethlehem, and avoid incorporating this plant into hay and other feeds. It would be advisable to eliminate the plant from pastures, especially if they grow in any significant numbers.

INDEX

48. BLACK LOCUST

Robinia pseudo-acacia

(pea family)

TOXICITY RATING: High to moderate.

ANIMALS AFFECTED: Horses are particularly at risk, but all animals ingesting the plant may be poisoned.

DANGEROUS PARTS OF PLANT: Leaves, especially wilted leaves, young shoots, pods, seeds, inner bark.

CLASS OF SIGNS: Depression, poor appetite, weakness, paralysis, abdominal pain, diarrhea (which may be bloody) and abnormalities in the heart rate and/or rhythm. Death is possible.

PLANT DESCRIPTION: These moderate-sized trees with rough bark often bear two short spines at the base of each leafstalk (easiest to see on young leaves). Leaves are alternate and pinnately compound with oval, entire leaflets (fig. 48). The fragrant flowers are creamy white, sweet-pea-like, and arranged in long drooping clusters. The fruit is a flat brown pod which contains kidney-shaped beans (fig. 48A). Black locusts are common in well-drained woods, thickets, and waste areas, especially in the southeastern part of the state. They are often planted along highways and fencerows as ornamentals and for erosion control.

SIGNS: This discussion will center on the effects in horses, the species most likely to be poisoned by black locust. Horses may ingest the bark or leaves when hungry and no other forage is available, or if they are confined or bored in the vicinity of the tree.

There are several toxic components in black locust including the toxic protein robin, the glycoside robitin, and the alkaloid robinine. The toxins affect the gastrointestinal tract as well as the nervous system. Clinical signs can manifest as soon as one hour after consumption and can include

depression, poor appetite, generalized weakness to paralysis, abdominal pain, diarrhea (which may be bloody) and abnormalities in the heart rate and/or rhythm. With sufficient amounts ingested, death may occur within a few days, although black locust is not always lethal. Some animals recover despite showing clinical signs, an indication of the dose-dependent nature of the toxin.

Honey locust (*Gleditsia triacanthos*, pea family) has been implicated in causing similar toxic signs, but the information on this is not clear. Prickly ash (*Zanthoxylum americanum*, citrus family) superficially resembles black locust in vegetative aspect and has been blamed for loss of sheep.

FIRST AID: If horses are observed eating black locust, contact a veterinarian immediately, since emergency measures to rid the gastrointestinal tract of toxin may be implemented. Beyond this, therapy is aimed at preventing further exposure and keeping other animals away from the trees, and treating clinical signs symptomatically. Recovery may take days to weeks. Be extra cautious around affected horses to prevent human injury, and these horses should not be ridden until all clinical signs have resolved.

SAFETY IN PREPARED FEEDS: Reports are not clear on this matter, but given the potentially toxic nature of black locust, it should never be allowed to contaminate feeds, especially those destined for horses.

PREVENTION: Do not confine horses in an area where black locust grows. If this is unavoidable, provide enough palatable feed so that the horses leave the trees alone. Some horses are wood and bark chewers, however, and for these horses it may be necessary to fence off the trees or utilize a different pasture to prevent toxicosis. Paints and sprays to prevent wood chewing may be tried, but long-term success with these treatments may be difficult.

INDEX

45. BLACK WALNUT

Juglans nigra

(walnut family)

TOXICITY RATING: Moderately toxic, depending upon length of exposure.

ANIMALS AFFECTED: Horses, dogs, possibly other animals.

CLASS OF SIGNS: Laminitis, breathing problems, gastroenteritis.

PLANT DESCRIPTION: These familiar trees are recent additions to the list of poisonous plants. Little information is yet available about their toxicity. Black walnuts are large (60-80 foot) forest trees often

planted as ornamentals. The bark has characteristic broad, round ridges. The leaves are alternate, pinnately compound, 1 to 2 feet long, with 13 to 23 sharply toothed, tapered-pointed leaflets (fig. 45). Often there is no terminal leaflet. The fruit is a very rough nut enclosed within a clammy glandular husk, 2 to 4 inches in diameter (fig. 45A).

SIGNS: Horses are most often affected. When horses are bedded on wood shavings containing more than about 20% of black walnut shavings (which tend to be dark in color), clinical signs of laminitis (inflammation of the laminae in the hoof) can occur within 12 to 18 hours of contact, but 24 hours may elapse before signs manifest. Consumption of the shavings may cause signs of laminitis as well as mild colic. Affected horses become unwilling to move or have their feet picked up, are depressed, may exhibit limb edema and signs of laminitis. Difficulty in breathing (increased rate and depth) may be noted. Horses on pasture may show mild respiratory signs from pollen or fallen leaves. Poisoning in dogs is reported occasionally when the seed hulls are consumed, causing stomach upset and diarrhea (gastroenteritis).

The toxin causing equine laminitis has not been clearly identified. It was once thought to be

juglone, but this is not believed to be the toxin. Juglone is produced by the tree which limits the growth of other plants in the vicinity. Walnuts are also lethal to earthworms.

FIRST AID: Remove black walnut shavings immediately; cooling the hooves and legs with a hose can help. Call a veterinarian if signs are severe or if shavings were consumed. Prompt removal of shavings typically results in complete recovery. Respiratory signs in horses usually do not require treatment unless severe or long-lasting. Stomach upset in dogs will resolve when hulls are no longer eaten.

SAFETY IN PREPARED FEEDS: Reports are not clear concerning the safety of black walnut leaves in processed feeds. The bark and seed hulls are toxic, and these should never be incorporated into any feeds. In the interest of safety, any part of the black walnut plant should not be allowed to contaminate feeds.

PREVENTION: Do not use shavings containing black walnut, limit access of horses to pastures with walnut trees. Purchase bedding shavings only from reputable dealers. Do not let dogs eat walnut hulls.

INDEX



41. BOUNCING BET, SOAPWORT

Saponaria officinalis

(carnation family)

TOXICITY RATING: Low.

ANIMALS AFFECTED: All animals have the potential to be affected.

DANGEROUS PARTS OF PLANT: All parts, especially seeds and roots.

CLASS OF SIGNS: Mouth, stomach, and intestinal irritation.

PLANT DESCRIPTION: A very common and familiar weed of summer and autumn throughout the United States, bouncing bet (fig. 41) is found in colonies along roadsides and railroad tracks, in meadows, and waste areas. It is a knee-high, spreading, perennial weed with jointed stems. The leaves are opposite, simple, toothless, and slightly hairy. Phlox-like, flat-topped flower clusters consist of white or pinkish-white to red blossoms that have five petals, each with a slight notch at the tip.

SIGNS: Bouncing bet contains saponins, substances that when mixed with water produce a soap-like foam. These saponins produce gastrointestinal irritation upon ingestion. Animals will typically avoid eating this plant, however they may ingest it if extremely hungry and no better feed is available, or if parts of the plant (especially the seeds or the roots) are incorporated into prepared feeds. The plant needs to be consumed for several days before toxic signs are noted, which can include: mild depression, vomiting (in those species that can vomit), abdominal pain, diarrhea (which may become bloody). Overall, this toxicosis is not encountered frequently.

The seeds of corn cockle (*Agrostemma githago*) contains saponins and cause toxicity similar to that of bouncing bet. In the case of corn cockle, the poisonings occurred when seeds contaminated prepared feeds. Swine are particularly susceptible to this toxicity.

FIRST AID: If the animals are eating the plant in the pasture, either remove the animals or eliminate the plants. Provide better forage, since most animals will not eat this plant unless there is little else to eat. If the feed is contaminated, it may need to be discarded, since the continual presence of the saponins will perpetuate the gastrointestinal irritation. Call a veterinarian if animals are severely affected and do not recover within 12 to 24 hours, or if the animals were observed eating a large amount of the plants.

SAFETY IN PREPARED FEEDS: Feed and hay contamination with bouncing bet (especially the seeds) is the primary route of poisoning. The toxicity remains with drying and upon storage, and the feed is not safe for consumption.

PREVENTION: Maintain pastures in good condition, keeping weeds mowed. This alone will discourage most broadleaf plants from growing, including bouncing bet. Exercise caution when preparing hay or other feeds, so that no seeds or other plant part becomes incorporated into the mixture. When buying feeds, only do business with reputable suppliers.

INDEX



23. BRACKENFERN, BRAKE FERN

Pteridium aquilinum

(fern family)

TOXICITY RATING: Moderate.

ANIMALS AFFECTED: Ruminants (especially cattle), horses, sometimes swine. Any grazing animal is susceptible.

DANGEROUS PARTS OF PLANT: All parts, especially the roots.

CLASS OF SIGNS: In horses and swine: Weight loss, weakness, gait abnormalities, abnormal heart rate and/or rhythm, inability to rise, death.

In ruminants: Bleeding disorders (bruising, hemorrhaging, anemia), breathing difficulties, weight loss, death.

PLANT DESCRIPTION: The broad, triangular leaves (fronds) of this perennial fern rise 2-3 feet tall (sometimes to 4 feet) from a thick, brown or black, horizontal rootstock. Each frond divides into three main parts, and each of these is twice subdivided (fig. 23). The edges of the leaves usually turn under. Late in summer the lower edges of mature fronds bear powdery clusters of brown spores (fig. 23A). These ferns are common in open, acid woodlands, burned-over areas, and

open pastures in dry, sandy, or gravelly soil. Stands of bracken may be so dense that they crowd out all other plants. Although brackenfern grows statewide, it is more common in the northern prairie and lake regions.

SIGNS: Toxic signs vary between ruminants (cattle, sheep and goats) and monogastric animals (like horses and swine):

Horses: The toxin in brackenfern is thiaminase, an enzyme that destroys thiamine (vitamin B1). The horse then essentially suffers from a vitamin deficiency of thiamine, which causes myelin degeneration of peripheral nerves (a loss of the fatty insulation layer to nerves that primarily control muscles). Poisoning can occur at any time of year, but is more likely in the late summer when other forages are scarce and the level of thiaminase is at its peak. Bracken is not considered palatable, but horses will eat it if no other forage is available, or they will consume it in hay or bedding, where it remains toxic. Some horses are believed to acquire a taste for it, and these horses will consume it even if other forages are available.

Horses need to consume bracken for one to two months prior to manifesting clinical signs. After this time horses may then be fed bracken-free forage and yet still develop clinical signs within 2 to 3 weeks. The first signs in horses is weight loss after a few days on bracken. Later, weakness and gait abnormalities are present, which progress to staggering, hence "bracken staggers". Affected horses may stand with their legs widely placed and their back arched. Muscle tremors and weakness is apparent when the horses are forced to move. Early in the course of the syndrome, a slow heart rate and abnormalities of the heart rhythm may be noted. Near the end of the clinical course, the heart rate and temperature rise, and the animals cannot get up and may have spasms and an upward arching of the head and neck. The syndrome runs its course, with death occurring within 2 to 10 days of the onset of signs, but it can be treated.

Swine would show signs similar to those in horses.

Ruminants, especially cattle: Thiaminase does not adversely affect ruminants since the ruminal bacteria degrade the enzyme. However, other toxins in bracken affect ruminants, most notably ptaquiloside, a lactone toxin that affects the bone marrow. The toxin is present in all parts of the plant, but is concentrated in the rhizomes, and is toxic in fresh as well as dried plants.

Consumption of bracken results in the depression of bone marrow (and thus red and white blood cell and platelet production), and the plant has a direct or indirect anti-coagulant property. Cattle show signs after grazing bracken for 1 to 2 months, although death may occur within this time frame as well. Affected cattle have an increased temperature, weight loss, and exhibit increased bruising and bleeding. From the excessive bleeding, cattle are anemic, and can die within a week of showing signs. Young cattle may develop swelling in the larynx and have difficulty breathing. Sheep may be poisoned in a similar manner, but are apparently more reluctant to consume bracken.

The plant is also reported to contain carcinogenic substances, but instances of cancer in animals resulting from bracken fern ingestion is not well reported.

FIRST AID: Horses: If horses are observed eating bracken, immediately remove them from the pasture, or in some way prevent access to the plant. Hay with bracken in it should never be fed. If large amounts were consumed, and especially if clinical signs are present, call a veterinarian

immediately. The antidote is daily injections of thiamine for up to two weeks. Do not wait until the animal cannot rise, by then it may be too late. Provide similar first aid to swine.

For ruminants: Immediately remove cattle from bracken pastures, or fence off the bracken areas to limit access. Do not feed hay or bed animals on straw that contains bracken. A veterinarian can assist with treatment of affected animals, but this may be cost prohibitive. Evacuation of the rumen and intestinal tract is usually not of value, since the poison accumulates in the system for many days, and there may be little or no toxin remaining in the digestive tract to be removed once clinical signs appear. Treatment is concerned with alleviating the clinical signs and providing supportive care. Blood transfusions may be attempted, but the prognosis is poor for clinically affected animals.

SAFETY IN PREPARED FEEDS: Bracken remains toxic when dry, and is never safe for consumption.

PREVENTION: Grazing animals should not be allowed access to bracken fern, especially if they have developed a taste for it. Provide supplemental feed if the pasture is low in adequate forage. Never use hay or bedding material that contains bracken.

NOTE: Sensitive fern (*Onoclea sensibilis*, fern family), may also be poisonous. Horses reportedly have become nervous and uncoordinated after eating this common fern of marshy areas.

INDEX



44. OHIO BUCKEYE HORSECHESTNUT

Aesculus glabra *Aesculus hippocastanum*

(horsechestnut family)

TOXICITY RATING: Moderate to high.

ANIMALS AFFECTED: All animals may be affected, especially grazing animals and those consuming the honey.

DANGEROUS PARTS OF PLANT: Buds, nuts, leaves, bark, seedlings, and honey.

CLASS OF SIGNS: Two effects: gastrointestinal and neurologic: excessive salivation, gastrointestinal irritation, vomiting in those species that can vomit, abdominal pain, diarrhea. Neurologic signs can include staggering, trembling, breathing difficulty, dilated pupils, collapse and paralysis, which can proceed to coma and death.

PLANT DESCRIPTION: The thick twigs of these medium-sized trees have glistening buds in spring and bear opposite leaves composed of five leaflets in a finger-like arrangement (fig. 44). The yellowish flowers rise in large, upright, dense, candle-like clusters at branch ends during June. The prickly fruit contains 1 to 3 nutlike seeds, glossy and leathery brown with a pale scar on each that gives the tree its name. These trees commonly grow in rich, moist woods or along river banks and are often planted as ornamentals.

SIGNS: The toxins in Buckeye and Horsechestnut affect the gastrointestinal tract as well as the nervous system. The saponic glycoside aesculin in addition to suspected alkaloids cause the toxic signs. Initially, gastrointestinal signs manifest, which can include salivation, vomiting (in those species that can vomit), abdominal pain, and diarrhea. If enough was ingested, neurologic signs may develop, including trembling, staggering, and difficulty in breathing. Toxicity may then progress to collapse, paralysis, coma and death.

These trees are among the first to leaf out in the spring, and hungry animals on pasture may be tempted to eat them if no other forages are available.

FIRST AID: If animals are observed eating Ohio Buckeye or Horsechestnut, contact a veterinarian immediately; emergency measures can be used to remove plant material from the digestive tract. Once clinical signs are present, and if it has been several hours after the plants were consumed, supportive care is all that can be provided, since there is no antidote for this toxicosis.

SAFETY IN PREPARED FEEDS: Reports are unclear concerning the safety of Ohio Buckeye or Horsechestnut in processed feeds. Therefore, in the interest of safety, consider these plants as toxic and do not feed processed feeds if contaminated.

PREVENTION: If animals are to be pastured with these trees, be certain that adequate, nutritious forage is available. In this way, the animals are likely to avoid consuming toxic quantities of these trees.

INDEX



4. BULB-BEARING PLANTS OF HOUSE AND GARDEN

TOXICITY RATING: Moderate. Incidents of poisoning by these plants is rare, but special care must be taken, especially with lily of the valley.

ANIMALS AFFECTED: Pets are primarily at risk, cattle have been poisoned by iris.

DANGEROUS PARTS OF PLANTS: Bulbs, rootstocks, whole plants.

CLASS OF SIGNS: Stomach upset, vomiting, diarrhea. For lily of the valley, additional signs may include irregular heartbeat, convulsions, and death.

PLANT DESCRIPTIONS:

1. *Convallaria majalis* (lily-of-the-valley, lily family). A familiar low-growing garden perennial, forms dense clumps from slender rootstocks called "pips." The lily-like leaves are parallel-veined (fig. 4A), and from them rise flower stalks that bear small white blossoms all on one side. The flowers are bell-like and fragrant and rarely develop into the red to orange-red berries.

2. *Hippeastrum vittata* (amaryllis, amaryllid family). A houseplant (fig. 4B) that blooms in only a few weeks after forcing in the wintertime. At first one or two 1 to 3 feet tall, naked stalks appear, each bearing from one to four large, six-petaled, red, blue, white, or bicolored flowers. Later several sword-shaped, fleshy leaves develop from the base of the plant.

3. *Hyacinthus* spp. (hyacinth, lily family). These potted or garden plants grow from a 1 to 2 inch diameter bulb (fig. 4C). The 8 to 12 inch long leaves are narrow, somewhat trough-shaped, and fleshy. The small fragrant, white, pink, or blue lily-like flowers are borne on a leafless stalk that is taller than the leaves.

4. *Iris* spp. (iris or blue flag, iris family). These commonly grown garden perennials also occur

wild in wet

meadows, marshes, roadsides, lakeshores, and stream banks. Branching, fleshy rootstocks bear clusters of long, sword-like leaves in which the base of each leaf is folded over the base of the next higher leaf (fig. 4D). The flowers, blue with a yellow heart in our wild species but purple, blue, yellow, or reddish-brown in cultivated varieties, have three upright "standard" petals and three pendant "fall" petals. The fruit is a dry capsule.

5. *Narcissus* spp. (daffodil, jonquil, narcissus; amaryllid family). Springtime in Indiana is officially proclaimed by the yellow trumpets of daffodils (fig. 4E). These perennials produce lily-like leaves and slender stalks that each bear a conspicuous orange, white, or yellow flower with six petals, parts of which fuse to form the trumpet.

SIGNS: This group of plants is divided into two sections. The first section includes lily of the valley, and the second section includes the other bulbs.

Lily of the valley is the far more dangerous plant, producing a mixture of many cardiac glycosides, especially convallatoxin. Toxic signs in pets after they chew on the plant would include stomach upset, vomiting, irregular heartbeat, convulsions, and death if sufficient quantities are consumed. The toxin in lily of the valley acts in a similar manner to the toxin in foxglove, a plant from which digitalis, a powerful cardiac medication, is derived.

The bulbs or corms of tulip, daffodil, jonquil, narcissus, amaryllis, and iris produce primarily gastrointestinal signs (vomiting and diarrhea) after consumption, and are not as toxic as lily of the valley. Pets are more likely to come into contact with these plants than are horses or livestock, however, livestock (cattle) have been poisoned when grazing wild-growing iris and eating the rootstocks.

Concerning pets, dogs are the most likely to consume the bulbs, and the usual time for poisoning is when the bulbs are removed from the ground or stored prior to planting. This is not a common poisoning, but some animals, once they find the stored bulbs, will consume them. While unlikely, some animals will dig the bulbs up in the yard and eat them. The toxic components in these bulbs is not well identified, but may be a mixture of alkaloids, having an irritant action on the gastrointestinal tract.

FIRST AID: For lily of the valley, contact a veterinarian immediately. If the animal is vomiting, allow it to continue to do so, since this will remove the toxin from the gastrointestinal tract. If the vomiting is severe or persists, a veterinarian needs to be contacted. In cases where the pet has eaten a large quantity, emergency treatment is imperative. For the other bulbs and for iris, vomiting and diarrhea should resolve in a few hours. If the signs continue, or if the pet is weak, sick, pregnant, nursing, or old, a veterinarian can provide supportive care until the toxin is eliminated.

SAFETY IN PREPARED FEEDS: It is unlikely that these plants would be incorporated into animal feeds. On the rare event that this occurs, the toxins would remain, and the feed is then unsafe for consumption.

PREVENTION: Do not allow livestock to graze where iris grows, especially if there is insufficient forage available. For pets, do not allow access to stored bulbs, and restrict access to bulb beds and

4. BULB-BEARING PLANTS OF HOUSE AND GARDEN

newly planted bulbs. Never pen or place an animal within reach of these plants, especially lily of the valley, since the pets (including birds) may nibble them out of boredom.

INDEX

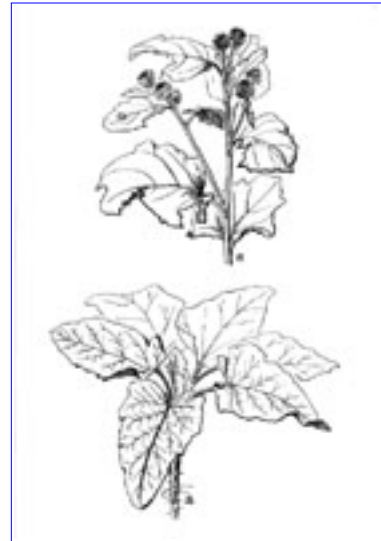

2. COMMON BURDOCK

Arctium minus

(daisy family)

TOXICITY RATING: Low. Burs cause local irritation and possibly intestinal hairballs, and most animals avoid ingesting these plants. Serious illness and death are rare.

ANIMALS AFFECTED: All animals may be affected. Pastured animals and outdoor dogs are particularly at risk. Poultry may get burs lodged in the esophagus.

DANGEROUS PARTS OF PLANT: Burs.

CLASS OF SIGNS: Skin, eye, mouth, nose, and ear irritation; stomach irritation; hairballs.

PLANT DESCRIPTION: This familiar biennial weed (fig. 2) of waste places and roadsides grows from a fleshy taproot and produces large, heart-shaped, hairy leaves and red-violet flower heads surrounded by numerous hooked bracts that form a bur-like cup.

Burdock is often confused with cocklebur (a far more dangerous plant). Burdock burs are rounder and have softer, more Velcro-like hairs than cocklebur. Cocklebur burs are oblong and have hooked spines on the bur, and have, on the end of the bur, two spines which are larger and not as strongly hooked.

SIGNS: These burs, and those of cocklebur, crimson clover, rabbitfoot clover, sandbur, and buffalobur may lodge in the skin, eyes, ears, mouth, throat, or stomachs of grazing animals (and sometimes pets). Direct irritation may result, with swelling and pain, or the bur may form the center of a "hairball", a mass of plant matter, hair, and debris that can cause digestive tract irritation and possible obstruction. These burs also tend to lodge in the fur, manes, and tails of animals.

2. COMMON BURDOCK

FIRST AID: Remove all visible burs (some may need to be cut out of the hair). If the irritation is minor, provide supportive care. If the eyes, ears, nose, mouth, feet, or hooves are involved, or in cases of digestive upset or inability to eat, a veterinarian needs to be contacted. Burs and hairballs may require surgical removal.

SAFETY IN PREPARED FEEDS: Only poor quality hay and feeds would contain these burs. If the number of burs is small or only in certain sections of the hay (which should be discarded), few problems may result. If there are many burs, especially if the animals are forced to eat these feeds, problems are likely to develop.

PREVENTION: Prevention consists of removing these plants from the pasture. Mowing is effective in reducing the number of flowers and burs that will develop.

INDEX

30. BUTTERCUPS

Ranunculus spp.

(buttercup family)

TOXICITY RATING: Low. Most animals avoid buttercups, and seldom ingest enough to cause any serious toxicity.

ANIMALS AFFECTED: All animals that chew on or ingest the plant can be affected.

DANGEROUS PARTS OF PLANT: Fresh leaves and stems.

CLASS OF SIGNS: Oral and gastrointestinal irritation are the primary signs (oral irritation, salivation, abdominal pain, diarrhea which may be bloody).

PLANT DESCRIPTION: Buttercups arise from fibrous roots, thickened rootstocks, or bulbs to form a rosette of basal leaves and often a low stem with alternate and divided (three-parted) leaves. The axillary, solitary flowers have five green sepals, five glossy yellow petals, and numerous reproductive parts and seeds. Buttercups usually are found in moist woods, meadows, fields, pastures, and sometimes along roadsides and in drier sites. Bristly buttercup (*Ranunculus hispidus*, fig. 30A) is typical of the wet site species; celeryleaf buttercup (cursed crowfoot, *Ranunculus sceleratus*, fig. 30B) is typical of the small-flowered, dry-site species.

SIGNS: The toxin in buttercup is protoanemonin, a volatile yellow oil, which causes intense oral irritation and gastrointestinal irritation. Problems in livestock tend to occur most often in the spring, herbivorous pets may be poisoned at any time if they have access to the plant. The plant is not palatable, and causes almost immediate oral irritation, so animals tend to avoid it. The toxicity of buttercup varies greatly among the different species and during the course of the growing season. Seldom is buttercup reported as a significant threat to animals. In experimental feeding

trials with greater quantities of buttercup, prostration, coma and death have been reported, but these signs are rarely reported under field conditions.

FIRST AID: No treatment is necessary unless severe gastrointestinal signs are present (colic, bloody diarrhea) or if a large quantity was observed to be eaten. Minor oral irritation will resolve on its own.

SAFETY IN PREPARED FEEDS: Reportedly, the toxin is volatilized ("evaporates off"), so processed feeds and hay may be safe for consumption. However, consumption of any significant quantity of contaminated feeds is not recommended.

PREVENTION: Buttercup is a common pasture contaminant, and tends to not cause problems as long as there is sufficient quantities of good forage available. Eradication is not usually necessary, since animals tend to avoid this plant on their own. If it has become a problem, mowing or eradication are recommended.

NOTE: Marsh marigold (*Caltha palustris*), a closely related plant found in similar habitats, also contains protoanemonin and causes mouth and stomach irritation as well as generalized distress when cattle, sheep, or horses eat the fresh tops. Hay has been considered safe for consumption. First aid is the same as for buttercups.

INDEX



11. CASTORBEAN, CASTOR OIL PLANT

Ricinus communis

(spurge family)

TOXICITY RATING: High. Death is likely with consumption of even small amount of castorbean.

ANIMALS AFFECTED: All animals may be affected.

DANGEROUS PARTS OF PLANT: The seeds are the primary source of toxin, but the rest of the plant may be considered to be slightly toxic as well.

CLASS OF SIGNS: Stomach irritation, diarrhea, abdominal pain, increased heart rate, profuse sweating, collapse, convulsions, death.

PLANT DESCRIPTION: This stout, robust shrub-like plant with reddish to purple stems may reach 12 feet in height. A perennial in its native tropics, it is grown as a garden annual in Indiana. The large (4 to 30 inches across), umbrella-like leaves (fig. 11) have 5 to 9 pointed, finger-like lobes. Long purple leaf-stems are attached near the centers of the leaf blades. Greenish-white or reddish-brown flowers are produced in narrow, upright clusters. The fruit is a three-lobed, green or red capsule with a soft, spiny

exterior. One large, mottled, attractive seed (fig. 11A) develops in each lobe. Some people think the seeds look like well-fed ticks.

SIGNS: The phytotoxin ("plant toxin") in castorbean is ricin, a water soluble protein, which is

concentrated in the seed. Also present are ricinine, an alkaloid, and an irritant oil. As a side note, commercially prepared castor oil contains none of the toxin. There is great species variability in susceptibility to ricin toxin, with humans and horses being the most at risk (25 grams of castorbean seed is lethal for the horse). Due to the powerful toxin however, it is best to keep all animals (livestock and pets) away from this plant.

The seed is only toxic if the outer shell is broken or chewed open. Seeds swallowed intact usually pass without incident. Signs of toxicity may not manifest for 18 to 24 hours after ingestion. The animal first shows signs of depression and a mild increase in temperature. Later, gastrointestinal signs predominate, including vomiting in humans and other species that can vomit (horses cannot vomit), profuse diarrhea (which may be bloody), colic and abdominal pain. The affected animal may then go into convulsions, collapse and die, with death generally occurring within 36 hours of consumption. The toxic signs are the result of severe gastrointestinal irritation, anaphylaxis and shock. This toxin is closely related to the toxin in rosary pea (a section on this plant is also included in this book).

FIRST AID: If animals are observed eating castorbean, call a veterinarian immediately, since emergency measures need to be undertaken. If consumption occurred several hours ago, a veterinarian will be able to provide supportive care and treat for shock, but death may still result from this powerful toxin.

SAFETY IN PREPARED FEEDS: The seeds may become incorporated into hay or grains. The seeds are never safe to eat, especially by horses or livestock, since these animals could easily crack the seed coat. After making castor oil, the remaining seed cake is sometimes used for animal feed. This needs to be boiled or heated to remove the toxin.

PREVENTION: Do not allow seeds or any other part of the plant to be incorporated into animal feeds. It is advisable to not let castorbean grow in the vicinity of pastures used for grazing or forage production. Do not allow pets access to this plant. To decrease the chances of intoxication, snip off the flower heads before they develop into seeds; this will protect children as well as pets.

INDEX



7. CATNIP

Nepeta cataria

(mint family)

TOXICITY RATING: Low

ANIMALS AFFECTED: Cats.

DANGEROUS PARTS OF PLANT: Stems, leaves.

CLASS OF SIGNS: Behavioral changes.

PLANT DESCRIPTION: Catnip (fig. 7) has all the characteristic earmarks of a member of the mint family: stems square in cross-section, leaves opposite and fragrant, and small flowers in tight clusters at the ends of branches. This perennial herb may grow up to 3 feet tall and be highly branched. The gray-green to green leaves are heart-shaped with scalloped edges and are often crowded toward the top of the plant. The flowers are white, dotted with purple, two-lipped, and produce four tiny, dark nutlets per flower.

SIGNS: Only cats are affected, and some cats are affected more than others. Aromatic oils and the monoterpene, nepetalactone, cause the signs. Cats will rub and sometime ingest the plant, and then act "drunk" or "wild" for up to an hour or more. No lasting toxicity is reported. If excessive amounts are ingested, vomiting and diarrhea can result, but the signs are self-limiting. Catnip can be considered as a legal recreational drug for cats!

7. CATNIP

FIRST AID: None is required.

SAFETY IN PREPARED FEEDS: Not applicable.

PREVENTION: Catnip is safe, however avoid excessive ingestion since vomiting or diarrhea may occur.

INDEX

46. WILD BLACK CHERRY

Prunus serotina

(rose family)

TOXICITY RATING: High.

ANIMALS AFFECTED: All animals may be affected. Ruminants (cattle, sheep, goats, deer) are more at risk than monogastric animals (dogs, cats, pigs, horses) and birds.

DANGEROUS PARTS OF PLANT: Damaged leaves pose the greatest risk. All parts are potentially toxic.

CLASS OF SIGNS: Anxiety, breathing problems, staggering, convulsions, collapse, death (which may be sudden).

PLANT DESCRIPTION: This cherry may grow as a tree or shrub. Bark of young branches and twigs is scaly and reddish-brown with prominent cross-marks ("lenticels"). Leaves (fig. 46) are alternate, simple, elliptic-pointed, leathery in texture, and finely toothed on the margins. Flowers are showy, fragrant, and white, hang in drooping clusters, and produce dark-red to black cherry fruits (fig. 46A). The wild black cherry commonly grows in fence rows, roadside thickets, and rich open woods.

SIGNS: Black cherry contains cyanogenic precursors that release cyanide whenever the leaves are damaged (frost, trampling, drought, wilting, blown down from the tree during storms). Most animals can consume small amounts of healthy leaves, bark and fruit safely; however when hungry animals consume large amounts of fresh leaves or small amounts of damaged leaves (as little as 2 ounces), clinical cases of poisoning will occur, and many animals may die. This is especially true if there is no other forage for the animals to consume, or in the case of pets, when confined and/or bored, the chances for toxic levels of ingestion can occur. The conditions of cyanide poisoning

have also been discussed under Johnsongrass.

Healthy cherry leaves contain prunasin, a cyanide precursor that in itself is non-toxic. When the leaves are damaged, the prunasin molecule is split and free cyanide (also called prussic acid or hydrocyanic acid) is liberated. Many plants, especially those in the rose family, have the potential to produce toxic levels of cyanide under certain conditions. Chokecherry (*Prunus virginiana*) is also toxic. There are reports of peach sprouts, leaves, and pits poisoning sows. Apricot pits and apple seeds are toxic as well. Arrowgrass (*Triglochin maritima*) contains a cyanogenic glycoside and has caused poisoning in livestock. Johnsongrass, discussed earlier, has a similar toxicity.

Cyanide prevents the body from being able to utilize oxygen at the cellular level, so although the animals physically can breathe, their tissues and cells "suffocate". After consumption, signs will manifest within a few minutes, but sometimes up to an hour may pass. The animals will try to breathe more rapidly and deeply, and then become anxious and stressed. Later, trembling, incoordination, attempts to urinate and defecate and collapse is noted, which can proceed to a violent death from respiratory and/or cardiac arrest within a few minutes to an hour. If an affected animal is still alive 2 or 3 hours after consumption, chances are good that it will live.

FIRST AID: The clinical signs of cyanide poisoning tends to come on quite rapidly, and the animals may be found dead without much warning. If the animals are exhibiting toxic signs, call a veterinarian immediately. There is an antidote, but it needs to be given intravenously and within a few minutes of the onset of signs, and it is often impossible to get help in time. Prevent the animals (especially the unaffected animals) from eating any more of the grass or feed. Do not handle or stress affected animals any more than absolutely necessary, since this will worsen the signs. Also, affected animals are extremely stressed and may be dangerous to work with, therefore exercise caution so no human injury results.

SAFETY IN PREPARED FEEDS: Cyanide is lost to the air with time, so processed feeds containing cherry may technically be free of the toxin. However, green chop and silage containing cherry will still retain large amounts of cyanide aside from being feeds of poor quality. Dried products would also not be of high quality if they contain cherry, but the cyanide levels will be much lower. Caution is still advised when feeding cherry-contaminated feeds.

PREVENTION: Do not allow animals to have access to damaged cherry leaves, especially if they are hungry and there is no other forage available. Do not place fallen branches or tree trimmings where animals can graze them. Exercise caution with animals on pasture after storms, during droughts or after a frost since these conditions will increase the chances of toxic levels of ingestion. For pets, do not house or confine animals in the vicinity of cherry, since boredom will increase the likelihood that the plant will be eaten. For most species of cherry, the fruit is safe for consumption. It is the leaves and bark which pose the greatest risk.

INDEX



8. CHRISTMAS PLANT

Poinsettia pulcherrima (*Euphorbia pulcherrima*)

(spurge family)

TOXICITY RATING: Low.

ANIMALS AFFECTED: All animals can be affected, but pets are more likely to come into contact with *Poinsettia* than are livestock.

DANGEROUS PARTS OF PLANT: Leaves and stems primarily, but all parts may be toxic.

CLASS OF SIGNS: Skin, mouth, eye, and stomach irritation.

PLANT DESCRIPTION: People commonly display this potted plant (fig. 8) in houses and offices in the wintertime. These 1 to 4 feet tall plants with yellow stems bear alternate, coarsely toothed, smooth, green leaves. The top leaves turn red. Although many people mistake them for petals, they function as "bracts", calling attention to the true flowers which are tiny, yellow, and clustered at the top of the plant. The inconspicuous fruits are small, green, three-lobed, fleshy capsules.

SIGNS: The milky sap (a latex) is irritating to skin, eyes, and mucus membranes. Once considered extremely poisonous, toxicity is more likely to manifest as irritation, discomfort, rash, and stomach upset. Nausea and vomiting may occur if sufficient quantities are consumed. Typically, animals will show head-shaking, salivation, and pawing or rubbing at the mouth or eyes.

FIRST AID: Wash sap off the animal to prevent further ingestion. Call a veterinarian if the eyes are affected, or if signs do not resolve in a few minutes.

PREVENTION: *Poinsettia* should not be allowed near curious animals.

INDEX

32. COMMON COCKLEBUR

Xanthium strumarium

(daisy family)

TOXICITY RATING: High.

ANIMALS AFFECTED: All animals may be affected. Cattle, swine, sheep, and poultry are more at risk than horses and pets.

DANGEROUS PARTS OF PLANT: The seeds and seedlings contain the highest quantity of toxin, yet the whole plant can be considered toxic. The seed burs can cause mechanical damage.

CLASS OF SIGNS: Gastrointestinal irritation, weakness, breathing difficulty, behavioral changes, cardiac abnormalities, death.

PLANT DESCRIPTION: The angled, sometimes red- or black-spotted stems of cocklebur grow 1 to 3 feet high. Leaves of this many-branched annual are alternate, hairy, rough-textured (sandpaper-like), somewhat heart-shaped, toothed, and lobed (fig. 32). Flowers are inconspicuous with male flowers in terminal spikes, female flowers in clusters in the leaf axils. The fruit is a hard, oval, prickly bur about 3/4 inch long containing two seeds (fig. 32A). Because seeds germinate best after being soaked in water, the plants are usually found along the shores of ponds where water has receded. The edges of farm ponds may be lush with young cockleburs. Seedlings have small strap-shaped leaves 1/4 inch wide by 1 1/4 inches long (fig. 32B). They also pop up in gardens, fields, roadsides, and other areas of nearly full sunlight.

SIGNS: There are several types of toxins in cocklebur, one being a glycoside, carboxyatractyloside, which causes hypoglycemia (low blood sugar) and a group of sesquiterpene lactones which can cause vomiting (in those species capable of vomiting), weakness, tremors, weak pulse, a loss of appetite and convulsions. Liver damage may also result from these toxins,

and death is likely if a sufficient dose was consumed (ingestion of green plant at approximately 0.75% of body weight). The seed bur can cause mechanical damage (please refer to the section on Foxtail barley). The most common time for toxic signs is late spring and early summer for the seedlings, later in the summer for the burs, and at any time seed-contaminated prepared feeds are ingested. As the cocklebur plant matures, the toxicity decreases (except for the seeds). The seedlings are extremely dangerous, and typically sprout in wet areas, such as alongside streams, at the edges of ponds, in receding floodplains, etc. Animals will tend to avoid cocklebur, even the seedlings, as long as there is sufficient forage available. Species that are less discriminant eaters (cattle, swine) are particularly at risk where cocklebur grows. Once toxic signs develop, death may follow within 48 hours. Some animals may recover, but this may take some time (weeks).

Other conditions of toxicity can occur when seeds are incorporated into prepared feeds. Feeds that may become contaminated include hay (especially if cut later in the growing season when cocklebur has gone to seed), silage, or grains (corn, beans). If the feeds (especially the grains) are highly processed, it may be difficult to arrive at an accurate diagnosis of cocklebur toxicosis. The seed is highly toxic, and any species may become poisoned upon consumption.

FIRST AID: If animals are observed eating cocklebur, contact a veterinarian immediately. In the meantime, prevent further consumption of the plant by all animals. Keep animals quiet until the veterinarian arrives.

SAFETY IN PREPARED FEEDS: The seedling, when dried, retains its toxicity, therefore feeds with dried seedlings are not safe for consumption. Mature plants are less toxic, but consumption is still not advised. Feeds that contain burs and/or seeds are a mechanical threat as well as a toxic one, therefore these feeds are also not safe for consumption at any dosage.

PREVENTION: Pasture management is essential to prevent poisonings by cocklebur. Mature, seed-bearing plants should be removed from the pasture to prevent seeding and germination. This is particularly important if the pasture contains any wet areas that are subject to seasonal drying. If removal of the plants is impractical, fence off areas where seedlings are likely to germinate and/or provide for supplemental feed to decrease interest in the seedlings. For prepared feeds, exert extra caution when harvesting for hay, silage, or grains and do not allow any cocklebur to be included. Buy prepared feeds only from reputable dealers.

INDEX



3. THE AROID FAMILY

Aglaonema: CHINESE EVERGREEN

Anthurium: ANTHURIUM

Arisaema: JACK-IN-THE-PULPIT, GREEN DRAGON

Caladium: ELEPHANT EARS

Colocasia: TARO

Dieffenbachia: DUMBCANE

Monstera: CUT-LEAF PHILODENDRON, CERIMAN, MEXICAN BREADFRUIT

Philodendron: PHILODENDRON

Scindapsus: DEVIL'S-IVY, POTHOS

Symplocarpus foetidus: SKUNKCABBAGE

Syngonium: TRI-LEAF WONDER, ARROWHEAD VINE, NEPHTHYTIS

TOXICITY RATING: Moderate. Pets may sample these commonly available plants with a nibble

or two, but rarely ingest any quantity sufficient to cause serious problems or death. Risk increases with hungry or bored animals housed in close proximity to these plants.

ANIMALS AFFECTED: Any animal that chews or ingests the leaves will be affected. In Indiana, nearly all of these plants would be grown as houseplants, therefore pets (including birds and reptiles) are primarily at risk.

DANGEROUS PARTS OF PLANT: Roots, leaves, stems.

CLASS OF SIGNS: Mouth and throat irritation, salivating, possibly stomach irritation, diarrhea (rarely).

PLANT DESCRIPTION: All 2,000 species of this family of plants should be treated as potentially toxic. A few are eaten, such as poi and taro (*Colocasia esculenta*) in Hawaii, but only after the poison is eliminated by cooking. Seven species of aroids occur naturally in Indiana, mostly in wet areas. Jack-in-the-pulpit and skunkcabbage are the most common and best known of these. Dumbcane (fig. 3), pothos, and philodendron are potted plants of offices, restaurant lobbies, and homes.

Aroids are perennials, many arising from corms or rhizomes. Some may be vines. The large net-veined leaves, which may have white or colored spots, are borne on leaf stalks that sheathe the stem. Most of these plants have simple leaves, but jack-in-the-pulpit has three-parted foliage (fig. 19). The aroid flower is a fleshy green, white, or yellow spike (spadix) borne inside a wraparound hood or bract (spathe). The fruits are brightly colored berries, borne in tight clusters, not often produced by the house plant species.

SIGNS: The plant cells contain needle-like crystal of insoluble calcium oxalate which penetrate the skin and mouth causing discomfort. In addition, the plants contain proteolytic enzymes which release histamine and kinins, causing swelling and an itching or burning sensation. Affected animals will shake their head, paw or rub the face and mouth, may salivate or foam at the mouth, may seek water, or may have visible swelling. Very severely affected animals may experience oral swelling to the point that swallowing and breathing become impaired. Typically, animals are not severely affected, since a few bites of the plants are often a sufficient deterrent to further consumption. Occasional reports of these plants causing kidney failure in cats have not been well-verified. Effects in cats appear to be limited to the signs described above. Some of these plants have been used with humans to prevent individuals from talking by causing excessive tongue swelling, hence the name "dumbcane".

FIRST AID: For minor irritation, provide supportive care and prevent further exposure. For more severe signs, if the animal does not improve within a few minutes, or if swallowing or breathing is impaired, consult a veterinarian immediately.

SAFETY IN PREPARED FEEDS: These plants are not likely to be incorporated into hay or other feeds, but if so, the toxins are likely to remain.

PREVENTION: Animals should not be allowed to consume these plants. Offer small amounts of fresh grass or other safe plant material (depending on the species), or remove the plant from the pet's environment. Some pets do not "learn their lesson" and may return to chew on these plants. In these situations, it is best to remove the plant from the pet's environment.

INDEX



21. DUTCHMAN'S BREECHES, STAGGERWEED

Dicentra cucullaria

SQUIRRELCORN, STAGGERWEED

Dicentra canadensis

CULTIVATED BLEEDING HEART

Dicentra spectabilis

(poppy family)

TOXICITY RATING: Low. The plant is unpalatable and is not eaten when better forages are available. Also, larger quantities need to be consumed to show clinical signs, and only rarely is consumption of *Dicentra* lethal.

ANIMALS AFFECTED: Cattle are primarily affected, horses and sheep also appear susceptible. Due to the nature of the toxic component (morphine-like derivatives), all species are likely to be susceptible at sufficient dosages.

DANGEROUS PARTS OF PLANT: Leaves, stems, roots.

CLASS OF SIGNS: Salivating, breathing difficulty, abdominal pain, collapse, convulsions, neurologic signs (running with head held up).

PLANT DESCRIPTION: These delicate perennials with finely-cut, fern-like leaves bear 1 to 10 showy flowers on slender stalks. The 4 to 10 creamy white flowers of Dutchman's breeches (fig. 21A) have spurs like bloomer legs. The white-flowered squirrel corn (fig. 21) and pink-flowered bleeding heart plants bear heart-shaped petals with teardrop-shaped appendages at the bottom. Small, yellow, pea-like tubers are scattered along the underground stem of squirrelcorn. The wild staggerweeds are common spring wildflowers in established woodlands.

SIGNS: This plant is one of the first to grow in the spring. It is considered to be unpalatable, but may be consumed if no other forages are available. The plant contains isoquinoline alkaloids, such as apomorphine, protoberberine, and protopine. Debate exists over whether the plants cause immediate signs, or if the plant needs to be consumed over several days before signs develop. Clinical signs begin with salivation and difficulty in breathing. Later, colic (abdominal pain) and possibly diarrhea may be noted. The animals may run with held up high, become uncoordinated, and may collapse and exhibit convulsions. Some have reported a loss of milk production in affected animals. Other disorders resembling *Dicentra* poisoning may also occur in the spring, making a diagnosis difficult. Death with *Dicentra* poisoning is rare, and animals tend to recover on their own in a few hours after they are removed from the plant. A plant called *Corydalis* (fitweed) will cause similar signs in animals (similar toxic component).

FIRST AID: Remove all animals from the plant and provide adequate safe forage. Signs tend to resolve in a few hours. For seriously affected animals, or those who are very young or ill, a veterinarian can provide basic emergency care and provide relief.

SAFETY IN PREPARED FEEDS: Precise information could not be located. Consider *Dicentra* unsafe in hay and other prepared feeds.

PREVENTION: Provide adequate feed for pastured animals, especially in the early spring. Animals will avoid *Dicentra* if better feed is available. If animals continue to eat this plant, consider fencing off the area where *Dicentra* grows to limit access.

INDEX

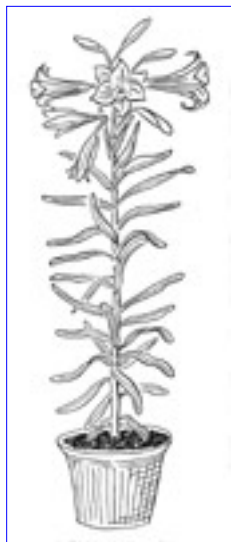

51. Easter lily

Lilium longiflorum

Lily family

TOXICITY RATING: High.

ANIMALS AFFECTED: The only reported toxicity is in cats.

DANGEROUS PARTS OF PLANT: Leaves primarily, stems and flowers may also be toxic.

CLASS OF SIGNS: Gastrointestinal irritation (vomiting), depression, lack of appetite.

PLANT DESCRIPTION: (I need to get this to you)

SIGNS: This is a newly reported toxicosis, apparently lethal only to cats. Upon consumption of Easter lily (the exact amount is unknown), the cats begin to vomit within an hour or so. The cat then becomes depressed over the next half day, presumably as the toxin begins to affect the kidneys. Within 48 to 96 hours after consumption, the cat will tend to show signs of clinical kidney failure: increased urination, depression, stomach upset, dehydration. Death tends to occur within 5 days.

FIRST AID: If a cat is seen eating Easter lily, contact a veterinarian immediately. If emergency treatment is begun within 6 hours of consumption, the chance are good that the cat will recover. This generally consists of emptying the gastrointestinal tract of the affected cat and intravenous fluid therapy in a hospital setting. If more than 18 hours has elapsed, the cat may not survive, even with emergency care.

PREVENTION: Easter lily is a popular plant at certain times of the year, and extra caution must be used when bringing these plants into the house where cats can get at them. Make sure the plant is kept away from cats, especially ones that like to nibble on things. If nibbling plants is unavoidable, have a selection of safe plants available (grass or catnip are two possibilities).

INDEX



5. ENGLISH IVY

Hedera helix

(ginseng family)

TOXICITY RATING: Low. Although reported to be very toxic in a few scattered reports, this is not a frequently encountered toxicosis.

ANIMALS AFFECTED: Cats, dogs, birds, other pets.

DANGEROUS PARTS OF PLANT: Leaves, berries.

CLASS OF SIGNS: Oral irritation, stomach irritation, diarrhea, breathing problems, coma, death.

PLANT DESCRIPTION: The vines that give many colleges their "halls of ivy" appearance may be poisonous. These woody vines, also used as groundcovers, have alternate, palmately-lobed, dark green leaves with lighter green veins (fig. 5). Flowers are uncommon but are borne in small umbrella-like clusters and produce small black berries.

SIGNS: A saponic glycoside, the aglycone hederagenin, is found in the leaves and berries. This is an uncommon poisoning, but incidents have been reported in dogs, cats, and pet monkeys, especially when the green berries were eaten. The most common signs relate to mouth and stomach irritation, but coma and death may occur if large quantities are consumed.

FIRST AID: There is no specific antidote. If animals are observed eating English ivy, contact a veterinarian immediately, especially if a large quantity of the plant was consumed. A bite or two of a leaf is not likely to cause a serious problem, but this should be discouraged.

SAFETY IN PREPARED FEEDS: There are no clear reports on this, but consider English ivy unsafe in prepared feeds.

PREVENTION: Keep animals, especially curious nibblers, away from English ivy. Exercise caution for indoor animals as well, since English ivy grows up the sides of buildings and can grow through window openings.

INDEX

14. ERGOT

Claviceps purpurea

(fungus)

TOXICITY RATING: Moderate. While ergot itself is extremely dangerous, modern feed production practices are vigilant in not allowing ergot into grain mixtures. Pasture poisoning remains the most likely source for toxicosis.

ANIMALS AFFECTED: Any animal consuming affected grain or grass seed heads: primarily swine, cattle, sheep, and goats. Poultry and horses may also be affected.

DANGEROUS PARTS OF PLANTS: Fungal bodies in the seed heads of grains and grasses.

CLASS OF SIGNS: Behavioral changes, lameness, abortions, convulsions, gangrene, death.

PLANT DESCRIPTION: Ergot (fig. 14) is a fungus parasite of the heads of grasses. In mid- to late-summer, entire grains are replaced by the black, hardened bodies of the fungus. Each body is up to 1 inch long, larger than the normal grain, and protrudes conspicuously from the head. One to a half dozen ergot bodies may develop on one head of grass. Ergots on wheat are straight. On rye they usually are curved. Ergot is found wherever its host plants grow. Rye is the most frequently attacked grain. Other grain, hay, turf, and weedy grasses may be affected, including wheat, oats, wild rice, Kentucky bluegrass, perennial ryegrass, redtop, smooth brome, orchardgrass, quackgrass, reed canarygrass, etc. When grain or hay is harvested, ergot bodies may fall to the ground and be left behind to infect the next season's crop.

SIGNS: The amines and the alkaloids in ergot (ergotamine being one of the major alkaloids) produce a number of clinical signs relating primarily to vasoconstriction and psychoactive effects. The ergot toxins are very similar structurally to lysergic acid (LSD). Wheat and rye contaminated with ergot has affected humans, and the resulting disorder is called St. Anthony's Fire. It is also believed that the one of the reasons for the Salem witch trials was due to the abnormal behavior of

persons affected with ergot toxicosis from contaminated rye flour. Ergot has been used in herbal medicine to control hemorrhage during childbirth, and is used currently as a drug to help control migraines.

Animals may be affected by ergot from eating small amounts over a long period of time, or eating greater quantities in a short period of time. Chronic toxicity is more common, with signs manifesting within several weeks of ergot consumption, and field exposure to ergot is more common than processed feed or flour exposure.

The clinical signs can vary, but often begins with swelling of and pain in the extremities, especially the hind legs, due to the constriction of blood vessels. Later, sensation is lost in the affected areas, and dry gangrene can develop. Eventually, the affected areas may slough ("fall off"), with typical losses including claws, hooves, teats, ears, or tail. In addition to the vascular effects, neurologic signs are often seen, such as apprehension, nervousness, and convulsions. Some animals may show signs of depression. Death can occur, but only with significant quantities ingested. In sublethal cases, once the source of ergot is removed, recovery from neurologic signs is likely, but recovery from the vascular effects and gangrene is not likely. Ergot poisoning has been implicated in cases of abortion in large animals.

FIRST AID: Remove animals from the source of ergot, whether in feed or pasture. Call a veterinarian if nervous signs are present. In cases of dry gangrene, the affected portion will be likely to spontaneously amputate. A veterinarian can advise and assist. Always exercise caution when working around animals that have nervous and behavioral changes to prevent human injury.

SAFETY IN PREPARED FEEDS: Ergot remains toxic in feed and should never be fed. Most feed producers are aware of ergot, so it is rare to have it contaminate commercially prepared feeds.

PREVENTION: Screen grains carefully prior to feeding or planting. Affected pastures may produce ergot each year under the right environmental circumstances (typically after wet, cool spring growing seasons). Commercially prepared feeds will not contain ergot. Pasture managers need to be able to identify ergot and limit animal access to affected fields. Keeping the pasture grasses mowed to prevent seed head formation will greatly decrease the presence of the ergot fungus. The fungus is likely to be present in the pasture, so infestations may occur in any year with the right environmental conditions.

INDEX



15. TALL FESCUE

Festuca arundinacea

(grass family)

TOXICITY RATING: Moderate to high, depending upon individual circumstance.

ANIMALS AFFECTED: Horses, cattle, possibly other ruminants.

DANGEROUS PARTS OF THE PLANT: Seed head, stem and leaf sheath.

CLASS OF SIGNS: Reproductive problems, "poor doers", lameness, dry gangrene, fever, death.

PLANT DESCRIPTION: This grass (fig. 15), often cultivated in wet pastures for forage or for turf, is a perennial, 3 to 4 foot tall clump grass with medium-wide leaves that are rough-ribbed on top. It has no rootstocks (rhizomes). The heads are open and many-branched. Escaped plants may be found along roadsides and in waste areas, especially in the southern half of the state.

SIGNS: Toxicity is the result of an endophytic ("inside the plant") fungus, *Acremonium coenophialum*, which is believed to enable the grass to be more hardy and outcompete other grass species. The grass itself is not toxic. The fungus is passed in the seed, and is not transmitted directly from plant to plant.

In horses, pregnant mares are most at risk when eating fescue, since the alkaloids produced by the fungus inhibit prolactin release. Mares will have an increased risk of prolonged gestation, abortion, stillbirth, dystocia (difficult birth), foal mortality, retained or thickened placenta, no milk, and mare death (in foaling, or from a retained placenta).

In cattle, several syndromes have been reported, including fescue toxicosis (summer slump), fescue foot and abdominal fat necrosis. Summer slump causes slower gains, decreased milk production, poor appetite, retention of winter coat, reproductive problems, and elevated

temperature. Diarrhea may also be present. Summer slump tends to occur in the warmer months, but has been noted at any time of year, and is the most common of the three syndromes. Fescue foot tends to develop in the late fall and winter, and the extremities (typically tail, ears, and rear feet) undergo necrosis ("death"). Another name for this type of necrosis is "dry gangrene". Fat necrosis develops when areas of fat inside the abdomen die.

Additional note: Fescue can accumulate nitrates under conditions of overfertilization (see the section on oats for more information on nitrate toxicosis).

FIRST AID: There is only supportive and symptomatic treatment once signs appear. A veterinarian can advise on treatment of more severely affected animals. Pregnant mares will be likely to need assistance when foaling and in the post-foaling period. Foals that survive will require supplemental colostrum. Management and prevention are the best means to minimize losses.

SAFETY IN PREPARED FEEDS: The toxin remains active in hay.

PREVENTION: There are several options, depending on the farm situation. Fungicides do not work, so animal and pasture management are the only viable alternatives. Pastures can be tested for the presence and degree of fungal contamination, and reseeded may be required. If reseeding the pasture is not feasible, keeping the pasture short will prevent seed formation. Feeding other forages, such as other warm season grasses or legumes, will be of benefit. Fescue pastures can also be diluted with legume planting (red or white clover). Heavy fertilization may make the problem worse, especially in cattle. If fescue has to be used for mares, at least avoid feeding fescue hay or pasture during the last 30 to 60 days of gestation to minimize problems. Endophyte-free strains of fescue exist, although they do not grow as well as tall fescue with endophyte.

INDEX



1. FOXTAIL BARLEY, SQUIRRELTAIL BARLEY, WILD BARLEY

Hordeum jubatum

(grass family)

TOXICITY RATING: Moderate. Irritation from the awns is likely, but serious illness and death are rare.

ANIMALS AFFECTED: All animals can be affected. Grazing animals and outdoor dogs are especially at risk.

DANGEROUS PARTS OF PLANT: Seedheads (awns).

CLASS OF SIGNS: Skin, mouth, ear, nose, and eye irritation; stomach irritation, abscesses.

PLANT DESCRIPTION: This perennial weedy grass (fig. 1) of fields, waste places, and roadsides gets its name from the long bushy flower spikes. Each long, slender, wiry bristle bears small teeth or barbs that point backwards like tiny fishhooks.

SIGNS: The seed heads (especially the awns) of this and several other types of grasses can cause mechanical irritation to the skin, eyes, ears, nose, mouth, and stomach of animals. The grasses can cause problems in pasture as well as in prepared feeds like hay. Embedded seed heads can cause local irritation and infections, or become more deeply embedded in tissues and migrate in the body. Irritation and infection often develop, necessitating removal of the plant matter. Signs depend on location of the seed awn, and can include head shaking; sneezing; nasal or ocular discharge; rubbing at the ears, eyes, or mouth; difficulty in chewing or swallowing; or signs of digestive disturbance. Yellow or green foxtail, rye and millet can cause similar problems.

FIRST AID: For minor irritation, supportive care is all that is required. Minor irritations will resolve in about a day. If any of the following are noted, a veterinarian needs to be contacted: if signs are severe, if signs of irritation do not resolve, if the eyes or ears are involved, or if the

animal cannot eat. Infections and abscesses require veterinary care, and some awns may need surgical removal.

SAFETY IN PREPARED FEEDS: Small amounts incorporated in hay and other feeds may not cause much harm, most animals will avoid eating these plants if better quality feed is available (good hay and feeds do not contain many seed heads of these grasses). Hay and other feeds containing large quantities of these seed heads are not safe for consumption, especially if animals are forced to eat these feeds.

PREVENTION: These plants are common weeds in pastures and along roadsides. If problems occur with these plants, consider mowing to reduce seedhead formation or otherwise removing them. The foxtail that commonly grows in the western U.S. (*Setaria*) is especially problematic and animals should have little or no contact with this grass.

INDEX



25. GREEN FALSEHELLEBORE, WHITE HELLEBORE, INDIAN POKE

Veratrum woodii

(lily family)

TOXICITY RATING: Moderate to high, depending on individual circumstance.

ANIMALS AFFECTED: Sheep are affected primarily, but chickens and cattle may also be at risk.

DANGEROUS PARTS OF PLANT: All parts, especially roots.

CLASS OF SIGNS: Gastrointestinal irritation, salivating, weakness, trembling, heart problems, breathing difficulties, birth defects.

PLANT DESCRIPTION: These perennial herbaceous plants (fig. 25) have stout, erect, unbranched, 1-8 feet tall stems arising from short, thick rootstocks. There are clusters of large, broad, alternate leaves that to some people resemble garden cabbage or skunk cabbage. These leaves are parallel-veined and pleated like a skirt. Green to greenish-white, inconspicuous flowers occur in large terminal clusters. *Veratrum woodii* grows in woods or on hillsides and bluffs, most commonly in the central and southern parts of the

state.

SIGNS: False hellebore can cause toxicity in grazing animals or more commonly, cause birth defects. Both of these syndromes are more common in sheep than in other species. It is possible that the toxins causing birth defects are not the same toxins that affect the grazing animals. Since toxicity of grazing animals is exceedingly rare and usually not lethal, this section will briefly cover the grazing animal toxicosis, and will focus on the teratogenic effects of false hellebore.

The toxic component in false hellebore is a mixture of alkaloids (primarily jervine, cyclopamine,

and cycloposine). In grazing animals that consume a toxic dose, salivation, gastrointestinal irritation, weakness, incoordination, decreased heart rate, and breathing difficulties may be noted. Rarely, animals may convulse and die.

More important are the effects that false hellebore has on fetuses. The toxins are known teratogens, causing developmental problems with lambs in utero. Specifically, if a pregnant ewe eats false hellebore on the 14th day of gestation, the lamb may die or have severe developmental problems. The problems in the lamb affect mostly the brain, skull and face, and the lambs can be born with a "monkey-face", or with the eyes in the center of the face ("cyclops") or hydrocephalus, or failure of the head to develop. These lambs are usually born dead or tend to die shortly after birth. In some cases, the ewes gestation is prolonged and the lamb grows too large, necessitating assistance at delivery or a C-section. It is possible that only one of a pair of twin lambs will be affected.

In addition to the well researched aspects in lambs, false hellebore, when ingested at any time prior to the 32nd day of gestation can cause many birth defects and death of the fetuses.

FIRST AID: For grazing animals, treatment is symptomatic. Call a veterinarian if signs are prolonged or severe. Nearly all animals will recover once removed from the plants. For affected fetuses, there is little that can be done other than to assist the ewe in delivery, since some of the lambs are large and/or malformed.

SAFETY IN PREPARED FEEDS: False hellebore reportedly remains toxic when dry, therefore feeds containing this plant should not be fed, especially to sheep.

PREVENTION: False hellebore is a big problem in western ranges, but can affect animals in Indiana. The danger is particularly high with sheep. It would be best to keep all pregnant ewes away from false hellebore until after their 33rd day of gestation. In addition, plants are more toxic in the spring, and toxicity decreases through the growing season. The roots and rhizomes are considered to be more toxic (lethal), with the leaves containing more of the teratogenic (birth defect) compounds. Therefore, be cautious with animals who appear to be eating this plant, and attempt to limit all access to false hellebore as much as possible.

INDEX

28. POISON HEMLOCK

Conium maculatum

(parsnip family)

TOXICITY RATINGS: Moderate to high.

ANIMALS AFFECTED: All animals may be affected. Grazing animals, swine and animals that may eat the seeds (especially poultry) are more at risk than pets.

DANGEROUS PARTS OF PLANT: All parts, especially young leaves and seeds.

CLASS OF SIGNS: Nervousness, trembling, incoordination, depression, coma, death, birth defects.

PLANT DESCRIPTION: This biennial herb (fig. 28) grows 3 to 8 feet tall and has a smooth purple-spotted stem and triangular, finely divided leaves with bases that sheathe the stem. Fresh leaves and roots have a rank, disagreeable, parsnip-like odor. The small but attractive white flowers, arranged in umbrella-like clusters, open in early summer. The fruit is tiny, flattened, and ridged. Underground is a fleshy, unbranched white taproot (fig. 28A). Unlike wild carrot (*Daucus carota*, parsnip family), there are no hairs on the stems or leaves of poison-hemlock and no branching, feathery bracts beneath the flower clusters. These plants are commonly found along roadsides, edges of cultivated fields, railroad tracks, irrigation ditches, stream banks, and in waste areas.

SIGNS: The toxic components include the volatile alkaloids coniine and gamma-coniine. A lethal dose for a horse is 4 to 5 pounds of leaves, cattle may be poisoned with 1 to 2 pounds, and sheep with a half pound or less. Humans are often poisoned, mistaking the roots for parsnips, the leaves for parsley, or the seeds for anise.

Affected animals show signs within 2 hours of eating the plant, and tend to become nervous, and will tremble and become uncoordinated. After the excitement phase, the animal becomes

depressed. The heart and respiratory rates slow down, the legs, ears and other extremities become cold, colic and/or bloating may occur. Even at this stage, the animal may not die, but may remain like this for several hours to days, and then recover. In lethal cases, the animals tend to die within 5 to 10 hours after the onset of the clinical signs, typically from respiratory failure (in which case the mucus membranes will appear blue). A mousy odor has been reported to emanate from affected animals.

The primary time of year for poison hemlock is spring, often when there is insufficient forage available. At this time, the plant may also be more palatable. The toxicity increases throughout the growing season, and the roots become toxic only later in the year. Once dried, the toxicity is considered to be reduced but not eliminated.

Poison hemlock can also cause birth defects in ruminants and swine, with cattle and swine more susceptible than sheep and goats. The most often reported birth defects are cleft palate and spinal abnormalities. The gestational ages that have been associated with birth defects are: for goats, days 30 through 60; for cattle, days 40 through 70; for pigs, days 30 through 60. The birth defects resemble those seen with lupine, with lupine being the more dangerous plant.

FIRST AID: If animals are seen ingesting poison hemlock, call a veterinarian immediately. Treatment consists of eliminating the toxin from the gastrointestinal tract and providing supportive care. If the animals become comatose but do not die, they will require intense nursing care until they recover.

SAFETY IN PREPARED FEEDS: Reportedly, poison hemlock has a decreased toxicity when dry, but hay that contains a large proportion of poison hemlock may still cause problems (besides, it would have a low nutritional value). Recommendations are to feed little or no hay that contains poison hemlock. Seeds may contaminate grain-type feeds, making these feeds unsafe for consumption.

PREVENTION: Most animals will avoid poison hemlock if other forages are available. Tiny amounts may be consumed with little problems resulting, but significant consumption, especially of the seeds, will produce clinical signs and possibly death. Eliminating the plant from the pasture is the best solution; treatment with herbicides may be tried. Be sure all plants are dead prior to re-introduction of animals, since treated plants may be more palatable. Poison hemlock may be difficult to eradicate.

INDEX

27. SPOTTED WATER-HEMLOCK, WATER-HEMLOCK, SPOTTED COWBANE

Cicuta maculata

(parsnip family)

TOXICITY RATING: High. This is one of the most toxic plants in the U.S.

ANIMALS AFFECTED: All animals can be affected, but cattle are especially at risk.

DANGEROUS PARTS OF PLANT: The roots contain the highest concentration of toxin, but all parts are toxic.

CLASS OF SIGNS: Nervousness, breathing difficulties, muscle tremors, collapse, convulsions (seizures), death (which may be sudden).

PLANT DESCRIPTION: The perennial stem of water-hemlock (fig. 27) may grow to 7 feet from its cluster of 2 to 8 fleshy or tuberous roots. Stems are smooth, branching, swollen at the base, purple-striped or mottled, and hollow except for partitions at the junction of the root and stem (fig. 27A). A yellow, oily liquid smelling like parsnips exudes from cut stems and roots. Leaves are alternate, two to three times pinnately compound, and toothed, with the leaf veins extending to the leaf notches. Leaf petioles partially sheath the stems. The small white flowers are borne in flat-topped, umbrella-like clusters at the tips of stems and branches. Seed pods are small and dry with rounded, prominent ribs. Water-hemlock is found in swampy areas and marshes, wet meadows and pastures, and along streambanks and low roadsides.

SIGNS: This plant is considered to be one of the most toxic plants in the United States since so little of it needs to be consumed to cause death. Humans have been killed after only one or two bites of what they thought were "parsnips" (water hemlock root resembles a parsnip). Cattle are the primary species affected, hence the name "cowbane", especially in early spring when the plants are smaller and apparently more palatable and the roots are easily pulled up. Animals may also be poisoned if water hemlock is plowed under or if ground is reclaimed, since this may expose the root. Toxicity decreases through the growing season, and the toxicity of above-ground parts may

be negligible when dry. The roots however are toxic at all times, even when dry. Animals have been poisoned by drinking water that had been contaminated with trampled water hemlock roots.

The toxin is cicutoxin, a yellow, viscous resin with a carrot-like odor, which affects the central nervous system. The toxic dose (the dose needed to cause clinical signs) and the lethal dose are nearly the same, with a little more than 1 gram of water hemlock per kilogram of body weight able to kill sheep, and 8 ounces (approximately 230 grams) will kill a horse.

Once the animal has ingested even a small amount of the plant, signs will develop within an hour, and as soon as 10 to 15 minutes. The syndrome is typically very violent. Stimulation of the central nervous system begins with nervousness, and dilated pupils. Later, muscle tremors occur, the animal has difficulty breathing, falls down and goes into convulsions. Death, from respiratory paralysis and terminal convulsions, is a typical outcome, occurring within 30 minutes of the onset of signs. If a sublethal dose is consumed, and the animal survives for 4 to 6 hours (or in one report, over 2 hours), the animal may recover, but may suffer from temporary or permanent damage to heart and/or skeletal muscle.

FIRST AID: If animals are seen eating water hemlock, especially the roots, get all animals away from the plant, and call a veterinarian immediately. Emergency measures (emptying the stomach or rumen and the use of medications to control seizures) may be tried, but death may still occur. The seizures cause severe damage to the heart and skeletal muscle, and this damage can be avoided if the seizures are controlled. However, this is rarely possible under farm and field conditions since the toxin acts so quickly.

SAFETY IN PREPARED FEEDS: The above-ground parts of water hemlock decrease in toxicity over the growing season and lose additional toxin with drying. Therefore, the hay may not cause clinical toxicosis, but it is still advisable not to feed hay, or other prepared feeds, that contain water hemlock. The root is never safe, and remains toxic when dry, and should never be fed.

PREVENTION: Do not allow livestock (especially cattle) to graze in areas containing water hemlock. Prevent access to these areas or completely remove the plant (most importantly the roots) prior to introducing livestock, especially in the spring or when the roots may be exposed due to plowing, ditch maintenance, or other such activity. Never allow water hemlock to be incorporated into hay or other prepared feeds.

INDEX



29. FIELD HORSETAIL SCOURINGRUSH

Equisetum arvense *Equisetum hyemale*

(horsetail family)

TOXICITY RATING: High for horses, moderate for other species.

ANIMALS AFFECTED: Horses are the species most affected, cattle and sheep may be affected, but this occurs rarely.

DANGEROUS PARTS OF PLANT: All parts, both fresh and dried.

CLASS OF SIGNS: Weight loss, weakness, gait abnormalities, abnormal heart rate and/or rhythm, inability to rise, death.

PLANT DESCRIPTION: Two types of shoots 1 to 3 feet tall merge from horsetail's underground rootstock. Both types are round, hollow, stiff, and jointed. The stem sections easily pull apart. The first type of shoot (fig. 29A) is tan, appears early in spring, and ends in a terminal, cone-like structure. The later, green, sterile shoot (fig. 29A) bears whorls of pine-needle-like branches and looks like a horse's tail. Scouringrush sends up long, tapering, cane-like shoots 1-6 feet tall. These stiff, evergreen shoots terminate in spore-producing cones. Leaves are reduced to teeth-like scales arranged in whorls around the joints of the stems (fig. 29B). The plants commonly grow on shaded, moist soil in meadows, along roadsides, in ditches and thickets, along stream banks, at the

borders of swamps, and on railroad embankments.

SIGNS: The toxic signs associated with horsetail are essentially the same as for bracken fern, since the toxin is the same: thiaminase. Horsetail does not contain the bone marrow toxin found in brackenfern. See the section on bracken fern (horses) for more details.

FIRST AID: A veterinarian needs to be called to assist in the treatment of thiamine deficiency. For more discussion, see brackenfern.

SAFETY IN PREPARED FEEDS: Consumption of horsetail in feeds is the most likely route of poisoning, but fresh plants are also toxic (but considered unpalatable).

PREVENTION: Do not allow horsetail to be incorporated into feeds, especially if these feeds are intended for horses. Do not feed contaminated hay.

INDEX

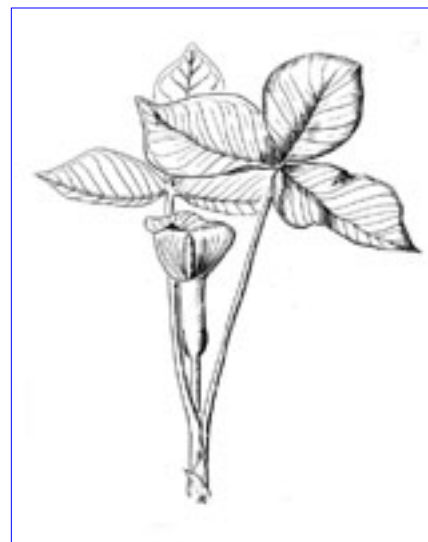

19. JACK-IN-THE-PULPIT, INDIAN TURNIP

Arisaema triphyllum

(aroid family)

TOXICITY RATING: Low.

ANIMALS AFFECTED: All animals may be affected.

DANGEROUS PARTS OF PLANT: Bulbs, stems, possibly leaves.

CLASS OF SIGNS: Oral and gastric irritation, mouth and throat swelling on rare occasions may be severe enough to affect breathing.

PLANT DESCRIPTION: These herbaceous perennials (fig. 19) pop up in spring in Indiana woodlands. They grow 1 to 2 feet tall from a tuberous root. The large leaves are three-parted, smooth-margined, and net-veined. Each plant produces one bloom beneath the leaves on a short stalk. The "jack" is a fleshy green spike ("spadix") bearing a number of inconspicuous male and female flowers. The most noticeable

part of the bloom is the "pulpit", a modified leaf ("spathe") that wraps around and hides the spadix. It may be all green or striped with red or reddish-violet. In late summer the spathe falls away, revealing a cluster of bright red berries.

SIGNS and FIRST AID: See the section for the Aroid discussion. Rarely is enough of this plant consumed to cause a problem, but the potential exists, especially in spring when other forages are not readily available and if the livestock have access to a wooded area. Signs are self-limiting, and a veterinarian only needs to be contacted if signs do not resolve or if breathing is affected.

PREVENTION: Jack-in-the-Pulpit grows in wooded, shaded areas in the spring, so limit animal access to these areas when plants begin to emerge.

INDEX



36. JIMSONWEED, THORNAPPLE

Datura stramonium

(nightshade family)

TOXICITY RATING: High. The plant and seeds are extremely toxic, this plant is abused as a hallucinogen in humans, and deaths in humans and animals have been reported.

ANIMALS AFFECTED: All animals (including pets and poultry) may be affected.

DANGEROUS PARTS OF PLANT: All parts, especially seeds.

CLASS OF SIGNS: Dilated pupils, agitation, trembling, delirium, may appear to be experiencing hallucinations, convulsions (which may be violent), coma, and possible death. Abortions and birth defects have also been reported.

PLANT DESCRIPTION: This stout, coarse annual (fig. 36) grows to 5 feet tall with strongly-scented, coarsely toothed, green or purplish alternate leaves. The large trumpet-shaped flowers are white or purplish and are formed singly at the forks in the stems. The fruits are hard, spiny capsules (fig. 36) which split open along four lines at maturity to release numerous tiny black seeds. Jimsonweed commonly grows in cultivated fields, waste areas, barnyards, abandoned pastures, roadsides, and feedlots. Other *Datura* species (angel's-trumpets) are grown as ornamentals.

SIGNS: Animals will avoid eating Jimsonweed whenever possible. Even when forages are scarce, animals are reluctant to consume this plant. For animals, the danger lies primarily in the consumption of seeds that contaminate prepared feeds (hay, silage, grains, processed feeds). The plants may become palatable after the application of herbicides, thus greatly increasing the risk of toxicosis.

Once the plant is consumed, signs become apparent within a few minutes up to several hours. The

alkaloids in Jimsonweed act on the central nervous system as well as the autonomic nervous system that controls bodily functions. Animals may seek water to drink, have dilated pupils, become agitated, may exhibit increased heart rate, tremble, become delirious, may appear to be experiencing hallucinations, have convulsions (which may be violent), become comatose, and possibly die. Consumption of Jimsonweed during gestation may result in abortions or birth defects.

Jimsonweed contains many toxic components, in particular the alkaloids, including atropine, hyoscyamine, and hyoscyne (scopolamine). As much as 0.7% of the fresh weight of the leaves may be the toxic alkaloids, which is a very large quantity. The seeds are the greatest risk, with alkaloid concentrations believed to be greater than the leaves and stems, and even the nectar is toxic.

FIRST AID: Prevent further exposure to the plant or contaminated feed. Exercise caution when working with affected animals to avoid human injury. Contact a veterinarian if signs are severe, since there are medications that can counteract the effects of the toxin. Also, if consumption was recent, contact a veterinarian quickly, since it may be possible to evacuate a large amount of the plant from the digestive tract before the toxicosis becomes severe. For less severely affected animals (a veterinarian will be able to assist in determining this), the clinical signs will resolve within a day or two, so keep animals quiet and undisturbed.

SAFETY IN FEEDS: Jimsonweed remains toxic when dry, therefore feeds are not safe for consumption. The small black seeds are very toxic and may contaminate prepared or processed feeds. Toxic signs will occur even when good forage is fed, and there is no reported "safe" quantity of Jimsonweed that can be fed.

PREVENTION: Do not allow animals to graze on Jimsonweed. Provide adequate forage whenever animals are in contact with the growing plants. If the plants are treated with herbicides, make sure they are completely dead prior to introducing animals to the pasture. Use caution when harvesting feeds, especially near the edges of fields where Jimsonweed is likely to grow. In this way, incorporation of the plant or the seeds into the feeds will be prevented. When buying processed feeds, only work with reputable dealers.

INDEX



43. JOHNSONGRASS

Sorghum halepense

(grass family)

TOXICITY RATING: Moderate to high.

ANIMALS AFFECTED: All types, especially ruminants.

DANGEROUS PARTS OF PLANTS: Leaves and stems, especially young plants.

CLASS OF SIGNS: Breathing problems, staggering, severe anxiety, convulsions, coma, death (may be very sudden).

PLANT DESCRIPTION: Johnsongrass (fig. 43), a coarse perennial grass, produces large, scaly rootstocks and grows in dense stands up to 6 feet high. Seed heads are large and loose. This plant grows commonly in the fields, fencerows, and ditch banks of the southern part of the state and is rapidly spreading northward. Once grown for dike stabilization or for hay, it is now classified as a "noxious" weed.

SIGNS: The toxic signs resulting from ingestion of Johnsongrass are due to the presence of cyanide in the leaves and stems. This toxicity is identical to that resulting from the ingestion of wilted or damaged cherry leaves. In normal, healthy Johnsongrass plants, the levels of free cyanide

are low, and the plant can be consumed safely. Other members of this grass genus have been bred as grain or forage plants (milo, Sudan grass, etc.) and also have the potential to produce cyanide, although not as much as Johnsongrass. The young shoots are the most dangerous, and when wilted, trampled, herbicide treated or frost damaged, a great deal of free cyanide is liberated in the leaves. Upon ingestion, the animals quickly develop signs related to cyanide poisoning. Mature plants have much lower toxicity, and well-cured hay is relatively safe for consumption.

The most common occurrence of Johnsongrass toxicity is on pasture after the plants have been damaged somehow. Cyanide prevents the body from being able to utilize oxygen at the cellular level, so although the animals physically can breathe, their tissues and cells "suffocate". After consumption, signs will manifest within a few minutes, but sometimes up to an hour may pass. The animals will try to breathe more rapidly and deeply, and then become anxious and stressed. Later, trembling, incoordination, attempts to urinate and defecate and collapse is noted, which can proceed to a violent death (respiratory and/or cardiac arrest). If an affected animal is still alive 2 or 3 hours after consumption, chances are good that it will live. Under rare circumstances, a chronic cyanide toxicity can develop, which causes weakness and partial paralysis, but this is not a common occurrence. In the southwestern U.S., a syndrome affecting the urinary bladder and nervous system in horses has been reported after consumption of sorghum grasses. This disorder is called equine sorghum cystitis ataxia, and the animal is uncoordinated, has urinary incontinence (dribbles urine uncontrollably), and foals of affected mares may be aborted or be born with birth defects. The disorder can also cause death.

Johnsongrass, like other plant species, can accumulate toxic levels of nitrates, depending on fertilization practices. Nitrates are extremely toxic and can also cause death, especially in cattle, sheep and goats. Look in the section on oats for more discussion of nitrate poisoning. The signs of nitrate poisoning may be confused with cyanide poisoning.

FIRST AID: The clinical signs of cyanide poisoning tends to come on quite rapidly, and the animals may be found dead without much warning. If the animals are exhibiting toxic signs, call a veterinarian immediately. There is an antidote, but it needs to be given intravenously and within a few minutes of the onset of signs, and it is often impossible to get help in time. Prevent the animals (especially the unaffected animals) from eating any more of the grass or feed. Do not handle or stress affected animals any more than absolutely necessary, since this will worsen the signs. Also, affected animals are extremely stressed and may be dangerous to work with, therefore exercise caution so no human injury results. Similar recommendations exist for nitrate poisoning, although death usually doesn't occur as quickly as with cyanide.

SAFETY IN PREPARED FEEDS: When Johnsongrass is dry, the level of cyanide is extremely low, so properly cured hay is safe for consumption. If the grass is used for silage or green chop, the levels of cyanide may still be quite high and potentially lethal. If the grass has accumulated toxic levels of nitrates, the hay, silage and chop will continue to be toxic. This may be fed in small amounts along with an adequate supply of good forage, although it would be best to discard feeds that are high in nitrates.

PREVENTION: Johnsongrass and other sorghums may be grazed safely throughout most of the growing season. Extra care must be taken when the grass is young, especially if damaged somehow. Animals should not be allowed access to the grass if these circumstances occur. Care

43. JOHNSONGRASS

must also be taken when fertilizing johnsongrass (as well as many other types of grasses) so as to not accumulate toxic levels of nitrates. Do not use johnsongrass as green chop or silage.

INDEX



38. COMMON ST. JOHNSWORT, KLAMATH WEED

Hypericum perforatum

(St. Johnswort family)

TOXICITY RATING: Low to moderate.

ANIMALS AFFECTED: Cattle, sheep, goats, horses, and swine.

DANGEROUS PARTS OF PLANT: All parts.

CLASS OF SIGNS: Sunburn, skin slough, eye irritation.

PLANT DESCRIPTION: This perennial herb (fig. 38) grows 1 to 1 1/2 feet 1/2 to 1 inch long and flat-topped clusters of golden yellow flowers 3/4 to 1 inch broad which bloom from midsummer to late fall. The five petals often have distinctive black dots around their edges (fig. 38A) and the leaves may have similar dots (fig. 38B). St. Johnswort commonly grows in droughty, poor, or over-grazed meadows, pastures, fields, and waste areas, usually on dry, gravelly, or sandy soils in full sunshine. Other species of *Hypericum* occur in Indiana, some as garden plants. Although the evidence of their toxicity is not as clear, it may be prudent to avoid them, too.

SIGNS: The toxin in St. Johnswort is called hypericin. When animals ingest the plant, the hypericin is absorbed from the intestinal tract and goes into the circulation. Hypericin is photodynamic, able to convert sunlight into energy (primarily heat), causing cellular damage and sunburn (which can be severe). Cattle and sheep are the most sensitive to this toxin, but swine and horses may also be affected.

St. Johnswort is not palatable and is eaten only when better food is unavailable. Animals must consume the plants for 4 to 5 days or more before clinical signs are noted. The affected skin first

becomes swollen and tender, then reddened. This occurs primarily on the lightly pigmented areas (pink or white skin), and on the areas of the body that receive more sunlight (head, neck, back). The skin can be burned to the point where large areas of skin peel off. This is extremely painful, and predisposes the animal to infection. Affected animals are reluctant to have the areas examined, and may act abnormally and not want to eat due to the discomfort. Occasionally the eyes will be affected, causing redness and inflammation of the eyelids and the eye itself. These animals may not be able to see.

There are many plants that can cause sunburn either by contact or ingestion. In addition to St. Johnswort, some types of clover, vetches and buckwheat (*Fagopyrum*) have caused sunburn and skin scald in animals.

FIRST AID: The first steps are to prevent further consumption of the plant and to get the animals into the shade or a barn. Emergency evacuation of the gastrointestinal tract is not required since the toxin takes several days to build up in the body and cause signs. If the sunburn is mild, conservative treatment and supportive care is all that is required. Animals will resent handling, and horses will not be able to be ridden for at least 1 to 2 weeks. Keep animals in the shade, consider turning them out at night only. For more severely affected animals, including animals whose eyes are affected, or where the skin is blistered or sloughing, a veterinarian needs to be contacted, and antibiotics and anti-inflammatory medications provided.

SAFETY IN PREPARED FEEDS: The toxin in St. Johnswort remains active even when the plants are dry, therefore hay or processed feeds will still be toxic and should not be fed. However, if the hay needs to be fed under extreme circumstances, keep all animals out of direct sunlight for up to one week after the contaminated feed is no longer being used.

PREVENTION: Animals will voluntarily avoid St. Johnswort if more nutritious and palatable forage is made available. If the pasture contains large stands of this plant, it may be best to mow, spray, or re-seed to improve the pasture quality and eliminate potential problems. If the plants are to be sprayed, keep animals off the pasture until the plants are completely dead, since herbicide treatment often increases plant palatability.

INDEX



20. DWARF LARKSPUR, STAGGERWEED, POISON WEED

Delphinium tricorne

CULTIVATED LARKSPUR

Delphinium ajacis

(buttercup family)

TOXICITY RATING: Moderate for Indiana. These plants are a more serious threat in the western ranges.

ANIMALS AFFECTED: Cattle are the primary animals affected; toxin can also affect other ruminants as well as horses.

DANGEROUS PARTS OF PLANT: All parts, especially seeds and young leaves.

CLASS OF SIGNS: Nervousness, incoordination, staggering, salivating, bloating, abnormal heart beat, breathing difficulty, paralysis, convulsions, death.

PLANT DESCRIPTION: These short annual or perennial herbs (fig. 20), 1/2 to 4 feet high, bear alternate, deeply-lobed ("crowfoot") leaves and elongate clusters of spurred white, blue, or purple flowers in the spring. Roots grow in tuberous clusters. This weed commonly grows in rich open woods, along

streams, in old fields, along roadsides, and on sand hills. Wild larkspur is most common in the southern two-thirds of the state, but the equally poisonous cultivated larkspur may be found in gardens statewide.

SIGNS: Larkspur is primarily a problem in western ranges, especially with cattle. Apparently, the

plant is palatable, which increases the risk of clinical toxicosis. The toxicity of larkspur varies, with the highest periods of toxicity occurring during early growth, and when the plant goes to seed. The toxin is a mixture of alkaloids, including ajacine and delphinine, and blocks communication between nerves and muscles (like curare). Signs appear within a few hours of ingestion. Approximately 1/4 pound of larkspur per 100 pounds body weight may be lethal for cattle. A higher dose is needed before sheep and horses show clinical signs.

FIRST AID: There is no antidote for larkspur poisoning, and treatment is supportive. A veterinarian needs to be called if the animals are bloated, or if consumption was very recent (the veterinarian may be able to empty the stomach or rumen). Affected animals should not be handled any more than necessary, since stress will worsen the signs.

SAFETY IN PREPARED FEEDS: Larkspur remains toxic when dry, therefore hay and other prepared feeds will be toxic.

PREVENTION: Do not let animals (especially cattle) graze larkspur, particularly during the early growth and seed stages. Keeping pastures mowed will greatly reduce the number of larkspur plants.

INDEX



6. LUPINE, BLUEBONNET, QUAKER-BONNETS

Lupinus perennis (wild)

Lupinus polyphyllus (cultivated)

(pea family)

TOXICITY RATING: Low to moderate in Indiana. In the western rangelands, where lupine grows plentifully, the risk of toxicosis would be high. Different species of lupine have different toxicities. According to reports, *L. leucophyllus* (velvet or wooly-leaved lupine) is the most toxic and should never be grazed since all stages of plant growth are toxic.

ANIMALS AFFECTED: Sheep are primarily affected, but all animals are susceptible.

DANGEROUS PARTS OF PLANT: All parts, especially pods with seeds.

CLASS OF SIGNS: Breathing problems, behavioral changes, trembling, birth defects, coma, death.

PLANT DESCRIPTION: Lupines (fig. 6) are herbaceous perennials grown in gardens or found wild along roadsides, in fields, and in open woods. Wild lupines are common only in the prairie and lake counties of Indiana. In the rangelands of the West, they are a leading cause of livestock poisoning. Several stems often grow from one creeping root and reach 12 to 30 inches in height. The leaves are alternate and pal-

mately compound with 7 to 11 spear-tip-shaped, softly hairy segments. Elongate spikes of blue, purple, white, magenta, or bicolored pea-like flowers in early summer are followed by 1- to 2-inch, fuzzy, pea-like pods.

SIGNS: Toxicity in lupine is believed to result primarily from the alkaloid D-lupanine. The signs of lupine poisoning can develop within an hour or may take as long as a day. The signs are related

to the nervous system and resemble the signs seen with excessive consumption of nicotine (tobacco): twitching, nervousness, depression, difficulty in moving and breathing, and loss of muscular control. If large quantities were consumed, convulsions, coma, and death by respiratory paralysis may occur. In cows that graze lupine, skeletal birth defects in calves can occur, and the syndrome is called "crooked calf".

FIRST AID: There is no antidote. Allow affected livestock to rest quietly, especially if they are unfamiliar with human contact. Handling, trailering, or other stress on the animals after they have been grazing lupine will make the signs worse and can increase losses.

SAFETY IN PREPARED FEEDS: The alkaloids in lupine remain after the plants have dried, so prepared feeds are unsafe for consumption, especially if the feeds contain lupine seed pods.

PREVENTION: Do not allow hungry animals access to lupine, particularly when in the seed stage, if other forage is not available. If lupines are prevalent in the pasture, become familiar with the particular species, since toxicities vary. Do not handle, process, or ship animals that are heavily grazing lupine since this type of stress will increase the number of animals that will become sick and/or die. Livestock can graze lupine without incident as long as excessive ingestion is avoided and animals are not handled or trailered while on lupine pastures (and if the animals are not pregnant). In cattle, to avoid birth defects, do not allow grazing between days 40 and 70 of gestation.

INDEX



50. Red Maple

Acer rubrum

(maple family)

TOXICITY RATING: High, death is common.

ANIMALS AFFECTED: Horses only.

DANGEROUS PARTS OF PLANT: Leaves, especially when fallen, damaged, or wilted.

CLASS OF SYMPTOMS: Breathing difficulties, jaundice, dark brown urine, death.

PLANT DESCRIPTION: Red maple is a tree of medium size, occurring naturally or planted as an ornamental. Young bark is a smooth gray color, older bark is dark and broken. Leaves are 3 to 5 lobed, with shallow notches between lobes. Underside of leaves are white. Leaves are green during the growing season and turn red in the fall. Buds, twigs, flowers, and petioles are red. The sap is not milky.

SIGNS: The toxin has not been identified, but is believed to be an oxidant due to its effects on red blood cells. Only horses are known to be affected. The ingestion of wilted or fallen leaves causes massive destruction of red blood cells, and the blood can no longer carry sufficient oxygen. Ingestion of 1.5 pounds of leaves is toxic, and ingestion of 3 pounds is lethal. Wilted or dry leaves remain toxic for about a month. Fresh and undamaged leaves have not been implicated, but ingestion is still not advised. Clinical signs develop within one or two days and can include depression, lethargy, increased rate and depth of breathing, increased heart rate, jaundice, dark brown urine, coma, and death. Approximately 50% to 75% of affected horses die or are euthanized.

FIRST AID: The first step is to prevent further consumption by the horse (and any other horses on the same pasture). There is no specific treatment, and contacting a veterinarian is advised. The veterinarian may use methylene blue, but this is not often effective in horses, but can be tried early in the course of the disorder. Treatment is symptomatic and supportive and can include mineral oil and activated charcoal to prevent further absorption in the stomach, oxygen, fluid support, and blood transfusions.

SAFETY IN PREPARED FEEDS: Reports are lacking, but red maple should not be considered safe in hay, especially if it is freshly baled.

PREVENTION: Do not allow horses access to red maple. Most poisoning occur in the late summer and fall when leaves fall into pastures, or at any time when fallen limbs are placed in pastures. Apparently the leaves are palatable, thus increasing the risk of toxicosis. Do not incorporate red maple leaves into hay bales.

INDEX



35. HEMP, MARIJUANA, HASHISH, HASH

Cannabis sativa

(nettle family)

TOXICITY RATING: Low. Animals tend to avoid this plant, and toxic encounters are rarely fatal.

ANIMALS AFFECTED: All animals, pets as well as horses and livestock, may be affected.

DANGEROUS PARTS OF PLANT: Leaves, stems, flowers, seeds.

CLASS OF SIGNS: Behavioral changes, trembling, incoordination, gastrointestinal signs, sometime breathing difficulty.

PLANT DESCRIPTION: This coarse, roughly hairy, herbaceous annual, at least 3 to 6 feet tall, has opposite leaves on the lower part of the plant, alternate leaves above (fig. 35). The leaves are made up of from 3 to 7 coarsely-saw-toothed, rough-to-the-touch, long, narrow leaflets borne in a finger-like arrangement. Male and female flowers are found on separate plants, the male flowers on branch tips and the female along the length of the branches. Hemp may be found in weedy pastures, fence rows, brushy stream banks, and illicit plantings.

SIGNS: Nearly all animals will voluntarily avoid marijuana. Toxic cases are usually encountered when the plant is mixed in prepared feeds or bedding materials, or if the animal is forced into consuming or inhaling smoke from the plant. Signs can include nervousness and disorientation which can progress to depression, trembling, vomiting (in those species that can vomit), and sometimes diarrhea and breathing difficulties. Fatalities are rare. Animals more likely to be poisoned are pets (especially dogs and birds), and perhaps swine, but all species are susceptible.

The primary toxic component is tetrahydrocannabinol, a resin. In addition, alkaloids and glycosides are present in marijuana. Toxicity varies greatly in the plants. The top leaves and flower buds of the female plants contain the highest toxin concentration, with the rest of the plant as well

as male plants being toxic to a lesser degree.

FIRST AID: In nearly all cases, effects will wear off within a few hours with little or no permanent damage done. In cases of massive (or malicious) poisoning, contact a veterinarian as soon as possible. Emergency evacuation of the gastrointestinal tract may be necessary with followup supportive care. In cases where an animal (most often a dog) has consumed marijuana in baked goods (typically brownies), chocolate toxicosis may be additive to marijuana toxicosis. A veterinarian needs to be contacted in both cases of toxicoses.

SAFETY IN PREPARED FEEDS: Marijuana remains toxic when dried, therefore prepared feeds will still be toxic.

PREVENTION: Do not allow animals to have contact with the plant or any "preparations" where it might be contained and do not allow malicious intoxication.

INDEX

26. MILKWEEDS

Asclepias spp.

(milkweed family)

TOXICITY RATING: Low to moderate. Milkweeds are unpalatable, and have variable toxicities. Death is not likely unless large quantities are consumed.

ANIMALS AFFECTED: All animals may be affected. Sheep are most at risk, but cattle, goats, horses, poultry, and pets are also at risk.

DANGEROUS PARTS OF PLANT: Stems, leaves, roots.

CLASS OF SIGNS: Gastrointestinal irritation (primarily vomiting and diarrhea), incoordination, tremors, heart problems, respiratory difficulty, death.

PLANT DESCRIPTION: Milkweeds, such as common milkweed, *Asclepias syriaca* (fig. 26), get their name from the thick, sticky, milky sap that oozes out of cut or torn leaves, stems, and fresh pods. The usually solitary stems of milkweed grow 1 to 5 feet tall and bear opposite (sometimes whorled), sometimes fleshy leaves with entire margins. Flowers emerge in umbrella-like clusters and range in color from pink to rose-purple to orange or white. The fruit (fig. 26A) is a pod with "tufted" seeds. A dozen species of milkweeds grow in Indiana woods and swamps, but most commonly in dry soils of fields and road-

sides. Dogbanes (*Apocynum* spp.), which are easily confused with milkweeds, are found in the same habitats and may cause similar poisoning.

SIGNS: There are several different types of milkweeds with varying degrees of toxicity, with the whorled milkweeds being the most toxic. Milkweed plants are considered unpalatable and are eaten only when other forages are not available, and may also be found in hay and processed feeds. The primary toxicants are cardiac glycosides that cause gastrointestinal, cardiac and respiratory

problems and can cause death if enough is consumed. Resins (especially galitoxin) in the milky sap may also contribute to the toxicity of milkweed. In ruminants, the first signs are incoordination, muscle tremors and spasms, bloat, increased heart rate, breathing problems, and occasionally death. Horses are very reluctant to eat this plant, and its toxicity is only rarely reported: colic, diarrhea, abnormal heart rate and rhythm, rarely death. In animals that are capable of vomiting (pigs, dogs, cats, humans), this is the first sign to develop and is beneficial in that further absorption of the toxin is lessened. Horses cannot vomit, and vomiting is not generally observable in ruminants (if vomiting occurs, the contents still remain in the rumen), therefore toxic signs will be worse in these species.

FIRST AID: There is no antidote if an animal consumes milkweed. It is important to limit further ingestion of the plants or contaminated feed. If the animal recently consumed a large amount of the plant, a veterinarian should be called so that the gastrointestinal tract can be emptied and supportive care provided. Small tastes of the plants tend to result in minor oral irritation, and serve as a deterrent to further consumption, and these little nibbles typically do not require treatment.

SAFETY IN PREPARED FEEDS: Milkweed is toxic both fresh and dried, therefore hay, silage, green chop, and processed feeds that contain milkweed are never safe for consumption.

PREVENTION: Animals will avoid milkweed as long as there is sufficient forage available. Care must be taken to avoid incorporation of milkweed into prepared feeds and hay, and these feeds should be discarded.

INDEX



34. MUSTARD FAMILY

Brassica (wild mustard)

Thlaspi (pennycress)

Lepidium (peppergrass), etc.

TOXICITY RATING: Low to moderate.

ANIMALS AFFECTED: Cattle, horses, sheep, poultry.

DANGEROUS PARTS OF PLANT: All parts, especially seeds.

CLASS OF SIGNS: Oral and gastrointestinal irritation, photosensitivity, breathing difficulty.

PLANT DESCRIPTION: Mustard family members have a pungent, sulfurous odor or taste. They may be annual, perennial, or biennial, with a basal cluster of leaves and alternate leaves on the stem that are usually smaller and shorter-stalked than the basal leaves. Flowers of most mustard species are yellow, but some are white, blue, or purple, and all have four petals in a cross-like arrangement (fig. 34A). The seedpod (silique) is dry and may be broad and flat (fig. 34B) or skinny and much longer than it is wide (fig. 34C). The mustard family includes weeds such as yellow rocket, black mustard (fig. 34), tansy mustard, peppergrass, and pennycress. These are found in fields, pastures, lawns, roadsides, waste areas, and sometimes in woods. Cultivated

mustards, which may be harmful if eaten in large quantities, include cabbage, rape, broccoli, turnip, rutabaga, horseradish, and radish.

SIGNS: Mustard plants are capable of causing several types of problems. The most common is oral and gastrointestinal irritation primarily the result of the isoallyl thiocyanates and irritant oils. The plants are not palatable and tend to be avoided unless there is little else to eat or if the seeds have been incorporated into processed feeds. Clinical signs could include oral irritation, head shaking, salivating, colic, abdominal pain, vomiting (in those species capable of vomiting), and possibly diarrhea. Swine and younger animals (lambs and calves) appear to be more susceptible to the irritant effects of mustard seeds in processed feeds. In order to cause toxicity, fairly large amounts need to be consumed over a period of time.

Mustard plants can cause other problems, although these are not reported as often. Photosensitization has been reported in cattle after rape (*B. napus*) was consumed. There are also reports of abortions, goiter and blindness due to mustard consumption, but these are not major problems. Mustard plants may accumulate nitrates under certain fertilization conditions, and thus cause nitrate toxicosis.

FIRST AID: There is no antidote for mustard poisoning. Supportive care and providing adequate quality forage is necessary. For more serious signs, or if animals do not recover when mustard feed is withdrawn, consult a veterinarian.

SAFETY IN PREPARED FEEDS: Mustard plants retain their toxic components upon drying. The seeds in particular contain a high concentration of toxins, and may be incorporated into grain mixes or hay. Care must be taken to insure that these plants and seeds do not contaminate feeds, since they are toxic in any quantity. If small amounts have been incorporated into hay, animals are likely to voluntarily avoid the plants. However, if the hay is highly contaminated and there is no other forage available, the animals will eat the mustard out of necessity and suffer toxic signs as a result. Therefore, avoid feeding mustard, but if this is not entirely possible, provide for additional and more nutritious forage.

PREVENTION: Do not feed hay or other feeds that contain mustard plants or seeds. Do not let animals onto pastures that are overgrown with mustard plants without providing adequate edible forage. Use caution when feeding animals (especially swine) crop harvest leftovers from plants in the mustard family.

INDEX



31. STINGING NETTLE WOOD (BULL) NETTLE

Urtica dioica *Laportea canadensis*

(nettle family)

TOXICITY RATING: Low. Local irritation is the most common sign which shortly resolves on its own.

ANIMALS AFFECTED: Any animal that brushes against or consumes the plant can be affected. Short-haired hunting dogs and other dogs that run through the underbrush are more likely to encounter this plant.

DANGEROUS PARTS OF PLANT: Stems, leaves.

CLASS OF SIGNS: Facial, skin and oral irritation, salivation, pawing at the mouth, possible ocular irritation.

PLANT DESCRIPTION: These herbaceous perennials are common on moist ground in flood plains, woodlands, and along stream and river banks. They often occur in colonies so large that they are the only herbaceous plant present. The tough unbranched stems grow 2 to 5 feet tall from fibrous roots and are covered with stinging bristles. The leaves are opposite, thin, egg-shaped, toothed, and tapered at the tip. They measure 2 to 6 inches by 1 to 2 inches in stinging nettle and 3 to 8 inches by 3 to 5 inches in wood nettle. The 3 to 5 main veins from the base make the leaf (especially in wood nettle) strongly resemble the leaves of white snakeroot. However, the stinging hairs on the lower surface of the leaves prove the plant's identity. The tiny, green or greenish-white flowers droop in axillary clusters in stinging nettle (fig. 31) and stand upright in branching clusters at the top of the stem in wood nettles.

SIGNS: The small, hollow hairs in stinging nettle contain several irritating substances such as histamine (the mediator of some allergic reactions), serotonin, acetylcholine and formic acid (ants

contain a high concentration of formic acid). These substances, coupled with the hairs ability to scratch the skin and mucus membranes, results in almost immediate burning, itching and irritation. Typically, signs are present for a few minutes to a few hours, and resolve on their own. If oral contact was made, the animal may shake its head, salivate, and rub its mouth. Skin irritation is possible, especially with short-coated dogs, and ocular (eye) irritation is also possible. It is possible that the animals attempts to comfort itself and relieve the irritation may cause more damage than the plant itself. On very rare occasions (and only after significant amounts were consumed or contacted) will more severe systemic signs manifest (trembling, weakness, disturbances in heart rate). Nearly all animals (including humans) learn to stay away from nettle.

FIRST AID: Limit further exposure as much as possible. Remove affected animals from the areas where the plants are located, and monitor the animals so they don't self-traumatize. Recovery should occur within a few minutes to hours. If animals continue to have difficulty, or if more serious signs develop, or at any time if the eyes are affected, contact a veterinarian.

SAFETY IN PREPARED FEEDS: There is little information on the safety of nettle in feeds. However, due to its irritant potential, inclusion of this plant into hay or feeds is not recommended.

PREVENTION: Use caution in marshy or wooded areas where dense stands of nettle may be located. Prevent animals from contacting the plants as much as possible.

INDEX



42. BLACK NIGHTSHADE

Solanum nigrum

CAROLINA HORSENETTLE, BULL NETTLE

Solanum carolinense

BITTER NIGHTSHADE, CLIMBING BITTERSWEET

Solanum dulcamara

(nightshade family)

TOXICITY RATING: Moderate. While the plant itself is very toxic, it is also unpalatable, and rarely does an animal consume enough to cause a serious or potentially lethal poisoning. Toxic risk is higher if the plant is included in processed feeds.

ANIMALS AFFECTED: All animals, including pets, may be affected.

DANGEROUS PARTS OF PLANT: All parts are potentially toxic, the berries are often higher in toxicity.

CLASS OF SIGNS: The nightshade plants cause problems with the gastrointestinal tract and can also affect the central nervous system. Signs can include abdominal pain, vomiting, diarrhea, incoordination, weakness, depression, apparent hallucinations, convulsions, and possible death.

PLANT DESCRIPTION: Black nightshade is a low-branching annual (fig. 42A), 1 to 2 feet tall with triangular stems that bear oval, thin-textured, alternate leaves with wavy margins. The tiny white flowers, borne in drooping clusters on lateral stalks between the leaves, resemble tomato flowers. The berry fruit is green when immature, purplish-black when ripe. Bitter nightshade

resembles black nightshade except that the stems are climbing, the lower leaves are lobed at the base, the flowers are purple, and the ripe fruit is red. Horsenettles (fig. 42B) are similar but have coarser, prickly stems, larger white to purplish flowers in loose clusters, and yellow fruits that look much like small tomatoes. All three species commonly grow in open woods, old fields, waste areas, pastures, along roadsides, and around farm buildings.

SIGNS: Clinical signs of poisoning in the nightshade family tend to reflect gastrointestinal irritation and/or effects on the central nervous system. The plant is not palatable and is eaten only when animals have no other forage available. The plant may be a contaminant in hay, where it will still cause toxicity. Pets may eat the green, red, or black berries and be poisoned. The major toxin is solanine, an alkaloidal glycoside, and along with other glycosides and atropine have numerous and powerful effects on the body.

Gastrointestinal signs can include: vomiting (in those species that can vomit), poor appetite, abdominal pain, and diarrhea which may become bloody. Central nervous system signs can include depression, difficulty breathing, incoordination, weakness, collapse, convulsions, and possible death. In one report, one to ten pounds of plant material was potentially lethal for a horse.

A chronic toxicity has also been reported, where the animal eats small amounts of the plants each day. These animals tend to present with general unthriftiness, depression, and diarrhea or constipation.

FIRST AID: If a large amount of nightshade plant was consumed, contact a veterinarian immediately, since emergency measures may need to be undertaken. In most cases the animals will avoid eating this plant, so clinical cases are rare. Curious or bored pets are particularly at risk, and a veterinarian should be contacted if these animals are seen eating a nightshade plant. Treatment is largely symptomatic until the clinical signs wear off (which can take a day or two, sometimes longer). Death is rare in animals, but has occurred in people who have abused these plants.

SAFETY IN PREPARED FEEDS: The nightshade plants lose some toxicity with drying, but the toxin is not eliminated. Therefore, feeds containing nightshade are not considered to be safe. If there are just a few plants in hay bales, the animals may voluntarily avoid the nightshade if provided with enough nutritious and safe hay. In the case of hay then, careful observation to see that the nightshades are being left may make it allowable to feed the rest of the affected bales. If the feed is more highly processed (silage, chop, pellets), the feed is not safe at all since the animals will not be able to avoid the nightshade plants.

PREVENTION: Nearly all grazing animals will avoid eating plants in the nightshade family unless they are extremely hungry and there is little else to eat. The exception to this is if nightshade plants are incorporated into prepared feeds and the animals eat them unknowingly, therefore only feed quality feeds and only purchase from reputable dealers. Pets may be attracted to and eat the berries, so always keep pets away from nightshade plants, especially if the pet is confined, bored or unattended.

NOTE: Other *Solanum* species contain the same poisonous principle. These include buffalobur (*Solanum cornutum*), the ornamental Jerusalem cherry (*Solanum pseudocapsicum*), and the common white potato (*Solanum tuberosum*). Sprouts and sunburned (green) or spoiled potato

42. BLACK NIGHTSHADE

tubers should not be mixed in feed because they also contain solanine. Vines of tomatoes (*Lycopersicon esculentum*, nightshade family) contain similar glycoalkaloids. Toxicity is also related to that seen with Jimsonweed.

INDEX

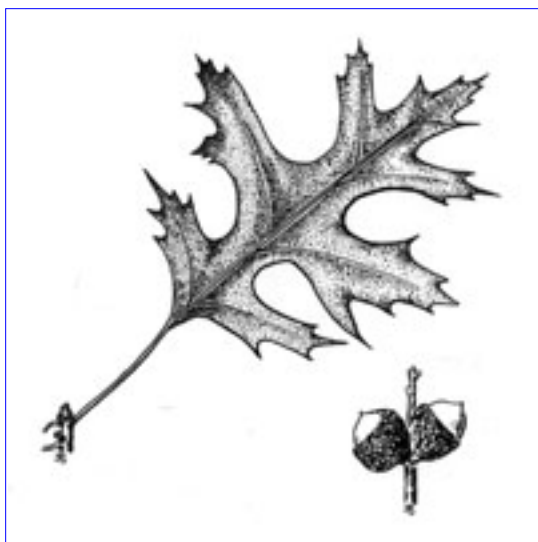

47. RED OAK

Quercus rubra

(beech family)

TOXICITY RATING: Moderate high.

ANIMALS AFFECTED: All animals may potentially be affected, but the primary risk is to cattle.

DANGEROUS PARTS OF PLANT: Buds (fall), young shoots (early spring), sprouts, acorns.

CLASS OF SIGNS: Poor doer, poor appetite, weight loss, diarrhea or constipation, increased drinking, increased urination, edema, death is possible.

PLANT DESCRIPTION: Oaks are trees with leaves that turn brown but hang on through the winter. In the southwestern U.S., Gambel's oak, shinnery oak, and post oak frequently cause poisonings. In our part of the country, red oak has produced problems. Red oak is a large tree of well-drained woodlands, parks, and home plantings that bears broad-bladed leaves with deep lobes ending in bristle-tips (fig. 47). The

fruit is the familiar nut borne in a scaly cup and called an acorn (fig. 47A).

SIGNS: This discussion refers primarily to cattle, the species most often affected by oak toxicosis.

It also seems that cattle less than 2 years of age succumb to oak toxicosis more than do older animals, however older animals are still at risk. Other species at risk include sheep and possibly deer. Goats and swine are more resistant to poisoning, and horses are rarely affected (likely due to a unwillingness to consume oak). Pets rarely consume sufficient quantities to do harm. Many species of oak have been implicated in the poisoning of livestock, with red and black oak exhibiting greater toxicity than white oak.

While short-term acute poisoning by oak has been reported, the most commonly encountered oak poisoning is of a chronic nature. Oak is most dangerous early in the spring when the leaves and buds are the highest in toxicity and when there is little else to eat. The fall is another at risk period, when acorns and leaves fall and better forage dies back. Therefore, management plays a key role in preventing oak toxicosis.

The toxins in oak are called gallotoxins and are converted in the body to tannic acid, gallic acid and pyrogallol, all of which are very toxic to the kidney. It is the resulting kidney failure that causes the clinical signs. Typically, a significant amount of oak needs to be consumed over a period of time before clinical signs appear. Signs can develop over 2 to 14 days, or signs may be present with the animals becoming progressively worse over many weeks. The number of animals affected in the herd can vary greatly, but of those showing clinical signs, up to 80% may die. Signs of oak poisoning can include depression, lack of appetite, a gaunt and emaciated appearance, poor or rough hair coat, dependent edema (fluid buildup under the skin under the neck, abdomen or on the legs), digestive disturbances (both diarrhea and constipation have been reported, with mucus covered or tarry stools), increased drinking, passage of copious amounts of urine which may contain blood, and death.

FIRST AID: The most important step is to get the animals back on to plentiful and nutritious feed, and to limit stress, shipping and handling during the recovery period. Also, make sure that plenty of fresh water is always available, since affected cattle cannot maintain their own water balance very well while recovering. Since this is a long-term chronic toxicity, there is little in the way of an antidote to relieve signs. Severely or more chronically affected animals may not recover, but the less affected animals may, and may return to previous rates of gain and milk production. A veterinarian will be able to assist in management, and will be able to assist in emergency measures if large amounts of oak were recently consumed. Beyond this, treatment is supportive and symptomatic.

SAFETY IN PREPARED FEEDS: The toxin in oak remains when dry, so no feeds are safe that contain oak.

PREVENTION: Oak toxicosis is easily preventable with proper livestock and pasture management. Animals tend to eat oak only out of necessity, therefore by providing adequate and nutritious feed in the spring when the oak leaves bud out and again in the fall when leaves and acorns drop, the incidence of toxicosis should be minimized or eliminated.

INDEX

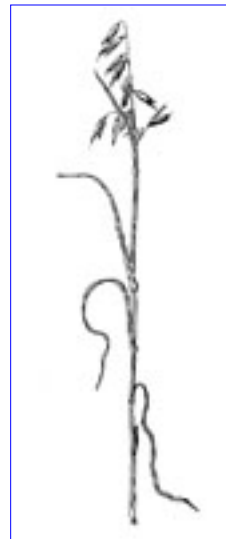

13. CULTIVATED OATS

Avena sativa

(grass family)

TOXICITY RATING: Moderate.

ANIMALS AFFECTED: Cattle, swine, sheep, goats, poultry, horses.

DANGEROUS PARTS OF PLANT: All parts.

CLASS OF SIGNS: Breathing difficulty, skin irritation, paralysis, convulsions, death (rarely).

PLANT DESCRIPTION: This widely cultivated annual grass has escaped into waste places. The plants grow up together in small tufts. The fruiting structure is a terminal, loose panicle (fig. 13).

SIGNS: Oats may cause up to three separate problems, depending upon the conditions:

a) Oats can accumulate excessive amounts of nitrates, especially when heavily fertilized. Many grasses and forages can accumulate toxic levels of nitrates depending upon fertilization practices. This is a serious problem, especially in cattle. The signs are then consistent with nitrate toxicosis: the blood turns a brownish color due to the action of nitrate on hemoglobin. The blood is not capable of carrying oxygen efficiently, and animals show signs of hypoxia: increased respiratory rate, anxiety, collapse, convulsions, and death. Nitrate toxicosis is less often reported in non-ruminants (horses, swine, etc), but can occur. The primary signs in these species is stomach and intestinal irritation, although an inability of the blood to carry oxygen may develop and require treatment.

b) Oats can also induce a photosensitivity reaction in animals, although the exact mechanism (direct contact and/or ingestion) is uncertain. The skin becomes increasingly susceptible to damage by ultraviolet radiation, and the typical presentation in affected animals is sunburn on the lightly

pigmented parts of the body. Both fresh oats and oat straw can cause a skin reaction.

c) Moldy oats (called smutty oats), which result from the improper curing or storing of oat hay, can cause paralysis, convulsions or death if sufficient quantities are ingested.

FIRST AID: In all three cases of possible toxicoses, the first and most important step is to remove the oats from the animals.

a) For nitrate toxicosis, it is best to call a veterinarian, especially when cattle or other ruminants are affected. There are emergency measures that can be performed, but severely affected animals still may die. Horses, swine, and poultry are less likely to be affected, but if clinical signs develop, they may require treatment as well, although it may be impractical to attempt treatment on swine or poultry.

b) For photosensitization, allow the animal access to shade. The animal may need shade for a week or two until the sunburned areas heal. Animals on pasture can be turned out at night and stabled during the day. Remove oat straw if used for bedding. The sunburn may be severe enough to prevent normal function, such as seeing, eating, walking, allowing young ones to nurse, etc. In these cases, a veterinarian needs to be called to provide supportive care until the lesions heal. In addition, a veterinarian needs to be called if the sunburned areas are extensive or if they appear infected, or if the animal is depressed and unwilling to eat.

c) For moldy oats, discard affected feed and provide proper forage. If clinical signs develop, call a veterinarian.

SAFETY IN PREPARED FEEDS: Ideally, oat hay with excessive levels of nitrate should not be fed. If feeding this hay cannot be avoided, the animals should receive a well-balanced and adequate diet, since these animal will be less likely to show toxic signs. Nitrate contaminated feed should only make up a small portion of the total ration. Since the cause of oat photosensitivity is unknown, consumption of oat hay or grass may induce the clinical syndrome. Moldy oats are not safe for consumption and should be discarded.

PREVENTION: Ideally, the oat feed should be discarded. If this is impossible, know that properly fed cattle can consume forages higher in nitrate than can poorly fed cattle, therefore, feed cattle an adequate and balanced diet, especially if high nitrate forages are to be included in the diet. Do not over-fertilize oats or any grass forage, to reduce the likelihood of this common toxicosis. Photosensitive individuals may need to have oats permanently removed from their diet. Moldy oats should never be fed.

INDEX

52. Oleander

Nerium oleander

Apocynaceae (Dogbane family)

TOXICITY RATING: High. Ingestion of even small amounts can kill.**ANIMALS AFFECTED:** All animals can be affected.**DANGEROUS PARTS OF PLANT:** The entire plant is toxic. Most animals are poisoned by consuming leaves, fresh or dried.**CLASS OF SIGNS:** Gastrointestinal irritation, cardiac abnormalities, death (may be sudden).**PLANT DESCRIPTION:** This plant grows outdoors in warmer regions, and in Indiana is grown as a houseplant. Oleander grows as a shrub or sometimes to the size of a small tree. The leaves are lance-shaped, thick and leathery, and grow opposite each other. Sometimes, leaves may grow in whorls. The leaves are 8 to 10 inches long, although smaller specimens will have shorter leaves. Flowers are showy, approximately 1 to 3 inches in diameter, and grow in large clusters at the ends of the branches, and can be white or any shade of pink or red.**SIGNS:** Oleander contains the toxins oleandrin and nerioside, which very similar to the toxins in foxglove (*Digitalis*). This is a tropical plant, but is grown as an ornamental and as a houseplant in Indiana. Apparently the plant is not palatable, but will be eaten by hungry animals. It is reported that dried or wilted leaves may be slightly more palatable than fresh leaves, and the leaves are still toxic when wilted or dried. In one report with horses, it was indicated that approximately 1/4 pound of leaves (about 30 or 40 leaves) could deliver a lethal dose to an adult horse.

Clinical signs may develop rapidly, and the animal may be found dead with no prior warning. In other cases, depression coupled with gastrointestinal distress is evident: vomiting (in those species that can vomit), diarrhea (which may be bloody), and abdominal pain. Irregularities in the heart

rate and rhythm will occur: the heart may speed up or slow down, and beat erratically. As the toxicosis progresses, the extremities may become cold and the mucous membranes pale. Trembling and collapse can occur, followed by coma and death within a few hours.

FIRST AID: If animals are observed eating oleander, contact a veterinarian immediately. The toxin acts quickly, and is lethal in small amounts. Emergency measures may be used to empty the gastrointestinal tract of remaining plant matter, and medications may be administered to control the effects that the toxin has on the heart. Despite emergency care, the animal may still die, but the sooner treatment is begun, the better the prognosis for survival.

SAFETY IN PREPARED FEEDS: Oleander is extremely toxic, even in small quantities, and the toxin is not eliminated by drying. Therefore, feeds containing oleander are never safe for consumption.

PREVENTION: Be able to identify oleander and exercise extreme caution when pets (and humans) are in the vicinity of these plants. The plants should never be placed where animals can have contact with them. Extra care needs to be taken in cases where leaves can fall into a pasture or in the vicinity of a confined, bored or hungry animal.

INDEX



33. REDROOT PIGWEED

Amaranthus retroflexus

(pigweed family)

TOXICITY RATING: High. The plant is quite common and very toxic.

ANIMALS AFFECTED: Cattle and swine are the animals most likely to be affected; goats and sheep can also be poisoned.

DANGEROUS PARTS OF PLANT: Leaves, stems, roots.

CLASS OF SIGNS: Breathing problems, trembling, weakness, abortions, coma, death.

PLANT DESCRIPTION: Redroot pigweed (fig. 33) is a large (to 5 feet tall), coarse, annual with red stems and simple, egg-shaped, wavy-margined, alternate leaves. The green, inconspicuous flowers are borne in short, compact clusters along with green spines. Seeds are small, shiny, and black. Fields, barnyards, and waste areas are the favorite habitats of this weed.

SIGNS: Pigweed contains a nephrotoxin that causes kidney failure, and also contains soluble oxalates and is capable of accumulating nitrates. Therefore, toxicity can be due to any combination of these toxicoses.

Animals need to consume pigweed in fairly significant quantities over several days before signs appear. Typically, onset of signs is 3 to 7 days from the onset of ingestion. Animals will usually avoid pigweed if there are better forages available. Common incidences of poisonings have occurred when swine have been raised in confinement and are then turned out into a pigweed-infested pasture in the late summer to early fall. Under these circumstances, the swine consume large amounts of the plant quickly, with 5-90% of the animals becoming affected, with 75% or greater mortality among the affected animals. Modern management practices have largely eliminated this type of poisoning, but it can still occur. In cattle, pigweed toxicosis resembles oak toxicosis.

In affected animals, early signs include weakness, trembling and incoordination. This progresses to an inability to stand and paralysis, yet the animals may still be alert and able to eat. Near the end of the clinical course, the affected animals may go into a coma, and have edema under the skin of the abdomen and the legs, have a bloated abdomen, and die. The course of the disease is approximately 48 hours and is primarily consistent with kidney failure. Cases where animals consume smaller amounts of plants over long time periods have not been well studied, but this is also believed to cause toxicology problems.

Treatment with herbicides may render pigweed even more palatable, therefore make sure all treated plants are dead prior to introducing animals.

FIRST AID: If pigweed is being rapidly consumed, limit further access and ingestion of the plants. A veterinarian will be able to provide supportive care for the different toxicants contained in pigweed, but the animals may still succumb to the nitrates, soluble oxalates or the kidney toxin.

SAFETY IN PREPARED FEEDS: Pigweed is not safe in hay or other prepared feeds.

PREVENTION: To prevent pigweed poisoning, do not allow animals to have access to affected pastures, especially if the animals are hungry. Spray or mow plants down, making sure they are dead before animals are on pasture. Provide for supplemental feed if pasture quality is poor, since well-fed animals are less likely to consume pigweed.

INDEX



40. COMMON POKEWEED, POKEBERRY, POKEROOT, INKBERRY, POKE

Phytolacca americana

(pokeweed family)

TOXICITY RATING: Low.

ANIMALS AFFECTED: All animals may potentially be affected.

DANGEROUS PARTS OF PLANT: All parts, especially roots and seeds.

CLASS OF SIGNS: Gastrointestinal irritation (colic, diarrhea which may be bloody). Rarely: anemia, possibly death. Birth defects and tumors may also be possible.

PLANT DESCRIPTION: Pokeweed (fig. 40) is a tall (to 10 feet), smooth-stemmed, perennial herb with a large, fleshy taproot (fig. 40A). Stems are succulent, purplish, and bear alternate, lance-shaped, shiny leaves with smooth, curled margins. The small, white to greenish flowers hang in long, drooping, grape-like clusters. Each flattened, spherical, green berry turns dark-purple or ink-black and usually contains 10 seeds. Pokeweed commonly grows on recently cleared land, in open woods, barnyards, pastures, fence rows, and roadsides.

SIGNS: Animals do not voluntarily eat this plant unless there is no other forage available. If the animals are forced to eat pokeweed (especially if it has been incorporated into processed feeds), the primary signs relate to the irritant effects of the saponin toxins, in particular phytolaccigenin. Salivation, abdominal pain, diarrhea (which may become bloody) can be noted. Horses and ruminants do not exhibit vomiting, which is seen in humans, dogs, cats, and pigs. Signs usually resolve within a day or two. Only if large doses are consumed will the animal display more serious signs: anemia, alterations in the heart rate and in respiration, and in very rare cases, death.

Noted in the human literature but not well published in the veterinary literature is the mutagenic and teratogenic properties of pokeweed, that is the ability to induce mutations (and possibly

cancer) and birth defects. For humans, even handling the plant is considered dangerous, so it would seem wise to not only prevent human contact with the plant, but animal contact as well. Despite this, the plant is eaten as a spring vegetable in the southern U.S. after cooking it first in several changes of water. Consumption of the plant is not advised.

FIRST AID: For gastrointestinal irritation, provide better feed and symptomatic care, and signs should abate in about 24 hours. Discard all feeds containing pokeweed, since the plant is never safe for consumption. For severely affected animals, or if it is known that a large amount was consumed, consult a veterinarian promptly for emergency care.

SAFETY IN PREPARED FEEDS: Reports are not clear, but consider pokeweed as unsafe in hay and other feeds.

PREVENTION: Pokeweed should be removed from pastures and barnyards. Exercise caution when doing so, since the plant is toxic to humans as well. Good pasture management, with mowing and weed removal, will suffice in keeping pokeweed under control.

INDEX



24. GROUNDSEL, RAGWORT

Senecio spp.

(daisy family)

TOXICITY RATING: High. *Senecio* is very toxic both fresh and in hay, affected animals often die.

ANIMALS AFFECTED: All grazing animals may be affected, but horses and cattle are particularly susceptible. Young, growing animals are more susceptible than mature animals, and fetuses may be affected in utero.

DANGEROUS PARTS OF PLANT: All above ground parts, with higher concentrations in the seeds.

CLASS OF SIGNS: "Poor doer", weight loss, unthriftiness, poor hair coat, anorexia, behavioral changes, sunscald, liver failure, jaundice, death.

PLANT DESCRIPTION: There are several species of ragworts. In Indiana they are perennial herbs about 1 foot tall (rarely to 3 feet tall). Basal leaves are spoon-shaped and stem leaves are alternate and pinnately cut into narrow segments. At the top of the plant are clusters of yellow composite (daisy-like) flowers with yellow ray petals. Most ragworts grow along roadsides, in pastures, and in wet or waste areas. *Senecio aureus* (golden ragwort) blooms in early spring in woodlands or meadows statewide (fig. 24).

SIGNS: Poisoning from ragwort may be chronic or acute, with the chronic form more commonly encountered. The disease is also called "seneciosis" or "pictou" disease. The toxic principle is a mixture of pyrrolizidine alkaloids which adversely affect the liver. The plant grows in late winter through the spring and tends to be incorporated in first cutting hays. Animals may not show signs

until the fall or winter after eating this hay for some time. In horses especially, the clinical signs may develop months after ragwort hay is no longer being fed, making an accurate diagnosis difficult.

In the rare acute toxic case (20 or more pounds consumed in a short period of time for a horse), the animals may become very excited and violent, with gastrointestinal signs (colic, diarrhea), dilated pupils and increased heart rate, and sudden death. Chronic toxicity is far more likely to be encountered. The animals must consume the plants fresh or in hay for weeks to months before clinical signs appear. The toxin is cumulative, and continues to damage the liver until enough of the liver is affected to cause clinical signs. Approximately 50 to 150 pounds of ragwort needs to be consumed by a horse before signs appear. Cattle are more resistant to the toxic effects than horses and reports have indicated that cattle may be fed small amounts of ragwort hay without ill effects. There are reports that sheep are relatively resistant to this toxin.

In chronic cases, the first clinical signs are weight loss, "poor doer", unthriftiness, and a decreasing appetite. These and all clinical signs are reflective of the gradual loss of liver function. Later, nearly total anorexia, jaundice, behavioral changes (depression, drowsiness, confusion, aimless wandering, "sleepy staggers") and an uncoordinated gait may manifest. Some animals will head press, where the animals lower their head and press it and/or their neck against a sturdy object. Some animals have been noted to stumble over objects and to appear blind. Since the liver is responsible for degrading diet-derived plant pigments, these pigments are not destroyed, and enter into the circulation. The pigments react with light and can cause photosensitization and sunscald, especially to the more lightly pigmented areas. Near the end of the course of the disease, abdominal fluid may build up ("ascites"), and fluid may build up under the skin in the "lower" parts of the body (throat latch, under the abdomen, legs), and the animal may develop diarrhea. Loss of blood's ability to clot (another important liver function) may be present as well, with bruising and hemorrhaging noted (which may occur in the urinary tract and present as red to black colored urine). Just prior to death, the animal may collapse and go into convulsions. Once clinical signs become apparent, the chances that the animal will recover are very unlikely.

In cattle, other signs can be noted in addition to those listed above. The muzzle may become dry and scaly, and animals may strain to defecate, causing the rectum to prolapse. Affected animals will produce milk with an unusual odor. It is not known, but it is suspected, that this milk may be toxic.

FIRST AID: Once clinical signs are present, recovery is less likely. Newer and experimental treatments exist, but the prognosis is poor for survival. Remove all ragwort hay from animals and provide proper feed. A veterinarian may be able to provide some treatment or referral to an animal hospital for care of valuable animals, but even this treatment option has a low rate of success, especially for severely affected animals.

SAFETY IN PREPARED FEEDS: All plants that contain pyrrolizidine alkaloids remain toxic in hay, silage and other feeds. Horses should never be allowed to consume any feed containing ragwort. Ruminant (cattle primarily) may be able to tolerate small amounts of ragwort hay if it is fed intermittently and enough good forage is made available. The recommendation for cattle is that ragwort hay be fed at 10% or less of the body weight over the course of a year. This would amount to 50 pounds per year for a 500 pound animal. If at all possible, the ragwort hay should never be

fed, even to cattle.

PREVENTION: Learn to recognize ragwort both fresh and in hay, and only deal with reputable feed dealers. Never feed ragwort to horses, and it is advisable not to feed it to cattle. If ragwort hay must be fed to cattle, follow the guidelines listed above.

NOTE: Plants that also may cause similar signs due to the presence of pyrrolizidine alkaloids: Stinking willie (*Senecio jacobea*), common groundsel (*S. vulgaris*), fiddleneck and tarweed (*Amsinckia* spp), rattlebox (*Crotalaria*), Hound's tongue (*Cynoglossum officinale*), heliotropium (*Heliotropium* spp) and salivation Jane (*Echium lycopsis*). Ragwort poisoning is a major problem in the western United States and may be increasing in the East. The greatest risk in Indiana seems to be in the southwestern counties where cressleaf groundsel (*Senecio glabellus*) grows. Another species, prairie ragwort (*Senecio plattensis*), occurs in the northern half of the state. Ragwort growing in alfalfa fields has been reported.

INDEX



9. RHUBARB, PIE PLANT

Rheum rhaponticum

(dock family)

TOXICITY RATING: Low, unless animals are fed the leaves intentionally.

ANIMALS AFFECTED: All animals may be affected, those being fed garden trimmings are particularly at risk (cattle, swine, sheep and goats).

CLASS OF SIGNS: Staggering, trembling, breathing difficulties, weakness, diarrhea, increased drinking and urinating, death.

PLANT DESCRIPTION: This herbaceous garden perennial (fig. 9) develops from a heavy rootstock. Its leaves grow from the base of the plant on stout, shiny, red stalks. Heart-shaped and 1 to 2 feet long by 1/2 to 1 1/2 feet wide, the leaf blades have a smooth and shiny surface, darker above, with five main veins and wavy margins. The hollow stems end in greenish-white flower clusters in late spring.

SIGNS: The leaves contain oxalic acid, soluble oxalates, and citric acid, although the stems are edible. Some oxalates are insoluble and cause local irritation but the oxalates in rhubarb (and other species, such as sorrel or dock, *Rumex*) are soluble, and cause systemic problems, especially in the kidneys, or they can affect the electrolytes in the body, such as the balance of calcium and magnesium. Poisoning can be acute, when large amounts of oxalates are consumed quickly, or may be chronic, where smaller amounts are eaten over a longer period of time. Low blood levels of calcium and kidney failure are commonly reported findings in soluble oxalate toxicity.

Affected animals will appear depressed, and may stagger and tremble and be weak. Often, they will drink and urinate more as kidney function declines. Diarrhea may be noted, and affected animals may die if the electrolyte balance is extremely deranged or if the kidneys fail.

FIRST AID: There is no specific antidote for oxalate toxicity. If an animal is observed eating a large quantity of rhubarb or other oxalate plant, call a veterinarian immediately. If the plants were ingested a day or more previously, only supportive care can be given. A veterinarian will be able to provide assistance, although death may result from electrolyte imbalance or from kidney failure.

SAFETY IN PREPARED FEEDS: Rhubarb is not safe in hay, nor is any other oxalate-containing plant.

PREVENTION: Ruminants have some ability to adapt to oxalate plants if they are introduced to them gradually, since the rumen bacteria will detoxify the oxalates to a certain degree, although feeding these plants is never recommended. Do not allow animals to ingest large amounts of oxalate plants quickly, and it is best to not allow the feeding of oxalate plants at all. Do not incorporate weeds or rhubarb leaves into feed for animals, especially ruminants and swine, since these animals are not finicky eaters. Always make sure that animals have sufficient water, since oxalate toxicity is worsened if animals go thirsty.

INDEX

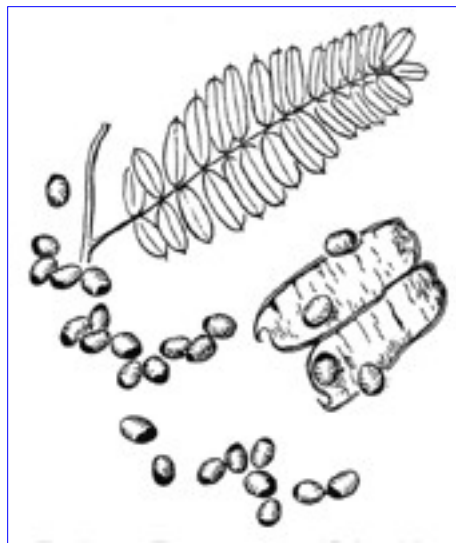

53. Rosary Pea , Precatory beans, crabs eye, jequirity bean

Abrus precatorius

legume or pea family

TOXICITY RATING: High. Even one bean can kill.

ANIMALS AFFECTED: All animals may be affected, although the primary risk is to pets.

DANGEROUS PARTS OF THE PLANT: The beans are the primary risk.

CLASS OF SIGNS: Severe gastrointestinal irritation, vomiting, diarrhea, abdominal pain, collapse, death.

PLANT DESCRIPTION: Twisting perennial vine, grows naturally in tropical climates. Rosary pea is established in certain areas of southern Florida. The leaves are alternate and compound, with 8 to 15 leaflets. The flowers are small, and can be any shade of white to red to purple. The seed pod is about 1 and 1/2 inches long, containing several seeds, bright red with a black spot.

SIGNS: The toxic signs resulting from rosary pea ingestion are very similar to those of castorbean, except rosary pea contains a more powerful toxin. It is reported that one seed if well-chewed can kill an adult human. The toxins are a protein called abrin and a glycoside called abric acid, which cause severe gastrointestinal signs: vomiting (if the species can vomit), diarrhea (which may be

bloody) and abdominal pain. This progresses to weakness, shock and death within a short period of time.

The plant does not grow in Indiana, but sometimes seeds are imported to make jewelry and rosaries. If the seed is swallowed without damage to the seed coat, poisoning is unlikely, and the seed will tend to pass without incident. In cases where the seed coat is chewed or opened (as in drilling to make jewelry), toxic signs and death are likely.

FIRST AID: If rosary pea was ingested, contact a veterinarian immediately. Prevent further exposure and get other animals away from the source. Emergency measures may be used to eliminate the toxin from the stomach and intestines. Once gastrointestinal signs appear, it may be inadvisable to try to evacuate the stomach and intestines for fear of doing even greater damage, but a veterinarian will decide this. Beyond this, care is symptomatic and supportive of the digestive upset, weakness, and shock. Affected animals are likely to die even with care.

SAFETY IN FEEDS: The seed is toxic in feeds, and is never safe at any level of feeding. Discard all feeds if contaminated with rosary pea.

PREVENTION: Rosary pea should never be allowed around the home or pasture for the safety of animals and humans alike. If jewelry or rosaries are made of rosary pea, discard them immediately.

INDEX



22. WHITE SNAKEROOT, WHITE SANICLE, RICHWEED

Eupatorium rugosum

(daisy family)

TOXICITY RATING: High. White snakeroot will be eaten, especially in the late summer and fall, and is often lethal.

ANIMALS AFFECTED: Cattle, horse, goat, sheep, swine. All grazing animals can be affected by white snakeroot, and the toxin passes in the milk, so nursing animals and humans are also at risk.

DANGEROUS PARTS OF PLANT: Leaves and stems, possibly flowers. Roots seem to have a lower toxicity.

CLASS OF SIGNS: Trembling, sweating, depression, stiff gait, heart failure, jaundice, toxic milk, death (may be sudden).

PLANT DESCRIPTION: White snakeroot (fig. 22) grows from fibrous, matted roots as a smooth, erect, perennial herb 1 to 3 feet high with opposite, oval, pointed-tipped leaves with sharply-toothed edges. The upper surfaces of the leaves are dull, the lower surfaces shiny with three prominent main veins. Small white flowers in compound terminal clusters are conspicuous in late summer. White snakeroot is found in woods, damp and shady pastures, and occasionally in thickets and clearings (especially at the edges of wooded areas) in all 92 Indiana counties.

SIGNS: Clinical signs include: depression, stiff gait, periods of sweating, normal or subnormal body temperature, labored or shallow respiration, muscle tremors, trembling, partial throat paralysis, jaundice, passage of hard feces, prostration, death (death may be sudden with no prior signs). Onset of signs is typically 2 days to 3 weeks. Death occurs within 1 day to 3 weeks, with horses typically succumbing in 1 to 3 days. Even if the horse does not die from this toxin, it may suffer permanent heart damage and be unsuitable for work or pleasure purposes. The toxic component is tremetol, and the toxic dose of the green plant is approximately 1% to 10% of the body weight of the animal at one time or over several doses. The toxin is cumulative, so one large

dose or multiple smaller doses over time can kill. The toxin is excreted in the milk, so lactating animals are slower to show signs of toxicity, but the nursing animals will then be affected by the toxin. Humans who drink raw milk from affected animals can also be poisoned, sometimes fatally (the disorder was called "milk sickness" in colonial times).

The primary danger occurs in late summer throughout the fall, especially in overgrazed pastures or where there is insufficient food. Poisonings in early winter where the animals eat stalks that extend above the snow have also been reported. The edges of woods or thickets are common locations for white snakeroot. Dry years are also associated with more reports of toxicity, perhaps due to inadequate pasture forage.

FIRST AID: Supportive care is required, since there is no specific antidote. Many affected animals will die or be permanently disabled. Remove all animals from the pasture or fence off the wooded areas, especially in the fall through winter. Continue to milk lactating animals, and discard milk. A veterinarian will be able to provide supportive care to animals showing signs, but death is likely once clinical signs develop.

SAFETY IN FEEDS: Drying decreases but does not eliminate the toxin, therefore hay with white snakeroot in it is unsafe for consumption.

PREVENTION: Learn to recognize and avoid white snakeroot. Do not allow animals to graze this plant under any circumstance. To do this, fence off wooded areas, provide supplemental feed (especially in the late fall and winter), or treat the snakeroot with herbicides. Be cautioned that treatment with herbicides may make the plant more palatable, so allow several weeks to pass between spraying and allowing animal access (be sure the plants are completely dead). The problem may recur the following year, so plan ahead to avoid animal loss. Under no circumstances should raw milk from affected animals be used for animal or human consumption.

INDEX



37. SPURGES, EUPHORBIA

Euphorbia spp.

(spurge family)

EXAMPLES:

Euphorbia cyparissias, cypress spurge, fields and gardens (fig. 37A)

Euphorbia esula, leafy spurge, noxious weed

Chamaesyce maculata (*Euphorbia maculata*, old name), prostrate spurge, weed (fig. 37B)

E. marginata, snow on the mountain, garden plant

E. splendens, crown of thorns, houseplant

E. lactea, candelabra cactus, houseplant

E. tirucalli, tinsel tree, milk bush, houseplant

E. pulcherrima, poinsettia, houseplant

TOXICITY RATING: Moderate. Spurges are highly unpalatable, and are rarely consumed in quantities sufficient to cause serious toxicity, but are very irritating upon contact.

ANIMALS AFFECTED: Any animal consuming spurge or coming in contact with the sap may be affected.

DANGEROUS PARTS OF PLANT: All parts.

CLASS OF SIGNS: Gastrointestinal irritation, dermal and ocular irritation, poor doer, weakness.

PLANT DESCRIPTION: These spindly annuals or herbaceous, sometimes succulent or even cactus-like perennials with milky, acrid sap have simple, alternate or opposite, entire or toothed leaves. The tiny flowers are clustered in small, cup-like structures themselves resembling white-petaled flowers in some species. The fruit, three-lobed and three-seeded, is borne on a stalk extending from the cup-like flower structure. Spurges grow in old fields, open woods, roadsides, waste areas, and around homes as cultivated or escaped plantings. Some are houseplants.

SIGNS: Spurges contain sap that is highly irritating upon contact, especially to the eyes and mouth, and upon prolonged exposure to skin (legs and head primarily). Irritation, redness, pain and swelling will result, and salivation and head-shaking if the oral mucosa is affected. Blistering and open sores are possible with spurge sap, and some plants have historically been used as a chemical brand for cattle. If the plants are swallowed, stomach and intestinal irritation can occur, with vomiting (in those species that can vomit), abdominal pain, and diarrhea.

FIRST AID: Prevent further contact and ingestion of spurge. If a large quantity was consumed, if an eye is affected, or if the animal cannot eat, contact a veterinarian immediately. For minor irritation, provide supportive care, since the signs are usually self-limiting within about 12 to 24 hours.

SAFETY IN PREPARED FEEDS: Spurges remain toxic when dry, therefore feeds are not safe for consumption. If small amounts have been incorporated into hay (where the plants are still recognizable), animals may voluntarily avoid consuming spurge if there is enough good feed available. Caution must be used in more highly processed feeds where consumption is unavoidable, such as silage, chop, and pellets.

PREVENTION: Animals should not be pastured where spurges grow. Mow or spray to eliminate them, since skin irritation can occur just by the animal's contact with the plant. Do not feed spurge-contaminated feeds, especially the more highly processed ones where consumption cannot be prevented. Small amounts of spurge in hay may be safe for most animals since they typically will avoid eating it, although all efforts should be made to provide clean feed.

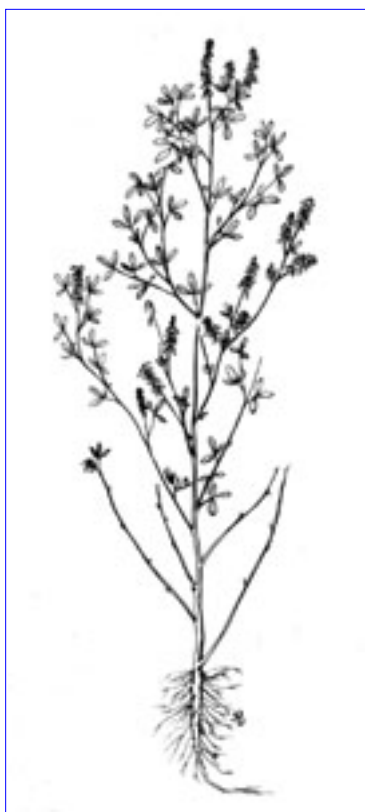

16. YELLOW SWEETCLOVER WHITE SWEETCLOVER

Melilotus officinalis *Melilotus alba*

(pea family)

TOXICITY RATING: Moderate.

ANIMALS AFFECTED: All animals that eat affected hay may be poisoned.

DANGEROUS PARTS OF PLANTS: All above-ground parts when present in moldy hay.

CLASS OF SIGNS: Bruising, spontaneous bleeding.

PLANT DESCRIPTION: These coarse biennial herbs (fig. 16) have alternate, three-parted, toothed leaves and bear white or yellow flowers in long, slender, spike-like clusters in the leaf axils. The numerous small, pea-like, white or yellow flowers fall soon after blooming. Pods are small, egg-shaped to round, inflated, and contain 1 to 4 seeds. Sweetclover grows along roadsides, fence rows, and in old fields. It is cultivated as a forage crop and soil builder. The plants favor alkaline or calcareous soils.

SIGNS: Clinical signs are related to the anticoagulant ("prevents blood clotting") activity of dicoumarol (also called dicoumarin). Coumarin, present in sweet clover, is converted to dicoumarin during improper curing of sweet clover hay, or when the plant is excessively stressed (frosts, drought). Fresh, undamaged sweetclover is safe for consumption.

Signs are related to the consumption and inadequate production of vitamin K, responsible for blood clotting, therefore excessive and uncontrolled bruising and bleeding will occur. The bleeding may be noticeable (through the nose, mouth or a wound), or may occur under the skin as large bruises, but can also occur inside the body, making an accurate diagnosis more difficult. The toxin can be passed in the milk, therefore nursing animals may be affected. The moldy hay needs to be consumed for 2 weeks or longer before signs manifest and this toxicosis is most often seen in winter after several weeks of moldy sweetclover has been consumed and is typically a herd problem.

Affected animals are weak, anorexic, may exhibit visible bleeding, have pale mucus membranes, increased respiratory rates, rapid and weak pulses, and may die. Often more than one animal is affected at a time.

Dicoumarin and related drugs are used in human medicine as "blood thinners" and are commonly used in rat and mouse poisons (which if ingested by any other animal can cause excessive bleeding and death if not treated).

FIRST AID: Remove all moldy hay from the animals. A veterinarian needs to be called if animals are bleeding, although once bleeding starts, it may be difficult to save the animal. Treatments can include blood or plasma transfusions (which may not be available or practical with large numbers of livestock) or treatment with vitamin K1. Vitamin K1 therapy requires a minimum of 12 to 24 hours to be effective, therefore severely affected animals may not survive this time period.

PREVENTION: Toxicity can be prevented by properly curing sweet clover hay, especially by allowing the stems to dry before baling. Extra caution must be taken with second year growth, since it contains a higher concentration of toxin. Affected hay may remain toxic for years. Moldy sweet clover hay should not be fed, but if it has to be fed, alternating with a non-moldy quality hay every few days will minimize clinical signs. Moldy sweet clover hay should be withheld for 4 to 6 weeks prior to anticipated parturition ("giving birth") or surgical procedure, to lessen the chances of these animals bleeding to death. Discard milk from affected animals to prevent signs developing in nursing animals.

INDEX

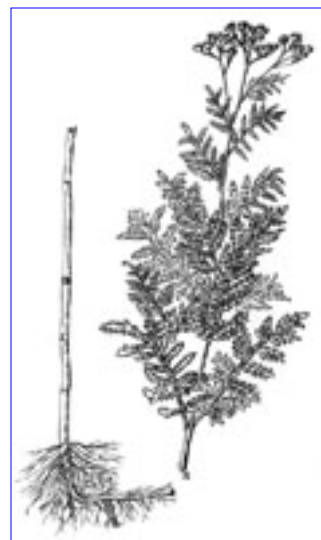

12. COMMON TANSY

Tanacetum vulgare

(daisy family)

TOXICITY RATING: Low.

ANIMALS AFFECTED: All animals may be affected.

DANGEROUS PARTS OF PLANT: Leaves, stems.

CLASS OF SIGNS: Salivating, colic, abdominal pain.

PLANT DESCRIPTION: These old-fashioned garden plants (fig. 12) were introduced from Europe and are now found in old gardens or along roadsides, creek banks, and waste areas. They are perennial herbs from a short, stout rootstock and bear alternate fern-like leaves with saw-toothed margins. The yellow, strong-scented, bitter-tasting flowers are in flat-topped clusters at the tops of the plant.

SIGNS: This is not a commonly reported toxic plant. Animals rarely ingest it, and this plant rarely occupies significant acreage in pastures. Illness and death in humans has been reported due to attempts at medicinal uses of concentrated plant extracts. Toxic signs may include salivating and abdominal pain (colic), with the possibility of convulsions and abortions occurring. The oil tanacetin is believed to cause the clinical signs.

FIRST AID: The risk of serious illness and death is slight with this tansy. Provide adequate and proper forage if the animals are eating this plant, and do not let pets nibble on the leaves or flowers.

SAFETY IN PREPARED FEEDS: Information is lacking on this, however, consider the plant toxic in prepared feeds.

PREVENTION: The risk of toxicosis is low with tansy, however if a pet begins to chew this plant, consider keeping the pet and plant separated (especially if the pet is confined in the plant's vicinity). If tansy occupies a significant amount of a pasture, consider mowing or otherwise eliminating the plant, or keeping the animals and plants separated.

INDEX



17. TOBACCO

Nicotiana spp.

(nightshade family)

TOXICITY RATING: Low to moderate, depending on the situation.

ANIMALS AFFECTED: All animals may be affected, but pets in contact with tobacco products are at risk as are pigs allowed to forage on harvested tobacco fields.

DANGEROUS PARTS OF PLANT: Leaves.

CLASS OF SIGNS: Gastrointestinal irritation, trembling, staggering, weakness, breathing problems, heart problems, collapse, birth defects, death.

PLANT DESCRIPTION: These tall annual plants grow from fibrous roots and produce large, hairy leaves and terminal clusters of tubular, 2 inches long, white, red, lavender, or yellow flowers on short stalks. Many-seeded capsules may appear in late summer. The tobacco species with colorful flowers (fig. 17) are grown as garden ornamentals. Those with yellow-green flowers and the largest leaves are an economic crop in the southern counties of the state.

SIGNS: The toxin in tobacco is nicotine, an alkaloid with an irritating effect on the stomach and intestines and also the nervous system. This toxin is related to the toxins in poison hemlock and lupine. Concerning nicotine concentrations, an average cigarette can contain between 20 and 30 mg, and 120 mg for a cigar. One report indicates that for a human unaccustomed to tobacco, 4 mg can cause clinical signs, and 60 mg at one time can cause death.

Pets can easily be poisoned by tobacco products in the home, either accidentally or maliciously. The primary route of poisoning is by ingestion (eating tobacco products or drinking tobacco-tainted water), but inhalation of smoke is also possible. Clinical signs nearly always are present, but only rarely is a lethal dose ingested. The initial signs of poisoning can develop within

10 to 15 minutes or may not manifest for several hours. At first, the irritating effect that tobacco has on the stomach and intestines will cause salivating, vomiting (if capable), and diarrhea. Shortly after the digestive signs develop, neurologic signs appear. Initially, nicotine stimulates the nervous system, with depression of the nervous system occurring at a later time. Early signs include nervousness, shaking, trembling, a stiff and uncoordinated gait, weakness and collapse. Cardiac abnormalities may be noted as well as breathing difficulties, to the point of respiratory paralysis (the cause of death in lethal cases). Tobacco is also teratogenic, causing birth defects if the mother animal was pregnant when the toxicosis occurred.

In large animals, pigs are the most likely to suffer tobacco poisoning, since they are allowed to forage on harvested tobacco fields. In addition to the gastric and neurologic signs, birth defects have been well documented when pregnant sows ingest tobacco. The most common defects are limb deformities in the piglets.

FIRST AID: For pigs and other large animals, it is unlikely that a lethal dose would be consumed. Keep the animal quiet and undisturbed and clinical signs should resolve within a few hours, although birth defects may still occur. For more severely affected large animals or in cases where it is known that a large quantity was ingested, call a veterinarian as soon as possible, since emergency evacuation of the gastrointestinal tract may be necessary. For pets, contact a veterinarian if any ingestion has occurred. With their smaller size, pets will show clinical signs more rapidly and more severely than large animals. In addition, the effects of nicotine can come on rapidly.

SAFETY IN PREPARED FEEDS: Tobacco remains toxic when dried, therefore processed feeds containing tobacco are not safe for consumption.

PREVENTION: Do not allow pets to be in contact with tobacco or tobacco products. Do not let animals drink from puddles or cups that have leached tobacco juice in them (such as when a water-filled cup has been used as an "ashtray", or spittoons), since this water can have extremely high concentrations of nicotine. Forced ingestion or inhalation is inhumane and potentially lethal. Concerning sows, there is disagreement over whether there exists a "danger window" for consumption of tobacco during gestation (currently there exists two thoughts, that on days 10 to 30 of gestation the piglets are susceptible, and another that indicates that anything after 30 days is dangerous). Until more clarity is brought to bear on the issue, do not let pregnant sows graze on tobacco.

INDEX

49. ENGLISH YEW JAPANESE YEW

Taxus baccata Taxus cuspidata

(yew family)

TOXICITY RATING: Extremely toxic, death is likely.

ANIMALS AFFECTED: All animals (livestock, pets and birds).

PLANT DESCRIPTION: Several species of yew are planted as ornamental shrubs or hedges. They are woody perennials with flat 1/2-1 inch long evergreen leaves (fig. 49) lighter green on the underside and broader than pine needles. The "berry" (technically called an aril) is grape-sized, juicy, and bright scarlet, with a hole in the end which makes it look cup-like.

CLASS OF SIGNS: Sudden death is the typical sign. Occasionally: breathing problems, trembling, weakness, heart problems, stomach upset.

SIGNS: "Found dead" is the typical presenting sign. Very rarely will animals show signs up to 2 days later: trembling, slow heart rate, difficulty breathing, gastroenteritis (stomach upset and diarrhea). The plant is exceptionally toxic, with one mouthful able to kill a horse or cow within 5 minutes. Toxicity is compounded by the apparent palatability of yew. Many animals are poisoned accidentally when yew trimmings are thrown into the pasture or when yew is planted as an ornamental within browsing reach. Infrequent reports of dogs chewing the leaves resulted in gastroenteritis, seizures, and aggressive behavior.

The toxin is taxine, a mixture of alkaloids, that slow down cardiac conduction. As little as 0.1 to 0.5% of the fresh plant per body weight is lethal. Death is due to cardiac and/or respiratory collapse.

FIRST AID: First aid is usually impractical, since the animals die so quickly. Prevent other animals from being exposed and use caution around animals showing clinical signs to prevent

human injury. If animals are still alive, contact a veterinarian. Cardiac drug therapy may be attempted, but success is unlikely.

SAFETY IN PREPARED FEEDS: Yew is toxic even when dry, therefore hay with yew in it is never safe in any amount.

PREVENTION: Never allow yew plants or trimmings within reach of horses, cattle, sheep, goats, pigs, birds, or any other animal likely to eat plants. Dogs and cats rarely chew on this plant, so it is not necessary to remove it from ornamental gardens. Toxicities in dogs occurred when puppies were confined to a pen with yew and chewed the plant out of boredom. The fleshy red "berry" is not considered toxic, but consumption is not advised.

THE POISONOUS PLANT GARDEN



The University of Illinois Poisonous Plant Garden will help individuals become familiar with plants that are potentially hazardous to a range of animal species including human beings. The garden includes over ninety species of plants native to Illinois or commonly used as ornamentals or house plants.

Toxic effects of plants vary with the species, health status, and age of the individual(s). Time of year, humidity, growth conditions, growth stage, and other factors also play a role in the hazards posed by toxic plants.

The Poisonous Plant Garden is located just northwest of the College of Veterinary Medicine Basic Science Building, near the corner of Lincoln Avenue and St. Mary's Road in Urbana, Illinois. The Garden is open to the public free of charge throughout the year.



[Toxicology Homepage](#)
[Veterinary Medicine Library](#)
[UIUC Library Gateway Homepage](#)
Comments to: [M. Williams](#)
Updated on: 10-15-2002 KMD

Bibliography

1. ASPCA National Animal Poison Control Center. *Household Plant Reference*. New York, NY: ASPCA, 1998.
2. Beckett, Kenneth A. *The RHS Encyclopedia of House Plants, Including Greenhouse Plants*. London: Swallow Editions Ltd., 1987.
3. Boon, W. and H. Groe. *Nature's Heartland: Native Plant Communities of the Great Plains Illustrated in Seasonal Color*. Ames, IA: Iowa State University Press, 1990.
4. Burger, Sandra M. *Horse Owner's Field Guide to Toxic Plants*. Ossining, NY: Breakthrough Publications Inc., 1996. ISBN: 0-914-32762-3
5. Campbell, Alexander. *Handbook of poisoning in dogs and cats*. Oxford ; Malden, MA, USA : Blackwell Science, 2000. ISBN: 0632050292.
6. Cheeke, Peter R. *Natural Toxicants in Feeds, Forages, and Poisonous Plants*. Danville, IL: Interstate Publishers, Inc., 1998. ISBN: 0-8134-3128-X [[Table of Contents](#)]
7. Colegate, S. M. and P. R. Dorling. *Plant-Associated Toxins: Agricultural, Phytochemical & Ecological Aspects*. Wallingford, U.K.: CAB International, 1994.
8. Davis, Brian. *The Gardener's Illustrated Encyclopedia of Trees & Shrubs*. Emmaus, PA: Rodale Press, 1987.
9. *Dictionary of Plant Toxins*. Jeffrey B. Harborne and Berbert Baxter, eds. Chichester, U.K.: Wiley, 1996. [[Description](#)]
10. Evers, Robert A. and Roger P. Link. *Poisonous Plants of the Midwest and Their Effects on Livestock*. Urbana, IL: University of Illinois at Urbana-Champaign, College of Agriculture, 1972. (Special Publication 24).
11. Foster, Steven, and Roger A. Caras. *A Field Guide to Venomous Animals and Poisonous Plants: North America North of Mexico*. Boston: Houghton Mifflin, 1994.
12. Fowler, Murray E. *Plant Poisoning in Small Companion Animals*. St. Louis, MO: Ralston Purina, 1981.
13. Gfeller, Roger W. and Shawn P. Messonnier. *Handbook of Small Animal Toxicology and Poisonings*. St. Louis, MO: Mosby, 2004. [[Description](#)]
14. Great Plains Flora Association. *Flora of the Great Plains*. Coordinated by R. L. McGregor. Lawrence, KS: University Press of Kansas, 1986.
15. Hails, Michael R. Comp. *Plant Poisoning in Animals: A Bibliography from the World Literature: no.3 1983-1992*. Wallingford, U.K.: CAB International, 1994.
16. Hall, Jeffery O., William B. Buck, and Loise-M. Côté. *Natural Poisons in Horses*. Second edition. Urbana, IL: National Poison Control Center; University of Illinois, 1995.
17. Kingsbury, John M. *Poisonous Plants of the United States and Canada*. Englewood Cliffs, NJ: Prentice Hall, 1964.
18. Knight, Anthony P. and Richard G. Walter. *A Guide to Plant Poisoning of Animals in North America*. Jackson, WY: Teton NewMedia, 2001.

19. Lampe, Kenneth F. and Mary Ann McCann. *AMA Handbook of Poisonous and Injurious Plants*. Chicago, IL: American Medical Association, 1985.
 20. Mohlenbrock, R.H. and D.M. Ladd. *Distribution of Illinois Vascular Plants*. Carbondale, IL: Southern Illinois University Press, 1978.
 21. Murphy, Michael J. *A Field Guide to Common Animal Poisons*. Ames, IA: Iowa State University Press, 1996.
 22. North, Pamela M. *Poisonous Plants and Fungi in Colour*. London: Blandford Press, 1967.
 23. Pojar, Jim and Andy MacKinnon. *Plants of Coastal British Columbia Including Washington, Oregon & Alaska*. Vancouver, British Columbia: B.C. Ministry of Forests and Lone Pine Publishing, 1994.
 24. Ricciuti, Edward R. *The Devil's Garden: Facts and Folklore of Perilous Plants*. New York: Walker and Company, 1978.
 25. Ross, Ivan A. *Medical Plants of the World: Chemical Constituents, Traditional and Modern Medicinal Uses*. Totowa, NJ: Humana Press, c1999.
 26. Spoerke, David G. and Susan C. Smolinske. *Toxicity of Houseplants*. Boca Raton, FL: CRC Press, 1990.
 27. Stephens, H.A. *Poisonous Plants of the Central United States*. Lawrence: The Regents Press of Kansas, 1980.
 28. Tehon, L.R. C. C. Morrill, and Robert Graham. *Illinois Plants Poisonous to Livestock*. Urbana, IL: University of Illinois, 1946. (Circular 599 of College of Agriculture Extension Service in Agriculture and Home Economics.)
 29. Tichy, William. *Poisons, Antidotes & Anecdotes*. New York: Sterling Publishing, 1977.
 30. Turner, Nancy J. and Adam F. Szczawinski. *Common Poisonous Plants and Mushrooms of North America*. Portland, OR: Timber Press, 1991.
 31. West, Erdman and M.W. Emmel. *Plants That Poison Farm Animals*. Gainesville, FL: University of Florida, 1987.
 32. West, Erdman. *Poisonous Plants Around the Home*. Gainesville, FL: University of Florida, 1984. (Bulletin 175D of Florida Cooperative Extension Service, Institute of Food and Agricultural Sciences.)
 33. Whitson, Tom D. *Weeds of the West*. Laramie, WY: The Western Society of Weed Science in cooperation with the Western United States Land Grant Universities Cooperative Extension Services, 1991.
 34. Whitson, Tom D. *Weeds of the West*. Laramie, WY: The Western Society of Weed Science in cooperation with the Western United States Land Grant Universities Cooperative Extension Services, 1995.
-



[Veterinary Medicine Library](#)

[UIUC Library Gateway Homepage](#)

Comments to: [M. Williams](#)

Updated on: 02/17/2003 KMD, 10/13/2003 KJH

LIST OF PLANTS BY COMMON NAME

[Alfalfa \(*Medicago sativa* L.\)](#)

American Coffee Berry Tree see [Kentucky Coffee Tree](#)

[Bloodroot \(*Sanguinaria canadensis* L.\)](#)

[Bouncing Bet \(*Saponaria officinalis* L.\)](#)

[Bull Nettle \(*Solanum carolinense* L.\)](#)

[Bracken or Brake Fern \(*Pteridium aquilinum* L.\)](#)

Burning Bush see [Fireweed](#)

[Buttercup \(*Ranunculus* spp.\)](#)

Carelessweed see [Pigweed](#)

[Castor Bean \(*Ricinus communis* L.\)](#)

[Clover, Alsike & Other Clovers \(*Trifolium hybridum* L. & other species\)](#)

[Cocklebur \(*Xanthium strumarium* L.\)](#)

Creeping Charlie see [Ground Ivy](#)

[Crown of Thorns \(*Euphorbia milii*\)](#)

[Curly Dock \(*Rumex crispus* L.\)](#)

[Daffodil \(*Narcissus* spp.\)](#)

[Delphinium \(*Delphinium* spp.\)](#)

Devil's Trumpet see [Jimson Weed](#)

[Dogbane \(*Apocynum* spp.\)](#)

[Dutchman's Breeches \(*Dicentra cucullaria* \(L.\) Bernh.\)](#)

[Elderberry \(*Sambucus canadensis* L.\)](#)

[English Ivy \(*Hedera helix* L.\)](#)

[Ergot \(*Claviceps purpurea* \(Fr.\) Tul.\)](#)

[Fern, Bracken \(*Pteridium aquilinum* L.\)](#)

[Fireweed \(*Kochia scoparia* L.\)](#)

[Foxglove \(*Digitalis purpurea* L.\)](#)

[Ground Ivy \(*Glechoma hederacea* L.\)](#)

Hemlock

[Poison \(*Conium maculatum* L.\)](#)

[Water \(*Cicuta maculata* L.\)](#)

Hemp (*Cannabis sativa* L.) (being reviewed - 7/25/2003)

[Horse Chestnut, Buckeyes \(*Aesculus hippocastanum* L.\)](#)

[Horse Nettle \(*Solanum carolinense* L.\)](#)

[Horsetails \(*Equisetum arvense* L. & other species\)](#)

[Hyacinth \(*Hyacinth orientalis*\)](#)

[Hydrangea \(*Hydrangea* spp.\)](#)

Ivy

[English \(*Hedera helix* L.\)](#)

[Ground \(*Glechoma hederacea* L.\)](#)

[Poison \(*Toxicodendron radicans* \(L.\) Kuntze\)](#)

[Jack-in-the-Pulpit \(*Arisaema* spp.\)](#)

Jamestown Weed see [Jimson Weed](#)

[Japanese Yew \(*Taxus cuspidata* Sieb. & Zucc.\)](#)

[Jerusalem Cherry \(*Solanum pseudocapsicum* L.\)](#)

[Jimson Weed \(*Datura stramonium* L.\)](#)

[Kentucky Coffee Tree \(*Gymnocladus dioica* \(L.\) K. Koch\)](#)

Kentucky Mahogany Tree see [Kentucky Coffee Tree](#)

Klamath Weed see [St. Johnswort](#)

[Lamb's Quarters \(*Chenopodium album* L.\)](#)

[Lantana \(*Lantana camara* L.\)](#)

[Larkspur \(*Delphinium* spp.\)](#)

[Lily-of-the-Valley \(*Convallaria majalis*\)](#)

[Lupine \(*Lupinus* spp.\)](#)

Mad Apple see [Jimson Weed](#)

[Maple, Red \(*Acer rubrum*\)](#)

[Mayapple \(*Podophyllum peltatum* L.\)](#)

[Milkweed, Common \(*Asclepias syriaca* L.\)](#)

[Mint, Purple \(*Perilla frutescens*\)](#)

Nicker Tree see [Kentucky Coffee Tree](#)

[Nightshade \(*Solanum* spp.\)](#)

[Oleander \(*Nerium oleander* L.\)](#)

[Ohio Buckeye \(*Aesculus glabra* Willd.\)](#)

[Philodendron \(*Philodendron* spp.\)](#)

[Pigweed \(*Amaranthus* spp.\)](#)

[Poison Hemlock \(*Conium maculatum* L.\)](#)

[Poison Ivy \(*Toxicodendron radicans* \(L.\) Kuntze\)](#)

[Poke \(*Phytolacca americana* L.\)](#)

[Purple Mint \(*Perilla frutescens*\)](#)

Redroot see [Pigweed](#)

[Rhododendron \(*Rhododendron* spp.\)](#)

[Rhubarb \(*Rheum rhaponticum* L.\)](#)

Squirrelcorn (*Dicentra canadensis* (Goldie) Walp.) see [Dutchman's Breeches](#)

Staggerweed (*Dicentra* spp.) see [Dutchman's Breeches](#)

[St. Johnswort \(*Hypericum perforatum* L.\)](#)

Stink Weed see [Jimson Weed](#)

Stump Tree see [Kentucky Coffee Tree](#)

[Sudan Grass \(*Sorghum vulgare* var. *sudanense* Hitchc.\)](#)

Summer Cypress see [Fireweed](#)

Thorn Apple see [Jimson Weed](#)

[Tulip \(*Tulipa* spp.\)](#)

[Water Hemlock \(*Cicuta maculata* L.\)](#)

[White Snakeroot \(*Eupatorium rugosum* Hout.\)](#)

[Wild Onion \(*Allium* spp.\)](#)

Yellow Sage see [Lantana](#)

| [Scientific Name List](#) | [Toxic Plant Homepage](#) | [Veterinary Medicine Library](#) |



[Veterinary Medicine Library](#)

[UIUC Library Gateway Homepage](#)

Comments to: [M. Williams](#)

Updated on: 7/25/2003 KMD

LIST OF PLANTS BY SCIENTIFIC NAME

[*Acer rubrum* -- \(Maple, Red\)](#)
[*Aesculus glabra* Willd. -- \(Ohio Buckeye\)](#)
[*Aesculus hippocastanum* L. -- \(Horse Chestnut, Buckeye\)](#)
[*Allium* spp. -- \(Wild Onion\)](#)
[*Amaranthus retroflexus*. -- \(Pigweed\)](#)
[*Apocynum* spp. -- \(Dogbane\)](#)
[*Arisaema* spp. -- \(Jack-in-the-Pulpit\)](#)
[*Asclepias syriaca* L. -- \(Common Milkweed\)](#)
[*Cannabis sativa* L. -- Hemp \(being reviewed - 7/25/2003\)](#)
[*Chenopodium album* L. -- \(Lamb's Quarters\)](#)
[*Cicuta maculata* L. -- \(Water Hemlock\)](#)
[*Claviceps purpurea* \(Fr.\) Tul. -- \(Ergot\)](#)
[*Conium maculatum* L. -- \(Poison Hemlock\)](#)
[*Convallaria majalis* -- \(Lily-of-the-Valley\)](#)
[*Datura stramonium* L. -- \(Jimson Weed\)](#)
[*Delphinium* spp. -- \(Delphinium\)](#)
[*Dicentra* spp. \(Dutchman's Breeches & Squirrelcorn\)](#)
[*Digitalis purpurea* L. -- \(Foxglove\)](#)
[*Equisetum arvense* L. & other species -- \(Horsetails\)](#)
[*Eupatorium rugosum* Hout. -- \(White Snakeroot\)](#)
[*Euphorbia milii* -- \(Crown of Thorns\)](#)
[*Glechoma hederacea* L. -- \(Ground Ivy\)](#)
[*Gymnocladus dioica* \(L.\) K. Koch -- \(Kentucky Coffee Tree\)](#)
[*Hedera helix* L. -- \(English Ivy\)](#)
[*Hyacinth orientalis* -- \(Hyacinth\)](#)
[*Hydrangea* spp. -- \(Hydrangea\)](#)
[*Hypericum perforatum* L. -- \(St. Johnswort\)](#)
[*Kochia scoparia* L. -- \(Fireweed\)](#)
[*Lantana camara* L. -- \(Lantana\)](#)
[*Lupinus* spp. -- \(Lupine\)](#)
[*Medicago sativa* L. -- \(Alfalfa\)](#)
[*Narcissus* spp. -- \(Daffodil\)](#)
[*Nerium oleander* L. -- \(Oleander\)](#)
[*Perilla frutescens* -- \(Purple Mint\)](#)
[*Philodendron* spp. -- \(Philodendron\)](#)
[*Phytolacca americana* L. -- \(Poke\)](#)

[*Podophyllum peltatum* L. -- \(Mayapple\)](#)
[*Pteridium aquilinum* \(Desv.\) Hier. -- \(Bracken or Brake Fern\)](#)
[*Ranunculus* spp. -- \(Buttercup\)](#)
[*Rhododendron* spp. -- \(Rhododendron\)](#)
[*Rheum rhaponticum* L. -- \(Rhubarb\)](#)
[*Ricinus communis* L. -- \(Castor Bean\)](#)
[*Rumex crispus* L. -- \(Curly Dock\)](#)
[*Sambucus canadensis* L. -- \(Elderberry\)](#)
[*Sanguinaria canadensis* L. -- \(Bloodroot\)](#)
[*Saponaria officinalis* L. -- \(Bouncing Bet\)](#)
[*Solanum* spp. -- \(Nightshades\)](#)
[*Solanum carolinense* L. -- \(Horse or Bull Nettle\)](#)
[*Solanum pseudocapsicum* L. -- \(Jerusalem Cherry\)](#)
[*Sorghum vulgare* var. *sudanense* Hitchc. -- \(Sudan Grass\)](#)
[*Taxus cuspidata* Sieb. & Zucc. -- \(Japanese Yew\)](#)
[*Toxicodendron radicans* \(L.\) Kuntze -- \(Poison Ivy\)](#)
[*Trifolium hybridum* L. & other species -- \(Alsike & Other Clovers\)](#)
[*Tulipa* spp. -- \(Tulip\)](#)
[*Xanthium strumarium* L. -- \(Cocklebur\)](#)

[Common Name List](#)



[Toxicology Homepage](#)
[Veterinary Medicine Library](#)
[UIUC Library Gateway Homepage](#)
Comments to [:M. Williams](#)
Updated on: 7/22/2003 KMD

STRUCTURE OF DATABASE

The following is a brief explanation of the structure which will aid you in your navigation around the database.

Within the Toxic Plant Database Homepage and at the bottom of this page you will find links to two alphabetical lists of plant names, one by common names and the other by scientific names. When you select a plant in either of the lists, you will be guided to the description of that plant. The description contains a representative plant image at the height of its growth and a brief description for identifying the plant. This section may also contain links to other images of the same plant at different growth stages.

From the description, you can access 5 other parts of the same plant entry as shown below:

(1) Distribution

This section describes the geographical and the type of area in which the plant is commonly found.

(2) Conditions of poisoning

This section describes how animals are most often poisoned, i.e., time of year, weather conditions, etc.

(3) Control

This section contains general information about controlling the growth of the plant to prevent poisoning.

(4) Toxic principle

This section identifies the chemical principle of the plant which causes the poisoning.

(5) Clinical signs

This section describes the signs displayed by animals that may have been poisoned by the plant.

[Common Name List](#)

[Scientific Name List](#)



[Veterinary Medicine Library](#)
[UIUC Library Gateway Homepage](#)

Comments to: [M. Williams](#)

Updated on: 9-24-1999

ILLINOIS

UNIVERSITY OF ILLINOIS AT URBANA-CHAMPAIGN



[campus units \(a-z\)](#)

[find people](#)

[library](#)

[maps](#)

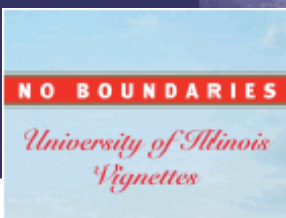

[explore illinois](#)

[search options](#)

Search

[Campus Overview](#)

[Academics](#)

[Research](#)

[Public Engagement](#)

[Admissions & Records](#)

[Services](#)

[Administration](#)

[Arts & Culture](#)

[Community](#)

[International](#)

[Sports & Recreation](#)

Featured Resources

[Webmail](#)

[Course Information](#)

[Commencement](#)

[Brown Jubilee](#)

Resources for

[Prospective Students](#)

[Visitors](#)

[Alumni](#)

[Parents](#)

[Students](#)

[Faculty](#)

[Staff](#)

[Giving to Illinois](#)

[Illinois News](#)

[New book tells the unique stories of U of I](#)

[Use ongoing training to sharpen skills of](#)

[airport screeners](#)

[Roger Ebert's papers find a home at Illinois](#)

[Illinois in the News](#)

[Calendar](#)

[10 May Collections begin for Dump and Run at University Y](#)

[10 May Registration for Learn-to-Swim Classes](#)

[14 May Baseball vs. University of Minnesota](#)

[15 May Commencement Weekend](#)

Announcements

[NEW information on benefit changes](#) [VIRUS ALERT: Internet Worm Outbreak!](#) [Recent MassMail to Students](#) [Try the new virtual campus tour](#)

Shortcuts

[From the Chancellor Congratulations to both 2003 Nobel Laureates](#)

[Campus Holidays for FY 2004-2005](#)

Colleges & Schools

[College of Agricultural, Consumer and Environmental Sciences](#)

[College of Applied Life Studies](#)

[Institute of Aviation](#)

[College of Business](#)

[College of Communications](#)

[College of Education](#)

[College of Engineering](#)

[College of Fine and Applied Arts](#)

[Graduate College](#)

[Institute of Labor and Industrial Relations](#)

[College of Law](#)

[College of Liberal Arts and Sciences](#)

[Graduate School of Library and Information Science](#)

[College of Medicine at Urbana-Champaign](#)

[School of Social Work](#)

[College of Veterinary Medicine](#)

[About this Site](#) | [Site Map](#) | [Contact Us](#) | [Text Only](#) | [Privacy Policy](#) |

[University Administration](#) · [Springfield](#) · [Chicago](#) | © 2004 The Board of Trustees at the

University of Illinois

PLANTS TOXIC TO ANIMALS

looksmart



Mitsuko Williams ©
Veterinary Medicine Librarian
University of Illinois at Urbana-Champaign

[Introduction](#)

[Plant Entries by Common Names](#)

[Plant Entries by Scientific Names](#)

[University of Illinois Poisonous Plant Garden](#)

[Bibliography](#)

[Database Structure](#)

[National Animal Poison Control Center](#)

[Links to Related Sources](#)



[Veterinary Medicine Library](#)
[UIUC Library Gateway Homepage](#)
Comments to: [M. Williams](#)
Updated on: 6/8/2001 MKS

LIBRARY GATEWAY

UNIVERSITY OF ILLINOIS AT URBANA-CHAMPAIGN



Library Friends

NEWS ITEMS

[Library Expands Access to Digital Resources in the Sciences and Humanities](#)

[Fund-raising Campaign for the Library](#)

[Year of the University Press](#)

[Construction of Oak Street Shelving Facility](#)

[Proceedings of the Conference on the Future of the Library](#)

[Library Hours and Services Affected by Campus Budget Reduction](#)

[Frequently Asked Questions about Library Budget Cuts](#)

LIBRARY CATALOGS

[UIUC Library Online Catalog](#)

[Specialized UIUC Catalogs](#)

[Off Campus Libraries' Catalogs](#)

ONLINE RESEARCH RESOURCES

Including:

[Article Indexes & Abstracts Full Alphabetical List](#)

[Electronic Journals](#)

[More . . .](#)

[Online Reference Collection](#)

[Digital Projects of the UIUC Library](#)

LIBRARY SERVICES

[General Information](#)

[Hours/Locations](#)

[Course Reserves](#)

[Interlibrary Loan](#)

[Ask a Librarian \(real time\)](#)

[Circulation \(renewals\)](#)

[Departmental Libraries](#)

[Alumni & Library](#)

[Friends](#)

LIBRARY HELP

LIBRARY SITE MAP AND SEARCH

[Library Website Search](#)

[Undergraduate Library](#)
[Media Center and](#)
[Reserve Unit combine](#)

[System &](#)
[Services Alerts](#)



[University of Illinois at Urbana-Champaign](#)
[Library Gateway Homepage](#)

Comments to: [UIUC Library Webmaster](#)

University of Illinois at Urbana-Champaign Library
1408 West Gregory Drive
Urbana, IL 61801

Phone: 217-333-0790

Updated on: Wednesday, 28-Apr-2004 21:46:32 CDT



E-mail to Mitzi Williams

VetMed Library

Please note that e-mails using this form are sent to the above address at the UIUC Veterinary Medicine Library only.

Please provide your correct contact information

Name

E-mail address

Department/School

Subject of email:

Message, comments, suggestions, etc. :



[University of Illinois at Urbana-Champaign](#)

[Library Gateway Homepage](#)

[Comments to: M. Williams](#)

Updated on: 03.04.99 may

Alfalfa

(*Medicago sativa* L.)



Description

Alfalfa is an excellent forage crop when harvested and stored properly. However, the plant can cause "hepatogenous photosensitivity syndrome" if water-damaged (Monlux AW . J Am Vet Med Assoc, Vol. 142, 9, p. 989-994, 1963).

[Additional images of Alfalfa](#)

| Plant Lists: [Scientific](#) or [Common](#) | [Veterinary Medicine Library](#) | [UIUC Library](#) |

Last updated: July 01, 2002 KMD

Please direct all comments or requests for information to [M. Williams](#).

Kentucky Coffee Tree

(*Gymnocladus dioica* (L.) Koch)

Other common names include: American coffee berry, Kentucky mahogany, nicker treet, stump tree.





Description

Kentucky coffee tree is a large round-barked tree belonging to the legume family and reaches heights of 60 to 100 feet. Its short trunk, 1 to 2 feet in diameter, divides into several large branches that end in contorted, stout twigs. Twice-compound leaves are arranged feather-fashion in 3-7 pairs of leaflets which are more or less ovalish without marginal teeth and 2-4 inches long. The tree is most easily identified in fall and winter for its large derressed leaf scars. The leaf which emerges late in spring is made up of a hundred or more separate oval leaflets arranged on the branches of the rib.

The flower, which blooms in May, is inconspicuous, greenish-white in terminal racemes, and has a tubular base about 1/2 inch long. Male and female flowers are found on the same tree. The fruit is a thick, flat pod, containing 4-7 flat broad seeds with a sticky pulp between them. The pulp dries at maturity and the seeds become olive-brown, 1/2 - 3/4 inches in diameter.

[Additional images of Kentucky Coffee Tree](#)

| [Distribution](#) | [Conditions of poisoning](#) | [Control](#) | [Toxic principle](#) | [Clinical signs](#) |

| Plant Lists: [Scientific](#) or [Common](#) | [Veterinary Medicine Library](#) | [UIUC Library](#) |

Last updated: March 18, 1996

Please direct all comments or requests for information to [M. Williams](#).

Bloodroot

(*Sanguinaria canadensis* L.)



[Additional images of Bloodroot](#)

| [Description](#) | [Distribution](#) | [Conditions of poisoning](#) | [Toxic Principle](#) |

| Plant Lists: [Scientific](#) or [Common](#) | [Veterinary Medicine Library](#) | [UIUC Library](#) |

Last updated: July 16, 1995

Please direct all comments or requests for information to [M. Williams](#).

Bouncing Bet

(*Saponaria officinalis* L.)



[Additional images of Bouncing Bet](#)

[Description](#) | [Distribution](#) | [Conditions of poisoning](#) | [Control](#) | [Toxic principle](#) | [Clinical signs](#) |

| Plant Lists: [Scientific](#) or [Common](#) | [Veterinary Medicine Library](#) | [UIUC Library](#) |

Last updated: June 20, 1996

Please direct all comments or requests for information to [M. Williams](#).

Horse Nettle or Bull Nettle

(*Solanum carolinense* L.)



[Additional images of Horse Nettle](#)

See [Nightshade \(*Solanum* spp.\)](#) for toxicology information.

| Plant Lists: [Scientific](#) or [Common](#) | [Veterinary Medicine Library](#) | [UIUC Library](#) |

Please direct all comments or requests for information to [M. Williams](#).

Bracken Fern or Brake Fern

(*Pteridium aquilinum*)



Description

Bracken fern is a typical fern. Its large triangular fronds are divided into three main parts with each part bipinnately subdivided. These fronds are 2 to 4 feet long by 1 to 3 feet wide. They are borne at the tips of erect, rigid, straw-colored, smooth stalks 1 to 3 feet tall. The stalks rise at intervals from stout black underground rootstocks sometimes a yard or more long.

Spores are borne in late summer at the edges on the lower sides of mature fronds, and the edges fold under to form the spore cover. The rootstocks also spread the fern.

[Distribution](#) | [Conditions of poisoning](#) | [Control](#) | [Toxic principle](#) | [Clinical signs](#) |

| Plant Lists: [Scientific](#) or [Common](#) | [Veterinary Medicine Library](#) | [UIUC Library](#) |

Last updated: January 16, 1996

Please direct all comments or requests for information to [M. Williams](#).

Fireweed

(*Kochia scoparia* (L.) Schrad.)



Other names: Summer Cypress, Burning Bush, Mexican Fireweed

[Additional Images of Fireweed](#)

| Plant Lists: [Scientific](#) or [Common](#) | [Veterinary Medicine Library](#) | [UIUC Library](#) |

Last updated: February 14, 1996

Please direct all comments or requests for information to [M. Williams](#).

Buttercup

(*Ranunculus* spp.)



[Additional images of Buttercup](#)

| [Description](#) | [Distribution](#) | [Conditions of poisoning](#) | [Control](#) | [Toxic principle](#) | [Clinical signs](#) |

Plant Lists: [Scientific](#) or [Common](#) | [Veterinary Medicine Library](#) | [UIUC Library](#) |

Last updated: July 19, 1996

Please direct all comments or requests for information to [M. Williams](#)

Pigweed

(*Amaranthus retroflexus* L.)



Other common names

Carelessweed, Redroot

| Plant Lists: [Scientific](#) or [Common](#) | [Veterinary Medicine Library](#) | [UIUC Library](#) |

Last revised 12/07/95

Please direct all comments or requests for information to [M. Williams](#).

Castor Bean

(*Ricinus communis*)



[Additional images of Castor Bean](#)

Description

Castor bean is a herbaceous annual which can reach to nearly 15 feet tall when growing in open spaces in warm climates. Large leaves are alternate, palmately lobed with 5-11 toothed lobes. Leaves are glossy and often red or bronze tinted when young. Flowers appear in clusters at the end of the main stem in late summer. The fruit consists of an oblong spiny pod which contains three

seeds on average. Seeds are oval and light brown, mottled or streaked with light and dark brown and resemble a pinto bean. The plant itself is fast growing, but the seeds require a long frost-free season in order to mature.

| [Distribution](#) | [Conditions of poisoning](#) | [Toxic principle](#) | [Clinical signs](#) |

| Plant Lists: [Scientific](#) or [Common](#) | [Veterinary Medicine Library](#) | [UIUC Library](#) |

Last updated: August 4, 1996

Please direct all comments or requests for information to [M. Williams](#).

Clover, Alsike and Other Clovers

(*Trifolium hybridum* L. and other species)



Description

Alsike clover is a many-stemmed herb 1 1/2 to 2 1/2 feet high, much like the common red and white clovers, of which it is a hybrid. Its stems and leaves are not hairy. Its leaves, like those of all other clovers, are made up of 3 leaflets grouped at the ends of the long leafstalks. There are no crescents in the leaflets. Its flowers, borne in rather compact, stalked heads, are usually pink but range from red to white. Its seeds are smaller than those of red clover and are dark yellow-green.

The flowers of [Red clover \(*Trifolium pratense* L.\)](#) are usually rose purple or magenta. The stems

and leaves of American strains are generally hairy.

| [Distribution](#) | [Conditions of poisoning](#) | [Control](#) | [Toxic principle](#) | [Clinical signs](#) |

| Plant Lists: [Scientific](#) or [Common](#) | [Veterinary Medicine Library](#) | [UIUC Library](#) |

Last updated: January 17, 1996

Please direct all comments and suggestions to [M. Williams](#).

Cockleburs

(*Xanthium pennsylvanicum* L. and other species)



[Additional images of Cocklebur](#)

Description

The cocklebur plant is a coarse herbaceous annual about 3 feet high. They have erect, stout stems and spreading branches that are angled and often red-spotted. The leaves are alternate, rough to the touch, and broadly triangular to heart-shaped. Cockleburs produce two kinds of flowers. One kind, in short terminal branches, produces only pollen; the other kind, in clusters in the axils of the leaves, produces seed. The fruit is a small, hard, 2-chambered bur, oval in shape and about 3/4 inch long. It is covered with strong, hooked spines. This plant reproduces only by means of its seed.

The seedling, the plant's most dangerous stage, is very different from the mature plant. It consists of a slender, straight whitish green stem 1 to 3 inches tall. Capping this stem are two strap-shaped

green leaves, each about 1 1/4 inches long and 1/4 inch wide. Leaves produced after these first leaves gradually assume the characteristic shape of those of the mature plant. Proof of the identity of young seedlings may be found in their attachment underground to the easily recognized burs from which they sprout.

| [Distribution](#) | [Conditions of poisoning](#) | [Control](#) | [Toxic principle](#) | [Clinical signs](#) |

| Plant Lists: [Scientific](#) or [Common](#) | [Veterinary Medicine Library](#) | [UIUC Library](#) |

Last updated: January 29, 1997

Please direct all comments or requests for information to [M. Williams](#).

Ground Ivy

(*Glechoma hederacea* L.)

[No Image Available]

Description

Ground ivy is a low, prostrate perennial herb with slender 4-sided stems that hug the ground, root at their joints, and often cover areas of many square feet. Its leaves, two at a joint, are raised on slender stalks. They are roundish and have scalloplike teeth on their margins. Its small bluish flowers, found in the axils of the leaves, appear from April to May and even into July.

| [Distribution](#) | [Conditions of poisoning](#) | [Control](#) | [Toxic principle](#) | [Clinical signs](#) |

| Plant Lists: [Scientific](#) or [Common](#) | [Veterinary Medicine Library](#) | [UIUC Library](#) |

Please direct all comments or requests for information to [M. Williams](#).

Crown-of-Thorns

(*Euphorbia mili*)



Description

A low-growing evergreen shrub with very thorny grooved stems and branches. The stems are purplish brown and are 1-2 feet tall on average, but can reach 3 feet in a warm climate. The thorns are sharp pointed and are 1/2 inch long on average. The ovate leaves are 1-3 inches long, few in number, and are found mostly at the growing ends. The cyathia, a type of inflorescence characteristic of the genus *Euphorbia*, are born in small umbels and have showy, ovate and bright red bracts. The small flowers are produced in clusters of 2-8 at the tips of green flower stem about 1 inch long. Genus *Euphorbia* includes other commonly available plants such as poinsettia (*E. pulcherrima*) and snow-on-the-mountain (*E. marginata*).

[Distribution](#) | [Conditions of poisoning](#) | [Control](#) | [Toxic principle](#) | [Clinical signs](#)

| Plant Lists: [Scientific](#) or [Common](#) | [Veterinary Medicine Library](#) | [UIUC Library](#) |

Last updated: July 1, 1996

Please direct all comments or requests for information to [M. Williams.](#)

Curly Dock

(*Rumex crispus* L.)



[Additional images of Curly Dock](#)

| Plant Lists: [Scientific](#) or [Common](#) | [Veterinary Medicine Library](#) | [UIUC Library](#) |

Last updated: July 18, 1996

Please direct all comments or requests for information to [M. Williams](#).

Daffodil

(*Narcissus* spp.)



[Additional images of Daffodil](#)

| Plant Lists: [Scientific](#) or [Common](#) | [Veterinary Medicine Library](#) | [UIUC Library](#) |

Last updated: August 12, 1996

Please direct all comments or requests for information to [M. Williams](#).

Delphinium

(*Delphinium* spp.)



[Additional images of Delphinium](#)

| Plant Lists: [Scientific](#) or [Common](#) | [Veterinary Medicine Library](#) | [UIUC Library](#) |

Last updated: July 19, 1996

Please direct all comments or requests for information to [M. Williams](#).

Jimsonweed

(*Datura stramonium* L.)



Other common names

Jamestown Weed, Thorn Apple, Devil's Trumpet, Mad Apple, Stink Weed

[Additional images of Jimsonweed](#)

Description

Jimsonweed is a stout, coarse annual herb 2 to 5 feet tall, with spreading branches. It has a pale-green stem and large, ovate, green or purplish, strong-scented leaves, coarsely toothed on their margins. Its flowers are large, white, and tubular, 2 to 4 inches long, and set on short stalks in the axils of branches. Its circular seeds, about 1/8 inch across, are contained in a hard, prickly capsule which, when ripe, splits lengthwise into four parts.

| [Distribution](#) | [Conditions of poisoning](#) | [Control](#) | [Toxic principle](#) | [Clinical signs](#) |

| Plant Lists: [Scientific](#) or [Common](#) | [Veterinary Medicine Library](#) | [UIUC Library](#) |

Last updated: June 20, 1996

Please direct all comments or requests for information to [M. Williams](#).

Dogbane

(*Apocynum* spp.)



| [Additional images of Dogbane](#) | [Description](#) | [Distribution](#) | [Conditions of poisoning](#) | [Control](#) |
[Toxic principle](#) | [Clinical signs](#) |

| Plant Lists: [Scientific](#) or [Common](#) | [Veterinary Medicine Library](#) |

Last updated: January 29, 1997

Please direct all comments or requests for information to [M. Williams](#).

Dutchman's Breeches

(*Dicentra cucullaria*)



| [Description](#) | [Distribution](#) | [Conditions of poisoning](#) | [Control](#) | [Toxic principle](#) | [Clinical signs](#) |

| Plant Lists: [Scientific](#) or [Common](#) | [Veterinary Medicine Library](#) | [UIUC Library](#) |

Last updated: July 17, 1996

Please direct all comments or requests for information to [M. Williams](#).

Elderberry

(*Sambucus canadensis*)



[Additional images of Elderberry](#)

| Plant Lists: [Scientific](#) or [Common](#) | [Veterinary Medicine Library](#) | [UIUC Library](#) |

Last updated: January 17, 1997

Please direct all comments or requests for information to [M. Williams](#).

English Ivy

(*Hedera helix* L.)



[Additional images of English Ivy](#)

| Plant Lists: [Scientific](#) or [Common](#) | [Veterinary Medicine Library](#) | [UIUC Library](#) |

Last updated: June 4, 1996

Please direct all comments or requests for information to [M. Williams](#).

Ergot

(*Claviceps purpurea* (Fr.) Tul.)

[No Image Available]

Description

Ergot is a fungus that lives as a parasite in the blossoms of grasses. When the grass heads are nearly mature, it appears as jumbo grains protruding from the heads. Ergot grains, which are fungus bodies and not seeds, are several to many times the size of the grass seed. They are dark violet to almost black and are curved, hard, and hornlike. Ergot varies in abundance from year to year.

| [Distribution](#) | [Conditions of poisoning](#) | [Control](#) | [Toxic principle](#) | [Clinical signs](#) |

| Plant Lists: [Scientific](#) or [Common](#) | [Veterinary Medicine Library](#) | [UIUC Library](#) |

Please direct all comments or requests for information to [M. Williams](#).

Poison Hemlock

(*Conium maculatum* L.)



Description

Poison hemlock is a coarse biennial herb with a smooth, purple-spotted, hollow stem and leaves like parsley. It grows 3 to 6 feet tall and in late summer has many small white flowers in showy umbels. Its leaves are extremely nauseating when tasted.

Although sometimes confused with water hemlock, poison hemlock can be distinguished by its leaves and its roots. The leaf veins of the poison hemlock run to the tips of the teeth; those of the water hemlock run to the notches between the teeth. The poison hemlock root is long, white, and fleshy. It is usually unbranched and can be easily distinguished from the root of water hemlock, which is made up of several tubers.

[Additional images of Poison Hemlock](#)

| [Distribution](#) | [Conditions of poisoning](#) | [Control](#) | [Toxic principle](#) | [Clinical signs](#) |

| Plant Lists: [Scientific](#) or [Common](#) | [Veterinary Medicine Library](#) | [UIUC Library](#) |

Last updated: February 14, 1996

Please direct all comments or requests for information to [M. Williams](#).

Water Hemlock

(*Cicuta maculata* L.)



[Additional images of Water Hemlock](#)

Description

This 2-10 feet tall herbaceous perennial or biennial native of the Umbelliferae family is very difficult to separate from other species of the same family. It has a tuberous root with 2-8 oblong tubers which are 1.5-3 inches long and about 1/2 inch thick at the thickest point near the middle and stem end. The purple-streaked stems are stout and erect with much branching. The stems are solid when very young, but become hollow with nodes where the leaflets are attached. The stems are chambered with horizontal diaphragm of pith tissue which are more closely arranged at the base of the stem. The horizontal plates of piths are most easily visible by cutting the stem base lengthwise.

The alternate leaves are pinnately 2-3 times compound. The leaves of most species are lanceolate, 2-5 inches long, and sharply toothed. The base of the long petioles clasp the stem.

Flowers are white and tiny (no more than 1/8 inch across), have 5 petals, and appear in loose compound umbels at branch ends in mid summer. Umbels measure from 2 to 8 inches across and become somewhat spherical in fruit. Fruits are ovoid and ribbed on the outer surface.

New growth begins from tubers as well as from seeds.

| [Distribution](#) | [Conditions of poisoning](#) | [Control](#) | [Toxic principle](#) | [Clinical signs](#) |

| Plant Lists: [Scientific](#) or [Common](#) | [Veterinary Medicine Library](#) | [UIUC Library](#) |

Last updated: July 18, 1996

Please direct all comments or requests for information to [M. Williams](#).

Horse Chestnut, Buckeyes

(*Aesculus hippocastanum* L.)

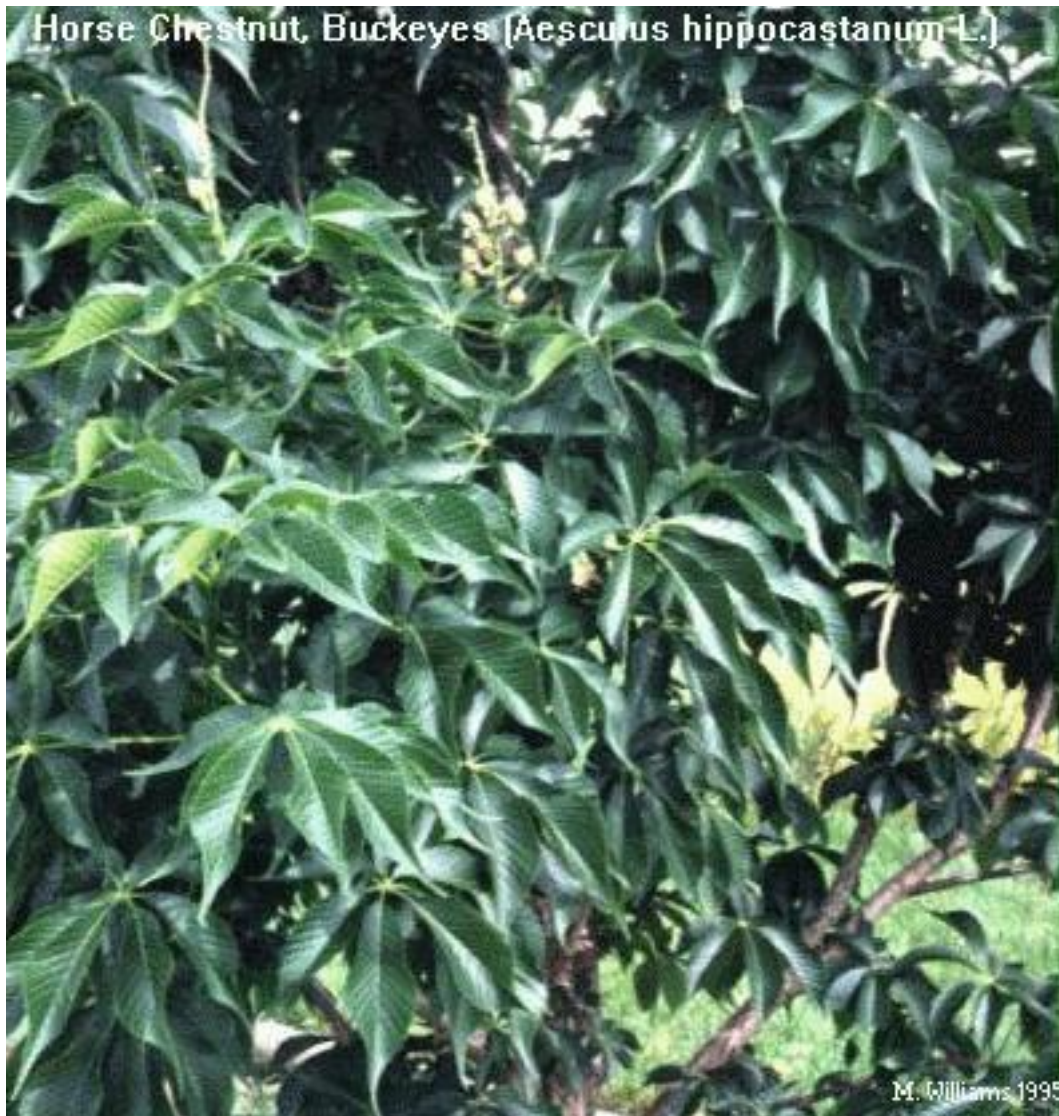

[Additional images of Horse Chestnut](#)

| Plant Lists: [Scientific](#) or [Common](#) | [Veterinary Medicine Library](#) | [UIUC Library](#) |

Last updated: August 12, 1996

Please direct all comments or requests for information to [M. Williams](#).

Horsetails

(*Equisetum arvense* L.)



[Additional images of Horsetails](#)

| Plant Lists: [Scientific](#) or [Common](#) | [Veterinary Medicine Library](#) |

Last updated: July 16, 1996

Please direct all comments or requests for information to [M. Williams](#).

Hyacinth

(*Hyacinth orientalis*)

Hyacinth

(*Hyacinth orientalis*)

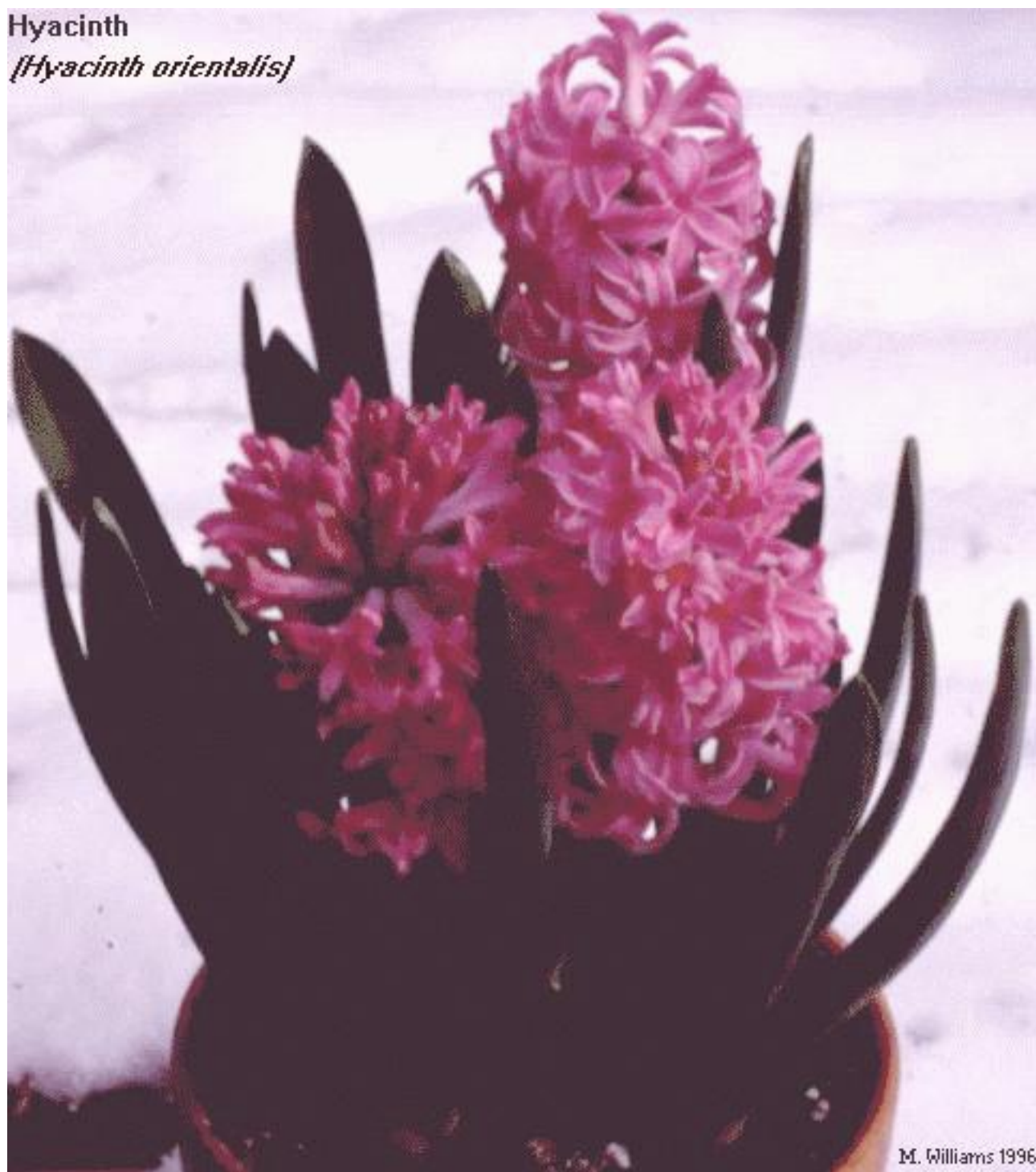

[Additional images of Hyacinth](#)

Description

Hyacinth is one of all the early spring blooming flowers most favored by home gardeners. It is a bulbous herb of the lily family with its origin in the Mediterranean region and cultivated in many color varieties. Green leaves, 7-8 per bulb, all arising from the ground level, are fleshy, glossy, narrow with smooth margins, 4-12 inches long and about 3/4 inches wide without marginal teeth. Flowers, borne in a dense raceme on a 6-8 inch long stem, are bell-shaped, and eventually open into 6 reflexed tepals. The flower is most well known for its fragrance. Fruits are globose and have 3 divisions. The bulb is 1-1/2 to 2 inches in diameter, light purple or cream colored, and covered with dry skin-like layers.

| [Distribution](#) | [Conditions of poisoning](#) | [Toxic principle](#) | [Clinical signs](#) |

| Plant Lists: [Scientific](#) or [Common](#) | [Veterinary Medicine Library](#) | [UIUC Library](#) |

Last updated: July 2, 1996

Please direct all comments or requests for information to [M. Williams](#).

Hydrangea

(*Hydrangea* spp.)



[Additional images of Hydrangea](#)

Description

The cultivated species, *Hydrangea macrophylla* Ser. (= *H. hortensis*), is a deciduous shrub which can reach to nearly 6 feet. The common cultivated species is grown widely in gardens and as potted plants. The flowers among the cultivated species include white, pink, mauve, bluish purple, to blue. The forms of the flower clusters and the leaves of the cultivated species are similar to those of the cold-hardy wild species (*H. arborescens* L.).

Wild hydrangeas, *H. quercifolia* Bartr. and *H. arborescens* L. , are shrubs which reach 3.5 to 10

feet in height. The stems are light green when new, turning light brown and woody with time. Leaves are alternate, 4-10 inches in length, dark green above, lighter or pale green on the underside. The leaves of *H. quercifolia* Bartr. are deeply lobed, while those of the other species (*H. arborescens* L.) are broadly rounded with apex tapering to a point. Flowers appear in clusters or heads, mostly with 4 petals in white or cream color, blooming from June to July. The capsular fruit is less than 1/8 inch in length and has many small, thin brown seeds.

| [Distribution](#) | [Conditions of poisoning](#) | [Toxic principle](#) | [Clinical signs](#) |

| Plant Lists: [Scientific](#) or [Common](#) | [Veterinary Medicine Library](#) | [UIUC Library](#) |

Last updated: July 2, 1996

Please direct all comments and suggestions to [M. Williams](#).

Poison Ivy

(*Toxicodendron radicans* (L.) Kuntze)
(=*Rhus toxicodendron* L., *Rhus radicans* L.)



| Plant Lists: [Scientific](#) or [Common](#) | [Veterinary Medicine Library](#) | [UIUC Library](#) |

Last revised 12/07/95

Please direct all comments or requests for information to [M. Williams](#).

Jack-in-the-Pulpit

(*Arisaema* spp.)



[Additional images of Jack-in-the-Pulpit](#)

| [Description](#) | [Distribution](#) | [Conditions of poisoning](#) | [Control](#) | [Toxic principle](#) | [Clinical signs](#) |

| Plant Lists: [Scientific](#) or [Common](#) | [Veterinary Medicine Library](#) | [UIUC Library](#) |

Last updated: July 22, 2003

Please direct all comments or requests for information to [M. Williams](#).

Japanese Yew

(*Taxus cuspidata* Sieb. & Zucc.)



[Additional images of Japanese Yew](#)

| Plant Lists: [Scientific](#) or [Common](#) | [Veterinary Medicine Library](#) | [UIUC Library](#) |

Last updated: June 4, 1996

Please direct all comments or requests for information to [M. Williams](#).

Jerusalem Cherry

(*Solanum pseudocapsicum* L.)



[Additional Images of Jerusalem Cherry](#)

| Plant Lists: [Scientific](#) or [Common](#) | [Veterinary Medicine Library](#) | [UIUC Library](#) |

Last updated: February 14, 1996

Please direct all comments or requests for information to [M. Williams](#).

St. Johnswort

(*Hypericum perforatum* L.)



[Additional images of St. Johnswort](#)

| Plant Lists: [Scientific](#) or [Common](#) | [Veterinary Medicine Library](#) | [UIUC Library](#) |

Last updated: January 27, 1997

Please direct all comments or requests for information to [M. Williams](#).

Lamb's Quarters

(*Chenopodium album* L.)



[Additional Images of Lamb's Quarters](#)

| Plant Lists: [Scientific](#) or [Common](#) | [Veterinary Medicine Library](#) | [UIUC Library](#) |

Please direct all comments or requests for information to [M. Williams](#).

Lantana

(*Lantana camara* L.)



Description

Lantana (yellow sage) is a native of tropical Americas and West Africa. In the northern states including Illinois, it is grown as a garden annual reaching 12-18 inches tall. In the south, from Florida to California, it grows as a perennial shrub of 3-6 feet tall. In the tropics, it may grow even taller. Leaves are opposite, ovate, 1-5 inches long and 1-2 inches wide, with very small rounded teeth, somewhat rough and hairy. Leaves are aromatic when crushed. Flowers are borne in dense clusters 1-2 inches across on the axils near the top of the stem. Each flower is tubular with 4 lobes flaring to about 1/4 inch, initially yellow or pink gradually changing to orange and deep red. Often, the different colored flowers are present on the same cluster. Fruit is fleshy, greenish-blue to black, and berry-like with each containing one seed.

| [Distribution](#) | [Conditions of poisoning](#) | [Toxic principle](#) | [Clinical signs](#) |

| Plant Lists: [Scientific](#) or [Common](#) | [Veterinary Medicine Library](#) | [UIUC Library](#) |

Last updated: March 12, 1996

Please direct all comments or requests for information to [M. Williams](#).

Dwarf Larkspur and Other Larkspurs

(*Delphinium tricorne* Michx. and other species)

[No Image Available]

Description

Dwarf larkspur is an erect, little-branched herb 1 to 3 feet tall. Its leaves, alternately placed and slender-stalked, are deeply divided into 5 to 7 nearly separate lobes, each lobe itself again rather deeply lobed or toothed. Its stout stem ends in a flower-bearing part that carries several blue or white, spurred blossoms 1 to 1 1/2 inches long. Three short-pointed rather fragile, widely spreading pods about 1/2 inch long develop from each blossom. These pods contain numerous small, dark seeds.

The rocket larkspur (*Delphinium ajacis* L.), which is cultivated and sometimes escapes, may be recognized from the above general description. It is supposed, in common with all other larkspurs, to be poisonous.

| [Distribution](#) | [Conditions of poisoning](#) | [Control](#) | [Toxic principle](#) | [Clinical signs](#) |

| Plant Lists: [Scientific](#) or [Common](#) | [Veterinary Medicine Library](#) | [UIUC Library](#) |

Please direct all comments or requests for information to [M. Williams](#).

Lily of the Valley

(*Convallaria majalis*)



[Additional images of Lily of the Valley](#)

| Plant Lists: [Scientific](#) or [Common](#) | [Veterinary Medicine Library](#) | [UIUC Library](#) |

Last updated: March 4, 1997

Please direct all comments or requests for information to [M. Williams](#).

Lupine

(*Lupinus*)



[Additional images of Lupine](#)

| [Description](#) | [Distribution](#) | [Conditions of poisoning](#) | [Toxic principle](#) | [Clinical signs](#) |

| Plant Lists: [Scientific](#) or [Common](#) | [Veterinary Medicine Library](#) | [UIUC Library](#) |

Last updated: August 5, 1996

Please direct all comments and suggestions to [M. Williams](#).

Maple, Red

(*Acer rubrum*)

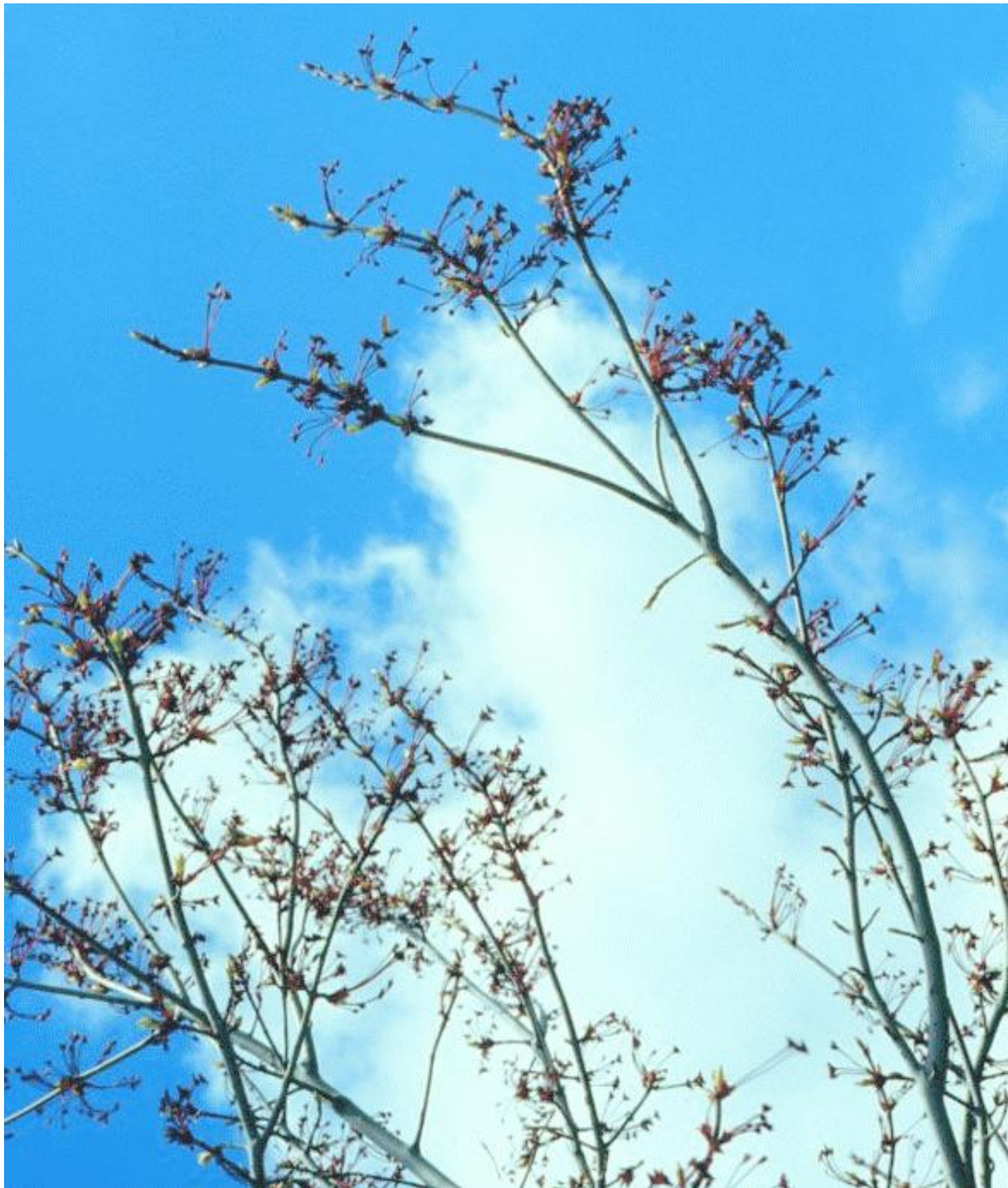

| Plant Lists: [Scientific](#) or [Common](#) | [Veterinary Medicine Library](#) | [UIUC Library](#) |

Last updated: March 3, 2003

Please direct all comments or requests for information to [M. Williams](#).

Photo is copyright 1996 by Mitsuko Williams.

Mayapple

(*Podophyllum peltatum* L.)



[Additional images of Mayapple](#)

Description

Mayapple is a perennial herb of the Barberry family. Leaves are umbrella-shaped and are about 8 inches wide with 5-9 lobes. Plants that have a single leaf do not flower, while those with two leaves develop a single flower in the axil of the leaf stalks. The flower appears at the end of the downward-curved flower stalk about 1 inch long. The flower, with 6 or more white petals and about 1.5-2 inches across, blooms in April to May, and is eventually replaced by a green ovoid fruit. The plant withers away by mid-summer.

Although the creeping, fleshy rhizome has been used to prepare medicine commercially, it is poisonous by contact. The green leaves and unripened fruit are poisonous but the fruit becomes

edible as it ripens and turns greenish-yellow in color.

| [Distribution](#) | [Conditions of poisoning](#) | [Toxic principle](#) | [Clinical signs](#) |

| Plant Lists: [Scientific](#) or [Common](#) | [Veterinary Medicine Library](#) | [UIUC Library](#) |

Last updated: July 16, 1996

Please direct all comments or requests for information to [M. Williams](#).

Common Milkweed

(*Asclepias syriaca* L.)



[Additional Images of Common Milkweed](#)

| Plant Lists: [Scientific](#) or [Common](#) | [Veterinary Medicine Library](#) | [UIUC Library](#) |

Last updated: July 25, 1997

Please direct all comments or requests for information to [M. Williams](#).

Purple Mint

(*Perilla frutescens*)



[Additional images of Purple Mint](#)

| Plant Lists: [Scientific](#) or [Common](#) | [Veterinary Medicine Library](#) | [UIUC Library](#) |

Last updated: August 6, 1996

Please direct all comments or requests for information to [M. Williams](#).

Nightshade

(*Solanum* spp.)



Description

About 1,500 *Solanum* species exist in the world, and they include some of the most common garden plants such as potato (*Solanum tuberosum* L.) and eggplant (*Solanum melongena* L.). One of the species, Jerusalem cherry (*Solanum pseudocapricum* L.) is grown as a house plant for its compact form and small round berries which turn bright red at maturity. The tomato (*Lycopersicon esculentum* Mill.) is also a related plant. Included in this entry are descriptions of Black Nightshade, Bittersweet Nightshade, Silverleaf Nightshade, and Horse Nettle. Other related species may be found under their own names.

Bittersweet Nightshade (*S. dulcamara*)

Bittersweet nightshade is also known as European bittersweet or climbing nightshade. This plant grows from rhizomes and is a slender climbing or trailing perennial reaching 6 feet in length. Leaves are alternate, ovate, simple or deeply lobed, 1-1/2 to 4 inches long, and pointed at the tip. Flowers are deep purple or bluish purple with flower stalk arising between the leaf nodes or opposite the leaves. Nearly round fruits turn red when mature and stay on the vines through mid winter.

[Black Nightshade \(*S. nigrum*\)](#)

Black nightshade is an annual herb with a tap root. Stems are erect and much branched reaching 3 feet tall. Leaves alternate, ovate or lanceolate, and long-stalked. The flower has 5 white petals, sometimes with a yellow inner star, and ranges from 1/4 inch to 3/8 inch across. Berries are round

and about 1/4 or so inches across, green, and turn purplish to black when ripe. Immature berries and foliage are toxic, but ripe fruits are reportedly edible.

Plants commonly known as back nightshade may include two native species, American Black Nightshade (*S. americanum* P. Mill.) and Eastern Black Nightshade (*S. ptycanthum* Dun.), as well as *S. nigrum* which was introduced from Europe and is widely naturalized. *Solanum ptycanthum* may be more commonly found in the midwest since *S. americanum* appears to be more concentrated in the southern states.

[Horse Nettle, Bull Nettle \(*S. carolinense*\)](#)

A perennial with a deep taproot and rhizome below ground. Its stem and leaves have yellowish spines and sometimes are hairy. Leaves are alternate and ovate with irregularly wavy or lobed margins. Flowers appear in June to August, are light purple to white, 3/4 to 1 inch across, and in short racemes near the top of the plant. Petals are united with 5 points at the margin. Fruits are globose, about 1/2 inch in diameter and yellow when mature. Yellow or brownish seeds are numerous, and irregularly circular, about 1/8 inch across.

Silverleaf Nightshade or White Horse-Nettle (*S. eleagnifolium*)

This perennial herb gets its common name because of its silvery appearance caused by the numerous fine hairs. Its thick, lanceolate leaves are wavy and roughly indented (sinuate). The stems and parts of the leaves have short stiff spines. The flowers appear at the end of branches and have petals which are pale to deep blue or lavender in color.

[Jerusalem Cherry \(*S. pseudocapsicum*\)](#)

| [Distribution](#) | [Conditions of poisoning](#) | [Control](#) | [Toxic principle](#) | [Clinical signs](#) |

| Plant Lists: [Scientific](#) or [Common](#) | [Veterinary Medicine Library](#) |

Last updated: July 30, 1997

Please direct all comments or requests for information to [M. Williams](#).

Oleander

(*Nerium oleander* L.)



| Plant Lists: [Scientific](#) or [Common](#) | [Veterinary Medicine Library](#) | [UIUC Library](#) |

Last revised 12/07/95

Please direct all comments or requests for information to [M. Williams](#).

Ohio Buckeye or Horse Chestnut

(*Aesculus glabra* Willd.)



[Additional images of Ohio Buckeye](#)

| [Description](#) | [Distribution](#) | [Conditions of poisoning](#) | [Control](#) | [Toxic principle](#) | [Clinical signs](#) |

| Plant Lists: [Scientific](#) or [Common](#) | [Veterinary Medicine Library](#) | [UIUC Library](#) |

Last updated: August 5, 1995

Please direct all comments or requests for information to [M. Williams](#).

Philodendron

(*Philodendron* spp.)



| Plant Lists: [Scientific](#) or [Common](#) | [Veterinary Medicine Library](#) | [UIUC Library](#) |

Last updated: June 20, 1996

Please direct all comments or requests for information to [M. Williams](#).

Poke or Pokeberry or Pokeweed

(*Phytolacca americana* L.)
(= *P. decandra* L.)



[Additional Images of Pokeweed](#)

Description

Poke is an erect, branched, smooth herb with coarse, succulent, purplish stems; at maturity it is 3 to 10 feet tall. Its leaves, borne on short stalks, are alternately placed and ovate and are without teeth on their margins. Leaves grow up to about 5 inches long. Poke bears small white flowers on short flowerstalks along separate branches at the growing tip of the plant and in the axils of the leaves. Each flower becomes a dark purple berry, flattened and spherical. The berries contain crimson juice and about 10 seeds each.

A perennial, poke comes up year after year from an enormous taproot but it is spread only by seed.

| [Distribution](#) | [Conditions of poisoning](#) | [Control](#) | [Toxic principle](#) | [Clinical signs](#) |

| Plant Lists: [Scientific](#) or [Common](#) | [Veterinary Medicine Library](#) | [UIUC Library](#) |

Last updated: January 22, 1997

Please direct all comments or requests for information to [M. Williams](#).

Rhododendron

(*Rhododendron* spp.)



[Additional images of Rhododendron](#)

Description

Rhododendron is a genus of a shrub with about 800 species worldwide. Its ovate evergreen or deciduous leaves are alternate, 1/2 - 8 inches in length depending on variety, with smooth untoothed margins. They are dark green with a glossy upper surface and a dull underside. Large trusses of bell-shaped flowers bloom from spring to early summer. Plants are available with flowers in colors such as white, purple, deep rose, red, yellow, and orange. Rhododendron and its closely related azalea have been hybridized for many uses in gardens and rarely reach above 3-5 feet tall in northern states including Illinois.

| [Distribution](#) | [Conditions of poisoning](#) | [Toxic Principle](#) | [Clinical signs](#) |

| Plant Lists: [Scientific](#) or [Common](#) | [Veterinary Medicine Library](#) |

Last updated: July 16, 1996

Please direct all comments or requests for information to [M. Williams](#).

Rhubarb

(*Rheum rhaponticum*)



[Additional images of Rhubarb](#)

| Plant Lists: [Scientific](#) or [Common](#) | [Veterinary Medicine Library](#) | [UIUC Library](#) |

Last updated: July 30, 1996

Please direct all comments or requests for information to [M. Williams](#).

Sudan Grass

(*Sorghum vulgare* var. *sudanense* Hitchc.)

Sudan Grass
[*Sorghum vulgare* var. *sudanense*]



[Additional Images of Sudan Grass](#)

| Plant Lists: [Scientific](#) or [Common](#) | [Veterinary Medicine Library](#) | [UIUC Library](#) |

Last updated: January 22, 1997

Please direct all comments or requests for information to [M. Williams](#).

Tulip

(*Tulipa* spp.)



[Additional images of Tulip](#)

| Plant Lists: [Scientific](#) or [Common](#) | [Veterinary Medicine Library](#) | [UIUC Library](#) |

Last updated: August 12, 1996

Please direct all comments or requests for information to [M. Williams](#).

White Snakeroot

(*Eupatorium rugosum* Hout.)
(formerly known as *Eupatorium urticaefolium*)



[Additional images of White Snakeroot](#)

Description

White snakeroot is an erect, branched herb usually about 3 feet tall but varying from 1 to 5 feet. It has slender, round stems and branches bearing pointed, oval, oppositely placed leaves. These leaves, 3 to 5 inches long and petioled, are sharply toothed on the margins. Each leaf has 3 main veins that show prominently on the underside. The roots are fibrous, coarse, and shallow.

In late summer, numerous small heads of minute white flowers appear at the top of the stem and the ends of the branches. These flower heads, except that they are white, are almost exactly like the flower heads of the familiar ageratum of gardens. Later the flowers are replaced in the heads by small black seeds each with a crown of soft white hairs.

Because the leaves of white snakeroot resemble those of the nettle, other plants with nettle-like leaves are often mistaken for it. Two such plants are the nettle-leaved sage and the nettle-leaved vervain. Even without flowers or fruit, these plants can be easily distinguished from white snakeroot. The nettle-leaved sage, a rare plant in some southern Illinois counties, has square stems; white snakeroot stems are round. The nettle-leaved vervain, a common weed throughout Illinois,

has lance-shaped leaves; white snakeroot leaves are broad at the base but narrow quickly in a wedge-shaped part to the petiole.

| [Distribution](#) | [Conditions of poisoning](#) | [Control](#) | [Toxic principle](#) | [Clinical signs](#) |

| Plant Lists: [Scientific](#) or [Common](#) | [Veterinary Medicine Library](#) | [UIUC Library](#) |

Last updated: August 5, 1996

Please direct all comments or requests for information to [M. Williams](#).

Wild Onion

(*Allium* spp.)



[Additional images of Wild Onion](#)

Description

Wild onion (*A. validum* or *A. canadense*) is a bulbous herb of the Amaryllis family and is a close relative of cultivated onion (*Allium cepa* L.). It has a distinct onion odor. It has slender grass-like leaves and reaches about 2 feet in height when flowers appear in late summer. Leaves are narrow, long, and with parallel edges arising from the small underground bulb. Flowers, varying in color, depending on the species, from white to pink, appear at the top of a leafless stem and eventually become bulblets which drop to the ground and propagate.

It is thought that the name Chicago is derived from the smell of wild onions:

"Indians, mainly Potawatomi, who were the most powerful tribe around the south end of Lake Michigan, hunted, traded furs, and occasionally camped in the area they called "Checagou," evidently referring to the garlic wild onion smell which permeated the air."

Encyclopedia of Illinois, 2nd. Edition. Somerset Publishers, New York, 1994. p. 138.

| [Distribution](#) | [Conditions of poisoning](#) | [Toxic principle](#) | [Clinical signs](#) |

| Plant Lists: [Scientific](#) or [Common](#) | [Veterinary Medicine Library](#) | [UIUC Library](#) |

Last updated: May 7, 1999

Please direct all comments or requests for information to [M. Williams](#).

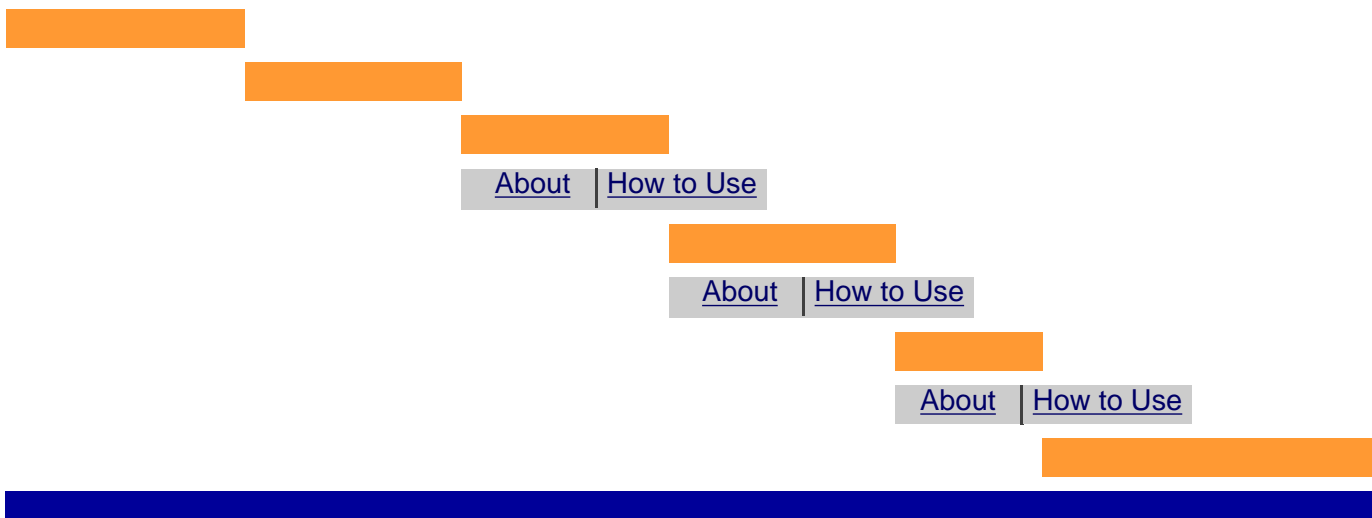

About Veterinary Medicine Library Select Resources

- [About the VM Library](#)
- [Hours and Location](#)
- [Missing Journal Volumes/Issues](#)
- [News](#)
- [New Books](#)

Services

- [Guides and Bibliographies](#)
- [How to renew library materials](#)
- [Loansome Doc](#)
- [Orientation](#)
- [Photocopy & Information Service](#)
- [Reference Service](#)
- [Select Tips on Using UIUC Online](#)
- [Library Catalog](#)

Terminology

- [Journal Abbreviations](#)
- [Veterinary Acronyms](#)
- [More...](#)

- [AGRICOLA](#)
- [Biological Abstracts](#)
- [Consultant](#)
- [Current Contents](#)
- [European Veterinary Dissertations \(EVD\)](#)
- [Int. Pharmaceutical Abstracts](#)
- [Journal Citation Reports](#)
- [MD Consult - about](#)
- [Online Books](#)
- [Plants Toxic to Animals](#)
- [SciFinder Scholar \(Chem Abs\)](#)
- [TOXNET](#)
- [Truncation Guide for searching databases](#)
- [Web of Science](#)
- [Wildlife Worldwide](#)
- [WorldCat](#)
- [Zoological Record](#)

[Veterinary Medicine Related Links](#)

Community Service Information

[Bibliographies for animal owners](#)
[Pet Care Home Page](#)
[Science Fair Project Index](#)
[UIUC College of Veterinary Medicine](#)
[Veterinary Partner](#)

Order Books and Articles

[Loansome Doc](#)
[Photocopy & Information Services](#)
[UIUC Interlibrary Loan](#)

Other UIUC Libraries

[ACES Library](#)
[Biology Library](#)
[Chemistry Library](#)
[Natural History Library](#)
[Environmental Studies Virtual Lib](#)
[More...](#)

Search the UIUC Library website:

Search the Veterinary Medicine Library website:



[University of Illinois at Urbana-Champaign](#)

[Library Gateway Homepage](#)

Comments to: [Greg Youngen](#)

Updated on: 3/19/04 KJH, 07/25/03 KMD, 9/4/2001 MKS, 5/12/1999 WHF

Revised March 18, 2004 by [KMD](#)



HOME





Nightshade, Bittersweet

(*Solanum dulcamara* L.)



| Plant Lists: [Scientific](#) or [Common](#) | [Veterinary Medicine Library](#) | [UIUC Library](#) |

Last updated: March 25, 1996

Please direct all comments or requests for information to [M. Williams.](#)

Alfalfa

(*Medicago sativa* L.)

Additional Images

Below are small images of additional photographs taken of Alfalfa. If you would like to see any of these images enlarged, simply click on the photo.



[Return to Description for Alfalfa](#)

| Plant Lists: [Scientific](#) or [Common](#) | [Veterinary Medicine Library](#) | [UIUC Library](#) |

Last updated: August 14, 1996

Please direct all comments or requests for information to [M. Williams](#).

Bouncing Bet

(*Saponaria officinalis* L.)

Additional Images

Below are small images of additional photographs taken of Bouncing Bet. If you would like to see any of these images enlarged, simply click on the photo.

[Bouncing Bet in mid summer](#)



[Bouncing Bet in Autumn](#)



[Bouncing Bet with seed pods](#)



[Return to Description for Bouncing Bet](#)

| Plant Lists: [Scientific](#) or [Common](#) | [Veterinary Medicine Library](#) | [UIUC Library](#) |

Last updated: January 17, 1997

Please direct all comments or requests for information to [M. Williams.](#)

Bouncing Bet

(*Saponaria officinalis* L.)



[Additional images of Bouncing Bet](#)

Description

Bouncing bet is a herbaceous perennial, 1-3 feet tall, which grows from rhizomes. Its close relative, cow cockle (*Saponaria vaccaria* L.), is an annual. The stems are erect and jointed with opposite elliptic leaves which are 3-4 inches long and 1/2 to 1-1/2 inches wide at the middle. The leaf margins lack teeth.

The flowers come in clusters of cylindric sepals and bloom from June to September, displaying 5-6 petals notched at the apex. Petal colors range from white to pink. The fruit is a capsule about 1 inch long and 1/4 inch thick containing many somewhat round black seeds. The seeds have minute bumps on the surface.

[|Distribution](#) | [Conditions of poisoning](#) | [Control](#) | [Toxic principle](#) | [Clinical signs](#) |

| Plant Lists: [Scientific](#) or [Common](#) | [Veterinary Medicine Library](#) | [UIUC Library](#) |

Last updated: January 17, 1997

Please direct all comments or requests for information to [M. Williams](#)

Bouncing Bet

(*Saponaria officinalis* L.)

Distribution

Originally from Europe, bouncing bet and the related species, cow cockle (*Saponaria vaccaria* L.), grow in open unused areas, along roadsides and railroad tracks, and waste grounds throughout the U.S. Bouncing bet is found in nearly all counties of Illinois, while cow cockle is limited only to scattered counties in northern and central Illinois. Bouncing bet and cow cockle are considered weeds, although they are attractive plants.

[Description](#) | [Conditions of poisoning](#) | [Control](#) | [Toxic principle](#) | [Clinical signs](#) |

| Plant Lists: [Scientific](#) or [Common](#) | [Veterinary Medicine Library](#) | [UIUC Library](#) |

Last updated: July 25, 1996

Please direct all comments or requests for information to [M. Williams](#)

Bouncing Bet

(*Saponaria officinalis* L.)

Conditions of poisoning

The abundance of bouncing bet along roadsides and in other wastelands makes it easily accessible to animals allowed to graze in such places. Although the entire plant is poisonous, the seeds contain the largest concentration of the toxic principle.

[Description](#) | [Distribution](#) | [Control](#) | [Toxic principle](#) | [Clinical signs](#)

| Plant Lists: [Scientific](#) or [Common](#) | [Veterinary Medicine Library](#) | [UIUC Library](#) |

Last updated: July 25, 1996

Please direct all comments or requests for information to [M. Williams](#).

Bouncing Bet

(*Saponaria officinalis* L.)

Control

Screenings of grain should be checked for large quantities of *Saponaria* seeds. Animals tend to avoid contaminated feed because the plants apparently are distasteful. Animals should not be grazed where *Saponaria* species is abundant, especially when the pasture grasses are present in short supply or are exceedingly dry.

[Description](#) | [Distribution](#) | [Conditions of poisoning](#) | [Toxic principle](#) | [Clinical signs](#) |

| Plant Lists: [Scientific](#) or [Common](#) | [Veterinary Medicine Library](#) | [UIUC Library](#) |

Last updated: July 25, 1996

Please direct all comments or requests for information to [M. Williams](#).

Bouncing Bet

(*Saponaria officinalis* L.)

Toxic principle

Bouncing Bet contains large amounts of saponins, which froth when extracted with water. The saponins are soluble in water and alcohol. The sapotoxins of these saponins are similar or identical to those of corn cockle (*Agrostemma Githago*). Hydrolysis of the saponins yields sugars and sapogonins, a group of physiologically active substances.

The toxic material is contained in highest concentration in the seeds. Most animals refuse to eat the seeds and avoid grains or screenings containing them. Feeding of the plant itself to sheep in an amount of 3% of the body weight caused death within 4 hours; the plant weight being expressed on a dry-weight basis.

[Description](#) | [Distribution](#) | [Conditions of poisoning](#) | [Control](#) | [Clinical signs](#)

| Plant Lists: [Scientific](#) or [Common](#) | [Veterinary Medicine Library](#) | [UIUC Library](#) |

Last updated: April 2, 1996

Please direct all comments or requests for information to [M. Williams](#).

Bouncing Bet

(*Saponaria officinalis* L.)

Clinical signs

Poisoning caused by bouncing bet is usually mild, as animals tend to avoid the feed that contains this plant. The poison irritates the digestive tract and may cause vomiting, signs suggestive of nausea, and diarrhea. Slowed or rapid breathing as well as unsteadiness, ataxia and coma also are associated with poisoning by this plant.

[|Description](#) |[Distribution](#) |[Conditions of poisoning](#) |[Control](#) |[Toxic principle](#)|

| Plant Lists: [Scientific](#) or [Common](#) | [Veterinary Medicine Library](#) | [UIUC Library](#) |

Last updated: July 25, 1996

Please direct all comments or requests for informatino to [M. Williams](#).



English	Contactez-nous	Aide	Recherche	Site du Canada
À venir	À notre sujet	Liens	Rapports et publications	Accueil

Système canadien d'information sur la biodiversité



Système canadien d'information sur les plantes toxiques

[Introduction](#)

[Recherche interactive](#)

[Liste de toutes les plantes toxiques par nom
scientifique](#)

[Liste de toutes les plantes toxiques par nom
commun](#)

[Les principaux sites Web sur les plantes
toxiques](#)



préparé par

[Derek B. Munro](#)

spécialiste de l'informatique biologique

- [Introduction](#)
- [Recherche interactive](#)
- [Liste de toutes les plantes toxiques par nom scientifique](#)
- [Liste de toutes les plantes toxiques par nom commun](#)
- [Les principaux sites Web sur les plantes toxiques](#)
- [Avertissement](#)
- [Droits d'auteur](#)
- [données XML \(pour les programmeurs\)](#)

[English](#) | [Contactez nous](#) | [Aide](#) | [Recherche](#) | [Site du Canada](#)
[À venir](#) | [À notre sujet](#) | [Liens](#) | [Rapports et publications](#) |
[Accueil](#)

Date de modification: 2003-02-06

[Avis important](#)



Français	Contact us	Help	Search	Canada site
Coming events	About CBIF	Links	Reports and publications	Home

Canadian Biodiversity Information Facility



Site Index

[Introduction](#)

[Interactive](#)

[All poisonous plants by Botanical name](#)

[All poisonous plants by Common name](#)

[Important WWW Poisonous Plants sites](#)



- [About the Canadian Biodiversity Information Facility](#)
- Databases
 - [Biological Observations, Specimens and Collections \(BiOSC\) Gateway](#)
 - [Canadian Poisonous Plants Information System](#)
 - [Integrated Taxonomic Information System \(ITIS\)](#)
 - [Species Analyst Canada](#)
 - [Birds \(Aves\)](#)
 - [Reptiles and amphibians \(Reptilia and Amphibia\)](#)
 - [Fish \(Osteichthyes\)](#)
 - [Butterflies \(Lepidoptera\)](#)
 - [Ants, wasps, bees \(Hymenoptera\)](#)
 - [Plants \(Plantae\)](#)
- [Reports and publications](#)
- [SpeciesBank](#)
 - [Butterflies of Canada](#)
- [Biodiversity Knowledge and Innovation Network](#)

[Français](#) | [Contact Us](#) | [Help](#) | [Search](#) | [Canada site](#)
[Coming Events](#) | [About CBIF](#) | [Links](#) | [Reports and Publications](#) |
[Home](#)

Date modified: 2003-02-06

[Important Notices](#)



Français	Contact Us	Help	Search	Home
What's New	Publications	About Government	About Canada	Provinces and Territories

Quick Tips**E-Forms and Services****Government Contacts:**

- E-mail
- Telephone
- In Person
- Your MP

Find Information and Services by:

- Subjects and Audiences
- Departments and Agencies
- A to Z Index
- Frequently Asked Questions

Sign Up for E-mail Updates 

Create Your Customized Page 

Government Announcements 

Search All Government of Canada Web Sites

[Help](#) [Advanced Search](#)

[Other Government of Canada Search Engines](#)

Language to search:

Return documents containing:

Search Terms:

[Synonyms](#) [Translated Terms](#) [Feedback on the Search Engine](#)

In order to experience the full capabilities of the "Synonyms" and "Translated Terms" Modules, please enable JavaScript on your browser.

[About This Site](#) [Quick Tips](#) [Site Map](#) [Tell Us What You Think](#)

Last updated: 2003-03-31

[Important Notices](#)



Français	Contact Us	Help	Search	Home
What's New	Publications	About Government	Quick Tips	Provinces and Territories

Prime Minister of Canada 

Government Announcements

I'M TAKING THE One-Tonne CHALLENGE ARE YOU?

Take action on Climate Change

Government News

E-Forms and Services

Government Contacts:

- E-mail
- Telephone
- In Person
- Your MP

Departments and Agencies

A to Z Index

Frequently Asked Questions

Sign Up for E-mail Updates 

Create Your Customized Page 

We've Gone Mobile! 



▶ Canadians



▶ Non-Canadians



▶ Canadian Business

Easy access to trusted information on topics such as [ID cards](#), [travel](#), [jobs](#), [financial benefits](#), the [environment](#), services for [consumers](#), [youth](#), [children](#), and [more topics...](#)

The information source for Non-Canadians: Find out about **immigration, tourism, doing business, studying, global affairs**, and [more...](#)

Your source for federal, provincial and territorial information and services such as **business start-up, taxes, financing**, and [more topics...](#)

About Canada



Society, Government, Land, Economy

Search:

[More Search Options](#)

How do I find information on...

[About This Site](#)

[Quick Tips](#)

[Site Map](#)

[Tell Us What You Think](#)

Last updated: 2004-05-03

[Important Notices](#)



Français	Contact us	Help	Search	Canada site
Coming events	About CBIF	Links	Reports and publications	Home

Canadian Biodiversity Information Facility



Coming events

[ITIS](#)

[Biological name search](#)

[BiOSC](#)

[Global specimen information networks](#)

[Species Access](#)

[Canadian specimen information network](#)

[Point Mapper](#)

[Make your own map](#)

[SpeciesBank](#)

[FBIP](#)



April 25-30, 2004

Eighth meeting of the GBIF Governing Board (GB8)

Oaxaca, Mexico

The eighth meeting of the Governing Board (GB8) of the Global Biodiversity Information Facility (GBIF), GBIF committee and subcommittee meetings, and the Science Symposium will take place in April 2004 (25th-30th).

For more information: <http://www.gbif.org/GB8/>

[Français](#) | [Contact Us](#) | [Help](#) | [Search](#) | [Canada site](#)

[Coming Events](#) | [About CBIF](#) | [Links](#) | [Reports and Publications](#) |

[Home](#)

Date Modified: 2003-03-25

[Important Notices](#)



Français	Contact us	Help	Search	Canada site
Coming events	About CBIF	Links	Reports and publications	Home

Canadian Biodiversity Information Facility



About the Canadian Biodiversity Information Facility

[ITIS](#)

[Biological name search](#)

[BiOSC](#)

[Global specimen information networks](#)

[Species Access](#)

[Canadian specimen information network](#)

[Point Mapper](#)

[Make your own map](#)

[SpeciesBank](#)

[FBIP](#)



- [Partners in the network](#)
- [Some of the problems that CBIF will address](#)
- [Reports and background information](#)

Partners in CBIF

CBIF is made up of the five federal natural resource departments ([5NR departments](#)) and other partners:

The 5NR

- [Agriculture and Agri-Food Canada](#)
- [Environment Canada](#)
- [Fisheries and Oceans Canada](#)
- [Health Canada](#)
- [Natural Resources Canada](#)

Other partners

- [Canadian Food Inspection Agency](#)
- [Canadian Museum of Nature](#)
- [Parks Canada](#)

[Français](#) | [Contact Us](#) | [Help](#) | [Search](#) | [Canada site](#)
[Coming Events](#) | [About CBIF](#) | [Links](#) | [Reports and Publications](#) |
[Home](#)

Date Modified: 2003-03-25

[Important Notices](#)



Français	Contact us	Help	Search	Canada site
Coming events	About CBIF	Links	Reports and publications	Home

Canadian Biodiversity Information Facility



Links

[ITIS](#)

[Biological name search](#)

[BiOSC](#)

[Global specimen information networks](#)

[Species Access](#)

[Canadian specimen information network](#)

[Point Mapper](#)

[Make your own map](#)

[SpeciesBank](#)

[FBIP](#)



- **Canadian Biodiversity Information Network (CBIN)** -CBIN is a node an international clearinghouse of information on biodiversity. Its goal is to provide information on Canadian biodiversity from ALL sectors. Explore Canadian environmental policy and agreements, technology, data, funding programs, web sites, upcoming events, reference material, expertise, and more.
[\[http://www.cbin.ec.gc.ca/search/default.cfm?lang=e\]](http://www.cbin.ec.gc.ca/search/default.cfm?lang=e)
- **Plant Gene Resources of Canada** -Search the Genetic Resource Information Network, Canadian version. Canada uses a computerized database management system to assist in handling the massive amounts of data associated with the genetic resources. Researchers can learn about specific characteristics for each accession in the collection. All nodes interact with the database regularly, entering data, conducting searches and so on. Seed requests can also be made through the database.
[\[http://pgrc3.agr.gc.ca/search_grinca-recherche_rirgc_e.html\]](http://pgrc3.agr.gc.ca/search_grinca-recherche_rirgc_e.html)
- **Consultation on FAO Treaty on Plant Genetic Resources** -Agriculture and Agri-Food Canada is soliciting comments on the FAO International Treaty on Plant Genetic Resources for Food and Agriculture leading to a decision on Canadian ratification and signature of the Treaty. The text of the Treaty, FAO Conference resolution, the text of the Canadian statement to the FAO Conference presented by Associate Deputy Minister Diane Vincent and some relevant communication information are presented for your consideration. Although the formal part of this consultation ended on March 31, 2002, your feedback is still welcome.
[\[http://pgrc3.agr.gc.ca/itpgrfa/index_e.html\]](http://pgrc3.agr.gc.ca/itpgrfa/index_e.html)
- **Biodiversity: Connecting with the Tapestry of Life**, prepared by the Smithsonian Institution Monitoring and Assessment of Biodiversity Program
[\[http://www.si.edu/simab/\]](http://www.si.edu/simab/) and click on link to view this publication in PDF format]
- **Global Biodiversity Information Facility** - "an interoperable network of biodiversity databases and information technology tools that will enable users to navigate and put to use the world's vast quantities of biodiversity information to produce national economic, environmental and social benefits."
[\[http://www.gbif.org/\]](http://www.gbif.org/)
- **Species Analyst** - A "community editable site" that contains documentation on the Species Analyst project, particularly for the

various software components that make up the network.

[<http://tsadev.speciesanalyst.net/documentation/ow.asp?TsaHome>]

- **World Biodiversity Information Network (REMIB), Mexico** - "a computerized biological information system (i.e., it includes databases of curatorial, taxonomic, ecological, cartographic, bibliographic, ethnobiological and use type, and catalogues of natural resources and other topics) based on a decentralized inter-institutional academic organization formed by research centers and universities, both public and private, that possess both scientific biological collections and information banks."
[http://www.conabio.gob.mx/remib/doctos/remib_esp.html]
- **National Biological Information Infrastructure (NBII), United States** - access to specimens and exhibits from museums around the world; newsletter; FrogWeb; and BioBot, the NBII's biological search engine.
[<http://www.nbii.gov/index.html>]
- **Ecoinformatics.org** - "online data and information management resource for ecologists" sponsored and developed by the Long Term Ecological Research Network and the National Center for Ecological Analysis and Synthesis.
[<http://www.ecoinformatics.org/>]

[Français](#) | [Contact Us](#) | [Help](#) | [Search](#) | [Canada site](#)

[Coming Events](#) | [About CBIF](#) | [Links](#) | [Reports and Publications](#) | [Home](#)

Date Modified: 2003-03-25

[Important Notices](#)



Français	Contact us	Help	Search	Canada site
Coming events	About CBIF	Links	Reports and publications	Home

Canadian Biodiversity Information Facility



Reports and publications

[ITIS](#)[Biological name search](#)[BiOSC](#)[Global specimen information networks](#)[Species Access](#)[Canadian specimen information network](#)[Point Mapper](#)[Make your own map](#)[SpeciesBank](#)[FBIP](#)

Toward a Biodiversity Knowledge and Innovation Network (BKIN) for Canada

[If you would like a copy of a document, please send an email to: [CBIF](#)]

Strategic Report from Canadian Biodiversity Network Conference, Ottawa March 1—4, 2001.



Implementing a BKIN [February 2002]

The need to formally "organize" the stakeholders into a "community" or "association" and how a BKIN Secretariat can manage that network, setting out the rationale for a biodiversity knowledge and innovation network and recommendations for its structure, mandate, and preliminary budget requirements.



The Urgent Need for a BKIN [February 2002]

Describes the impacts already being experienced by not having a well-functioning biodiversity knowledge and innovation network. These impacts also show where a BKIN could be useful to support decision-making in these areas.



The Requirements for a BKIN [February 2002]

This document indicates the infrastructure that is required to establish and maintain a strong biodiversity knowledge and innovation network.

The Biota of Canada Information Network: Documenting and Analysing Canada's Living Capital for Science and Society
Final report on the inaugural workshop of the 5NR Biota of Canada Information Network project, Ottawa March 2-3, 2000.

[Français](#) | [Contact Us](#) | [Help](#) | [Search](#) | [Canada site](#)
[Coming Events](#) | [About CBIF](#) | [Links](#) | [Reports and Publications](#) |
[Home](#)

Date Modified: 2003-03-25

[Important Notices](#)



Français	Contact us	Help	Search	Canada site
Coming events	About CBIF	Links	Reports and publications	Home

Canadian Biodiversity Information Facility



Canadian Biodiversity Information Facility (CBIF)

[ITIS](#)

[Biological name search](#)

[BiOSC](#)

[Global specimen information networks](#)

[Species Access](#)

[Canadian specimen information network](#)

[Point Mapper](#)

[Make your own map](#)

[SpeciesBank](#)

[FBIP](#)

As a member of the [Global Biodiversity Information Facility \(GBIF\)](#), Canada is exploring new ways to improve the organization, exchange, correlation, and availability of primary data on biological species of interest to Canadians. By enhancing access to these data, CBIF provides a valuable resource that supports a wide range of social and economic decisions including efforts to conserve our biodiversity in healthy ecosystems, use our biological resources in sustainable ways, and monitor and control pests and diseases.

CBIF has developed the following tools to help users find the information they need.

Species Access Canada



Species Access Canada is the Canadian component of a global project to allow Internet access to information associated with the billions of specimens housed in the world's natural history collections. The Canadian network currently incorporates collections on five servers; many more will be added over the next few years.

Users can search these collections by species name, source collection, collector, or location.

Note: If you have a specimen database you would like added to Species Access Canada, please contact [CBIF](#)

Integrated Taxonomic Information System

ITIS is a catalogue of common and scientific names that will eventually include all species found in Canada, the United States and Mexico. The database also contains synonyms.

Search results pages for individual species include the taxonomic hierarchy for the species (genus, order, family, etc.). They also provide links to search engines, automatically searching on the pertinent terms for the species you select.

The Biological Observations, Specimens and Collections Gateway

The BiOSC Gateway is a global metadata search engine that cross-walks multiple distributed biodiversity networks and facilitates access to their combined holdings. As of early January 2002, the BiOSC Gateway contained approximately 2.4 million biological records. The gateway associates a biological names harvester with a multilingual taxonomic authority file (ITIS*North America), providing international users with access to biodiversity records by scientific names, vernacular names, synonymy, country of collection or geographic coordinates. Each individual metadata record (either an individual specimen or a single observation) is hyperlinked directly to its primary source on its native biodiversity network, ensuring that end-users access detailed records exclusively via the facility of the owners who remain in full control of their records. Interactive world maps are provided for those biological records that are associated with explicit latitude and longitude coordinates.

[More information about BiOSC](#)

SpeciesBank

Butterflies of Canada is the pilot project in this section of CBIF's web site. Identifying information, photographs, distribution maps, and more are available for all butterflies found in Canada.

[Français](#) | [Contact Us](#) | [Help](#) | [Search](#) | [Canada site](#)
[Coming Events](#) | [About CBIF](#) | [Links](#) | [Reports and Publications](#) | [Home](#)

Date Modified: 2003-03-25

[Important Notices](#)



Français	Contact us	Help	Search	Canada site
Coming events	About CBIF	Links	Reports and publications	Home

Canadian Biodiversity Information Facility



Introduction - Canadian poisonous plants

[Introduction](#)

[Interactive](#)

[All poisonous plants by Botanical name](#)

[All poisonous plants by Common name](#)

[Important WWW Poisonous Plants sites](#)

- [Intended audience](#)
- [What the Information System does](#)
- [What the Information System does not do](#)
- [Illustrations](#)
- [Acknowledgments](#)
- [Project history](#)



The CANADIAN POISONOUS PLANTS INFORMATION SYSTEM presents data on plants that cause poisoning in livestock, pets, and humans. The plants include native, introduced, and cultivated outdoor plants as well as indoor plants that are found in Canada. Some food and herbal plants are also included that may cause potential poisoning problems.

Plant poisoning is caused by chemicals in plants that have undesirable effects upon animals and humans. Some poisons must be ingested whereas others, such as chemicals in poison-ivy, only require contact to elicit response in sensitive humans. Some chemicals must be modified before they are poisonous to animals, such as prunasin and other cyanogenic glycosides. These chemicals must be hydrolyzed by plant enzymes or by rumen organisms.

Plants that cause dermatitis are discussed in this program if the reactions are severe. The more obscure dermatologic plants are not included. For more information on plant-induced dermatitis [see Mitchell, J. C., Rook, A. 1979. [Botanical dermatology](#). Greenglass Ltd, Vancouver, B.C., Canada. 787 pp.].

Other excluded plants are those that only cause mechanical injury, poisonous blue-green algae, and plants causing hay fever.

While the Information System is oriented primarily to a Canadian audience, much of the information is useful elsewhere. Certainly the plants grown in and around homes can be grown throughout the temperate regions of the world. Indeed, many house plants are

tropical in origin. Other plant species included here have been introduced to North America as well as other temperate regions of the world. The information on the native plant species is applicable wherever they grow in North America.

Information included in this program has the following limitations:

- much literature on poisonous plants is anecdotal and therefore of limited reliability
- many plants are only mildly poisonous or cause symptoms in unusual circumstances such as when prodigious quantities of material have been consumed
- the author has attempted to find the most current literature available on each included plant species (up to the 1993 publishing date of the original document). However, in many cases, current information refers to works published early in that century.

[Français](#) | [Contact Us](#) | [Help](#) | [Search](#) | [Canada site](#)
[Coming Events](#) | [About CBIF](#) | [Links](#) | [Reports and Publications](#) | [Home](#)

Date modified: 2003-02-06

[Important Notices](#)



Français	Contact us	Help	Search	Canada site
Coming events	About CBIF	Links	Reports and publications	Home

Canadian Biodiversity Information Facility



Canada: lists of poisonous plants

[Introduction](#)[Interactive](#)

[All poisonous plants by Botanical name](#) **Choose one from each section**

[All poisonous plants by Common name](#) **Choose one from section A**

[Important WWW Poisonous Plants sites](#)

1. Common plant names.
2. Botanical (scientific plant) names.



Choose one from section B

1. Complete list of poisonous plants.
 2. Poisonous house plants only.
 3. Plants with Illustrations.
-
4. Humans/Animals.
 5. Poisonous Plant Parts.
 6. Toxic chemicals.
 7. Distribution (by province).
 8. Symptoms.
 9. Plant family.
-
10. Humans/Animals || Provincial Distribution.
 11. Poisonous Plant Parts || Provincial Distribution.
 12. Humans/Animals || Symptoms.

[Français](#) | [Contact Us](#) | [Help](#) | [Search](#) | [Canada site](#)
[Coming Events](#) | [About CBIF](#) | [Links](#) | [Reports and Publications](#) |
[Home](#)

Date modified: 2003-02-06

[Important Notices](#)



Français	Contact us	Help	Search	Canada site
Coming events	About CBIF	Links	Reports and publications	Home

Canadian Biodiversity Information Facility



All poisonous plants

[Introduction](#)[Interactive](#)[All poisonous plants by Botanical name](#)[All poisonous plants by Common name](#)[Important WWW Poisonous Plants sites](#)**Scientific name**[*Abrus precatorius*](#)[*Acer rubrum*](#)[*Aconitum napellus*](#)[*Aesculus glabra*](#)[*Aesculus hippocastanum*](#)[*Agrostemma githago*](#)[*Ailanthus altissima*](#)[*Allamanda cathartica*](#)[*Allium canadense*](#)[*Allium cepa*](#)[*Allium sativum*](#)[*Allium schoenoprasum*](#)[*Aloe arborescens*](#)[*Aloe barbadensis*](#)[*Alstroemeria ligtu*](#)[*Amaranthus blitoides*](#)[*Amaranthus hybridus*](#)[*Amaranthus retroflexus*](#)[*Amaryllis belladonna*](#)[*Amaryllis vittata*](#)[*Amelanchier alnifolia*](#)[*Amsinckia intermedia*](#)[*Anagallis arvensis*](#)[*Anthurium andraeanum*](#)[*Apocynum androsaemifolium*](#)[*Apocynum cannabinum*](#)[*Arisaema triphyllum*](#)[*Armoracia rusticana*](#)[*Asarum canadense*](#)**Common name**

precatory-pea

red maple

monk's hood

Ohio buckeye

horse-chestnut

purple cockle

tree-of-heaven

golden-trumpet

wild onion

onion

garlic

chives

candalabra aloe

aloe - A. barbadensis

Peruvian lily

prostrate pigweed

smooth pigweed

redroot pigweed

amaryllis (A. belladonna)

amaryllis (A. vittata)

Saskatoon (a serviceberry)

fiddleneck

scarlet pimpernel

flamingo lily

spreading dogbane

hemp dogbane

Jack-in-the-pulpit

horseradish

wild ginger

<u><i>Asclepias speciosa</i></u>	showy milkweed
<u><i>Asclepias syriaca</i></u>	common milkweed
<u><i>Asclepias verticillata</i></u>	eastern whorled milkweed
<u><i>Asimina triloba</i></u>	pawpaw
<u><i>Astragalus adsurgens</i></u>	Astragalus (A. adsurgens)
<u><i>Astragalus bisulcatus</i></u>	two-grooved milk-vetch
<u><i>Astragalus canadensis</i></u>	Canadian milk-vetch
<u><i>Astragalus lentiginosus</i></u>	Astragalus (A. lentiginosus)
<u><i>Astragalus miser</i></u>	timber milk-vetch
<u><i>Avena sativa</i></u>	oats
<u><i>Baptisia leucantha</i></u>	wild false indigo
<u><i>Baptisia tinctoria</i></u>	wild indigo
<u><i>Barbarea vulgaris</i></u>	yellow rocket
<u><i>Bassia hyssopifolia</i></u>	five-hooked bassia
<u><i>Brassaia actinophylla</i></u>	Australian umbrella tree
<u><i>Brassica campestris</i></u>	bird rape
<u><i>Brassica juncea</i></u>	Indian mustard
<u><i>Brassica napus</i></u>	rapeseed
<u><i>Brassica oleracea</i></u>	wild cabbage
<u><i>Caladium bicolor</i></u>	caladium
<u><i>Calla palustris</i></u>	wild calla
<u><i>Cannabis sativa</i></u>	marijuana
<u><i>Caulophyllum thalictroides</i></u>	blue cohosh
<u><i>Centaurea repens</i></u>	Russian knapweed
<u><i>Centaurea solstitialis</i></u>	yellow star-thistle
<u><i>Ceratocephalus testiculatus</i></u>	bur buttercup
<u><i>Chelidonium majus</i></u>	greater celandine
<u><i>Chenopodium album</i></u>	lamb's-quarters
<u><i>Chrysanthemum indicum</i></u>	chrysanthemum
<u><i>Chrysothamnus nauseosus</i></u>	stinking rabbitbrush
<u><i>Cicuta douglasii</i></u>	western water-hemlock
<u><i>Cicuta maculata</i></u>	spotted water-hemlock
<u><i>Cicuta virosa</i></u>	northern water-hemlock
<u><i>Clivia miniata</i></u>	Kaffir lily
<u><i>Codiaeum variegatum</i></u>	croton
<u><i>Colchicum autumnale</i></u>	autumn crocus
<u><i>Conium maculatum</i></u>	poison-hemlock
<u><i>Convallaria majalis</i></u>	lily-of-the-valley

<u><i>Cyclamen persicum</i></u>	cyclamen
<u><i>Cynoglossum officinale</i></u>	hound's tongue
<u><i>Cypripedium acaule</i></u>	pink lady's-slipper
<u><i>Cypripedium calceolus</i></u>	yellow lady's-slipper
<u><i>Cypripedium reginae</i></u>	showy lady's-slipper
<u><i>Daphne cneorum</i></u>	garland daphne
<u><i>Daphne laureola</i></u>	spurge-laurel
<u><i>Daphne mezereum</i></u>	February daphne
<u><i>Datura innoxia</i></u>	angel's trumpet
<u><i>Datura stramonium</i></u>	jimsonweed
<u><i>Delphinium bicolor</i></u>	low larkspur
<u><i>Delphinium glaucum</i></u>	tall larkspur
<u><i>Delphinium menziesii</i></u>	Menzies larkspur
<u><i>Descurainia pinnata</i></u>	green tansy mustard
<u><i>Dicentra canadensis</i></u>	squirrel-corn
<u><i>Dicentra cucullaria</i></u>	Dutchman's-breeches
<u><i>Dicentra formosa</i></u>	western bleedingheart
<u><i>Dictamnus albus</i></u>	gas plant
<u><i>Dieffenbachia amoena</i></u>	giant dumbcane
<u><i>Dieffenbachia bausei</i></u>	dumbcane
<u><i>Dieffenbachia maculata</i></u>	spotted dumbcane
<u><i>Dieffenbachia seguine</i></u>	mother-in-law plant
<u><i>Digitalis purpurea</i></u>	foxglove
<u><i>Dirca palustris</i></u>	leatherwood
<u><i>Echium vulgare</i></u>	blueweed
<u><i>Equisetum arvense</i></u>	field horsetail
<u><i>Equisetum palustre</i></u>	marsh horsetail
<u><i>Erysimum cheiranthoides</i></u>	wormseed mustard
<u><i>Euonymus atropurpureus</i></u>	burningbush
<u><i>Euonymus europaeus</i></u>	European spindle tree
<u><i>Eupatorium rugosum</i></u>	white snakeroot
<u><i>Euphorbia cyparissias</i></u>	cypress spurge
<u><i>Euphorbia esula</i></u>	leafy spurge
<u><i>Euphorbia helioscopia</i></u>	sun spurge
<u><i>Euphorbia lactea</i></u>	candelabra-cactus
<u><i>Euphorbia lathyris</i></u>	caper spurge
<u><i>Euphorbia milii</i></u>	crown-of-thorns
<u><i>Euphorbia peplus</i></u>	petty spurge

<u><i>Euphorbia pulcherrima</i></u>	poinsettia
<u><i>Euphorbia tirucalli</i></u>	penciltree
<u><i>Fagopyrum esculentum</i></u>	buckwheat
<u><i>Galanthus nivalis</i></u>	snowdrop
<u><i>Ginkgo biloba</i></u>	maidenhair tree
<u><i>Glechoma hederacea</i></u>	ground-ivy
<u><i>Gloriosa superba</i></u>	glory lily
<u><i>Glyceria grandis</i></u>	tall manna grass
<u><i>Gutierrezia sarothrae</i></u>	broom snakeweed
<u><i>Gymnocladus dioicus</i></u>	Kentucky coffeetree
<u><i>Hedera helix</i></u>	English ivy
<u><i>Helenium autumnale</i></u>	sneezeweed
<u><i>Helenium flexuosum</i></u>	naked-flowered sneezeweed
<u><i>Helianthus annuus</i></u>	sunflower
<u><i>Heliotropium curassavicum</i></u>	spatulate-leaved heliotrope
<u><i>Heracleum mantegazzianum</i></u>	giant hogweed
<u><i>Humulus lupulus</i></u>	common hop
<u><i>Hyacinthoides nonscripta</i></u>	English bluebell
<u><i>Hydrangea macrophylla</i></u>	hydrangea
<u><i>Hymenoxys richardsonii</i></u>	Colorado rubberweed
<u><i>Hyoscyamus niger</i></u>	black henbane
<u><i>Hypericum perforatum</i></u>	St. John's-wort
<u><i>Ilex aquifolium</i></u>	English holly
<u><i>Ilex opaca</i></u>	American holly
<u><i>Ipomoea tricolor</i></u>	morning glory
<u><i>Iris pseudacorus</i></u>	yellow iris
<u><i>Iris versicolor</i></u>	blue flag iris
<u><i>Iva xanthifolia</i></u>	false ragweed
<u><i>Juglans nigra</i></u>	black walnut
<u><i>Kalanchoe daigremontiana</i></u>	Devil's-backbone
<u><i>Kalmia angustifolia</i></u>	sheep-laurel
<u><i>Kalmia polifolia</i></u>	bog-laurel
<u><i>Kochia scoparia</i></u>	kochia
<u><i>Laburnum anagyroides</i></u>	golden-chain
<u><i>Lactuca scariola</i></u>	prickly lettuce
<u><i>Lantana camara</i></u>	yellow sage
<u><i>Laportea canadensis</i></u>	Canada nettle
<u><i>Lathyrus odoratus</i></u>	sweet pea

<u><i>Lathyrus sativus</i></u>	grass pea
<u><i>Leonurus cardiaca</i></u>	motherwort
<u><i>Ligustrum vulgare</i></u>	common privet
<u><i>Linaria vulgaris</i></u>	yellow toadflax
<u><i>Lobelia cardinalis</i></u>	cardinalflower
<u><i>Lobelia inflata</i></u>	Indian-tobacco
<u><i>Lobelia siphilitica</i></u>	blue cardinalflower
<u><i>Lonicera tatarica</i></u>	Tartarian honeysuckle
<u><i>Lonicera xylosteum</i></u>	fly honeysuckle
<u><i>Lupinus argenteus</i></u>	silvery lupine
<u><i>Lupinus burkei</i></u>	Burke's lupine
<u><i>Lupinus polyphyllus</i></u>	large-leaved lupine
<u><i>Lupinus pusillus</i></u>	small lupine
<u><i>Lupinus sericeus</i></u>	silky lupine
<u><i>Maclura pomifera</i></u>	Osage-orange
<u><i>Mangifera indica</i></u>	mango
<u><i>Medicago sativa</i></u>	alfalfa
<u><i>Melilotus alba</i></u>	white sweet-clover
<u><i>Melilotus officinalis</i></u>	yellow sweet-clover
<u><i>Menispermum canadense</i></u>	moonseed
<u><i>Menziesia ferruginea</i></u>	western minniebush
<u><i>Monstera deliciosa</i></u>	Swiss-cheese plant
<u><i>Narcissus poeticus</i></u>	narcissus
<u><i>Narcissus pseudonarcissus</i></u>	daffodil
<u><i>Nerium oleander</i></u>	oleander
<u><i>Nicotiana tabacum</i></u>	tobacco
<u><i>Onoclea sensibilis</i></u>	sensitive fern
<u><i>Ornithogalum umbellatum</i></u>	star-of-Bethlehem
<u><i>Oxytropis lambertii</i></u>	purple locoweed
<u><i>Oxytropis sericea</i></u>	locoweed (<i>Oxytropis sericea</i>)
<u><i>Papaver nudicaule</i></u>	Iceland poppy
<u><i>Papaver orientale</i></u>	Oriental poppy
<u><i>Papaver rhoeas</i></u>	corn poppy
<u><i>Papaver somniferum</i></u>	opium poppy
<u><i>Parthenocissus quinquefolia</i></u>	Virginia creeper
<u><i>Pastinaca sativa</i></u>	wild parsnip
<u><i>Persea americana</i></u>	avocado
<u><i>Phacelia campanularia</i></u>	California bluebell

<u><i>Phalaris arundinacea</i></u>	reed canarygrass
<u><i>Philodendron cordatum</i></u>	philodendron
<u><i>Philodendron scandens</i></u>	heart-leaved philodendron
<u><i>Phoradendron flavescens</i></u>	American mistletoe
<u><i>Physalis alkekengi</i></u>	Chinese-lantern
<u><i>Physalis peruviana</i></u>	ground-cherry
<u><i>Phytolacca americana</i></u>	pokeweed
<u><i>Pinus ponderosa</i></u>	ponderosa pine
<u><i>Podophyllum peltatum</i></u>	May-apple
<u><i>Primula obconica</i></u>	primula
<u><i>Prunus pensylvanica</i></u>	pin cherry
<u><i>Prunus serotina</i></u>	black cherry
<u><i>Prunus virginiana</i></u>	red chokecherry
<u><i>Pteridium aquilinum</i></u>	bracken
<u><i>Quercus alba</i></u>	white oak
<u><i>Quercus rubra</i></u>	red oak
<u><i>Quercus velutina</i></u>	black oak
<u><i>Ranunculus bulbosus</i></u>	bulbous buttercup
<u><i>Ranunculus sceleratus</i></u>	celery-leaved buttercup
<u><i>Raphanus raphanistrum</i></u>	wild radish
<u><i>Raphanus sativus</i></u>	radish
<u><i>Rhamnus cathartica</i></u>	European buckthorn
<u><i>Rhamnus frangula</i></u>	alder buckthorn
<u><i>Rheum rhaponticum</i></u>	rhubarb
<u><i>Rhododendron albiflorum</i></u>	white rose-bay
<u><i>Rhododendron macrophyllum</i></u>	California rose-bay
<u><i>Rhus diversiloba</i></u>	western poison-oak
<u><i>Rhus radicans</i></u>	poison ivy
<u><i>Rhus vernix</i></u>	poison sumac
<u><i>Ricinus communis</i></u>	castor-bean
<u><i>Robinia pseudoacacia</i></u>	black locust
<u><i>Rudbeckia laciniata</i></u>	cut-leaved coneflower
<u><i>Rudbeckia serotina</i></u>	black-eyed Susan
<u><i>Rumex acetosa</i></u>	garden-sorrel
<u><i>Rumex acetosella</i></u>	sheep sorrel
<u><i>Rumex venosus</i></u>	veined dock
<u><i>Sambucus canadensis</i></u>	American elder
<u><i>Sambucus nigra</i></u>	European elder

<u><i>Sarcobatus vermiculatus</i></u>	greasewood
<u><i>Scilla siberica</i></u>	Siberian scilla
<u><i>Senecio integerrimus</i></u>	entire-leaved groundsel
<u><i>Senecio jacobaea</i></u>	tansy ragwort
<u><i>Senecio vulgaris</i></u>	common groundsel
<u><i>Sinapis arvensis</i></u>	wild mustard
<u><i>Solanum dulcamara</i></u>	climbing nightshade
<u><i>Solanum nigrum</i></u>	black nightshade
<u><i>Solanum pseudocapsicum</i></u>	Jerusalem-cherry
<u><i>Solanum tuberosum</i></u>	potato
<u><i>Solidago mollis</i></u>	velvety goldenrod
<u><i>Sorghum bicolor</i></u>	Sorghum
<u><i>Sorghum halepense</i></u>	Johnson grass
<u><i>Sorghum sudanense</i></u>	Sudan grass
<u><i>Suckleya suckleyana</i></u>	poison suckleya
<u><i>Symphoricarpos albus</i></u>	thin-leaved snowberry
<u><i>Symphytum asperum</i></u>	prickly comfrey
<u><i>Symphytum officinale</i></u>	common comfrey
<u><i>Symplocarpus foetidus</i></u>	skunk cabbage
<u><i>Tanacetum vulgare</i></u>	tansy
<u><i>Taxus baccata</i></u>	English yew
<u><i>Taxus canadensis</i></u>	Canada yew
<u><i>Taxus cuspidata</i></u>	Japanese yew
<u><i>Thermopsis rhombifolia</i></u>	golden-bean
<u><i>Thlaspi arvense</i></u>	stinkweed
<u><i>Trifolium hybridum</i></u>	alsike clover
<u><i>Trifolium pratense</i></u>	red clover
<u><i>Trifolium repens</i></u>	white clover
<u><i>Triglochin maritima</i></u>	seaside arrow-grass
<u><i>Triglochin palustre</i></u>	marsh arrow-grass
<u><i>Tulipa gesneriana</i></u>	tulip
<u><i>Urtica dioica</i></u>	stinging nettle
<u><i>Veratrum viride</i></u>	false hellebore
<u><i>Viburnum opulus</i></u>	Guelder-rose
<u><i>Vicia faba</i></u>	broad bean
<u><i>Vicia sativa</i></u>	common vetch
<u><i>Vicia villosa</i></u>	hairy vetch
<u><i>Wisteria floribunda</i></u>	Japanese wisteria

[*Xanthium strumarium*](#)

cocklebur

[*Zigadenus elegans*](#)

white camas

[*Zigadenus venenosus*](#)

death camas

[Another search?](#)

[Français](#) | [Contact Us](#) | [Help](#) | [Search](#) | [Canada site](#)

[Coming Events](#) | [About CBIF](#) | [Links](#) | [Reports and Publications](#) |

[Home](#)

Date modified: 2003-02-06

[Important Notices](#)



Français	Contact us	Help	Search	Canada site
Coming events	About CBIF	Links	Reports and publications	Home

Canadian Biodiversity Information Facility



All poisonous plants

[Introduction](#)[Interactive](#)[All poisonous plants by Botanical name](#)[All poisonous plants by Common name](#)[Important WWW Poisonous Plants sites](#)**Common name**[alder buckthorn](#)[alfalfa](#)[aloe - *A. barbadensis*](#)[alsike clover](#)[amaryllis \(*A. belladonna*\)](#)[amaryllis \(*A. vittata*\)](#)[American elder](#)[American holly](#)[American mistletoe](#)[angel's trumpet](#)[Astragalus \(*A. adsurgens*\)](#)[Astragalus \(*A. lentiginosus*\)](#)[Australian umbrella tree](#)[autumn crocus](#)[avocado](#)[bird rape](#)[black cherry](#)[black henbane](#)[black locust](#)[black nightshade](#)[black oak](#)[black walnut](#)[black-eyed Susan](#)[blue cardinalflower](#)[blue cohosh](#)[blue flag iris](#)[blueweed](#)[bog-laurel](#)[bracken](#)**Scientific name***Rhamnus frangula**Medicago sativa**Aloe barbadensis**Trifolium hybridum**Amaryllis belladonna**Amaryllis vittata**Sambucus canadensis**Ilex opaca**Phoradendron flavescens**Datura innoxia**Astragalus adsurgens**Astragalus lentiginosus**Brassaia actinophylla**Colchicum autumnale**Persea americana**Brassica campestris**Prunus serotina**Hyoscyamus niger**Robinia pseudoacacia**Solanum nigrum**Quercus velutina**Juglans nigra**Rudbeckia serotina**Lobelia siphilitica**Caulophyllum thalictroides**Iris versicolor**Echium vulgare**Kalmia polifolia**Pteridium aquilinum*

broad bean	<i>Vicia faba</i>
broom snakeweed	<i>Gutierrezia sarothrae</i>
buckwheat	<i>Fagopyrum esculentum</i>
bulbous buttercup	<i>Ranunculus bulbosus</i>
bur buttercup	<i>Ceratocephalus testiculatus</i>
Burke's lupine	<i>Lupinus burkei</i>
burningbush	<i>Euonymus atropurpureus</i>
caladium	<i>Caladium bicolor</i>
California bluebell	<i>Phacelia campanularia</i>
California rose-bay	<i>Rhododendron macrophyllum</i>
Canada nettle	<i>Laportea canadensis</i>
Canada yew	<i>Taxus canadensis</i>
Canadian milk-vetch	<i>Astragalus canadensis</i>
candalabra aloe	<i>Aloe arborescens</i>
candelabra-cactus	<i>Euphorbia lactea</i>
caper spurge	<i>Euphorbia lathyris</i>
cardinalflower	<i>Lobelia cardinalis</i>
castor-bean	<i>Ricinus communis</i>
celery-leaved buttercup	<i>Ranunculus sceleratus</i>
Chinese-lantern	<i>Physalis alkekengi</i>
chives	<i>Allium schoenoprasum</i>
chrysanthemum	<i>Chrysanthemum indicum</i>
climbing nightshade	<i>Solanum dulcamara</i>
cocklebur	<i>Xanthium strumarium</i>
Colorado rubberweed	<i>Hymenoxys richardsonii</i>
common comfrey	<i>Symphytum officinale</i>
common groundsel	<i>Senecio vulgaris</i>
common hop	<i>Humulus lupulus</i>
common milkweed	<i>Asclepias syriaca</i>
common privet	<i>Ligustrum vulgare</i>
common vetch	<i>Vicia sativa</i>
corn poppy	<i>Papaver rhoeas</i>
croton	<i>Codiaeum variegatum</i>
crown-of-thorns	<i>Euphorbia milii</i>
cut-leaved coneflower	<i>Rudbeckia laciniata</i>
cyclamen	<i>Cyclamen persicum</i>
cypress spurge	<i>Euphorbia cyparissias</i>
daffodil	<i>Narcissus pseudonarcissus</i>

death camas	<i>Zigadenus venenosus</i>
Devil's-backbone	<i>Kalanchoe daigremontiana</i>
dumbcane	<i>Dieffenbachia bausei</i>
Dutchman's-breeches	<i>Dicentra cucullaria</i>
eastern whorled milkweed	<i>Asclepias verticillata</i>
English bluebell	<i>Hyacinthoides nonscripta</i>
English holly	<i>Ilex aquifolium</i>
English ivy	<i>Hedera helix</i>
English yew	<i>Taxus baccata</i>
entire-leaved groundsel	<i>Senecio integerrimus</i>
European buckthorn	<i>Rhamnus cathartica</i>
European elder	<i>Sambucus nigra</i>
European spindletree	<i>Euonymus europaeus</i>
false hellebore	<i>Veratrum viride</i>
false ragweed	<i>Iva xanthifolia</i>
February daphne	<i>Daphne mezereum</i>
fiddleneck	<i>Amsinckia intermedia</i>
field horsetail	<i>Equisetum arvense</i>
five-hooked bassia	<i>Bassia hyssopifolia</i>
flamingo lily	<i>Anthurium andraeanum</i>
fly honeysuckle	<i>Lonicera xylosteum</i>
foxglove	<i>Digitalis purpurea</i>
garden-sorrel	<i>Rumex acetosa</i>
garland daphne	<i>Daphne cneorum</i>
garlic	<i>Allium sativum</i>
gas plant	<i>Dictamnus albus</i>
giant dumbcane	<i>Dieffenbachia amoena</i>
giant hogweed	<i>Heracleum mantegazzianum</i>
glory lily	<i>Gloriosa superba</i>
golden-bean	<i>Thermopsis rhombifolia</i>
golden-chain	<i>Laburnum anagyroides</i>
golden-trumpet	<i>Allamanda cathartica</i>
grass pea	<i>Lathyrus sativus</i>
greasewood	<i>Sarcobatus vermiculatus</i>
greater celandine	<i>Chelidonium majus</i>
green tansy mustard	<i>Descurainia pinnata</i>
ground-cherry	<i>Physalis peruviana</i>
ground-ivy	<i>Glechoma hederacea</i>

Guelder-rose	<i>Viburnum opulus</i>
hairy vetch	<i>Vicia villosa</i>
heart-leaved philodendron	<i>Philodendron scandens</i>
hemp dogbane	<i>Apocynum cannabinum</i>
horse-chestnut	<i>Aesculus hippocastanum</i>
horseradish	<i>Armoracia rusticana</i>
hound's tongue	<i>Cynoglossum officinale</i>
hydrangea	<i>Hydrangea macrophylla</i>
Iceland poppy	<i>Papaver nudicaule</i>
Indian mustard	<i>Brassica juncea</i>
Indian-tobacco	<i>Lobelia inflata</i>
Jack-in-the-pulpit	<i>Arisaema triphyllum</i>
Japanese wisteria	<i>Wisteria floribunda</i>
Japanese yew	<i>Taxus cuspidata</i>
Jerusalem-cherry	<i>Solanum pseudocapsicum</i>
jimsonweed	<i>Datura stramonium</i>
Johnson grass	<i>Sorghum halepense</i>
Kaffir lily	<i>Clivia miniata</i>
Kentucky coffeetree	<i>Gymnocladus dioica</i>
kochia	<i>Kochia scoparia</i>
lamb's-quarters	<i>Chenopodium album</i>
large-leaved lupine	<i>Lupinus polyphyllus</i>
leafy spurge	<i>Euphorbia esula</i>
leatherwood	<i>Dirca palustris</i>
lily-of-the-valley	<i>Convallaria majalis</i>
locoweed (<i>Oxytropis sericea</i>)	<i>Oxytropis sericea</i>
low larkspur	<i>Delphinium bicolor</i>
maidenhair tree	<i>Ginkgo biloba</i>
mango	<i>Mangifera indica</i>
marijuana	<i>Cannabis sativa</i>
marsh arrow-grass	<i>Triglochin palustre</i>
marsh horsetail	<i>Equisetum palustre</i>
May-apple	<i>Podophyllum peltatum</i>
Menzies larkspur	<i>Delphinium menziesii</i>
monk's hood	<i>Aconitum napellus</i>
moonseed	<i>Menispermum canadense</i>
morning glory	<i>Ipomoea tricolor</i>
mother-in-law plant	<i>Dieffenbachia seguine</i>

motherwort	<i>Leonurus cardiaca</i>
naked-flowered sneezeweed	<i>Helenium flexuosum</i>
narcissus	<i>Narcissus poeticus</i>
northern water-hemlock	<i>Cicuta virosa</i>
oats	<i>Avena sativa</i>
Ohio buckeye	<i>Aesculus glabra</i>
oleander	<i>Nerium oleander</i>
onion	<i>Allium cepa</i>
opium poppy	<i>Papaver somniferum</i>
Oriental poppy	<i>Papaver orientale</i>
Osage-orange	<i>Maclura pomifera</i>
pawpaw	<i>Asimina triloba</i>
penciltree	<i>Euphorbia tirucalli</i>
Peruvian lily	<i>Alstroemeria ligtu</i>
petty spurge	<i>Euphorbia peplus</i>
philodendron	<i>Philodendron cordatum</i>
pin cherry	<i>Prunus pensylvanica</i>
pink lady's-slipper	<i>Cypripedium acaule</i>
poinsettia	<i>Euphorbia pulcherrima</i>
poison ivy	<i>Rhus radicans</i>
poison suckleya	<i>Suckleya suckleyana</i>
poison sumac	<i>Rhus vernix</i>
poison-hemlock	<i>Conium maculatum</i>
pokeweed	<i>Phytolacca americana</i>
ponderosa pine	<i>Pinus ponderosa</i>
potato	<i>Solanum tuberosum</i>
precatory-pea	<i>Abrus precatorius</i>
prickly comfrey	<i>Symphytum asperum</i>
prickly lettuce	<i>Lactuca scariola</i>
primula	<i>Primula obconica</i>
prostrate pigweed	<i>Amaranthus blitoides</i>
purple cockle	<i>Agrostemma githago</i>
purple locoweed	<i>Oxytropis lambertii</i>
radish	<i>Raphanus sativus</i>
rapeseed	<i>Brassica napus</i>
red chokecherry	<i>Prunus virginiana</i>
red clover	<i>Trifolium pratense</i>
red maple	<i>Acer rubrum</i>

red oak	<i>Quercus rubra</i>
redroot pigweed	<i>Amaranthus retroflexus</i>
reed canarygrass	<i>Phalaris arundinacea</i>
rhubarb	<i>Rheum rhaponticum</i>
Russian knapweed	<i>Centaurea repens</i>
Saskatoon (a serviceberry)	<i>Amelanchier alnifolia</i>
scarlet pimpernel	<i>Anagallis arvensis</i>
seaside arrow-grass	<i>Triglochin maritima</i>
sensitive fern	<i>Onoclea sensibilis</i>
sheep sorrel	<i>Rumex acetosella</i>
sheep-laurel	<i>Kalmia angustifolia</i>
showy lady's-slipper	<i>Cypripedium reginae</i>
showy milkweed	<i>Asclepias speciosa</i>
Siberian scilla	<i>Scilla siberica</i>
silky lupine	<i>Lupinus sericeus</i>
silvery lupine	<i>Lupinus argenteus</i>
skunk cabbage	<i>Symplocarpus foetidus</i>
small lupine	<i>Lupinus pusillus</i>
smooth pigweed	<i>Amaranthus hybridus</i>
sneezeweed	<i>Helenium autumnale</i>
snowdrop	<i>Galanthus nivalis</i>
Sorghum	<i>Sorghum bicolor</i>
spatulate-leaved heliotrope	<i>Heliotropium curassavicum</i>
spotted dumbcane	<i>Dieffenbachia maculata</i>
spotted water-hemlock	<i>Cicuta maculata</i>
spreading dogbane	<i>Apocynum androsaemifolium</i>
spurge-laurel	<i>Daphne laureola</i>
squirrel-corn	<i>Dicentra canadensis</i>
St. John's-wort	<i>Hypericum perforatum</i>
star-of-Bethlehem	<i>Ornithogalum umbellatum</i>
stinging nettle	<i>Urtica dioica</i>
stinking rabbitbrush	<i>Chrysothamnus nauseosus</i>
stinkweed	<i>Thlaspi arvense</i>
Sudan grass	<i>Sorghum sudanense</i>
sun spurge	<i>Euphorbia helioscopia</i>
sunflower	<i>Helianthus annuus</i>
sweet pea	<i>Lathyrus odoratus</i>
Swiss-cheese plant	<i>Monstera deliciosa</i>

tall larkspur	<i>Delphinium glaucum</i>
tall manna grass	<i>Glyceria grandis</i>
tansy	<i>Tanacetum vulgare</i>
tansy ragwort	<i>Senecio jacobaea</i>
Tartarian honeysuckle	<i>Lonicera tatarica</i>
thin-leaved snowberry	<i>Symphoricarpos albus</i>
timber milk-vetch	<i>Astragalus miser</i>
tobacco	<i>Nicotiana tabacum</i>
tree-of-heaven	<i>Ailanthus altissima</i>
tulip	<i>Tulipa gesneriana</i>
two-grooved milk-vetch	<i>Astragalus bisulcatus</i>
veined dock	<i>Rumex venosus</i>
velvety goldenrod	<i>Solidago mollis</i>
Virginia creeper	<i>Parthenocissus quinquefolia</i>
western bleedingheart	<i>Dicentra formosa</i>
western minniebush	<i>Menziesia ferruginea</i>
western poison-oak	<i>Rhus diversiloba</i>
western water-hemlock	<i>Cicuta douglasii</i>
white camas	<i>Zigadenus elegans</i>
white clover	<i>Trifolium repens</i>
white oak	<i>Quercus alba</i>
white rose-bay	<i>Rhododendron albiflorum</i>
white snakeroot	<i>Eupatorium rugosum</i>
white sweet-clover	<i>Melilotus alba</i>
wild cabbage	<i>Brassica oleracea</i>
wild calla	<i>Calla palustris</i>
wild false indigo	<i>Baptisia leucantha</i>
wild ginger	<i>Asarum canadense</i>
wild indigo	<i>Baptisia tinctoria</i>
wild mustard	<i>Sinapis arvensis</i>
wild onion	<i>Allium canadense</i>
wild parsnip	<i>Pastinaca sativa</i>
wild radish	<i>Raphanus raphanistrum</i>
wormseed mustard	<i>Erysimum cheiranthoides</i>
yellow iris	<i>Iris pseudacorus</i>
yellow lady's-slipper	<i>Cypripedium calceolus</i>
yellow rocket	<i>Barbarea vulgaris</i>
yellow sage	<i>Lantana camara</i>

[yellow star-thistle](#)

Centaurea solstitialis

[yellow sweet-clover](#)

Melilotus officinalis

[yellow toadflax](#)

Linaria vulgaris

[Another search?](#)

[Français](#) | [Contact Us](#) | [Help](#) | [Search](#) | [Canada site](#)

[Coming Events](#) | [About CBIF](#) | [Links](#) | [Reports and Publications](#) |

[Home](#)

Date modified: 2003-02-06

[Important Notices](#)



Français	Contact us	Help	Search	Canada site
Coming events	About CBIF	Links	Reports and publications	Home

Canadian Biodiversity Information Facility



Poisonous Plants sites

[Introduction](#)

[Interactive](#)

[All poisonous plants by Botanical name](#)

[All poisonous plants by Common name](#)

[Important WWW Poisonous Plants sites](#)



General Poisonous Plant sites

- [USDA/ARS Poisonous Plants Research Laboratory](#), Logan, Utah
- [Poison Information on the Web \(University of Arizona\)](#)
- [Cornell University Poisonous Plants Page](#)
- [Poisonous Plant Databases](#)
- [Dermatology Database](#)

Poisonous plants by Geographical Region

North America

- [Canadian Poisonous Plants Information System](#)
- [Guide to Poisonous Plants](#) - Colorado State University
- [Indiana plants poisonous to livestock and pets](#)
- [Poisonous Plants of North Carolina](#)
- [Nova Scotia](#) - Poisonous plants and Poisonous fungi [illustrated]
- [Ostrich Fern Poisoning](#)
- [Plants toxic to animals](#) [University of Illinois]
- [PLANTOX -American bibliographic Poisonous plants database.](#)
- [Poisonous Plants of Veterinary Importance](#) - University of Pennsylvania
- **Poison Ivy, Western Poison Oak, Poison Sumac**
 - [Poison Ivy, Western Poison Oak, Poison Sumac](#) -- *from Agriculture and Agri-Food Canada*
- [Poisonous Plants of the southeastern United States](#)

Other related resources

Veterinarians

- [NetVet](#)

Medical Doctors/Poison Control

- [MIC-KIBIC Karolinska Institute](#) Extensive list of general poisoning WWW sites.
- [Dermatology Online Atlas](#)

Toxic Chemicals

- [Toxic Chemicals web sites](#)
- [Phytochemical and Ethnobotanical databases](#) -- plants ranked by chemical content
- [Foodborne Pathogenic Microorganisms and Natural Toxins](#) USDA

[External and broken links?](#)

[Français](#) | [Contact Us](#) | [Help](#) | [Search](#) | [Canada site](#)
[Coming Events](#) | [About CBIF](#) | [Links](#) | [Reports and Publications](#) | [Home](#)

Date modified: 2003-02-06

[Important Notices](#)



Français	Contact us	Help	Search	Canada site
Coming events	About CBIF	Links	Reports and publications	Home

Canadian Biodiversity Information Facility



Copyright // Disclaimer - Canadian poisonous plants

[Introduction](#)

[Interactive](#)

[All poisonous plants by Botanical name](#)

[All poisonous plants by Common name](#)

[Important WWW Poisonous Plants sites](#)

©Minister of Supply and Services Canada 1993

Cat. No. A21-40/1933-1

ISBN 0-662-59802-4

1993



Information supplied by this program is based entirely on published literature. Every effort has been made to verify input of the data, but, inaccuracies may occur. In a medical situation, always check the original references or other authoritative sources. Any medical information about symptoms, diseases, and treatments are derived from these references. The author of this program is a botanist with an interest in poisonous plants and professes no expertise in either veterinary or human medicine. This INFORMATION SYSTEM is intended as A RESEARCH TOOL ONLY. It is intended to aid medical experts in obtaining appropriate information on plant poisoning of animals and humans in Canada.

Limited use data product license agreement

The Government of Canada (Minister of Supply and Services) (hereafter called "the owner") owns all intellectual property rights, (including copyright) in the Canadian Poisonous Plants Information System (hereafter called the "INFORMATION SYSTEM").

1. This agreement does not transfer any or all of the owner's rights.
2. You may not develop or derive for commercial sale any other product in machine-readable form that incorporates or uses any substantial part of the INFORMATION SYSTEM.
3. The INFORMATION SYSTEM is provided "as-is", and the owner makes no warranty, either express or implied, including but not limited to, warranties of fitness for a

particular purpose.

4. In no event will the owner be liable for any indirect, special, consequential, or other similar damages.
5. It is your responsibility to ensure that your use of the data product complies with the terms of this agreement, and to seek prior written permission from the owner for any uses not permitted or not specified in this agreement.
6. ANY USE WHATSOEVER OF THE INFORMATION SYSTEM SHALL CONSTITUTE YOUR ACCEPTANCE OF THE TERMS OF THIS AGREEMENT.

[Français](#) | [Contact Us](#) | [Help](#) | [Search](#) | [Canada site](#)
[Coming Events](#) | [About CBIF](#) | [Links](#) | [Reports and Publications](#) |
[Home](#)

Date modified: 2003-02-06

[Important Notices](#)



Français	Contact us	Help	Search	Canada site
Coming events	About CBIF	Links	Reports and publications	Home

Canadian Biodiversity Information Facility



Copyright // Droits d'auteur

[Introduction](#)

[Interactive](#)

[All poisonous plants by Botanical name](#)

[All poisonous plants by Common name](#)

[Important WWW Poisonous Plants sites](#)



©Minister of Supply and Services Canada 1993
Cat. No. A21-40/1933-1
ISBN 0-662-59802-4
1993

©Approvisionnement et Services Canada 1993
No de cat. A21-40/1933-1
ISBN 0-662-59802-4
1993

[Français](#) | [Contact Us](#) | [Help](#) | [Search](#) | [Canada site](#)
[Coming Events](#) | [About CBIF](#) | [Links](#) | [Reports and Publications](#) | [Home](#)

Date modified: 2003-02-06

[Important Notices](#)



Français	Contact us	Help	Search	Canada site
Coming events	About CBIF	Links	Reports and publications	Home

Canadian Biodiversity Information Facility



XML output

[Introduction](#)

[Interactive](#)

[All poisonous plants by Botanical name](#)

[All poisonous plants by Common name](#)

[Important WWW Poisonous Plants sites](#)



Common name

[alder buckthorn](#)
[alfalfa](#)
[aloe - *A. barbadensis*](#)
[alsike clover](#)
[amaryllis \(*A. belladonna*\)](#)
[amaryllis \(*A. vittata*\)](#)
[American elder](#)
[American holly](#)
[American mistletoe](#)
[angel's trumpet](#)
[Astragalus \(*A. adsurgens*\)](#)
[Astragalus \(*A. lentiginosus*\)](#)
[Australian umbrella tree](#)
[autumn crocus](#)
[avocado](#)
[bird rape](#)
[black cherry](#)
[black henbane](#)
[black locust](#)
[black nightshade](#)
[black oak](#)
[black walnut](#)
[black-eyed Susan](#)
[blue cardinalflower](#)
[blue cohosh](#)
[blue flag iris](#)
[blueweed](#)
[bog-laurel](#)
[bracken](#)
[broad bean](#)
[broom snakeweed](#)
[buckwheat](#)
[bulbous buttercup](#)

Scientific name

Rhamnus frangula
Medicago sativa
Aloe barbadensis
Trifolium hybridum
Amaryllis belladonna
Amaryllis vittata
Sambucus canadensis
Ilex opaca
Phoradendron flavescens
Datura innoxia
Astragalus adsurgens
Astragalus lentiginosus
Brassaia actinophylla
Colchicum autumnale
Persea americana
Brassica campestris
Prunus serotina
Hyoscyamus niger
Robinia pseudoacacia
Solanum nigrum
Quercus velutina
Juglans nigra
Rudbeckia serotina
Lobelia siphilitica
Caulophyllum thalictroides
Iris versicolor
Echium vulgare
Kalmia polifolia
Pteridium aquilinum
Vicia faba
Gutierrezia sarothrae
Fagopyrum esculentum
Ranunculus bulbosus
Ceratocephalus testiculatus
Lupinus burkei
Euonymus atropurpureus
Caladium bicolor

bur buttercup	<i>Phacelia campanularia</i>
Burke's lupine	<i>Rhododendron macrophyllum</i>
burningbush	<i>Laportea canadensis</i>
caladium	<i>Taxus canadensis</i>
California bluebell	<i>Astragalus canadensis</i>
California rose-bay	<i>Aloe arborescens</i>
Canada nettle	<i>Euphorbia lactea</i>
Canada yew	<i>Euphorbia lathyris</i>
Canadian milk-vetch	<i>Lobelia cardinalis</i>
candalabra aloe	<i>Ricinus communis</i>
candelabra-cactus	<i>Ranunculus sceleratus</i>
caper spurge	<i>Physalis alkekengi</i>
cardinalflower	<i>Allium schoenoprasum</i>
castor-bean	<i>Chrysanthemum indicum</i>
celery-leaved buttercup	<i>Solanum dulcamara</i>
Chinese-lantern	<i>Xanthium strumarium</i>
chives	<i>Hymenoxys richardsonii</i>
chrysanthemum	<i>Symphytum officinale</i>
climbing nightshade	<i>Senecio vulgaris</i>
cocklebur	<i>Humulus lupulus</i>
Colorado rubberweed	<i>Asclepias syriaca</i>
common comfrey	<i>Ligustrum vulgare</i>
common groundsel	<i>Vicia sativa</i>
common hop	<i>Papaver rhoeas</i>
common milkweed	<i>Codiaeum variegatum</i>
common privet	<i>Euphorbia milii</i>
common vetch	<i>Rudbeckia laciniata</i>
corn poppy	<i>Cyclamen persicum</i>
croton	<i>Euphorbia cyparissias</i>
crown-of-thorns	<i>Narcissus pseudonarcissus</i>
cut-leaved coneflower	<i>Zigadenus venenosus</i>
cyclamen	<i>Kalanchoe daigremontiana</i>
cypress spurge	<i>Dieffenbachia bausei</i>
daffodil	<i>Dicentra cucullaria</i>
death camas	<i>Asclepias verticillata</i>
Devil's-backbone	<i>Hyacinthoides nonscripta</i>
dumbcane	<i>Ilex aquifolium</i>
Dutchman's-breeches	<i>Hedera helix</i>
eastern whorled milkweed	<i>Taxus baccata</i>
English bluebell	<i>Senecio integerrimus</i>
English holly	<i>Rhamnus cathartica</i>
English ivy	<i>Sambucus nigra</i>
English yew	<i>Euonymus europaeus</i>
entire-leaved groundsel	<i>Veratrum viride</i>
European buckthorn	<i>Iva xanthifolia</i>

European elder	<i>Digitalis purpurea</i>
European spindletree	<i>Rumex acetosa</i>
false hellebore	<i>Daphne cneorum</i>
false ragweed	<i>Allium sativum</i>
February daphne	<i>Dictamnus albus</i>
fiddleneck	<i>Dieffenbachia amoena</i>
field horsetail	<i>Heracleum mantegazzianum</i>
five-hooked bassia	<i>Gloriosa superba</i>
flamingo lily	<i>Thermopsis rhombifolia</i>
fly honeysuckle	<i>Laburnum anagyroides</i>
foxglove	<i>Allamanda cathartica</i>
garden-sorrel	<i>Lathyrus sativus</i>
garland daphne	<i>Sarcobatus vermiculatus</i>
garlic	<i>Chelidonium majus</i>
gas plant	<i>Descurainia pinnata</i>
giant dumbcane	<i>Physalis peruviana</i>
giant hogweed	<i>Glechoma hederacea</i>
glory lily	<i>Viburnum opulus</i>
golden-bean	<i>Vicia villosa</i>
golden-chain	<i>Philodendron scandens</i>
golden-trumpet	<i>Apocynum cannabinum</i>
grass pea	<i>Aesculus hippocastanum</i>
greasewood	<i>Armoracia rusticana</i>
greater celandine	<i>Cynoglossum officinale</i>
green tansy mustard	<i>Hydrangea macrophylla</i>
ground-cherry	<i>Papaver nudicaule</i>
ground-ivy	<i>Brassica juncea</i>
Guelder-rose	<i>Lobelia inflata</i>
hairy vetch	<i>Arisaema triphyllum</i>
heart-leaved philodendron	<i>Wisteria floribunda</i>
hemp dogbane	<i>Taxus cuspidata</i>
horse-chestnut	<i>Solanum pseudocapsicum</i>
horseradish	<i>Datura stramonium</i>
hound's tongue	<i>Sorghum halepense</i>
hydrangea	<i>Clivia miniata</i>
Iceland poppy	<i>Gymnocladus dioicus</i>
Indian mustard	<i>Kochia scoparia</i>
Indian-tobacco	<i>Chenopodium album</i>
Jack-in-the-pulpit	<i>Lupinus polyphyllus</i>
Japanese wisteria	<i>Euphorbia esula</i>
Japanese yew	<i>Dirca palustris</i>
Jerusalem-cherry	<i>Convallaria majalis</i>
jimsonweed	<i>Oxytropis sericea</i>
Johnson grass	<i>Delphinium bicolor</i>
Kaffir lily	<i>Ginkgo biloba</i>
	<i>Mangifera indica</i>
	<i>Cannabis sativa</i>
	<i>Triglochin palustre</i>
	<i>Equisetum palustre</i>
	<i>Podophyllum peltatum</i>

Kentucky coffeetree	<i>Delphinium menziesii</i>
kochia	<i>Aconitum napellus</i>
lamb's-quarters	<i>Menispermum canadense</i>
large-leaved lupine	<i>Ipomoea tricolor</i>
leafy spurge	<i>Dieffenbachia seguine</i>
leatherwood	<i>Leonurus cardiaca</i>
lily-of-the-valley	<i>Helenium flexuosum</i>
locoweed (<i>Oxytropis sericea</i>)	<i>Narcissus poeticus</i>
low larkspur	<i>Cicuta virosa</i>
maidenhair tree	<i>Avena sativa</i>
mango	<i>Aesculus glabra</i>
marijuana	<i>Nerium oleander</i>
marsh arrow-grass	<i>Allium cepa</i>
marsh horsetail	<i>Papaver somniferum</i>
May-apple	<i>Papaver orientale</i>
Menzies larkspur	<i>Maclura pomifera</i>
monk's hood	<i>Asimina triloba</i>
moonseed	<i>Euphorbia tirucalli</i>
morning glory	<i>Alstroemeria ligtu</i>
mother-in-law plant	<i>Euphorbia peplus</i>
motherwort	<i>Philodendron cordatum</i>
naked-flowered sneezeweed	<i>Prunus pensylvanica</i>
narcissus	<i>Cypripedium acaule</i>
northern water-hemlock	<i>Euphorbia pulcherrima</i>
oats	<i>Rhus radicans</i>
Ohio buckeye	<i>Suckleya suckleyana</i>
oleander	<i>Rhus vernix</i>
onion	<i>Conium maculatum</i>
opium poppy	<i>Phytolacca americana</i>
Oriental poppy	<i>Pinus ponderosa</i>
Osage-orange	<i>Solanum tuberosum</i>
pawpaw	<i>Abrus precatorius</i>
penciltree	<i>Symphytum asperum</i>
Peruvian lily	<i>Lactuca scariola</i>
petty spurge	<i>Primula obconica</i>
philodendron	<i>Amaranthus blitoides</i>
pin cherry	<i>Agrostemma githago</i>
pink lady's-slipper	<i>Oxytropis lambertii</i>
poinsettia	<i>Raphanus sativus</i>
poison ivy	<i>Brassica napus</i>
poison suckleya	<i>Prunus virginiana</i>
poison sumac	<i>Trifolium pratense</i>
poison-hemlock	<i>Acer rubrum</i>
pokeweed	<i>Quercus rubra</i>
ponderosa pine	<i>Amaranthus retroflexus</i>
	<i>Phalaris arundinacea</i>
	<i>Rheum rhaponticum</i>
	<i>Centaurea repens</i>
	<i>Amelanchier alnifolia</i>
	<i>Anagallis arvensis</i>
	<i>Triglochin maritima</i>

potato	<i>Onoclea sensibilis</i>
precatory-pea	<i>Rumex acetosella</i>
prickly comfrey	<i>Kalmia angustifolia</i>
prickly lettuce	<i>Cypripedium reginae</i>
primula	<i>Asclepias speciosa</i>
prostrate pigweed	<i>Scilla siberica</i>
purple cockle	<i>Lupinus sericeus</i>
purple locoweed	<i>Lupinus argenteus</i>
radish	<i>Symplocarpus foetidus</i>
rapeseed	<i>Lupinus pusillus</i>
red chokecherry	<i>Amaranthus hybridus</i>
red clover	<i>Helenium autumnale</i>
red maple	<i>Galanthus nivalis</i>
red oak	<i>Sorghum bicolor</i>
redroot pigweed	<i>Heliotropium curassavicum</i>
reed canarygrass	<i>Dieffenbachia maculata</i>
rhubarb	<i>Cicuta maculata</i>
Russian knapweed	<i>Apocynum androsaemifolium</i>
Saskatoon (a serviceberry)	<i>Daphne laureola</i>
scarlet pimpernel	<i>Dicentra canadensis</i>
seaside arrow-grass	<i>Hypericum perforatum</i>
sensitive fern	<i>Ornithogalum umbellatum</i>
sheep sorrel	<i>Urtica dioica</i>
sheep-laurel	<i>Chrysothamnus nauseosus</i>
showy lady's-slipper	<i>Thlaspi arvense</i>
showy milkweed	<i>Sorghum sudanense</i>
Siberian scilla	<i>Euphorbia helioscopia</i>
silky lupine	<i>Helianthus annuus</i>
silvery lupine	<i>Lathyrus odoratus</i>
skunk cabbage	<i>Monstera deliciosa</i>
small lupine	<i>Delphinium glaucum</i>
smooth pigweed	<i>Glyceria grandis</i>
sneezeweed	<i>Tanacetum vulgare</i>
snowdrop	<i>Senecio jacobaea</i>
Sorghum	<i>Lonicera tatarica</i>
spatulate-leaved heliotrope	<i>Symphoricarpos albus</i>
spotted dumbcane	<i>Astragalus miser</i>
spotted water-hemlock	<i>Nicotiana tabacum</i>
spreading dogbane	<i>Ailanthus altissima</i>
spurge-laurel	<i>Tulipa gesneriana</i>
squirrel-corn	<i>Astragalus bisulcatus</i>
St. John's-wort	<i>Rumex venosus</i>
star-of-Bethlehem	<i>Solidago mollis</i>
stinging nettle	<i>Parthenocissus quinquefolia</i>
stinking rabbitbrush	<i>Dicentra formosa</i>
	<i>Menziesia ferruginea</i>
	<i>Rhus diversiloba</i>
	<i>Cicuta douglasii</i>
	<i>Zigadenus elegans</i>
	<i>Trifolium repens</i>

[stinkweed](#)
[Sudan grass](#)
[sun spurge](#)
[sunflower](#)
[sweet pea](#)
[Swiss-cheese plant](#)
[tall larkspur](#)
[tall manna grass](#)
[tansy](#)
[tansy ragwort](#)
[Tartarian honeysuckle](#)
[thin-leaved snowberry](#)
[timber milk-vetch](#)
[tobacco](#)
[tree-of-heaven](#)
[tulip](#)
[two-grooved milk-vetch](#)
[veined dock](#)
[velvety goldenrod](#)
[Virginia creeper](#)
[western bleedingheart](#)
[western minniebush](#)
[western poison-oak](#)
[western water-hemlock](#)
[white camas](#)
[white clover](#)
[white oak](#)
[white rose-bay](#)
[white snakeroot](#)
[white sweet-clover](#)
[wild cabbage](#)
[wild calla](#)
[wild false indigo](#)
[wild ginger](#)
[wild indigo](#)
[wild mustard](#)
[wild onion](#)
[wild parsnip](#)
[wild radish](#)
[wormseed mustard](#)
[yellow iris](#)
[yellow lady's-slipper](#)
[yellow rocket](#)
[yellow sage](#)
[yellow star-thistle](#)

Quercus alba
Rhododendron albiflorum
Eupatorium rugosum
Melilotus alba
Brassica oleracea
Calla palustris
Baptisia leucantha
Asarum canadense
Baptisia tinctoria
Sinapis arvensis
Allium canadense
Pastinaca sativa
Raphanus raphanistrum
Erysimum cheiranthoides
Iris pseudacorus
Cypripedium calceolus
Barbarea vulgaris
Lantana camara
Centaurea solstitialis
Melilotus officinalis
Linaria vulgaris

[yellow sweet-clover](#)

[yellow toadflax](#)

[Français](#) | [Contact Us](#) | [Help](#) | [Search](#) | [Canada site](#)

[Coming Events](#) | [About CBIF](#) | [Links](#) | [Reports and Publications](#) |

[Home](#)

Date modified: 2003-02-06

[Important Notices](#)



Government
of Canada

Gouvernement
du Canada

Français

CanExplore

Your doorway to the world of sustainable development

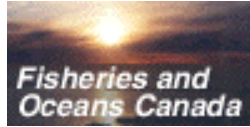

CANCELLATION of CanExplore Search

As of December 31, 2002, CanExplore will no longer be available. Agriculture and Agri-Food Canada has been supporting CanExplore but will cease to host the search engine site due changes in the four Federal Government departments involved.

Please refer to the individual Web sites of these four departments as follows:

[Agriculture and Agri-Food Canada](#)

[Environment Canada](#)

[Fisheries and Oceans Canada](#)

[Natural Resources Canada](#)

Thank you.

Canada¹³¹



Français	Contact us	Help	Search	Canada site
Coming events	About CBIF	Links	Reports and publications	Home

Canadian Biodiversity Information Facility



Copyright/permission to reproduce

[ITIS](#)

[Biological name search](#)

[BiOSC](#)

[Global specimen information networks](#)

[Species Access](#)

[Canadian specimen information network](#)

[Point Mapper](#)

[Make your own map](#)

[SpeciesBank](#)

[FBIP](#)

- [Copyright/permission to reproduce](#)
- [Privacy notices](#)
- [Conditions for use of data](#)

Materials on this Web site were produced and/or compiled by the Canadian Biodiversity Information Facility (CBIF) for the purpose of providing Canadians with direct access to information about the programs and services offered by the Government of Canada.

The material on this site is covered by the provisions of the [Copyright Act](#), by Canadian laws, policies, regulations and international agreements. Such provisions serve to identify the information source and, in specific instances, to prohibit reproduction of materials without written permission.

Non-commercial reproduction



Information on this site has been posted with the intent that it be readily available for personal and public non-commercial use and may be reproduced, in part or in whole and by any means, without charge or further permission from CBIF. We ask only that:

- Users exercise due diligence in ensuring the accuracy of the materials reproduced;
- CBIF be identified as the source department; and,
- The reproduction is not represented as an official version of the materials reproduced, nor as having been made, in affiliation with or with the endorsement of CBIF.

Commercial reproduction

Reproduction of multiple copies of materials on this site, in whole or in part, for the purposes of commercial redistribution is prohibited except with written permission from the Government of Canada's copyright administrator, Public Works and Government Services Canada (PWGSC). Through the permission granting process, PWGSC helps ensure individuals/organizations wishing to reproduce Government of

Canada materials for commercial purposes have access to the most accurate, up-to-date versions. To obtain permission to reproduce materials on this site for commercial purposes please contact:

- Public Works and Government Services Canada
- Canadian Government Publishing Directorate
- Constitution Square Building, 4th Floor, 350 Albert Street
- Ottawa ON K1A 0S5
- Canada
- or copyright.droitdauteur@communication.gc.ca

Third-party materials

Some of the materials and graphical elements found on Government of Canada Web sites are subject to copyrights held by other organizations. This is particularly true of sites that are jointly operated by a Government of Canada institution and an external organization as part of a collaborative arrangement. In such cases, some restrictions on the reproduction of materials or graphical elements may apply and it may be necessary to seek permission from the rights holder prior to reproducing the material.

To obtain information concerning copyright ownership and restrictions on reproduction on this site, please [contact us](#).

Privacy notices

The Government of Canada and CBIF are committed to providing visitors with web sites that respect their privacy. This page summarizes the privacy policy and practices on CBIF's web site.

- CBIF web pages do not automatically gather any specific personal information from you, such as your name, phone number or e-mail address. We would only obtain this type of information if you supply it by sending us an e-mail or registering in a secure portion of the site.
- All personal information created, held or collected by this department is protected under the federal *Privacy Act*. This means that at any point of collection you will be asked for consent to collect your information, and you will be informed of the purpose for which it is being collected and how to exercise your right of access to that information.
- CBIF employs software programs to monitor network traffic to identify unauthorized attempts to upload or change information, or otherwise cause damage. This software receives and records the Internet Protocol (IP) address of the computer that has contacted our Web site, the date and time of the visit and the pages visited. We make no attempt to link these addresses with the identity of individuals visiting our site unless an attempt to damage the site has been detected.

- CBIF does not normally use "cookies" to track how our visitors use this site or to determine sites previously visited. The system will notify you before any cookies are used so that you may refuse them. (A "cookie" is a file that may be placed on your hard drive without your knowledge by a Web site to allow it to monitor your use of the site.)
- Information on individual visitors is used by CBIF employees who need to know the information in order to respond to your request or to ensure the security of this system. We only share the information you give us with another government department if your inquiry relates to that department. We do not use the information to create individual profiles, nor do we disclose this information to anyone outside the federal government.

Questions or comments regarding this policy, or the administration of the *Privacy Act* in CBIF may be directed to the Privacy Co-ordinator by [e-mail](#). If you are not satisfied with our response to your privacy concern, you may wish to contact the [Office of the Privacy Commissioner](#). >

Conditions for use of data

Disclaimers

- Data are provided on an "as is" basis -no responsibility by the network or by the caretakers of the original data is accepted for uses or misuses.
- Data are not to be used on a for-profit basis - use of the data for commercial or for-profit applications are permitted only via written permission from the managers of the data network and from the component data caretakers.
- Data are provided on an end-user basis - that is, data are provided to users, but are not to be passed on to third parties or otherwise redistributed.
- Proper acknowledgment of the data network and source institutions is expected; in textual form, the following format should be used: "Biodiversity data were drawn from the distributed data network entitled Species Analyst, a project of the North American Biodiversity Information Network, and participating institutions." Acknowledgment of individual institutions should also be included.
- Data are provided under the understanding that their use will be generally consistent with the philosophy of not causing detriment to wild species.
- Data are provided in this facility under the general, overarching principle of free and open access to biodiversity information and technology.

Provisos

- *Issues of data quality* - Although interested in assisting data caretakers to improve data under their care, this data network serves simply to make information available. We refer users with special concerns regarding data precision or quality to the original data caretakers. Areas of special concern include taxonomic determinations and geographic referencing.
- *Use of negative information* -Biodiversity data generally constitute positive information only; that is, absence of a record does not always mean absence of a particular species from a particular point in space and time. Because biodiversity sampling is notoriously spotty, biased, and incomplete, understanding the positive-only nature of the data is critical to their proper understanding.
- *General* -Neither the creators of this biodiversity information network nor the institutions that it links guarantees either the accuracy, reliability, or completeness of the data or information provided, or the reliability and functionality of the computer tools provided, and neither accepts any liability in this regard.

[Français](#) | [Contact Us](#) | [Help](#) | [Search](#) | [Canada site](#)

[Coming Events](#) | [About CBIF](#) | [Links](#) | [Reports and Publications](#) | [Home](#)

Date Modified: 2003-03-25

[Important Notices](#)



English	Contactez-nous	Aide	Recherche	Site du Canada
À venir	À notre sujet	Liens	Rapports et publications	Accueil

Système canadien d'information sur la biodiversité



Index du site

[Introduction](#)

[Recherche interactive](#)

[Liste de toutes les plantes toxiques par nom scientifique](#)

[Liste de toutes les plantes toxiques par nom commun](#)

[Les principaux sites Web sur les plantes toxiques](#)



- [Au sujet du Système canadien d'information sur la biodiversité](#)
- Bases de données
 - [Passerelle d'information sur les collections, spécimens et observations biologiques \(ICSOB\)](#)
 - [Système canadien d'information sur les plantes toxiques](#)
 - [Système d'information taxonomique intégré \(SITI\)](#)
 - [Analyste d'espèces Canada](#)
 - [Oiseaux \(Aves\)](#)
 - [Reptiles et amphibiens \(Reptilia et Amphibia\)](#)
 - [Poissons \(Osteichthyes\)](#)
 - [Papillons \(Lepidoptera\)](#)
 - [Fourmis, guêpes, abeilles \(Hymenoptera\)](#)
 - [Plantes \(Plantae\)](#)
- [Rapports et publications](#)
- [Banque d'espèces](#)
 - [Les papillons diurnes du Canada](#)
- [Le Réseau de connaissances et d'innovation pour la biodiversité](#)

[English](#) | [Contactez nous](#) | [Aide](#) | [Recherche](#) | [Site du Canada](#)
[À venir](#) | [À notre sujet](#) | [Liens](#) | [Rapports et publications](#) |
[Accueil](#)

Date de modification: 2003-02-06

[Avis important](#)



Français	Contact us	Help	Search	Canada site
Coming events	About CBIF	Links	Reports and publications	Home

Canadian Biodiversity Information Facility



ITIS

Integrated Taxonomic Information System (ITIS) Taxon based biological information system

[New Query](#)[Advanced Searches](#)[Data Quality](#)[Search Help](#)**BIOSC Gateway**[New Query](#)[About BiOSC](#)

Biological Observations, Specimens and Collections (BiOSC) Gateway
Biodiversity Knowledge, Global Knowledge

Search by scientific name and/or geography

Hints:

- **enter scientific name only**
- **leave the name input field blank to see all collections from a given geographic area**
- **enter at least three letters if searching *All* geographic areas**



Search: Kingdom the

name

from the geographic region:

Search within a bounding box
(only some collections are GIS referenced)

Hints:

- enter the centroid coordinates
- use whole numbers or decimal degrees (e.g. 45° or 45.076°)
- use negative numbers for latitudes south of the equator (e.g. -45°)
- use negative numbers for longitudes west of the 0 ° meridian (e.g. -79°)

Latitude

Longitude

The prototype BiOSC Gateway demonstrates the power of *interoperability* between different biodiversity networks. Supported networks currently include:

- [Distributed Generic Information Retrieval \(DiGIR\) \(DiGIR\)](#)
- [European Natural History Specimen Information Network \(ENHSIN\)](#)
- [The Species Analyst \(TSA\)](#)
- [The World Information Network on Biodiversity \(REMIB\)](#)

These networks utilize differing techniques to store and display data. When you click on any of the country links the resulting information is being returned directly from the institutions holding these data. For more information [about BiOSC](#) visit the Canadian Biodiversity Information Facility.

Hints: To properly see the information returning from the ENHSIN network, please use Microsoft Internet Explorer Version 5.x, Netscape 6.x or view Page Source from your browser.

[Advanced searches](#) · [BiOSC](#) · [Data Quality](#) · [Search help](#)

Generated on: 10-May -2004 || Data as of 12-April -2004

[Français](#) | [Contact Us](#) | [Help](#) | [Search](#) | [Canada site](#)

[Coming Events](#) | [About CBIF](#) | [Links](#) | [Reports and Publications](#) | [Home](#)

Date modified: 2003-02-11

[Important Notices](#)



Français	Contact us	Help	Search	Canada site
Coming events	About CBIF	Links	Reports and publications	Home

Canadian Biodiversity Information Facility



ITIS

Integrated Taxonomic Information System (ITIS) Taxon based biological information system

[New Query](#)[Advanced Searches](#)[Data Quality](#)[Search Help](#)**BiOSC Gateway**[New Query](#)[About BiOSC](#)

Name input (common name or scientific name):

Search: Kingdom

[Advanced searches](#) · [BiOSC](#) · [Data Quality](#) · [Search help](#)

Generated on: 10-May -2004 || Data as of 12-April -2004

[Français](#) | [Contact Us](#) | [Help](#) | [Search](#) | [Canada site](#)[Coming Events](#) | [About CBIF](#) | [Links](#) | [Reports and Publications](#) | [Home](#)

Date modified: 2003-02-11

[Important Notices](#)



Français	Contact us	Help	Search	Canada site
Coming events	About CBIF	Links	Reports and publications	Home

Canadian Biodiversity Information Facility



SpeciesBank

[ITIS](#)[Biological name search](#)[BiOSC](#)[Global specimen information networks](#)[Species Access](#)[Canadian specimen information network](#)[Point Mapper](#)[Make your own map](#)[SpeciesBank](#)[FBIP](#)

CBIF's SpeciesBank is a growing library of digital information about the biological species of Canada. It includes high-quality photographs, distribution maps, identification guidance, and a host of other information including links to monographs and species-specific information elsewhere on the Internet.

- [Butterflies of Canada](#)
- [Brassicaceae of Canada](#)
- [Canadian Poisonous Plants Information System](#)
- [Moths of Canada](#)

[Français](#) | [Contact Us](#) | [Help](#) | [Search](#) | [Canada site](#)
[Coming Events](#) | [About CBIF](#) | [Links](#) | [Reports and Publications](#) |
[Home](#)

Date Modified: 2003-03-25

[Important Notices](#)



Français	Contact us	Help	Search	Canada site
Coming events	About CBIF	Links	Reports and publications	Home

Canadian Biodiversity Information Facility



SpeciesBank

Butterflies of Canada

[ITIS](#)

[Biological name search](#)

[BiOSC](#)

[Global specimen information networks](#)

[Species Access](#)

[Canadian specimen information network](#)

[Point Mapper](#)

[Make your own map](#)

[SpeciesBank](#)

[FBIP](#)



- [Alphabetical index of all species, subfamilies, and families by common and latin name](#)
- [Taxonomic index \(including families, subfamilies, genera\)](#)
- [Index to larval food plants](#)
- [Dubious records](#)
- [Glossary](#)
- [Bibliography](#)
- [How to use this material](#)
- [History of butterfly study in Canada](#)
- [Canadian geography and butterfly distribution](#)
- [Butterfly observation](#)
- [Butterfly gardening](#)
- [Butterfly conservation](#)
- [What is a butterfly?](#)
- [Lepidoptera classification](#)
- [Butterfly life history](#)
- [Butterfly systematics](#)
- [Collecting guidelines](#) [statement of the Lepidopterists' Society]

Note: Most of the material in this section of the SpeciesBank is reproduced, with permission, from *The Butterflies of Canada* by Ross A. Layberry, Peter W. Hall, and J. Donald Lafontaine. University of Toronto Press; 1998.

[Français](#) | [Contact Us](#) | [Help](#) | [Search](#) | [Canada site](#)
[Coming Events](#) | [About CBIF](#) | [Links](#) | [Reports and Publications](#) |
[Home](#)

Date Modified: 2003-03-25

[Important Notices](#)



Français	Contact us	Help	Search	Canada site
Coming events	About CBIF	Links	Reports and publications	Home

Canadian Biodiversity Information Facility



Biodiversity Knowledge and Innovation Network

[ITIS](#)

[Biological name search](#)

[BiOSC](#)

[Global specimen information networks](#)

[Species Access](#)

[Canadian specimen information network](#)

[Point Mapper](#)

[Make your own map](#)

[SpeciesBank](#)

[FBIP](#)



The Biodiversity Knowledge and Innovation Network (BKIN) was established in response to a recommendation by representatives of governments, universities, zoological and botanical gardens, museums, environmental and wildlife nongovernmental organizations, aboriginal groups and sectoral and high-technology industries at the Canadian Biodiversity Network Conference held in March 2001 in Ottawa. This conference was held to develop a national strategic approach for a biodiversity knowledge network in Canada [[see full report in PDF format](#)].

Participants in BKIN

Participants in BKIN include the following organizations, which were represented on the steering committee for the Canadian Biodiversity Network Conference, 1–4 March 2001.

- [Agriculture and Agri-Food Canada](#)
- [Biodiversity Convention Office](#), Environment Canada
- [Canadian Advanced Technology Alliance](#)
- [Canadian Biodiversity Information Network](#), Environment Canada
- [Canadian Federation of Agriculture](#)
- [Canadian Forest Service](#), Natural Resources Canada
- [Canadian Information System for the Environment](#), Environment Canada
- [Canadian Museum of Nature](#)
- [Canadian Nature Federation](#)
- [Canadian Wildlife Service](#), Environment Canada
- [Dow AgroSciences Canada](#)
- [Ducks Unlimited Canada](#)
- [Ecological Monitoring and Assessment Network](#), Environment Canada
- [Elanco Animal Health](#)

- [Eskimo Lakes Inc.](#)
- [Fisheries and Oceans Canada](#)
- [Goodfellow Agricola Consultants Inc.](#)
- [Miistakis Institute for the Rockies](#)
- [Ministère de l'Environnement du Québec](#)
- [Montréal Botanical Garden](#)
- [National Research Council Canada](#)
- [The Nature Conservancy of Canada](#)
- [NatureServe Canada](#)
- [Parks Canada](#), Canadian Heritage
- [Royal Ontario Museum](#)
- [Secretariat of the Convention on Biological Diversity](#)
- [Texar Corporation](#)
- [University of Alberta](#)
- [University of British Columbia, Zoology Department](#)
- [University of Calgary](#)
- [University of Guelph, Department of Computing and Information Science](#)
- [Wildlife Habitat Canada](#)
- [World Wildlife Fund Canada](#)

More information

For more information about BKIN, see [Investing in Biodiversity for the Information Age: The Need for a Biodiversity Knowledge and Innovation Network in Canada](#) [PDF format; 900 MB]

For more about the purpose, structure, and operations of BKIN, please see [Reports and publications](#).

For more information about the Canadian Biodiversity Network Conference, 1–4 March 2001, visit the [conference web site](#).

[Français](#) | [Contact Us](#) | [Help](#) | [Search](#) | [Canada site](#)
[Coming Events](#) | [About CBIF](#) | [Links](#) | [Reports and Publications](#) |
[Home](#)

Date Modified: 2003-03-25

[Important Notices](#)



English	Contactez-nous	Aide	Recherche	Site du Canada
À venir	À notre sujet	Liens	Rapports et publications	Accueil

Système canadien d'information sur la biodiversité



Introduction - Système canadien d'information sur les plantes toxiques

[Introduction](#)[Recherche interactive](#)[Liste de toutes les plantes toxiques par nom scientifique](#)[Liste de toutes les plantes toxiques par nom commun](#)[Les principaux sites Web sur les plantes toxiques](#)

- [Audience suscitée](#)
- [Ce que le Système d'information permet de faire](#)
- [Ce que le Système d'information ne permet pas de faire](#)
- [Illustrations](#)
- [Remerciements](#)
- [Historique du projet](#)



Les plantes provoquent des empoisonnements parce qu'elles contiennent des substances chimiques qui ont des effets indésirables sur les animaux et les humains. Pour produire un tel effet, certains poisons doivent être ingérés; dans d'autres cas (herbe à puce), il suffit d'un simple contact sur la peau pour produire une réaction chez les personnes sensibles. Certaines substances chimiques (prunasine et autres glucosides cyanogénétiques) ne deviennent toxiques pour les animaux que si elles sont transformées, c'est-à-dire hydrolysées par les enzymes végétales ou par les organismes présents dans le rumen.

Les plantes qui provoquent des dermatites ne sont traitées dans ce système que si elles produisent des réactions sévères et non si leurs effets sur la peau sont peu marqués. On trouvera plus d'information sur les dermatites d'origine végétale dans Mitchell, J. C., Rook, A. 1979, [Botanical dermatology](#), Greenglass Ltd, Vancouver, B.C., Canada. 787 pp.

Les plantes qui ne produisent que des blessures mécaniques, les algues bleu-vert toxiques et les espèces qui provoquent le rhume des foin ont également été exclues.

Bien que ce Système d'information s'adresse avant tout à un public canadien, il sera également utile dans d'autres pays. Bien entendu, les plantes d'intérieur ou qu'on fait pousser près des habitations peuvent aussi être cultivées dans toutes les

régions tempérées du monde. De nombreuses plantes d'intérieur sont même d'origine tropicale. D'autres espèces végétales traitées dans ce système ont été introduites en Amérique du Nord et dans d'autres régions tempérées du monde. L'information relative aux espèces végétales indigènes est pertinente dans toutes les régions de l'Amérique du Nord où elles sont présentes.

Pour ce qui est de l'information qui figure dans ce système, il convient de noter les points suivants :

- une grande partie de la documentation sur les plantes toxiques est de nature anecdotique et présente donc une fiabilité limitée.
- beaucoup de plantes sont peu toxiques ou ne produisent des symptômes que dans des circonstances inhabituelles (p. ex. consommation d'énormes quantités)
- l'auteur s'est efforcé de trouver les documents les plus récents qui étaient disponibles sur chacune des espèces traitées (jusqu'à 1993, date de publication de la première version). Cependant, dans beaucoup de cas, l'information la plus récente est tirée d'ouvrages publiés au début du XX^e si.

[English](#) | [Contactez nous](#) | [Aide](#) | [Recherche](#) | [Site du Canada](#)
[À venir](#) | [À notre sujet](#) | [Liens](#) | [Rapports et publications](#) |
[Accueil](#)

Date de modification: 2003-02-06

[Avis important](#)



Français	Contact us	Help	Search	Canada site
Coming events	About CBIF	Links	Reports and publications	Home

Canadian Biodiversity Information Facility



Intended audience - Canadian poisonous plants

[Introduction](#)[Interactive](#)[All poisonous plants by Botanical name](#)[All poisonous plants by Common name](#)[Important WWW Poisonous Plants sites](#)

The Information System is intended for use by veterinarians, doctors, and poison control personnel. The information is based entirely on literature references. Biologists are asked to excuse the convenient separation of animals and humans, which allows more rapid access to information for veterinarians and poison control personnel.



[Français](#) | [Contact Us](#) | [Help](#) | [Search](#) | [Canada site](#)

[Coming Events](#) | [About CBIF](#) | [Links](#) | [Reports and Publications](#) | [Home](#)

Date modified: 2003-02-06

[Important Notices](#)



Français	Contact us	Help	Search	Canada site
Coming events	About CBIF	Links	Reports and publications	Home

Canadian Biodiversity Information Facility



What the information system does

[Introduction](#)

[Interactive](#)

[All poisonous plants by Botanical name](#)

[All poisonous plants by Common name](#)

[Important WWW Poisonous Plants sites](#)



The Information System is intended for USE AS A RESEARCH TOOL that provides access to information on poisonous plants and their effects on animals and humans. The program contains information on:

- plant nomenclature (common and scientific names)
- distribution of wild plants (rendered graphically by province and territory)
- cultivated and food plants of concern
- toxic plant parts
- toxic chemicals (if known)
- additional descriptive information on many of the poisonous plants
- references from which information was extracted (up to the 1993 publishing date of the original document)

Veterinarians

Veterinarians can find information on poisoning of livestock and pets for:

- animals that have been poisoned by a particular plant and on all plants that have caused poisoning in a particular animal species
- symptoms of recognized diseases (such as chewing disease)
- symptoms of poisoning for each animal species that may be poisoned

Medical doctors//Poison control

Medical doctors and poison control centre personnel can obtain details on:

- human poisoning by a particular plant and on all plants that have caused poisoning in humans

- symptoms of recognized diseases (such as milk sickness)
- symptoms of poisoning by each plant species

[Français](#) | [Contact Us](#) | [Help](#) | [Search](#) | [Canada site](#)
[Coming Events](#) | [About CBIF](#) | [Links](#) | [Reports and Publications](#) |
[Home](#)

Date modified: 2003-02-06

[Important Notices](#)



Français	Contact us	Help	Search	Canada site
Coming events	About CBIF	Links	Reports and publications	Home

Canadian Biodiversity Information Facility



What the information system does not do

[Introduction](#)

[Interactive](#)

[All poisonous plants by Botanical name](#)

[All poisonous plants by Common name](#)

[Important WWW Poisonous Plants sites](#)



This Information System does not provide the following:

- a means for identifying poisonous plants. A decision was made to leave out this feature because of the complication and time involved in developing a complete identification system to separate all the poisonous plants from nonpoisonous plants that may be encountered. Other computerized systems under development may provide on-screen identification of poisonous plants. For example, Debbie Metsger has been doing research into the development of computer identification systems with specific reference to ingested house plants in Canada, including poisonous plants. She may be contacted at:

[Debbie Metsger](#)

Department of Botany
Royal Ontario Museum
100 Queen Park Cres. West
Toronto, Ont. M5S 2C6

Also, please see our web page to [other important WWW Poisonous Plant sites](#).

- a diagnostic tool for medical situations. In some cases, additional information has been provided on treatments that have been reported as effective, but this inclusion by no means implies any comment of their use. For more information, you should always get a copy of the original published references.

[Français](#) | [Contact Us](#) | [Help](#) | [Search](#) | [Canada site](#)
[Coming Events](#) | [About CBIF](#) | [Links](#) | [Reports and Publications](#) | [Home](#)

Date modified: 2003-02-06

[Important Notices](#)



Français	Contact us	Help	Search	Canada site
Coming events	About CBIF	Links	Reports and publications	Home

Canadian Biodiversity Information Facility



Illustrations - Canadian poisonous plants

[Introduction](#)

[Interactive](#)

[All poisonous plants by Botanical name](#)

[All poisonous plants by Common name](#)

[Important WWW Poisonous Plants sites](#)

Illustrative material was not included in the original version of this product. However we are grateful to several web sites that have given us permission to point to their images.

We intend to add images and illustrations for more plant species as time allows. If anyone has images that you could let us use or know of internet links to images for other poisonous plants please contact [Derek Munro](#). Thank you very much.



[Français](#) | [Contact Us](#) | [Help](#) | [Search](#) | [Canada site](#)

[Coming Events](#) | [About CBIF](#) | [Links](#) | [Reports and Publications](#) | [Home](#)

Date modified: 2003-02-06

[Important Notices](#)



Français	Contact us	Help	Search	Canada site
Coming events	About CBIF	Links	Reports and publications	Home

Canadian Biodiversity Information Facility



Acknowledgements - Canadian poisonous plants

[Introduction](#)[Interactive](#)[All poisonous plants by Botanical
name](#)[All poisonous plants by Common
name](#)[Important WWW Poisonous
Plants sites](#)

The author wishes to thank the following individuals from Agriculture & Agri-Food Canada (AAFC):

- Gerry Mulligan (retired) who started the initial literature projects on poisonous plants and with whom the author has co-authored three publications on the subject including "Poisonous Plants of Canada"
- Scientific editing was provided by Jane Buckley and Frances Smith. Any remaining errors are the responsibility of the author.
- [Guy Baillargeon](#) who encouraged the author to start the Internet project, for continued help and ideas on computerizing this information, and for some French translations.
- Walter Majak, Harriet Douwes and [Ruth McDiarmid](#) [who supplied the chemical diagrams], all of Kamloops Research Station, Kamloops, B.C.
- Dr. Donna Hutchings, Microbiology, CFIA, Ottawa, Ont.
- [Debbie Metsger](#), Department of Botany, Royal Ontario Museum, Toronto, Ont.

French Translation:

1. Stephen Bolcso of the Research Branch, AAFC for helping to find funding for the French translation,
2. the translation was done by Jean-Pierre Artigau, Traductions Artigau, Inc, Alymer, Qc,
3. finishing touches by Françoise Guilbault of Research Branch.

[Français](#) | [Contact Us](#) | [Help](#) | [Search](#) | [Canada site](#)

[Coming Events](#) | [About CBIF](#) | [Links](#) | [Reports and Publications](#) | [Home](#)

Date modified: 2003-02-06

[Important Notices](#)



Français	Contact us	Help	Search	Canada site
Coming events	About CBIF	Links	Reports and publications	Home

Canadian Biodiversity Information Facility

Project History

[Introduction](#)

[Interactive](#)

[All poisonous plants by Botanical name](#)

[All poisonous plants by Common name](#)

[Important WWW Poisonous Plants sites](#)

During the 1980's Gerry Mulligan (retired) and I (Derek Munro) produced two technical bulletins and a publication on poisonous plants in Canada. In 1990 I started work on a database version of the poisonous plants using DBase software. This was published as a *runtime* version for DOS computers. With the introduction of the World Wide Web I converted the DBase version into an Internet product using UNIX shell scripts and delimited text files (thereby simulating a relational database system). The latest incarnation has been ported into Oracle SQL database enabling extra query possibilities, enhanced performance, and XML (eXtensible Markup Language) output for application developers.



Publishing History:

- Mulligan, G.A & Munro, D.B. 1983. Vascular plants poisonous to livestock in Canada 1. A preliminary inventory. Contribution 1983-23E. Research Branch, Agriculture & Agri-Food Canada. 33 pp.
- Mulligan, G.A. & Munro, D.B. 1984. Wild and cultivated plants poisonous to humans in Canada. A preliminary inventory. Technical Bulletin 1984-15E. Research Branch, Agriculture & Agri-Food Canada. 22 pp.
- Mulligan, G.A. & Munro, D.B. 1990. Poisonous plants of Canada. Publication 1842/E. Ministry of Supply and Services Canada. 96 pp.
- Munro, D.B. 1993. Canadian Poisonous Plants Information System. Information Systems No. 1993-1B Agriculture & Agri-Food Canada (Manual 15 pp + 3 DOS diskettes)
- Munro, D.B. 1996. Canadian Poisonous Plants Information System Internet version 1. (no longer available at <http://res.agr.ca/brd/poisonpl/>)
- Munro, D.B. 2000. Canadian Poisonous Plants Information System Internet version 2. (<http://www.cbif.gc.ca/poison/>)

[Français](#) | [Contact Us](#) | [Help](#) | [Search](#) | [Canada site](#)

[Coming Events](#) | [About CBIF](#) | [Links](#) | [Reports and Publications](#) | [Home](#)

Date modified: 2003-02-06

[Important Notices](#)

- BoDD Search Engine •
- BoDD Home Page • [BoDD Home Page](#) • Support BoDD •
- Plant Families Index • • Main Index •



Welcome to BoDD

the Botanical Dermatology Database

WWW Launch Date: 08 August 1994
This page last updated: 05 January 2004
[[Server statistics](#); [Sites with links to BoDD](#)]

From the time of its WWW launch in August 1994 until January 1997 access to BoDD was restricted. Access restrictions were then removed. Anyone may now access the database. You may enter BoDD via the index links below. If you find BoDD useful, please consider supporting the project with a donation. Follow the [Support BoDD](#) link to discover how you can contribute to the upkeep of the project.

BoDD is an electronic re-incarnation of BOTANICAL DERMATOLOGY by John Mitchell & Arthur Rook, which was originally published in 1979 by Greengrass Ltd, Vancouver [ISBN 0-88978-047-1]. This updated on-line version is made available to you with the kind permission of the original authors.

This database is under continuous development. You may view the indexes, text, and image files but you may not systematically download the database, nor reproduce the html

code, text or images for profit or gain without express permission from the copyright holder. Educational users should make proper acknowledgement of the source of any information derived from BoDD.

If your browser is capable of displaying forms, please use the [BoDD Search Engine](#) to enter BoDD. For other users, only the [Plant Families Index](#) provides access to the whole database. The [Main Index](#) is under construction and will in due course provide a variety of alternative entry modes.

Constructive criticism, corrections, etc. will be gratefully received.

File format last modified: 01/2004
Content last updated: 01/2004



Copyright © Richard J. Schmidt PhD 1994 - 2004
schmidt@cf.ac.uk

<http://BoDD.cf.ac.uk/BoDDHomePage.html>

[Valid HTML
4.01!]



English	Contactez-nous	Aide	Recherche	Site du Canada
À venir	À notre sujet	Liens	Rapports et publications	Accueil

Système canadien d'information sur la biodiversité



Toutes les plantes vénéneuses

[Introduction](#)[Recherche interactive](#)[Liste de toutes les plantes toxiques par nom scientifique](#)[Liste de toutes les plantes toxiques par nom commun](#)[Les principaux sites Web sur les plantes toxiques](#)**Nom scientifique**[*Abrus precatorius*](#)[*Acer rubrum*](#)[*Aconitum napellus*](#)[*Aesculus glabra*](#)[*Aesculus hippocastanum*](#)[*Agrostemma githago*](#)[*Ailanthus altissima*](#)[*Allamanda cathartica*](#)[*Allium canadense*](#)[*Allium cepa*](#)[*Allium sativum*](#)[*Allium schoenoprasum*](#)[*Aloe arborescens*](#)[*Aloe barbadensis*](#)[*Alstroemeria ligtu*](#)[*Amaranthus blitoides*](#)[*Amaranthus hybridus*](#)[*Amaranthus retroflexus*](#)[*Amaryllis belladonna*](#)[*Amaryllis vittata*](#)[*Amelanchier alnifolia*](#)[*Amsinckia intermedia*](#)[*Anagallis arvensis*](#)[*Anthurium andraeanum*](#)[*Apocynum androsaemifolium*](#)[*Apocynum cannabinum*](#)[*Arisaema triphyllum*](#)**Nom commun**

abrus à chapelet

érable rouge

aconit Napel

marronnier à fleurs rouges

marronnier

nielle

frêne puant

trompette dorée

ail du Canada

oignon

ail

ciboulette

corne de cerf

aloès

lis des Incas

amarante fausse-blite

amarante hybride

amarante à racine rouge

amaryllis belladone

amaryllis

amélanchier à feuilles d'aulne

Amsinckia

mouron rouge

Anthurium

apocyn à feuilles d'androsème

apocyn chanvrin

petit-prêcheur

<u><i>Armoracia rusticana</i></u>	raifort
<u><i>Asarum canadense</i></u>	asaret du Canada
<u><i>Asclepias speciosa</i></u>	belle asclépiade
<u><i>Asclepias syriaca</i></u>	asclépiade de Syrie
<u><i>Asclepias verticillata</i></u>	asclépiade verticillée
<u><i>Asimina triloba</i></u>	asiminier trilobé
<u><i>Astragalus adsurgens</i></u>	Astragalus (A. adsurgens)
<u><i>Astragalus bisulcatus</i></u>	astragale fondu
<u><i>Astragalus canadensis</i></u>	astragale du Canada
<u><i>Astragalus lentiginosus</i></u>	Astragalus (A. lentiginosus)
<u><i>Astragalus miser</i></u>	astragale prostré
<u><i>Avena sativa</i></u>	avoine
<u><i>Baptisia leucantha</i></u>	baptisie leucanthe
<u><i>Baptisia tinctoria</i></u>	indigo sauvage
<u><i>Barbarea vulgaris</i></u>	barbarée vulgaire
<u><i>Bassia hyssopifolia</i></u>	bassia à feuilles d'hysope
<u><i>Brassaia actinophylla</i></u>	arbre ombrelle
<u><i>Brassica campestris</i></u>	moutarde des oiseaux
<u><i>Brassica juncea</i></u>	moutarde de l'Inde
<u><i>Brassica napus</i></u>	navette
<u><i>Brassica oleracea</i></u>	chou sauvage
<u><i>Caladium bicolor</i></u>	caladium
<u><i>Calla palustris</i></u>	calla des marais
<u><i>Cannabis sativa</i></u>	chanvre
<u><i>Caulophyllum thalictroides</i></u>	graines à chapelet
<u><i>Centaurea repens</i></u>	centaurée de Russie
<u><i>Centaurea solstitialis</i></u>	centaurée du solstice
<u><i>Ceratocephalus testiculatus</i></u>	Ceratocephalus
<u><i>Chelidonium majus</i></u>	grande chélideine
<u><i>Chenopodium album</i></u>	chénopode blanc
<u><i>Chrysanthemum indicum</i></u>	chrysanthème
<u><i>Chrysothamnus nauseosus</i></u>	bigelovie puante
<u><i>Cicuta douglasii</i></u>	cicutaire pourpre
<u><i>Cicuta maculata</i></u>	carotte à Moreau
<u><i>Cicuta virosa</i></u>	cicutaire du nord
<u><i>Clivia miniata</i></u>	clivies
<u><i>Codiaeum variegatum</i></u>	croton ou codier
<u><i>Colchicum autumnale</i></u>	colchique d'automne

<u><i>Conium maculatum</i></u>	cigüe maculée
<u><i>Convallaria majalis</i></u>	muguet
<u><i>Cyclamen persicum</i></u>	cyclamen de Perse
<u><i>Cynoglossum officinale</i></u>	cynoglosse officinale
<u><i>Cypripedium acaule</i></u>	cyripède acaule
<u><i>Cypripedium calceolus</i></u>	cyripède soulier
<u><i>Cypripedium reginae</i></u>	cyripède royal
<u><i>Daphne cneorum</i></u>	daphné camélee
<u><i>Daphne laureola</i></u>	auriole
<u><i>Daphne mezereum</i></u>	daphné jolibois
<u><i>Datura innoxia</i></u>	stramoine parfumée
<u><i>Datura stramonium</i></u>	stramoine commune
<u><i>Delphinium bicolor</i></u>	ped d'alouette bicolore
<u><i>Delphinium glaucum</i></u>	ped d'alouette glauque
<u><i>Delphinium menziesii</i></u>	Delphinium menziesii Delphinium
<u><i>Descurainia pinnata</i></u>	moutarde tanaisie verte
<u><i>Dicentra canadensis</i></u>	dicentre du Canada
<u><i>Dicentra cucullaria</i></u>	dicentre à capuchon
<u><i>Dicentra formosa</i></u>	dielytra à belles fleurs
<u><i>Dictamnus albus</i></u>	dictame
<u><i>Dieffenbachia amoena</i></u>	arum vénéneux
<u><i>Dieffenbachia bausei</i></u>	dieffenbachia
<u><i>Dieffenbachia maculata</i></u>	dieffenbachia tachetée
<u><i>Dieffenbachia seguine</i></u>	Dieffenbachia
<u><i>Digitalis purpurea</i></u>	digitale pourpre
<u><i>Dirca palustris</i></u>	dirca des marais
<u><i>Echium vulgare</i></u>	vipérine
<u><i>Equisetum arvense</i></u>	prèle des champs
<u><i>Equisetum palustre</i></u>	prèle des marais
<u><i>Erysimum cheiranthoides</i></u>	vélar fausse giroflée
<u><i>Euonymus atropurpureus</i></u>	fusain
<u><i>Euonymus europaeus</i></u>	fusain d'Europe
<u><i>Eupatorium rugosum</i></u>	eupatoire rugueuse
<u><i>Euphorbia cyparissias</i></u>	euphorbe cyprès
<u><i>Euphorbia esula</i></u>	euphorbe ésule
<u><i>Euphorbia helioscopia</i></u>	euphorbe réveille-matin
<u><i>Euphorbia lactea</i></u>	cactus candélabre
<u><i>Euphorbia lathyris</i></u>	cagarrino

<u><i>Euphorbia milii</i></u>	couronne d'épines
<u><i>Euphorbia peplus</i></u>	euphorbe des jardins
<u><i>Euphorbia pulcherrima</i></u>	poinsettia
<u><i>Euphorbia tirucalli</i></u>	euphorbe effilée
<u><i>Fagopyrum esculentum</i></u>	sarrasin commun
<u><i>Galanthus nivalis</i></u>	perce-neige
<u><i>Ginkgo biloba</i></u>	ginkgo
<u><i>Glechoma hederacea</i></u>	lierre terrestre
<u><i>Gloriosa superba</i></u>	glorieuse du Malabar
<u><i>Glyceria grandis</i></u>	glycérie géante
<u><i>Gutierrezia sarothrae</i></u>	gutierrezie faux-sarothra
<u><i>Gymnocladus dioicus</i></u>	chicot du Canada
<u><i>Hedera helix</i></u>	lierre commun
<u><i>Helenium autumnale</i></u>	hélénie automnale
<u><i>Helenium flexuosum</i></u>	hélénie nudiflore
<u><i>Helianthus annuus</i></u>	hélianthe annuel
<u><i>Heliotropium curassavicum</i></u>	héliotrope obové de Curaçao
<u><i>Heracleum mantegazzianum</i></u>	berce du Caucase
<u><i>Humulus lupulus</i></u>	houblon
<u><i>Hyacinthoides nonscripta</i></u>	jacinthe des bois
<u><i>Hydrangea macrophylla</i></u>	hortensia
<u><i>Hymenoxys richardsonii</i></u>	hyménoxys de Richardson
<u><i>Hyoscyamus niger</i></u>	jusquiame noire
<u><i>Hypericum perforatum</i></u>	millepertuis perforé
<u><i>Ilex aquifolium</i></u>	houx commun
<u><i>Ilex opaca</i></u>	houx d'Amérique
<u><i>Ipomoea tricolor</i></u>	liseron
<u><i>Iris pseudacorus</i></u>	iris de marais
<u><i>Iris versicolor</i></u>	clajoux
<u><i>Iva xanthifolia</i></u>	fausse herbe à poux
<u><i>Juglans nigra</i></u>	noyer noir
<u><i>Kalanchoe daigremontiana</i></u>	Kalanchoe
<u><i>Kalmia angustifolia</i></u>	kalmia à feuilles étroites
<u><i>Kalmia polifolia</i></u>	kalmia à feuilles d'andromède
<u><i>Kochia scoparia</i></u>	kochia à balais
<u><i>Laburnum anagyroides</i></u>	cytise
<u><i>Lactuca scariola</i></u>	laitue scariole
<u><i>Lantana camara</i></u>	Lantana

<u><i>Laportea canadensis</i></u>	laportéa du Canada
<u><i>Lathyrus odoratus</i></u>	pois de senteur
<u><i>Lathyrus sativus</i></u>	lentil d'Espagne
<u><i>Leonurus cardiaca</i></u>	agripaume cardiaque
<u><i>Ligustrum vulgare</i></u>	troène commun
<u><i>Linaria vulgaris</i></u>	linaire vulgaire
<u><i>Lobelia cardinalis</i></u>	lobélie du cardinal
<u><i>Lobelia inflata</i></u>	lobélie gonflée
<u><i>Lobelia siphilitica</i></u>	cardinale bleue
<u><i>Lonicera tatarica</i></u>	chèvrefeuille de Tartarie
<u><i>Lonicera xylosteum</i></u>	chèvrefeuille à mouches
<u><i>Lupinus argenteus</i></u>	lupin argenté
<u><i>Lupinus burkei</i></u>	lupin de Burke
<u><i>Lupinus polyphyllus</i></u>	lupin de polyphylle
<u><i>Lupinus pusillus</i></u>	Lupinus
<u><i>Lupinus sericeus</i></u>	lupin soyeux
<u><i>Maclura pomifera</i></u>	bois d'arc
<u><i>Mangifera indica</i></u>	manguier
<u><i>Medicago sativa</i></u>	luzerne
<u><i>Melilotus alba</i></u>	mélilot blanc
<u><i>Melilotus officinalis</i></u>	mélilot jaune
<u><i>Menispermum canadense</i></u>	ménisperme du Canada
<u><i>Menziesia ferruginea</i></u>	menziézie ferrugineuse
<u><i>Monstera deliciosa</i></u>	philodendron monstéra
<u><i>Narcissus poeticus</i></u>	narcisse
<u><i>Narcissus pseudonarcissus</i></u>	jonquille
<u><i>Nerium oleander</i></u>	laurier rose
<u><i>Nicotiana tabacum</i></u>	tabac
<u><i>Onoclea sensibilis</i></u>	onoclée sensible
<u><i>Ornithogalum umbellatum</i></u>	dame d'onze heures
<u><i>Oxytropis lambertii</i></u>	oxytrophe de Lambert
<u><i>Oxytropis sericea</i></u>	Oxytropis
<u><i>Papaver nudicaule</i></u>	pavot d'Islande
<u><i>Papaver orientale</i></u>	pavot d'Orient
<u><i>Papaver rhoeas</i></u>	pavot coquelicot
<u><i>Papaver somniferum</i></u>	pavot somnifère
<u><i>Parthenocissus quinquefolia</i></u>	vigne vierge
<u><i>Pastinaca sativa</i></u>	panais sauvage

<u><i>Persea americana</i></u>	avocatier
<u><i>Phacelia campanularia</i></u>	phacélie de Californie
<u><i>Phalaris arundinacea</i></u>	alpiste roseau
<u><i>Philodendron cordatum</i></u>	Philodendron cordatum
<u><i>Philodendron scandens</i></u>	Philodendron (scandens)
<u><i>Phoradendron flavescens</i></u>	gui de chêne
<u><i>Physalis alkekengi</i></u>	alkékenge
<u><i>Physalis peruviana</i></u>	coqueret
<u><i>Phytolacca americana</i></u>	phytolaque d'Amérique
<u><i>Pinus ponderosa</i></u>	pin ponderosa
<u><i>Podophyllum peltatum</i></u>	podophylle pelté
<u><i>Primula obconica</i></u>	primula
<u><i>Prunus pensylvanica</i></u>	cerisier de Pennsylvanie
<u><i>Prunus serotina</i></u>	cerisier tardif
<u><i>Prunus virginiana</i></u>	cerisier de Virginie
<u><i>Pteridium aquilinum</i></u>	fougère d'aigle
<u><i>Quercus alba</i></u>	chêne blanc
<u><i>Quercus rubra</i></u>	chêne rouge
<u><i>Quercus velutina</i></u>	chêne noir
<u><i>Ranunculus bulbosus</i></u>	renoncule bulbeuse
<u><i>Ranunculus sceleratus</i></u>	renoncule scélérate
<u><i>Raphanus raphanistrum</i></u>	radis sauvage
<u><i>Raphanus sativus</i></u>	radis
<u><i>Rhamnus cathartica</i></u>	nerprun commun
<u><i>Rhamnus frangula</i></u>	nerprun bourdaine
<u><i>Rheum rhaponticum</i></u>	rhubarbe
<u><i>Rhododendron albiflorum</i></u>	azalée blanche
<u><i>Rhododendron macrophyllum</i></u>	rhododendron de Californie
<u><i>Rhus diversiloba</i></u>	sumac de l'Ouest
<u><i>Rhus radicans</i></u>	herbe à la puce
<u><i>Rhus vernix</i></u>	sumac à vernis
<u><i>Ricinus communis</i></u>	ricin
<u><i>Robinia pseudoacacia</i></u>	robinier faux-acacia
<u><i>Rudbeckia laciniata</i></u>	rudbeckie laciniée
<u><i>Rudbeckia serotina</i></u>	rudbeckie hérissée
<u><i>Rumex acetosa</i></u>	grande oseille
<u><i>Rumex acetosella</i></u>	petite oseille
<u><i>Rumex venosus</i></u>	rumex veiné

<u><i>Sambucus canadensis</i></u>	sureau blanc
<u><i>Sambucus nigra</i></u>	sureau noir
<u><i>Sarcobatus vermiculatus</i></u>	sarcobatus vermiculé
<u><i>Scilla siberica</i></u>	scille de Sibérie
<u><i>Senecio integerrimus</i></u>	Senecio
<u><i>Senecio jacobaea</i></u>	séneçon jacobée
<u><i>Senecio vulgaris</i></u>	séneçon vulgaire
<u><i>Sinapis arvensis</i></u>	moutarde des champs
<u><i>Solanum dulcamara</i></u>	morelle douce-amère
<u><i>Solanum nigrum</i></u>	morelle noire
<u><i>Solanum pseudocapsicum</i></u>	cerisier d'amour
<u><i>Solanum tuberosum</i></u>	pomme de terre
<u><i>Solidago mollis</i></u>	verge d'or veloutée
<u><i>Sorghum bicolor</i></u>	sorgho
<u><i>Sorghum halepense</i></u>	sorgho d'Alep
<u><i>Sorghum sudanense</i></u>	sorgho du Soudan
<u><i>Suckleya suckleyana</i></u>	Suckleya
<u><i>Symphoricarpos albus</i></u>	symphorine à grappes
<u><i>Symphytum asperum</i></u>	consoude âpre
<u><i>Symphytum officinale</i></u>	consoude officinale
<u><i>Symplocarpus foetidus</i></u>	chou puant
<u><i>Tanacetum vulgare</i></u>	tanaïsie vulgaire
<u><i>Taxus baccata</i></u>	if de l'Angleterre
<u><i>Taxus canadensis</i></u>	if du Canada
<u><i>Taxus cuspidata</i></u>	if du Japon
<u><i>Thermopsis rhombifolia</i></u>	Thermopsis
<u><i>Thlaspi arvense</i></u>	tabouret des champs
<u><i>Trifolium hybridum</i></u>	trèfle alsike
<u><i>Trifolium pratense</i></u>	trèfle rouge
<u><i>Trifolium repens</i></u>	trèfle blanc
<u><i>Triglochin maritima</i></u>	troscart maritime
<u><i>Triglochin palustre</i></u>	troscart des marais
<u><i>Tulipa gesneriana</i></u>	tulipe
<u><i>Urtica dioica</i></u>	ortie dioïque
<u><i>Veratrum viride</i></u>	varaïre vert
<u><i>Viburnum opulus</i></u>	obier
<u><i>Vicia faba</i></u>	vesce fève
<u><i>Vicia sativa</i></u>	vesce cultivée

[Vicia villosa](#)

vesce velue

[Wisteria floribunda](#)

glycine du Japon

[Xanthium strumarium](#)

lampourde glouteron

[Zigadenus elegans](#)

zigadène élégant

[Zigadenus venenosus](#)

zigadène vénéneux

[Une autre recherche?](#)

[English](#) | [Contactez nous](#) | [Aide](#) | [Recherche](#) | [Site du Canada](#)

[À venir](#) | [À notre sujet](#) | [Liens](#) | [Rapports et publications](#) |

[Accueil](#)

Date de modification: 2003-02-06

[Avis important](#)



Français	Contact us	Help	Search	Canada site
Coming events	About CBIF	Links	Reports and publications	Home

Canadian Biodiversity Information Facility



Notes on poisoning: *Abrus precatorius*

[Introduction](#)[Interactive](#)[All poisonous plants by Botanical name](#)[All poisonous plants by Common name](#)[Important WWW Poisonous Plants sites](#)

General poisoning notes:

Precatory-pea (*Abrus precatorius*) seeds contain a chemical called abrin, which is highly toxic. A single well-masticated seed can kill an adult human (Kingsbury 1964).

In Canada the seeds of this plant are imported into the country on necklaces and perhaps on other decorative items. These attractive seeds are shiny, red, and black and about 5-8 mm long (Hoy and Catling 1981).

References:

Davis, J. H. 1978. *Abrus precatorius* (rosary pea). The most common lethal plant poison. J. Fla. Med. Assoc., 65: 189-191.

Gunn, C. R. 1969. *Abrus precatorius*: a deadly gift. Gard. J., 19:2-5.

Hoy, D. L., Catling, P. M. 1981. Necklaces from nature - seed jewelry. Davidsonia, 12: 63-77.

Kingsbury, J. M. 1964. Poisonous plants of the United States and Canada. Prentice-Hall Inc., Englewood Cliffs, N.J., USA. 626 pp.

Stirpe, F., Barbieri, L. 1986. Ribosome-inactivating proteins up to date. FEBS (Fed. Eur. Biochem. Soc.) Lett., 195: 1-8.

Nomenclature:

Scientific Name: *Abrus precatorius* L.

Vernacular name(s): precatory-pea

Scientific family name: *Leguminosae*

Vernacular family name: pea

Go to ITIS^{*ca} for more taxonomic information on: [Abrus](#)

[precatorius](#)

References:

Agriculture Quebec. 1975. Noms des maladies des plantes du Canada/ Names of plant diseases in Canada. , Quebec City, Que., Canada. 288 pp.

Alex, J. F., Cayouette, R., Mulligan, G. A. 1980. Common and botanical names of weeds in Canada/Noms populaire et scientifiques des plantes nuisibles du Canada. Revised. Agric. Can. Publ., Ottawa, Ont., Canada. 132 pp.

Bailey, L. H., Bailey, E. Z. 1976. Hortus third. Revised. MacMillan, New York, N.Y., USA. 1290 pp.

Scoggan, H. J. 1978, 1979. The flora of Canada. Nat. Mus. Nat. Sci. (Ottawa) Publ. Bot. 7(1)-7(4). 1711 pp.

Van Wijk, H. L. 1911. A dictionary of plant names. Martinus Nijhoff, The Hague, The Netherlands. 1444 pp.

Victorin, M. 1964. Flore Laurentienne. 2nd ed. Univ. Montreal, Montreal, Que., Canada. 952 pp.

Geographic Information

Plant or plant parts used in or around the home.

References:

Bailey, L. H., Bailey, E. Z. 1976. Hortus third. Revised. MacMillan, New York, N.Y., USA. 1290 pp.

Boivin, B. 1966, 1967. Énumération des plantes du Canada. Provencheria 6. Nat. Can. (Que.) 93: 253-274; 371-437; 583-646; 989-1063. 94: 131-157; 471-528; 625-655.

Image or illustration

Abrus precatorius:

Images: images.google.com

Toxic parts:

seeds

References:

Davis, J. H. 1978. *Abrus precatorius* (rosary pea). The most common lethal plant poison. J. Fla. Med. Assoc., 65: 189-191.

Gunn, C. R. 1969. *Abrus precatorius*: a deadly gift. Gard. J., 19:2-5.

Hoy, D. L., Catling, P. M. 1981. Necklaces from nature - seed jewelry. Davidsonia, 12: 63-77.

Notes on Toxic plant chemicals:

Abrin is a lectin of *Abrus precatorius* and is a ribosome-inactivating protein. This chemical is regarded as one of the most deadly plant toxins known.

LD-50: 0.56 micro gm/kg in mice (Stirpe and Barbieri 1986). Kingsbury (1964) states that a toxicity dose is about 0.00015% of a human subject's weight. A single well-masticated seed can kill an adult. Abrin causes large-scale disruption in lymphoid tissues, with apoptotic cell death. Apoptotic bodies have increased in the small intestine of experimental rats (Griffiths et al. 1987).

Toxic plant chemicals:

abrin

References:

Davis, J. H. 1978. *Abrus precatorius* (rosary pea). The most common lethal plant poison. J. Fla. Med. Assoc., 65: 189-191.

Griffiths, G. D., Leek, M. D., Gee, D. J. 1987. The toxic plant proteins ricin and abrin induce apoptotic changes in mammalian lymphoid tissues and intestine. J. Pathol., 151: 221-229.

Kingsbury, J. M. 1964. Poisonous plants of the United States and Canada. Prentice-Hall Inc., Englewood Cliffs, N.J., USA. 626 pp.

Stirpe, F., Barbieri, L. 1986. Ribosome-inactivating proteins up to date. FEBS (Fed. Eur. Biochem. Soc.) Lett., 195: 1-8.

Animals/Human Poisoning:

Note: When an animal is listed without additional information, the literature (as of 1993) contained no detailed explanation.

Humans

General symptoms of poisoning:

[abdominal pains](#)

[cecum, red and inflamed](#)

[cerebral edema](#)

[death](#)

[diarrhea](#)

[gastric mucosa, purple](#)

[nausea](#)

[stomach, gray mucous](#)

[vomiting](#)

References:

Davis, J. H. 1978. *Abrus precatorius* (rosary pea). The most common lethal plant poison. J. Fla. Med. Assoc., 65: 189-191.

Gunn, C. R. 1969. *Abrus precatorius*: a deadly gift. Gard. J., 19:2-5.

Hoy, D. L., Catling, P. M. 1981. Necklaces from nature - seed jewelry. Davidsonia, 12: 63-77.

Rodents

General symptoms of poisoning:

[death](#)

References:

Stirpe, F., Barbieri, L. 1986. Ribosome-inactivating proteins up to date. FEBS (Fed. Eur. Biochem. Soc.) Lett., 195: 1-8.

[Another search?](#)

[Français](#) | [Contact Us](#) | [Help](#) | [Search](#) | [Canada site](#)

[Coming Events](#) | [About CBIF](#) | [Links](#) | [Reports and Publications](#) |

[Home](#)

Date modified: 2003-02-06

[Important Notices](#)



Français	Contact us	Help	Search	Canada site
Coming events	About CBIF	Links	Reports and publications	Home

Canadian Biodiversity Information Facility



Notes on poisoning: *Acer rubrum*

[Introduction](#)[Interactive](#)[All poisonous plants by Botanical name](#)[All poisonous plants by Common name](#)[Important WWW Poisonous Plants sites](#)

General poisoning notes:

Red maple (*Acer rubrum*) is a native tree found in eastern Canada. Leaves of this plant have poisoned horses in the New England States and Georgia. Divers et al. (1982) noted that three of four horses died in one case. Experimental symptoms of hemolytic anemia indistinguishable from the field case were induced in a pony. This problem should be suspected in horses in which acute hemolytic anemia occurs after they ingest red maple leaves.

Horses are poisoned sporadically in the northeastern United States after they ingest red maple leaves. Signs of toxicity are similar to those seen with the *Brassica* anemia factor after animals ingest plants of the genus *Brassica* (such as canola, kale, cabbage). Tennant et al. (1981) noted 33 cases of hemolytic anemia in horses in the New England States in the late 1970s. These cases were attributed to red maple leaves.

References:

Cheeke, P. R., Shull, L. R. 1985. Natural toxicants in feeds and poisonous plants. AVI Publishing Company, Inc., Westport, Conn., USA. 492 pp.

Divers, T. J., George, L. W., George, J. W. 1982. Hemolytic anemia in horses after the ingestion of red maple leaves. *Toxicology*, 180: 300-302.

George, L. W., Divers, T. J., Mahaffey, E. A., Suarez, M. J. 1982. Heinz body anemia and methemoglobinemia in ponies given red maple (*Acer rubrum* L.) leaves. *Vet. Pathol.*, 19: 521-533.

Long, P. H., Payne, J. W. 1984. Red maple-associated pulmonary thrombosis in a horse. *J. Am. Vet. Med. Assoc.*, 184: 977-978.

Plumlee, K. H. 1991. Red maple toxicity in a horse. *Vet. Hum. Toxicol.*, 33: 66-67.

Tennant, B., Dill, S. G., Glickman, L. T., Mirro, E. J., King, J. M., Polak, D. M., Smith, M. C., Kradel, D. C. 1981. Acute hemolytic anemia, methemoglobinemia, and Heinz body formation associated with ingestion of red maple leaves by horses. *J. Am. Vet. Med. Assoc.*, 179: 143-150.

Nomenclature:

Scientific Name: *Acer rubrum* L.

Vernacular name(s): red maple

Scientific family name: *Aceraceae*

Vernacular family name: maple

Go to ITIS^{*ca} for more taxonomic information on: [Acer rubrum](#)

References:

Agriculture Quebec. 1975. Noms des maladies des plantes du Canada/ Names of plant diseases in Canada. , Quebec City, Que., Canada. 288 pp.

Alex, J. F., Cayouette, R., Mulligan, G. A. 1980. Common and botanical names of weeds in Canada/Noms populaire et scientifiques des plantes nuisibles du Canada. Revised. Agric. Can. Publ., Ottawa, Ont., Canada. 132 pp.

Bailey, L. H., Bailey, E. Z. 1976. Hortus third. Revised. MacMillan, New York, N.Y., USA. 1290 pp.

Scoggan, H. J. 1978, 1979. The flora of Canada. *Nat. Mus. Nat. Sci. (Ottawa) Publ. Bot.* 7(1)-7(4). 1711 pp.

Van Wijk, H. L. 1911. A dictionary of plant names. Martinus Nijhoff, The Hague, The Netherlands. 1444 pp.

Victorin, M. 1964. Flore Laurentienne. 2nd ed. Univ. Montreal, Montreal, Que., Canada. 952 pp.

Geographic Information

New Brunswick
Newfoundland
Nova Scotia
Ontario
Prince Edward Island
Quebec

References:

Bailey, L. H., Bailey, E. Z. 1976. Hortus third. Revised. MacMillan, New York, N.Y., USA. 1290 pp.

Boivin, B. 1966, 1967. Énumération des plantes du Canada. Provencheria 6. Nat. Can. (Que.) 93: 253-274; 371-437; 583-646; 989-1063. 94: 131-157; 471-528; 625-655.

Image or illustration

Acer rubrum:

Images: images.google.com

Notes on Poisonous plant parts:

The wilted leaves of red maple (*Acer rubrum*) have caused poisoning and death in horses. This toxicity is most prevalent from June through October. Cases become symptomatic 3-4 days after ingesting the leaves (Divers et al. 1982).

Wilted leaves administered to a pony at the rate of 3.0 g/kg of body weight caused illness and death within 1-5 days. Freshly harvested leaves did not cause any symptoms. Dried leaves remained toxic for 30 days (George et al. 1982).

Toxic parts:

leaves

References:

Cheeke, P. R., Shull, L. R. 1985. Natural toxicants in feeds and poisonous plants. AVI Publishing Company, Inc., Westport, Conn., USA. 492 pp.

Divers, T. J., George, L. W., George, J. W. 1982. Hemolytic anemia in horses after the ingestion of red maple leaves. Toxicology, 180: 300-302.

George, L. W., Divers, T. J., Mahaffey, E. A., Suarez, M. J. 1982. Heinz body anemia and methemoglobinemia in ponies given red maple (*Acer rubrum* L.) leaves. Vet. Pathol., 19: 521-533.

Long, P. H., Payne, J. W. 1984. Red maple-associated pulmonary thrombosis in a horse. J. Am. Vet. Med. Assoc., 184: 977-978.

Plumlee, K. H. 1991. Red maple toxicity in a horse. Vet. Hum. Toxicol., 33: 66-67.

Tennant, B., Dill, S. G., Glickman, L. T., Mirro, E. J., King, J.

M., Polak, D. M., Smith, M. C., Kradel, D. C. 1981. Acute hemolytic anemia, methemoglobinemia, and Heinz body formation associated with ingestion of red maple leaves by horses. *J. Am. Vet. Med. Assoc.*, 179: 143-150.

Notes on Toxic plant chemicals:

The chemical that causes hemolytic anemia poisoning in horses is not yet known for red maple (*Acer rubrum*). The chemical probably works as an oxidant. In Georgia, ponies poisoned by red maple leaves died rapidly when fed dried leaves after mid September, whereas ponies fed leaves collected earlier in the summer had a more prolonged illness. This finding suggests that the toxin increases in quantity during autumn (George et al. 1982).

Toxic plant chemicals:

unknown chemical

References:

George, L. W., Divers, T. J., Mahaffey, E. A., Suarez, M. J. 1982. Heinz body anemia and methemoglobinemia in ponies given red maple (*Acer rubrum* L.) leaves. *Vet. Pathol.*, 19: 521-533.

Tennant, B., Dill, S. G., Glickman, L. T., Mirro, E. J., King, J. M., Polak, D. M., Smith, M. C., Kradel, D. C. 1981. Acute hemolytic anemia, methemoglobinemia, and Heinz body formation associated with ingestion of red maple leaves by horses. *J. Am. Vet. Med. Assoc.*, 179: 143-150.

Animals/Human Poisoning:

Note: When an animal is listed without additional information, the literature (as of 1993) contained no detailed explanation.

Horses

General symptoms of poisoning:

[anorexia](#)

[blood brownish](#)

[brain, vacuolation of](#)

[breathing, rapid](#)

[coma](#)

[cyanosis](#)

[death](#)

[dehydration](#)
[depression](#)
[heart rate, elevated](#)
[Heinz bodies](#)
[hemoglobinuria](#)
[icterus](#)
[kidney, edema of](#)
[lungs, congestion of](#)
[lungs, thrombosis of](#)
[mucous membrane, brown](#)
[nephrosis, severe](#)
[urine, brownish](#)
[weakness](#)

References:

Divers, T. J., George, L. W., George, J. W. 1982. Hemolytic anemia in horses after the ingestion of red maple leaves. *Toxicology*, 180: 300-302.

George, L. W., Divers, T. J., Mahaffey, E. A., Suarez, M. J. 1982. Heinz body anemia and methemoglobinemia in ponies given red maple (*Acer rubrum* L.) leaves. *Vet. Pathol.*, 19: 521-533.

Long, P. H., Payne, J. W. 1984. Red maple-associated pulmonary thrombosis in a horse. *J. Am. Vet. Med. Assoc.*, 184: 977-978.

Plumlee, K. H. 1991. Red maple toxicity in a horse. *Vet. Hum. Toxicol.*, 33: 66-67.

[Another search?](#)

[Français](#) | [Contact Us](#) | [Help](#) | [Search](#) | [Canada site](#)

[Coming Events](#) | [About CBIF](#) | [Links](#) | [Reports and Publications](#) |

[Home](#)

Date modified: 2003-02-06

[Important Notices](#)



Français	Contact us	Help	Search	Canada site
Coming events	About CBIF	Links	Reports and publications	Home

Canadian Biodiversity Information Facility



Notes on poisoning: *Aconitum napellus*

[Introduction](#)[Interactive](#)[All poisonous plants by Botanical name](#)[All poisonous plants by Common name](#)[Important WWW Poisonous Plants sites](#)

General poisoning notes:

Monk's hood (*Aconitum napellus*) is an outdoor ornamental herb. The plant contains poisonous alkaloids, which have proved toxic in humans when accidentally ingested (e.g., aconitine; see Fiddes 1958). Few cases of animal poisoning occur (Kingsbury 1964).



References:

Fiddes, F. S. 1958. Poisoning by aconitine. Report of two cases. Br. Med. J., 2: 779-780.

Nomenclature:

Scientific Name: *Aconitum napellus* L.

Vernacular name(s): monk's hood

Scientific family name: *Ranunculaceae*

Vernacular family name: crowfoot

Go to ITIS*^{ca} for more taxonomic information on: [Aconitum napellus](#)

References:

Agriculture Quebec. 1975. Noms des maladies des plantes du Canada/ Names of plant diseases in Canada. , Quebec City, Que., Canada. 288 pp.

Alex, J. F., Cayouette, R., Mulligan, G. A. 1980. Common and botanical names of weeds in Canada/Noms populaire et scientifiques des plantes nuisibles du Canada. Revised. Agric. Can. Publ., Ottawa, Ont., Canada. 132 pp.

Bailey, L. H., Bailey, E. Z. 1976. Hortus third. Revised.

MacMillan, New York, N.Y., USA. 1290 pp.

Scoggan, H. J. 1978, 1979. The flora of Canada. Nat. Mus. Nat. Sci. (Ottawa) Publ. Bot. 7(1)-7(4). 1711 pp.

Van Wijk, H. L. 1911. A dictionary of plant names. Martinus Nijhoff, The Hague, The Netherlands. 1444 pp.

Victorin, M. 1964. Flore Laurentienne. 2nd ed. Univ. Montreal, Montreal, Que., Canada. 952 pp.

Geographic Information

Plant or plant parts used in or around the home.

References:

Bailey, L. H., Bailey, E. Z. 1976. Hortus third. Revised. MacMillan, New York, N.Y., USA. 1290 pp.

Boivin, B. 1966, 1967. Énumération des plantes du Canada. Provencheria 6. Nat. Can. (Que.) 93: 253-274; 371-437; 583-646; 989-1063. 94: 131-157; 471-528; 625-655.

Image or illustration

Aconitum napellus:

Images: images.google.com

Toxic parts:

all parts
leaves
roots

References:

Lampe, K. F., McCann, M. A. 1985. AMA Handbook of poisonous and injurious plants. American Medical Assoc. Chicago, Ill., USA. 432 pp.

Toxic plant chemicals:

aconitine

References:

Bonisteel, W. J. 1940. Polyploidy in relation to chemical analysis. J. Am. Pharm. Assoc., 6: 404-408.

Fiddes, F. S. 1958. Poisoning by aconitine. Report of two cases. Br. Med. J., 2: 779-780.

Animals/Human Poisoning:

Note: When an animal is listed without additional information, the literature (as of 1993) contained no detailed explanation.

Humans

General symptoms of poisoning:

[agitation](#)

[faintness](#)

[muscle, weakness of](#)

[nausea](#)

[salivation](#)

[skin, cold and moist](#)

[throat, constriction](#)

[tingling sensation](#)

[vomiting](#)

References:

Fiddes, F. S. 1958. Poisoning by aconitine. Report of two cases. Br. Med. J., 2: 779-780.

[Another search?](#)

[Français](#) | [Contact Us](#) | [Help](#) | [Search](#) | [Canada site](#)

[Coming Events](#) | [About CBIF](#) | [Links](#) | [Reports and Publications](#) |

[Home](#)

Date modified: 2003-02-06

[Important Notices](#)



Français	Contact us	Help	Search	Canada site
Coming events	About CBIF	Links	Reports and publications	Home

Canadian Biodiversity Information Facility



Notes on poisoning: *Aesculus glabra*

[Introduction](#)[Interactive](#)[All poisonous plants by Botanical name](#)[All poisonous plants by Common name](#)[Important WWW Poisonous Plants sites](#)

General poisoning notes:

Ohio buckeye (*Aesculus glabra*) is not native to Canada but is occasionally planted as an ornamental tree in southern Ontario. It is winter-hardy in Ottawa. Cattle have been poisoned in the eastern United States, where this tree is a native species. Symptoms are mostly gastrointestinal and neuromuscular (Kornheiser 1983). This plant is unlikely to cause livestock poisoning because it is rare in Canada. The fruits of this plant may be attractive to children and could cause poisoning if ingested.

References:

Kornheiser, K. M. 1983. Buckeye poisoning in cattle. *Vet. Med. Small Anim. Clin.*, 78: 769-770.

Lampe, K. F., McCann, M. A. 1985. *AMA Handbook of poisonous and injurious plants*. American Medical Assoc. Chicago, Ill., USA. 432 pp.

Nomenclature:

Scientific Name: *Aesculus glabra* Willd.

Vernacular name(s): Ohio buckeye

Scientific family name: *Hippocastanaceae*

Vernacular family name: horse-chestnut

Go to ITIS^{*ca} for more taxonomic information on: [Aesculus glabra](#)

References:

Agriculture Quebec. 1975. Noms des maladies des plantes du

Canada/ Names of plant diseases in Canada. , Quebec City, Que., Canada. 288 pp.

Alex, J. F., Cayouette, R., Mulligan, G. A. 1980. Common and botanical names of weeds in Canada/Noms populaire et scientifiques des plantes nuisibles du Canada. Revised. Agric. Can. Publ., Ottawa, Ont., Canada. 132 pp.

Bailey, L. H., Bailey, E. Z. 1976. Hortus third. Revised. MacMillan, New York, N.Y., USA. 1290 pp.

Scoggan, H. J. 1978, 1979. The flora of Canada. Nat. Mus. Nat. Sci. (Ottawa) Publ. Bot. 7(1)-7(4). 1711 pp.

Van Wijk, H. L. 1911. A dictionary of plant names. Martinus Nijhoff, The Hague, The Netherlands. 1444 pp.

Victorin, M. 1964. Flore Laurentienne. 2nd ed. Univ. Montreal, Montreal, Que., Canada. 952 pp.

Geographic Information

Plant or plant parts used in or around the home.

References:

Bailey, L. H., Bailey, E. Z. 1976. Hortus third. Revised. MacMillan, New York, N.Y., USA. 1290 pp.

Boivin, B. 1966, 1967. Énumération des plantes du Canada. Provencheria 6. Nat. Can. (Que.) 93: 253-274; 371-437; 583-646; 989-1063. 94: 131-157; 471-528; 625-655.

Image or illustration

Aesculus glabra:

Images: images.google.com

Toxic parts:

mature fruit

References:

Kornheiser, K. M. 1983. Buckeye poisoning in cattle. Vet. Med. Small Anim. Clin., 78: 769-770.

Animals/Human Poisoning:

Note: When an animal is listed without additional information,

the literature (as of 1993) contained no detailed explanation.

Cattle

General symptoms of poisoning:

[ataxia](#)

[gait, unsteady](#)

[opisthotonos](#)

[torticollis](#)

References:

Kornheiser, K. M. 1983. Buckeye poisoning in cattle. *Vet. Med. Small Anim. Clin.*, 78: 769-770.

Humans

General symptoms of poisoning:

[death](#)

[gastroenteritis](#)

References:

Lampe, K. F., McCann, M. A. 1985. *AMA Handbook of poisonous and injurious plants*. American Medical Assoc. Chicago, Ill., USA. 432 pp.

[Another search?](#)

[Français](#) | [Contact Us](#) | [Help](#) | [Search](#) | [Canada site](#)

[Coming Events](#) | [About CBIF](#) | [Links](#) | [Reports and Publications](#) |

[Home](#)

Date modified: 2003-02-06

[Important Notices](#)



Français	Contact us	Help	Search	Canada site
Coming events	About CBIF	Links	Reports and publications	Home

Canadian Biodiversity Information Facility



Notes on poisoning: *Aesculus hippocastanum*

[Introduction](#)

[Interactive](#)

[All poisonous plants by Botanical name](#)

[All poisonous plants by Common name](#)

[Important WWW Poisonous Plants sites](#)

General poisoning notes:

Horse-chestnut (*Aesculus hippocastanum*) is an introduced tree that is found in the southern parts of Ontario and Quebec. It has poisoned cattle, horses, and pigs, causing sickness and death (Reynard and Norton 1942, Muenscher 1975). Human poisoning has also occurred.

References:

Cooper, M. R., Johnson, A. W. 1984. Poisonous plants in Britain and their effects on animals and man. Her Majesty's Stationery Office, London, England. 305 pp.

Hardin, J. W., Arena, J. M. 1969. Human poisoning from native and cultivated plants. Duke University Press, Durham, N.C., USA. 167 pp.

Lampe, K. F., McCann, M. A. 1985. AMA Handbook of poisonous and injurious plants. American Medical Assoc. Chicago, Ill., USA. 432 pp.

Reynard, G. B., Norton, J. B. 1942. Poisonous plants of Maryland in relation to livestock. Univ. MD. Agric. Exp. Stn. Bull., A10. 312 pp.

Nomenclature:

Scientific Name: *Aesculus hippocastanum* L.

Vernacular name(s): horse-chestnut

Scientific family name: *Hippocastanaceae*

Vernacular family name: horse-chestnut

Go to ITIS*^{ca} for more taxonomic information on: [Aesculus](#)



[*hippocastanum*](#)

References:

Agriculture Quebec. 1975. Noms des maladies des plantes du Canada/ Names of plant diseases in Canada. , Quebec City, Que., Canada. 288 pp.

Alex, J. F., Cayouette, R., Mulligan, G. A. 1980. Common and botanical names of weeds in Canada/Noms populaire et scientifiques des plantes nuisibles du Canada. Revised. Agric. Can. Publ., Ottawa, Ont., Canada. 132 pp.

Bailey, L. H., Bailey, E. Z. 1976. Hortus third. Revised. MacMillan, New York, N.Y., USA. 1290 pp.

Scoggan, H. J. 1978, 1979. The flora of Canada. Nat. Mus. Nat. Sci. (Ottawa) Publ. Bot. 7(1)-7(4). 1711 pp.

Van Wijk, H. L. 1911. A dictionary of plant names. Martinus Nijhoff, The Hague, The Netherlands. 1444 pp.

Victorin, M. 1964. Flore Laurentienne. 2nd ed. Univ. Montreal, Montreal, Que., Canada. 952 pp.

Geographic Information

Plant or plant parts used in or around the home.

References:

Bailey, L. H., Bailey, E. Z. 1976. Hortus third. Revised. MacMillan, New York, N.Y., USA. 1290 pp.

Boivin, B. 1966, 1967. Énumération des plantes du Canada. Provencheria 6. Nat. Can. (Que.) 93: 253-274; 371-437; 583-646; 989-1063. 94: 131-157; 471-528; 625-655.

Image or illustration

Aesculus hippocastanum:

Images: images.google.com

Notes on Poisonous plant parts:

Horse-chestnut fruits, leaves, and flowers contain the chemical aesculin. Young leaves and flowers are especially toxic to cattle (Reynard and Norton 1942). Children occasionally ingest the fruit but few authenticated cases of poisoning are found in the literature, although death has been reported (Lampe and McCann

1985).

Toxic parts:

flowers
leaves
mature fruit

References:

Cooper, M. R., Johnson, A. W. 1984. Poisonous plants in Britain and their effects on animals and man. Her Majesty's Stationery Office, London, England. 305 pp.

Hardin, J. W., Arena, J. M. 1969. Human poisoning from native and cultivated plants. Duke University Press, Durham, N.C., USA. 167 pp.

Lampe, K. F., McCann, M. A. 1985. AMA Handbook of poisonous and injurious plants. American Medical Assoc. Chicago, Ill., USA. 432 pp.

Reynard, G. B., Norton, J. B. 1942. Poisonous plants of Maryland in relation to livestock. Univ. MD. Agric. Exp. Stn. Bull., A10. 312 pp.

Notes on Toxic plant chemicals:

Aesculin is a saponin (7-hydroxycoumarin 6-glucoside) that yields aesculetin (6,7-dihydroxycoumarin) upon hydrolysis. Aesculin is related to hydrocoumarin found in spoiled sweet-clover hay (Cooper and Johnson 1984). LD-50 measurements from nut extracts were as follows (Williams and Olsen 1984):

10.6 mg/g of body weight for chicks
10.7 mg/g of body weight for hamsters.

Toxic plant chemicals:

aesculin

References:

Cooper, M. R., Johnson, A. W. 1984. Poisonous plants in Britain and their effects on animals and man. Her Majesty's Stationery Office, London, England. 305 pp.

Reynard, G. B., Norton, J. B. 1942. Poisonous plants of Maryland in relation to livestock. Univ. MD. Agric. Exp. Stn. Bull., A10. 312 pp.

Williams, M. C., Olsen, J. D. 1984. Toxicity of seeds of three *Aesculus* spp to chicks and hamsters. *Am. J. Vet. Res.*, 45: 539-542.

Animals/Human Poisoning:

Note: When an animal is listed without additional information, the literature (as of 1993) contained no detailed explanation.

Cattle

Humans

General symptoms of poisoning:

[death](#)

[depression](#)

[diarrhea](#)

[gastroenteritis](#)

[muscle twitching](#)

[paralysis](#)

[pupil dilation](#)

[restlessness](#)

[unconsciousness](#)

[vomiting](#)

[weakness](#)

References:

Cooper, M. R., Johnson, A. W. 1984. Poisonous plants in Britain and their effects on animals and man. Her Majesty's Stationery Office, London, England. 305 pp.

Hardin, J. W., Arena, J. M. 1969. Human poisoning from native and cultivated plants. Duke University Press, Durham, N.C., USA. 167 pp.

Lampe, K. F., McCann, M. A. 1985. AMA Handbook of poisonous and injurious plants. American Medical Assoc. Chicago, Ill., USA. 432 pp.

[Another search?](#)

[Français](#) | [Contact Us](#) | [Help](#) | [Search](#) | [Canada site](#)

[Coming Events](#) | [About CBIF](#) | [Links](#) | [Reports and Publications](#) |

[Home](#)

Date modified: 2003-02-06

[Important Notices](#)



Français	Contact us	Help	Search	Canada site
Coming events	About CBIF	Links	Reports and publications	Home

Canadian Biodiversity Information Facility



Notes on poisoning: *Agrostemma githago*

[Introduction](#)[Interactive](#)[All poisonous plants by Botanical name](#)[All poisonous plants by Common name](#)[Important WWW Poisonous Plants sites](#)

General poisoning notes:

Purple cockle (*Agrostemma githago*) is a naturalized herb found across southern Canada. The seeds are contaminants of wheat seeds and they are considered to be poisonous to poultry, cattle, and humans. Human poisoning is rare. Feeding trials have been conducted with ground seeds, which are unappetizing to poultry (Quigley and Waite 1931).

References:

Hardin, J. W., Arena, J. M. 1969. Human poisoning from native and cultivated plants. Duke University Press, Durham, N.C., USA. 167 pp.

Heuser, G. F., Shumacher, A. E. 1942. The feeding of corn cockle to chickens. Poultr. Sci., 21:86-93.

Quigley, G. D., Waite, R. H. 1931. Miscellaneous feeding trials with poultry. Univ. MD. Agric. Exp. Stn. Bull., 325: 343-354.

Nomenclature:

Scientific Name: *Agrostemma githago* L.

Vernacular name(s): purple cockle

Scientific family name: *Caryophyllaceae*

Vernacular family name: pink

Go to ITIS^{*ca} for more taxonomic information on: [Agrostemma githago](#)

References:

Agriculture Quebec. 1975. Noms des maladies des plantes du

Canada/ Names of plant diseases in Canada. , Quebec City, Que., Canada. 288 pp.

Alex, J. F., Cayouette, R., Mulligan, G. A. 1980. Common and botanical names of weeds in Canada/Noms populaire et scientifiques des plantes nuisibles du Canada. Revised. Agric. Can. Publ., Ottawa, Ont., Canada. 132 pp.

Bailey, L. H., Bailey, E. Z. 1976. Hortus third. Revised. MacMillan, New York, N.Y., USA. 1290 pp.

Scoggan, H. J. 1978, 1979. The flora of Canada. Nat. Mus. Nat. Sci. (Ottawa) Publ. Bot. 7(1)-7(4). 1711 pp.

Van Wijk, H. L. 1911. A dictionary of plant names. Martinus Nijhoff, The Hague, The Netherlands. 1444 pp.

Victorin, M. 1964. Flore Laurentienne. 2nd ed. Univ. Montreal, Montreal, Que., Canada. 952 pp.

Geographic Information

Alberta
British Columbia
Manitoba
New Brunswick
Nova Scotia
Ontario
Prince Edward Island
Quebec
Saskatchewan

References:

Bailey, L. H., Bailey, E. Z. 1976. Hortus third. Revised. MacMillan, New York, N.Y., USA. 1290 pp.

Boivin, B. 1966, 1967. Énumération des plantes du Canada. Provencheria 6. Nat. Can. (Que.) 93: 253-274; 371-437; 583-646; 989-1063. 94: 131-157; 471-528; 625-655.

Image or illustration

Agrostemma githago:

Images: images.google.com

Toxic parts:

seeds

References:

Heuser, G. F., Shumacher, A. E. 1942. The feeding of corn cockle to chickens. *Poult. Sci.*, 21:86-93.

Quigley, G. D., Waite, R. H. 1931. Miscellaneous feeding trials with poultry. *Univ. MD. Agric. Exp. Stn. Bull.*, 325: 343-354.

Notes on Toxic plant chemicals:

Purple cockle (*Agrostemma githago*) contains the saponin githagin, which is toxic mainly to poultry. The toxin is destroyed in seeds at 50 C. The following quantities have been found to be toxic in experiments with animals:

calf 0.0025% of body weight
poultry 0.0025%
pig 0.0010%
dog 0.0009%

Most feeding experiments have been conducted on chickens (Quigley and Waite 1931; Heuser and Schumacher 1942).

Toxic plant chemicals:

githagin

References:

Heuser, G. F., Shumacher, A. E. 1942. The feeding of corn cockle to chickens. *Poult. Sci.*, 21:86-93.

Animals/Human Poisoning:

Note: When an animal is listed without additional information, the literature (as of 1993) contained no detailed explanation.

Humans

General symptoms of poisoning:

[breathing, shallow](#)

[diarrhea](#)

[dizziness](#)

[stomach cramps](#)

[vomiting](#)

[weakness](#)

Notes on poisoning:

Purple cockle (*Agrostemma githago*) seeds can contaminate wheat because the seeds are difficult to screen. Highly contaminated wheat is unsalable. The seeds are a danger if present in home-ground wheat, corn, or oats (Hardin and Arena 1969).

References:

Hardin, J. W., Arena, J. M. 1969. Human poisoning from native and cultivated plants. Duke University Press, Durham, N.C., USA. 167 pp.

Poultry

General symptoms of poisoning:

[appetite, loss of](#)
[breathing, labored](#)
[death](#)
[diarrhea](#)
[gait, staggering](#)
[heart, cheesy material](#)
[mouth, cheesy material](#)

References:

Heuser, G. F., Shumacher, A. E. 1942. The feeding of corn cockle to chickens. *Poult. Sci.*, 21:86-93.

Quigley, G. D., Waite, R. H. 1931. Miscellaneous feeding trials with poultry. *Univ. MD. Agric. Exp. Stn. Bull.*, 325: 343-354.

[Another search?](#)

[Français](#) | [Contact Us](#) | [Help](#) | [Search](#) | [Canada site](#)

[Coming Events](#) | [About CBIF](#) | [Links](#) | [Reports and Publications](#) | [Home](#)

Date modified: 2003-02-06

[Important Notices](#)



Français	Contact us	Help	Search	Canada site
Coming events	About CBIF	Links	Reports and publications	Home

Canadian Biodiversity Information Facility



Notes on poisoning: *Ailanthus altissima*

[Introduction](#)[Interactive](#)[All poisonous plants by Botanical name](#)[All poisonous plants by Common name](#)[Important WWW Poisonous Plants sites](#)

General poisoning notes:

Tree-of-heaven (*Ailanthus altissima*) is an ornamental found in the warmest parts of Canada. Exposure to the leaves may have caused dermatitis in humans and it is suspected of being a poisonous plant as well. However, convincing documentation of poisoning is lacking. The tree has been suspected of causing gastroenteritis. (Muenscher 1975, Mitchell and Rook 1979).

References:

Mitchell, J. C., Rook, A. 1979. Botanical dermatology. Greenglass Ltd, Vancouver, B.C., Canada. 787 pp.

Muenscher, W. C. 1975. Poisonous plants of the United States. Revised. Collier Books, New York, N.Y., USA. 277 pp.

Perkins, K. D., Payne, W. W. 1978. Guide to the poisonous and irritant plants of Florida. Univ. Fla. Agric. Ext. Serv. Circ., 441. 84 pp.

Nomenclature:

Scientific Name: *Ailanthus altissima* (Mill.) Swingle

Vernacular name(s): tree-of-heaven

Scientific family name: *Simaroubaceae*

Vernacular family name: ginkgo

Go to ITIS^{*ca} for more taxonomic information on: [Ailanthus altissima](#)

Vernacular name(s): tree-of-heaven

Scientific family name: *Simaroubaceae*

Vernacular family name: quassia

Go to ITIS^{*ca} for more taxonomic information on: [Ailanthus altissima](#)

References:

Agriculture Quebec. 1975. Noms des maladies des plantes du Canada/ Names of plant diseases in Canada. , Quebec City, Que., Canada. 288 pp.

Alex, J. F., Cayouette, R., Mulligan, G. A. 1980. Common and botanical names of weeds in Canada/Noms populaire et scientifiques des plantes nuisibles du Canada. Revised. Agric. Can. Publ., Ottawa, Ont., Canada. 132 pp.

Bailey, L. H., Bailey, E. Z. 1976. Hortus third. Revised. MacMillan, New York, N.Y., USA. 1290 pp.

Scoggan, H. J. 1978, 1979. The flora of Canada. Nat. Mus. Nat. Sci. (Ottawa) Publ. Bot. 7(1)-7(4). 1711 pp.

Van Wijk, H. L. 1911. A dictionary of plant names. Martinus Nijhoff, The Hague, The Netherlands. 1444 pp.

Victorin, M. 1964. Flore Laurentienne. 2nd ed. Univ. Montreal, Montreal, Que., Canada. 952 pp.

Geographic Information

Plant or plant parts used in or around the home.

References:

Bailey, L. H., Bailey, E. Z. 1976. Hortus third. Revised. MacMillan, New York, N.Y., USA. 1290 pp.

Boivin, B. 1966, 1967. Énumération des plantes du Canada. Provencheria 6. Nat. Can. (Que.) 93: 253-274; 371-437; 583-646; 989-1063. 94: 131-157; 471-528; 625-655.

Image or illustration

Ailanthus altissima:

Images: images.google.com

Toxic parts:

flowers

leaves

References:

Muenscher, W. C. 1975. Poisonous plants of the United States. Revised. Collier Books, New York, N.Y., USA. 277 pp.

Animals/Human Poisoning:

Note: When an animal is listed without additional information, the literature (as of 1993) contained no detailed explanation.

Humans

General symptoms of poisoning:

[erythema](#)

References:

Mitchell, J. C., Rook, A. 1979. Botanical dermatology. Greenglass Ltd, Vancouver, B.C., Canada. 787 pp.

[Another search?](#)

[Français](#) | [Contact Us](#) | [Help](#) | [Search](#) | [Canada site](#)

[Coming Events](#) | [About CBIF](#) | [Links](#) | [Reports and Publications](#) |

[Home](#)

Date modified: 2003-02-06

[Important Notices](#)



Français	Contact us	Help	Search	Canada site
Coming events	About CBIF	Links	Reports and publications	Home

Canadian Biodiversity Information Facility



Notes on poisoning: *Allamanda cathartica*

[Introduction](#)[Interactive](#)[All poisonous plants by Botanical name](#)[All poisonous plants by Common name](#)[Important WWW Poisonous Plants sites](#)

General poisoning notes:

Golden-trumpet (*Allamanda cathartica*) is an indoor ornamental vine that is suited to greenhouses. It is considered poisonous, but firm evidence is lacking. The plant was once used as a cathartic. Ingesting the fruits may cause upset stomach (Kingsbury 1964; Hardin and Arena 1969).



There is a case of a young boy who was sucking the end of the stem of this plant. He subsequently became nauseated, and developed a high temperature and swollen lips. Some individuals develop a rash from the plant sap (Morton 1962).

References:

Hardin, J. W., Arena, J. M. 1969. Human poisoning from native and cultivated plants. Duke University Press, Durham, N.C., USA. 167 pp.

Kingsbury, J. M. 1964. Poisonous plants of the United States and Canada. Prentice-Hall Inc., Englewood Cliffs, N.J., USA. 626 pp.

Morton, J. F. 1962. Ornamental plants with toxic and or irritant properties. II. Proc. Fla. State Hortic. Soc., 75: 484-491.

Nomenclature:

Scientific Name: *Allamanda cathartica* L.

Vernacular name(s): golden-trumpet

Scientific family name: *Apocynaceae*

Vernacular family name: dogbane

Go to ITIS^{*ca} for more taxonomic information on: [Allamanda cathartica](#)

References:

Agriculture Quebec. 1975. Noms des maladies des plantes du Canada/ Names of plant diseases in Canada. , Quebec City, Que., Canada. 288 pp.

Alex, J. F., Cayouette, R., Mulligan, G. A. 1980. Common and botanical names of weeds in Canada/Noms populaire et scientifiques des plantes nuisibles du Canada. Revised. Agric. Can. Publ., Ottawa, Ont., Canada. 132 pp.

Bailey, L. H., Bailey, E. Z. 1976. Hortus third. Revised. MacMillan, New York, N.Y., USA. 1290 pp.

Scoggan, H. J. 1978, 1979. The flora of Canada. Nat. Mus. Nat. Sci. (Ottawa) Publ. Bot. 7(1)-7(4). 1711 pp.

Van Wijk, H. L. 1911. A dictionary of plant names. Martinus Nijhoff, The Hague, The Netherlands. 1444 pp.

Victorin, M. 1964. Flore Laurentienne. 2nd ed. Univ. Montreal, Montreal, Que., Canada. 952 pp.

Geographic Information

Plant or plant parts used in or around the home.

References:

Bailey, L. H., Bailey, E. Z. 1976. Hortus third. Revised. MacMillan, New York, N.Y., USA. 1290 pp.

Boivin, B. 1966, 1967. Énumération des plantes du Canada. Provencheria 6. Nat. Can. (Que.) 93: 253-274; 371-437; 583-646; 989-1063. 94: 131-157; 471-528; 625-655.

Image or illustration

Allamanda cathartica:

Images: images.google.com

Notes on Poisonous plant parts:

This plant has an unidentified toxin in the fruits and in the cell sap of the stem and leaves (Hardin and Arena 1969). The plant is used only as an indoor ornamental in Canada, most likely found in greenhouses because it is a large climbing vine.

Toxic parts:

mature fruit
plant juices

References:

Hardin, J. W., Arena, J. M. 1969. Human poisoning from native and cultivated plants. Duke University Press, Durham, N.C., USA. 167 pp.

Kingsbury, J. M. 1964. Poisonous plants of the United States and Canada. Prentice-Hall Inc., Englewood Cliffs, N.J., USA. 626 pp.

Animals/Human Poisoning:

Note: When an animal is listed without additional information, the literature (as of 1993) contained no detailed explanation.

Humans

General symptoms of poisoning:

[nausea](#)

[stomach cramps](#)

[temperature, elevated](#)

[thirsty](#)

References:

Hardin, J. W., Arena, J. M. 1969. Human poisoning from native and cultivated plants. Duke University Press, Durham, N.C., USA. 167 pp.

Morton, J. F. 1962. Ornamental plants with toxic and or irritant properties. II. Proc. Fla. State Hortic. Soc., 75: 484-491.

[Another search?](#)

[Français](#) | [Contact Us](#) | [Help](#) | [Search](#) | [Canada site](#)

[Coming Events](#) | [About CBIF](#) | [Links](#) | [Reports and Publications](#) |

[Home](#)

Date modified: 2003-02-06

[Important Notices](#)



Français	Contact us	Help	Search	Canada site
Coming events	About CBIF	Links	Reports and publications	Home

Canadian Biodiversity Information Facility



Notes on poisoning: *Allium canadense*

[Introduction](#)

[Interactive](#)

[All poisonous plants by Botanical name](#)

[All poisonous plants by Common name](#)

[Important WWW Poisonous Plants sites](#)



General poisoning notes:

Wild onion (*Allium canadense*) is a native herb found in parts of eastern Canada. This plant can cause gastroenteritis in young children who ingest parts of this plant. Chronic ingestion of the bulbs reduces iodine uptake by the thyroid gland, which can lead to problems. No specific treatment is suggested other than to prevent dehydration (Lampe and McCann 1985). Livestock have also been poisoned by ingesting wild onions, and some have died (Pipal 1918). Horses have developed hemolytic anemia from ingesting wild onion leaves (Scoggan 1989).

References:

Lampe, K. F., McCann, M. A. 1985. AMA Handbook of poisonous and injurious plants. American Medical Assoc. Chicago, Ill., USA. 432 pp.

Pipal, F. J. 1918. A suspected case of stock poisoning by wild onion (*Allium canadense*). Proc. Indiana Acad. Sci., 1917: 139.

Nomenclature:

Scientific Name: *Allium canadense* L.

Vernacular name(s): wild onion

Scientific family name: *Liliaceae*

Vernacular family name: lily

Go to ITIS^{*ca} for more taxonomic information on: [Allium canadense](#)

References:

Agriculture Quebec. 1975. Noms des maladies des plantes du

Canada/ Names of plant diseases in Canada. , Quebec City, Que., Canada. 288 pp.

Alex, J. F., Cayouette, R., Mulligan, G. A. 1980. Common and botanical names of weeds in Canada/Noms populaire et scientifiques des plantes nuisibles du Canada. Revised. Agric. Can. Publ., Ottawa, Ont., Canada. 132 pp.

Bailey, L. H., Bailey, E. Z. 1976. Hortus third. Revised. MacMillan, New York, N.Y., USA. 1290 pp.

Scoggan, H. J. 1978, 1979. The flora of Canada. Nat. Mus. Nat. Sci. (Ottawa) Publ. Bot. 7(1)-7(4). 1711 pp.

Van Wijk, H. L. 1911. A dictionary of plant names. Martinus Nijhoff, The Hague, The Netherlands. 1444 pp.

Victorin, M. 1964. Flore Laurentienne. 2nd ed. Univ. Montreal, Montreal, Que., Canada. 952 pp.

Geographic Information

New Brunswick
Ontario
Quebec

References:

Bailey, L. H., Bailey, E. Z. 1976. Hortus third. Revised. MacMillan, New York, N.Y., USA. 1290 pp.

Boivin, B. 1966, 1967. Énumération des plantes du Canada. Provencheria 6. Nat. Can. (Que.) 93: 253-274; 371-437; 583-646; 989-1063. 94: 131-157; 471-528; 625-655.

Image or illustration

Allium canadense:

Images: images.google.com

Toxic parts:

bulbs
leaves

References:

Scoggan, R. D. 1989. Wild onion toxicosis and other hemolytic anemia toxins. Equine professional topics. Univ. Ill. Urbana-Champaign Ext., 14(1): 1-2.

Notes on Toxic plant chemicals:

The three onion species (*Allium* spp.) mentioned in this information system contain S-methyl-L-cysteine sulfoxide (SMCO), which is a sulfur-containing alpha-amino acid. The empirical formula is C₄-H₉-O₃-NS. The common garden onion (*A. cepa*) contains the following:

- 100 mg/kg wet weight of SMCO in the leaves,
- 1600 mg/kg wet weight of SMCO in the bulbs (Benevenga et al. 1989)

Toxic plant chemicals:

S-methyl-L-cysteine sulfoxide (SMCO)

References:

Benevenga, N. J., Case, G. L., Steele, R. D. 1989. Occurrence and metabolism of s-methyl-l-cysteine and s-methyl-l-cysteine sulfoxide in plants and their toxicity and metabolism in animals. Pages 203-228 in Cheeke, P. R., ed. Toxicants of plant origin. Vol. III. Proteins and amino acids. CRC Press, Inc., Boca Raton, Fla., USA. 271 pp.

Animals/Human Poisoning:

Note: When an animal is listed without additional information, the literature (as of 1993) contained no detailed explanation.

Cattle

General symptoms of poisoning:

[breathing, rapid](#)

[death](#)

[gastroenteritis](#)

[heart rate, elevated](#)

[Heinz bodies](#)

[recumbency](#)

[weakness](#)

References:

Pipal, F. J. 1918. A suspected case of stock poisoning by wild onion (*Allium canadense*). Proc. Indiana Acad. Sci., 1917: 139.

Horses

Humans

[Another search?](#)

[Français](#) | [Contact Us](#) | [Help](#) | [Search](#) | [Canada site](#)

[Coming Events](#) | [About CBIF](#) | [Links](#) | [Reports and Publications](#) |

[Home](#)

Date modified: 2003-02-06

[Important Notices](#)



Français	Contact us	Help	Search	Canada site
Coming events	About CBIF	Links	Reports and publications	Home

Canadian Biodiversity Information Facility



Notes on poisoning: *Allium cepa*

[Introduction](#)[Interactive](#)[All poisonous plants by Botanical name](#)[All poisonous plants by Common name](#)[Important WWW Poisonous Plants sites](#)

General poisoning notes:

Cultivated onion (*Allium cepa*) has caused hemolytic anemia in livestock including cattle, horses, and experimentally in sheep. Death can occur in severe cases. The formation of Heinz bodies in the red blood cells is a common occurrence. Heinz bodies consist of a precipitate, denatured hemoglobin caused by oxidant attack (Hutchinson 1977).

References:

Hutchinson, T. W. 1977. Onions as a cause of Heinz body anaemia and death in cattle. *Can. Vet. J.*, 18: 358-360.

Kirk, J. H., Bulgin, M. S. 1979. Effects of feeding cull domestic onions (*Allium cepa*) to sheep. *Am. J. Vet. Res.*, 40: 397-399.

Thorp, F., Harshfield, G. S. 1939. Onion poisoning in horses. *J. Am. Vet. Med. Assoc.*, 94: 52-53.

Nomenclature:

Scientific Name: *Allium cepa* L.

Vernacular name(s): onion

Scientific family name: *Liliaceae*

Vernacular family name: lily

Go to ITIS*^{ca} for more taxonomic information on: [Allium cepa](#)

References:

Agriculture Quebec. 1975. Noms des maladies des plantes du Canada/ Names of plant diseases in Canada. , Quebec City, Que., Canada. 288 pp.

Alex, J. F., Cayouette, R., Mulligan, G. A. 1980. Common and botanical names of weeds in Canada/Noms populaire et scientifiques des plantes nuisibles du Canada. Revised. Agric. Can. Publ., Ottawa, Ont., Canada. 132 pp.

Bailey, L. H., Bailey, E. Z. 1976. Hortus third. Revised. MacMillan, New York, N.Y., USA. 1290 pp.

Scoggan, H. J. 1978, 1979. The flora of Canada. Nat. Mus. Nat. Sci. (Ottawa) Publ. Bot. 7(1)-7(4). 1711 pp.

Van Wijk, H. L. 1911. A dictionary of plant names. Martinus Nijhoff, The Hague, The Netherlands. 1444 pp.

Victorin, M. 1964. Flore Laurentienne. 2nd ed. Univ. Montreal, Montreal, Que., Canada. 952 pp.

Geographic Information

Plant or plant parts used in or around the home.

References:

Bailey, L. H., Bailey, E. Z. 1976. Hortus third. Revised. MacMillan, New York, N.Y., USA. 1290 pp.

Boivin, B. 1966, 1967. Énumération des plantes du Canada. Provencheria 6. Nat. Can. (Que.) 93: 253-274; 371-437; 583-646; 989-1063. 94: 131-157; 471-528; 625-655.

Image or illustration

Allium cepa:

Images: images.google.com

Toxic parts:

bulbs
leaves

References:

Hutchinson, T. W. 1977. Onions as a cause of Heinz body anaemia and death in cattle. Can. Vet. J., 18: 358-360.

Kirk, J. H., Bulgin, M. S. 1979. Effects of feeding cull domestic onions (*Allium cepa*) to sheep. Am. J. Vet. Res., 40: 397-399.

Thorp, F., Harshfield, G. S. 1939. Onion poisoning in horses. J. Am. Vet. Med. Assoc., 94: 52-53.

Notes on Toxic plant chemicals:

Onions (*Allium* spp.) contain various toxins that can cause problems. N-propyl disulphide, an alkaloid, has been implicated as the toxic chemical (Hutchinson 1977). More recent studies have shown that S-methyl-L-cysteine sulfoxide (SMCO) is involved in forming Heinz bodies and hemolytic anemia. This chemical is less toxic in nonruminant animals (Benevenga et al. 1989).

(Note: calcium oxalate crystals have been found in the dry outer skin or scale leaves of this plant (Sarma and Terpó 1980)). Garlic (*Allium sativum*) is a cultivated plant grown for its bulbs.

Toxic plant chemicals:

N-propyl disulphide

oxalate

S-methyl-L-cysteine sulfoxide (SMCO)

References:

Benevenga, N. J., Case, G. L., Steele, R. D. 1989. Occurrence and metabolism of s-methyl-l-cysteine and s-methyl-l-cysteine sulfoxide in plants and their toxicity and metabolism in animals. Pages 203-228 in Cheeke, P. R., ed. Toxicants of plant origin. Vol. III. Proteins and amino acids. CRC Press, Inc., Boca Raton, Fla., USA. 271 pp.

Hutchinson, T. W. 1977. Onions as a cause of Heinz body anaemia and death in cattle. *Can. Vet. J.*, 18: 358-360.

Kirk, J. H., Bulgin, M. S. 1979. Effects of feeding cull domestic onions (*Allium cepa*) to sheep. *Am. J. Vet. Res.*, 40: 397-399.

Sarma, S. K., Terpó, A. 1980. The occurrence of different types of calcium oxalate crystals in *Allium cepa* L. and *Allium fistulosum* L. and their importance in taxonomy. *Acta Agron. Acad. Sci. Hung.*, 29: 25-37.

Animals/Human Poisoning:

Note: When an animal is listed without additional information, the literature (as of 1993) contained no detailed explanation.

Cattle

General symptoms of poisoning:

[death](#)

[Heinz bodies](#)

References:

Hutchinson, T. W. 1977. Onions as a cause of Heinz body anaemia and death in cattle. *Can. Vet. J.*, 18: 358-360.

Horses

General symptoms of poisoning:

[anemia](#)

[breath, onion odor of](#)

[breathing, rapid](#)

[death](#)

[icterus](#)

[weight loss](#)

References:

Thorp, F., Harshfield, G. S. 1939. Onion poisoning in horses. *J. Am. Vet. Med. Assoc.*, 94: 52-53.

Sheep

General symptoms of poisoning:

[anemia](#)

References:

Kirk, J. H., Bulgin, M. S. 1979. Effects of feeding cull domestic onions (*Allium cepa*) to sheep. *Am. J. Vet. Res.*, 40: 397-399.

[Another search?](#)

[Français](#) | [Contact Us](#) | [Help](#) | [Search](#) | [Canada site](#)

[Coming Events](#) | [About CBIF](#) | [Links](#) | [Reports and Publications](#) | [Home](#)

Date modified: 2003-02-06

[Important Notices](#)



Français	Contact us	Help	Search	Canada site
Coming events	About CBIF	Links	Reports and publications	Home

Canadian Biodiversity Information Facility



Notes on poisoning: *Allium sativum*

[Introduction](#)[Interactive](#)[All poisonous plants by Botanical name](#)[All poisonous plants by Common name](#)[Important WWW Poisonous Plants sites](#)

General poisoning notes:

Human allergy to garlic dust has been documented by Lybarger et al. 1982. Ingesting garlic leaves can also cause allergic reactions.

References:



Lybarger, J. A., Gallagher, J. S., Pulver, D. W., Litwin, A., Brooks, S., Bernstein, I. L. 1982. Occupational asthma induced by inhalation and ingestion of garlic. *J. All. Clin. Immunol.*, 69: 448-454.

Nomenclature:

Scientific Name: *Allium sativum* L.

Vernacular name(s): garlic

Scientific family name: *Liliaceae*

Vernacular family name: lily

Go to ITIS*^{ca} for more taxonomic information on: [Allium sativum](#)

References:

Agriculture Quebec. 1975. Noms des maladies des plantes du Canada/ Names of plant diseases in Canada. , Quebec City, Que., Canada. 288 pp.

Alex, J. F., Cayouette, R., Mulligan, G. A. 1980. Common and botanical names of weeds in Canada/Noms populaire et scientifiques des plantes nuisibles du Canada. Revised. Agric. Can. Publ., Ottawa, Ont., Canada. 132 pp.

Bailey, L. H., Bailey, E. Z. 1976. Hortus third. Revised.

MacMillan, New York, N.Y., USA. 1290 pp.

Scoggan, H. J. 1978, 1979. The flora of Canada. Nat. Mus. Nat. Sci. (Ottawa) Publ. Bot. 7(1)-7(4). 1711 pp.

Van Wijk, H. L. 1911. A dictionary of plant names. Martinus Nijhoff, The Hague, The Netherlands. 1444 pp.

Victorin, M. 1964. Flore Laurentienne. 2nd ed. Univ. Montreal, Montreal, Que., Canada. 952 pp.

Geographic Information

Plant or plant parts used in or around the home.

References:

Bailey, L. H., Bailey, E. Z. 1976. Hortus third. Revised. MacMillan, New York, N.Y., USA. 1290 pp.

Boivin, B. 1966, 1967. Énumération des plantes du Canada. Provencheria 6. Nat. Can. (Que.) 93: 253-274; 371-437; 583-646; 989-1063. 94: 131-157; 471-528; 625-655.

Image or illustration

Allium sativum:

Images: images.google.com

Toxic parts:

bulb - dust of
bulbs

References:

Lybarger, J. A., Gallagher, J. S., Pulver, D. W., Litwin, A., Brooks, S., Bernstein, I. L. 1982. Occupational asthma induced by inhalation and ingestion of garlic. J. All. Clin. Immunol., 69: 448-454.

Toxic plant chemicals:

S-methyl-L-cysteine sulfoxide (SMCO)

References:

Benevenga, N. J., Case, G. L., Steele, R. D. 1989. Occurrence and metabolism of s-methyl-l-cysteine and s-methyl-l-cysteine

sulfoxide in plants and their toxicity and metabolism in animals. Pages 203-228 in Cheeke, P. R., ed. Toxicants of plant origin. Vol. III. Proteins and amino acids. CRC Press, Inc., Boca Raton, Fla., USA. 271 pp.

Animals/Human Poisoning:

Note: When an animal is listed without additional information, the literature (as of 1993) contained no detailed explanation.

Humans

General symptoms of poisoning:

[dyspnea](#)

[wheezing](#)

References:

Lybarger, J. A., Gallagher, J. S., Pulver, D. W., Litwin, A., Brooks, S., Bernstein, I. L. 1982. Occupational asthma induced by inhalation and ingestion of garlic. J. All. Clin. Immunol., 69: 448-454.

[Another search?](#)

[Français](#) | [Contact Us](#) | [Help](#) | [Search](#) | [Canada site](#)

[Coming Events](#) | [About CBIF](#) | [Links](#) | [Reports and Publications](#) | [Home](#)

Date modified: 2003-02-06

[Important Notices](#)



Français	Contact us	Help	Search	Canada site
Coming events	About CBIF	Links	Reports and publications	Home

Canadian Biodiversity Information Facility



Notes on poisoning: *Allium schoenoprasum*

[Introduction](#)[Interactive](#)[All poisonous plants by Botanical name](#)[All poisonous plants by Common name](#)[Important WWW Poisonous Plants sites](#)

General poisoning notes:

Horses have been poisoned in Japan by ingesting the leaves of chive (*Allium schoenoprasum*) in early spring. Chives have escaped cultivation and have been naturalized in various parts of Canada, but the plants are not abundant.

References:

Kobayashi, T. 1950. Studies on the histo-pathologic changes of experimental cases of the "Ezonegi-poisoning" in horses. Jpn. J. Vet. Sci., 12: 209.

Nomenclature:

Scientific Name: *Allium schoenoprasum* L.

Vernacular name(s): chives

Scientific family name: *Liliaceae*

Vernacular family name: lily

Go to ITIS*^{ca} for more taxonomic information on: [Allium schoenoprasum](#)

References:

Agriculture Quebec. 1975. Noms des maladies des plantes du Canada/ Names of plant diseases in Canada. , Quebec City, Que., Canada. 288 pp.

Alex, J. F., Cayouette, R., Mulligan, G. A. 1980. Common and botanical names of weeds in Canada/Noms populaire et scientifiques des plantes nuisibles du Canada. Revised. Agric. Can. Publ., Ottawa, Ont., Canada. 132 pp.

Bailey, L. H., Bailey, E. Z. 1976. Hortus third. Revised. MacMillan, New York, N.Y., USA. 1290 pp.

Scoggan, H. J. 1978, 1979. The flora of Canada. Nat. Mus. Nat. Sci. (Ottawa) Publ. Bot. 7(1)-7(4). 1711 pp.

Van Wijk, H. L. 1911. A dictionary of plant names. Martinus Nijhoff, The Hague, The Netherlands. 1444 pp.

Victorin, M. 1964. Flore Laurentienne. 2nd ed. Univ. Montreal, Montreal, Que., Canada. 952 pp.

Geographic Information

Alberta
British Columbia
Labrador
New Brunswick
Newfoundland
Northwest Territories
Nova Scotia
Ontario
Quebec
Saskatchewan
Yukon Territory

References:

Bailey, L. H., Bailey, E. Z. 1976. Hortus third. Revised. MacMillan, New York, N.Y., USA. 1290 pp.

Boivin, B. 1966, 1967. Énumération des plantes du Canada. Provencheria 6. Nat. Can. (Que.) 93: 253-274; 371-437; 583-646; 989-1063. 94: 131-157; 471-528; 625-655.

Image or illustration

Allium schoenoprasum:

Images: images.google.com

Toxic parts:

leaves

References:

Kobayashi, T. 1950. Studies on the histo-pathologic changes of experimental cases of the "Ezonegi-poisoning" in horses. Jpn. J. Vet. Sci., 12: 209.

Animals/Human Poisoning:

Note: When an animal is listed without additional information, the literature (as of 1993) contained no detailed explanation.

Horses

General symptoms of poisoning:

[hemoglobinuria](#)

[icterus](#)

References:

Kobayashi, T. 1950. Studies on the histo-pathologic changes of experimental cases of the "Ezonegi-poisoning" in horses. Jpn. J. Vet. Sci., 12: 209.

[Another search?](#)

[Français](#) | [Contact Us](#) | [Help](#) | [Search](#) | [Canada site](#)

[Coming Events](#) | [About CBIF](#) | [Links](#) | [Reports and Publications](#) |

[Home](#)

Date modified: 2003-02-06

[Important Notices](#)



Français	Contact us	Help	Search	Canada site
Coming events	About CBIF	Links	Reports and publications	Home

Canadian Biodiversity Information Facility



Notes on poisoning: *Aloe arborescens*

[Introduction](#)

[Interactive](#)

[All poisonous plants by Botanical name](#)

[All poisonous plants by Common name](#)

[Important WWW Poisonous Plants sites](#)

General poisoning notes:

Aloe (*Aloe* spp.) extracts are used in many cosmetic and medicinal compounds. Unfortunately, some humans develop allergic contact dermatitis from this plant. Ingesting the plant latex can cause a cathartic action. Excessive doses may cause nephritis (Shoji 1982 Lampe and McCann 1985).



References:

Shoji, A. 1982. Contact dermatitis to *Aloe arborescens*. Contact Dermatitis, 8: 164-167.

Nomenclature:

Scientific Name: *Aloe arborescens* Mill.

Vernacular name(s): candalabra aloe

Scientific family name: *Liliaceae*

Vernacular family name: lily

Go to ITIS^{*ca} for more taxonomic information on: [Aloe arborescens](#)

References:

Agriculture Quebec. 1975. Noms des maladies des plantes du Canada/ Names of plant diseases in Canada. , Quebec City, Que., Canada. 288 pp.

Alex, J. F., Cayouette, R., Mulligan, G. A. 1980. Common and botanical names of weeds in Canada/Noms populaire et scientifiques des plantes nuisibles du Canada. Revised. Agric. Can. Publ., Ottawa, Ont., Canada. 132 pp.

Bailey, L. H., Bailey, E. Z. 1976. Hortus third. Revised. MacMillan, New York, N.Y., USA. 1290 pp.

Scoggan, H. J. 1978, 1979. The flora of Canada. Nat. Mus. Nat. Sci. (Ottawa) Publ. Bot. 7(1)-7(4). 1711 pp.

Van Wijk, H. L. 1911. A dictionary of plant names. Martinus Nijhoff, The Hague, The Netherlands. 1444 pp.

Victorin, M. 1964. Flore Laurentienne. 2nd ed. Univ. Montreal, Montreal, Que., Canada. 952 pp.

Geographic Information

Plant or plant parts used in or around the home.

References:

Bailey, L. H., Bailey, E. Z. 1976. Hortus third. Revised. MacMillan, New York, N.Y., USA. 1290 pp.

Boivin, B. 1966, 1967. Énumération des plantes du Canada. Provencheria 6. Nat. Can. (Que.) 93: 253-274; 371-437; 583-646; 989-1063. 94: 131-157; 471-528; 625-655.

Image or illustration

Aloe arborescens:

Images: images.google.com

Toxic parts:

plant juices

References:

Nakamura, T., Kotajima, S. 1984. Contact dermatitis from *Aloe arborescens*. Contact Dermatitis, 11: 51.

Shoji, A. 1982. Contact dermatitis to *Aloe arborescens*. Contact Dermatitis, 8: 164-167.

Animals/Human Poisoning:

Note: When an animal is listed without additional information, the literature (as of 1993) contained no detailed explanation.

Humans

General symptoms of poisoning:

[eczema](#)

[erythema](#)

References:

Shoji, A. 1982. Contact dermatitis to *Aloe arborescens*. Contact Dermatitis, 8: 164-167.

[Another search?](#)

[Français](#) | [Contact Us](#) | [Help](#) | [Search](#) | [Canada site](#)

[Coming Events](#) | [About CBIF](#) | [Links](#) | [Reports and Publications](#) |

[Home](#)

Date modified: 2003-02-06

[Important Notices](#)



Français	Contact us	Help	Search	Canada site
Coming events	About CBIF	Links	Reports and publications	Home

Canadian Biodiversity Information Facility



Notes on poisoning: *Aloe barbadensis*

[Introduction](#)

[Interactive](#)

[All poisonous plants by Botanical name](#)

[All poisonous plants by Common name](#)

[Important WWW Poisonous Plants sites](#)



General poisoning notes:

Aloe (Aloe barbadensis) is the common "Aloe vera" found in extracts that are used in cosmetics and medicinal products. The latex from under the skin can cause a cathartic action because it irritates the large intestine; anthraquinones color alkaline urine red. An excessive dose may cause nephritis (Lampe and McCann 1985). Contact dermatitis can also result from contact with this plant.

References:

Lampe, K. F., McCann, M. A. 1985. AMA Handbook of poisonous and injurious plants. American Medical Assoc. Chicago, Ill., USA. 432 pp.

Schenkel, B., Vorherr, H. 1974. Non-prescription drugs during pregnancy: potential teratogenic and toxic effects upon embryo and fetus. J. Reprod. Med., 12: 33.

Spoerke, D. G., Ekins, B. R. 1980. *Aloe vera* - fact or quackery. Vet. Hum. Toxicol., 22: 418-424.

Nomenclature:

Scientific Name: *Aloe barbadensis* Mill.

Vernacular name(s): aloe - *A. barbadensis*

Scientific family name: *Liliaceae*

Vernacular family name: lily

Go to ITIS^{*ca} for more taxonomic information on: [Aloe barbadensis](#)

References:

Agriculture Quebec. 1975. Noms des maladies des plantes du Canada/ Names of plant diseases in Canada. , Quebec City, Que., Canada. 288 pp.

Alex, J. F., Cayouette, R., Mulligan, G. A. 1980. Common and botanical names of weeds in Canada/Noms populaire et scientifiques des plantes nuisibles du Canada. Revised. Agric. Can. Publ., Ottawa, Ont., Canada. 132 pp.

Bailey, L. H., Bailey, E. Z. 1976. Hortus third. Revised. MacMillan, New York, N.Y., USA. 1290 pp.

Scoggan, H. J. 1978, 1979. The flora of Canada. Nat. Mus. Nat. Sci. (Ottawa) Publ. Bot. 7(1)-7(4). 1711 pp.

Van Wijk, H. L. 1911. A dictionary of plant names. Martinus Nijhoff, The Hague, The Netherlands. 1444 pp.

Victorin, M. 1964. Flore Laurentienne. 2nd ed. Univ. Montreal, Montreal, Que., Canada. 952 pp.

Geographic Information

Plant or plant parts used in or around the home.

References:

Bailey, L. H., Bailey, E. Z. 1976. Hortus third. Revised. MacMillan, New York, N.Y., USA. 1290 pp.

Boivin, B. 1966, 1967. Énumération des plantes du Canada. Provencheria 6. Nat. Can. (Que.) 93: 253-274; 371-437; 583-646; 989-1063. 94: 131-157; 471-528; 625-655.

Image or illustration

Aloe barbadensis:

Images: images.google.com

Toxic parts:

latex

References:

Schenkel, B., Vorherr, H. 1974. Non-prescription drugs during pregnancy: potential teratogenic and toxic effects upon embryo and fetus. J. Reprod. Med., 12: 33.

Spoerke, D. G., Ekins, B. R. 1980. *Aloe vera* - fact or quackery. Vet. Hum. Toxicol., 22: 418-424.

Toxic plant chemicals:

aloe-emodin

References:

Spoerke, D. G., Ekins, B. R. 1980. *Aloe vera* - fact or quackery. Vet. Hum. Toxicol., 22: 418-424.

Animals/Human Poisoning:

Note: When an animal is listed without additional information, the literature (as of 1993) contained no detailed explanation.

Humans

General symptoms of poisoning:

[catharsis](#)

[nephritis](#)

References:

Schenkel, B., Vorherr, H. 1974. Non-prescription drugs during pregnancy: potential teratogenic and toxic effects upon embryo and fetus. J. Reprod. Med., 12: 33.

Spoerke, D. G., Ekins, B. R. 1980. *Aloe vera* - fact or quackery. Vet. Hum. Toxicol., 22: 418-424.

[Another search?](#)

[Français](#) | [Contact Us](#) | [Help](#) | [Search](#) | [Canada site](#)

[Coming Events](#) | [About CBIF](#) | [Links](#) | [Reports and Publications](#) |

[Home](#)

Date modified: 2003-02-06

[Important Notices](#)



Français	Contact us	Help	Search	Canada site
Coming events	About CBIF	Links	Reports and publications	Home

Canadian Biodiversity Information Facility



Notes on poisoning: *Alstroemeria ligtu*

[Introduction](#)[Interactive](#)[All poisonous plants by Botanical name](#)[All poisonous plants by Common name](#)[Important WWW Poisonous Plants sites](#)

General poisoning notes:

Peruvian lily (*Alstroemeria ligtu*) is grown as a cut flower by the florist industry. Cut flowers are also flown into North America from Holland. This plant causes contact dermatitis to workers who may be sensitized to the chemical tuliposide A, which is also found in tulip plants. This chemical readily penetrates vinyl gloves. Nitrile gloves may prevent the allergic reaction of workers sensitive to this chemical (Marks 1988).

References:

- Marks, J. G. 1988. Allergic contact dermatitis to *Alstroemeria*. Arch. Dermatol., 124: 914-916.
- Santucci, B., Picardo, M., Iavaroni, C., Trogolo, C. 1985. Contact dermatitis to *Alstroemeria*. Contact Dermatitis, 12: 215-219.
- Spoerke, D. G., Smolinske, S. C. 1990. Toxicity of houseplants. CRC Press, Inc., Boca Raton, Fla., USA. 335 pp.

Nomenclature:

Scientific Name: *Alstroemeria ligtu* L.

Vernacular name(s): Peruvian lily

Scientific family name: *Amaryllidaceae*

Vernacular family name: amaryllis

References:

- Agriculture Quebec. 1975. Noms des maladies des plantes du Canada/ Names of plant diseases in Canada. , Quebec City, Que., Canada. 288 pp.

Alex, J. F., Cayouette, R., Mulligan, G. A. 1980. Common and botanical names of weeds in Canada/Noms populaire et scientifiques des plantes nuisibles du Canada. Revised. Agric. Can. Publ., Ottawa, Ont., Canada. 132 pp.

Bailey, L. H., Bailey, E. Z. 1976. Hortus third. Revised. MacMillan, New York, N.Y., USA. 1290 pp.

Scoggan, H. J. 1978, 1979. The flora of Canada. Nat. Mus. Nat. Sci. (Ottawa) Publ. Bot. 7(1)-7(4). 1711 pp.

Van Wijk, H. L. 1911. A dictionary of plant names. Martinus Nijhoff, The Hague, The Netherlands. 1444 pp.

Victorin, M. 1964. Flore Laurentienne. 2nd ed. Univ. Montreal, Montreal, Que., Canada. 952 pp.

Geographic Information

Plant or plant parts used in or around the home.

References:

Bailey, L. H., Bailey, E. Z. 1976. Hortus third. Revised. MacMillan, New York, N.Y., USA. 1290 pp.

Boivin, B. 1966, 1967. Énumération des plantes du Canada. Provencheria 6. Nat. Can. (Que.) 93: 253-274; 371-437; 583-646; 989-1063. 94: 131-157; 471-528; 625-655.

Image or illustration

Alstroemeria ligtu:

Images: images.google.com

Toxic parts:

plant juices

References:

Marks, J. G. 1988. Allergic contact dermatitis to *Alstroemeria*. Arch. Dermatol., 124: 914-916.

Santucci, B., Picardo, M., Iavaroni, C., Trogolo, C. 1985. Contact dermatitis to *Alstroemeria*. Contact Dermatitis, 12: 215-219.

Notes on Toxic plant chemicals:

The lactone 6-tuliposide A occurs in both the Peruvian lily and in

tulip plants. A human who becomes sensitized to one of the plants generally becomes cross-reactive to the other plant. In a series of tests, it took about 3 years for workers to become sensitive to Peruvian lily (Santucci et al. 1985).

Toxic plant chemicals:

tuliposide A
6-tuliposide A

References:

Marks, J. G. 1988. Allergic contact dermatitis to *Alstroemeria*. Arch. Dermatol., 124: 914-916.

Santucci, B., Picardo, M., Iavaroni, C., Trogolo, C. 1985. Contact dermatitis to *Alstroemeria*. Contact Dermatitis, 12: 215-219.

Spoerke, D. G., Smolinske, S. C. 1990. Toxicity of houseplants. CRC Press, Inc., Boca Raton, Fla., USA. 335 pp.

Animals/Human Poisoning:

Note: When an animal is listed without additional information, the literature (as of 1993) contained no detailed explanation.

Humans

General symptoms of poisoning:

[blistering](#)

[erythema](#)

References:

Marks, J. G. 1988. Allergic contact dermatitis to *Alstroemeria*. Arch. Dermatol., 124: 914-916.

Santucci, B., Picardo, M., Iavaroni, C., Trogolo, C. 1985. Contact dermatitis to *Alstroemeria*. Contact Dermatitis, 12: 215-219.

[Another search?](#)

[Français](#) | [Contact Us](#) | [Help](#) | [Search](#) | [Canada site](#)

[Coming Events](#) | [About CBIF](#) | [Links](#) | [Reports and Publications](#) | [Home](#)

Date modified: 2003-02-06

[Important Notices](#)



Français	Contact us	Help	Search	Canada site
Coming events	About CBIF	Links	Reports and publications	Home

Canadian Biodiversity Information Facility



Notes on poisoning: *Amaranthus blitoides*

[Introduction](#)[Interactive](#)[All poisonous plants by Botanical name](#)[All poisonous plants by Common name](#)[Important WWW Poisonous Plants sites](#)

General poisoning notes:

Prostrate pigweed (*Amaranthus blitoides*) is a naturalized herb found across parts of southern Canada. This plant accumulates nitrogen and can cause nitrate poisoning because it can accumulate amounts sufficient to kill cattle (Fuller and McClintock 1986).



References:

Fuller, T. C., McClintock, E. 1986. Poisonous plants of California. Univ. California Press, Berkeley, Calif., USA. 432 pp.

Nomenclature:

Scientific Name: *Amaranthus blitoides* S. Wats.

Vernacular name(s): prostrate pigweed

Scientific family name: *Amaranthaceae*

Vernacular family name: amaranth

Go to ITIS^{*ca} for more taxonomic information on: [Amaranthus blitoides](#)

References:

Agriculture Quebec. 1975. Noms des maladies des plantes du Canada/ Names of plant diseases in Canada. , Quebec City, Que., Canada. 288 pp.

Alex, J. F., Cayouette, R., Mulligan, G. A. 1980. Common and botanical names of weeds in Canada/Noms populaire et scientifiques des plantes nuisibles du Canada. Revised. Agric. Can. Publ., Ottawa, Ont., Canada. 132 pp.

Bailey, L. H., Bailey, E. Z. 1976. Hortus third. Revised. MacMillan, New York, N.Y., USA. 1290 pp.

Scoggan, H. J. 1978, 1979. The flora of Canada. Nat. Mus. Nat. Sci. (Ottawa) Publ. Bot. 7(1)-7(4). 1711 pp.

Van Wijk, H. L. 1911. A dictionary of plant names. Martinus Nijhoff, The Hague, The Netherlands. 1444 pp.

Victorin, M. 1964. Flore Laurentienne. 2nd ed. Univ. Montreal, Montreal, Que., Canada. 952 pp.

Geographic Information

Alberta
British Columbia
Manitoba
Ontario
Quebec
Saskatchewan

References:

Bailey, L. H., Bailey, E. Z. 1976. Hortus third. Revised. MacMillan, New York, N.Y., USA. 1290 pp.

Boivin, B. 1966, 1967. Énumération des plantes du Canada. Provencheria 6. Nat. Can. (Que.) 93: 253-274; 371-437; 583-646; 989-1063. 94: 131-157; 471-528; 625-655.

Image or illustration

Amaranthus blitoides:

Images: images.google.com

Toxic parts:

leaves

References:

Fuller, T. C., McClintock, E. 1986. Poisonous plants of California. Univ. California Press, Berkeley, Calif., USA. 432 pp.

Toxic plant chemicals:

nitrate

References:

Fuller, T. C., McClintock, E. 1986. Poisonous plants of California. Univ. California Press, Berkeley, Calif., USA. 432 pp.

Animals/Human Poisoning:

Note: When an animal is listed without additional information, the literature (as of 1993) contained no detailed explanation.

Cattle

Swine

[Another search?](#)

[Français](#) | [Contact Us](#) | [Help](#) | [Search](#) | [Canada site](#)

[Coming Events](#) | [About CBIF](#) | [Links](#) | [Reports and Publications](#) | [Home](#)

Date modified: 2003-02-06

[Important Notices](#)



Français	Contact us	Help	Search	Canada site
Coming events	About CBIF	Links	Reports and publications	Home

Canadian Biodiversity Information Facility



Notes on poisoning: *Amaranthus hybridus*

[Introduction](#)[Interactive](#)[All poisonous plants by Botanical name](#)[All poisonous plants by Common name](#)[Important WWW Poisonous Plants sites](#)

General poisoning notes:

Smooth pigweed (*Amaranthus retroflexus*) is a naturalized herb found in waste places across Canada. Ingesting this plant has caused nitrate poisoning of cattle in New Zealand. No other literature references to poisoning were found (Duckworth 1975).



References:

Duckworth, R. H. 1975. Poisoning of cattle by *Amaranthus*. N. Z. Vet. J., 23: 154-155.

Nomenclature:

Scientific Name: *Amaranthus hybridus* L.

Vernacular name(s): smooth pigweed

Scientific family name: *Amaranthaceae*

Vernacular family name: amaranth

Go to ITIS*^{ca} for more taxonomic information on: [Amaranthus hybridus](#)

References:

Agriculture Quebec. 1975. Noms des maladies des plantes du Canada/ Names of plant diseases in Canada. , Quebec City, Que., Canada. 288 pp.

Alex, J. F., Cayouette, R., Mulligan, G. A. 1980. Common and botanical names of weeds in Canada/Noms populaire et scientifiques des plantes nuisibles du Canada. Revised. Agric. Can. Publ., Ottawa, Ont., Canada. 132 pp.

Bailey, L. H., Bailey, E. Z. 1976. Hortus third. Revised.

MacMillan, New York, N.Y., USA. 1290 pp.

Scoggan, H. J. 1978, 1979. The flora of Canada. Nat. Mus. Nat. Sci. (Ottawa) Publ. Bot. 7(1)-7(4). 1711 pp.

Van Wijk, H. L. 1911. A dictionary of plant names. Martinus Nijhoff, The Hague, The Netherlands. 1444 pp.

Victorin, M. 1964. Flore Laurentienne. 2nd ed. Univ. Montreal, Montreal, Que., Canada. 952 pp.

Geographic Information

Ontario

References:

Bailey, L. H., Bailey, E. Z. 1976. Hortus third. Revised. MacMillan, New York, N.Y., USA. 1290 pp.

Boivin, B. 1966, 1967. Énumération des plantes du Canada. Provencheria 6. Nat. Can. (Que.) 93: 253-274; 371-437; 583-646; 989-1063. 94: 131-157; 471-528; 625-655.

Image or illustration

Amaranthus hybridus:

Images: images.google.com

Toxic parts:

stems

References:

Duckworth, R. H. 1975. Poisoning of cattle by *Amaranthus*. N. Z. Vet. J., 23: 154-155.

Notes on Toxic plant chemicals:

Smooth pigweed (*Amaranthus hybridus*) has caused poisoning of cattle from nitrate accumulation. All the *Amaranthus* spp. listed in this information system are nitrate accumulators. In serious cases, poisoning and death can occur (Duckworth 1975, Osweiler et al. 1985).

Toxic plant chemicals:

nitrate

References:

Duckworth, R. H. 1975. Poisoning of cattle by *Amaranthus*. N. Z. Vet. J., 23: 154-155.

Animals/Human Poisoning:

Note: When an animal is listed without additional information, the literature (as of 1993) contained no detailed explanation.

Cattle

General symptoms of poisoning:

[blood brownish](#)

[death](#)

[gait, unsteady](#)

[mucous membrane, brown](#)

[nervousness](#)

Notes on poisoning:

In one case in New Zealand, cattle were poisoned and one died as a result of suspected nitrate poisoning after ingesting smooth pigweed. The mucous membranes were brown and the blood was dark. The animals were unsteady. Postmortem findings showed the rumen to be full of the plants, but no obvious lesions were present (Duckworth 1975).

References:

Duckworth, R. H. 1975. Poisoning of cattle by *Amaranthus*. N. Z. Vet. J., 23: 154-155.

Swine

[Another search?](#)

[Français](#) | [Contact Us](#) | [Help](#) | [Search](#) | [Canada site](#)

[Coming Events](#) | [About CBIF](#) | [Links](#) | [Reports and Publications](#) |

[Home](#)

Date modified: 2003-02-06

[Important Notices](#)



Français	Contact us	Help	Search	Canada site
Coming events	About CBIF	Links	Reports and publications	Home

Canadian Biodiversity Information Facility



Notes on poisoning: *Amaranthus retroflexus*

[Introduction](#)[Interactive](#)[All poisonous plants by Botanical name](#)[All poisonous plants by Common name](#)[Important WWW Poisonous Plants sites](#)

General poisoning notes:

Redroot pigweed (*Amaranthus retroflexus*) is a naturalized herb that is found across much of Canada. This plant can cause a variety of toxic problems, including perirenal edema in pigs. However, the nature of the toxic compound is not known. This plant can also accumulate oxalates to as much as 30% of dry weight. Redroot pigweed is capable of accumulating toxic concentrations of nitrates (Osweiler et al. 1985).

References:

Crawford, R. F., Kennedy, W. K., Davison, K. L. 1966. Factors influencing the toxicity of forages that contain nitrate when fed to cattle. *Cornell Vet.*, 56: 3-17.

Duckworth, R. H. 1975. Poisoning of cattle by *Amaranthus*. *N. Z. Vet. J.*, 23: 154-155.

Hibbs, C. M., Stencel, E. L., Hill, R. M. 1978. Nitrate toxicosis in cattle. *Vet. Hum. Toxicol.*, 20: 1-2.

Osweiler, G. D., Buck, W. B., Bicknell, E. J. 1969. Production of perirenal edema in swine with *Amaranthus retroflexus*. *Am. J. Vet. Res.*, 30: 557-566.

Osweiler, G. D., Carson, T. L., Buck, W. B., Van Gelder, G. A. 1985. *Clinical and diagnostic veterinary toxicology*. Third edition. Kendall/Hunt Publishing Co., Dubuque, Iowa, USA. 494 pp.

Scimeca, J. M., Oehme, F. W. 1985. Postmortem guide to common poisonous plants of livestock. *Vet. Hum. Toxicol.*, 27: 189-199.

Stuart, B. P., Nicholson, S. S., Smith, J. B. 1975. Perirenal edema and toxic nephrosis in cattle, associated with ingestion of pigweed. *J. Am. Vet. Med. Assoc.*, 167: 949-950.

Nomenclature:

Scientific Name: *Amaranthus retroflexus* L.

Vernacular name(s): redroot pigweed

Scientific family name: *Amaranthaceae*

Vernacular family name: amaranth

Go to ITIS^{*ca} for more taxonomic information on: [Amaranthus retroflexus](#)

References:

Agriculture Quebec. 1975. Noms des maladies des plantes du Canada/ Names of plant diseases in Canada. , Quebec City, Que., Canada. 288 pp.

Alex, J. F., Cayouette, R., Mulligan, G. A. 1980. Common and botanical names of weeds in Canada/Noms populaire et scientifiques des plantes nuisibles du Canada. Revised. Agric. Can. Publ., Ottawa, Ont., Canada. 132 pp.

Bailey, L. H., Bailey, E. Z. 1976. Hortus third. Revised. MacMillan, New York, N.Y., USA. 1290 pp.

Scoggan, H. J. 1978, 1979. The flora of Canada. Nat. Mus. Nat. Sci. (Ottawa) Publ. Bot. 7(1)-7(4). 1711 pp.

Van Wijk, H. L. 1911. A dictionary of plant names. Martinus Nijhoff, The Hague, The Netherlands. 1444 pp.

Victorin, M. 1964. Flore Laurentienne. 2nd ed. Univ. Montreal, Montreal, Que., Canada. 952 pp.

Geographic Information

Alberta
British Columbia
Manitoba
New Brunswick
Northwest Territories
Nova Scotia
Ontario
Prince Edward Island
Quebec
Saskatchewan

References:

Bailey, L. H., Bailey, E. Z. 1976. Hortus third. Revised.

MacMillan, New York, N.Y., USA. 1290 pp.

Boivin, B. 1966, 1967. Énumération des plantes du Canada. Provencheria 6. Nat. Can. (Que.) 93: 253-274; 371-437; 583-646; 989-1063. 94: 131-157; 471-528; 625-655.

Image or illustration

Amaranthus retroflexus:

Images: images.google.com

Toxic parts:

leaves

stems

References:

Osweiler, G. D., Buck, W. B., Bicknell, E. J. 1969. Production of perirenal edema in swine with *Amaranthus retroflexus*. Am. J. Vet. Res., 30: 557-566.

Stuart, B. P., Nicholson, S. S., Smith, J. B. 1975. Perirenal edema and toxic nephrosis in cattle, associated with ingestion of pigweed. J. Am. Vet. Med. Assoc., 167: 949-950.

Notes on Toxic plant chemicals:

Nitrates have the following LD-50 values (Crawford et al. 1966):

LD-50 1.0 g/kg body weight in cattle

LD-50 0.5 g/kg body weight in other ruminants.

Acute poisoning occurs when forage nitrates exceed 1.0% nitrate (dry weight) or 1500 ppm in water (Osweiler et al. 1985). All *Amaranthus* spp. mentioned in this information system can accumulate toxic quantities of nitrates.

Toxic plant chemicals:

nitrate

References:

Crawford, R. F., Kennedy, W. K., Davison, K. L. 1966. Factors influencing the toxicity of forages that contain nitrate when fed to cattle. Cornell Vet., 56: 3-17.

Animals/Human Poisoning:

Note: When an animal is listed without additional information, the literature (as of 1993) contained no detailed explanation.

Cattle

General symptoms of poisoning:

[abortion](#)

[bloat](#)

[blood brownish](#)

[breathing, rapid](#)

[death](#)

[dyspnea](#)

[kidney, edema of](#)

[mucous membrane, brown](#)

[nephrosis, severe](#)

[nervousness](#)

[recumbency](#)

[recumbency, ventral](#)

[regurgitation](#)

[weakness, posterior](#)

References:

Crawford, R. F., Kennedy, W. K., Davison, K. L. 1966. Factors influencing the toxicity of forages that contain nitrate when fed to cattle. *Cornell Vet.*, 56: 3-17.

Duckworth, R. H. 1975. Poisoning of cattle by *Amaranthus*. *N. Z. Vet. J.*, 23: 154-155.

Hibbs, C. M., Stencel, E. L., Hill, R. M. 1978. Nitrate toxicosis in cattle. *Vet. Hum. Toxicol.*, 20: 1-2.

Stuart, B. P., Nicholson, S. S., Smith, J. B. 1975. Perirenal edema and toxic nephrosis in cattle, associated with ingestion of pigweed. *J. Am. Vet. Med. Assoc.*, 167: 949-950.

Swine

General symptoms of poisoning:

[ataxia](#)

[death](#)

[gait, crouching](#)

[kidney, edema of](#)

[nephrosis, severe](#)
[recumbency, ventral](#)
[trembling](#)
[weakness](#)

References:

Oswailer, G. D., Buck, W. B., Bicknell, E. J. 1969. Production of perirenal edema in swine with *Amaranthus retroflexus*. Am. J. Vet. Res., 30: 557-566.

Scimeca, J. M., Oehme, F. W. 1985. Postmortem guide to common poisonous plants of livestock. Vet. Hum. Toxicol., 27: 189-199.

[Another search?](#)

[Français](#) | [Contact Us](#) | [Help](#) | [Search](#) | [Canada site](#)

[Coming Events](#) | [About CBIF](#) | [Links](#) | [Reports and Publications](#) | [Home](#)

Date modified: 2003-02-06

[Important Notices](#)



Français	Contact us	Help	Search	Canada site
Coming events	About CBIF	Links	Reports and publications	Home

Canadian Biodiversity Information Facility



Notes on poisoning: *Amaryllis belladonna*

[Introduction](#)[Interactive](#)[All poisonous plants by Botanical name](#)[All poisonous plants by Common name](#)[Important WWW Poisonous Plants sites](#)

General poisoning notes:

Amaryllis (*Amaryllis belladonna*) is an ornamental plant commonly sold for its winter flowers. Ingesting the bulbs has poisoned humans. The toxic alkaloid, lycorine, is the principal toxin, although small quantities of related alkaloids are also present (Lampe and McCann 1985; Fuller and McClintock 1986).



References:

- Fuller, T. C., McClintock, E. 1986. Poisonous plants of California. Univ. California Press, Berkeley, Calif., USA. 432 pp.
- Lampe, K. F., McCann, M. A. 1985. AMA Handbook of poisonous and injurious plants. American Medical Assoc. Chicago, Ill., USA. 432 pp.

Nomenclature:

Scientific Name: *Amaryllis belladonna* L.

Vernacular name(s): amaryllis (A. belledonna)

Scientific family name: *Amaryllidaceae*

Vernacular family name: amaryllis

Go to ITIS^{*ca} for more taxonomic information on: [Amaryllis belladonna](#)

References:

Agriculture Quebec. 1975. Noms des maladies des plantes du Canada/ Names of plant diseases in Canada. , Quebec City, Que., Canada. 288 pp.

Alex, J. F., Cayouette, R., Mulligan, G. A. 1980. Common and

botanical names of weeds in Canada/Noms populaire et scientifiques des plantes nuisibles du Canada. Revised. Agric. Can. Publ., Ottawa, Ont., Canada. 132 pp.

Bailey, L. H., Bailey, E. Z. 1976. Hortus third. Revised. MacMillan, New York, N.Y., USA. 1290 pp.

Scoggan, H. J. 1978, 1979. The flora of Canada. Nat. Mus. Nat. Sci. (Ottawa) Publ. Bot. 7(1)-7(4). 1711 pp.

Van Wijk, H. L. 1911. A dictionary of plant names. Martinus Nijhoff, The Hague, The Netherlands. 1444 pp.

Victorin, M. 1964. Flore Laurentienne. 2nd ed. Univ. Montreal, Montreal, Que., Canada. 952 pp.

Geographic Information

Plant or plant parts used in or around the home.

References:

Bailey, L. H., Bailey, E. Z. 1976. Hortus third. Revised. MacMillan, New York, N.Y., USA. 1290 pp.

Boivin, B. 1966, 1967. Énumération des plantes du Canada. Provencheria 6. Nat. Can. (Que.) 93: 253-274; 371-437; 583-646; 989-1063. 94: 131-157; 471-528; 625-655.

Image or illustration

Amaryllis belladonna:

Images: images.google.com

Toxic parts:

bulbs

References:

Lampe, K. F., McCann, M. A. 1985. AMA Handbook of poisonous and injurious plants. American Medical Assoc. Chicago, Ill., USA. 432 pp.

Notes on Toxic plant chemicals:

Lycorine, a heat-stable alkaloid, is found in *Amaryllis* spp. as well as *Clivia* spp., *Galanthus nivalis*, and *Narcissus* spp. This chemical occurs in small quantities in *Amaryllis* species, so that large quantities of bulb must be eaten to cause symptoms (Lampe

and McCann 1985).

Toxic plant chemicals:

lycorine

References:

Fuller, T. C., McClintock, E. 1986. Poisonous plants of California. Univ. California Press, Berkeley, Calif., USA. 432 pp.

Lampe, K. F., McCann, M. A. 1985. AMA Handbook of poisonous and injurious plants. American Medical Assoc. Chicago, Ill., USA. 432 pp.

Animals/Human Poisoning:

Note: When an animal is listed without additional information, the literature (as of 1993) contained no detailed explanation.

Humans

General symptoms of poisoning:

[diarrhea](#)

[nausea](#)

[vomiting](#)

References:

Fuller, T. C., McClintock, E. 1986. Poisonous plants of California. Univ. California Press, Berkeley, Calif., USA. 432 pp.

Lampe, K. F., McCann, M. A. 1985. AMA Handbook of poisonous and injurious plants. American Medical Assoc. Chicago, Ill., USA. 432 pp.

[Another search?](#)

[Français](#) | [Contact Us](#) | [Help](#) | [Search](#) | [Canada site](#)

[Coming Events](#) | [About CBIF](#) | [Links](#) | [Reports and Publications](#) |

[Home](#)

Date modified: 2003-02-06

[Important Notices](#)



Français	Contact us	Help	Search	Canada site
Coming events	About CBIF	Links	Reports and publications	Home

Canadian Biodiversity Information Facility



Notes on poisoning: *Amaryllis vittata*

[Introduction](#)[Interactive](#)[All poisonous plants by Botanical name](#)[All poisonous plants by Common name](#)[Important WWW Poisonous Plants sites](#)

General poisoning notes:

The symptoms of poisoning and the chemical involved in amaryllis (*A. vittata*) are the same as those for [A. belladonna](#).

Please see the additional notes listed under that species.

References:



Lampe, K. F., McCann, M. A. 1985. AMA Handbook of poisonous and injurious plants. American Medical Assoc. Chicago, Ill., USA. 432 pp.

Nomenclature:

Scientific Name: *Amaryllis vittata* Ait.

Vernacular name(s): amaryllis (*A. vittata*)

Scientific family name: *Amaryllidaceae*

Vernacular family name: amaryllis

References:

Agriculture Quebec. 1975. Noms des maladies des plantes du Canada/ Names of plant diseases in Canada. , Quebec City, Que., Canada. 288 pp.

Alex, J. F., Cayouette, R., Mulligan, G. A. 1980. Common and botanical names of weeds in Canada/Noms populaire et scientifiques des plantes nuisibles du Canada. Revised. Agric. Can. Publ., Ottawa, Ont., Canada. 132 pp.

Bailey, L. H., Bailey, E. Z. 1976. Hortus third. Revised. MacMillan, New York, N.Y., USA. 1290 pp.

Scoggan, H. J. 1978, 1979. The flora of Canada. Nat. Mus. Nat.

Sci. (Ottawa) Publ. Bot. 7(1)-7(4). 1711 pp.

Van Wijk, H. L. 1911. A dictionary of plant names. Martinus Nijhoff, The Hague, The Netherlands. 1444 pp.

Victorin, M. 1964. Flore Laurentienne. 2nd ed. Univ. Montreal, Montreal, Que., Canada. 952 pp.

Geographic Information

Plant or plant parts used in or around the home.

References:

Bailey, L. H., Bailey, E. Z. 1976. Hortus third. Revised. MacMillan, New York, N.Y., USA. 1290 pp.

Boivin, B. 1966, 1967. Énumération des plantes du Canada. Provencheria 6. Nat. Can. (Que.) 93: 253-274; 371-437; 583-646; 989-1063. 94: 131-157; 471-528; 625-655.

Image or illustration

Amaryllis vittata:

Images: images.google.com

Toxic parts:

bulbs

References:

Lampe, K. F., McCann, M. A. 1985. AMA Handbook of poisonous and injurious plants. American Medical Assoc. Chicago, Ill., USA. 432 pp.

Toxic plant chemicals:

lycorine

References:

Lampe, K. F., McCann, M. A. 1985. AMA Handbook of poisonous and injurious plants. American Medical Assoc. Chicago, Ill., USA. 432 pp.

Animals/Human Poisoning:

Note: When an animal is listed without additional information, the literature (as of 1993) contained no detailed explanation.

Humans

General symptoms of poisoning:

[nausea](#)

[vomiting](#)

References:

Lampe, K. F., McCann, M. A. 1985. AMA Handbook of poisonous and injurious plants. American Medical Assoc. Chicago, Ill., USA. 432 pp.

[Another search?](#)

[Français](#) | [Contact Us](#) | [Help](#) | [Search](#) | [Canada site](#)

[Coming Events](#) | [About CBIF](#) | [Links](#) | [Reports and Publications](#) |

[Home](#)

Date modified: 2003-02-06

[Important Notices](#)



Français	Contact us	Help	Search	Canada site
Coming events	About CBIF	Links	Reports and publications	Home

Canadian Biodiversity Information Facility



Notes on poisoning: *Amelanchier alnifolia*

[Introduction](#)[Interactive](#)[All poisonous plants by Botanical name](#)[All poisonous plants by Common name](#)[Important WWW Poisonous Plants sites](#)

General poisoning notes:

Saskatoon, a serviceberry (*Amelanchier alnifolia*), is a shrub native to western Canada. The shrub has an hydrogen cyanide (HCN) potential high enough to kill cattle and mule deer. Mule deer that ingested 1 kg of fresh weight per day were poisoned and died within 24 h of the appearance of clinical signs. Experiments with cattle also showed the poisoning potential (Majak et al. 1978, Majak et al. 1980).

References:

Majak, W., Bose, R. J., Quinton, D. A. 1978. Prunasin, the cyanogenic glycoside in *Amelanchier alnifolia*. *Phytochemistry* (Oxf.), 17: 803.

Majak, W., Udenberg, T., Clark, L. J., McLean, A. 1980. Toxicity of Saskatoon serviceberry to cattle. *Can. Vet. J.*, 21: 74-76.

Nomenclature:

Scientific Name: *Amelanchier alnifolia* Nutt.

Vernacular name(s): Saskatoon (a serviceberry)

Scientific family name: *Rosaceae*

Vernacular family name: rose

Go to ITIS*^{ca} for more taxonomic information on: [Amelanchier alnifolia](#)

References:

Agriculture Quebec. 1975. Noms des maladies des plantes du Canada/ Names of plant diseases in Canada. , Quebec City, Que.,

Canada. 288 pp.

Alex, J. F., Cayouette, R., Mulligan, G. A. 1980. Common and botanical names of weeds in Canada/Noms populaire et scientifiques des plantes nuisibles du Canada. Revised. Agric. Can. Publ., Ottawa, Ont., Canada. 132 pp.

Bailey, L. H., Bailey, E. Z. 1976. Hortus third. Revised. MacMillan, New York, N.Y., USA. 1290 pp.

Scoggan, H. J. 1978, 1979. The flora of Canada. Nat. Mus. Nat. Sci. (Ottawa) Publ. Bot. 7(1)-7(4). 1711 pp.

Van Wijk, H. L. 1911. A dictionary of plant names. Martinus Nijhoff, The Hague, The Netherlands. 1444 pp.

Victorin, M. 1964. Flore Laurentienne. 2nd ed. Univ. Montreal, Montreal, Que., Canada. 952 pp.

Geographic Information

Alberta
British Columbia
Manitoba
Northwest Territories
Ontario
Quebec
Saskatchewan
Yukon Territory

References:

Bailey, L. H., Bailey, E. Z. 1976. Hortus third. Revised. MacMillan, New York, N.Y., USA. 1290 pp.

Boivin, B. 1966, 1967. Énumération des plantes du Canada. Provencheria 6. Nat. Can. (Que.) 93: 253-274; 371-437; 583-646; 989-1063. 94: 131-157; 471-528; 625-655.

Image or illustration

Amelanchier alnifolia:

Images: images.google.com

Notes on Poisonous plant parts:

Saskatoon contains a large quantity of prunasin, which has a hydrogen cyanide (HCN) potential exceeding the level required to cause of poisoning in cattle. HCN occurs in the twigs before the leaves appear and during the bloom period. The level of HCN

potential is highest in new-growth twigs, especially during dry years (Majak et al. 1981).

Toxic parts:

flower buds
leaves
seeds
twigs
young shoots

References:

Majak, W., Bose, R. J., Quinton, D. A. 1978. Prunasin, the cyanogenic glycoside in *Amelanchier alnifolia*. *Phytochemistry* (Oxf.), 17: 803.

Majak, W., McDiarmid, R. E., Hall, J. W. 1981. The cyanide potential of Saskatoon serviceberry (*Amelanchier alnifolia*) and chokecherry (*Prunus virginiana*). *Can. J. Anim. Sci.*, 61: 681-686.

Majak, W., Quinton, D. A., Broersma, K. 1980. Cyanogenic glycoside levels in Saskatoon serviceberry. *J. Range Manage.*, 33: 197-199.

Majak, W., Udenberg, T., Clark, L. J., McLean, A. 1980. Toxicity of Saskatoon serviceberry to cattle. *Can. Vet. J.*, 21: 74-76.

Toxic plant chemicals:

prunasin

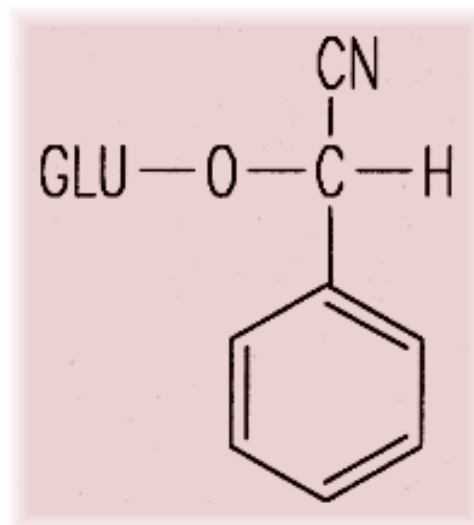

Chemical diagram(s) are courtesy of [Ruth McDiarmid](#), Biochemistry Technician, Kamloops Range Station, Agriculture and Agri-Food Canada, Kamloops, British Columbia, Canada.

References:

Majak, W., Bose, R. J., Quinton, D. A. 1978. Prunasin, the cyanogenic glycoside in *Amelanchier alnifolia*. *Phytochemistry* (Oxf.), 17: 803.

Majak, W., Quinton, D. A., Broersma, K. 1980. Cyanogenic glycoside levels in Saskatoon serviceberry. *J. Range Manage.*, 33: 197-199.

Majak, W., Udenberg, T., Clark, L. J., McLean, A. 1980. Toxicity of Saskatoon serviceberry to cattle. *Can. Vet. J.*, 21: 74-76.

Animals/Human Poisoning:

Note: When an animal is listed without additional information, the literature (as of 1993) contained no detailed explanation.

Cattle

General symptoms of poisoning:

[breathing, labored](#)

[death](#)

[diarrhea](#)

[heart rate, elevated](#)

[recumbency, lateral](#)

[restlessness](#)

[shivering](#)

[weight loss](#)

Notes on poisoning:

Hydrogen cyanide (HCN) poisoning was experimentally induced in cattle. The experiment showed that a single dose of the browse with 1.43% prunasin can be lethal to cattle. Peak cyanide levels occurred in the blood 1-2 h after ingestion. The rumen had a distinct almond smell (Majak et al. 1980).

References:

Majak, W., Udenberg, T., Clark, L. J., McLean, A. 1980. Toxicity of Saskatoon serviceberry to cattle. *Can. Vet. J.*, 21: 74-76.

[Another search?](#)

[Français](#) | [Contact Us](#) | [Help](#) | [Search](#) | [Canada site](#)

[Coming Events](#) | [About CBIF](#) | [Links](#) | [Reports and Publications](#) | [Home](#)

Date modified: 2003-02-06

[Important Notices](#)



Français	Contact us	Help	Search	Canada site
Coming events	About CBIF	Links	Reports and publications	Home

Canadian Biodiversity Information Facility



Notes on poisoning: *Amsinckia intermedia*

[Introduction](#)[Interactive](#)[All poisonous plants by Botanical name](#)[All poisonous plants by Common name](#)[Important WWW Poisonous Plants sites](#)

General poisoning notes:

Fiddleneck (*Amsinckia intermedia*) is an introduced plant found in parts of western Canada. Ingestion can cause severe diseases in horses, swine, and cattle. Hepatic cirrhosis results from ingesting the seeds of the plant. The symptoms are termed walking disease in horses and are known as hard liver disease in swine and cattle. These diseases were present mainly in California and the Pacific Northwest. With the advent of herbicides, the problems have mostly disappeared (Woolsey et al. 1952, Cheeke and Schull 1985).

References:

Cheeke, P. R., Shull, L. R. 1985. Natural toxicants in feeds and poisonous plants. AVI Publishing Company, Inc., Westport, Conn., USA. 492 pp.

Kennedy, P. C. 1957. Symposium on poisoning-part 2. Case 16-Tarweed poisoning in swine. J. Am. Vet. Med. Assoc., 130: 305-306.

McCulloch, E. C. 1940. Hepatic cirrhosis of horses, swine and cattle due to the ingestion of seeds of the tarweed, *Amsinckia intermedia*. J. Am. Vet. Med. Assoc., 96: 5-18.

Woolsey, J. H., Jasper, D. E., Cordy, D. R., Christensen, J. F. 1952. Two outbreaks of hepatic cirrhosis in swine in California, with evidence incriminating the tarweed, *Amsinckia intermedia*. Vet. Med. Small Anim. Clin., 47: 55-58.

Nomenclature:

Scientific Name: *Amsinckia intermedia* Fisch & Mey.

Vernacular name(s): fiddleneck

Scientific family name: *Boraginaceae*

Vernacular family name: borage

Go to ITIS^{*ca} for more taxonomic information on: [Amsinckia intermedia](#)

References:

Agriculture Quebec. 1975. Noms des maladies des plantes du Canada/ Names of plant diseases in Canada. , Quebec City, Que., Canada. 288 pp.

Alex, J. F., Cayouette, R., Mulligan, G. A. 1980. Common and botanical names of weeds in Canada/Noms populaire et scientifiques des plantes nuisibles du Canada. Revised. Agric. Can. Publ., Ottawa, Ont., Canada. 132 pp.

Bailey, L. H., Bailey, E. Z. 1976. Hortus third. Revised. MacMillan, New York, N.Y., USA. 1290 pp.

Scoggan, H. J. 1978, 1979. The flora of Canada. Nat. Mus. Nat. Sci. (Ottawa) Publ. Bot. 7(1)-7(4). 1711 pp.

Van Wijk, H. L. 1911. A dictionary of plant names. Martinus Nijhoff, The Hague, The Netherlands. 1444 pp.

Victorin, M. 1964. Flore Laurentienne. 2nd ed. Univ. Montreal, Montreal, Que., Canada. 952 pp.

Geographic Information

Alberta
British Columbia
Manitoba
Saskatchewan
Yukon Territory

References:

Bailey, L. H., Bailey, E. Z. 1976. Hortus third. Revised. MacMillan, New York, N.Y., USA. 1290 pp.

Boivin, B. 1966, 1967. Énumération des plantes du Canada. Provencheria 6. Nat. Can. (Que.) 93: 253-274; 371-437; 583-646; 989-1063. 94: 131-157; 471-528; 625-655.

Image or illustration

Amsinckia intermedia:

Images: images.google.com

Toxic parts:

seeds

References:

McCulloch, E. C. 1940. Hepatic cirrhosis of horses, swine and cattle due to the ingestion of seeds of the tarweed, *Amsinckia intermedia*. J. Am. Vet. Med. Assoc., 96: 5-18.

Woolsey, J. H., Jasper, D. E., Cordy, D. R., Christensen, J. F. 1952. Two outbreaks of hepatic cirrhosis in swine in California, with evidence incriminating the tarweed, *Amsinckia intermedia*. Vet. Med. Small Anim. Clin., 47: 55-58.

Notes on Toxic plant chemicals:

The pyrrolizidine alkaloids of fiddleneck cause hepatic cirrhosis in cattle, swine, and horses, mainly a result of the presence of the seeds in grain and grain screenings fed to livestock. With modern herbicides, the problem has disappeared (Cheeke and Schull 1985).

Toxic plant chemicals:

echiumine
intermedine
lycopsamine

References:

Cheeke, P. R., Shull, L. R. 1985. Natural toxicants in feeds and poisonous plants. AVI Publishing Company, Inc., Westport, Conn., USA. 492 pp.

Animals/Human Poisoning:

Note: When an animal is listed without additional information, the literature (as of 1993) contained no detailed explanation.

Cattle

General symptoms of poisoning:

[abdominal pains](#)

[death](#)

[icterus](#)

[liver, cirrhosis of](#)

References:

McCulloch, E. C. 1940. Hepatic cirrhosis of horses, swine and cattle due to the ingestion of seeds of the tarweed, *Amsinckia intermedia*. J. Am. Vet. Med. Assoc., 96: 5-18.

Horses

General symptoms of poisoning:

[death](#)

[hemoglobinuria](#)

[icterus](#)

[liver, cirrhosis of](#)

References:

McCulloch, E. C. 1940. Hepatic cirrhosis of horses, swine and cattle due to the ingestion of seeds of the tarweed, *Amsinckia intermedia*. J. Am. Vet. Med. Assoc., 96: 5-18.

Swine

General symptoms of poisoning:

[abdomen, distended](#)

[anemia](#)

[appetite, loss of](#)

[ascites](#)

[death](#)

[icterus](#)

[liver, cirrhosis of](#)

[prostration](#)

[weakness](#)

[weight gain, reduced](#)

[weight loss](#)

References:

Kennedy, P. C. 1957. Symposium on poisoning-part 2. Case 16-Tarweed poisoning in swine. J. Am. Vet. Med. Assoc., 130: 305-306.

McCulloch, E. C. 1940. Hepatic cirrhosis of horses, swine and cattle due to the ingestion of seeds of the tarweed, *Amsinckia intermedia*. J. Am. Vet. Med. Assoc., 96: 5-18.

Woolsey, J. H., Jasper, D. E., Cordy, D. R., Christensen, J. F.

1952. Two outbreaks of hepatic cirrhosis in swine in California, with evidence incriminating the tarweed, *Amsinckia intermedia*. Vet. Med. Small Anim. Clin., 47: 55-58.

[Another search?](#)

[Français](#) | [Contact Us](#) | [Help](#) | [Search](#) | [Canada site](#)

[Coming Events](#) | [About CBIF](#) | [Links](#) | [Reports and Publications](#) |

[Home](#)

Date modified: 2003-02-06

[Important Notices](#)



Français	Contact us	Help	Search	Canada site
Coming events	About CBIF	Links	Reports and publications	Home

Canadian Biodiversity Information Facility



Notes on poisoning: *Anagallis arvensis*

[Introduction](#)[Interactive](#)[All poisonous plants by Botanical name](#)[All poisonous plants by Common name](#)[Important WWW Poisonous Plants sites](#)

General poisoning notes:

Scarlet pimpernel (*Anagallis arvensis*) is a naturalized plant found across parts of southern Canada. The plant contains several toxins that have poisoned livestock, and an irritant in the plant hairs can cause allergies in humans. The occurrence of poisoning appears to depend on unknown conditions, which may account for the conflicting literature reports. However, the plant has been implicated in enough cases of poisoning to be treated as a potentially toxic plant (Cooper and Johnson 1984, Fuller and McClintock 1986).

References:

- Cooper, M. R., Johnson, A. W. 1984. Poisonous plants in Britain and their effects on animals and man. Her Majesty's Stationery Office, London, England. 305 pp.
- Fuller, T. C., McClintock, E. 1986. Poisonous plants of California. Univ. California Press, Berkeley, Calif., USA. 432 pp.
- Perkins, K. D., Payne, W. W. 1978. Guide to the poisonous and irritant plants of Florida. Univ. Fla. Agric. Ext. Serv. Circ., 441. 84 pp.
- Reynard, G. B., Norton, J. B. 1942. Poisonous plants of Maryland in relation to livestock. Univ. MD. Agric. Exp. Stn. Bull., A10. 312 pp.

Nomenclature:

Scientific Name: *Anagallis arvensis* L.

Vernacular name(s): scarlet pimpernel

Scientific family name: *Primulaceae*

Vernacular family name: primrose

Go to ITIS^{*ca} for more taxonomic information on: [Anagallis arvensis](#)

References:

Agriculture Quebec. 1975. Noms des maladies des plantes du Canada/ Names of plant diseases in Canada. , Quebec City, Que., Canada. 288 pp.

Alex, J. F., Cayouette, R., Mulligan, G. A. 1980. Common and botanical names of weeds in Canada/Noms populaire et scientifiques des plantes nuisibles du Canada. Revised. Agric. Can. Publ., Ottawa, Ont., Canada. 132 pp.

Bailey, L. H., Bailey, E. Z. 1976. Hortus third. Revised. MacMillan, New York, N.Y., USA. 1290 pp.

Scoggan, H. J. 1978, 1979. The flora of Canada. Nat. Mus. Nat. Sci. (Ottawa) Publ. Bot. 7(1)-7(4). 1711 pp.

Van Wijk, H. L. 1911. A dictionary of plant names. Martinus Nijhoff, The Hague, The Netherlands. 1444 pp.

Victorin, M. 1964. Flore Laurentienne. 2nd ed. Univ. Montreal, Montreal, Que., Canada. 952 pp.

Geographic Information

Alberta
British Columbia
Labrador
Nova Scotia
Ontario
Quebec

References:

Bailey, L. H., Bailey, E. Z. 1976. Hortus third. Revised. MacMillan, New York, N.Y., USA. 1290 pp.

Boivin, B. 1966, 1967. Énumération des plantes du Canada. Provencheria 6. Nat. Can. (Que.) 93: 253-274; 371-437; 583-646; 989-1063. 94: 131-157; 471-528; 625-655.

Image or illustration

Anagallis arvensis:

Images: images.google.com

Toxic parts:

all parts

References:

Cooper, M. R., Johnson, A. W. 1984. Poisonous plants in Britain and their effects on animals and man. Her Majesty's Stationery Office, London, England. 305 pp.

Notes on Toxic plant chemicals:

Scarlet pimpernel contains a triterpenoid saponin in the above-ground plant parts, a glycoside (cyclamine) in the roots, and an acrid volatile oil. The plant hairs contain primin, which can cause human dermatitis (Perkins and Payne 1987, Cooper and Johnson 1984).

Toxic plant chemicals:

cyclamin

References:

Cooper, M. R., Johnson, A. W. 1984. Poisonous plants in Britain and their effects on animals and man. Her Majesty's Stationery Office, London, England. 305 pp.

Perkins, K. D., Payne, W. W. 1978. Guide to the poisonous and irritant plants of Florida. Univ. Fla. Agric. Ext. Serv. Circ., 441. 84 pp.

Animals/Human Poisoning:

Note: When an animal is listed without additional information, the literature (as of 1993) contained no detailed explanation.

Cattle

General symptoms of poisoning:

[death](#)

References:

Fuller, T. C., McClintock, E. 1986. Poisonous plants of California. Univ. California Press, Berkeley, Calif., USA. 432 pp.

Reynard, G. B., Norton, J. B. 1942. Poisonous plants of Maryland

in relation to livestock. Univ. MD. Agric. Exp. Stn. Bull., A10.
312 pp.

Horses

Humans

General symptoms of poisoning:

[constipation](#)

[erythema](#)

[gait, staggering](#)

[headache](#)

[kidney, congestion of](#)

[nausea](#)

References:

Fuller, T. C., McClintock, E. 1986. Poisonous plants of California. Univ. California Press, Berkeley, Calif., USA. 432 pp.

Perkins, K. D., Payne, W. W. 1978. Guide to the poisonous and irritant plants of Florida. Univ. Fla. Agric. Ext. Serv. Circ., 441. 84 pp.

Sheep

[Another search?](#)

[Français](#) | [Contact Us](#) | [Help](#) | [Search](#) | [Canada site](#)

[Coming Events](#) | [About CBIF](#) | [Links](#) | [Reports and Publications](#) |

[Home](#)

Date modified: 2003-02-06

[Important Notices](#)



Français	Contact us	Help	Search	Canada site
Coming events	About CBIF	Links	Reports and publications	Home

Canadian Biodiversity Information Facility



Notes on poisoning: *Anthurium andraeanum*

[Introduction](#)[Interactive](#)[All poisonous plants by Botanical name](#)[All poisonous plants by Common name](#)[Important WWW Poisonous Plants sites](#)

General poisoning notes:

Flamingo lily (*Anthurium andraeanum*) is an indoor ornamental plant that produces striking flowers. Ingestion can cause painful irritation of the mouth and throat. Other species of the genus *Anthurium* may be cultivated in Canada, and all these plants should be regarded as containing calcium oxalate crystals, an irritant.



References:

- Fuller, T. C., McClintock, E. 1986. Poisonous plants of California. Univ. California Press, Berkeley, Calif., USA. 432 pp.
- Lampe, K. F., McCann, M. A. 1985. AMA Handbook of poisonous and injurious plants. American Medical Assoc. Chicago, Ill., USA. 432 pp.

Nomenclature:

Scientific Name: *Anthurium andraeanum* Lind.

Vernacular name(s): flamingo lily

Scientific family name: *Araceae*

Vernacular family name: arum

References:

- Agriculture Quebec. 1975. Noms des maladies des plantes du Canada/ Names of plant diseases in Canada. , Quebec City, Que., Canada. 288 pp.
- Alex, J. F., Cayouette, R., Mulligan, G. A. 1980. Common and botanical names of weeds in Canada/Noms populaire et scientifiques des plantes nuisibles du Canada. Revised. Agric.

Can. Publ., Ottawa, Ont., Canada. 132 pp.

Bailey, L. H., Bailey, E. Z. 1976. Hortus third. Revised. MacMillan, New York, N.Y., USA. 1290 pp.

Scoggan, H. J. 1978, 1979. The flora of Canada. Nat. Mus. Nat. Sci. (Ottawa) Publ. Bot. 7(1)-7(4). 1711 pp.

Van Wijk, H. L. 1911. A dictionary of plant names. Martinus Nijhoff, The Hague, The Netherlands. 1444 pp.

Victorin, M. 1964. Flore Laurentienne. 2nd ed. Univ. Montreal, Montreal, Que., Canada. 952 pp.

Geographic Information

Plant or plant parts used in or around the home.

References:

Bailey, L. H., Bailey, E. Z. 1976. Hortus third. Revised. MacMillan, New York, N.Y., USA. 1290 pp.

Boivin, B. 1966, 1967. Énumération des plantes du Canada. Provencheria 6. Nat. Can. (Que.) 93: 253-274; 371-437; 583-646; 989-1063. 94: 131-157; 471-528; 625-655.

Image or illustration

Anthurium andraeanum:

Images: images.google.com

Toxic parts:

leaves

stems

References:

Lampe, K. F., McCann, M. A. 1985. AMA Handbook of poisonous and injurious plants. American Medical Assoc. Chicago, Ill., USA. 432 pp.

Notes on Toxic plant chemicals:

Flamingo lily (*Anthurium andraeanum*) contains calcium oxalate raphide crystals, which cause painful swelling in the mouth and throat upon ingestion. These crystals readily penetrate mucous membranes, leading to irritation (Lampe and McCann 1985). Unidentified toxic proteins are also contained in the plants (Fuller

and McClintock 1986).

Toxic plant chemicals:

oxalate

References:

Fuller, T. C., McClintock, E. 1986. Poisonous plants of California. Univ. California Press, Berkeley, Calif., USA. 432 pp.

Lampe, K. F., McCann, M. A. 1985. AMA Handbook of poisonous and injurious plants. American Medical Assoc. Chicago, Ill., USA. 432 pp.

Animals/Human Poisoning:

Note: When an animal is listed without additional information, the literature (as of 1993) contained no detailed explanation.

Humans

General symptoms of poisoning:

[blistering](#)

[dysphagia](#)

[hoarseness](#)

References:

Lampe, K. F., McCann, M. A. 1985. AMA Handbook of poisonous and injurious plants. American Medical Assoc. Chicago, Ill., USA. 432 pp.

[Another search?](#)

[Français](#) | [Contact Us](#) | [Help](#) | [Search](#) | [Canada site](#)

[Coming Events](#) | [About CBIF](#) | [Links](#) | [Reports and Publications](#) |

[Home](#)

Date modified: 2003-02-06

[Important Notices](#)



Français	Contact us	Help	Search	Canada site
Coming events	About CBIF	Links	Reports and publications	Home

Canadian Biodiversity Information Facility



Notes on poisoning:

Apocynum

androsaemifolium

[Introduction](#)[Interactive](#)[All poisonous plants by Botanical name](#)[All poisonous plants by Common name](#)[Important WWW Poisonous Plants sites](#)

General poisoning notes:

Spreading dogbane (*Apocynum androsaemifolium*) is a native herb found across Canada. This plant has been reported to cause serious poisoning potential in cattle, horses, and sheep after ingestion (Johnson and Archer 1922). This information was credited to a report from the Arizona Experiment Station and to an article that was erroneously stated to be about *Apocynum*. However, that article actually concerned *Nerium* (oleander) poisoning of livestock. Therefore, the various signs and symptoms attributed to dogbane poisoning since 1922 are usually based on this mistake (Kingsbury 1959).

References:

- Fleurbec Inc. 1981. Plantes sauvages comestibles. Le groupe Fleurbec Inc., Sainte-Cuthbert, Que, Canada. 167 pp.
- Fuller, T. C., McClintock, E. 1986. Poisonous plants of California. Univ. California Press, Berkeley, Calif., USA. 432 pp.
- Johnson, E. P., Archer, W. A. 1922. The principal stock-poisoning plants of New Mexico. N. M. Agric. Ext. Serv. Circ., 71. 40 pp.
- Kingsbury, J. M. 1959. Toxicity of *Apocynum* (dogbane) to stock; a correction. Cornell Vet., 49: 285-287.
- Moore, C. W. 1909. LXXXV. - The constituents of the rhizome of *Apocynum androsaemifolium*. J. Chem. Soc. (Lond.), 95: 734-751.

Nomenclature:

Scientific Name: *Apocynum androsaemifolium* L.

Vernacular name(s): spreading dogbane

Scientific family name: *Apocynaceae*

Vernacular family name: dogbane

Go to ITIS^{*ca} for more taxonomic information on: [Apocynum androsaemifolium](#)

References:

Agriculture Quebec. 1975. Noms des maladies des plantes du Canada/ Names of plant diseases in Canada. , Quebec City, Que., Canada. 288 pp.

Alex, J. F., Cayouette, R., Mulligan, G. A. 1980. Common and botanical names of weeds in Canada/Noms populaire et scientifiques des plantes nuisibles du Canada. Revised. Agric. Can. Publ., Ottawa, Ont., Canada. 132 pp.

Bailey, L. H., Bailey, E. Z. 1976. Hortus third. Revised. MacMillan, New York, N.Y., USA. 1290 pp.

Scoggan, H. J. 1978, 1979. The flora of Canada. Nat. Mus. Nat. Sci. (Ottawa) Publ. Bot. 7(1)-7(4). 1711 pp.

Van Wijk, H. L. 1911. A dictionary of plant names. Martinus Nijhoff, The Hague, The Netherlands. 1444 pp.

Victorin, M. 1964. Flore Laurentienne. 2nd ed. Univ. Montreal, Montreal, Que., Canada. 952 pp.

Geographic Information

Alberta
British Columbia
Manitoba
New Brunswick
Newfoundland
Northwest Territories
Nova Scotia
Ontario
Prince Edward Island
Quebec
Saskatchewan
Yukon Territory

References:

Bailey, L. H., Bailey, E. Z. 1976. Hortus third. Revised. MacMillan, New York, N.Y., USA. 1290 pp.

Boivin, B. 1966, 1967. Énumération des plantes du Canada. Provencheria 6. Nat. Can. (Que.) 93: 253-274; 371-437; 583-646;

989-1063. 94: 131-157; 471-528; 625-655.

Image or illustration

Apocynum androsaemifolium:

Images: images.google.com

Toxic parts:

rhizome

References:

Moore, C. W. 1909. LXXXV. - The constituents of the rhizome of *Apocynum androsaemifolium*. J. Chem. Soc. (Lond.), 95: 734-751.

Notes on Toxic plant chemicals:

Experimental evidence shows that spreading dogbane contains apocynamarin, a cardiac glycoside, as well as other glycosides and resins. These chemicals have caused sickness and death when administered cats and dogs. The potential for poisoning therefore exists (Moore

Toxic plant chemicals:

apocynamarin

References:

Moore, C. W. 1909. LXXXV. - The constituents of the rhizome of *Apocynum androsaemifolium*. J. Chem. Soc. (Lond.), 95: 734-751.

Animals/Human Poisoning:

Note: When an animal is listed without additional information, the literature (as of 1993) contained no detailed explanation.

Cats

General symptoms of poisoning:

[blood pressure, high](#)
[death](#)

References:

Moore, C. W. 1909. LXXXV. - The constituents of the rhizome of *Apocynum androsaemifolium*. J. Chem. Soc. (Lond.), 95: 734-751.

Dogs

General symptoms of poisoning:

[death](#)

[vomiting](#)

References:

Moore, C. W. 1909. LXXXV. - The constituents of the rhizome of *Apocynum androsaemifolium*. J. Chem. Soc. (Lond.), 95: 734-751.

Horses

Humans

General symptoms of poisoning:

[convulsions](#)

[death](#)

[diarrhea](#)

[sweating](#)

[urination, frequent](#)

[vomiting](#)

Notes on poisoning:

The root of spreading dogbane has been used for medicinal purposes. Excessive doses of the extracts apparently cause sickness and death in humans (Fleurbec 1981).

References:

Fleurbec Inc. 1981. Plantes sauvages comestibles. Le groupe Fleurbec Inc., Sainte-Cuthbert, Que, Canada. 167 pp.

[Another search?](#)

[Français](#) | [Contact Us](#) | [Help](#) | [Search](#) | [Canada site](#)

[Coming Events](#) | [About CBIF](#) | [Links](#) | [Reports and Publications](#) |

[Home](#)

Date modified: 2003-02-06

[Important Notices](#)



Français	Contact us	Help	Search	Canada site
Coming events	About CBIF	Links	Reports and publications	Home

Canadian Biodiversity Information Facility



Notes on poisoning: *Apocynum cannabinum*

[Introduction](#)[Interactive](#)[All poisonous plants by Botanical name](#)[All poisonous plants by Common name](#)[Important WWW Poisonous Plants sites](#)

General poisoning notes:

1909). Hemp dogbane (*Apocynum cannabinum*) is a native plant found across Canada. Fuller and McClintock (1986) report that two horses died after ingesting alfalfa hay that contained large quantities of hemp dogbane. The tops of the plants (up to 1 m tall) were found in the hay.

References:

Fuller, T. C., McClintock, E. 1986. Poisonous plants of California. Univ. California Press, Berkeley, Calif., USA. 432 pp.

Nomenclature:

Scientific Name: *Apocynum cannabinum* L.

Vernacular name(s): hemp dogbane

Scientific family name: *Apocynaceae*

Vernacular family name: dogbane

Go to ITIS*^{ca} for more taxonomic information on: [Apocynum cannabinum](#)

References:

Agriculture Quebec. 1975. Noms des maladies des plantes du Canada/ Names of plant diseases in Canada. , Quebec City, Que., Canada. 288 pp.

Alex, J. F., Cayouette, R., Mulligan, G. A. 1980. Common and botanical names of weeds in Canada/Noms populaire et scientifiques des plantes nuisibles du Canada. Revised. Agric. Can. Publ., Ottawa, Ont., Canada. 132 pp.

Bailey, L. H., Bailey, E. Z. 1976. Hortus third. Revised. MacMillan,

New York, N.Y., USA. 1290 pp.

Scoggan, H. J. 1978, 1979. The flora of Canada. Nat. Mus. Nat. Sci. (Ottawa) Publ. Bot. 7(1)-7(4). 1711 pp.

Van Wijk, H. L. 1911. A dictionary of plant names. Martinus Nijhoff, The Hague, The Netherlands. 1444 pp.

Victorin, M. 1964. Flore Laurentienne. 2nd ed. Univ. Montreal, Montreal, Que., Canada. 952 pp.

Geographic Information

Alberta
British Columbia
Manitoba
New Brunswick
Newfoundland
Northwest Territories
Nova Scotia
Ontario
Quebec
Saskatchewan

References:

Bailey, L. H., Bailey, E. Z. 1976. Hortus third. Revised. MacMillan, New York, N.Y., USA. 1290 pp.

Boivin, B. 1966, 1967. Énumération des plantes du Canada. Provencheria 6. Nat. Can. (Que.) 93: 253-274; 371-437; 583-646; 989-1063. 94: 131-157; 471-528; 625-655.

Image or illustration

Apocynum cannabinum:

Images: images.google.com

Toxic parts:

all parts

References:

Fuller, T. C., McClintock, E. 1986. Poisonous plants of California. Univ. California Press, Berkeley, Calif., USA. 432 pp.

Notes on Toxic plant chemicals:

Hemp dogbane contains the chemical cymarin (a cardiac glycoside). Joubert (1989) lists this chemical under "**Apocynum camrabinum**," which is a typographical error and should read "**Apocynum cannabinum**."

Toxic plant chemicals:

apocynamarin

cymarin

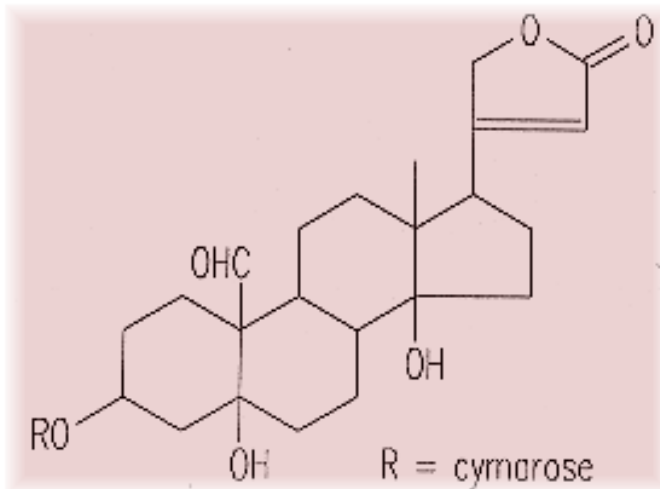

Chemical diagram(s) are courtesy of [Ruth McDiarmid](#), Biochemistry Technician, Kamloops Range Station, Agriculture and Agri-Food Canada, Kamloops, British Columbia, Canada.

References:

Fuller, T. C., McClintock, E. 1986. Poisonous plants of California. Univ. California Press, Berkeley, Calif., USA. 432 pp.

Joubert, J. P. 1989. Cardiac glycosides. Pages 61-97 in Cheeke, P. R., ed. Toxicants of plant origin. Vol. II. Glycosides. CRC Press, Inc., Boca Raton, Fla., USA. 277 pp.

Animals/Human Poisoning:

Note: When an animal is listed without additional information, the literature (as of 1993) contained no detailed explanation.

Horses

[Another search?](#)

[Français](#) | [Contact Us](#) | [Help](#) | [Search](#) | [Canada site](#)

[Coming Events](#) | [About CBIF](#) | [Links](#) | [Reports and Publications](#) | [Home](#)

Date modified: 2003-02-06

[Important Notices](#)



Français	Contact us	Help	Search	Canada site
Coming events	About CBIF	Links	Reports and publications	Home

Canadian Biodiversity Information Facility



Notes on poisoning: *Arisaema triphyllum*

[Introduction](#)[Interactive](#)[All poisonous plants by Botanical name](#)[All poisonous plants by Common name](#)[Important WWW Poisonous Plants sites](#)

General poisoning notes:

Jack-in-the-pulpit (*Arisaema triphyllum*) is a native plant found in wet soils in parts of eastern Canada. The plant contains calcium oxalate raphide crystals, as do many other members of the family Araceae. When ingested, these crystals can cause severe pain and burning in the lips, mouth, and throat (Lampe and McCann 1985).



References:

Lampe, K. F., McCann, M. A. 1985. AMA Handbook of poisonous and injurious plants. American Medical Assoc. Chicago, Ill., USA. 432 pp.

Muenschler, W. C. 1975. Poisonous plants of the United States. Revised. Collier Books, New York, N.Y., USA. 277 pp.

Nomenclature:

Scientific Name: *Arisaema triphyllum* (L.) Torr.

Vernacular name(s): Jack-in-the-pulpit

Scientific family name: *Araceae*

Vernacular family name: arum

Go to ITIS*^{ca} for more taxonomic information on: [Arisaema triphyllum](#)

References:

Agriculture Quebec. 1975. Noms des maladies des plantes du Canada/ Names of plant diseases in Canada. , Quebec City, Que., Canada. 288 pp.

Alex, J. F., Cayouette, R., Mulligan, G. A. 1980. Common and botanical names of weeds in Canada/Noms populaire et scientifiques des plantes nuisibles du Canada. Revised. Agric. Can. Publ., Ottawa, Ont., Canada. 132 pp.

Bailey, L. H., Bailey, E. Z. 1976. Hortus third. Revised. MacMillan, New York, N.Y., USA. 1290 pp.

Scoggan, H. J. 1978, 1979. The flora of Canada. Nat. Mus. Nat. Sci. (Ottawa) Publ. Bot. 7(1)-7(4). 1711 pp.

Van Wijk, H. L. 1911. A dictionary of plant names. Martinus Nijhoff, The Hague, The Netherlands. 1444 pp.

Victorin, M. 1964. Flore Laurentienne. 2nd ed. Univ. Montreal, Montreal, Que., Canada. 952 pp.

Geographic Information

Manitoba
New Brunswick
Nova Scotia
Ontario
Prince Edward Island
Quebec

References:

Bailey, L. H., Bailey, E. Z. 1976. Hortus third. Revised. MacMillan, New York, N.Y., USA. 1290 pp.

Boivin, B. 1966, 1967. Énumération des plantes du Canada. Provencheria 6. Nat. Can. (Que.) 93: 253-274; 371-437; 583-646; 989-1063. 94: 131-157; 471-528; 625-655.

Image or illustration

Arisaema triphyllum:

Images: images.google.com

Toxic parts:

all parts
rhizome

References:

Lampe, K. F., McCann, M. A. 1985. AMA Handbook of poisonous and injurious plants. American Medical Assoc. Chicago, Ill., USA. 432 pp.

Toxic plant chemicals:

oxalate

References:

Lampe, K. F., McCann, M. A. 1985. AMA Handbook of poisonous and injurious plants. American Medical Assoc. Chicago, Ill., USA. 432 pp.

Animals/Human Poisoning:

Note: When an animal is listed without additional information, the literature (as of 1993) contained no detailed explanation.

Humans

General symptoms of poisoning:

[salivation](#)

Notes on poisoning:

Ingesting Jack-in-the-pulpit causes a burning sensation, with associated inflammation, edema, and salivation. Treatment includes cool liquids held in the mouth to provide relief. The oxalates are insoluble and do not cause systemic poisoning in plants (Lampe and McCann 1985).

References:

Lampe, K. F., McCann, M. A. 1985. AMA Handbook of poisonous and injurious plants. American Medical Assoc. Chicago, Ill., USA. 432 pp.

[Another search?](#)

[Français](#) | [Contact Us](#) | [Help](#) | [Search](#) | [Canada site](#)

[Coming Events](#) | [About CBIF](#) | [Links](#) | [Reports and Publications](#) |

[Home](#)

Date modified: 2003-02-06

[Important Notices](#)



Français	Contact us	Help	Search	Canada site
Coming events	About CBIF	Links	Reports and publications	Home

Canadian Biodiversity Information Facility



Notes on poisoning: *Armoracia rusticana*

[Introduction](#)[Interactive](#)[All poisonous plants by Botanical name](#)[All poisonous plants by Common name](#)[Important WWW Poisonous Plants sites](#)

General poisoning notes:

Horseradish (*Armoracia rusticana*) is a cultivated plant that can persist after cultivation. The plant contains glucosinolates, which can cause toxicity in livestock. Irritation of the mucous membranes can occur in humans who grind the roots to produce horseradish condiment. See the notes under *Brassica oleracea* for more information on these chemicals. Under normal circumstances horseradish is safe.

References:



Fenwick, G. R., Heaney, R. K., Mawson, R. 1989. Glucosinolates. Pages 1-41 in Cheeke, P. R., ed. Toxicants of plant origin. Vol. II. Glycosides. CRC Press, Inc., Boca Raton, Fla., USA. 277 pp.

Kingsbury, J. M. 1964. Poisonous plants of the United States and Canada. Prentice-Hall Inc., Englewood Cliffs, N.J., USA. 626 pp.

Nomenclature:

Scientific Name: *Armoracia rusticana* P. Gaertn., Mey & Scherb.

Vernacular name(s): horseradish

Scientific family name: *Cruciferae*

Vernacular family name: mustard

Go to ITIS^{*ca} for more taxonomic information on: [Armoracia rusticana](#)

References:

Agriculture Quebec. 1975. Noms des maladies des plantes du Canada/ Names of plant diseases in Canada. , Quebec City, Que., Canada. 288 pp.

Alex, J. F., Cayouette, R., Mulligan, G. A. 1980. Common and botanical names of weeds in Canada/Noms populaire et scientifiques des plantes nuisibles du Canada. Revised. Agric. Can. Publ., Ottawa, Ont., Canada. 132 pp.

Bailey, L. H., Bailey, E. Z. 1976. Hortus third. Revised. MacMillan, New York, N.Y., USA. 1290 pp.

Scoggan, H. J. 1978, 1979. The flora of Canada. Nat. Mus. Nat. Sci. (Ottawa) Publ. Bot. 7(1)-7(4). 1711 pp.

Van Wijk, H. L. 1911. A dictionary of plant names. Martinus Nijhoff, The Hague, The Netherlands. 1444 pp.

Victorin, M. 1964. Flore Laurentienne. 2nd ed. Univ. Montreal, Montreal, Que., Canada. 952 pp.

Geographic Information

Alberta
British Columbia
Manitoba
Ontario
Prince Edward Island
Quebec
Saskatchewan

References:

Bailey, L. H., Bailey, E. Z. 1976. Hortus third. Revised. MacMillan, New York, N.Y., USA. 1290 pp.

Boivin, B. 1966, 1967. Énumération des plantes du Canada. Provencheria 6. Nat. Can. (Que.) 93: 253-274; 371-437; 583-646; 989-1063. 94: 131-157; 471-528; 625-655.

Image or illustration

A Armoracia rusticana:

Images: images.google.com

Notes on Poisonous plant parts:

Horseradish contains glucosinolates which, if ingested in sufficient quantities, can cause poisoning (Fenwick et al. 1989).

Toxic parts:

all parts

leaves

roots

References:

Fenwick, G. R., Heaney, R. K., Mawson, R. 1989. Glucosinolates. Pages 1-41 in Cheeke, P. R., ed. Toxicants of plant origin. Vol. II. Glycosides. CRC Press, Inc., Boca Raton, Fla., USA. 277 pp.

Notes on Toxic plant chemicals:

See the notes under [Brassica oleracea](#) for a discussion on this chemical and its effects on livestock and humans.

Toxic plant chemicals:

glucosinolates

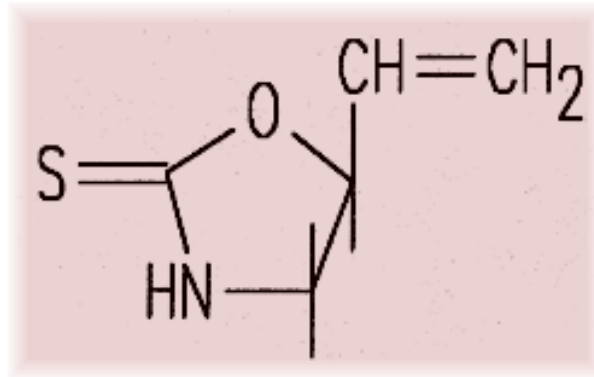

glucosinolates

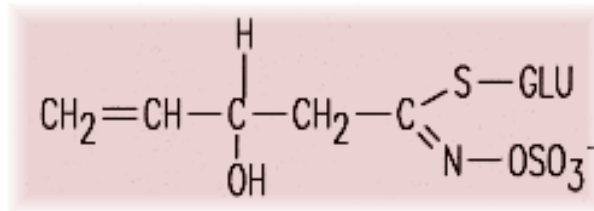

glucosinolates

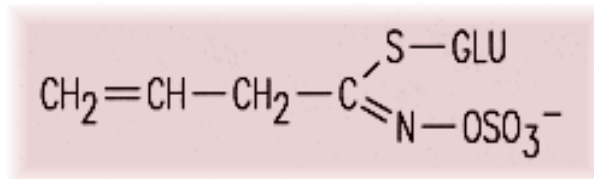

Chemical diagram(s) are courtesy of [Ruth McDiarmid](#), Biochemistry Technician, Kamloops Range Station, Agriculture and Agri-Food Canada, Kamloops, British Columbia, Canada.

References:

Fenwick, G. R., Heaney, R. K., Mawson, R. 1989. Glucosinolates. Pages 1-41 in Cheeke, P. R., ed. Toxicants of plant origin. Vol. II.

Glycosides. CRC Press, Inc., Boca Raton, Fla., USA. 277 pp.

Animals/Human Poisoning:

Note: When an animal is listed without additional information, the literature (as of 1993) contained no detailed explanation.

Humans

Swine

General symptoms of poisoning:

[collapse](#)

[death](#)

Notes on poisoning:

Swine have been poisoned after ingesting of horseradish root equal to 1% of body weight. The animals suffer acute inflammation of the mucous membranes of the stomach as well as pain, followed by collapse and death (Kingsbury 1964).

References:

Fenwick, G. R., Heaney, R. K., Mawson, R. 1989. Glucosinolates. Pages 1-41 in Cheeke, P. R., ed. Toxicants of plant origin. Vol. II. Glycosides. CRC Press, Inc., Boca Raton, Fla., USA. 277 pp.

Kingsbury, J. M. 1964. Poisonous plants of the United States and Canada. Prentice-Hall Inc., Englewood Cliffs, N.J., USA. 626 pp.

[Another search?](#)

[Français](#) | [Contact Us](#) | [Help](#) | [Search](#) | [Canada site](#)

[Coming Events](#) | [About CBIF](#) | [Links](#) | [Reports and Publications](#) |

[Home](#)

Date modified: 2003-02-06

[Important Notices](#)



Français	Contact us	Help	Search	Canada site
Coming events	About CBIF	Links	Reports and publications	Home

Canadian Biodiversity Information Facility



Notes on poisoning: *Asarum canadense*

[Introduction](#)[Interactive](#)[All poisonous plants by Botanical name](#)[All poisonous plants by Common name](#)[Important WWW Poisonous Plants sites](#)

General poisoning notes:

Wild ginger (*Asarum canadense*) is a native wildflower growing in rich woods in eastern Canada. This plant can cause dermatitis in some humans (Mitchell and Rook 1979).

References:



Mitchell, J. C., Rook, A. 1979. Botanical dermatology. Greenglass Ltd, Vancouver, B.C., Canada. 787 pp.

Nomenclature:

Scientific Name: *Asarum canadense* L.

Vernacular name(s): wild ginger

Scientific family name: *Aristolochiaceae*

Vernacular family name: birthwort

Go to ITIS^{*ca} for more taxonomic information on: [Asarum canadense](#)

References:

Agriculture Quebec. 1975. Noms des maladies des plantes du Canada/ Names of plant diseases in Canada. , Quebec City, Que., Canada. 288 pp.

Alex, J. F., Cayouette, R., Mulligan, G. A. 1980. Common and botanical names of weeds in Canada/Noms populaire et scientifiques des plantes nuisibles du Canada. Revised. Agric. Can. Publ., Ottawa, Ont., Canada. 132 pp.

Bailey, L. H., Bailey, E. Z. 1976. Hortus third. Revised. MacMillan, New York, N.Y., USA. 1290 pp.

Scoggan, H. J. 1978, 1979. The flora of Canada. Nat. Mus. Nat. Sci. (Ottawa) Publ. Bot. 7(1)-7(4). 1711 pp.

Van Wijk, H. L. 1911. A dictionary of plant names. Martinus Nijhoff, The Hague, The Netherlands. 1444 pp.

Victorin, M. 1964. Flore Laurentienne. 2nd ed. Univ. Montreal, Montreal, Que., Canada. 952 pp.

Geographic Information

Manitoba

New Brunswick

Ontario

Quebec

References:

Bailey, L. H., Bailey, E. Z. 1976. Hortus third. Revised. MacMillan, New York, N.Y., USA. 1290 pp.

Boivin, B. 1966, 1967. Énumération des plantes du Canada. Provencheria 6. Nat. Can. (Que.) 93: 253-274; 371-437; 583-646; 989-1063. 94: 131-157; 471-528; 625-655.

Image or illustration

Asarum canadense:

Images: images.google.com

Toxic parts:

leaves

References:

Mitchell, J. C., Rook, A. 1979. Botanical dermatology. Greenglass Ltd, Vancouver, B.C., Canada. 787 pp.

Animals/Human Poisoning:

Note: When an animal is listed without additional information, the literature (as of 1993) contained no detailed explanation.

Humans

[Another search?](#)

[Français](#) | [Contact Us](#) | [Help](#) | [Search](#) | [Canada site](#)
[Coming Events](#) | [About CBIF](#) | [Links](#) | [Reports and Publications](#) |
[Home](#)

Date modified: 2003-02-06

[Important Notices](#)



Français	Contact us	Help	Search	Canada site
Coming events	About CBIF	Links	Reports and publications	Home

Canadian Biodiversity Information Facility



Notes on poisoning: *Asclepias speciosa*

[Introduction](#)[Interactive](#)[All poisonous plants by Botanical name](#)[All poisonous plants by Common name](#)[Important WWW Poisonous Plants sites](#)

General poisoning notes:

Showy milkweed (*Asclepias speciosa*) is a native plant found in dry rangelands in western Canada. The plant is poisonous to sheep and cattle. However, this plant is so distasteful to livestock that they ingest it only under extreme circumstances (Fleming et al. 1920)



References:

Fleming, C. E., Peterson, N. F., Miller, M. R., Vawter, L. R., Wright, L. H. 1920. The narrow-leaved milkweed and the broad-leaved or showy milkweed. Plants poisonous to livestock in Nevada. Univ. Nev. Agric. Exp. Stn. Bull., 99. 32 pp.

Nomenclature:

Scientific Name: *Asclepias speciosa* Torr.

Vernacular name(s): showy milkweed

Scientific family name: *Asclepiadaceae*

Vernacular family name: milkweed

Go to ITIS*^{ca} for more taxonomic information on: [Asclepias speciosa](#)

References:

Agriculture Quebec. 1975. Noms des maladies des plantes du Canada/ Names of plant diseases in Canada. , Quebec City, Que., Canada. 288 pp.

Alex, J. F., Cayouette, R., Mulligan, G. A. 1980. Common and botanical names of weeds in Canada/Noms populaire et scientifiques des plantes nuisibles du Canada. Revised. Agric.

Can. Publ., Ottawa, Ont., Canada. 132 pp.

Bailey, L. H., Bailey, E. Z. 1976. Hortus third. Revised. MacMillan, New York, N.Y., USA. 1290 pp.

Scoggan, H. J. 1978, 1979. The flora of Canada. Nat. Mus. Nat. Sci. (Ottawa) Publ. Bot. 7(1)-7(4). 1711 pp.

Van Wijk, H. L. 1911. A dictionary of plant names. Martinus Nijhoff, The Hague, The Netherlands. 1444 pp.

Victorin, M. 1964. Flore Laurentienne. 2nd ed. Univ. Montreal, Montreal, Que., Canada. 952 pp.

Geographic Information

Alberta
British Columbia
Manitoba
Saskatchewan

References:

Bailey, L. H., Bailey, E. Z. 1976. Hortus third. Revised. MacMillan, New York, N.Y., USA. 1290 pp.

Boivin, B. 1966, 1967. Énumération des plantes du Canada. Provencheria 6. Nat. Can. (Que.) 93: 253-274; 371-437; 583-646; 989-1063. 94: 131-157; 471-528; 625-655.

Image or illustration

Asclepias speciosa:

Images: images.google.com

Notes on Poisonous plant parts:

Experimental feeding tests on sheep showed that leaves are poisonous, but that large amounts must be ingested: (a 43-kg ewe died after ingesting 1 kg of green leaves. The pods and seeds are also poisonous (Fleming et al. 1920).

Toxic parts:

leaves
mature fruit
seeds

References:

Fleming, C. E., Peterson, N. F., Miller, M. R., Vawter, L. R., Wright, L. H. 1920. The narrow-leaved milkweed and the broad-leaved or showy milkweed. Plants poisonous to livestock in Nevada. Univ. Nev. Agric. Exp. Stn. Bull., 99. 32 pp.

Toxic plant chemicals:

desglucosyrioside
syrioside

References:

Joubert, J. P. 1989. Cardiac glycosides. Pages 61-97 in Cheeke, P. R., ed. Toxicants of plant origin. Vol. II. Glycosides. CRC Press, Inc., Boca Raton, Fla., USA. 277 pp.

Animals/Human Poisoning:

Note: When an animal is listed without additional information, the literature (as of 1993) contained no detailed explanation.

Cattle

Sheep

General symptoms of poisoning:

[appetite, loss of](#)
[breathing, labored](#)
[breathing with grunts](#)
[recumbency](#)

References:

Fleming, C. E., Peterson, N. F., Miller, M. R., Vawter, L. R., Wright, L. H. 1920. The narrow-leaved milkweed and the broad-leaved or showy milkweed. Plants poisonous to livestock in Nevada. Univ. Nev. Agric. Exp. Stn. Bull., 99. 32 pp.

[Another search?](#)

[Français](#) | [Contact Us](#) | [Help](#) | [Search](#) | [Canada site](#)
[Coming Events](#) | [About CBIF](#) | [Links](#) | [Reports and Publications](#) | [Home](#)

Date modified: 2003-02-06

[Important Notices](#)



Français	Contact us	Help	Search	Canada site
Coming events	About CBIF	Links	Reports and publications	Home

Canadian Biodiversity Information Facility



Notes on poisoning: *Asclepias syriaca*

[Introduction](#)[Interactive](#)[All poisonous plants by Botanical name](#)[All poisonous plants by Common name](#)[Important WWW Poisonous Plants sites](#)

General poisoning notes:

Common milkweed (*Asclepias syriaca*) is a native perennial herb found in eastern Canada in fields, ditches, and waste places. This plant has poisoned sheep in the eastern United States. The plant contains cardiac glycosides, which are toxic to animals (Reynard and Norton, Joubert 1989).



References:

Joubert, J. P. 1989. Cardiac glycosides. Pages 61-97 in Cheeke, P. R., ed. Toxicants of plant origin. Vol. II. Glycosides. CRC Press, Inc., Boca Raton, Fla., USA. 277 pp.

Reynard, G. B., Norton, J. B. 1942. Poisonous plants of Maryland in relation to livestock. Univ. MD. Agric. Exp. Stn. Bull., A10. 312 pp.

Nomenclature:

Scientific Name: *Asclepias syriaca* L.

Vernacular name(s): common milkweed

Scientific family name: *Asclepiadaceae*

Vernacular family name: milkweed

Go to ITIS*^{ca} for more taxonomic information on: [Asclepias syriaca](#)

References:

Agriculture Quebec. 1975. Noms des maladies des plantes du Canada/ Names of plant diseases in Canada. , Quebec City, Que., Canada. 288 pp.

Alex, J. F., Cayouette, R., Mulligan, G. A. 1980. Common and botanical names of weeds in Canada/Noms populaire et scientifiques des plantes nuisibles du Canada. Revised. Agric. Can. Publ., Ottawa, Ont., Canada. 132 pp.

Bailey, L. H., Bailey, E. Z. 1976. Hortus third. Revised. MacMillan, New York, N.Y., USA. 1290 pp.

Scoggan, H. J. 1978, 1979. The flora of Canada. Nat. Mus. Nat. Sci. (Ottawa) Publ. Bot. 7(1)-7(4). 1711 pp.

Van Wijk, H. L. 1911. A dictionary of plant names. Martinus Nijhoff, The Hague, The Netherlands. 1444 pp.

Victorin, M. 1964. Flore Laurentienne. 2nd ed. Univ. Montreal, Montreal, Que., Canada. 952 pp.

Geographic Information

Manitoba
New Brunswick
Nova Scotia
Ontario
Prince Edward Island
Quebec

References:

Bailey, L. H., Bailey, E. Z. 1976. Hortus third. Revised. MacMillan, New York, N.Y., USA. 1290 pp.

Boivin, B. 1966, 1967. Énumération des plantes du Canada. Provencheria 6. Nat. Can. (Que.) 93: 253-274; 371-437; 583-646; 989-1063. 94: 131-157; 471-528; 625-655.

Image or illustration

Asclepias syriaca:

Images: images.google.com

Toxic parts:

latex
leaves
stems

References:

Joubert, J. P. 1989. Cardiac glycosides. Pages 61-97 in Cheeke, P. R., ed. Toxicants of plant origin. Vol. II. Glycosides. CRC

Press, Inc., Boca Raton, Fla., USA. 277 pp.

Toxic plant chemicals:

desglucosyrioside
syrioboside
syrioside

References:

Joubert, J. P. 1989. Cardiac glycosides. Pages 61-97 in Cheeke, P. R., ed. Toxicants of plant origin. Vol. II. Glycosides. CRC Press, Inc., Boca Raton, Fla., USA. 277 pp.

Animals/Human Poisoning:

Note: When an animal is listed without additional information, the literature (as of 1993) contained no detailed explanation.

Sheep

General symptoms of poisoning:

[death](#)

Notes on poisoning:

A dozen sheep died after ingesting large amounts of common milkweed in Maryland. The plants, which were almost the only vegetation available during a drought, are normally distasteful to livestock (Reynard and Norton 1942).

References:

Reynard, G. B., Norton, J. B. 1942. Poisonous plants of Maryland in relation to livestock. Univ. MD. Agric. Exp. Stn. Bull., A10. 312 pp.

[Another search?](#)

[Français](#) | [Contact Us](#) | [Help](#) | [Search](#) | [Canada site](#)

[Coming Events](#) | [About CBIF](#) | [Links](#) | [Reports and Publications](#) |

[Home](#)

Date modified: 2003-02-06

[Important Notices](#)



Français	Contact us	Help	Search	Canada site
Coming events	About CBIF	Links	Reports and publications	Home

Canadian Biodiversity Information Facility



Notes on poisoning: *Asclepias verticillata*

[Introduction](#)[Interactive](#)[All poisonous plants by Botanical name](#)[All poisonous plants by Common name](#)[Important WWW Poisonous Plants sites](#)

General poisoning notes:

Eastern whorled milkweed (*Asclepias verticillata*) is a native plant found in fields in parts of southern Canada. It has caused poisoning in experimental feeding tests in sheep. Large quantities of fresh plant were administered with a balling gun at about 2.2% of body weight, causing symptoms of poisoning (Marsh and Clawson 1921). The early literature is rife with contradictions in determining the scientific names of various milkweeds. *Asclepias verticillata* was termed *Asclepias verticillata* var. *geyeri* in Marsh and Clawson (1921). For more information on *Asclepias* taxonomy see Woodson (1954).

References:

Clark, J. G. 1979. Whorled milkweed poisoning. Vet. Hum. Toxicol., 21: 431.

Marsh, C. D., Clawson, A. B. 1921. Poisonous properties of the whorled milkweeds *Asclepias pumila* and *A. verticillata* var. *geyeri*. U. S. Dept. Agric. Bull., 942. 14 pp.

Woodson, R. E. 1954. The North American species of *Asclepias* L. Ann. Mo. Bot. Gard., 41: 1-211.

Nomenclature:

Scientific Name: *Asclepias verticillata* L.

Vernacular name(s): eastern whorled milkweed

Scientific family name: *Asclepiadaceae*

Vernacular family name: milkweed

Go to ITIS*^{ca} for more taxonomic information on: [Asclepias verticillata](#)

References:

Agriculture Quebec. 1975. Noms des maladies des plantes du Canada/ Names of plant diseases in Canada. , Quebec City, Que., Canada. 288 pp.

Alex, J. F., Cayouette, R., Mulligan, G. A. 1980. Common and botanical names of weeds in Canada/Noms populaire et scientifiques des plantes nuisibles du Canada. Revised. Agric. Can. Publ., Ottawa, Ont., Canada. 132 pp.

Bailey, L. H., Bailey, E. Z. 1976. Hortus third. Revised. MacMillan, New York, N.Y., USA. 1290 pp.

Scoggan, H. J. 1978, 1979. The flora of Canada. Nat. Mus. Nat. Sci. (Ottawa) Publ. Bot. 7(1)-7(4). 1711 pp.

Van Wijk, H. L. 1911. A dictionary of plant names. Martinus Nijhoff, The Hague, The Netherlands. 1444 pp.

Victorin, M. 1964. Flore Laurentienne. 2nd ed. Univ. Montreal, Montreal, Que., Canada. 952 pp.

Geographic Information

Manitoba

Ontario

Saskatchewan

References:

Bailey, L. H., Bailey, E. Z. 1976. Hortus third. Revised. MacMillan, New York, N.Y., USA. 1290 pp.

Boivin, B. 1966, 1967. Énumération des plantes du Canada. Provencheria 6. Nat. Can. (Que.) 93: 253-274; 371-437; 583-646; 989-1063. 94: 131-157; 471-528; 625-655.

Image or illustration

Asclepias verticillata:

Images: images.google.com

Toxic parts:

flower buds

leaves

References:

Clark, J. G. 1979. Whorled milkweed poisoning. *Vet. Hum. Toxicol.*, 21: 431.

Toxic plant chemicals:

galitoxin

References:

Clark, J. G. 1979. Whorled milkweed poisoning. *Vet. Hum. Toxicol.*, 21: 431.

Animals/Human Poisoning:

Note: When an animal is listed without additional information, the literature (as of 1993) contained no detailed explanation.

Sheep

General symptoms of poisoning:

[agitation](#)

[bloat](#)

[breathing, labored](#)

[convulsions](#)

[death](#)

[depression](#)

[opisthotonos](#)

[pupil dilation](#)

[temperature, elevated](#)

[trembling](#)

[weakness, posterior](#)

Notes on poisoning:

Experimental feeding of fresh eastern whorled milkweed caused poisoning in sheep. The animals fell down and went through characteristic running movements. The head and jaws occasionally moved compulsively. The pulse was often weak. Ingesting 2.2% of body weight was necessary to produce serious poisoning in sheep. Animals do not normally eat these distasteful plants or other milkweeds (Marsh and Clawson 1921).

References:

Clark, J. G. 1979. Whorled milkweed poisoning. *Vet. Hum.*

Toxicol., 21: 431.

Marsh, C. D., Clawson, A. B. 1921. Poisonous properties of the whorled milkweeds *Asclepias pumila* and *A. verticillata* var. *geyeri*. U. S. Dept. Agric. Bull., 942. 14 pp.

[Another search?](#)

[Français](#) | [Contact Us](#) | [Help](#) | [Search](#) | [Canada site](#)

[Coming Events](#) | [About CBIF](#) | [Links](#) | [Reports and Publications](#) |

[Home](#)

Date modified: 2003-02-06

[Important Notices](#)



Français	Contact us	Help	Search	Canada site
Coming events	About CBIF	Links	Reports and publications	Home

Canadian Biodiversity Information Facility



Notes on poisoning: *Asimina triloba*

[Introduction](#)[Interactive](#)[All poisonous plants by Botanical name](#)[All poisonous plants by Common name](#)[Important WWW Poisonous Plants sites](#)

General poisoning notes:

Pawpaw (*Asimina triloba*) is a native tree found in southwestern Ontario. The tree has edible fruit that has caused dermatitis in some individuals and can also cause severe gastroenteritis when it is ingested. This tree has limited distribution in southwestern Ontario (Kingsbury 1964).



References:

Kingsbury, J. M. 1964. Poisonous plants of the United States and Canada. Prentice-Hall Inc., Englewood Cliffs, N.J., USA. 626 pp.

Nomenclature:

Scientific Name: *Asimina triloba* (L.) Dunal

Vernacular name(s): pawpaw

Scientific family name: *Annonaceae*

Vernacular family name: custard-apple

Go to ITIS^{*ca} for more taxonomic information on: [Asimina triloba](#)

References:

Agriculture Quebec. 1975. Noms des maladies des plantes du Canada/ Names of plant diseases in Canada. , Quebec City, Que., Canada. 288 pp.

Alex, J. F., Cayouette, R., Mulligan, G. A. 1980. Common and botanical names of weeds in Canada/Noms populaire et scientifiques des plantes nuisibles du Canada. Revised. Agric. Can. Publ., Ottawa, Ont., Canada. 132 pp.

Bailey, L. H., Bailey, E. Z. 1976. Hortus third. Revised. MacMillan, New York, N.Y., USA. 1290 pp.

Scoggan, H. J. 1978, 1979. The flora of Canada. Nat. Mus. Nat. Sci. (Ottawa) Publ. Bot. 7(1)-7(4). 1711 pp.

Van Wijk, H. L. 1911. A dictionary of plant names. Martinus Nijhoff, The Hague, The Netherlands. 1444 pp.

Victorin, M. 1964. Flore Laurentienne. 2nd ed. Univ. Montreal, Montreal, Que., Canada. 952 pp.

Geographic Information

Ontario

References:

Bailey, L. H., Bailey, E. Z. 1976. Hortus third. Revised. MacMillan, New York, N.Y., USA. 1290 pp.

Boivin, B. 1966, 1967. Énumération des plantes du Canada. Provencheria 6. Nat. Can. (Que.) 93: 253-274; 371-437; 583-646; 989-1063. 94: 131-157; 471-528; 625-655.

Image or illustration

Asimina triloba:

Images: images.google.com

Toxic parts:

mature fruit

References:

Kingsbury, J. M. 1964. Poisonous plants of the United States and Canada. Prentice-Hall Inc., Englewood Cliffs, N.J., USA. 626 pp.

Animals/Human Poisoning:

Note: When an animal is listed without additional information, the literature (as of 1993) contained no detailed explanation.

Humans

[Another search?](#)

[Français](#) | [Contact Us](#) | [Help](#) | [Search](#) | [Canada site](#)
[Coming Events](#) | [About CBIF](#) | [Links](#) | [Reports and Publications](#) |
[Home](#)

Date modified: 2003-02-06

[Important Notices](#)



Français	Contact us	Help	Search	Canada site
Coming events	About CBIF	Links	Reports and publications	Home

Canadian Biodiversity Information Facility



Notes on poisoning: *Astragalus adsurgens*

[Introduction](#)[Interactive](#)[All poisonous plants by Botanical name](#)[All poisonous plants by Common name](#)[Important WWW Poisonous Plants sites](#)

General poisoning notes:

Astragalus adsurgens is a native herb found across western Canada. This plant has the potential to accumulate toxic levels of selenium, which would cause symptoms in cattle and probably other livestock. Cases of livestock poisoned by this plant could not be found in the literature.



References:

Davis, A. M. 1986. Selenium uptake in *Astragalus* and *Lupinus* species. *Agron. J.*, 78: 727-729.

Nomenclature:

Scientific Name: *Astragalus adsurgens* Pall.

Vernacular name(s): *Astragalus* (*A. adsurgens*)

Scientific family name: *Leguminosae*

Vernacular family name: pea

Go to ITIS*^{ca} for more taxonomic information on: [Astragalus adsurgens](#)

References:

Agriculture Quebec. 1975. Noms des maladies des plantes du Canada/ Names of plant diseases in Canada. , Quebec City, Que., Canada. 288 pp.

Alex, J. F., Cayouette, R., Mulligan, G. A. 1980. Common and botanical names of weeds in Canada/Noms populaire et scientifiques des plantes nuisibles du Canada. Revised. Agric. Can. Publ., Ottawa, Ont., Canada. 132 pp.

Bailey, L. H., Bailey, E. Z. 1976. Hortus third. Revised. MacMillan, New York, N.Y., USA. 1290 pp.

Scoggan, H. J. 1978, 1979. The flora of Canada. Nat. Mus. Nat. Sci. (Ottawa) Publ. Bot. 7(1)-7(4). 1711 pp.

Van Wijk, H. L. 1911. A dictionary of plant names. Martinus Nijhoff, The Hague, The Netherlands. 1444 pp.

Victorin, M. 1964. Flore Laurentienne. 2nd ed. Univ. Montreal, Montreal, Que., Canada. 952 pp.

Geographic Information

Alberta
British Columbia
Manitoba
Northwest Territories
Ontario
Saskatchewan

References:

Bailey, L. H., Bailey, E. Z. 1976. Hortus third. Revised. MacMillan, New York, N.Y., USA. 1290 pp.

Boivin, B. 1966, 1967. Énumération des plantes du Canada. Provencheria 6. Nat. Can. (Que.) 93: 253-274; 371-437; 583-646; 989-1063. 94: 131-157; 471-528; 625-655.

Image or illustration

Astragalus adsurgens:

Images: images.google.com

Toxic parts:

leaves
stems

References:

Davis, A. M. 1986. Selenium uptake in *Astragalus* and *Lupinus* species. Agron. J., 78: 727-729.

Notes on Toxic plant chemicals:

Astragalus adsurgens has been found to accumulate selenium well above the minimum amount of 5 mg/kg required for the

existence of selenium poisoning in sheep and cattle. Some plants collected in Canada contained 44 mg/kg of selenium (Davis 1986).

Toxic plant chemicals:

selenium

References:

Davis, A. M. 1986. Selenium uptake in *Astragalus* and *Lupinus* species. *Agron. J.*, 78: 727-729.

Animals/Human Poisoning:

Note: When an animal is listed without additional information, the literature (as of 1993) contained no detailed explanation.

Cattle

[Another search?](#)

[Français](#) | [Contact Us](#) | [Help](#) | [Search](#) | [Canada site](#)

[Coming Events](#) | [About CBIF](#) | [Links](#) | [Reports and Publications](#) |

[Home](#)

Date modified: 2003-02-06

[Important Notices](#)



Français	Contact us	Help	Search	Canada site
Coming events	About CBIF	Links	Reports and publications	Home

Canadian Biodiversity Information Facility



Notes on poisoning: *Astragalus bisulcatus*

[Introduction](#)[Interactive](#)[All poisonous plants by Botanical name](#)[All poisonous plants by Common name](#)[Important WWW Poisonous Plants sites](#)

General poisoning notes:

Two-grooved milk-vetch (*Astragalus bisulcatus*) is a native plant found on rangelands in western Canada. This plant can accumulate quantities of selenium high enough to cause toxicity in cattle, horses, sheep, and swine. High quantities of selenium cause acute toxicity, with symptoms including staggering, diarrhea, prostration, and abdominal pain. Plants that contain a selenium content of less than 200 ppm cause chronic toxicity. James et al.(1983) used this plant (selenium content of 180 ppm) to conduct feeding experiments on sheep. They found that the symptoms and microscopic lesions of tissues collected from the sheep were similar to those caused by locoweed poisoning and not selenium poisoning. This finding suggests that other toxic compounds in addition to selenium may be present.

Swainsonine is also found in this plant, which may explain why, in experiments, sheep exhibited symptoms more appropriate to locoism than to selenium poisoning (Cheeke and Schull 1985).

References:

Baker, D. C., James, L. F., Panter, K. E., Mayland, H. F., Pfister, J. A. 1987. Selenosis in developing pigs fed selenium from different sources. Am . Soc. Anim. Sci. Abstr., 65: 351.

Cheeke, P. R., Shull, L. R. 1985. Natural toxicants in feeds and poisonous plants. AVI Publishing Company, Inc., Westport, Conn., USA. 492 pp.

James, L. F., Van Kampen, K. V., Hartley, W. J. 1983. *Astragalus bisulcatus*--a cause of selenium or locoweed poisoning? Vet. Hum. Toxicol., 25: 86-89.

Nomenclature:

Scientific Name: *Astragalus bisulcatus* (Hook.) A. Gray

Vernacular name(s): two-grooved milk-vetch

Scientific family name: *Leguminosae*

Vernacular family name: pea

Go to ITIS^{*ca} for more taxonomic information on: [Astragalus bisulcatus](#)

References:

Agriculture Quebec. 1975. Noms des maladies des plantes du Canada/ Names of plant diseases in Canada. , Quebec City, Que., Canada. 288 pp.

Alex, J. F., Cayouette, R., Mulligan, G. A. 1980. Common and botanical names of weeds in Canada/Noms populaire et scientifiques des plantes nuisibles du Canada. Revised. Agric. Can. Publ., Ottawa, Ont., Canada. 132 pp.

Bailey, L. H., Bailey, E. Z. 1976. Hortus third. Revised. MacMillan, New York, N.Y., USA. 1290 pp.

Scoggan, H. J. 1978, 1979. The flora of Canada. Nat. Mus. Nat. Sci. (Ottawa) Publ. Bot. 7(1)-7(4). 1711 pp.

Van Wijk, H. L. 1911. A dictionary of plant names. Martinus Nijhoff, The Hague, The Netherlands. 1444 pp.

Victorin, M. 1964. Flore Laurentienne. 2nd ed. Univ. Montreal, Montreal, Que., Canada. 952 pp.

Geographic Information

Alberta

Manitoba

Saskatchewan

References:

Bailey, L. H., Bailey, E. Z. 1976. Hortus third. Revised. MacMillan, New York, N.Y., USA. 1290 pp.

Boivin, B. 1966, 1967. Énumération des plantes du Canada. Provencheria 6. Nat. Can. (Que.) 93: 253-274; 371-437; 583-646; 989-1063. 94: 131-157; 471-528; 625-655.

Image or illustration

Astragalus bisulcatus:

Images: images.google.com

Toxic parts:

flowers
leaves
stems

References:

James, L. F., Van Kampen, K. V., Hartley, W. J. 1983. *Astragalus bisulcatus*--a cause of selenium or locoweed poisoning? *Vet. Hum. Toxicol.*, 25: 86-89.

Notes on Toxic plant chemicals:

This plant is a recognized selenium accumulator. Selenium has been found to be toxic to sheep and cattle at levels of 4-5 mg/kg of dry matter. Two-grooved milk-vetch collected in Canada contained selenium at 43 mg/kg, well above the level required for toxicity (Davis 1986).

Toxic plant chemicals:

selenium
swainsonine

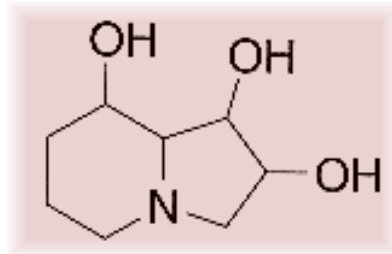

Chemical diagram(s) are courtesy of [Ruth McDiarmid](#), Biochemistry Technician, Kamloops Range Station, Agriculture and Agri-Food Canada, Kamloops, British Columbia, Canada.

References:

Cheeke, P. R., Shull, L. R. 1985. *Natural toxicants in feeds and poisonous plants*. AVI Publishing Company, Inc., Westport, Conn., USA. 492 pp.

Davis, A. M. 1986. Selenium uptake in *Astragalus* and *Lupinus* species. *Agron. J.*, 78: 727-729.

Animals/Human Poisoning:

Note: When an animal is listed without additional information, the literature (as of 1993) contained no detailed explanation.

Cattle

Horses

Sheep

General symptoms of poisoning:

[ascites](#)

[brain, vacuolation of](#)

[coat, rough and dry](#)

[cytoplasm vacuolation](#)

[depression](#)

[fetus, dead](#)

[kidney, vacuolation of](#)

References:

James, L. F., Van Kampen, K. V., Hartley, W. J. 1983.
Astragalus bisulcatus--a cause of selenium or locoweed poisoning? Vet. Hum. Toxicol., 25: 86-89.

Swine

[Another search?](#)

[Français](#) | [Contact Us](#) | [Help](#) | [Search](#) | [Canada site](#)

[Coming Events](#) | [About CBIF](#) | [Links](#) | [Reports and Publications](#) |

[Home](#)

Date modified: 2003-02-06

[Important Notices](#)



Français	Contact us	Help	Search	Canada site
Coming events	About CBIF	Links	Reports and publications	Home

Canadian Biodiversity Information Facility



Notes on poisoning: *Astragalus canadensis*

[Introduction](#)[Interactive](#)[All poisonous plants by Botanical name](#)[All poisonous plants by Common name](#)[Important WWW Poisonous Plants sites](#)

General poisoning notes:

Cattle have been fatally poisoned when fed on rangeland containing Canadian milk-vetch (*Astragalus canadensis*).

Experiments with sheep indicated that plant material must contain NO₂ at 250 mg/kg of body weight to produce toxic responses and 275 mg/kg body weight for a lethal dose. In week-old chicks, the LD-50 = 2 g of plant ingested (Williams and James 1975).

References:

Williams, C., James, L. F. 1975. Toxicity of nitro-containing *Astragalus* to sheep and chicks. *J. Range Manage.*, 28: 260-263.

Nomenclature:

Scientific Name: *Astragalus canadensis* L.

Vernacular name(s): Canadian milk-vetch

Scientific family name: *Leguminosae*

Vernacular family name: pea

Go to ITIS^{*ca} for more taxonomic information on: [Astragalus canadensis](#)

References:

Agriculture Quebec. 1975. Noms des maladies des plantes du Canada/ Names of plant diseases in Canada. , Quebec City, Que., Canada. 288 pp.

Alex, J. F., Cayouette, R., Mulligan, G. A. 1980. Common and botanical names of weeds in Canada/Noms populaire et scientifiques des plantes nuisibles du Canada. Revised. Agric. Can. Publ., Ottawa, Ont., Canada. 132 pp.

Bailey, L. H., Bailey, E. Z. 1976. Hortus third. Revised. MacMillan, New York, N.Y., USA. 1290 pp.

Scoggan, H. J. 1978, 1979. The flora of Canada. Nat. Mus. Nat. Sci. (Ottawa) Publ. Bot. 7(1)-7(4). 1711 pp.

Van Wijk, H. L. 1911. A dictionary of plant names. Martinus Nijhoff, The Hague, The Netherlands. 1444 pp.

Victorin, M. 1964. Flore Laurentienne. 2nd ed. Univ. Montreal, Montreal, Que., Canada. 952 pp.

Geographic Information

Alberta
British Columbia
Manitoba
Northwest Territories
Ontario
Quebec
Saskatchewan

References:

Bailey, L. H., Bailey, E. Z. 1976. Hortus third. Revised. MacMillan, New York, N.Y., USA. 1290 pp.

Boivin, B. 1966, 1967. Énumération des plantes du Canada. Provencheria 6. Nat. Can. (Que.) 93: 253-274; 371-437; 583-646; 989-1063. 94: 131-157; 471-528; 625-655.

Image or illustration

Astragalus canadensis:

Images: images.google.com

Toxic parts:

flowers
leaves

References:

Williams, C., James, L. F. 1975. Toxicity of nitro-containing *Astragalus* to sheep and chicks. J. Range Manage., 28: 260-263.

Toxic plant chemicals:

3-nitropropionic acid

References:

Williams, C., James, L. F. 1975. Toxicity of nitro-containing *Astragalus* to sheep and chicks. *J. Range Manage.*, 28: 260-263.

Animals/Human Poisoning:

Note: When an animal is listed without additional information, the literature (as of 1993) contained no detailed explanation.

Cattle

General symptoms of poisoning:

[death](#)

References:

Williams, C., James, L. F. 1975. Toxicity of nitro-containing *Astragalus* to sheep and chicks. *J. Range Manage.*, 28: 260-263.

Sheep

[Another search?](#)

[Français](#) | [Contact Us](#) | [Help](#) | [Search](#) | [Canada site](#)

[Coming Events](#) | [About CBIF](#) | [Links](#) | [Reports and Publications](#) |

[Home](#)

Date modified: 2003-02-06

[Important Notices](#)



Français	Contact us	Help	Search	Canada site
Coming events	About CBIF	Links	Reports and publications	Home

Canadian Biodiversity Information Facility



Notes on poisoning: *Astragalus lentiginosus*

[Introduction](#)[Interactive](#)[All poisonous plants by Botanical name](#)[All poisonous plants by Common name](#)[Important WWW Poisonous Plants sites](#)

General poisoning notes:

Astragalus lentiginosus is a native plant found in south-central British Columbia. Ingesting the plant causes a variety of problems. Plants contain the alkaloid swainsonine, which can cause locoism. The common symptoms are impairment of the nervous system, depression, and excitement when disturbed. Teratogenic effects have also been noted in lambs and foals. At high altitudes (above 2120 m), cattle suffer from congestive heart failure (swainsonine influences the vascular system). This plant is a major poisonous range plant in the western United States. It is not abundant anywhere in Canada (Cheeke and Schull 1985, Panter et al. 1988).

References:

Cheeke, P. R., Shull, L. R. 1985. Natural toxicants in feeds and poisonous plants. AVI Publishing Company, Inc., Westport, Conn., USA. 492 pp.

James, L. F., Van Kampen, K. R. 1971. Effects of locoweed intoxication on the genital tract of the ram. *Am. J. Vet. Res.*, 32: 1253-1256.

LeGrande, C. E., James, L. F., McMullen, R. W., Panter, K. E. 1985. Reduced progesterone and altered cotyledonary prostaglandin values induced by locoweed (*Astragalus lentiginosus*) in sheep. *Am. J. Vet. Res.*, 46: 1903-1907.

Panter, K. E., Bunch, T. D., James, L. F., Sisson, D. V. 1987. Ultrasonographic imaging to monitor fetal and placental developments in ewes fed locoweed (*Astragalus lentiginosus*). *Am. J. Vet. Res.*, 48: 686-690.

Panter, K. E., James, L. F., Hartley, W. J. 1989. Transient testicular degeneration in rams fed locoweed (*Astragalus lentiginosus*). *Vet. Hum. Toxicol.*, 31: 42-46.

Panter, K. E., James, L. F., Nielson, D., Molyneux, R. J., Ralphs, M. H. 1988. The relationship of *Oxytropis sericea* (green and dry) and *Astragalus lentiginosus* with high mountain disease in cattle. *Vet. Hum. Toxicol.*, 30: 318-323.

Ralphs, M. H., Panter, K. E., James, L. F. 1990. Feed preferences and habituation of sheep poisoned by locoweed. *J. Anim. Sci.*, 68: 1354-1362.

Tulsiani, D. R., Broquist, H. P., James, L. F., Touster, O. 1984. The similar effects of swainsonine and locoweed on tissue glycosidases and oligosaccharides of the pig indicate that the alkaloid is the principal toxin for induction of locoism. *Arch. Biochem. Biophys.*, 232: 76-85.

Van Kampen, K. R., James, L. F. 1972. Sequential development of the lesions in locoweed poisoning. *Clin. Toxicol.*, 5: 575-580.

Nomenclature:

Scientific Name: *Astragalus lentiginosus* Dougl.

Vernacular name(s): Astragalus (A. lentiginosus)

Scientific family name: *Leguminosae*

Vernacular family name: pea

Go to ITIS*^{ca} for more taxonomic information on: [Astragalus lentiginosus](#)

References:

Agriculture Quebec. 1975. Noms des maladies des plantes du Canada/ Names of plant diseases in Canada. , Quebec City, Que., Canada. 288 pp.

Alex, J. F., Cayouette, R., Mulligan, G. A. 1980. Common and botanical names of weeds in Canada/Noms populaire et scientifiques des plantes nuisibles du Canada. Revised. Agric. Can. Publ., Ottawa, Ont., Canada. 132 pp.

Bailey, L. H., Bailey, E. Z. 1976. Hortus third. Revised. MacMillan, New York, N.Y., USA. 1290 pp.

Scoggan, H. J. 1978, 1979. The flora of Canada. Nat. Mus. Nat. Sci. (Ottawa) Publ. Bot. 7(1)-7(4). 1711 pp.

Van Wijk, H. L. 1911. A dictionary of plant names. Martinus Nijhoff, The Hague, The Netherlands. 1444 pp.

Victorin, M. 1964. Flore Laurentienne. 2nd ed. Univ. Montreal, Montreal, Que., Canada. 952 pp.

Geographic Information

British Columbia

References:

Bailey, L. H., Bailey, E. Z. 1976. Hortus third. Revised. MacMillan, New York, N.Y., USA. 1290 pp.

Boivin, B. 1966, 1967. Énumération des plantes du Canada. Provencheria 6. Nat. Can. (Que.) 93: 253-274; 371-437; 583-646; 989-1063. 94: 131-157; 471-528; 625-655.

Image or illustration

Astragalus lentiginosus:

Images: images.google.com

Toxic parts:

flowers

leaves

seeds

stems

References:

James, L. F., Van Kampen, K. R. 1971. Effects of locoweed intoxication on the genital tract of the ram. Am. J. Vet. Res., 32: 1253-1256.

LeGrande, C. E., James, L. F., McMullen, R. W., Panter, K. E. 1985. Reduced progesterone and altered cotyledonary prostaglandin values induced by locoweed (*Astragalus lentiginosus*) in sheep. Am. J. Vet. Res., 46: 1903-1907.

Panter, K. E., James, L. F., Hartley, W. J. 1989. Transient testicular degeneration in rams fed locoweed (*Astragalus lentiginosus*). Vet. Hum. Toxicol., 31: 42-46.

Panter, K. E., James, L. F., Nielson, D., Molyneux, R. J., Ralphs, M. H. 1988. The relationship of *Oxytropis sericea* (green and dry) and *Astragalus lentiginosus* with high mountain disease in cattle. Vet. Hum. Toxicol., 30: 318-323.

Tulsiani, D. R., Broquist, H. P., James, L. F., Touster, O. 1984. The similar effects of swainsonine and locoweed on tissue glycosidases and oligosaccharides of the pig indicate that the alkaloid is the principal toxin for induction of locoism. Arch. Biochem. Biophys., 232: 76-85.

Van Kampen, K. R., James, L. F. 1972. Sequential development of the lesions in locoweed poisoning. *Clin. Toxicol.*, 5: 575-580.

Notes on Toxic plant chemicals:

Swainsonine, the chemical involved in locoism, is found in several plants occurring in Canada, including *Astragalus bisulcatus*, *A. lentiginosus*, *Oxytropis lambertii*, and *O. sericea*. This indolizidine alkaloid causes locoism in cattle, horses, and sheep; it also causes teratogenic deformities in lambs, calves, and foals. In addition, at high altitudes (above 2120 m) it contributes to congenital heart failure in calves and cows (Cheeke and Schull 1985).

Toxic plant chemicals:

slaframine
swainsonine

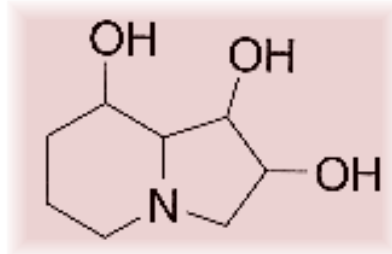

Chemical diagram(s) are courtesy of [Ruth McDiarmid](#), Biochemistry Technician, Kamloops Range Station, Agriculture and Agri-Food Canada, Kamloops, British Columbia, Canada.

References:

Cheeke, P. R., Shull, L. R. 1985. Natural toxicants in feeds and poisonous plants. AVI Publishing Company, Inc., Westport, Conn., USA. 492 pp.

Molyneux, R. J., James, L. F. 1982. Loco intoxication: indolizidine alkaloids of spotted locoweed (*Astragalus lentiginosus*). *Science (Wash. D. C.)*, 216: 190-191.

Tulsiani, D. R., Broquist, H. P., James, L. F., Touster, O. 1984. The similar effects of swainsonine and locoweed on tissue glycosidases and oligosaccharides of the pig indicate that the alkaloid is the principal toxin for induction of locoism. *Arch. Biochem. Biophys.*, 232: 76-85.

Animals/Human Poisoning:

Note: When an animal is listed without additional information, the literature (as of 1993) contained no detailed explanation.

Cattle

General symptoms of poisoning:

[abdominal edema](#)
[appetite, loss of](#)
[duodenum, edema of](#)
[gall bladder, enlarged](#)
[jaw \(lower\), edema of](#)
[thorax \(ventral\), edema](#)
[throat, edema of](#)
[ventricular\(right\), edema](#)

References:

Panter, K. E., James, L. F., Nielson, D., Molyneux, R. J., Ralphs, M. H. 1988. The relationship of *Oxytropis sericea* (green and dry) and *Astragalus lentiginosus* with high mountain disease in cattle. *Vet. Hum. Toxicol.*, 30: 318-323.

Horses

Sheep

General symptoms of poisoning:

[abortion](#)
[blisters, weeping](#)
[brain, vacuolation of](#)
[cytoplasm vacuolation](#)
[death](#)
[depression](#)
[eyes, dull](#)
[fetus, dead](#)
[gait, unsteady](#)
[heart rate, elevated](#)
[incoordination](#)
[kidney, congestion of](#)
[kidney, vacuolation of](#)
[lethargy](#)
[liver, congestion of](#)
[muscle, weakness of](#)
[sperm, detached tails](#)
[sperm mobility, poor](#)
[testicle degeneration](#)
[ventricular\(right\), edema](#)

[ventricle\(right\),round
weakness](#)

Notes on poisoning:

Astragalus lentiginosus caused fetal abortion in sheep and clinical signs of locoism in pregnant ewes. It also caused fluid accumulation in the placenta, altered cotyledonary development, and decreased fetal heart rates causing cardiac irregularity. At necropsy the fetuses had hypertrophy of the heart, right ventricular dilation, rounded apex of the heart, and generalized edema (Panter et al. 1987).

References:

James, L. F., Van Kampen, K. R. 1971. Effects of locoweed intoxication on the genital tract of the ram. *Am. J. Vet. Res.*, 32: 1253-1256.

LeGrande, C. E., James, L. F., McMullen, R. W., Panter, K. E. 1985. Reduced progesterone and altered cotyledonary prostaglandin values induced by locoweed (*Astragalus lentiginosus*) in sheep. *Am. J. Vet. Res.*, 46: 1903-1907.

Panter, K. E., Bunch, T. D., James, L. F., Sisson, D. V. 1987. Ultrasonographic imaging to monitor fetal and placental developments in ewes fed locoweed (*Astragalus lentiginosus*). *Am. J. Vet. Res.*, 48: 686-690.

Panter, K. E., James, L. F., Hartley, W. J. 1989. Transient testicular degeneration in rams fed locoweed (*Astragalus lentiginosus*). *Vet. Hum. Toxicol.*, 31: 42-46.

Ralphs, M. H., Panter, K. E., James, L. F. 1990. Feed preferences and habituation of sheep poisoned by locoweed. *J. Anim. Sci.*, 68: 1354-1362.

Van Kampen, K. R., James, L. F. 1972. Sequential development of the lesions in locoweed poisoning. *Clin. Toxicol.*, 5: 575-580.

Swine

General symptoms of poisoning:

[brain, vacuolation of
coat, rough and dry
cytoplasm vacuolation
depression
eyes, dull
incoordination
kidney, vacuolation of](#)

References:

Tulsiani, D. R., Broquist, H. P., James, L. F., Touster, O. 1984. The similar effects of swainsonine and locoweed on tissue glycosidases and oligosaccharides of the pig indicate that the alkaloid is the principal toxin for induction of locoism. Arch. Biochem. Biophys., 232: 76-85.

[Another search?](#)

[Français](#) | [Contact Us](#) | [Help](#) | [Search](#) | [Canada site](#)

[Coming Events](#) | [About CBIF](#) | [Links](#) | [Reports and Publications](#) |

[Home](#)

Date modified: 2003-02-06

[Important Notices](#)



Français	Contact us	Help	Search	Canada site
Coming events	About CBIF	Links	Reports and publications	Home

Canadian Biodiversity Information Facility



Notes on poisoning: *Astragalus miser*

[Introduction](#)[Interactive](#)[All poisonous plants by Botanical name](#)[All poisonous plants by Common name](#)[Important WWW Poisonous Plants sites](#)

General poisoning notes:

Timber milk-vetch (*Astragalus miser*) is a native herb that is found in southern British Columbia and southern Alberta. This plant causes acute and chronic toxicity in cattle and sheep. Experimental poisoning has been caused in other livestock. Honey bees that forage on the flowers of timber milk-vetch were also poisoned (Majak and Pass 1989).

References:



James, L. F., Hartley, W. J., Van Kampen, K. R. 1981. Syndromes of *Astragalus* poisoning in livestock. J. Am. Vet. Med. Assoc., 178: 146-150.

Majak, W., Neufeld, R., Corner, J. 1980. Toxicity of *Astragalus miser* v. *serotinus* to the honeybee. J. Apic. Res., 19: 196-199.

Majak, W., Pass, M. A. 1989. Aliphatic nitrocompounds. Pages 143-159 in Cheeke, P. R., ed. Toxicants of plant origin. Vol. II Glycosides. CRC Press, Inc., Boca Raton, Fla., USA. 277 pp.

Quinton, D. A., Majak, W., Hall, J. W. 1989. The effect of cattle grazing on the growth and miserotoxin content of Columbia milkvetch. J. Range Manage., 42: 368-371.

Nomenclature:

Scientific Name: *Astragalus miser* Dougl. ex Hook.

Vernacular name(s): timber milk-vetch

Scientific family name: *Leguminosae*

Vernacular family name: pea

Go to ITIS*^{ca} for more taxonomic information on: [Astragalus miser](#)

References:

- Agriculture Quebec. 1975. Noms des maladies des plantes du Canada/ Names of plant diseases in Canada. , Quebec City, Que., Canada. 288 pp.
- Alex, J. F., Cayouette, R., Mulligan, G. A. 1980. Common and botanical names of weeds in Canada/Noms populaire et scientifiques des plantes nuisibles du Canada. Revised. Agric. Can. Publ., Ottawa, Ont., Canada. 132 pp.
- Bailey, L. H., Bailey, E. Z. 1976. Hortus third. Revised. MacMillan, New York, N.Y., USA. 1290 pp.
- Scoggan, H. J. 1978, 1979. The flora of Canada. Nat. Mus. Nat. Sci. (Ottawa) Publ. Bot. 7(1)-7(4). 1711 pp.
- Van Wijk, H. L. 1911. A dictionary of plant names. Martinus Nijhoff, The Hague, The Netherlands. 1444 pp.
- Victorin, M. 1964. Flore Laurentienne. 2nd ed. Univ. Montreal, Montreal, Que., Canada. 952 pp.

Geographic Information

Alberta
British Columbia

References:

- Bailey, L. H., Bailey, E. Z. 1976. Hortus third. Revised. MacMillan, New York, N.Y., USA. 1290 pp.
- Boivin, B. 1966, 1967. Énumération des plantes du Canada. Provencheria 6. Nat. Can. (Que.) 93: 253-274; 371-437; 583-646; 989-1063. 94: 131-157; 471-528; 625-655.

Image or illustration

Astragalus miser:

Images: images.google.com

Notes on Poisonous plant parts:

Timber milk-vetch contains miserotoxin. This toxic principle is found primarily in the leaves and reaches its highest concentration during the bud and mature-flower stages of growth. The levels drop rapidly when leaves dry. Herbicides bleach leaves and cause a reduction in the concentration of miserotoxin. Tests with fertilizer on range plants showed that use of urea (nitrogen at 200 kg/ha)

increased the level of miserotoxin during the second year of fertilizer use on a clearcut site. Use of urea (nitrogen at 100 kg/ha) on grassland sites did not affect miserotoxin levels (Cheeke and Schull 1985; Majak and Wikeem 1986).

Toxic parts:

leaves
stems

References:

Cheeke, P. R., Shull, L. R. 1985. Natural toxicants in feeds and poisonous plants. AVI Publishing Company, Inc., Westport, Conn., USA. 492 pp.

Quinton, D. A., Majak, W., Hall, J. W. 1989. The effect of cattle grazing on the growth and miserotoxin content of Columbia milkvetch. *J. Range Manage.*, 42: 368-371.

Notes on Toxic plant chemicals:

The glycoside (3-nitro-1-propyl-beta-D-glucopyranoside), called miserotoxin, is the poisonous principle in timber milk-vetch. Other toxic chemicals have been found including the following:

3-nitro-1-propyl-beta-D-gentiobioside (called gentitoxin)
3-nitropropyl-beta-D-allolactoside.

Miserotoxin is rapidly hydrolysed by rumen organisms. The acute toxic effect is related to methemoglobinemia, where hemoglobin is oxidized by nitrite (Cheeke and Schull 1985, Majak et al. 1988).

Miserotoxin is not converted to NPA (3-nitro-1-propionic acid) in the digestive tract of nonruminants. Cattle and sheep can be intoxicated by feeding the chemical NPOH (3-nitro-1-propanal) at 20-60 mg/kg of body weight. NPOH is lethal at 30-35 mg/kg in cattle when fed intravenously:

LD-50 » 77 mg/kg for oral acute toxicity in rats
LD-50 » 25 mg/kg for chronic toxicity in rats fed twice daily for several days.

The acute and chronic syndromes were caused experimentally in rats, pigs, chicks, pigeons, rabbits, and mice (Majak and Pass 1989).

Toxic plant chemicals:

miserotoxin

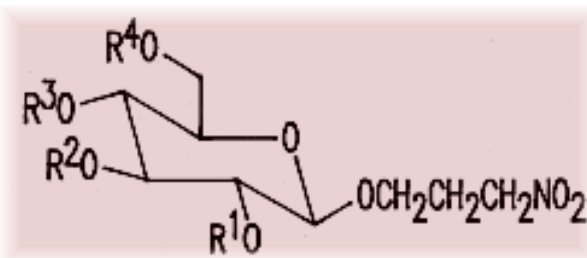

3-nitropropanol

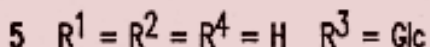
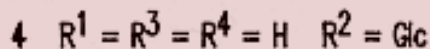
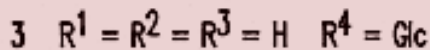
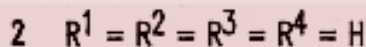

Chemical diagram(s) are courtesy of [Ruth McDiarmid](#), Biochemistry Technician, Kamloops Range Station, Agriculture and Agri-Food Canada, Kamloops, British Columbia, Canada.

References:

Cheeke, P. R., Shull, L. R. 1985. Natural toxicants in feeds and poisonous plants. AVI Publishing Company, Inc., Westport, Conn., USA. 492 pp.

James, L. F., Hartley, W. J., Van Kampen, K. R. 1981. Syndromes of *Astragalus* poisoning in livestock. J. Am. Vet. Med. Assoc., 178: 146-150.

Majak, W., Benn, M. H., Huang, Y. Y. 1988. A new glycoside of 3-nitropropanol from *Astragalus miser* var. *serotinus*. J. Nat. Prod. (Lloydia), 51: 985-988.

Majak, W., Pass, M. A. 1989. Aliphatic nitrocompounds. Pages 143-159 in Cheeke, P. R., ed. Toxicants of plant origin. Vol. II Glycosides. CRC Press, Inc., Boca Raton, Fla., USA. 277 pp.

Quinton, D. A., Majak, W., Hall, J. W. 1989. The effect of cattle grazing on the growth and miserotoxin content of Columbia milkvetch. J. Range Manage., 42: 368-371.

Animals/Human Poisoning:

Note: When an animal is listed without additional information, the literature (as of 1993) contained no detailed explanation.

Cattle

General symptoms of poisoning:

[breathing, labored](#)

[collapse](#)

[cyanosis](#)

[death](#)

[emphysema](#)

[incoordination](#)

[liver, congestion of
muscle, weakness of
weakness](#)

Notes on poisoning:

Cattle that have ingested timber milk-vetch can suffer from acute syndrome, in which a rapid onset with death occurs a few hours to a day after ingestion. Chronically affected animals have liver damage, emphysema, Wallerian degeneration of the spinal cord and peripheral nerves, and focal hemorrhages in the brain. Lactating animals are most susceptible to the toxin (Majak and Pass 1989).

References:

James, L. F., Hartley, W. J., Van Kampen, K. R. 1981. Syndromes of *Astragalus* poisoning in livestock. J. Am. Vet. Med. Assoc., 178: 146-150.

Majak, W., Pass, M. A. 1989. Aliphatic nitrocompounds. Pages 143-159 in Cheeke, P. R., ed. Toxicants of plant origin. Vol. II Glycosides. CRC Press, Inc., Boca Raton, Fla., USA. 277 pp.

Honey bees

General symptoms of poisoning:

[death](#)

[incoordination](#)

[weakness](#)

Notes on poisoning:

Honey bees were poisoned after ingesting the nectar of timber milk-vetch. Sickness and death occur with 0.1-0.8% daily mortality rate of the hive population. In experiments, 2.5% miserotoxin in a 50% sugar solution killed 100% of bees within 48 h. Poisoned bees were unable to fly, and dead bees were usually seen with the wings extended and the proboscis protruding (Majak et al. 1980).

References:

Majak, W., Neufeld, R., Corner, J. 1980. Toxicity of *Astragalus*

miser v. *serotinus* to the honeybee. J. Apic. Res., 19: 196-199.

Majak, W., Pass, M. A. 1989. Aliphatic nitrocompounds. Pages 143-159 in Cheeke, P. R., ed. Toxicants of plant origin. Vol. II Glycosides. CRC Press, Inc., Boca Raton, Fla., USA. 277 pp.

Horses

Sheep

General symptoms of poisoning:

[breathing, labored](#)

[cyanosis](#)

[death](#)

[incoordination](#)

Notes on poisoning:

Sheep often collapse and die from acute miserotoxin poisoning after exhibiting few clinical signs. In sheep the respiratory signs of chronic poisoning are more prominent than the nervous system signs. The animals lose weight and develop respiratory distress, hind limb paresis, nasal discharge, and a roaring sound. Lactating sheep are more susceptible to intoxication than nonlactating ones (Majak and Pass 1989).

References:

James, L. F., Hartley, W. J., Van Kampen, K. R. 1981. Syndromes of *Astragalus* poisoning in livestock. J. Am. Vet. Med. Assoc., 178: 146-150.

Majak, W., Pass, M. A. 1989. Aliphatic nitrocompounds. Pages 143-159 in Cheeke, P. R., ed. Toxicants of plant origin. Vol. II Glycosides. CRC Press, Inc., Boca Raton, Fla., USA. 277 pp.

[Another search?](#)

[Français](#) | [Contact Us](#) | [Help](#) | [Search](#) | [Canada site](#)

[Coming Events](#) | [About CBIF](#) | [Links](#) | [Reports and Publications](#) |

[Home](#)

Date modified: 2003-02-06

[Important Notices](#)



Français	Contact us	Help	Search	Canada site
Coming events	About CBIF	Links	Reports and publications	Home

Canadian Biodiversity Information Facility



Notes on poisoning: *Avena sativa*

[Introduction](#)[Interactive](#)[All poisonous plants by Botanical name](#)[All poisonous plants by Common name](#)[Important WWW Poisonous Plants sites](#)

General poisoning notes:

Oats (*Avena sativa*) can cause nitrate toxicity in livestock. Cattle are more prone to toxicity, but swine and turkeys have been poisoned on oat stubble. Grass tetany also occurs during periods of lush growth when ruminants suffer from a mineral imbalance.



References:

Kingsbury, J. M. 1964. Poisonous plants of the United States and Canada. Prentice-Hall Inc., Englewood Cliffs, N.J., USA. 626 pp.

Newsom, I. E., Stout, E. N., Thorp, F., Barber, C. W., Groth, A. H. 1937. Oat hay poisoning. J. Am. Vet. Med. Assoc., 90: 66-75.

Nomenclature:

Scientific Name: *Avena sativa* L.

Vernacular name(s): oats

Scientific family name: *Gramineae*

Vernacular family name: grass

Go to ITIS*^{ca} for more taxonomic information on: [Avena sativa](#)

References:

Agriculture Quebec. 1975. Noms des maladies des plantes du Canada/ Names of plant diseases in Canada. , Quebec City, Que., Canada. 288 pp.

Alex, J. F., Cayouette, R., Mulligan, G. A. 1980. Common and botanical names of weeds in Canada/Noms populaire et scientifiques des plantes nuisibles du Canada. Revised. Agric. Can. Publ., Ottawa, Ont., Canada. 132 pp.

Bailey, L. H., Bailey, E. Z. 1976. Hortus third. Revised. MacMillan, New York, N.Y., USA. 1290 pp.

Scoggan, H. J. 1978, 1979. The flora of Canada. Nat. Mus. Nat. Sci. (Ottawa) Publ. Bot. 7(1)-7(4). 1711 pp.

Van Wijk, H. L. 1911. A dictionary of plant names. Martinus Nijhoff, The Hague, The Netherlands. 1444 pp.

Victorin, M. 1964. Flore Laurentienne. 2nd ed. Univ. Montreal, Montreal, Que., Canada. 952 pp.

Geographic Information

Alberta
British Columbia
Manitoba
New Brunswick
Newfoundland
Nova Scotia
Ontario
Prince Edward Island
Quebec
Saskatchewan
Yukon Territory

References:

Bailey, L. H., Bailey, E. Z. 1976. Hortus third. Revised. MacMillan, New York, N.Y., USA. 1290 pp.

Boivin, B. 1966, 1967. Énumération des plantes du Canada. Provencheria 6. Nat. Can. (Que.) 93: 253-274; 371-437; 583-646; 989-1063. 94: 131-157; 471-528; 625-655.

Image or illustration

Avena sativa:

Images: images.google.com

Toxic parts:

leaves
stems

References:

Kingsbury, J. M. 1964. Poisonous plants of the United States and Canada. Prentice-Hall Inc., Englewood Cliffs, N.J., USA. 626 pp.

Notes on Toxic plant chemicals:

Oat hay is a common source of plant poisoning by nitrates. Evidence suggests that moisture on outdoor hay may promote bacterial reduction of nitrate to the more toxic nitrite (Kingsbury 1964).

Toxic plant chemicals:

nitrate

References:

Kingsbury, J. M. 1964. Poisonous plants of the United States and Canada. Prentice-Hall Inc., Englewood Cliffs, N.J., USA. 626 pp.

Animals/Human Poisoning:

Note: When an animal is listed without additional information, the literature (as of 1993) contained no detailed explanation.

Cattle

General symptoms of poisoning:

[cyanosis](#)

[death](#)

[gait, staggering](#)

[trembling](#)

[weakness](#)

References:

Newsom, I. E., Stout, E. N., Thorp, F., Barber, C. W., Groth, A. H. 1937. Oat hay poisoning. J. Am. Vet. Med. Assoc., 90: 66-75.

Swine

Turkeys

[Another search?](#)

[Français](#) | [Contact Us](#) | [Help](#) | [Search](#) | [Canada site](#)

[Coming Events](#) | [About CBIF](#) | [Links](#) | [Reports and Publications](#) |

[Home](#)

Date modified: 2003-02-06

[Important Notices](#)



Français	Contact us	Help	Search	Canada site
Coming events	About CBIF	Links	Reports and publications	Home

Canadian Biodiversity Information Facility



Notes on poisoning: *Baptisia leucantha*

[Introduction](#)[Interactive](#)[All poisonous plants by Botanical name](#)[All poisonous plants by Common name](#)[Important WWW Poisonous Plants sites](#)

General poisoning notes:

Wild false indigo (*Baptisia leucantha*) is a native perennial herb found in southern Ontario. The plant contains toxic alkaloids that have caused poisoning in cattle (Hansen 1930). This plant is potentially poisonous to humans, but no cases of human poisoning have been reported (Cheeke and Schull 1985).



References:

Hansen, A. A. 1930. Indiana plants injurious to livestock. Purdue Univ. Agric. Ext. Stn. Circ., 175. 38 pp.

Lampe, K. F., McCann, M. A. 1985. AMA Handbook of poisonous and injurious plants. American Medical Assoc. Chicago, Ill., USA. 432 pp.

Nomenclature:

Scientific Name: *Baptisia leucantha* T. & G.

Vernacular name(s): wild false indigo

Scientific family name: *Leguminosae*

Vernacular family name: pea

Go to ITIS^{*ca} for more taxonomic information on: [Baptisia leucantha](#)

References:

Agriculture Quebec. 1975. Noms des maladies des plantes du Canada/ Names of plant diseases in Canada. , Quebec City, Que., Canada. 288 pp.

Alex, J. F., Cayouette, R., Mulligan, G. A. 1980. Common and

botanical names of weeds in Canada/Noms populaire et scientifiques des plantes nuisibles du Canada. Revised. Agric. Can. Publ., Ottawa, Ont., Canada. 132 pp.

Bailey, L. H., Bailey, E. Z. 1976. Hortus third. Revised. MacMillan, New York, N.Y., USA. 1290 pp.

Scoggan, H. J. 1978, 1979. The flora of Canada. Nat. Mus. Nat. Sci. (Ottawa) Publ. Bot. 7(1)-7(4). 1711 pp.

Van Wijk, H. L. 1911. A dictionary of plant names. Martinus Nijhoff, The Hague, The Netherlands. 1444 pp.

Victorin, M. 1964. Flore Laurentienne. 2nd ed. Univ. Montreal, Montreal, Que., Canada. 952 pp.

Geographic Information

Ontario

References:

Bailey, L. H., Bailey, E. Z. 1976. Hortus third. Revised. MacMillan, New York, N.Y., USA. 1290 pp.

Boivin, B. 1966, 1967. Énumération des plantes du Canada. Provencheria 6. Nat. Can. (Que.) 93: 253-274; 371-437; 583-646; 989-1063. 94: 131-157; 471-528; 625-655.

Image or illustration

Baptisia leucantha:

Images: images.google.com

Toxic parts:

flowers
leaves
stems

References:

Hansen, A. A. 1930. Indiana plants injurious to livestock. Purdue Univ. Agric. Ext. Stn. Circ., 175. 38 pp.

Toxic plant chemicals:

cytisine

References:

Hansen, A. A. 1930. Indiana plants injurious to livestock. Purdue Univ. Agric. Ext. Stn. Circ., 175. 38 pp.

Lampe, K. F., McCann, M. A. 1985. AMA Handbook of poisonous and injurious plants. American Medical Assoc. Chicago, Ill., USA. 432 pp.

Animals/Human Poisoning:

Note: When an animal is listed without additional information, the literature (as of 1993) contained no detailed explanation.

Cattle

General symptoms of poisoning:

[anorexia](#)

[diarrhea](#)

References:

Hansen, A. A. 1930. Indiana plants injurious to livestock. Purdue Univ. Agric. Ext. Stn. Circ., 175. 38 pp.

Humans

[Another search?](#)

[Français](#) | [Contact Us](#) | [Help](#) | [Search](#) | [Canada site](#)

[Coming Events](#) | [About CBIF](#) | [Links](#) | [Reports and Publications](#) |

[Home](#)

Date modified: 2003-02-06

[Important Notices](#)



Français	Contact us	Help	Search	Canada site
Coming events	About CBIF	Links	Reports and publications	Home

Canadian Biodiversity Information Facility



Notes on poisoning: *Baptisia tinctoria*

[Introduction](#)[Interactive](#)[All poisonous plants by Botanical name](#)[All poisonous plants by Common name](#)[Important WWW Poisonous Plants sites](#)

General poisoning notes:

Wild indigo (*Baptisia tinctoria*) is a native perennial herb found in southern Ontario. Cheeke and Schull (1985) call the plant toxic but no cases of human poisoning have been reported.

References:



Lampe, K. F., McCann, M. A. 1985. AMA Handbook of poisonous and injurious plants. American Medical Assoc. Chicago, Ill., USA. 432 pp.

Nomenclature:

Scientific Name: *Baptisia tinctoria* (L.) Br.

Vernacular name(s): wild indigo

Scientific family name: *Leguminosae*

Vernacular family name: pea

Go to ITIS*^{ca} for more taxonomic information on: [Baptisia tinctoria](#)

References:

Agriculture Quebec. 1975. Noms des maladies des plantes du Canada/ Names of plant diseases in Canada. , Quebec City, Que., Canada. 288 pp.

Alex, J. F., Cayouette, R., Mulligan, G. A. 1980. Common and botanical names of weeds in Canada/Noms populaire et scientifiques des plantes nuisibles du Canada. Revised. Agric. Can. Publ., Ottawa, Ont., Canada. 132 pp.

Bailey, L. H., Bailey, E. Z. 1976. Hortus third. Revised.

MacMillan, New York, N.Y., USA. 1290 pp.

Scoggan, H. J. 1978, 1979. The flora of Canada. Nat. Mus. Nat. Sci. (Ottawa) Publ. Bot. 7(1)-7(4). 1711 pp.

Van Wijk, H. L. 1911. A dictionary of plant names. Martinus Nijhoff, The Hague, The Netherlands. 1444 pp.

Victorin, M. 1964. Flore Laurentienne. 2nd ed. Univ. Montreal, Montreal, Que., Canada. 952 pp.

Geographic Information

Ontario

References:

Bailey, L. H., Bailey, E. Z. 1976. Hortus third. Revised. MacMillan, New York, N.Y., USA. 1290 pp.

Boivin, B. 1966, 1967. Énumération des plantes du Canada. Provencheria 6. Nat. Can. (Que.) 93: 253-274; 371-437; 583-646; 989-1063. 94: 131-157; 471-528; 625-655.

Image or illustration

Baptisia tinctoria:

Images: images.google.com

Toxic parts:

all parts
leaves

References:

Lampe, K. F., McCann, M. A. 1985. AMA Handbook of poisonous and injurious plants. American Medical Assoc. Chicago, Ill., USA. 432 pp.

Perkins, K. D., Payne, W. W. 1978. Guide to the poisonous and irritant plants of Florida. Univ. Fla. Agric. Ext. Serv. Circ., 441. 84 pp.

Toxic plant chemicals:

baptisin
cytisine

References:

Lampe, K. F., McCann, M. A. 1985. AMA Handbook of poisonous and injurious plants. American Medical Assoc. Chicago, Ill., USA. 432 pp.

Perkins, K. D., Payne, W. W. 1978. Guide to the poisonous and irritant plants of Florida. Univ. Fla. Agric. Ext. Serv. Circ., 441. 84 pp.

Animals/Human Poisoning:

Note: When an animal is listed without additional information, the literature (as of 1993) contained no detailed explanation.

Humans

[Another search?](#)

[Français](#) | [Contact Us](#) | [Help](#) | [Search](#) | [Canada site](#)

[Coming Events](#) | [About CBIF](#) | [Links](#) | [Reports and Publications](#) | [Home](#)

Date modified: 2003-02-06

[Important Notices](#)



Français	Contact us	Help	Search	Canada site
Coming events	About CBIF	Links	Reports and publications	Home

Canadian Biodiversity Information Facility



Notes on poisoning: *Barbarea vulgaris*

[Introduction](#)[Interactive](#)[All poisonous plants by Botanical name](#)[All poisonous plants by Common name](#)[Important WWW Poisonous Plants sites](#)

General poisoning notes:

Yellow rocket (*Barbarea vulgaris*) is a naturalized plant found across much of Canada. This plant poisoned a horse in one unusual case in which the animal ate large quantities of the plant from a wagon that was hauling the weed from a field (Hansen 1930). The symptoms suggested glucosinolate poisoning, as in *Brassica* spp.



References:

Hansen, A. A. 1930. Indiana plants injurious to livestock. Purdue Univ. Agric. Ext. Stn. Circ., 175. 38 pp.

MacDonald, M. A., Cavers, P. B. 1991. The biology of Canadian weeds. 97. *Barbarea vulgaris* R.Br. Can. J. Plant Sci., 71: 149-166.

Nomenclature:

Scientific Name: *Barbarea vulgaris* R. Br.

Vernacular name(s): yellow rocket

Scientific family name: *Cruciferae*

Vernacular family name: mustard

Go to ITIS*^{ca} for more taxonomic information on: [Barbarea vulgaris](#)

References:

Agriculture Quebec. 1975. Noms des maladies des plantes du Canada/ Names of plant diseases in Canada. , Quebec City, Que., Canada. 288 pp.

Alex, J. F., Cayouette, R., Mulligan, G. A. 1980. Common and botanical names of weeds in Canada/Noms populaire et scientifiques des plantes nuisibles du Canada. Revised. Agric. Can. Publ., Ottawa, Ont., Canada. 132 pp.

Bailey, L. H., Bailey, E. Z. 1976. Hortus third. Revised. MacMillan, New York, N.Y., USA. 1290 pp.

Scoggan, H. J. 1978, 1979. The flora of Canada. Nat. Mus. Nat. Sci. (Ottawa) Publ. Bot. 7(1)-7(4). 1711 pp.

Van Wijk, H. L. 1911. A dictionary of plant names. Martinus Nijhoff, The Hague, The Netherlands. 1444 pp.

Victorin, M. 1964. Flore Laurentienne. 2nd ed. Univ. Montreal, Montreal, Que., Canada. 952 pp.

Geographic Information

Alberta
British Columbia
Labrador
Manitoba
New Brunswick
Newfoundland
Northwest Territories
Nova Scotia
Ontario
Prince Edward Island
Quebec
Saskatchewan
Yukon Territory

References:

Bailey, L. H., Bailey, E. Z. 1976. Hortus third. Revised. MacMillan, New York, N.Y., USA. 1290 pp.

Boivin, B. 1966, 1967. Énumération des plantes du Canada. Provencheria 6. Nat. Can. (Que.) 93: 253-274; 371-437; 583-646; 989-1063. 94: 131-157; 471-528; 625-655.

Image or illustration

Barbarea vulgaris:

Images: images.google.com

Toxic parts:

leaves

stems

References:

Hansen, A. A. 1930. Indiana plants injurious to livestock. Purdue Univ. Agric. Ext. Stn. Circ., 175. 38 pp.

Animals/Human Poisoning:

Note: When an animal is listed without additional information, the literature (as of 1993) contained no detailed explanation.

Horses

[Another search?](#)

[Français](#) | [Contact Us](#) | [Help](#) | [Search](#) | [Canada site](#)

[Coming Events](#) | [About CBIF](#) | [Links](#) | [Reports and Publications](#) |

[Home](#)

Date modified: 2003-02-06

[Important Notices](#)



Français	Contact us	Help	Search	Canada site
Coming events	About CBIF	Links	Reports and publications	Home

Canadian Biodiversity Information Facility



Notes on poisoning: *Bassia hyssopifolia*

[Introduction](#)[Interactive](#)[All poisonous plants by Botanical name](#)[All poisonous plants by Common name](#)[Important WWW Poisonous Plants sites](#)

General poisoning notes:

Five-hooked bassia (*Bassia hyssopifolia*) is a naturalized herb found in southern parts of western Canada. The plant is suspected of poisoning livestock. James et al. (1976) report experimental poisoning of sheep after they were fed macerated above-ground parts of the plant.



References:

James, L. F., Williams, M. C., Bleak, A. T. 1976. Toxicity of *Bassia hyssopifolia* to sheep. *J. Range Manage.*, 29: 284-285.

Nomenclature:

Scientific Name: *Bassia hyssopifolia* (Pall.) Ktze.

Vernacular name(s): five-hooked bassia

Scientific family name: *Chenopodiaceae*

Vernacular family name: goosefoot

Go to ITIS*^{ca} for more taxonomic information on: [Bassia hyssopifolia](#)

References:

Agriculture Quebec. 1975. Noms des maladies des plantes du Canada/ Names of plant diseases in Canada. , Quebec City, Que., Canada. 288 pp.

Alex, J. F., Cayouette, R., Mulligan, G. A. 1980. Common and botanical names of weeds in Canada/Noms populaire et scientifiques des plantes nuisibles du Canada. Revised. Agric. Can. Publ., Ottawa, Ont., Canada. 132 pp.

Bailey, L. H., Bailey, E. Z. 1976. Hortus third. Revised. MacMillan, New York, N.Y., USA. 1290 pp.

Scoggan, H. J. 1978, 1979. The flora of Canada. Nat. Mus. Nat. Sci. (Ottawa) Publ. Bot. 7(1)-7(4). 1711 pp.

Van Wijk, H. L. 1911. A dictionary of plant names. Martinus Nijhoff, The Hague, The Netherlands. 1444 pp.

Victorin, M. 1964. Flore Laurentienne. 2nd ed. Univ. Montreal, Montreal, Que., Canada. 952 pp.

Geographic Information

Alberta
British Columbia
Saskatchewan

References:

Bailey, L. H., Bailey, E. Z. 1976. Hortus third. Revised. MacMillan, New York, N.Y., USA. 1290 pp.

Boivin, B. 1966, 1967. Énumération des plantes du Canada. Provencheria 6. Nat. Can. (Que.) 93: 253-274; 371-437; 583-646; 989-1063. 94: 131-157; 471-528; 625-655.

Image or illustration

Bassia hyssopifolia:

Images: images.google.com

Toxic parts:

flowers
leaves

References:

James, L. F., Williams, M. C., Bleak, A. T. 1976. Toxicity of *Bassia hyssopifolia* to sheep. J. Range Manage., 29: 284-285.

Toxic plant chemicals:

oxalate

References:

James, L. F., Williams, M. C., Bleak, A. T. 1976. Toxicity of

Bassia hyssopifolia to sheep. J. Range Manage., 29: 284-285.

Animals/Human Poisoning:

Note: When an animal is listed without additional information, the literature (as of 1993) contained no detailed explanation.

Sheep

General symptoms of poisoning:

[coma](#)

[death](#)

[gait, unsteady](#)

[incoordination](#)

[tetany](#)

[weakness](#)

Notes on poisoning:

In experimental feeding of sheep, five-hooked bassia caused symptoms similar to poisoning by *Kochia scoparia*. In addition to the symptoms listed, hemorrhaging on the rumen surface and enlarged kidneys occurred. Calcium concentrations in the serum of five sheep dropped from an average of 10.9 mg/mL to 3.6 mg/mL. Signs of photosensitization were also noted in some of the sheep (James et al. 1976).

References:

James, L. F., Williams, M. C., Bleak, A. T. 1976. Toxicity of *Bassia hyssopifolia* to sheep. J. Range Manage., 29: 284-285.

[Another search?](#)

[Français](#) | [Contact Us](#) | [Help](#) | [Search](#) | [Canada site](#)

[Coming Events](#) | [About CBIF](#) | [Links](#) | [Reports and Publications](#) | [Home](#)

Date modified: 2003-02-06

[Important Notices](#)



Français	Contact us	Help	Search	Canada site
Coming events	About CBIF	Links	Reports and publications	Home

Canadian Biodiversity Information Facility



Notes on poisoning: *Brassaia actinophylla*

[Introduction](#)[Interactive](#)[All poisonous plants by Botanical name](#)[All poisonous plants by Common name](#)[Important WWW Poisonous Plants sites](#)

General poisoning notes:

Australian umbrella tree (*Brassaia actinophylla*) is an ornamental shrub grown indoors in Canada. This plant caused toxic symptoms in a dog after it ingested the leaves. Experimental work on rats caused death after they ingested 3.2 g of leaf tissue over 7 days. Symptoms in the rats included extramedullary hematopoiesis in the spleen, with black tarry gastrointestinal content caused by blood (Quam et al. 1985).

References:

Mitchell, J. C. 1981. Allergic contact dermatitis from *Hedera helix* and *Brassaia actinophylla* (Araliaceae). *Contact Dermatitis*, 7: 158-159.

Quam, V. C., Schermeister, L. J., Tanner, N. S. 1985. Investigation for toxicity of a household plant - Australian umbrella tree (*Brassaia actinophylla* Endl.). *N. D. Farm Res.*, 43: 15-17.

Spoerke, D. G., Smolinske, S. C. 1990. *Toxicity of houseplants*. CRC Press, Inc., Boca Raton, Fla., USA. 335 pp.

Nomenclature:

Scientific Name: *Brassaia actinophylla* Endl.

Vernacular name(s): Australian umbrella tree

Scientific family name: *Araliaceae*

Vernacular family name: aralia

Go to ITIS^{*ca} for more taxonomic information on: [Brassaia actinophylla](#)

References:

Agriculture Quebec. 1975. Noms des maladies des plantes du Canada/ Names of plant diseases in Canada. , Quebec City, Que., Canada. 288 pp.

Alex, J. F., Cayouette, R., Mulligan, G. A. 1980. Common and botanical names of weeds in Canada/Noms populaire et scientifiques des plantes nuisibles du Canada. Revised. Agric. Can. Publ., Ottawa, Ont., Canada. 132 pp.

Bailey, L. H., Bailey, E. Z. 1976. Hortus third. Revised. MacMillan, New York, N.Y., USA. 1290 pp.

Scoggan, H. J. 1978, 1979. The flora of Canada. Nat. Mus. Nat. Sci. (Ottawa) Publ. Bot. 7(1)-7(4). 1711 pp.

Van Wijk, H. L. 1911. A dictionary of plant names. Martinus Nijhoff, The Hague, The Netherlands. 1444 pp.

Victorin, M. 1964. Flore Laurentienne. 2nd ed. Univ. Montreal, Montreal, Que., Canada. 952 pp.

Geographic Information

Plant or plant parts used in or around the home.

References:

Bailey, L. H., Bailey, E. Z. 1976. Hortus third. Revised. MacMillan, New York, N.Y., USA. 1290 pp.

Boivin, B. 1966, 1967. Énumération des plantes du Canada. Provencheria 6. Nat. Can. (Que.) 93: 253-274; 371-437; 583-646; 989-1063. 94: 131-157; 471-528; 625-655.

Image or illustration

Brassaia actinophylla:

Images: images.google.com

Toxic parts:

leaves

References:

Quam, V. C., Schermeister, L. J., Tanner, N. S. 1985. Investigation for toxicity of a household plant - Australian umbrella tree (*Brassaia actinophylla* Endl.). N. D. Farm Res., 43: 15-17.

Notes on Toxic plant chemicals:

Chemical analysis (Quam et al. 1985) revealed that leaves contain oxalates and saponins as well as some cardiac glycosides and alkaloids.

Toxic plant chemicals:

oxalate

References:

Quam, V. C., Schermeister, L. J., Tanner, N. S. 1985. Investigation for toxicity of a household plant - Australian umbrella tree (*Brassaia actinophylla* Endl.). N. D. Farm Res., 43: 15-17.

Animals/Human Poisoning:

Note: When an animal is listed without additional information, the literature (as of 1993) contained no detailed explanation.

Dogs

General symptoms of poisoning:

[anorexia](#)

[ataxia](#)

[vomiting](#)

Notes on poisoning:

A poodle that ingested Australian umbrella tree leaves suffered from vomiting, leucopenia, anorexia, and ataxia. The leaves were found to contain 0.9%-1.5% oxalate crystals by weight (Spoerke and Smolinske 1990).

References:

Spoerke, D. G., Smolinske, S. C. 1990. Toxicity of houseplants. CRC Press, Inc., Boca Raton, Fla., USA. 335 pp.

Humans

General symptoms of poisoning:

[erythema](#)

References:

Mitchell, J. C. 1981. Allergic contact dermatitis from *Hedera helix* and *Brassaia actinophylla* (Araliaceae). *Contact Dermatitis*, 7: 158-159.

Rodents

General symptoms of poisoning:

[death](#)

[hemorrhage](#)

References:

Quam, V. C., Schermeister, L. J., Tanner, N. S. 1985. Investigation for toxicity of a household plant - Australian umbrella tree (*Brassaia actinophylla* Endl.). *N. D. Farm Res.*, 43: 15-17.

[Another search?](#)

[Français](#) | [Contact Us](#) | [Help](#) | [Search](#) | [Canada site](#)

[Coming Events](#) | [About CBIF](#) | [Links](#) | [Reports and Publications](#) |

[Home](#)

Date modified: 2003-02-06

[Important Notices](#)



Français	Contact us	Help	Search	Canada site
Coming events	About CBIF	Links	Reports and publications	Home

Canadian Biodiversity Information Facility



Notes on poisoning: *Brassica campestris*

[Introduction](#)

[Interactive](#)

[All poisonous plants by Botanical name](#)

[All poisonous plants by Common name](#)

[Important WWW Poisonous Plants sites](#)



General poisoning notes:

Bird rape (*Brassica campestris*) includes the vegetables turnip and chinese cabbage. These plants can accumulate toxic quantities of SMC0, which poisoned several types of livestock after they ingested sufficient quantities (Benevenga et al. 1985). Please see the expanded notes on poisoning by this chemical under kale (*Brassica oleracea*) and the effects on various livestock animals.

References:

Benevenga, N. J., Case, G. L., Steele, R. D. 1989. Occurrence and metabolism of s-methyl-l-cysteine and s-methyl-l-cysteine sulfoxide in plants and their toxicity and metabolism in animals. Pages 203-228 in Cheeke, P. R., ed. Toxicants of plant origin. Vol. III. Proteins and amino acids. CRC Press, Inc., Boca Raton, Fla., USA. 271 pp.

Nomenclature:

Scientific Name: *Brassica campestris* L.

Vernacular name(s): bird rape

Scientific family name: *Cruciferae*

Vernacular family name: mustard

Go to ITIS*^{ca} for more taxonomic information on: [Brassica campestris](#)

References:

Agriculture Quebec. 1975. Noms des maladies des plantes du Canada/ Names of plant diseases in Canada. , Quebec City, Que.,

Canada. 288 pp.

Alex, J. F., Cayouette, R., Mulligan, G. A. 1980. Common and botanical names of weeds in Canada/Noms populaire et scientifiques des plantes nuisibles du Canada. Revised. Agric. Can. Publ., Ottawa, Ont., Canada. 132 pp.

Bailey, L. H., Bailey, E. Z. 1976. Hortus third. Revised. MacMillan, New York, N.Y., USA. 1290 pp.

Scoggan, H. J. 1978, 1979. The flora of Canada. Nat. Mus. Nat. Sci. (Ottawa) Publ. Bot. 7(1)-7(4). 1711 pp.

Van Wijk, H. L. 1911. A dictionary of plant names. Martinus Nijhoff, The Hague, The Netherlands. 1444 pp.

Victorin, M. 1964. Flore Laurentienne. 2nd ed. Univ. Montreal, Montreal, Que., Canada. 952 pp.

Geographic Information

Alberta
British Columbia
Labrador
Manitoba
New Brunswick
Newfoundland
Northwest Territories
Nova Scotia
Ontario
Prince Edward Island
Quebec
Saskatchewan
Yukon Territory

References:

Bailey, L. H., Bailey, E. Z. 1976. Hortus third. Revised. MacMillan, New York, N.Y., USA. 1290 pp.

Boivin, B. 1966, 1967. Énumération des plantes du Canada. Provencheria 6. Nat. Can. (Que.) 93: 253-274; 371-437; 583-646; 989-1063. 94: 131-157; 471-528; 625-655.

Image or illustration

Brassica campestris:

Images: images.google.com

Notes on Poisonous plant parts:

The quantities of SMCO vary amongst the plant parts and in relation to the maturity of the plant (Benevenga et al. 1989).

Toxic parts:

flowers
leaves
stems

References:

Benevenga, N. J., Case, G. L., Steele, R. D. 1989. Occurrence and metabolism of s-methyl-l-cysteine and s-methyl-l-cysteine sulfoxide in plants and their toxicity and metabolism in animals. Pages 203-228 in Cheeke, P. R., ed. Toxicants of plant origin. Vol. III. Proteins and amino acids. CRC Press, Inc., Boca Raton, Fla., USA. 271 pp.

Notes on Toxic plant chemicals:

This species can produce toxic quantities of SMCO (S-methyl-L-cysteine sulfoxide) (Benevenga et al. 1989).

Toxic plant chemicals:

S-methyl-L-cysteine sulfoxide (SMCO)

References:

Benevenga, N. J., Case, G. L., Steele, R. D. 1989. Occurrence and metabolism of s-methyl-l-cysteine and s-methyl-l-cysteine sulfoxide in plants and their toxicity and metabolism in animals. Pages 203-228 in Cheeke, P. R., ed. Toxicants of plant origin. Vol. III. Proteins and amino acids. CRC Press, Inc., Boca Raton, Fla., USA. 271 pp.

Animals/Human Poisoning:

Note: When an animal is listed without additional information, the literature (as of 1993) contained no detailed explanation.

Cattle

[Another search?](#)

[Français](#) | [Contact Us](#) | [Help](#) | [Search](#) | [Canada site](#)
[Coming Events](#) | [About CBIF](#) | [Links](#) | [Reports and Publications](#) |
[Home](#)

Date modified: 2003-02-06

[Important Notices](#)



Français	Contact us	Help	Search	Canada site
Coming events	About CBIF	Links	Reports and publications	Home

Canadian Biodiversity Information Facility



Notes on poisoning: *Brassica juncea*

[Introduction](#)[Interactive](#)[All poisonous plants by Botanical name](#)[All poisonous plants by Common name](#)[Important WWW Poisonous Plants sites](#)

General poisoning notes:

Indian mustard (*Brassica juncea*) is a naturalized herb found across much of Canada. This plant can contain large quantities of toxins that are common to the genus *Brassica*. Many of these compounds are being reduced through plant breeding. See the comments under sections of *Brassica oleracea*, which include a discussion of problems in relation to this genus.

References:



Fenwick, G. R., Heaney, R. K., Mawson, R. 1989. Glucosinolates. Pages 1-41 in Cheeke, P. R., ed. Toxicants of plant origin. Vol. II. Glycosides. CRC Press, Inc., Boca Raton, Fla., USA. 277 pp.

Kernaleguen, A., Smith, R. A., Yong, C. W. 1989. Acute mustard seed toxicosis in beef cattle. Can. Vet. J., 30: 524.

Nomenclature:

Scientific Name: *Brassica juncea* (L.) Czern.

Vernacular name(s): Indian mustard

Scientific family name: *Cruciferae*

Vernacular family name: mustard

Go to ITIS^{*ca} for more taxonomic information on: [Brassica juncea](#)

References:

Agriculture Quebec. 1975. Noms des maladies des plantes du Canada/ Names of plant diseases in Canada. , Quebec City, Que., Canada. 288 pp.

Alex, J. F., Cayouette, R., Mulligan, G. A. 1980. Common and

botanical names of weeds in Canada/Noms populaire et scientifiques des plantes nuisibles du Canada. Revised. Agric. Can. Publ., Ottawa, Ont., Canada. 132 pp.

Bailey, L. H., Bailey, E. Z. 1976. Hortus third. Revised. MacMillan, New York, N.Y., USA. 1290 pp.

Scoggan, H. J. 1978, 1979. The flora of Canada. Nat. Mus. Nat. Sci. (Ottawa) Publ. Bot. 7(1)-7(4). 1711 pp.

Van Wijk, H. L. 1911. A dictionary of plant names. Martinus Nijhoff, The Hague, The Netherlands. 1444 pp.

Victorin, M. 1964. Flore Laurentienne. 2nd ed. Univ. Montreal, Montreal, Que., Canada. 952 pp.

Geographic Information

Alberta
British Columbia
Newfoundland
Northwest Territories
Ontario
Quebec
Saskatchewan

References:

Bailey, L. H., Bailey, E. Z. 1976. Hortus third. Revised. MacMillan, New York, N.Y., USA. 1290 pp.

Boivin, B. 1966, 1967. Énumération des plantes du Canada. Provencheria 6. Nat. Can. (Que.) 93: 253-274; 371-437; 583-646; 989-1063. 94: 131-157; 471-528; 625-655.

Image or illustration

Brassica juncea:

Images: images.google.com

Toxic parts:

leaves
seeds

References:

Fenwick, G. R., Heaney, R. K., Mawson, R. 1989. Glucosinolates. Pages 1-41 in Cheeke, P. R., ed. Toxicants of plant origin. Vol. II. Glycosides. CRC Press, Inc., Boca Raton, Fla., USA. 277 pp.

Toxic plant chemicals:

glucosinolates

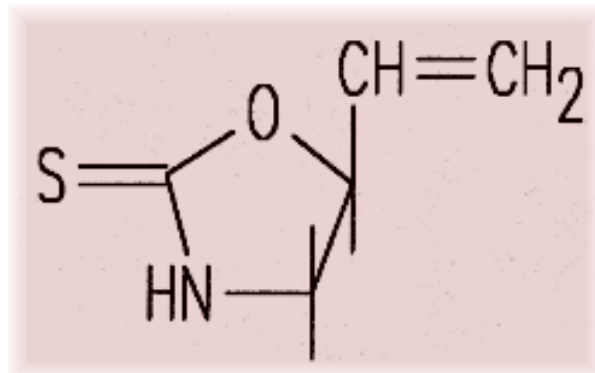

glucosinolates

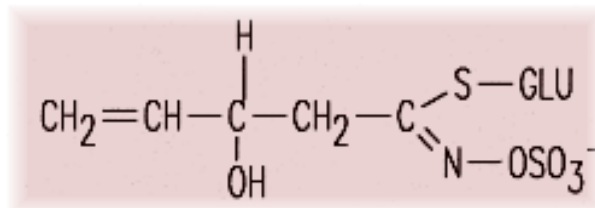

glucosinolates

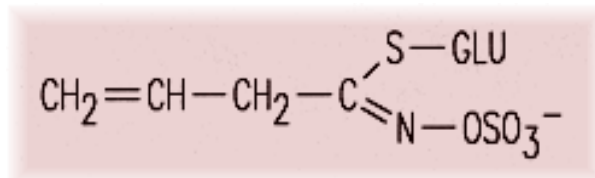

S-methyl-L-cysteine sulfoxide (SMCO)

Chemical diagram(s) are courtesy of [Ruth McDiarmid](#), Biochemistry Technician, Kamloops Range Station, Agriculture and Agri-Food Canada, Kamloops, British Columbia, Canada.

References:

Fenwick, G. R., Heaney, R. K., Mawson, R. 1989. Glucosinolates. Pages 1-41 in Cheeke, P. R., ed. Toxicants of plant origin. Vol. II. Glycosides. CRC Press, Inc., Boca Raton, Fla., USA. 277 pp.

Animals/Human Poisoning:

Note: When an animal is listed without additional information, the literature (as of 1993) contained no detailed explanation.

Cattle

General symptoms of poisoning:

[abortion](#)

[death](#)

[dehydration](#)

[gait, staggering](#)

Notes on poisoning:

In one case in Saskatchewan, a herd of cattle gained access to waste mustard seed. Six cows died and two were ill. Symptoms included depression, staggering, and reluctance to move. Several cows aborted, but most showed clinical signs of sickness. Postmortem findings revealed profuse edema of the forestomachs and abomasum. A 2-3 cm layer of clear, yellowish, gelatinous fluid was present under the serosa of the rumen, reticulum, and omasum. Allyl isothiocyanate at a rate of 1000 mg/100 mL was liberated from the seeds. A rate of 250 mg/100 mL is regarded as acutely toxic to cattle (Kernaleguen et al. 1989).

References:

Kernaleguen, A., Smith, R. A., Yong, C. W. 1989. Acute mustard seed toxicosis in beef cattle. *Can. Vet. J.*, 30: 524.

Swine

[Another search?](#)

[Français](#) | [Contact Us](#) | [Help](#) | [Search](#) | [Canada site](#)

[Coming Events](#) | [About CBIF](#) | [Links](#) | [Reports and Publications](#) |

[Home](#)

Date modified: 2003-02-06

[Important Notices](#)



Français	Contact us	Help	Search	Canada site
Coming events	About CBIF	Links	Reports and publications	Home

Canadian Biodiversity Information Facility



Notes on poisoning: *Brassica napus*

[Introduction](#)[Interactive](#)[All poisonous plants by Botanical name](#)[All poisonous plants by Common name](#)[Important WWW Poisonous Plants sites](#)

General poisoning notes:

Rapeseed (*Brassica napus*) meal is used as an additive to livestock feed, but toxicity occurs from glucosinolates and erucic acid, which form in the seeds. Canadian breeders have developed new cultivars called canola, which are low in these compounds (Cheeke and Schull 1985). See discussions under [Brassica oleracea](#) for more information on poisoning by *Brassica* species.

References:



Cheeke, P. R., Shull, L. R. 1985. Natural toxicants in feeds and poisonous plants. AVI Publishing Company, Inc., Westport, Conn., USA. 492 pp.

Kingsbury, J. M. 1964. Poisonous plants of the United States and Canada. Prentice-Hall Inc., Englewood Cliffs, N.J., USA. 626 pp.

Nomenclature:

Scientific Name: *Brassica napus* L.

Vernacular name(s): rapeseed

Scientific family name: *Cruciferae*

Vernacular family name: mustard

Go to ITIS*^{ca} for more taxonomic information on: [Brassica napus](#)

References:

Agriculture Quebec. 1975. Noms des maladies des plantes du Canada/ Names of plant diseases in Canada. , Quebec City, Que., Canada. 288 pp.

Alex, J. F., Cayouette, R., Mulligan, G. A. 1980. Common and

botanical names of weeds in Canada/Noms populaire et scientifiques des plantes nuisibles du Canada. Revised. Agric. Can. Publ., Ottawa, Ont., Canada. 132 pp.

Bailey, L. H., Bailey, E. Z. 1976. Hortus third. Revised. MacMillan, New York, N.Y., USA. 1290 pp.

Scoggan, H. J. 1978, 1979. The flora of Canada. Nat. Mus. Nat. Sci. (Ottawa) Publ. Bot. 7(1)-7(4). 1711 pp.

Van Wijk, H. L. 1911. A dictionary of plant names. Martinus Nijhoff, The Hague, The Netherlands. 1444 pp.

Victorin, M. 1964. Flore Laurentienne. 2nd ed. Univ. Montreal, Montreal, Que., Canada. 952 pp.

Geographic Information

Alberta
British Columbia
Labrador
Manitoba
New Brunswick
Newfoundland
Northwest Territories
Nova Scotia
Ontario
Prince Edward Island
Quebec
Saskatchewan
Yukon Territory

References:

Bailey, L. H., Bailey, E. Z. 1976. Hortus third. Revised. MacMillan, New York, N.Y., USA. 1290 pp.

Boivin, B. 1966, 1967. Énumération des plantes du Canada. Provencheria 6. Nat. Can. (Que.) 93: 253-274; 371-437; 583-646; 989-1063. 94: 131-157; 471-528; 625-655.

Image or illustration

Brassica napus:

Images: images.google.com

Notes on Poisonous plant parts:

Rapeseed meal is used as an additive to feeds for livestock. The recent development of canola cultivars allows a much higher amount

of rapeseed meal to be added to diets without toxic affects (Cheeke and Schull 1985).

Toxic parts:

leaves
seeds

References:

Cheeke, P. R., Shull, L. R. 1985. Natural toxicants in feeds and poisonous plants. AVI Publishing Company, Inc., Westport, Conn., USA. 492 pp.

Notes on Toxic plant chemicals:

See the notes under [Brassica oleracea](#) for a discussion on these chemicals, which are common to the genus *Brassica*.

Toxic plant chemicals:

glucosinolates

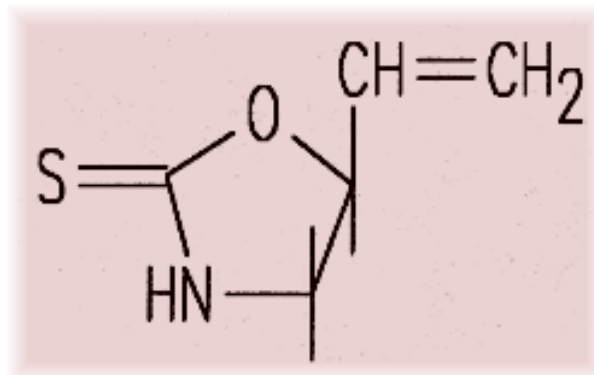

glucosinolates

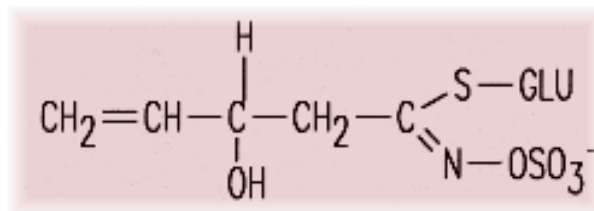

glucosinolates

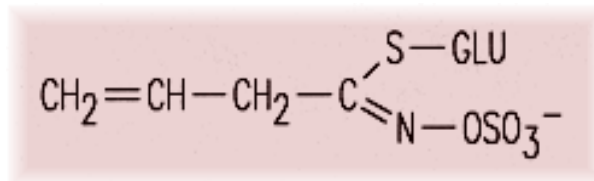

S-methyl-L-cysteine sulfoxide (SMCO)

Chemical diagram(s) are courtesy of [Ruth McDiarmid](#), Biochemistry

Technician, Kamloops Range Station, Agriculture and Agri-Food Canada, Kamloops, British Columbia, Canada.

References:

Cheeke, P. R., Shull, L. R. 1985. Natural toxicants in feeds and poisonous plants. AVI Publishing Company, Inc., Westport, Conn., USA. 492 pp.

Animals/Human Poisoning:

Note: When an animal is listed without additional information, the literature (as of 1993) contained no detailed explanation.

Cattle

Poultry

General symptoms of poisoning:

[liver, congestion of](#)
[thyroid, enlarged](#)
[weight gain, reduced](#)

Notes on poisoning:

Poultry exhibit growth depression and enlarged thyroid glands from ingesting too much rapeseed meal. Perosis, lowered egg production, and off-flavors in eggs also occur (Cheeke and Schull 1985).

References:

Cheeke, P. R., Shull, L. R. 1985. Natural toxicants in feeds and poisonous plants. AVI Publishing Company, Inc., Westport, Conn., USA. 492 pp.

Swine

[Another search?](#)

[Français](#) | [Contact Us](#) | [Help](#) | [Search](#) | [Canada site](#)

[Coming Events](#) | [About CBIF](#) | [Links](#) | [Reports and Publications](#) | [Home](#)

Date modified: 2003-02-06

[Important Notices](#)



Français	Contact us	Help	Search	Canada site
Coming events	About CBIF	Links	Reports and publications	Home



Notes on poisoning: *Brassica oleracea*

[Introduction](#)

[Interactive](#)

[All poisonous plants by Botanical name](#)

[All poisonous plants by Common name](#)

[Important WWW Poisonous Plants sites](#)



General poisoning notes:

Brassica oleracea includes common cultivated crops such as kale, broccoli, Brussels sprouts, and cabbage. All these vegetables are capable of forming toxic quantities of SMCO, a chemical that can cause hemolytic anemia in livestock. These plants also contain glucosinolates, which can cause goiter. In general, these widely used vegetables are safe for human consumption. Cases of livestock poisoning occur when they are used almost exclusively as fodder for animals (Kingsbury 1964, Smith 1980, Cheeke and Schull 1985, Benevenga et al. 1989). Glucosinolates contained in kale, cabbage, and broccoli (*Brassica oleracea*) can cause goiter in humans. These plants cause goiter in less than 5% of cases in humans. The chemicals cause a reduction in performance of young livestock, especially swine and poultry (Fenwick et al. 1989). It is important to note that the frequency of toxicity has dropped dramatically since a few decades ago. Researchers have changed the quantity of toxic compounds in the entire *Brassica* spp., creating new cultivars with lower quantities of these chemicals. The threat of poisoning from some of the plants has diminished or virtually disappeared in some cultivars. For example, the Canadian development of rapeseed into the so-called "double-zero" cultivars (low in glucosinolates and in erucic acid) has allowed rapeseed meal to be used for livestock at much higher levels without reducing performance (Cheeke and Schull 1985).

References:

Benevenga, N. J., Case, G. L., Steele, R. D. 1989. Occurrence and metabolism of s-methyl-l-cysteine and s-methyl-l-cysteine sulfoxide in plants and their toxicity and metabolism in animals. Pages 203-228 in Cheeke, P. R., ed. Toxicants of plant origin. Vol. III. Proteins and amino acids. CRC Press, Inc., Boca Raton, Fla., USA. 271 pp.

Cheeke, P. R., Shull, L. R. 1985. Natural toxicants in feeds and

poisonous plants. AVI Publishing Company, Inc., Westport, Conn., USA. 492 pp.

Fenwick, G. R., Heaney, R. K., Mawson, R. 1989. Glucosinolates. Pages 1-41 in Cheeke, P. R., ed. Toxicants of plant origin. Vol. II. Glycosides. CRC Press, Inc., Boca Raton, Fla., USA. 277 pp.

Kingsbury, J. M. 1964. Poisonous plants of the United States and Canada. Prentice-Hall Inc., Englewood Cliffs, N.J., USA. 626 pp.

Smith, R. H. 1980. Kale poisoning: the brassica anemia factor. Vet. Rec., 107: 12-15.

Nomenclature:

Scientific Name: *Brassica oleracea* L.

Vernacular name(s): wild cabbage

Scientific family name: *Cruciferae*

Vernacular family name: mustard

Go to ITIS*^{ca} for more taxonomic information on: [Brassica oleracea](#)

References:

Agriculture Quebec. 1975. Noms des maladies des plantes du Canada/ Names of plant diseases in Canada. , Quebec City, Que., Canada. 288 pp.

Alex, J. F., Cayouette, R., Mulligan, G. A. 1980. Common and botanical names of weeds in Canada/Noms populaire et scientifiques des plantes nuisibles du Canada. Revised. Agric. Can. Publ., Ottawa, Ont., Canada. 132 pp.

Bailey, L. H., Bailey, E. Z. 1976. Hortus third. Revised. MacMillan, New York, N.Y., USA. 1290 pp.

Scoggan, H. J. 1978, 1979. The flora of Canada. Nat. Mus. Nat. Sci. (Ottawa) Publ. Bot. 7(1)-7(4). 1711 pp.

Van Wijk, H. L. 1911. A dictionary of plant names. Martinus Nijhoff, The Hague, The Netherlands. 1444 pp.

Victorin, M. 1964. Flore Laurentienne. 2nd ed. Univ. Montreal, Montreal, Que., Canada. 952 pp.

Geographic Information

Newfoundland
Ontario
Prince Edward Island
Quebec

References:

Bailey, L. H., Bailey, E. Z. 1976. Hortus third. Revised. MacMillan, New York, N.Y., USA. 1290 pp.

Boivin, B. 1966, 1967. Énumération des plantes du Canada. Provencheria 6. Nat. Can. (Que.) 93: 253-274; 371-437; 583-646; 989-1063. 94: 131-157; 471-528; 625-655.

Image or illustration

Brassica oleracea:

Images: images.google.com

Notes on Poisonous plant parts:

SMCO is most abundant in young leaves and growing points. Brussels sprouts can have high amounts of the chemical, as can the flowering parts of the plants. The most drastic hemolytic anemia occurs when these plants form exclusive fodder for livestock (Smith 1980).

Toxic parts:

all parts
flowers
leaves

References:

Smith, R. H. 1980. Kale poisoning: the brassica anemia factor. Vet. Rec., 107: 12-15.

Notes on Toxic plant chemicals:

Glucosinolates are chemicals that can inhibit the function of the thyroid gland. Various components of the chemicals can be detrimental to both humans and livestock. Goitrin inhibits thyroid function. Thiocyanates and isothiocyanates inhibit iodine uptake by the thyroid gland. Nitriles can be formed from glucosinolates and these chemicals are toxic, affecting the liver and kidneys (Cheeke and Schull 1985). SMCO (S-methyl-L-cysteine sulfoxide) is an alpha-amino acid that causes hemolytic anemia in livestock. This chemical is restricted to various members of the family Cruciferae in the genera *Brassica* and *Raphanus* as well as the family Liliaceae in the genus *Allium* (onions). Additional notes on this chemical can be found under members of these genera. The concentration of SMCO

in kale plants may double as the plants mature. The quantity of SMCO is increased with the addition of nitrogen to high-sulfate soils. SMCO can be greatly reduced in low-sulfate soils. The variation of SMCO varies greatly amongst different varieties of plants in the genus *Brassica*, suggesting that concentrations of SMCO may be heritable (Benevenga et al. 1989).

Toxic plant chemicals:

glucosinolates

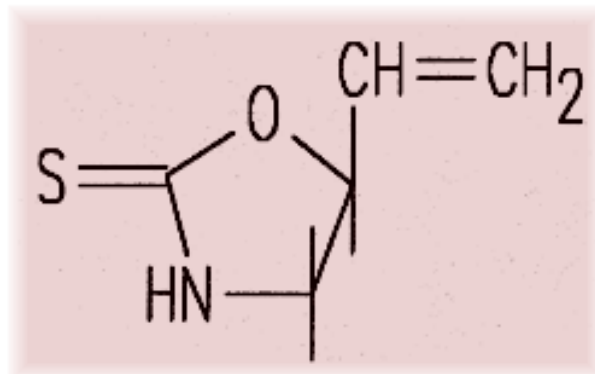

glucosinolates

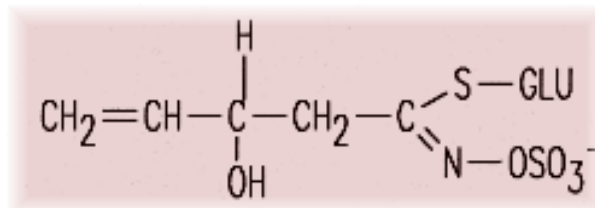

glucosinolates

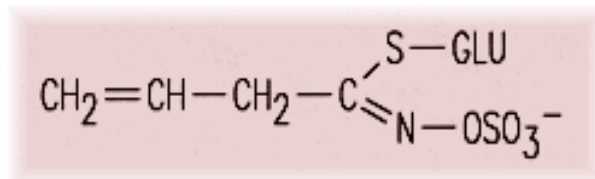

S-methyl-L-cysteine sulfoxide (SMCO)

Chemical diagram(s) are courtesy of [Ruth McDiarmid](#), Biochemistry Technician, Kamloops Range Station, Agriculture and Agri-Food Canada, Kamloops, British Columbia, Canada.

References:

Benevenga, N. J., Case, G. L., Steele, R. D. 1989. Occurrence and metabolism of s-methyl-l-cysteine and s-methyl-l-cysteine sulfoxide in plants and their toxicity and metabolism in animals. Pages 203-228 in Cheeke, P. R., ed. Toxicants of plant origin. Vol. III. Proteins and amino acids. CRC Press, Inc., Boca Raton, Fla., USA. 271 pp.

Cheeke, P. R., Shull, L. R. 1985. Natural toxicants in feeds and

poisonous plants. AVI Publishing Company, Inc., Westport, Conn., USA. 492 pp.

Animals/Human Poisoning:

Note: When an animal is listed without additional information, the literature (as of 1993) contained no detailed explanation.

Cattle

General symptoms of poisoning:

[Heinz bodies](#)
[hemoglobinuria](#)
[weight gain, reduced](#)

References:

Smith, R. H. 1980. Kale poisoning: the brassica anemia factor. Vet. Rec., 107: 12-15.

Goats

General symptoms of poisoning:

[Heinz bodies](#)
[hemoglobinuria](#)

References:

Smith, R. H. 1980. Kale poisoning: the brassica anemia factor. Vet. Rec., 107: 12-15.

Humans

General symptoms of poisoning:

[thyroid, enlarged](#)

References:

Cheeke, P. R., Shull, L. R. 1985. Natural toxicants in feeds and poisonous plants. AVI Publishing Company, Inc., Westport, Conn., USA. 492 pp.

Poultry

Sheep

General symptoms of poisoning:

[Heinz bodies](#)
[hemoglobinuria](#)

References:

Benevenga, N. J., Case, G. L., Steele, R. D. 1989. Occurrence and metabolism of s-methyl-l-cysteine and s-methyl-l-cysteine sulfoxide in plants and their toxicity and metabolism in animals. Pages 203-228 in Cheeke, P. R., ed. Toxicants of plant origin. Vol. III. Proteins and amino acids. CRC Press, Inc., Boca Raton, Fla., USA. 271 pp.

Swine

General symptoms of poisoning:

[weight gain, reduced](#)

Notes on poisoning:

Glucosinolates in the plants can cause general reduced weight gain in young pigs (less than 20 kg) (Fenwick et al. 1989).

References:

Fenwick, G. R., Heaney, R. K., Mawson, R. 1989. Glucosinolates. Pages 1-41 in Cheeke, P. R., ed. Toxicants of plant origin. Vol. II. Glycosides. CRC Press, Inc., Boca Raton, Fla., USA. 277 pp.

[Another search?](#)

[Français](#) | [Contact Us](#) | [Help](#) | [Search](#) | [Canada site](#)
[Coming Events](#) | [About CBIF](#) | [Links](#) | [Reports and Publications](#) | [Home](#)

Date modified: 2003-02-06

[Important Notices](#)



Français	Contact us	Help	Search	Canada site
Coming events	About CBIF	Links	Reports and publications	Home

Canadian Biodiversity Information Facility



Notes on poisoning: *Caladium bicolor*

[Introduction](#)[Interactive](#)[All poisonous plants by Botanical name](#)[All poisonous plants by Common name](#)[Important WWW Poisonous Plants sites](#)

General poisoning notes:

Caladium (*Caladium bicolor*) is a houseplant that can cause burning and irritation of the lips. The plant can be a problem to children who ingest the leaves as well as to family pets that might nibble on the foliage.



References:

Lampe, K. F., McCann, M. A. 1985. AMA Handbook of poisonous and injurious plants. American Medical Assoc. Chicago, Ill., USA. 432 pp.

Spoerke, D. G., Smolinske, S. C. 1990. Toxicity of houseplants. CRC Press, Inc., Boca Raton, Fla., USA. 335 pp.

Nomenclature:

Scientific Name: *Caladium bicolor* (Ait.) Vent.

Vernacular name(s): caladium

Scientific family name: *Araceae*

Vernacular family name: arum

Go to ITIS^{*ca} for more taxonomic information on: [Caladium bicolor](#)

References:

Agriculture Quebec. 1975. Noms des maladies des plantes du Canada/ Names of plant diseases in Canada. , Quebec City, Que., Canada. 288 pp.

Alex, J. F., Cayouette, R., Mulligan, G. A. 1980. Common and botanical names of weeds in Canada/Noms populaire et

scientifiques des plantes nuisibles du Canada. Revised. Agric. Can. Publ., Ottawa, Ont., Canada. 132 pp.

Bailey, L. H., Bailey, E. Z. 1976. Hortus third. Revised. MacMillan, New York, N.Y., USA. 1290 pp.

Scoggan, H. J. 1978, 1979. The flora of Canada. Nat. Mus. Nat. Sci. (Ottawa) Publ. Bot. 7(1)-7(4). 1711 pp.

Van Wijk, H. L. 1911. A dictionary of plant names. Martinus Nijhoff, The Hague, The Netherlands. 1444 pp.

Victorin, M. 1964. Flore Laurentienne. 2nd ed. Univ. Montreal, Montreal, Que., Canada. 952 pp.

Geographic Information

Plant or plant parts used in or around the home.

References:

Bailey, L. H., Bailey, E. Z. 1976. Hortus third. Revised. MacMillan, New York, N.Y., USA. 1290 pp.

Boivin, B. 1966, 1967. Énumération des plantes du Canada. Provencheria 6. Nat. Can. (Que.) 93: 253-274; 371-437; 583-646; 989-1063. 94: 131-157; 471-528; 625-655.

Image or illustration

Caladium bicolor:

Images: images.google.com

Notes on Poisonous plant parts:

All parts of this plant contain oxalate crystals, which can cause intense irritation if ingested (Lampe and McCann 1985).

Toxic parts:

leaves
roots
stems

References:

Lampe, K. F., McCann, M. A. 1985. AMA Handbook of poisonous and injurious plants. American Medical Assoc. Chicago, Ill., USA. 432 pp.

Notes on Toxic plant chemicals:

Oxalate crystals are common to many members of the family Araceae and are capable of causing intense irritation.

Toxic plant chemicals:

oxalate

References:

Lampe, K. F., McCann, M. A. 1985. AMA Handbook of poisonous and injurious plants. American Medical Assoc. Chicago, Ill., USA. 432 pp.

Animals/Human Poisoning:

Note: When an animal is listed without additional information, the literature (as of 1993) contained no detailed explanation.

Cats

Dogs

Humans

General symptoms of poisoning:

[mouth, irritation of](#)

Notes on poisoning:

Ingesting material containing calcium oxalate raphide crystals causes irritation of the soft mouth parts and perhaps the throat of humans and animals. Swelling of tissues causes pain and a burning sensation that slowly subsides. Cool liquids or analgesics may be indicated. The insoluble oxalates do not cause systemic poisoning (Lampe and McCann 1985).

References:

Lampe, K. F., McCann, M. A. 1985. AMA Handbook of poisonous and injurious plants. American Medical Assoc. Chicago, Ill., USA. 432 pp.

[Another search?](#)

[Français](#) | [Contact Us](#) | [Help](#) | [Search](#) | [Canada site](#)

[Coming Events](#) | [About CBIF](#) | [Links](#) | [Reports and Publications](#) | [Home](#)

Date modified: 2003-02-06

[Important Notices](#)



Français	Contact us	Help	Search	Canada site
Coming events	About CBIF	Links	Reports and publications	Home

Canadian Biodiversity Information Facility



Notes on poisoning: *Calla palustris*

[Introduction](#)

[Interactive](#)

[All poisonous plants by Botanical name](#)

[All poisonous plants by Common name](#)

[Important WWW Poisonous Plants sites](#)



General poisoning notes:

Wild calla (*Calla palustris*) is a native plant that grows in swamps and marshes through much of Canada. Calcium oxalates occur, which can cause severe irritation of the mouth and throat. No cases of livestock poisoning are found in the literature, but the potential for poisoning is present. Humans are also at risk from this plant (Kingsbury 1964, Lampe and McCann 1985).

References:

Lampe, K. F., McCann, M. A. 1985. AMA Handbook of poisonous and injurious plants. American Medical Assoc. Chicago, Ill., USA. 432 pp.

Nomenclature:

Scientific Name: *Calla palustris* L.

Vernacular name(s): wild calla

Scientific family name: *Araceae*

Vernacular family name: arum

Go to ITIS*^{ca} for more taxonomic information on: [Calla palustris](#)

References:

Agriculture Quebec. 1975. Noms des maladies des plantes du Canada/ Names of plant diseases in Canada. , Quebec City, Que., Canada. 288 pp.

Alex, J. F., Cayouette, R., Mulligan, G. A. 1980. Common and botanical names of weeds in Canada/Noms populaire et scientifiques des plantes nuisibles du Canada. Revised. Agric. Can. Publ., Ottawa, Ont., Canada. 132 pp.

Bailey, L. H., Bailey, E. Z. 1976. Hortus third. Revised. MacMillan, New York, N.Y., USA. 1290 pp.

Scoggan, H. J. 1978, 1979. The flora of Canada. Nat. Mus. Nat. Sci. (Ottawa) Publ. Bot. 7(1)-7(4). 1711 pp.

Van Wijk, H. L. 1911. A dictionary of plant names. Martinus Nijhoff, The Hague, The Netherlands. 1444 pp.

Victorin, M. 1964. Flore Laurentienne. 2nd ed. Univ. Montreal, Montreal, Que., Canada. 952 pp.

Geographic Information

Alberta
British Columbia
Labrador
Manitoba
New Brunswick
Newfoundland
Northwest Territories
Nova Scotia
Ontario
Prince Edward Island
Quebec
Saskatchewan
Yukon Territory

References:

Bailey, L. H., Bailey, E. Z. 1976. Hortus third. Revised. MacMillan, New York, N.Y., USA. 1290 pp.

Boivin, B. 1966, 1967. Énumération des plantes du Canada. Provencheria 6. Nat. Can. (Que.) 93: 253-274; 371-437; 583-646; 989-1063. 94: 131-157; 471-528; 625-655.

Image or illustration

Calla palustris:

Images: images.google.com

Notes on Poisonous plant parts:

All parts of the plant contain calcium oxalate crystals, which can cause irritation of the mouth and throat (Lampe and McCann 1985).

Toxic parts:

leaves
rhizome
roots
stems

References:

Lampe, K. F., McCann, M. A. 1985. AMA Handbook of poisonous and injurious plants. American Medical Assoc. Chicago, Ill., USA. 432 pp.

Toxic plant chemicals:

oxalate

References:

Lampe, K. F., McCann, M. A. 1985. AMA Handbook of poisonous and injurious plants. American Medical Assoc. Chicago, Ill., USA. 432 pp.

Animals/Human Poisoning:

Note: When an animal is listed without additional information, the literature (as of 1993) contained no detailed explanation.

Cattle

Humans

General symptoms of poisoning:

[mouth, irritation of](#)

Notes on poisoning:

Mouth and throat irritation, accompanied by pain and swelling, occurs upon chewing of plant parts. The insoluble oxalates do not produce systemic poisoning in humans. Washing or heating the rhizome can inactivate the oxalates. In northern Europe the ground rhizome is used as flour for bread (Frohne and Pfander 1983, Lampe and McCann 1985).

References:

Lampe, K. F., McCann, M. A. 1985. AMA Handbook of poisonous and injurious plants. American Medical Assoc. Chicago, Ill., USA. 432 pp.

[Another search?](#)

[Français](#) | [Contact Us](#) | [Help](#) | [Search](#) | [Canada site](#)

[Coming Events](#) | [About CBIF](#) | [Links](#) | [Reports and Publications](#) |

[Home](#)

Date modified: 2003-02-06

[Important Notices](#)



Français	Contact us	Help	Search	Canada site
Coming events	About CBIF	Links	Reports and publications	Home

Canadian Biodiversity Information Facility



Notes on poisoning: *Cannabis sativa*

[Introduction](#)[Interactive](#)[All poisonous plants by Botanical name](#)[All poisonous plants by Common name](#)[Important WWW Poisonous Plants sites](#)

General poisoning notes:

Accidental ingestion of marijuana (*Cannabis sativa*) by pets is an occasional problem. Family pets or young children may accidentally ingest the plant, which may be stored in plastic bags. A dog ingested hashish brownies and then exhibited various symptoms such as hyperactivity, vomiting, somnolence, staggering, and glazed eyes. In another case, in Edmonton, a pet ferret ingested the plant and became comatose after experiencing sneezing bouts and ataxia. Although no fatalities of humans have been reported, the effects on a young child accidentally ingesting marijuana are bound to be very disturbing to the parents (Jones 1978, Smith 1988).

References:

- Jones, D. L. 1978. A case of canine cannabis ingestion. N. Z. Vet. J., 26: 135-136.
- Smith, R. A. 1988. Coma in a ferret after ingestion of cannabis. Vet. Hum. Toxicol., 30: 486.

Nomenclature:

Scientific Name: *Cannabis sativa* L.

Vernacular name(s): marijuana

Scientific family name: *Cannabinaceae*

Vernacular family name: hemp

Go to ITIS^{*ca} for more taxonomic information on: [Cannabis sativa](#)

References:

Agriculture Quebec. 1975. Noms des maladies des plantes du Canada/ Names of plant diseases in Canada. , Quebec City, Que., Canada. 288 pp.

Alex, J. F., Cayouette, R., Mulligan, G. A. 1980. Common and botanical names of weeds in Canada/Noms populaire et scientifiques des plantes nuisibles du Canada. Revised. Agric. Can. Publ., Ottawa, Ont., Canada. 132 pp.

Bailey, L. H., Bailey, E. Z. 1976. Hortus third. Revised. MacMillan, New York, N.Y., USA. 1290 pp.

Scoggan, H. J. 1978, 1979. The flora of Canada. Nat. Mus. Nat. Sci. (Ottawa) Publ. Bot. 7(1)-7(4). 1711 pp.

Van Wijk, H. L. 1911. A dictionary of plant names. Martinus Nijhoff, The Hague, The Netherlands. 1444 pp.

Victorin, M. 1964. Flore Laurentienne. 2nd ed. Univ. Montreal, Montreal, Que., Canada. 952 pp.

Geographic Information

Alberta
British Columbia
Manitoba
Ontario
Quebec

References:

Bailey, L. H., Bailey, E. Z. 1976. Hortus third. Revised. MacMillan, New York, N.Y., USA. 1290 pp.

Boivin, B. 1966, 1967. Énumération des plantes du Canada. Provencheria 6. Nat. Can. (Que.) 93: 253-274; 371-437; 583-646; 989-1063. 94: 131-157; 471-528; 625-655.

Image or illustration

Cannabis sativa:

Images: images.google.com

Notes on Poisonous plant parts:

The resins in the leaves are psychoactive in mammals, including humans. These plants are cultivated indoors and outdoors for human use. The plants can overwinter as seed in warmer parts of

the country. The most common form that may be accidentally ingested by humans and pets is marijuana that has been left in houses for illegal human use.

Toxic parts:

flowers

leaves

References:

Small, E., Cronquist, A. 1976. A practical and natural taxonomy for *Cannabis*. *Taxon*, 25: 405-435.

Notes on Toxic plant chemicals:

Delta-tetrahydrocannabinol (THC) is the chemical most often cited as causing the psychoactive compound in marijuana. This chemical affects humans and many other mammals. Any children or pets that accidentally ingest quantities of marijuana may show various symptoms, including coma.

Toxic plant chemicals:

tetrahydrocannabinol

References:

Small, E., Cronquist, A. 1976. A practical and natural taxonomy for *Cannabis*. *Taxon*, 25: 405-435.

Animals/Human Poisoning:

Note: When an animal is listed without additional information, the literature (as of 1993) contained no detailed explanation.

Dogs

General symptoms of poisoning:

[agitation](#)

[drowsiness](#)

[gait, staggering](#)

[unconsciousness](#)

[vomiting](#)

References:

Jones, D. L. 1978. A case of canine cannabis ingestion. N. Z. Vet. J., 26: 135-136.

Ferrets

General symptoms of poisoning:

[ataxia](#)

[coma](#)

[temperature, depressed](#)

References:

Smith, R. A. 1988. Coma in a ferret after ingestion of cannabis. Vet. Hum. Toxicol., 30: 486.

[Another search?](#)

[Français](#) | [Contact Us](#) | [Help](#) | [Search](#) | [Canada site](#)

[Coming Events](#) | [About CBIF](#) | [Links](#) | [Reports and Publications](#) |

[Home](#)

Date modified: 2003-02-06

[Important Notices](#)



Français	Contact us	Help	Search	Canada site
Coming events	About CBIF	Links	Reports and publications	Home

Canadian Biodiversity Information Facility



Notes on poisoning: *Caulophyllum* *thalictroides*

[Introduction](#)[Interactive](#)[All poisonous plants by Botanical name](#)[All poisonous plants by Common name](#)[Important WWW Poisonous Plants sites](#)

General poisoning notes:



Blue cohosh (*Caulophyllum thalictroides*) is a native plant found in rich woods in eastern Canada. The plant contains chemicals that can cause cell damage. Experiments show that handling powdered root can cause irritation of mucous membranes, with possible dermatitis. No case histories of poisoning were found in the literature, but the plant has poisoning potential. Children should not be allowed to eat the attractive blue fruits of this plant (Muenscher 1975, Lampe and McCann 1985). No references were found of poisoning of livestock.

References:

Lampe, K. F., McCann, M. A. 1985. AMA Handbook of poisonous and injurious plants. American Medical Assoc. Chicago, Ill., USA. 432 pp.

Nomenclature:

Scientific Name: *Caulophyllum thalictroides* (L.) Michaux

Vernacular name(s): blue cohosh

Scientific family name: *Berberidaceae*

Vernacular family name: barberry

Go to ITIS*^{ca} for more taxonomic information on: [Caulophyllum thalictroides](#)

References:

Agriculture Quebec. 1975. Noms des maladies des plantes du

Canada/ Names of plant diseases in Canada. , Quebec City, Que., Canada. 288 pp.

Alex, J. F., Cayouette, R., Mulligan, G. A. 1980. Common and botanical names of weeds in Canada/Noms populaire et scientifiques des plantes nuisibles du Canada. Revised. Agric. Can. Publ., Ottawa, Ont., Canada. 132 pp.

Bailey, L. H., Bailey, E. Z. 1976. Hortus third. Revised. MacMillan, New York, N.Y., USA. 1290 pp.

Scoggan, H. J. 1978, 1979. The flora of Canada. Nat. Mus. Nat. Sci. (Ottawa) Publ. Bot. 7(1)-7(4). 1711 pp.

Van Wijk, H. L. 1911. A dictionary of plant names. Martinus Nijhoff, The Hague, The Netherlands. 1444 pp.

Victorin, M. 1964. Flore Laurentienne. 2nd ed. Univ. Montreal, Montreal, Que., Canada. 952 pp.

Geographic Information

Manitoba
New Brunswick
Nova Scotia
Ontario
Quebec

References:

Bailey, L. H., Bailey, E. Z. 1976. Hortus third. Revised. MacMillan, New York, N.Y., USA. 1290 pp.

Boivin, B. 1966, 1967. Énumération des plantes du Canada. Provencheria 6. Nat. Can. (Que.) 93: 253-274; 371-437; 583-646; 989-1063. 94: 131-157; 471-528; 625-655.

Image or illustration

Caulophyllum thalictroides:

Images: images.google.com

Notes on Poisonous plant parts:

The berries and roots contain chemicals that are cytotoxic, causing cell damage. The plant is extremely bitter and is not usually ingested by livestock. (Muenscher 1975, Lampe and McCann 1985).

Toxic parts:

mature fruit
roots

References:

Lampe, K. F., McCann, M. A. 1985. AMA Handbook of poisonous and injurious plants. American Medical Assoc. Chicago, Ill., USA. 432 pp.

Muenschler, W. C. 1975. Poisonous plants of the United States. Revised. Collier Books, New York, N.Y., USA. 277 pp.

Notes on Toxic plant chemicals:

An alkaloid and saponins occur in this plant. The chemicals are cytotoxic, damaging animal cells. The plant is reported to have orally active oxytocic substances, which cause uterine contractions (Fergusen and Edwards 1954, Lampe and McCann 1985).

Toxic plant chemicals:

N-methylcytisine

References:

Lampe, K. F., McCann, M. A. 1985. AMA Handbook of poisonous and injurious plants. American Medical Assoc. Chicago, Ill., USA. 432 pp.

Animals/Human Poisoning:

Note: When an animal is listed without additional information, the literature (as of 1993) contained no detailed explanation.

Humans

General symptoms of poisoning:

[mouth, irritation of](#)

References:

Lampe, K. F., McCann, M. A. 1985. AMA Handbook of poisonous and injurious plants. American Medical Assoc. Chicago, Ill., USA. 432 pp.

[Another search?](#)

[Français](#) | [Contact Us](#) | [Help](#) | [Search](#) | [Canada site](#)

[Coming Events](#) | [About CBIF](#) | [Links](#) | [Reports and Publications](#) |

[Home](#)

Date modified: 2003-02-06

[Important Notices](#)



Français	Contact us	Help	Search	Canada site
Coming events	About CBIF	Links	Reports and publications	Home

Canadian Biodiversity Information Facility



Notes on poisoning: *Centaurea repens*

[Introduction](#)[Interactive](#)[All poisonous plants by Botanical name](#)[All poisonous plants by Common name](#)[Important WWW Poisonous Plants sites](#)

General poisoning notes:

Russian knapweed (*Centaurea repens*) and yellow star-thistle (*Centaurea solstitialis*) are both naturalized in western Canada. Both plants cause chewing disease in horses. The problem is restricted to horses. Prolonged consumption of the plants is required to produce the symptoms. Russian knapweed is more toxic than yellow star-thistle (Cheeke and Schull 1985, Panter 1990):



- intake of 1.8-2.5 kg/100 kg of body weight per day of Russian knapweed causes toxicity after ingesting 59-71% of its body weight of the plant material in about 30 days;

- intake of 2.3-2.6 kg/100 kg of body weight per day of yellow star-thistle causes toxicity after ingesting 86-200% of its body weight of the plant material in about 54 days.

There are no known treatments for horses once the symptoms appear.

References:

Cheeke, P. R., Shull, L. R. 1985. Natural toxicants in feeds and poisonous plants. AVI Publishing Company, Inc., Westport, Conn., USA. 492 pp.

Cordy, D. R. 1978. *Centaurea* species and equine nigropallidal encephalomalacia. Pages 327-336 in Keeler, R. F., Van Kampen, K. R., James, L. F., eds. Effects of poisonous plants on livestock. Academic Press, New York, N.Y., USA. 600 pp.

Panter, K. E. 1990. Toxicity of knapweed in horses. Wash. State Univ. Knapweed, 4(3): 2.

Nomenclature:

Scientific Name: *Centaurea repens* L.

Vernacular name(s): Russian knapweed

Scientific family name: *Compositae*

Vernacular family name: composite

Go to ITIS*^{ca} for more taxonomic information on:

[Centaurea repens](#)

References:

Agriculture Quebec. 1975. Noms des maladies des plantes du Canada/ Names of plant diseases in Canada. , Quebec City, Que., Canada. 288 pp.

Alex, J. F., Cayouette, R., Mulligan, G. A. 1980. Common and botanical names of weeds in Canada/Noms populaire et scientifiques des plantes nuisibles du Canada. Revised. Agric. Can. Publ., Ottawa, Ont., Canada. 132 pp.

Bailey, L. H., Bailey, E. Z. 1976. Hortus third. Revised. MacMillan, New York, N.Y., USA. 1290 pp.

Scoggan, H. J. 1978, 1979. The flora of Canada. Nat. Mus. Nat. Sci. (Ottawa) Publ. Bot. 7(1)-7(4). 1711 pp.

Van Wijk, H. L. 1911. A dictionary of plant names. Martinus Nijhoff, The Hague, The Netherlands. 1444 pp.

Victorin, M. 1964. Flore Laurentienne. 2nd ed. Univ. Montreal, Montreal, Que., Canada. 952 pp.

Geographic Information

Alberta

British Columbia

Manitoba

Ontario

Saskatchewan

References:

Bailey, L. H., Bailey, E. Z. 1976. Hortus third. Revised. MacMillan, New York, N.Y., USA. 1290 pp.

Boivin, B. 1966, 1967. Énumération des plantes du Canada. Provencheria 6. Nat. Can. (Que.) 93: 253-274; 371-437; 583-646; 989-1063. 94: 131-157; 471-528; 625-655.

Image or illustration

Centaurea repens:

Images: images.google.com

Notes on Poisonous plant parts:

Horses must ingest fresh aboveground plant material for prolonged periods to reach a threshold level of unknown toxicity and then the symptoms appear abruptly. Chewing disease in horses has occurred in parts of the western United States. In California the peak times of disease onset are June-July and October-November (Cordy 1978).

Toxic parts:

leaves
mature fruit
stems

References:

Cheeke, P. R., Shull, L. R. 1985. Natural toxicants in feeds and poisonous plants. AVI Publishing Company, Inc., Westport, Conn., USA. 492 pp.

Cordy, D. R. 1978. *Centaurea* species and equine nigropallidal encephalomalacia. Pages 327-336 in Keeler, R. F., Van Kampen, K. R., James, L. F., eds. Effects of poisonous plants on livestock. Academic Press, New York, N.Y., USA. 600 pp.

Mettler, F. A., Stern, G. M. 1963. Observations on the toxic effects of yellow star thistle. J. Neuropathol. & Exp. Neurol., 22: 164-169.

Toxic plant chemicals:

unknown chemical

References:

Cheeke, P. R., Shull, L. R. 1985. Natural toxicants in feeds and poisonous plants. AVI Publishing Company, Inc., Westport, Conn., USA. 492 pp.

Animals/Human Poisoning:

Note: When an animal is listed without additional information, the literature (as of 1993) contained no detailed explanation.

Horses

General symptoms of poisoning:

[drowsiness](#)

[gait, unsteady](#)

[incoordination](#)

[restlessness](#)

References:

Cheeke, P. R., Shull, L. R. 1985. Natural toxicants in feeds and poisonous plants. AVI Publishing Company, Inc., Westport, Conn., USA. 492 pp.

[Another search?](#)

[Français](#) | [Contact Us](#) | [Help](#) | [Search](#) | [Canada site](#)

[Coming Events](#) | [About CBIF](#) | [Links](#) | [Reports and Publications](#) |

[Home](#)

Date modified: 2003-02-06

[Important Notices](#)



Français	Contact us	Help	Search	Canada site
Coming events	About CBIF	Links	Reports and publications	Home

Canadian Biodiversity Information Facility



Notes on poisoning: *Centaurea solstitialis*

[Introduction](#)[Interactive](#)[All poisonous plants by Botanical name](#)[All poisonous plants by Common name](#)[Important WWW Poisonous Plants sites](#)

General poisoning notes:

Yellow star-thistle (*Centaurea solstitialis*) has the same toxic effect on horses as Russian thistle, which is more toxic. Chewing disease becomes incurable once clinical signs are present (Cordy 1987). See the general notes under Russian thistle.



References:

Cordy, D. R. 1978. *Centaurea* species and equine nigropallidal encephalomalacia. Pages 327-336 in Keeler, R. F., Van Kampen, K. R., James, L. F., eds. Effects of poisonous plants on livestock. Academic Press, New York, N.Y., USA. 600 pp.

Nomenclature:

Scientific Name: *Centaurea solstitialis* L.

Vernacular name(s): yellow star-thistle

Scientific family name: *Compositae*

Vernacular family name: composite

Go to ITIS^{*ca} for more taxonomic information on: [Centaurea solstitialis](#)

References:

Agriculture Quebec. 1975. Noms des maladies des plantes du Canada/ Names of plant diseases in Canada. , Quebec City, Que., Canada. 288 pp.

Alex, J. F., Cayouette, R., Mulligan, G. A. 1980. Common and botanical names of weeds in Canada/Noms populaire et scientifiques des plantes nuisibles du Canada. Revised. Agric. Can. Publ., Ottawa, Ont., Canada. 132 pp.

Bailey, L. H., Bailey, E. Z. 1976. Hortus third. Revised. MacMillan, New York, N.Y., USA. 1290 pp.

Scoggan, H. J. 1978, 1979. The flora of Canada. Nat. Mus. Nat. Sci. (Ottawa) Publ. Bot. 7(1)-7(4). 1711 pp.

Van Wijk, H. L. 1911. A dictionary of plant names. Martinus Nijhoff, The Hague, The Netherlands. 1444 pp.

Victorin, M. 1964. Flore Laurentienne. 2nd ed. Univ. Montreal, Montreal, Que., Canada. 952 pp.

Geographic Information

Manitoba

Ontario

Saskatchewan

References:

Bailey, L. H., Bailey, E. Z. 1976. Hortus third. Revised. MacMillan, New York, N.Y., USA. 1290 pp.

Boivin, B. 1966, 1967. Énumération des plantes du Canada. Provencheria 6. Nat. Can. (Que.) 93: 253-274; 371-437; 583-646; 989-1063. 94: 131-157; 471-528; 625-655.

Image or illustration

Centaurea solstitialis:

Images: images.google.com

Toxic parts:

all parts

leaves

stems

References:

Cordy, D. R. 1978. *Centaurea* species and equine nigropallidal encephalomalacia. Pages 327-336 in Keeler, R. F., Van Kampen, K. R., James, L. F., eds. Effects of poisonous plants on livestock. Academic Press, New York, N.Y., USA. 600 pp.

Toxic plant chemicals:

unknown chemical

References:

Cordy, D. R. 1978. *Centaurea* species and equine nigropallidal encephalomalacia. Pages 327-336 in Keeler, R. F., Van Kampen, K. R., James, L. F., eds. Effects of poisonous plants on livestock. Academic Press, New York, N.Y., USA. 600 pp.

Animals/Human Poisoning:

Note: When an animal is listed without additional information, the literature (as of 1993) contained no detailed explanation.

Horses

General symptoms of poisoning:

[death](#)

[incoordination](#)

[water intake, reduced](#)

References:

Cordy, D. R. 1978. *Centaurea* species and equine nigropallidal encephalomalacia. Pages 327-336 in Keeler, R. F., Van Kampen, K. R., James, L. F., eds. Effects of poisonous plants on livestock. Academic Press, New York, N.Y., USA. 600 pp.

[Another search?](#)

[Français](#) | [Contact Us](#) | [Help](#) | [Search](#) | [Canada site](#)

[Coming Events](#) | [About CBIF](#) | [Links](#) | [Reports and Publications](#) | [Home](#)

Date modified: 2003-02-06

[Important Notices](#)



Français	Contact us	Help	Search	Canada site
Coming events	About CBIF	Links	Reports and publications	Home

Canadian Biodiversity Information Facility



Notes on poisoning:

Ceratocephalus

testiculatus

[Introduction](#)[Interactive](#)[All poisonous plants by Botanical name](#)[All poisonous plants by Common name](#)[Important WWW Poisonous Plants sites](#)

General poisoning notes:

Bur buttercup (*Ceratocephalus testiculatus*) is an introduced herb that so far is known only from around Kamloops, British Columbia. This plant is found in several western states bordering Canada, where it is rapidly spreading. The plant has also been found on South Bass Island in Ohio on Lake Erie. This plant contains ranunculin, as do some species of the genus *Ranunculus* (buttercup). This chemical changes into a toxic chemical when the plant is crushed. Sheep have been poisoned and have died in the western United States after ingesting aboveground plant material; this plant is considered highly toxic. About 500 g of green plant can kill a 45-kg sheep. This plant grows in dry sandy areas, such as sage slopes and in livestock pens, and has recently been found as a weed in grain and alfalfa fields (Olsen et al. 1983, Cusick 1989).

References:

Cusick, A. W. 1989. Bur buttercup (*Ceratocephalus testiculatus*: Ranunculaceae): a poisonous plant newly established in Ohio. Mich. Bot., 28: 33-35.

Olsen, J. D., Anderson, T. E., Murphy, J. C., Madsen, G. 1983. Bur buttercup poisoning of sheep. J. Am. Vet. Med. Assoc., 183: 538-543.

Nomenclature:

Scientific Name: *Ceratocephalus testiculatus* (Crantz) Roth

Vernacular name(s): bur buttercup

Scientific family name: *Ranunculaceae*

Vernacular family name: crowfoot

References:

Agriculture Quebec. 1975. Noms des maladies des plantes du Canada/ Names of plant diseases in Canada. , Quebec City, Que., Canada. 288 pp.

Alex, J. F., Cayouette, R., Mulligan, G. A. 1980. Common and botanical names of weeds in Canada/Noms populaire et scientifiques des plantes nuisibles du Canada. Revised. Agric. Can. Publ., Ottawa, Ont., Canada. 132 pp.

Bailey, L. H., Bailey, E. Z. 1976. Hortus third. Revised. MacMillan, New York, N.Y., USA. 1290 pp.

Scoggan, H. J. 1978, 1979. The flora of Canada. Nat. Mus. Nat. Sci. (Ottawa) Publ. Bot. 7(1)-7(4). 1711 pp.

Van Wijk, H. L. 1911. A dictionary of plant names. Martinus Nijhoff, The Hague, The Netherlands. 1444 pp.

Victorin, M. 1964. Flore Laurentienne. 2nd ed. Univ. Montreal, Montreal, Que., Canada. 952 pp.

Geographic Information

British Columbia

References:

Bailey, L. H., Bailey, E. Z. 1976. Hortus third. Revised. MacMillan, New York, N.Y., USA. 1290 pp.

Boivin, B. 1966, 1967. Énumération des plantes du Canada. Provencheria 6. Nat. Can. (Que.) 93: 253-274; 371-437; 583-646; 989-1063. 94: 131-157; 471-528; 625-655.

Image or illustration

Ceratocephalus testiculatus:

Images: images.google.com

Toxic parts:

plant juices

References:

Cusick, A. W. 1989. Bur buttercup (*Ceratocephalus testiculatus*: Ranunculaceae): a poisonous plant newly established in Ohio.

Mich. Bot., 28: 33-35.

Notes on Toxic plant chemicals:

Crushing the plant releases an enzyme that changes ranunculin, a glycoside, to protoanemonin, a highly irritant, yellow, volatile oil. This chemical is unstable and changes to nontoxic anemonin or volatilizes upon drying, leaving nontoxic plant material. The median LD-50 was 10.9 g/kg for sheep fed aboveground plant parts in the flower to early-seed stage. A sheep fed 7 g/kg of body weight might develop transient anorectic effects. Intake of 13.9 g/kg or greater would usually be lethal (Olsen et al. 1983).

Toxic plant chemicals:

ranunculin

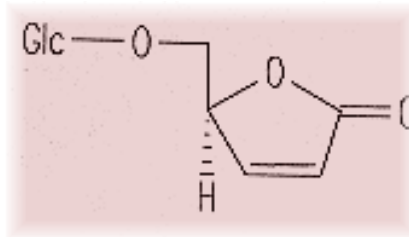

Chemical diagram(s) are courtesy of [Ruth McDiarmid](#), Biochemistry Technician, Kamloops Range Station, Agriculture and Agri-Food Canada, Kamloops, British Columbia, Canada.

References:

Olsen, J. D., Anderson, T. E., Murphy, J. C., Madsen, G. 1983. Bur buttercup poisoning of sheep. *J. Am. Vet. Med. Assoc.*, 183: 538-543.

Animals/Human Poisoning:

Note: When an animal is listed without additional information, the literature (as of 1993) contained no detailed explanation.

Sheep

General symptoms of poisoning:

[anorexia](#)
[breathing, labored](#)
[death](#)
[diarrhea](#)
[dyspnea](#)
[recumbency](#)

[weakness](#)

Notes on poisoning:

In Utah 150 of 800 sheep that ingested bur buttercup died. Symptoms took less than 24 h and included watery diarrhea, recumbency, weakness, and death. Experimental feeding showed more complete signs, such as tachycardia, dyspnea, anorexia, and occasional fever. Post-mortem findings revealed edema of the peritoneal surface to the ruminoreticulum, subendocardial hemorrhages in the left ventricle, and congestion of the heart, kidneys, liver and lungs. Severity was directly related to the dosage. Death results apparently as a failure of the cardiovascular system, with massive fluid shifts (Olsen et al. 1983).

References:

Olsen, J. D., Anderson, T. E., Murphy, J. C., Madsen, G. 1983. Bur buttercup poisoning of sheep. J. Am. Vet. Med. Assoc., 183: 538-543.

[Another search?](#)

[Français](#) | [Contact Us](#) | [Help](#) | [Search](#) | [Canada site](#)
[Coming Events](#) | [About CBIF](#) | [Links](#) | [Reports and Publications](#) |
[Home](#)

Date modified: 2003-02-06

[Important Notices](#)



Français	Contact us	Help	Search	Canada site
Coming events	About CBIF	Links	Reports and publications	Home

Canadian Biodiversity Information Facility



Notes on poisoning: *Chelidonium majus*

[Introduction](#)[Interactive](#)[All poisonous plants by Botanical name](#)[All poisonous plants by Common name](#)[Important WWW Poisonous Plants sites](#)

General poisoning notes:

Greater celandine (*Chelidonium majus*) is a perennial naturalized herb found in parts of eastern Canada. This plant is suspected in the death of a four-year old boy (Koopman 1937). There are records of skin irritation and soreness after the latex is applied to the skin, a practice that was followed in Europe to help minor skin injuries (Cooper and Johnson 1984). Cattle were poisoned and died in Britain after ingesting the ripe fruit of this plant (Reeks 1903); 500 g of the plant can cause toxic effects in horses or cattle (Frohne and Pfander 1983).

References:

Cooper, M. R., Johnson, A. W. 1984. Poisonous plants in Britain and their effects on animals and man. Her Majesty's Stationery Office, London, England. 305 pp.

Frohne, D., Pfander, H. J. 1983. A colour atlas of poisonous plants. Wolfe Publishing Ltd., London, England. 291 pp.

Koopman, H. 1937. A fatal case of celandine poisoning. Sammlung von Vergiftungsfallen, 8: 93-98.

Reeks, H. C. 1903. Poisoning of cattle by common celandine. J. Comp. Pathol. Ther., 16: 367-371.

Nomenclature:

Scientific Name: *Chelidonium majus* L.

Vernacular name(s): greater celandine

Scientific family name: *Papaveraceae*

Vernacular family name: poppy

Go to ITIS^{*ca} for more taxonomic information on: [Chelidonium](#)

[*majus*](#)

References:

Agriculture Quebec. 1975. Noms des maladies des plantes du Canada/ Names of plant diseases in Canada. , Quebec City, Que., Canada. 288 pp.

Alex, J. F., Cayouette, R., Mulligan, G. A. 1980. Common and botanical names of weeds in Canada/Noms populaire et scientifiques des plantes nuisibles du Canada. Revised. Agric. Can. Publ., Ottawa, Ont., Canada. 132 pp.

Bailey, L. H., Bailey, E. Z. 1976. Hortus third. Revised. MacMillan, New York, N.Y., USA. 1290 pp.

Scoggan, H. J. 1978, 1979. The flora of Canada. Nat. Mus. Nat. Sci. (Ottawa) Publ. Bot. 7(1)-7(4). 1711 pp.

Van Wijk, H. L. 1911. A dictionary of plant names. Martinus Nijhoff, The Hague, The Netherlands. 1444 pp.

Victorin, M. 1964. Flore Laurentienne. 2nd ed. Univ. Montreal, Montreal, Que., Canada. 952 pp.

Geographic Information

New Brunswick

Ontario

Prince Edward Island

Quebec

References:

Bailey, L. H., Bailey, E. Z. 1976. Hortus third. Revised. MacMillan, New York, N.Y., USA. 1290 pp.

Boivin, B. 1966, 1967. Énumération des plantes du Canada. Provencheria 6. Nat. Can. (Que.) 93: 253-274; 371-437; 583-646; 989-1063. 94: 131-157; 471-528; 625-655.

Image or illustration

Chelidonium majus:

Images: images.google.com

Notes on Poisonous plant parts:

The entire plant is considered poisonous. The plant contains bright yellow latex that turns reddish after exposure to air. The

plant is considered unpalatable because of its acrid taste and pungent, fetid smell (Frohne and Pfander 1983, Cooper and Johnson 1984).

Toxic parts:

latex

References:

Cooper, M. R., Johnson, A. W. 1984. Poisonous plants in Britain and their effects on animals and man. Her Majesty's Stationery Office, London, England. 305 pp.

Frohne, D., Pfander, H. J. 1983. A colour atlas of poisonous plants. Wolfe Publishing Ltd., London, England. 291 pp.

Notes on Toxic plant chemicals:

Chelidonine is the major alkaloid found in greater celandine. At least 20 other alkaloids have been found in the plant. The concentration of these alkaloids varies in various plant organs, depending on the stage of growth (Frohne and Pfander 1983).

Toxic plant chemicals:

chelidonine

References:

Cooper, M. R., Johnson, A. W. 1984. Poisonous plants in Britain and their effects on animals and man. Her Majesty's Stationery Office, London, England. 305 pp.

Frohne, D., Pfander, H. J. 1983. A colour atlas of poisonous plants. Wolfe Publishing Ltd., London, England. 291 pp.

Animals/Human Poisoning:

Note: When an animal is listed without additional information, the literature (as of 1993) contained no detailed explanation.

Cattle

General symptoms of poisoning:

[convulsions](#)

[death](#)

[drowsiness](#)

[gait, staggering](#)
[salivation](#)

Notes on poisoning:

One case of cattle poisoning is attributed to this plant. The cattle became drowsy, had a staggering gait, salivated, and some cows died. Calves that suckled the poisoned cows were unaffected. Postmortem examination revealed gastrointestinal irritation (Reeks 1903).

References:

Reeks, H. C. 1903. Poisoning of cattle by common celandine. J. Comp. Pathol. Ther., 16: 367-371.

Humans

General symptoms of poisoning:

[coma](#)
[death](#)
[diarrhea](#)
[drowsiness](#)
[headache](#)

Notes on poisoning:

The case of a 4-year-old boy who sickened and died is cited in the literature. Postmortem examination showed severe irritation of the large intestine. The cause of death was suspected to be greater celandine (Koopman 1937).

References:

Koopman, H. 1937. A fatal case of celandine poisoning. Sammlung von Vergiftungsfallen, 8: 93-98.

[Another search?](#)

[Français](#) | [Contact Us](#) | [Help](#) | [Search](#) | [Canada site](#)

[Coming Events](#) | [About CBIF](#) | [Links](#) | [Reports and Publications](#) | [Home](#)

Date modified: 2003-02-06

[Important Notices](#)



Français	Contact us	Help	Search	Canada site
Coming events	About CBIF	Links	Reports and publications	Home

Canadian Biodiversity Information Facility



Notes on poisoning: *Chenopodium album*

[Introduction](#)[Interactive](#)[All poisonous plants by Botanical name](#)[All poisonous plants by Common name](#)[Important WWW Poisonous Plants sites](#)

General poisoning notes:

Lamb's-quarters (*Chenopodium album*) is a naturalized annual herb found in disturbed soils across Canada. This plant can cause sickness and death in livestock if large quantities are ingested. The plants can accumulate both nitrates and soluble oxalates. Cattle and sheep have been poisoned. Humans who consume large quantities of the plant and are subsequently exposed to sunlight suffer photosensitization (Whitehead and Moxon 1952, Cooper and Johnson 1984).

References:

Cooper, M. R., Johnson, A. W. 1984. Poisonous plants in Britain and their effects on animals and man. Her Majesty's Stationery Office, London, England. 305 pp.

Nomenclature:

Scientific Name: *Chenopodium album* L.

Vernacular name(s): lamb's-quarters

Scientific family name: *Chenopodiaceae*

Vernacular family name: goosefoot

Go to ITIS^{*ca} for more taxonomic information on: [Chenopodium album](#)

References:

Agriculture Quebec. 1975. Noms des maladies des plantes du Canada/ Names of plant diseases in Canada. , Quebec City, Que., Canada. 288 pp.

Alex, J. F., Cayouette, R., Mulligan, G. A. 1980. Common and

botanical names of weeds in Canada/Noms populaire et scientifiques des plantes nuisibles du Canada. Revised. Agric. Can. Publ., Ottawa, Ont., Canada. 132 pp.

Bailey, L. H., Bailey, E. Z. 1976. Hortus third. Revised. MacMillan, New York, N.Y., USA. 1290 pp.

Scoggan, H. J. 1978, 1979. The flora of Canada. Nat. Mus. Nat. Sci. (Ottawa) Publ. Bot. 7(1)-7(4). 1711 pp.

Van Wijk, H. L. 1911. A dictionary of plant names. Martinus Nijhoff, The Hague, The Netherlands. 1444 pp.

Victorin, M. 1964. Flore Laurentienne. 2nd ed. Univ. Montreal, Montreal, Que., Canada. 952 pp.

Geographic Information

Alberta
British Columbia
Manitoba
New Brunswick
Newfoundland
Northwest Territories
Nova Scotia
Ontario
Prince Edward Island
Quebec
Saskatchewan
Yukon Territory

References:

Bailey, L. H., Bailey, E. Z. 1976. Hortus third. Revised. MacMillan, New York, N.Y., USA. 1290 pp.

Boivin, B. 1966, 1967. Énumération des plantes du Canada. Provencheria 6. Nat. Can. (Que.) 93: 253-274; 371-437; 583-646; 989-1063. 94: 131-157; 471-528; 625-655.

Image or illustration

Chenopodium album:

Images: images.google.com

Toxic parts:

leaves
stems

References:

Gilbert, C. S., Eppson, H. F., Bradley, W. B., Beath, O. A. 1946. Nitrate accumulation in cultivated plants and weeds. Univ. Wyo. Agric. Exp. Stn. Bull., 277. 39 pp.

Whitehead, E. I., Moxon, A. L. 1952. Nitrate poisoning. S. D. Agric. Exp. Stn. Bull., 424. 24 pp.

Notes on Toxic plant chemicals:

This plant can accumulate high levels of nitrates and oxalates. The high oxalate content is thought to be responsible for most cases of poisoning (Cooper and Johnson 1984).

Toxic plant chemicals:

nitrate
oxalate

References:

Cooper, M. R., Johnson, A. W. 1984. Poisonous plants in Britain and their effects on animals and man. Her Majesty's Stationery Office, London, England. 305 pp.

Gilbert, C. S., Eppson, H. F., Bradley, W. B., Beath, O. A. 1946. Nitrate accumulation in cultivated plants and weeds. Univ. Wyo. Agric. Exp. Stn. Bull., 277. 39 pp.

Whitehead, E. I., Moxon, A. L. 1952. Nitrate poisoning. S. D. Agric. Exp. Stn. Bull., 424. 24 pp.

Animals/Human Poisoning:

Note: When an animal is listed without additional information, the literature (as of 1993) contained no detailed explanation.

Cattle

General symptoms of poisoning:

[breathing, shallow](#)

[death](#)

[diarrhea](#)

[recumbency](#)

[skin, yellow pigment](#)

[unconsciousness](#)

References:

Cooper, M. R., Johnson, A. W. 1984. Poisonous plants in Britain and their effects on animals and man. Her Majesty's Stationery Office, London, England. 305 pp.

Horses

Humans

Sheep

Swine

[Another search?](#)

[Français](#) | [Contact Us](#) | [Help](#) | [Search](#) | [Canada site](#)

[Coming Events](#) | [About CBIF](#) | [Links](#) | [Reports and Publications](#) |

[Home](#)

Date modified: 2003-02-06

[Important Notices](#)



Français	Contact us	Help	Search	Canada site
Coming events	About CBIF	Links	Reports and publications	Home



Notes on poisoning: *Chrysanthemum indicum*

[Introduction](#)

[Interactive](#)

[All poisonous plants by Botanical name](#)

[All poisonous plants by Common name](#)

[Important WWW Poisonous Plants sites](#)

General poisoning notes:

Chrysanthemum (*Chrysanthemum indicum*) and cultivated hybrids (*C. X morifolium* Ramat.) are perennial ornamentals grown indoors and outdoors. Some humans develop contact dermatitis after extended exposure to garden chrysanthemums. This is an occupational hazard of florists, nursery workers, and gardeners. (Rook and Mitchell 1979, Frohne and Pfander 1983).

References:



Mitchell, J. C., Rook, A. 1979. Botanical dermatology. Greenglass Ltd, Vancouver, B.C., Canada. 787 pp.

Nomenclature:

Scientific Name: *Chrysanthemum indicum* L.

Vernacular name(s): chrysanthemum

Scientific family name: *Compositae*

Vernacular family name: composite

Go to ITIS*^{ca} for more taxonomic information on: [Chrysanthemum indicum](#)

References:

Agriculture Quebec. 1975. Noms des maladies des plantes du Canada/ Names of plant diseases in Canada. , Quebec City, Que., Canada. 288 pp.

Alex, J. F., Cayouette, R., Mulligan, G. A. 1980. Common and botanical names of weeds in Canada/Noms populaire et scientifiques des plantes nuisibles du Canada. Revised. Agric. Can. Publ., Ottawa, Ont., Canada. 132 pp.

Bailey, L. H., Bailey, E. Z. 1976. Hortus third. Revised. MacMillan, New York, N.Y., USA. 1290 pp.

Scoggan, H. J. 1978, 1979. The flora of Canada. Nat. Mus. Nat. Sci. (Ottawa) Publ. Bot. 7(1)-7(4). 1711 pp.

Van Wijk, H. L. 1911. A dictionary of plant names. Martinus Nijhoff, The Hague, The Netherlands. 1444 pp.

Victorin, M. 1964. Flore Laurentienne. 2nd ed. Univ. Montreal, Montreal, Que., Canada. 952 pp.

Geographic Information

Plant or plant parts used in or around the home.

References:

Bailey, L. H., Bailey, E. Z. 1976. Hortus third. Revised. MacMillan, New York, N.Y., USA. 1290 pp.

Boivin, B. 1966, 1967. Énumération des plantes du Canada. Provencheria 6. Nat. Can. (Que.) 93: 253-274; 371-437; 583-646; 989-1063. 94: 131-157; 471-528; 625-655.

Image or illustration

Chrysanthemum indicum:

Images: images.google.com

Toxic parts:

leaves

References:

Frohne, D., Pfander, H. J. 1983. A colour atlas of poisonous plants. Wolfe Publishing Ltd., London, England. 291 pp.

Notes on Toxic plant chemicals:

Arteglasin A is a sesquiterpene lactone of the quaianolide type and is one of the active allergens of garden chrysanthemums. A cross-link can form between this chemical and sulfhydryl groups of body proteins so that complete antigens are produced. Repeated exposure can cause the allergic reaction. Humans who are sensitive to one member of the Compositae family can become sensitive to other members of the plant family, such as yarrow (*Achillea millefolium*) or wild chamomile (*Matricaria chamomilla*) (Mitchell

and Rook 1979; Frohne and Pfander 1983).

Toxic plant chemicals:

arteglasin A

References:

Frohne, D., Pfander, H. J. 1983. A colour atlas of poisonous plants. Wolfe Publishing Ltd., London, England. 291 pp.

Mitchell, J. C., Rook, A. 1979. Botanical dermatology. Greenglass Ltd, Vancouver, B.C., Canada. 787 pp.

Animals/Human Poisoning:

Note: When an animal is listed without additional information, the literature (as of 1993) contained no detailed explanation.

Humans

[Another search?](#)

[Français](#) | [Contact Us](#) | [Help](#) | [Search](#) | [Canada site](#)

[Coming Events](#) | [About CBIF](#) | [Links](#) | [Reports and Publications](#) |

[Home](#)

Date modified: 2003-02-06

[Important Notices](#)



Français	Contact us	Help	Search	Canada site
Coming events	About CBIF	Links	Reports and publications	Home

Canadian Biodiversity Information Facility



Notes on poisoning:

Chrysothamnus

nauseosus

[Introduction](#)[Interactive](#)[All poisonous plants by Botanical name](#)[All poisonous plants by Common name](#)[Important WWW Poisonous Plants sites](#)

General poisoning notes:

Stinking rabbitbrush (*Chrysothamnus nauseosus*) is a native shrub found on rangeland in western Canada. This plant has been reported to be toxic to livestock, and some feeding experiments have supported this conclusion. However, the plant is so unpalatable that quantities sufficient to cause toxicity are not likely to be ingested (Sampson and Malmsten 1935, Kingsbury 1964, Fuller and McClintock 1986).

References:

- Fuller, T. C., McClintock, E. 1986. Poisonous plants of California. Univ. California Press, Berkeley, Calif., USA. 432 pp.
- Kingsbury, J. M. 1964. Poisonous plants of the United States and Canada. Prentice-Hall Inc., Englewood Cliffs, N.J., USA. 626 pp.
- Sampson, A. W., Malmsten, H. E. 1935. Stock-poisoning plants of California. Univ. Calif. Div. Agric. Sci. Bull., 593. 90 pp.

Nomenclature:

Scientific Name: *Chrysothamnus nauseosus* (Pall.) Britt.

Vernacular name(s): stinking rabbitbrush

Scientific family name: *Compositae*

Vernacular family name: composite

Go to ITIS*^{ca} for more taxonomic information on: [Chrysothamnus nauseosus](#)

References:

Agriculture Quebec. 1975. Noms des maladies des plantes du Canada/ Names of plant diseases in Canada. , Quebec City, Que., Canada. 288 pp.

Alex, J. F., Cayouette, R., Mulligan, G. A. 1980. Common and botanical names of weeds in Canada/Noms populaire et scientifiques des plantes nuisibles du Canada. Revised. Agric. Can. Publ., Ottawa, Ont., Canada. 132 pp.

Bailey, L. H., Bailey, E. Z. 1976. Hortus third. Revised. MacMillan, New York, N.Y., USA. 1290 pp.

Scoggan, H. J. 1978, 1979. The flora of Canada. Nat. Mus. Nat. Sci. (Ottawa) Publ. Bot. 7(1)-7(4). 1711 pp.

Van Wijk, H. L. 1911. A dictionary of plant names. Martinus Nijhoff, The Hague, The Netherlands. 1444 pp.

Victorin, M. 1964. Flore Laurentienne. 2nd ed. Univ. Montreal, Montreal, Que., Canada. 952 pp.

Geographic Information

Alberta
British Columbia
Saskatchewan

References:

Bailey, L. H., Bailey, E. Z. 1976. Hortus third. Revised. MacMillan, New York, N.Y., USA. 1290 pp.

Boivin, B. 1966, 1967. Énumération des plantes du Canada. Provencheria 6. Nat. Can. (Que.) 93: 253-274; 371-437; 583-646; 989-1063. 94: 131-157; 471-528; 625-655.

Image or illustration

Chrysothamnus nauseosus:

Images: images.google.com

Notes on Poisonous plant parts:

This plant is considered unpalatable for livestock under most circumstances (Fuller and McClintock 1986).

Toxic parts:

leaves

References:

Fuller, T. C., McClintock, E. 1986. Poisonous plants of California. Univ. California Press, Berkeley, Calif., USA. 432 pp.

Sampson, A. W., Malmsten, H. E. 1935. Stock-poisoning plants of California. Univ. Calif. Div. Agric. Sci. Bull., 593. 90 pp.

Toxic plant chemicals:

unknown chemical

References:

Fuller, T. C., McClintock, E. 1986. Poisonous plants of California. Univ. California Press, Berkeley, Calif., USA. 432 pp.

Sampson, A. W., Malmsten, H. E. 1935. Stock-poisoning plants of California. Univ. Calif. Div. Agric. Sci. Bull., 593. 90 pp.

Animals/Human Poisoning:

Note: When an animal is listed without additional information, the literature (as of 1993) contained no detailed explanation.

Cattle

[Another search?](#)

[Français](#) | [Contact Us](#) | [Help](#) | [Search](#) | [Canada site](#)

[Coming Events](#) | [About CBIF](#) | [Links](#) | [Reports and Publications](#) |

[Home](#)

Date modified: 2003-02-06

[Important Notices](#)



Français	Contact us	Help	Search	Canada site
Coming events	About CBIF	Links	Reports and publications	Home

Canadian Biodiversity Information Facility



Notes on poisoning: *Cicuta douglasii*

[Introduction](#)[Interactive](#)[All poisonous plants by Botanical name](#)[All poisonous plants by Common name](#)[Important WWW Poisonous Plants sites](#)

General poisoning notes:

Western water-hemlock (*Cicuta douglasii*) is a native perennial plant found in wet soils in British Columbia. This plant is poisonous to all types of livestock and to humans. Many cases of poisoning have occurred in cattle, sheep, and horses. Pigs seem more resistant to the toxins, but they have still been poisoned. Humans have also been poisoned by this plant. Children are especially susceptible because ingestion of only one bite of the rootstock is sufficient to cause death. The onset of symptoms is so rapid that treatment may not be successful (Starrveld and Hope 1975, James and Ralphs 1986). See additional information in the general notes under [Cicuta maculata](#).

References:

- James, L. F., Ralphs, M. H. 1986. Water hemlock. Utah. Sci., 47(2): 67-69.
- Panter, K. E., Keeler, R. F., Baker, D. C. 1988. Toxicoses in livestock from the hemlocks (*Conium* and *Cicuta* spp.). J. Anim. Sci., 66: 2407-2413.
- Starreveld, E., Hope, C. E. 1975. Cicutoxin poisoning (water hemlock). Neurology, 25: 730-734.

Nomenclature:

Scientific Name: *Cicuta douglasii* (DC.) Coult. & Rose

Vernacular name(s): western water-hemlock

Scientific family name: *Umbelliferae*

Vernacular family name: parsley

Go to ITIS*^{ca} for more taxonomic information on: [Cicuta](#)

[douglasii](#)

References:

Agriculture Quebec. 1975. Noms des maladies des plantes du Canada/ Names of plant diseases in Canada. , Quebec City, Que., Canada. 288 pp.

Alex, J. F., Cayouette, R., Mulligan, G. A. 1980. Common and botanical names of weeds in Canada/Noms populaire et scientifiques des plantes nuisibles du Canada. Revised. Agric. Can. Publ., Ottawa, Ont., Canada. 132 pp.

Bailey, L. H., Bailey, E. Z. 1976. Hortus third. Revised. MacMillan, New York, N.Y., USA. 1290 pp.

Scoggan, H. J. 1978, 1979. The flora of Canada. Nat. Mus. Nat. Sci. (Ottawa) Publ. Bot. 7(1)-7(4). 1711 pp.

Van Wijk, H. L. 1911. A dictionary of plant names. Martinus Nijhoff, The Hague, The Netherlands. 1444 pp.

Victorin, M. 1964. Flore Laurentienne. 2nd ed. Univ. Montreal, Montreal, Que., Canada. 952 pp.

Geographic Information

British Columbia

References:

Bailey, L. H., Bailey, E. Z. 1976. Hortus third. Revised. MacMillan, New York, N.Y., USA. 1290 pp.

Boivin, B. 1966, 1967. Énumération des plantes du Canada. Provencheria 6. Nat. Can. (Que.) 93: 253-274; 371-437; 583-646; 989-1063. 94: 131-157; 471-528; 625-655.

Image or illustration

Cicuta douglasii:

Images: images.google.com

Notes on Poisonous plant parts:

The toxins are concentrated in the chambered rootstock but also occur in the leaves and stems as well (James and Ralphs 1986).

Toxic parts:

leaves
 roots
 young shoots

References:

James, L. F., Ralphs, M. H. 1986. Water hemlock. *Utah. Sci.*, 47(2): 67-69.

Notes on Toxic plant chemicals:

Cicutoxin is a highly unsaturated alcohol that is very toxic. The following dosages have been found:

Lethal dose (fresh green plant material)	Animal
0.1 kg	sheep
0.4 kg	cattle
0.3 kg	horse

Pigs appear to be more resistant to poisoning than other livestock. Adult humans can be poisoned and can die with only two or three bites of the rootstock (Starrveld and Hope 1975, James and Ralphs 1986).

Toxic plant chemicals:

cicutoxin

References:

James, L. F., Ralphs, M. H. 1986. Water hemlock. *Utah. Sci.*, 47(2): 67-69.

Starreveld, E., Hope, C. E. 1975. Cicutoxin poisoning (water hemlock). *Neurology*, 25: 730-734.

Animals/Human Poisoning:

Note: When an animal is listed without additional information, the literature (as of 1993) contained no detailed explanation.

Cattle**General symptoms of poisoning:**

[bloat](#)

[coma](#)
[convulsions](#)
[death by asphyxiation](#)
[lesions, no specific](#)
[muscle spasms](#)
[muscle twitching](#)
[nervousness](#)
[salivation](#)

Notes on poisoning:

Symptoms of poisoning are similar to all classes of livestock. See the information in general notes under [Cicuta maculata](#).

References:

James, L. F., Ralphs, M. H. 1986. Water hemlock. Utah. Sci., 47(2): 67-69.

Horses

General symptoms of poisoning:

[bloat](#)
[coma](#)
[convulsions](#)
[death by asphyxiation](#)
[lesions, no specific](#)
[muscle spasms](#)
[muscle twitching](#)
[nervousness](#)
[salivation](#)
[teeth grinding](#)

References:

James, L. F., Ralphs, M. H. 1986. Water hemlock. Utah. Sci., 47(2): 67-69.

Humans

General symptoms of poisoning:

[coma](#)

Notes on poisoning:

Toxicity and death in humans is possible with all three species of the genus *Cicuta* (water-hemlock). See the information in the

general notes under [Cicuta maculata](#).

References:

Starreveld, E., Hope, C. E. 1975. Cicutoxin poisoning (water hemlock). *Neurology*, 25: 730-734.

Sheep

General symptoms of poisoning:

[bloat](#)

[coma](#)

[convulsions](#)

[death](#)

[death by asphyxiation](#)

[gait, unsteady](#)

[incoordination](#)

[lesions, no specific](#)

[mouth, frothing of](#)

[muscle spasms](#)

[muscle twitching](#)

[nervousness](#)

[salivation](#)

[tarsal joint knuckling](#)

[teeth grinding](#)

[trembling](#)

[urination, frequent](#)

References:

James, L. F., Ralphs, M. H. 1986. Water hemlock. *Utah. Sci.*, 47(2): 67-69.

Panter, K. E., Keeler, R. F., Baker, D. C. 1988. Toxicoses in livestock from the hemlocks (*Conium* and *Cicuta* spp.). *J. Anim. Sci.*, 66: 2407-2413.

Swine

General symptoms of poisoning:

[coma](#)

[convulsions](#)

[death by asphyxiation](#)

[muscle spasms](#)

[muscle twitching](#)

[nervousness](#)

[salivation](#)

References:

James, L. F., Ralphs, M. H. 1986. Water hemlock. Utah. Sci., 47(2): 67-69.

[Another search?](#)

[Français](#) | [Contact Us](#) | [Help](#) | [Search](#) | [Canada site](#)

[Coming Events](#) | [About CBIF](#) | [Links](#) | [Reports and Publications](#) | [Home](#)

Date modified: 2003-02-06

[Important Notices](#)



Français	Contact us	Help	Search	Canada site
Coming events	About CBIF	Links	Reports and publications	Home

Canadian Biodiversity Information Facility



Notes on poisoning: *Cicuta maculata*

[Introduction](#)

[Interactive](#)

[All poisonous plants by Botanical name](#)

[All poisonous plants by Common name](#)

[Important WWW Poisonous Plants sites](#)

General poisoning notes:

Spotted water-hemlock (*Cicuta maculata*) is a native perennial herb found in wet soils and marshes across most of Canada and is considered the most violently toxic plant in North America. Humans and all classes of livestock are susceptible to poisoning and death after ingesting plant material. The onset of symptoms is often so sudden and traumatic that treatments are not always successful. The symptoms are similar in all cases of poisoning: salivation, muscular spasms, violent convulsions, coma, and death from asphyxiation. Death can occur within 15 minutes to 2-3 h after a lethal dose (Starrveld and Hope 1976, Panter et al. 1988).



References:

- Campbell, E. W. 1966. Plant poisoning Umbelliferae (parsley family). Maine Med. Assoc., 57(2): 40-42.
- Haggerty, D. R., Conway, J. A. 1936. Report of poisoning by *Cicuta maculata*. Water hemlock. N. Y. State J. Med., 36: 1511-1514.
- Pammel, L. H. 1928. Cowbane (wild parsnip). N. Am. Vet., 9: 25-26.
- Panter, K. E., Keeler, R. F., Baker, D. C. 1988. Toxicoses in livestock from the hemlocks (*Conium* and *Cicuta* spp.). J. Anim. Sci., 66: 2407-2413.
- Skidmore, L. V. 1933. Water hemlock (*Cicuta maculata* L.) poisoning in swine. Vet. J., 89: 76-80.
- Smith, R. A., Lewis, D. 1987. *Cicuta* toxicosis in cattle: case history and simplified analytical method. Vet. Hum. Toxicol., 29(3): 240-241.
- Starreveld, E., Hope, C. E. 1975. Cicutoxin poisoning (water hemlock). Neurology, 25: 730-734.

Nomenclature:

Scientific Name: *Cicuta maculata* L.

Vernacular name(s): spotted water-hemlock

Scientific family name: *Umbelliferae*

Vernacular family name: parsley

Go to ITIS*^{ca} for more taxonomic information on: [Cicuta maculata](#)

References:

Agriculture Quebec. 1975. Noms des maladies des plantes du Canada/ Names of plant diseases in Canada. , Quebec City, Que., Canada. 288 pp.

Alex, J. F., Cayouette, R., Mulligan, G. A. 1980. Common and botanical names of weeds in Canada/Noms populaire et scientifiques des plantes nuisibles du Canada. Revised. Agric. Can. Publ., Ottawa, Ont., Canada. 132 pp.

Bailey, L. H., Bailey, E. Z. 1976. Hortus third. Revised. MacMillan, New York, N.Y., USA. 1290 pp.

Scoggan, H. J. 1978, 1979. The flora of Canada. Nat. Mus. Nat. Sci. (Ottawa) Publ. Bot. 7(1)-7(4). 1711 pp.

Van Wijk, H. L. 1911. A dictionary of plant names. Martinus Nijhoff, The Hague, The Netherlands. 1444 pp.

Victorin, M. 1964. Flore Laurentienne. 2nd ed. Univ. Montreal, Montreal, Que., Canada. 952 pp.

Geographic Information

Alberta
British Columbia
Manitoba
New Brunswick
Northwest Territories
Nova Scotia
Ontario
Prince Edward Island
Quebec
Saskatchewan
Yukon Territory

References:

Bailey, L. H., Bailey, E. Z. 1976. Hortus third. Revised. MacMillan, New York, N.Y., USA. 1290 pp.

Boivin, B. 1966, 1967. Énumération des plantes du Canada. Provencheria 6. Nat. Can. (Que.) 93: 253-274; 371-437; 583-646; 989-1063. 94: 131-157; 471-528; 625-655.

Image or illustration

Cicuta maculata:

Images: images.google.com

Notes on Poisonous plant parts:

The toxin is concentrated in the rootstock in the spring. Later during the growing season, the roots contain less toxin, and the leaves and stems contain sufficient chemical to cause lethal poisoning (Starreveld and Hope 1975).

Toxic parts:

all parts
roots

References:

Pammel, L. H. 1928. Cowbane (wild parsnip). N. Am. Vet., 9: 25-26.

Skidmore, L. V. 1933. Water hemlock (*Cicuta maculata* L.) poisoning in swine. Vet. J., 89: 76-80.

Smith, R. A., Lewis, D. 1987. *Cicuta* toxicosis in cattle: case history and simplified analytical method. Vet. Hum. Toxicol., 29(3): 240-241.

Starreveld, E., Hope, C. E. 1975. Cicutoxin poisoning (water hemlock). Neurology, 25: 730-734.

Notes on Toxic plant chemicals:

The chemical cicutoxin, (trans)heptadeca-8:10:12-triene-4:6-diene- 1:4-diol, is a highly unsaturated higher alcohol. Cicutol is also present. Bohlman (pers. comm.) in Mulligan and Munro (1981) found the following concentrations of these chemicals in *Cicuta* rootstocks:

<i>Cicuta maculata</i> var. <i>maculata</i>	1.01 mg/g active ingredients
<i>Cicuta douglasii</i>	0.75 mg/g
<i>Cicuta virosa</i>	0.07 mg/g
<i>Cicuta bulbifera</i>	0.01 mg/g

The first two *Cicuta* spp. are considered the most violently toxic plants in North America. *Cicuta virosa* is less likely to cause poisoning because of its reduced concentration of toxic compounds. *Cicuta bulbifera* contains too little toxin to be considered a threat.

Toxic plant chemicals:

cicutol

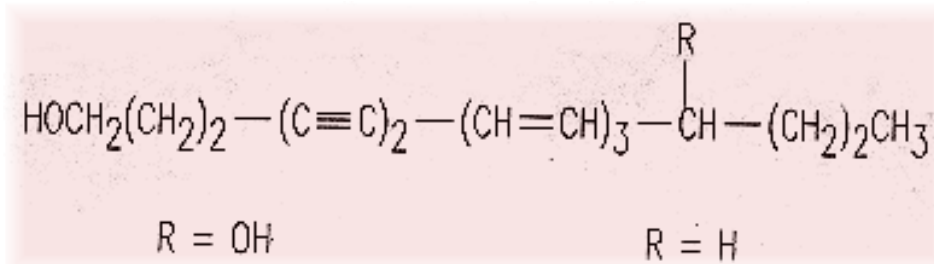

cicutoxin

Chemical diagram(s) are courtesy of [Ruth McDiarmid](#), Biochemistry Technician, Kamloops Range Station, Agriculture and Agri-Food Canada, Kamloops, British Columbia, Canada.

References:

Campbell, E. W. 1966. Plant poisoning Umbelliferae (parsley family). Maine Med. Assoc., 57(2): 40-42.

Skidmore, L. V. 1933. Water hemlock (*Cicuta maculata* L.) poisoning in swine. Vet. J., 89: 76-80.

Smith, R. A., Lewis, D. 1987. *Cicuta* toxicosis in cattle: case history and simplified analytical method. Vet. Hum. Toxicol., 29(3): 240-241.

Starreveld, E., Hope, C. E. 1975. Cicutoxin poisoning (water hemlock). Neurology, 25: 730-734.

Animals/Human Poisoning:

Note: When an animal is listed without additional information, the literature (as of 1993) contained no detailed explanation.

Cattle

General symptoms of poisoning:

[convulsions](#)

[death](#)

[falling down](#)

[nervousness](#)

[salivation](#)

Notes on poisoning:

Cattle have symptoms of poisoning similar to those of other livestock. The symptoms include salivation, grinding of teeth, muscular spasms, violent convulsions, and death by asphyxiation. Smith and Lewis (1987) developed a

rapid technique for identifying the presence of the toxic compounds of water-hemlocks in rumen samples.

References:

Pammel, L. H. 1928. Cowbane (wild parsnip). N. Am. Vet., 9: 25-26.

Panter, K. E., Keeler, R. F., Baker, D. C. 1988. Toxicoses in livestock from the hemlocks (*Conium* and *Cicuta* spp.). J. Anim. Sci., 66: 2407-2413.

Smith, R. A., Lewis, D. 1987. *Cicuta* toxicosis in cattle: case history and simplified analytical method. Vet. Hum. Toxicol., 29(3): 240-241.

Humans

General symptoms of poisoning:

[abdominal pains](#)

[cardiac arrest](#)

[coma](#)

[confusion](#)

[convulsions](#)

[cyanosis](#)

[death](#)

[dizziness](#)

[eyeballs, protruding](#)

[eyes, rolling](#)

[faintness](#)

[heart rate, elevated](#)

[inebriation](#)

[metabolic acidosis](#)

[mouth, frothing of](#)

[muscle contractions](#)

[muscle spasms](#)

[muscle twitching](#)

[nausea](#)

[neck, rigid](#)

[opisthotonos](#)

[pupil dilation](#)

[pupils, pinpoint](#)

[reflex excitability](#)

[salivation](#)

[teeth grinding](#)

[unconsciousness](#)

[voiding, involuntary](#)

[vomiting](#)

Notes on poisoning:

Symptoms of poisoning by the genus *Cicuta* include dizziness, salivation, clenching and grinding of teeth, violent convulsions, cyanosis, coma, and death from asphyxiation. In one case, a fisherman took two bites from the roots and then felt dizzy and fell unconscious within 30 min. The patient endured pain and convulsions for some time. Recommended treatment includes administration of oxygen, anesthesia to control gross wild movements, and intravenous sodium bicarbonate to correct metabolic acidosis. At least 83 cases of human poisoning by water-hemlock have been reported since 1900, of which 21 were fatal. The rootstocks are generally distasteful, but ingesting of only one bite causes symptoms in humans (Starrveld and Hope 1976). These notes apply to all water-hemlock species (*Cicuta*) listed in this information system.

References:

- Campbell, E. W. 1966. Plant poisoning Umbelliferae (parsley family). Maine Med. Assoc., 57(2): 40-42.
- Haggerty, D. R., Conway, J. A. 1936. Report of poisoning by *Cicuta maculata*. Water hemlock. N. Y. State J. Med., 36: 1511-1514.
- Pammel, L. H. 1928. Cowbane (wild parsnip). N. Am. Vet., 9: 25-26.
- Panter, K. E., Keeler, R. F., Baker, D. C. 1988. Toxicoses in livestock from the hemlocks (*Conium* and *Cicuta* spp.). J. Anim. Sci., 66: 2407-2413.
- Starreveld, E., Hope, C. E. 1975. Cicutoxin poisoning (water hemlock). Neurology, 25: 730-734.

Sheep

General symptoms of poisoning:

[breathing, labored](#)
[death](#)
[recumbency](#)

Notes on poisoning:

Ewes weighing 70 kg were experimentally poisoned with fresh rootstock. The ewe given 100 g showed few symptoms; 200 g of plant material caused extensive symptoms including seizures, recumbency, and labored breathing. Recovery occurred after several days. Gavage with 450 g of the rootstock caused death in 90 min (Panter et al. 1988).

References:

- Panter, K. E., Keeler, R. F., Baker, D. C. 1988. Toxicoses in livestock from the hemlocks (*Conium* and *Cicuta* spp.). J. Anim. Sci., 66: 2407-2413.

Swine

General symptoms of poisoning:

[agonal squeals](#)

[brain, congestion of](#)

[convulsions](#)

[death](#)

[lesions, no specific](#)

[lungs, congestion of](#)

[muscle contractions](#)

[paralysis](#)

[reflex excitability](#)

References:

Skidmore, L. V. 1933. Water hemlock (*Cicuta maculata* L.) poisoning in swine. *Vet. J.*, 89: 76-80.

[Another search?](#)

[Français](#) | [Contact Us](#) | [Help](#) | [Search](#) | [Canada site](#)

[Coming Events](#) | [About CBIF](#) | [Links](#) | [Reports and Publications](#) | [Home](#)

Date modified: 2003-02-06

[Important Notices](#)



Français	Contact us	Help	Search	Canada site
Coming events	About CBIF	Links	Reports and publications	Home

Canadian Biodiversity Information Facility



Notes on poisoning: *Cicuta virosa*

[Introduction](#)[Interactive](#)[All poisonous plants by Botanical name](#)[All poisonous plants by Common name](#)[Important WWW Poisonous Plants sites](#)

General poisoning notes:

Northern water-hemlock (*Cicuta virosa*) is a native perennial herb found in wet soils across northern Canada. It contains lower quantities of the toxic chemicals that cause poisoning in humans and livestock. However, Frohne and Pfander (1983) mention a case of human poisoning in Europe after ingestion of some rootstock of this plant. Livestock can also be poisoned if enough of the plants are ingested. Instances of poisoning in Canada should be fewer for northern water-hemlock because the concentration of chemicals is lower and the plant has essentially a boreal distribution outside of major livestock-growing areas. See additional information under [Cicuta maculata](#)



References:

Frohne, D., Pfander, H. J. 1983. A colour atlas of poisonous plants. Wolfe Publishing Ltd., London, England. 291 pp.

Nomenclature:

Scientific Name: *Cicuta virosa* L.

Vernacular name(s): northern water-hemlock

Scientific family name: *Umbelliferae*

Vernacular family name: parsley

Go to ITIS*^{ca} for more taxonomic information on: [Cicuta virosa](#)

References:

Agriculture Quebec. 1975. Noms des maladies des plantes du Canada/ Names of plant diseases in Canada. , Quebec City, Que., Canada. 288 pp.

Alex, J. F., Cayouette, R., Mulligan, G. A. 1980. Common and botanical names of weeds in Canada/Noms populaire et scientifiques des plantes nuisibles du Canada. Revised. Agric. Can. Publ., Ottawa, Ont., Canada. 132 pp.

Bailey, L. H., Bailey, E. Z. 1976. Hortus third. Revised. MacMillan, New York, N.Y., USA. 1290 pp.

Scoggan, H. J. 1978, 1979. The flora of Canada. Nat. Mus. Nat. Sci. (Ottawa) Publ. Bot. 7(1)-7(4). 1711 pp.

Van Wijk, H. L. 1911. A dictionary of plant names. Martinus Nijhoff, The Hague, The Netherlands. 1444 pp.

Victorin, M. 1964. Flore Laurentienne. 2nd ed. Univ. Montreal, Montreal, Que., Canada. 952 pp.

Geographic Information

Alberta
British Columbia
Manitoba
Northwest Territories
Ontario
Quebec
Saskatchewan
Yukon Territory

References:

Bailey, L. H., Bailey, E. Z. 1976. Hortus third. Revised. MacMillan, New York, N.Y., USA. 1290 pp.

Boivin, B. 1966, 1967. Énumération des plantes du Canada. Provencheria 6. Nat. Can. (Que.) 93: 253-274; 371-437; 583-646; 989-1063. 94: 131-157; 471-528; 625-655.

Image or illustration

Cicuta virosa:

Images: images.google.com

Toxic parts:

leaves
roots

References:

Frohne, D., Pfander, H. J. 1983. A colour atlas of poisonous plants. Wolfe Publishing Ltd., London, England. 291 pp.

Toxic plant chemicals:

cicutol

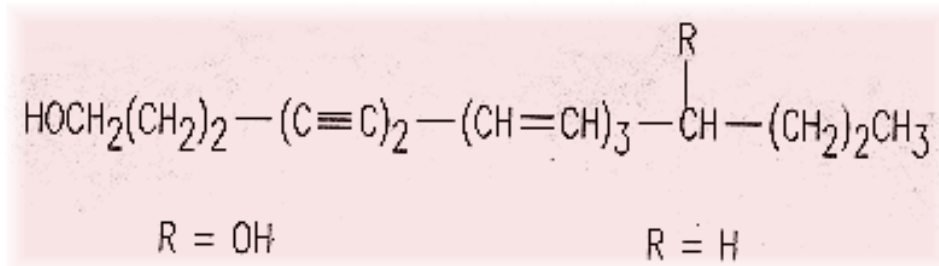

cicutoxin

Chemical diagram(s) are courtesy of [Ruth McDiarmid](#), Biochemistry Technician, Kamloops Range Station, Agriculture and Agri-Food Canada, Kamloops, British Columbia, Canada.

References:

Frohne, D., Pfander, H. J. 1983. A colour atlas of poisonous plants. Wolfe Publishing Ltd., London, England. 291 pp.

Animals/Human Poisoning:

Note: When an animal is listed without additional information, the literature (as of 1993) contained no detailed explanation.

Horses

Humans

[Another search?](#)

[Français](#) | [Contact Us](#) | [Help](#) | [Search](#) | [Canada site](#)

[Coming Events](#) | [About CBIF](#) | [Links](#) | [Reports and Publications](#) | [Home](#)

Date modified: 2003-02-06

[Important Notices](#)



Français	Contact us	Help	Search	Canada site
Coming events	About CBIF	Links	Reports and publications	Home

Canadian Biodiversity Information Facility



Notes on poisoning: *Clivia miniata*

[Introduction](#)[Interactive](#)[All poisonous plants by Botanical name](#)[All poisonous plants by Common name](#)[Important WWW Poisonous Plants sites](#)

General poisoning notes:

Kaffir lily (*Clivia miniata*) is an indoor ornamental plant grown for its flowers. The plant contains small amounts of the alkaloid lycorine. Large quantities must be ingested to cause symptoms of toxicity. Children and family pets can be poisoned (Frohne and Pfander 1983, Lampe and McCann 1985).



References:

Frohne, D., Pfander, H. J. 1983. A colour atlas of poisonous plants. Wolfe Publishing Ltd., London, England. 291 pp.

Lampe, K. F., McCann, M. A. 1985. AMA Handbook of poisonous and injurious plants. American Medical Assoc. Chicago, Ill., USA. 432 pp.

Nomenclature:

Scientific Name: *Clivia miniata* Regel

Vernacular name(s): Kaffir lily

Scientific family name: *Amaryllidaceae*

Vernacular family name: amaryllis

References:

Agriculture Quebec. 1975. Noms des maladies des plantes du Canada/ Names of plant diseases in Canada. , Quebec City, Que., Canada. 288 pp.

Alex, J. F., Cayouette, R., Mulligan, G. A. 1980. Common and botanical names of weeds in Canada/Noms populaire et scientifiques des plantes nuisibles du Canada. Revised. Agric. Can. Publ., Ottawa, Ont., Canada. 132 pp.

Bailey, L. H., Bailey, E. Z. 1976. Hortus third. Revised. MacMillan, New York, N.Y., USA. 1290 pp.

Scoggan, H. J. 1978, 1979. The flora of Canada. Nat. Mus. Nat. Sci. (Ottawa) Publ. Bot. 7(1)-7(4). 1711 pp.

Van Wijk, H. L. 1911. A dictionary of plant names. Martinus Nijhoff, The Hague, The Netherlands. 1444 pp.

Victorin, M. 1964. Flore Laurentienne. 2nd ed. Univ. Montreal, Montreal, Que., Canada. 952 pp.

Geographic Information

Plant or plant parts used in or around the home.

References:

Bailey, L. H., Bailey, E. Z. 1976. Hortus third. Revised. MacMillan, New York, N.Y., USA. 1290 pp.

Boivin, B. 1966, 1967. Énumération des plantes du Canada. Provencheria 6. Nat. Can. (Que.) 93: 253-274; 371-437; 583-646; 989-1063. 94: 131-157; 471-528; 625-655.

Image or illustration

Clivia miniata:

Images: images.google.com

Toxic parts:

bulbs

References:

Frohne, D., Pfander, H. J. 1983. A colour atlas of poisonous plants. Wolfe Publishing Ltd., London, England. 291 pp.

Notes on Toxic plant chemicals:

Lycorine has been found in quantities of 0.43% (dry weight) in the Kaffir lily. The greatest concentration of the alkaloid is in the bulb (Frohne and Pfander 1983).

Toxic plant chemicals:

lycorine

References:

Frohne, D., Pfander, H. J. 1983. A colour atlas of poisonous plants. Wolfe Publishing Ltd., London, England. 291 pp.

Lampe, K. F., McCann, M. A. 1985. AMA Handbook of poisonous and injurious plants. American Medical Assoc. Chicago, Ill., USA. 432 pp.

Animals/Human Poisoning:

Note: When an animal is listed without additional information, the literature (as of 1993) contained no detailed explanation.

Humans

General symptoms of poisoning:

[collapse](#)

[diarrhea](#)

[paralysis](#)

[salivation](#)

[vomiting](#)

References:

Frohne, D., Pfander, H. J. 1983. A colour atlas of poisonous plants. Wolfe Publishing Ltd., London, England. 291 pp.

Lampe, K. F., McCann, M. A. 1985. AMA Handbook of poisonous and injurious plants. American Medical Assoc. Chicago, Ill., USA. 432 pp.

[Another search?](#)

[Français](#) | [Contact Us](#) | [Help](#) | [Search](#) | [Canada site](#)

[Coming Events](#) | [About CBIF](#) | [Links](#) | [Reports and Publications](#) |

[Home](#)

Date modified: 2003-02-06

[Important Notices](#)



Français	Contact us	Help	Search	Canada site
Coming events	About CBIF	Links	Reports and publications	Home

Canadian Biodiversity Information Facility



Notes on poisoning: *Codiaeum variegatum*

[Introduction](#)[Interactive](#)[All poisonous plants by Botanical name](#)[All poisonous plants by Common name](#)[Important WWW Poisonous Plants sites](#)

General poisoning notes:

Croton (*Codiaeum variegatum*) is a common houseplant. Chewing the bark and roots is said to cause burning of the mouth. Some young leaves are used in the East Indies as a vegetable, but cases of irritation have been reported. The latex has caused eczema in some gardeners (Morton 1962, Frohne and Pfander 1983).



References:

- Morton, J. F. 1962. Ornamental plants with toxic and or irritant properties. II. Proc. Fla. State Hortic. Soc., 75: 484-491.
- Perkins, K. D., Payne, W. W. 1978. Guide to the poisonous and irritant plants of Florida. Univ. Fla. Agric. Ext. Serv. Circ., 441. 84 pp.

Nomenclature:

Scientific Name: *Codiaeum variegatum* (L.) Blume

Vernacular name(s): croton

Scientific family name: *Euphorbiaceae*

Vernacular family name: spurge

Go to ITIS*^{ca} for more taxonomic information on: [Codiaeum variegatum](#)

References:

- Agriculture Quebec. 1975. Noms des maladies des plantes du Canada/ Names of plant diseases in Canada. , Quebec City, Que., Canada. 288 pp.

Alex, J. F., Cayouette, R., Mulligan, G. A. 1980. Common and botanical names of weeds in Canada/Noms populaire et scientifiques des plantes nuisibles du Canada. Revised. Agric. Can. Publ., Ottawa, Ont., Canada. 132 pp.

Bailey, L. H., Bailey, E. Z. 1976. Hortus third. Revised. MacMillan, New York, N.Y., USA. 1290 pp.

Scoggan, H. J. 1978, 1979. The flora of Canada. Nat. Mus. Nat. Sci. (Ottawa) Publ. Bot. 7(1)-7(4). 1711 pp.

Van Wijk, H. L. 1911. A dictionary of plant names. Martinus Nijhoff, The Hague, The Netherlands. 1444 pp.

Victorin, M. 1964. Flore Laurentienne. 2nd ed. Univ. Montreal, Montreal, Que., Canada. 952 pp.

Geographic Information

Plant or plant parts used in or around the home.

References:

Bailey, L. H., Bailey, E. Z. 1976. Hortus third. Revised. MacMillan, New York, N.Y., USA. 1290 pp.

Boivin, B. 1966, 1967. Énumération des plantes du Canada. Provencheria 6. Nat. Can. (Que.) 93: 253-274; 371-437; 583-646; 989-1063. 94: 131-157; 471-528; 625-655.

Image or illustration

Codiaeum variegatum:

Images: images.google.com

Toxic parts:

bark
latex
leaves
roots

References:

Perkins, K. D., Payne, W. W. 1978. Guide to the poisonous and irritant plants of Florida. Univ. Fla. Agric. Ext. Serv. Circ., 441. 84 pp.

Toxic plant chemicals:

5-deoxyingenol

References:

Perkins, K. D., Payne, W. W. 1978. Guide to the poisonous and irritant plants of Florida. Univ. Fla. Agric. Ext. Serv. Circ., 441. 84 pp.

Animals/Human Poisoning:

Note: When an animal is listed without additional information, the literature (as of 1993) contained no detailed explanation.

Humans

General symptoms of poisoning:

[eczema](#)
[mouth, irritation of](#)

Notes on poisoning:

Ingesting the bark or roots has caused burning and irritation of the mouth parts. Occasional eczema has been reported after repeated exposure to the latex (Morton 1962, Frohne and Pfander 1983).

References:

Morton, J. F. 1962. Ornamental plants with toxic and or irritant properties. II. Proc. Fla. State Hortic. Soc., 75: 484-491.

Perkins, K. D., Payne, W. W. 1978. Guide to the poisonous and irritant plants of Florida. Univ. Fla. Agric. Ext. Serv. Circ., 441. 84 pp.

[Another search?](#)

[Français](#) | [Contact Us](#) | [Help](#) | [Search](#) | [Canada site](#)
[Coming Events](#) | [About CBIF](#) | [Links](#) | [Reports and Publications](#) | [Home](#)

Date modified: 2003-02-06

[Important Notices](#)



Français	Contact us	Help	Search	Canada site
Coming events	About CBIF	Links	Reports and publications	Home

Canadian Biodiversity Information Facility



Notes on poisoning: *Colchicum autumnale*

[Introduction](#)[Interactive](#)[All poisonous plants by Botanical name](#)[All poisonous plants by Common name](#)[Important WWW Poisonous Plants sites](#)

General poisoning notes:

Autumn crocus (*Colchicum autumnale*) is an outdoor ornamental grown for its autumn flowers. The plant is poisonous to all animals and to humans. Livestock have been poisoned in Europe and Asia, where the plants are native. Poisoning has been reported in cattle, goats horses, sheep, and swine, as well as in humans and dogs. The toxic chemical colchicine can be excreted through the milk of lactating animals, thereby poisoning young animals and humans. Cattle and, to a lesser extent, goats and sheep can develop complete resistance to colchicine (Cooper and Johnson 1984). This plant is found only in garden cultivation or maybe as a houseplant in Canada. Children and family pets are therefore most at risk from ingesting autumn crocus.

References:

Cooper, M. R., Johnson, A. W. 1984. Poisonous plants in Britain and their effects on animals and man. Her Majesty's Stationery Office, London, England. 305 pp.

Hill, S. R., Duke, P. K. 1986. 100 poisonous plants of Maryland. Univ. MD. Coop. Ext. Serv. Bull., 314. 55 pp.

Lampe, K. F., McCann, M. A. 1985. AMA Handbook of poisonous and injurious plants. American Medical Assoc. Chicago, Ill., USA. 432 pp.

Spoerke, D. G., Smolinske, S. C. 1990. Toxicity of houseplants. CRC Press, Inc., Boca Raton, Fla., USA. 335 pp.

Nomenclature:

Scientific Name: *Colchicum autumnale* L.

Vernacular name(s): autumn crocus

Scientific family name: *Liliaceae*

Vernacular family name: lily

Go to ITIS^{*ca} for more taxonomic information on: [Colchicum autumnale](#)

References:

Agriculture Quebec. 1975. Noms des maladies des plantes du Canada/ Names of plant diseases in Canada. , Quebec City, Que., Canada. 288 pp.

Alex, J. F., Cayouette, R., Mulligan, G. A. 1980. Common and botanical names of weeds in Canada/Noms populaire et scientifiques des plantes nuisibles du Canada. Revised. Agric. Can. Publ., Ottawa, Ont., Canada. 132 pp.

Bailey, L. H., Bailey, E. Z. 1976. Hortus third. Revised. MacMillan, New York, N.Y., USA. 1290 pp.

Scoggan, H. J. 1978, 1979. The flora of Canada. Nat. Mus. Nat. Sci. (Ottawa) Publ. Bot. 7(1)-7(4). 1711 pp.

Van Wijk, H. L. 1911. A dictionary of plant names. Martinus Nijhoff, The Hague, The Netherlands. 1444 pp.

Victorin, M. 1964. Flore Laurentienne. 2nd ed. Univ. Montreal, Montreal, Que., Canada. 952 pp.

Geographic Information

Plant or plant parts used in or around the home.

References:

Bailey, L. H., Bailey, E. Z. 1976. Hortus third. Revised. MacMillan, New York, N.Y., USA. 1290 pp.

Boivin, B. 1966, 1967. Énumération des plantes du Canada. Provencheria 6. Nat. Can. (Que.) 93: 253-274; 371-437; 583-646; 989-1063. 94: 131-157; 471-528; 625-655.

Image or illustration

Colchicum autumnale:

Images: images.google.com

Toxic parts:

all parts

References:

Lampe, K. F., McCann, M. A. 1985. AMA Handbook of poisonous and injurious plants. American Medical Assoc. Chicago, Ill., USA. 432 pp.

Notes on Toxic plant chemicals:

Colchicine is more toxic than colchiceine. These chemicals withstand drying, storage, and boiling without losing their toxic qualities. Colchicine affects the central nervous system, paralyzing nerve endings and blocking neuromuscular connections.

All parts of the plant are poisonous:

- 0.03-0.06% colchicine in the corm (bulb)
- 0.02-0.04% colchicine in the seeds

Ingesting fresh leaves in the following quantities results in death (Cooper and Johnson 1984):

8-16 g/kg of body weight	cattle
6.4 g/kg body weight	lambs (2-3 months old)
12 g/kg body weight	guinea pigs (adult)

Toxic plant chemicals:

colchiceine
colchicine

References:

Cooper, M. R., Johnson, A. W. 1984. Poisonous plants in Britain and their effects on animals and man. Her Majesty's Stationery Office, London, England. 305 pp.

Animals/Human Poisoning:

Note: When an animal is listed without additional information, the literature (as of 1993) contained no detailed explanation.

Cattle

General symptoms of poisoning:

[abdominal pains](#)

[collapse](#)

[death by asphyxiation](#)

[depression](#)

[diarrhea](#)

[incoordination](#)

[teeth grinding](#)

References:

Cooper, M. R., Johnson, A. W. 1984. Poisonous plants in Britain and their effects on animals and man. Her Majesty's Stationery Office, London, England. 305 pp.

Dogs

Goats

Horses

General symptoms of poisoning:

[collapse](#)

References:

Cooper, M. R., Johnson, A. W. 1984. Poisonous plants in Britain and their effects on animals and man. Her Majesty's Stationery Office, London, England. 305 pp.

Humans

General symptoms of poisoning:

[abdominal pains](#)

[colic](#)

[collapse](#)

[diarrhea](#)

[hemoglobinuria](#)

[mouth, irritation of](#)

[nausea](#)

[thirsty](#)

[vomiting](#)

Notes on poisoning:

Humans and other animals exhibit similar symptoms of colchicine poisoning. Symptoms develop 2-7 h after ingestion. Recovery is slow and relapse may occur, resulting in paralysis, respiratory or heart failure, and death. Temporary hair loss may occur (Cooper and Johnson 1984, Hill and Duke 1986).

References:

Cooper, M. R., Johnson, A. W. 1984. Poisonous plants in Britain and their effects on animals and man. Her Majesty's Stationery Office, London, England. 305 pp.

Hill, S. R., Duke, P. K. 1986. 100 poisonous plants of Maryland. Univ. MD. Coop. Ext. Serv. Bull., 314. 55 pp.

Lampe, K. F., McCann, M. A. 1985. AMA Handbook of poisonous and injurious plants. American Medical Assoc. Chicago, Ill., USA. 432 pp.

Sheep

General symptoms of poisoning:

[collapse](#)

[depression](#)

[diarrhea](#)

[salivation](#)

References:

Cooper, M. R., Johnson, A. W. 1984. Poisonous plants in Britain and their effects on animals and man. Her Majesty's Stationery Office, London, England. 305 pp.

Swine

[Another search?](#)

[Français](#) | [Contact Us](#) | [Help](#) | [Search](#) | [Canada site](#)

[Coming Events](#) | [About CBIF](#) | [Links](#) | [Reports and Publications](#) |

[Home](#)

Date modified: 2003-02-06

[Important Notices](#)



Français	Contact us	Help	Search	Canada site
Coming events	About CBIF	Links	Reports and publications	Home

Canadian Biodiversity Information Facility



Notes on poisoning: *Conium maculatum*

[Introduction](#)[Interactive](#)[All poisonous plants by Botanical name](#)[All poisonous plants by Common name](#)[Important WWW Poisonous Plants sites](#)

General poisoning notes:

Poison-hemlock (*Conium maculatum*) is a naturalized herb found in parts of southern Canada. The plant grows on dry to moist soils. Cattle, goats, horses, swine, and sheep as well as rabbits, poultry, deer, and humans have been poisoned after ingesting poison-hemlock. Animal species vary in their susceptibility to acute toxicity (Keeler et al. 1980):

cows	3.3 mg/kg body weight	1.5-2 h
ewes	44 mg/kg body weight	1.5-2 h
mares	15.5 mg/kg body weight	30-40 min

Poison-hemlock causes toxicity and death in animals after it is ingested. It also causes teratogenic effects called crooked calf disease in young pigs and cattle, caused by the chemical coniine (Keeler 1974, Panter et al. 1985).

References:

Anon. 1951. Unusual case of hemlock poisoning in swine. Calif. Vet., 5(2): 26.

Cooper, M. R., Johnson, A. W. 1984. Poisonous plants in Britain and their effects on animals and man. Her Majesty's Stationery Office, London, England. 305 pp.

Edmonds, L. D., Selby, L. A., Case, A. A. 1972. Poisoning and congenital malformations associated with consumption of poison hemlock by sows. J. Am. Vet. Med. Assoc., 160: 1319-1324.

Frank, A. A., Reed, W. M. 1987. *Conium maculatum* (poison hemlock) toxicosis in a flock of range turkeys. Avian Dis., 31: 386-388.

Hannam, D. A. 1985. Hemlock (*Conium maculatum*) poisoning in the pig. Vet. Rec., 116: 322.

- Keeler, R. F., Balls, L. D., Shupe, J. L., Crowe, M. W. 1980. Teratogenicity and toxicity of coniine in cows, ewes and mares. *Cornell Vet.*, 70: 19-26.
- Keeler, R. F. 1974. Coniine, a teratogenic principle from *Conium maculatum* producing congenital malformations in calves. *Clin. Toxicol.*, 7: 195-206.
- Lampe, K. F., McCann, M. A. 1985. *AMA Handbook of poisonous and injurious plants*. American Medical Assoc. Chicago, Ill., USA. 432 pp.
- MacDonald, H. 1937. Hemlock poisoning in horses. *Vet. Rec.*, 49: 1211-1212.
- Panter, K. E., Bunch, T. D., Keeler, R. F. 1988. Maternal and fetal toxicity of poison hemlock (*Conium maculatum*) in sheep. *Am. J. Vet. Res.*, 49: 281-283.
- Panter, K. E., Keeler, R. F., Baker, D. C. 1988. Toxicoses in livestock from the hemlocks (*Conium* and *Cicuta* spp.). *J. Anim. Sci.*, 66: 2407-2413.
- Panter, K. E., Keeler, R. F., Buck, W. B. 1985. Congenital skeletal malformations induced by maternal ingestion of *Conium maculatum* (poison hemlock) in newborn pigs. *Am. J. Vet. Res.*, 46: 2064-2066.
- Panter, K. E., Keeler, R. F. 1989. Piperidine alkaloids of poison hemlock (*Conium maculatum*). Pages 109-132 in Cheeke, P. R., ed. *Toxicants of plant origin*. Vol. I. Alkaloids. CRC Press, Inc., Boca Raton, Fla., USA. 335 pp.
- Penny, R. H. 1953. Hemlock poisoning in cattle. *Vet. Rec.*, 42: 669-670.
- Short, S. B., Edwards, W. C. 1989. Accidental *Conium maculata* poisoning in the rabbit. *Vet. Hum. Toxicol.*, 31(1): 54-57.
- Widmer, W. R. 1984. Poison hemlock toxicosis in swine. *Vet. Med. Small Anim. Clin.*, 79: 405-408.

Nomenclature:

Scientific Name: *Conium maculatum* L.

Vernacular name(s): poison-hemlock

Scientific family name: *Umbelliferae*

Vernacular family name: parsley

Go to ITIS^{*ca} for more taxonomic information on: [Conium maculatum](#)

References:

Agriculture Quebec. 1975. Noms des maladies des plantes du Canada/ Names of plant diseases in Canada. , Quebec City, Que., Canada. 288 pp.

Alex, J. F., Cayouette, R., Mulligan, G. A. 1980. Common and botanical names of weeds in Canada/Noms populaire et scientifiques des plantes nuisibles du Canada. Revised. Agric. Can. Publ., Ottawa, Ont., Canada. 132 pp.

Bailey, L. H., Bailey, E. Z. 1976. Hortus third. Revised. MacMillan, New York, N.Y., USA. 1290 pp.

Scoggan, H. J. 1978, 1979. The flora of Canada. Nat. Mus. Nat. Sci. (Ottawa) Publ. Bot. 7(1)-7(4). 1711 pp.

Van Wijk, H. L. 1911. A dictionary of plant names. Martinus Nijhoff, The Hague, The Netherlands. 1444 pp.

Victorin, M. 1964. Flore Laurentienne. 2nd ed. Univ. Montreal, Montreal, Que., Canada. 952 pp.

Geographic Information

British Columbia

Nova Scotia

Ontario

Quebec

Saskatchewan

References:

Bailey, L. H., Bailey, E. Z. 1976. Hortus third. Revised. MacMillan, New York, N.Y., USA. 1290 pp.

Boivin, B. 1966, 1967. Énumération des plantes du Canada. Provencheria 6. Nat. Can. (Que.) 93: 253-274; 371-437; 583-646; 989-1063. 94: 131-157; 471-528; 625-655.

Image or illustration

Conium maculatum:

Images: images.google.com

Notes on Poisonous plant parts:

All parts of poison-hemlock contain some level of the alkaloids, except for the sap in young plants. The most toxic chemical, gamma-coniceine is abundant in leaves flowers and less common

in the fruits, where it is quickly converted to coniine and N-methylconiine (Cromwell 1956).

Toxic parts:

flowers
leaves
mature fruit
roots
seeds
stems
young shoots

References:

Anon. 1951. Unusual case of hemlock poisoning in swine. *Calif. Vet.*, 5(2): 26.

Cromwell, B. T. 1956. The separation, micro-estimation and distribution of the alkaloids of hemlock (*Conium maculatum* L.). *Biochem. J.*, 64: 259-266.

Edmonds, L. D., Selby, L. A., Case, A. A. 1972. Poisoning and congenital malformations associated with consumption of poison hemlock by sows. *J. Am. Vet. Med. Assoc.*, 160: 1319-1324.

Fairbairn, J. W., Suwal, P. N. 1961. The alkaloids of hemlock (*Conium maculatum* L.) - II. *Phytochemistry (Oxf.)*, 1: 38-46.

Frank, A. A., Reed, W. M. 1987. *Conium maculatum* (poison hemlock) toxicosis in a flock of range turkeys. *Avian Dis.*, 31: 386-388.

Hannam, D. A. 1985. Hemlock (*Conium maculatum*) poisoning in the pig. *Vet. Rec.*, 116: 322.

MacDonald, H. 1937. Hemlock poisoning in horses. *Vet. Rec.*, 49: 1211-1212.

Panter, K. E., Keeler, R. F. 1989. Piperidine alkaloids of poison hemlock (*Conium maculatum*). Pages 109-132 in Cheeke, P. R., ed. *Toxicants of plant origin. Vol. I. Alkaloids.* CRC Press, Inc., Boca Raton, Fla., USA. 335 pp.

Penny, R. H. 1953. Hemlock poisoning in cattle. *Vet. Rec.*, 42: 669-670.

Widmer, W. R. 1984. Poison hemlock toxicosis in swine. *Vet. Med. Small Anim. Clin.*, 79: 405-408.

Notes on Toxic plant chemicals:

gamma-Coniceine is the precursor of the other alkaloids in

poison- hemlock. This chemical is a partly unsaturated piperidine alkaloid. The other chemicals, including coniine and N-methylconiine, are saturated. During the first year of growth, gamma-coniceine is the predominant chemical. During the second year of growth, the content of both coniine and N-methylconiine increase, especially in the leaves and fruits, with a decrease in the first chemical. gamma-Coniceine is considered seven or eight times more toxic than coniine, with N-methylconiine even less toxic (Cromwell 1956, Fairbairn and Suwal 1961, Panter and Keeler 1989).

The following LD50 toxicities in mice have been reported (Bowman and Snaghvi 1963):

gamma-coniceine	death time
2.6 mg/kg (intravenous)	30 sec
12.0 mg/kg (subcutaneous)	12 min
12.0 mg/kg (oral)	8 min

coniine	death time
19.0 mg/kg (intravenous)	30 sec
80 mg/kg (subcutaneous)	15 min
100 mg/kg (oral)	10 min

N-methylconiine	death time
27.5 mg/kg (intravenous)	30 sec
150.5 mg/kg (subcutaneous)	16 min
204.5 mg/kg (oral)	12 min

Toxic plant chemicals:

coniine
gamma-coniceine
N-methylconiine

References:

Bowman, W. C., Snaghvi, I. S. 1963. Pharmacological actions of hemlock (*Conium maculatum*) alkaloids. J. Pharm. Pharmacol., 15: 1.

Cromwell, B. T. 1956. The separation, micro-estimation and distribution of the alkaloids of hemlock (*Conium maculatum* L.). Biochem. J., 64: 259-266.

Fairbairn, J. W., Suwal, P. N. 1961. The alkaloids of hemlock (*Conium maculatum* L.) - II. Phytochemistry (Oxf.), 1: 38-46.

Keeler, R. F., Balls, L. D., Shupe, J. L., Crowe, M. W. 1980.

Teratogenicity and toxicity of coniine in cows, ewes and mares. *Cornell Vet.*, 70: 19-26.

Keeler, R. F. 1974. Coniine, a teratogenic principle from *Conium maculatum* producing congenital malformations in calves. *Clin. Toxicol.*, 7: 195-206.

Panter, K. E., Bunch, T. D., Keeler, R. F. 1988. Maternal and fetal toxicity of poison hemlock (*Conium maculatum*) in sheep. *Am. J. Vet. Res.*, 49: 281-283.

Panter, K. E., Keeler, R. F., Baker, D. C. 1988. Toxicoses in livestock from the hemlocks (*Conium* and *Cicuta* spp.). *J. Anim. Sci.*, 66: 2407-2413.

Panter, K. E., Keeler, R. F., Buck, W. B. 1985. Congenital skeletal malformations induced by maternal ingestion of *Conium maculatum* (poison hemlock) in newborn pigs. *Am. J. Vet. Res.*, 46: 2064-2066.

Panter, K. E., Keeler, R. F. 1989. Piperidine alkaloids of poison hemlock (*Conium maculatum*). Pages 109-132 in Cheeke, P. R., ed. *Toxicants of plant origin. Vol. I. Alkaloids.* CRC Press, Inc., Boca Raton, Fla., USA. 335 pp.

Animals/Human Poisoning:

Note: When an animal is listed without additional information, the literature (as of 1993) contained no detailed explanation.

Cattle

General symptoms of poisoning:

[arthrogryposis](#)

[breathing, rapid](#)

[carpal joint, flexure](#)

[depression](#)

[diarrhea](#)

[elbow joint, flexure](#)

[gait, unsteady](#)

[incoordination](#)

[limbs, lateral rotation](#)

[muscle spasms](#)

[salivation](#)

[scoliosis](#)

[teeth grinding](#)

[torticollis](#)

[trembling](#)

[urine, coffee-colored](#)

[vomiting](#)

Notes on poisoning:

General signs of poisoning in all types of livestock include apathy, salivation, frequent regurgitation, teeth grinding, and reduced milk production. For a lethal dose, cattle require coniine at a rate of about 16 mg/kg of body weight (Keeler et al. 1980).

References:

Cooper, M. R., Johnson, A. W. 1984. Poisonous plants in Britain and their effects on animals and man. Her Majesty's Stationery Office, London, England. 305 pp.

Keeler, R. F. 1974. Coniine, a teratogenic principle from *Conium maculatum* producing congenital malformations in calves. Clin. Toxicol., 7: 195-206.

Panter, K. E., Keeler, R. F., Baker, D. C. 1988. Toxicoses in livestock from the hemlocks (*Conium* and *Cicuta* spp.). J. Anim. Sci., 66: 2407-2413.

Penny, R. H. 1953. Hemlock poisoning in cattle. Vet. Rec., 42: 669-670.

Horses

General symptoms of poisoning:

[collapse](#)

[trembling](#)

[unconsciousness](#)

Notes on poisoning:

Horses exhibit symptoms similar to other types of livestock that have ingested poison-hemlock. Trembling and paralysis are common symptoms.

References:

MacDonald, H. 1937. Hemlock poisoning in horses. Vet. Rec., 49: 1211-1212.

Humans

General symptoms of poisoning:

[coma](#)

[convulsions](#)

[death by asphyxiation](#)

[dizziness](#)

[headache](#)

[incoordination](#)

[pupil dilation](#)

[thirsty](#)

[vomiting](#)

Notes on poisoning:

Poison-hemlock has been ingested on purpose and accidentally. Socrates was executed in 399 B.C. by an extract of this plant. Humans have accidentally ingested it, mistaking it for carrot or parsnip. The symptoms are similar to those in other animals. Coldness is often felt in the extremities. There is rapid onset of irritation of mucous membranes of the mouth and throat, accompanied by salivation and nausea. Severe poisoning may cause coma and death by respiratory failure. Treatment includes administering activated charcoal after emesis ceases. Treatment is otherwise symptomatic. Despite the severity of poisoning mortality is low (Cooper and Johnson 1984, Lampe and McCann 1985).

References:

Cooper, M. R., Johnson, A. W. 1984. Poisonous plants in Britain and their effects on animals and man. Her Majesty's Stationery Office, London, England. 305 pp.

Lampe, K. F., McCann, M. A. 1985. AMA Handbook of poisonous and injurious plants. American Medical Assoc. Chicago, Ill., USA. 432 pp.

Rabbits

General symptoms of poisoning:

[ataxia](#)

[breathing, shallow](#)

[death](#)

[trembling](#)

[weakness](#)

References:

Short, S. B., Edwards, W. C. 1989. Accidental *Conium maculata* poisoning in the rabbit. Vet. Hum. Toxicol., 31(1): 54-57.

Sheep

General symptoms of poisoning:

[ataxia](#)
[carpal joint, flexure](#)
[death](#)
[defecation, frequent](#)
[salivation](#)
[tail, kinked](#)
[trembling](#)
[urination, frequent](#)
[weakness](#)

References:

Panter, K. E., Bunch, T. D., Keeler, R. F. 1988. Maternal and fetal toxicity of poison hemlock (*Conium maculatum*) in sheep. Am. J. Vet. Res., 49: 281-283.

Swine

General symptoms of poisoning:

[arthrogryposis](#)
[articular rigidity](#)
[ataxia](#)
[blindness](#)
[blindness, temporary](#)
[breathing, labored](#)
[breathing, rapid](#)
[carpal joint, flexure](#)
[collapse](#)
[death](#)
[death by asphyxiation](#)
[fetlock joint, flexure](#)
[gait, staggering](#)
[gait, unsteady](#)
[heart rate, elevated](#)
[lacrimation, severe](#)
[palatoschisis](#)
[paralysis](#)
[prostration](#)
[pupil dilation](#)
[scoliosis](#)
[syndactylism](#)
[temperature, elevated](#)
[trembling](#)

[urination, frequent](#)

[vision, impaired](#)

[weakness](#)

References:

Anon. 1951. Unusual case of hemlock poisoning in swine. Calif. Vet., 5(2): 26.

Edmonds, L. D., Selby, L. A., Case, A. A. 1972. Poisoning and congenital malformations associated with consumption of poison hemlock by sows. J. Am. Vet. Med. Assoc., 160: 1319-1324.

Hannam, D. A. 1985. Hemlock (*Conium maculatum*) poisoning in the pig. Vet. Rec., 116: 322.

Panter, K. E., Keeler, R. F., Buck, W. B. 1985. Congenital skeletal malformations induced by maternal ingestion of *Conium maculatum* (poison hemlock) in newborn pigs. Am. J. Vet. Res., 46: 2064-2066.

Widmer, W. R. 1984. Poison hemlock toxicosis in swine. Vet. Med. Small Anim. Clin., 79: 405-408.

Turkeys

General symptoms of poisoning:

[death](#)

[diarrhea](#)

[enteritis](#)

[kidney, congestion of](#)

[liver, congestion of](#)

[lungs, congestion of](#)

[paralysis](#)

[salivation](#)

[weakness](#)

References:

Frank, A. A., Reed, W. M. 1987. *Conium maculatum* (poison hemlock) toxicosis in a flock of range turkeys. Avian Dis., 31: 386-388.

[Another search?](#)

[Français](#) | [Contact Us](#) | [Help](#) | [Search](#) | [Canada site](#)

[Coming Events](#) | [About CBIF](#) | [Links](#) | [Reports and Publications](#) |

[Home](#)

Date modified: 2003-02-06

[Important Notices](#)



Français	Contact us	Help	Search	Canada site
Coming events	About CBIF	Links	Reports and publications	Home

Canadian Biodiversity Information Facility



Notes on poisoning: *Convallaria majalis*

[Introduction](#)[Interactive](#)[All poisonous plants by Botanical name](#)[All poisonous plants by Common name](#)[Important WWW Poisonous Plants sites](#)

General poisoning notes:

Lily-of-the-valley (*Convallaria majalis*) is a perennial outdoor ornamental herb. The plant contains cardiac glycosides as well as saponins. There are some references in the literature that mention poisoning and death in humans after accidental ingestion of the berries and leaves, and even by drinking the water that the plants were kept in. Frohne and Pfander (1983) suggest that serious cases are unlikely to occur because the glycosides are poorly absorbed. They cast doubt on the report of poisoning by ingesting water that lily-of-the-valley was standing in because experiments with animals did not substantiate these reports. However, in spite of these reservations, some cases of human poisoning are mentioned in the literature, and so these plants should be considered potentially poisonous. Because of the cardiac glycosides and saponins found in this plant, animals that have access to the plant material may be poisoned. Certainly, ingesting large quantities of lily-of-the-valley can cause problems to family pets such as cats and dogs.

References:

Cooper, M. R., Johnson, A. W. 1984. Poisonous plants in Britain and their effects on animals and man. Her Majesty's Stationery Office, London, England. 305 pp.

Frohne, D., Pfander, H. J. 1983. A colour atlas of poisonous plants. Wolfe Publishing Ltd., London, England. 291 pp.

Nomenclature:

Scientific Name: *Convallaria majalis* L.

Vernacular name(s): lily-of-the-valley

Scientific family name: *Liliaceae*

Vernacular family name: lily

Go to ITIS^{*ca} for more taxonomic information on: [Convallaria majalis](#)

References:

Agriculture Quebec. 1975. Noms des maladies des plantes du Canada/ Names of plant diseases in Canada. , Quebec City, Que., Canada. 288 pp.

Alex, J. F., Cayouette, R., Mulligan, G. A. 1980. Common and botanical names of weeds in Canada/Noms populaire et scientifiques des plantes nuisibles du Canada. Revised. Agric. Can. Publ., Ottawa, Ont., Canada. 132 pp.

Bailey, L. H., Bailey, E. Z. 1976. Hortus third. Revised. MacMillan, New York, N.Y., USA. 1290 pp.

Scoggan, H. J. 1978, 1979. The flora of Canada. Nat. Mus. Nat. Sci. (Ottawa) Publ. Bot. 7(1)-7(4). 1711 pp.

Van Wijk, H. L. 1911. A dictionary of plant names. Martinus Nijhoff, The Hague, The Netherlands. 1444 pp.

Victorin, M. 1964. Flore Laurentienne. 2nd ed. Univ. Montreal, Montreal, Que., Canada. 952 pp.

Geographic Information

Plant or plant parts used in or around the home.

References:

Bailey, L. H., Bailey, E. Z. 1976. Hortus third. Revised. MacMillan, New York, N.Y., USA. 1290 pp.

Boivin, B. 1966, 1967. Énumération des plantes du Canada. Provencheria 6. Nat. Can. (Que.) 93: 253-274; 371-437; 583-646; 989-1063. 94: 131-157; 471-528; 625-655.

Image or illustration

Convallaria majalis:

Images: images.google.com

Toxic parts:

all parts
flowers
leaves

mature fruit

roots

References:

Lampe, K. F., McCann, M. A. 1985. AMA Handbook of poisonous and injurious plants. American Medical Assoc. Chicago, Ill., USA. 432 pp.

Notes on Toxic plant chemicals:

Convallotoxin is one of the most toxic naturally occurring substances affecting the heart. These glycosides cause irregularities in heart action (Cooper and Johnson 1984).

Toxic plant chemicals:

convallatoxin

convalloside

References:

Cooper, M. R., Johnson, A. W. 1984. Poisonous plants in Britain and their effects on animals and man. Her Majesty's Stationery Office, London, England. 305 pp.

Joubert, J. P. 1989. Cardiac glycosides. Pages 61-97 in Cheeke, P. R., ed. Toxicants of plant origin. Vol. II. Glycosides. CRC Press, Inc., Boca Raton, Fla., USA. 277 pp.

Animals/Human Poisoning:

Note: When an animal is listed without additional information, the literature (as of 1993) contained no detailed explanation.

Cats

Dogs

Humans

General symptoms of poisoning:

[abdominal pains](#)

[gastroenteritis](#)

[headache](#)

[nausea](#)

[pupil dilation](#)

[vomiting](#)

Notes on poisoning:

Symptoms of ingestion include irregular heart rate and cold and clammy skin. Coma and death from heart failure may occur if enough plant material is ingested (Cooper and Johnson 1984).

References:

Cooper, M. R., Johnson, A. W. 1984. Poisonous plants in Britain and their effects on animals and man. Her Majesty's Stationery Office, London, England. 305 pp.

Frohne, D., Pfander, H. J. 1983. A colour atlas of poisonous plants. Wolfe Publishing Ltd., London, England. 291 pp.

[Another search?](#)

[Français](#) | [Contact Us](#) | [Help](#) | [Search](#) | [Canada site](#)

[Coming Events](#) | [About CBIF](#) | [Links](#) | [Reports and Publications](#) | [Home](#)

Date modified: 2003-02-06

[Important Notices](#)



Français	Contact us	Help	Search	Canada site
Coming events	About CBIF	Links	Reports and publications	Home

Canadian Biodiversity Information Facility



Notes on poisoning: *Cyclamen persicum*

[Introduction](#)[Interactive](#)[All poisonous plants by Botanical name](#)[All poisonous plants by Common name](#)[Important WWW Poisonous Plants sites](#)

General poisoning notes:

Cyclamen persicum is a houseplant that has a toxic saponin, cyclamin, in the tuberous rhizomes. The rhizome is bitter and found underground, so that children or family pets are unlikely to be exposed to the toxins. There is no information on the amounts of saponins, if any, in cyclamen foliage (Spoerke et al. 1987).

References:

Spoerke, D. G., Spoerke, S. E., Hall, A., Rumack, B. H. 1987. Toxicity of *Cyclamen persicum* (Mill). *Vet. Hum. Toxicol.*, 29: 250-251.

Nomenclature:

Scientific Name: *Cyclamen persicum* Mill.

Vernacular name(s): cyclamen

Scientific family name: *Primulaceae*

Vernacular family name: primrose

Go to ITIS*^{ca} for more taxonomic information on: [Cyclamen persicum](#)

References:

Agriculture Quebec. 1975. Noms des maladies des plantes du Canada/ Names of plant diseases in Canada. , Quebec City, Que., Canada. 288 pp.

Alex, J. F., Cayouette, R., Mulligan, G. A. 1980. Common and botanical names of weeds in Canada/Noms populaire et scientifiques des plantes nuisibles du Canada. Revised. Agric.

Can. Publ., Ottawa, Ont., Canada. 132 pp.

Bailey, L. H., Bailey, E. Z. 1976. Hortus third. Revised. MacMillan, New York, N.Y., USA. 1290 pp.

Scoggan, H. J. 1978, 1979. The flora of Canada. Nat. Mus. Nat. Sci. (Ottawa) Publ. Bot. 7(1)-7(4). 1711 pp.

Van Wijk, H. L. 1911. A dictionary of plant names. Martinus Nijhoff, The Hague, The Netherlands. 1444 pp.

Victorin, M. 1964. Flore Laurentienne. 2nd ed. Univ. Montreal, Montreal, Que., Canada. 952 pp.

Geographic Information

Plant or plant parts used in or around the home.

References:

Bailey, L. H., Bailey, E. Z. 1976. Hortus third. Revised. MacMillan, New York, N.Y., USA. 1290 pp.

Boivin, B. 1966, 1967. Énumération des plantes du Canada. Provencheria 6. Nat. Can. (Que.) 93: 253-274; 371-437; 583-646; 989-1063. 94: 131-157; 471-528; 625-655.

Image or illustration

Cyclamen persicum:

Images: images.google.com

Notes on Poisonous plant parts:

The tuberous rhizomes contain the chemical cyclamin. However, these rhizomes are in the soil and have an acrid taste, so that ingestion by children is not likely (Spoerke et al. 1987). Cyclamin is a triterpenoid saponin, which is an irritant that can cause nausea and even paralysis upon absorption. The chemical is not volatile, but it is water soluble and can occur as small white crystals or an amorphous, lusterless mass (Spoerke et al. 1987).

Toxic parts:

rhizome

tubers

References:

Frohne, D., Pfander, H. J. 1983. A colour atlas of poisonous

plants. Wolfe Publishing Ltd., London, England. 291 pp.

Notes on Toxic plant chemicals:

The tuberous rhizomes contain the chemical cyclamin. However, these rhizomes are in the soil and have an acrid taste, so that ingestion by children is not likely (Spoerke et al. 1987). Cyclamin is a triterpenoid saponin, which is an irritant that can cause nausea and even paralysis upon absorption. The chemical is not volatile, but it is water soluble and can occur as small white crystals or an amorphous, lusterless mass (Spoerke et al. 1987).

Toxic plant chemicals:

cyclamin
unknown chemical

References:

Frohne, D., Pfander, H. J. 1983. A colour atlas of poisonous plants. Wolfe Publishing Ltd., London, England. 291 pp.

Santucci, B., Picardo, M., Cristaudo, A. 1985. Contact dermatitis from *Euphorbia pulcherrima*. Contact Dermatitis, 12: 285-286.

Spoerke, D. G., Spoerke, S. E., Hall, A., Rumack, B. H. 1987. Toxicity of *Cyclamen persium* (Mill). Vet. Hum. Toxicol., 29: 250-251.

Animals/Human Poisoning:

Note: When an animal is listed without additional information, the literature (as of 1993) contained no detailed explanation.

Humans

[Another search?](#)

[Français](#) | [Contact Us](#) | [Help](#) | [Search](#) | [Canada site](#)

[Coming Events](#) | [About CBIF](#) | [Links](#) | [Reports and Publications](#) | [Home](#)

Date modified: 2003-02-06

[Important Notices](#)



Français	Contact us	Help	Search	Canada site
Coming events	About CBIF	Links	Reports and publications	Home

Canadian Biodiversity Information Facility



Notes on poisoning: *Cynoglossum officinale*

[Introduction](#)[Interactive](#)[All poisonous plants by Botanical name](#)[All poisonous plants by Common name](#)[Important WWW Poisonous Plants sites](#)

General poisoning notes:

Hound's-tongue (*Cynoglossum officinale*) is a naturalized biennial plant found across southern Canada. The plant contains pyrrolizidine alkaloids, which have caused poisoning and death in horses and cattle. The plant causes disorders of the central nervous system and can cause hepatic failure in horses (Knight et al. 1984).



References:

Cooper, M. R., Johnson, A. W. 1984. Poisonous plants in Britain and their effects on animals and man. Her Majesty's Stationery Office, London, England. 305 pp.

Knight, A. P., Kimberling, C. V., Stermitz, F. R., Roby, M. R. 1984. *Cynoglossum officinale* (hound's-tongue) - a cause of pyrrolizidine alkaloid poisoning in horses. J. Am. Vet. Med. Assoc., 185: 647-650.

Nomenclature:

Scientific Name: *Cynoglossum officinale* L.

Vernacular name(s): hound's tongue

Scientific family name: *Boraginaceae*

Vernacular family name: borage

Go to ITIS*^{ca} for more taxonomic information on: [Cynoglossum officinale](#)

References:

Agriculture Quebec. 1975. Noms des maladies des plantes du Canada/ Names of plant diseases in Canada. , Quebec City, Que.,

Canada. 288 pp.

Alex, J. F., Cayouette, R., Mulligan, G. A. 1980. Common and botanical names of weeds in Canada/Noms populaire et scientifiques des plantes nuisibles du Canada. Revised. Agric. Can. Publ., Ottawa, Ont., Canada. 132 pp.

Bailey, L. H., Bailey, E. Z. 1976. Hortus third. Revised. MacMillan, New York, N.Y., USA. 1290 pp.

Scoggan, H. J. 1978, 1979. The flora of Canada. Nat. Mus. Nat. Sci. (Ottawa) Publ. Bot. 7(1)-7(4). 1711 pp.

Van Wijk, H. L. 1911. A dictionary of plant names. Martinus Nijhoff, The Hague, The Netherlands. 1444 pp.

Victorin, M. 1964. Flore Laurentienne. 2nd ed. Univ. Montreal, Montreal, Que., Canada. 952 pp.

Geographic Information

Alberta
British Columbia
Manitoba
New Brunswick
Nova Scotia
Ontario
Quebec
Saskatchewan

References:

Bailey, L. H., Bailey, E. Z. 1976. Hortus third. Revised. MacMillan, New York, N.Y., USA. 1290 pp.

Boivin, B. 1966, 1967. Énumération des plantes du Canada. Provencheria 6. Nat. Can. (Que.) 93: 253-274; 371-437; 583-646; 989-1063. 94: 131-157; 471-528; 625-655.

Image or illustration

Cynoglossum officinale:

Images: images.google.com

Notes on Poisonous plant parts:

The concentration of the various alkaloids is highest in the rosette stage, i.e., when the leaves are all attached to the root crown and a stem has not grown yet (Knight et al. 1984).

Toxic parts:

leaves

References:

Knight, A. P., Kimberling, C. V., Stermitz, F. R., Roby, M. R. 1984. *Cynoglossum officinale* (hound's-tongue) - a cause of pyrrolizidine alkaloid poisoning in horses. J. Am. Vet. Med. Assoc., 185: 647-650.

Notes on Toxic plant chemicals:

The following LD-50 toxicities have been determined in male rats:

heliosupine	60 mg/kg
echinatine	350 mg/kg

The amount of pyrrolizidine alkaloid content in the plant has been reported to be 0.6-2.1% of dry matter (Cheeke and Schull 1985).

Toxic plant chemicals:

echinatine
heliosupine

References:

Cheeke, P. R., Shull, L. R. 1985. Natural toxicants in feeds and poisonous plants. AVI Publishing Company, Inc., Westport, Conn., USA. 492 pp.

Knight, A. P., Kimberling, C. V., Stermitz, F. R., Roby, M. R. 1984. *Cynoglossum officinale* (hound's-tongue) - a cause of pyrrolizidine alkaloid poisoning in horses. J. Am. Vet. Med. Assoc., 185: 647-650.

Animals/Human Poisoning:

Note: When an animal is listed without additional information, the literature (as of 1993) contained no detailed explanation.

Cattle

General symptoms of poisoning:

[death](#)

Notes on poisoning:

Cattle have also been poisoned after ingesting hound's-tongue. The animals often have staring expressions and diarrhea. They experience increased thirst, nervousness, and a drop in milk yield. Necropsy shows an inflamed stomach as well as swollen, edematous mesenteric lymph nodes. Death occurred within 24 h of plant ingestion (Cooper and Johnson 1984, Knight et al. 1984).

References:

Cooper, M. R., Johnson, A. W. 1984. Poisonous plants in Britain and their effects on animals and man. Her Majesty's Stationery Office, London, England. 305 pp.

Horses

General symptoms of poisoning:

[ataxia](#)

[breathing, rapid](#)

[coma](#)

[convulsions](#)

[death](#)

[depression](#)

[diarrhea](#)

[hemoglobinuria](#)

[icterus](#)

[liver, cirrhosis of](#)

[lungs, congestion of](#)

Notes on poisoning:

Actual and experimental cases of hound's-tongue ingestion by horses have resulted in sickness and death. Postmortem examinations show severe icterus and hepatic cirrhosis with diffuse, severe megalocytosis, biliary hyperplasia, and fibrosis (Knight 1984).

References:

Knight, A. P., Kimberling, C. V., Stermitz, F. R., Roby, M. R. 1984. *Cynoglossum officinale* (hound's-tongue) - a cause of pyrrolizidine alkaloid poisoning in horses. J. Am. Vet. Med. Assoc., 185: 647-650.

[Another search?](#)

[Français](#) | [Contact Us](#) | [Help](#) | [Search](#) | [Canada site](#)

[Coming Events](#) | [About CBIF](#) | [Links](#) | [Reports and Publications](#) | [Home](#)

Date modified: 2003-02-06

[Important Notices](#)



Français	Contact us	Help	Search	Canada site
Coming events	About CBIF	Links	Reports and publications	Home

Canadian Biodiversity Information Facility



Notes on poisoning: *Cypripedium acaule*

[Introduction](#)

[Interactive](#)

[All poisonous plants by Botanical name](#)

[All poisonous plants by Common name](#)

[Important WWW Poisonous Plants sites](#)

General poisoning notes:

Pink lady's-slipper (*Cypripedium acaule*) is a native perennial orchid that grows across most of Canada. The plant can cause severe dermatitis in some individuals, as do the other *Cypripedium* spp., upon contact with the glandular hairs on the leaves and stem (Reddoch and Reddoch 1984).



References:

MaCaulay, J. C. 1987. Orchid allergy. Contact Dermatitis, 17: 112-113.

Mitchell, J. C., Rook, A. 1979. Botanical dermatology. Greenglass Ltd, Vancouver, B.C., Canada. 787 pp.

Reddoch, A. H., Reddoch, J. M. 1984. Warning: Lady's-slippers can be hazardous to your health. Plant Press, 2(1): 10.

Nomenclature:

Scientific Name: *Cypripedium acaule* Ait.

Vernacular name(s): pink lady's-slipper

Scientific family name: *Orchidaceae*

Vernacular family name: orchid

Go to ITIS*^{ca} for more taxonomic information on: [Cypripedium acaule](#)

References:

Agriculture Quebec. 1975. Noms des maladies des plantes du Canada/ Names of plant diseases in Canada. , Quebec City, Que., Canada. 288 pp.

Alex, J. F., Cayouette, R., Mulligan, G. A. 1980. Common and botanical names of weeds in Canada/Noms populaire et scientifiques des plantes nuisibles du Canada. Revised. Agric. Can. Publ., Ottawa, Ont., Canada. 132 pp.

Bailey, L. H., Bailey, E. Z. 1976. Hortus third. Revised. MacMillan, New York, N.Y., USA. 1290 pp.

Scoggan, H. J. 1978, 1979. The flora of Canada. Nat. Mus. Nat. Sci. (Ottawa) Publ. Bot. 7(1)-7(4). 1711 pp.

Van Wijk, H. L. 1911. A dictionary of plant names. Martinus Nijhoff, The Hague, The Netherlands. 1444 pp.

Victorin, M. 1964. Flore Laurentienne. 2nd ed. Univ. Montreal, Montreal, Que., Canada. 952 pp.

Geographic Information

Alberta
Manitoba
New Brunswick
Newfoundland
Nova Scotia
Ontario
Prince Edward Island
Quebec
Saskatchewan

References:

Bailey, L. H., Bailey, E. Z. 1976. Hortus third. Revised. MacMillan, New York, N.Y., USA. 1290 pp.

Boivin, B. 1966, 1967. Énumération des plantes du Canada. Provencheria 6. Nat. Can. (Que.) 93: 253-274; 371-437; 583-646; 989-1063. 94: 131-157; 471-528; 625-655.

Image or illustration

Cypripedium acaule:

Images: images.google.com

Notes on Poisonous plant parts:

The glandular hairs on the leaves and stems of the lady's-slippers contain the dermatogenic chemical that causes dermatitis in some individuals (Mitchell and Rook 1979).

Toxic parts:

leaves
stems

References:

Mitchell, J. C., Rook, A. 1979. Botanical dermatology. Greenglass Ltd, Vancouver, B.C., Canada. 787 pp.

Reddoch, A. H., Reddoch, J. M. 1984. Warning: Lady's-slippers can be hazardous to your health. Plant Press, 2(1): 10.

Notes on Toxic plant chemicals:

The dermatogenic quinone, cypripedin, has been identified in lady's-slippers (Reddoch and Reddoch 1984).

Toxic plant chemicals:

cypripedin

References:

Reddoch, A. H., Reddoch, J. M. 1984. Warning: Lady's-slippers can be hazardous to your health. Plant Press, 2(1): 10.

Animals/Human Poisoning:

Note: When an animal is listed without additional information, the literature (as of 1993) contained no detailed explanation.

Humans

General symptoms of poisoning:

[blisters, weeping](#)

References:

Reddoch, A. H., Reddoch, J. M. 1984. Warning: Lady's-slippers can be hazardous to your health. Plant Press, 2(1): 10.

[Another search?](#)

[Français](#) | [Contact Us](#) | [Help](#) | [Search](#) | [Canada site](#)

[Coming Events](#) | [About CBIF](#) | [Links](#) | [Reports and Publications](#) | [Home](#)

Date modified: 2003-02-06

[Important Notices](#)



Français	Contact us	Help	Search	Canada site
Coming events	About CBIF	Links	Reports and publications	Home

Canadian Biodiversity Information Facility



Notes on poisoning: *Cypripedium calceolus*

[Introduction](#)[Interactive](#)[All poisonous plants by Botanical name](#)[All poisonous plants by Common name](#)[Important WWW Poisonous Plants sites](#)

General poisoning notes:

Yellow lady's-slipper (*Cypripedium calceolus*) is a native perennial wild flower found across Canada. The plant causes a type of dermatitis that resembles the dermatitis caused by poison-ivy (*Rhus spp.*). See additional information under general notes for [Cypripedium acaule](#).



References:

Reddoch, A. H., Reddoch, J. M. 1984. Warning: Lady's-slippers can be hazardous to your health. Plant Press, 2(1): 10.

Nomenclature:

Scientific Name: *Cypripedium calceolus* L.

Vernacular name(s): yellow lady's-slipper

Scientific family name: *Orchidaceae*

Vernacular family name: orchid

Go to ITIS^{*ca} for more taxonomic information on: [Cypripedium calceolus](#)

References:

Agriculture Quebec. 1975. Noms des maladies des plantes du Canada/ Names of plant diseases in Canada. , Quebec City, Que., Canada. 288 pp.

Alex, J. F., Cayouette, R., Mulligan, G. A. 1980. Common and botanical names of weeds in Canada/Noms populaire et scientifiques des plantes nuisibles du Canada. Revised. Agric. Can. Publ., Ottawa, Ont., Canada. 132 pp.

Bailey, L. H., Bailey, E. Z. 1976. Hortus third. Revised. MacMillan, New York, N.Y., USA. 1290 pp.

Scoggan, H. J. 1978, 1979. The flora of Canada. Nat. Mus. Nat. Sci. (Ottawa) Publ. Bot. 7(1)-7(4). 1711 pp.

Van Wijk, H. L. 1911. A dictionary of plant names. Martinus Nijhoff, The Hague, The Netherlands. 1444 pp.

Victorin, M. 1964. Flore Laurentienne. 2nd ed. Univ. Montreal, Montreal, Que., Canada. 952 pp.

Geographic Information

Alberta
British Columbia
Labrador
Manitoba
New Brunswick
Newfoundland
Northwest Territories
Nova Scotia
Ontario
Quebec
Saskatchewan

References:

Bailey, L. H., Bailey, E. Z. 1976. Hortus third. Revised. MacMillan, New York, N.Y., USA. 1290 pp.

Boivin, B. 1966, 1967. Énumération des plantes du Canada. Provencheria 6. Nat. Can. (Que.) 93: 253-274; 371-437; 583-646; 989-1063. 94: 131-157; 471-528; 625-655.

Image or illustration

Cypripedium calceolus:

Images: images.google.com

Toxic parts:

leaves
stems

References:

Reddoch, A. H., Reddoch, J. M. 1984. Warning: Lady's-slippers can be hazardous to your health. Plant Press, 2(1): 10.

Toxic plant chemicals:

cypripedin

References:

Reddoch, A. H., Reddoch, J. M. 1984. Warning: Lady's-slippers can be hazardous to your health. Plant Press, 2(1): 10.

Animals/Human Poisoning:

Note: When an animal is listed without additional information, the literature (as of 1993) contained no detailed explanation.

Humans

General symptoms of poisoning:

[blisters, weeping](#)

References:

Reddoch, A. H., Reddoch, J. M. 1984. Warning: Lady's-slippers can be hazardous to your health. Plant Press, 2(1): 10.

[Another search?](#)

[Français](#) | [Contact Us](#) | [Help](#) | [Search](#) | [Canada site](#)

[Coming Events](#) | [About CBIF](#) | [Links](#) | [Reports and Publications](#) | [Home](#)

Date modified: 2003-02-06

[Important Notices](#)



Français	Contact us	Help	Search	Canada site
Coming events	About CBIF	Links	Reports and publications	Home

Canadian Biodiversity Information Facility



Notes on poisoning: *Cypripedium reginae*

[Introduction](#)[Interactive](#)[All poisonous plants by Botanical name](#)[All poisonous plants by Common name](#)[Important WWW Poisonous Plants sites](#)

General poisoning notes:

Showy lady's-slipper (*Cypripedium reginae*) is a native orchid found in eastern Canada. The plant can cause dermatitis in sensitive individuals. The symptoms are similar to those of poison-ivy (*Rhus spp.*). See additional information under general notes of [Cypripedium acaule](#).



References:

Reddoch, A. H., Reddoch, J. M. 1984. Warning: Lady's-slippers can be hazardous to your health. Plant Press, 2(1): 10.

Nomenclature:

Scientific Name: *Cypripedium reginae* Walt.

Vernacular name(s): showy lady's-slipper

Scientific family name: *Orchidaceae*

Vernacular family name: orchid

Go to ITIS*^{ca} for more taxonomic information on: [Cypripedium reginae](#)

References:

Agriculture Quebec. 1975. Noms des maladies des plantes du Canada/ Names of plant diseases in Canada. , Quebec City, Que., Canada. 288 pp.

Alex, J. F., Cayouette, R., Mulligan, G. A. 1980. Common and botanical names of weeds in Canada/Noms populaire et scientifiques des plantes nuisibles du Canada. Revised. Agric. Can. Publ., Ottawa, Ont., Canada. 132 pp.

Bailey, L. H., Bailey, E. Z. 1976. Hortus third. Revised. MacMillan, New York, N.Y., USA. 1290 pp.

Scoggan, H. J. 1978, 1979. The flora of Canada. Nat. Mus. Nat. Sci. (Ottawa) Publ. Bot. 7(1)-7(4). 1711 pp.

Van Wijk, H. L. 1911. A dictionary of plant names. Martinus Nijhoff, The Hague, The Netherlands. 1444 pp.

Victorin, M. 1964. Flore Laurentienne. 2nd ed. Univ. Montreal, Montreal, Que., Canada. 952 pp.

Geographic Information

Manitoba
New Brunswick
Newfoundland
Nova Scotia
Ontario
Prince Edward Island
Quebec

References:

Bailey, L. H., Bailey, E. Z. 1976. Hortus third. Revised. MacMillan, New York, N.Y., USA. 1290 pp.

Boivin, B. 1966, 1967. Énumération des plantes du Canada. Provencheria 6. Nat. Can. (Que.) 93: 253-274; 371-437; 583-646; 989-1063. 94: 131-157; 471-528; 625-655.

Image or illustration

Cypripedium reginae:

Images: images.google.com

Toxic parts:

leaves
stems

References:

Reddoch, A. H., Reddoch, J. M. 1984. Warning: Lady's-slippers can be hazardous to your health. Plant Press, 2(1): 10.

Toxic plant chemicals:

cypripedin

References:

Reddoch, A. H., Reddoch, J. M. 1984. Warning: Lady's-slippers can be hazardous to your health. Plant Press, 2(1): 10.

Animals/Human Poisoning:

Note: When an animal is listed without additional information, the literature (as of 1993) contained no detailed explanation.

Humans

General symptoms of poisoning:

[blisters, weeping](#)

References:

Reddoch, A. H., Reddoch, J. M. 1984. Warning: Lady's-slippers can be hazardous to your health. Plant Press, 2(1): 10.

[Another search?](#)

[Français](#) | [Contact Us](#) | [Help](#) | [Search](#) | [Canada site](#)

[Coming Events](#) | [About CBIF](#) | [Links](#) | [Reports and Publications](#) | [Home](#)

Date modified: 2003-02-06

[Important Notices](#)



Français	Contact us	Help	Search	Canada site
Coming events	About CBIF	Links	Reports and publications	Home

Canadian Biodiversity Information Facility



Notes on poisoning: *Daphne cneorum*

[Introduction](#)[Interactive](#)[All poisonous plants by Botanical name](#)[All poisonous plants by Common name](#)[Important WWW Poisonous Plants sites](#)

General poisoning notes:

Garland daphne (*Daphne cneorum*) is an ornamental shrub found in the warmest parts of Canada. This shrub contains the same toxins as the other *Daphne* spp. listed in this information system. It is capable of causing poisoning in humans and any animals that might ingest it, such as family pets. See additional information under general notes for [Daphne mezereum](#).

References:

Lampe, K. F., McCann, M. A. 1985. AMA Handbook of poisonous and injurious plants. American Medical Assoc. Chicago, Ill., USA. 432 pp.

Nomenclature:

Scientific Name: *Daphne cneorum* L.

Vernacular name(s): garland daphne

Scientific family name: *Thymelaeaceae*

Vernacular family name: mezereum

References:

Agriculture Quebec. 1975. Noms des maladies des plantes du Canada/ Names of plant diseases in Canada. , Quebec City, Que., Canada. 288 pp.

Alex, J. F., Cayouette, R., Mulligan, G. A. 1980. Common and botanical names of weeds in Canada/Noms populaire et scientifiques des plantes nuisibles du Canada. Revised. Agric. Can. Publ., Ottawa, Ont., Canada. 132 pp.

Bailey, L. H., Bailey, E. Z. 1976. Hortus third. Revised.

MacMillan, New York, N.Y., USA. 1290 pp.

Scoggan, H. J. 1978, 1979. The flora of Canada. Nat. Mus. Nat. Sci. (Ottawa) Publ. Bot. 7(1)-7(4). 1711 pp.

Van Wijk, H. L. 1911. A dictionary of plant names. Martinus Nijhoff, The Hague, The Netherlands. 1444 pp.

Victorin, M. 1964. Flore Laurentienne. 2nd ed. Univ. Montreal, Montreal, Que., Canada. 952 pp.

Geographic Information

Plant or plant parts used in or around the home.

References:

Bailey, L. H., Bailey, E. Z. 1976. Hortus third. Revised. MacMillan, New York, N.Y., USA. 1290 pp.

Boivin, B. 1966, 1967. Énumération des plantes du Canada. Provencheria 6. Nat. Can. (Que.) 93: 253-274; 371-437; 583-646; 989-1063. 94: 131-157; 471-528; 625-655.

Image or illustration

Daphne cneorum:

Images: images.google.com

Toxic parts:

all parts
flowers
leaves
mature fruit
seeds

References:

Lampe, K. F., McCann, M. A. 1985. AMA Handbook of poisonous and injurious plants. American Medical Assoc. Chicago, Ill., USA. 432 pp.

Toxic plant chemicals:

daphnetoxin
dihydroxycoumarin
mezeroin

References:

Fuller, T. C., McClintock, E. 1986. Poisonous plants of California. Univ. California Press, Berkeley, Calif., USA. 432 pp.

Lampe, K. F., McCann, M. A. 1985. AMA Handbook of poisonous and injurious plants. American Medical Assoc. Chicago, Ill., USA. 432 pp.

Animals/Human Poisoning:

Note: When an animal is listed without additional information, the literature (as of 1993) contained no detailed explanation.

Cats

Dogs

Humans

General symptoms of poisoning:

[abdominal pains](#)

[diarrhea](#)

[kidney, congestion of](#)

[mouth, irritation of](#)

[salivation](#)

[thirsty](#)

References:

Lampe, K. F., McCann, M. A. 1985. AMA Handbook of poisonous and injurious plants. American Medical Assoc. Chicago, Ill., USA. 432 pp.

[Another search?](#)

[Français](#) | [Contact Us](#) | [Help](#) | [Search](#) | [Canada site](#)

[Coming Events](#) | [About CBIF](#) | [Links](#) | [Reports and Publications](#) |

[Home](#)

Date modified: 2003-02-06

[Important Notices](#)



Français	Contact us	Help	Search	Canada site
Coming events	About CBIF	Links	Reports and publications	Home

Canadian Biodiversity Information Facility



Notes on poisoning: *Daphne laureola*

[Introduction](#)

[Interactive](#)

[All poisonous plants by Botanical name](#)

[All poisonous plants by Common name](#)

[Important WWW Poisonous Plants sites](#)

General poisoning notes:

Spurge-laurel (*Daphne laureola*) is an ornamental shrub that is poisonous to animals that ingest it. The *Daphne* species listed in this information system cause few cases of poisoning, but children or family pets can be affected. See additional information under general notes of [Daphne mezereum](#).



References:

Lampe, K. F., McCann, M. A. 1985. AMA Handbook of poisonous and injurious plants. American Medical Assoc. Chicago, Ill., USA. 432 pp.

Nomenclature:

Scientific Name: *Daphne laureola* L.

Vernacular name(s): spurge-laurel

Scientific family name: *Thymelaeaceae*

Vernacular family name: mezereum

Go to ITIS^{*ca} for more taxonomic information on: [Daphne laureola](#)

References:

Agriculture Quebec. 1975. Noms des maladies des plantes du Canada/ Names of plant diseases in Canada. , Quebec City, Que., Canada. 288 pp.

Alex, J. F., Cayouette, R., Mulligan, G. A. 1980. Common and botanical names of weeds in Canada/Noms populaire et scientifiques des plantes nuisibles du Canada. Revised. Agric. Can. Publ., Ottawa, Ont., Canada. 132 pp.

Bailey, L. H., Bailey, E. Z. 1976. Hortus third. Revised. MacMillan, New York, N.Y., USA. 1290 pp.

Scoggan, H. J. 1978, 1979. The flora of Canada. Nat. Mus. Nat. Sci. (Ottawa) Publ. Bot. 7(1)-7(4). 1711 pp.

Van Wijk, H. L. 1911. A dictionary of plant names. Martinus Nijhoff, The Hague, The Netherlands. 1444 pp.

Victorin, M. 1964. Flore Laurentienne. 2nd ed. Univ. Montreal, Montreal, Que., Canada. 952 pp.

Geographic Information

Plant or plant parts used in or around the home.

References:

Bailey, L. H., Bailey, E. Z. 1976. Hortus third. Revised. MacMillan, New York, N.Y., USA. 1290 pp.

Boivin, B. 1966, 1967. Énumération des plantes du Canada. Provencheria 6. Nat. Can. (Que.) 93: 253-274; 371-437; 583-646; 989-1063. 94: 131-157; 471-528; 625-655.

Image or illustration

Daphne laureola:

Images: images.google.com

Toxic parts:

all parts
bark
flowers
leaves
mature fruit

References:

Lampe, K. F., McCann, M. A. 1985. AMA Handbook of poisonous and injurious plants. American Medical Assoc. Chicago, Ill., USA. 432 pp.

Toxic plant chemicals:

daphnetoxin
dihydroxycoumarin
mezeroin

References:

Fuller, T. C., McClintock, E. 1986. Poisonous plants of California. Univ. California Press, Berkeley, Calif., USA. 432 pp.

Lampe, K. F., McCann, M. A. 1985. AMA Handbook of poisonous and injurious plants. American Medical Assoc. Chicago, Ill., USA. 432 pp.

Animals/Human Poisoning:

Note: When an animal is listed without additional information, the literature (as of 1993) contained no detailed explanation.

Cats

Dogs

Humans

General symptoms of poisoning:

[abdominal pains](#)

[diarrhea](#)

[dysphagia](#)

[mouth, irritation of](#)

[salivation](#)

[thirsty](#)

References:

Lampe, K. F., McCann, M. A. 1985. AMA Handbook of poisonous and injurious plants. American Medical Assoc. Chicago, Ill., USA. 432 pp.

[Another search?](#)

[Français](#) | [Contact Us](#) | [Help](#) | [Search](#) | [Canada site](#)

[Coming Events](#) | [About CBIF](#) | [Links](#) | [Reports and Publications](#) |

[Home](#)

Date modified: 2003-02-06

[Important Notices](#)



Français	Contact us	Help	Search	Canada site
Coming events	About CBIF	Links	Reports and publications	Home

Canadian Biodiversity Information Facility



Notes on poisoning: *Daphne mezereum*

[Introduction](#)[Interactive](#)[All poisonous plants by Botanical name](#)[All poisonous plants by Common name](#)[Important WWW Poisonous Plants sites](#)

General poisoning notes:

February daphne (*Daphne mezereum*) is an ornamental shrub that grows across southern Canada. This shrub and other *Daphne* species are poisonous to humans and animals. The plants contain irritant chemicals that cause pain, burning, and tingling sensations on exposed skin. These sensations are intensified on mucous membranes in the mouth, throat, and stomach after ingesting the fruits. More serious symptoms also occur in humans, including kidney damage, which may lead to death. With the exception of February daphne, the other *Daphne* species and cultivars are found only as ornamental plants in the more southerly and temperate parts of Canada. February daphne is naturalized in several eastern provinces. Horses and swine have been poisoned and have died after ingesting daphne leaves or berries, although poisoning of animals is a rare occurrence. Family pets can be poisoned if they have access to the plants. Several references give additional information (Frohne and Pfander 1983, Cooper and Johnson 1984, Lampe and McCann 1985, Fuller and McClintock 1986).

References:

- Cooper, M. R., Johnson, A. W. 1984. Poisonous plants in Britain and their effects on animals and man. Her Majesty's Stationery Office, London, England. 305 pp.
- Frohne, D., Pfander, H. J. 1983. A colour atlas of poisonous plants. Wolfe Publishing Ltd., London, England. 291 pp.
- Fuller, T. C., McClintock, E. 1986. Poisonous plants of California. Univ. California Press, Berkeley, Calif., USA. 432 pp.
- Fyles, F. 1920. Principal poisonous plants of Canada. Can. Dep. Agric. Exp. Farms. Bull. 39. 112 pp.
- Lampe, K. F., McCann, M. A. 1985. AMA Handbook of

poisonous and injurious plants. American Medical Assoc.
Chicago, Ill., USA. 432 pp.

Nomenclature:

Scientific Name: *Daphne mezereum* L.

Vernacular name(s): February daphne

Scientific family name: *Thymelaeaceae*

Vernacular family name: mezereum

Go to ITIS^{*ca} for more taxonomic information on: [Daphne mezereum](#)

References:

Agriculture Quebec. 1975. Noms des maladies des plantes du Canada/ Names of plant diseases in Canada. , Quebec City, Que., Canada. 288 pp.

Alex, J. F., Cayouette, R., Mulligan, G. A. 1980. Common and botanical names of weeds in Canada/Noms populaire et scientifiques des plantes nuisibles du Canada. Revised. Agric. Can. Publ., Ottawa, Ont., Canada. 132 pp.

Bailey, L. H., Bailey, E. Z. 1976. Hortus third. Revised. MacMillan, New York, N.Y., USA. 1290 pp.

Scoggan, H. J. 1978, 1979. The flora of Canada. Nat. Mus. Nat. Sci. (Ottawa) Publ. Bot. 7(1)-7(4). 1711 pp.

Van Wijk, H. L. 1911. A dictionary of plant names. Martinus Nijhoff, The Hague, The Netherlands. 1444 pp.

Victorin, M. 1964. Flore Laurentienne. 2nd ed. Univ. Montreal, Montreal, Que., Canada. 952 pp.

Geographic Information

Newfoundland

Nova Scotia

Ontario

Prince Edward Island

Quebec

References:

Bailey, L. H., Bailey, E. Z. 1976. Hortus third. Revised. MacMillan, New York, N.Y., USA. 1290 pp.

Boivin, B. 1966, 1967. Énumération des plantes du Canada.

Provencheria 6. Nat. Can. (Que.) 93: 253-274; 371-437; 583-646; 989-1063. 94: 131-157; 471-528; 625-655.

Image or illustration

Daphne mezereum:

Images: images.google.com

Notes on Poisonous plant parts:

All the *Daphne* species in this information system have the same toxic chemical found in all parts of the plant. The only part of the plants without mezerein is the fruit pulp. It is the broken seeds that are responsible for symptoms when fruit is chewed. Ingesting one or two of the bitter berries can cause severe poisoning in children. Twelve berries can be fatal to an adult human (Frohne and Pfander 1983, Fuller and McClintock 1986).

Toxic parts:

all parts
bark
flowers
mature fruit
seeds

References:

Frohne, D., Pfander, H. J. 1983. A colour atlas of poisonous plants. Wolfe Publishing Ltd., London, England. 291 pp.

Fuller, T. C., McClintock, E. 1986. Poisonous plants of California. Univ. California Press, Berkeley, Calif., USA. 432 pp.

Notes on Toxic plant chemicals:

Daphnetoxin and mezerein are diterpene alcohols with a daphnane skeleton. Mezerein has cocarcinogenic activity as does the chemically related phorbol esters found in many toxic members of the spurge family (Euphorbiaceae). In mice, daphnetoxin was determined to have an LD-50 of 275 micro g/kg and the mouse ear inflammation unit is 0.2 micro g of mezerein per ear (Frohne and Pfander 1983). The bark of these daphne plants contains a coumarin glycoside that has the aglycone dihydroxycoumarin (Fuller and McClintock 1986).

Toxic plant chemicals:

daphnetoxin
dihydroxycoumarin
mezerin

References:

Fuller, T. C., McClintock, E. 1986. Poisonous plants of California. Univ. California Press, Berkeley, Calif., USA. 432 pp.

Lampe, K. F., McCann, M. A. 1985. AMA Handbook of poisonous and injurious plants. American Medical Assoc. Chicago, Ill., USA. 432 pp.

Animals/Human Poisoning:

Note: When an animal is listed without additional information, the literature (as of 1993) contained no detailed explanation.

Dogs

Horses

General symptoms of poisoning:

[abdominal pains](#)

[death](#)

[vomiting](#)

Notes on poisoning:

Horses have been poisoned by the leaves and berries of the *Daphne* species. Abdominal pains, breathing problems, and death occurred. Post-mortem symptoms included inflammation, swelling, and blood-stained contents of the gastrointestinal tract. Experimental feeding produced similar symptoms but did not result in death. Only 100-150 g of the plants, which are bitter, were eaten (Cooper and Johnson 1984).

References:

Cooper, M. R., Johnson, A. W. 1984. Poisonous plants in Britain and their effects on animals and man. Her Majesty's Stationery Office, London, England. 305 pp.

Humans

General symptoms of poisoning:

[abdominal pains](#)

[breathing, labored](#)

[convulsions](#)

[death](#)

[diarrhea](#)

[dysphagia](#)

[gait, staggering](#)

[hoarseness](#)

[kidney failure](#)

[mouth, irritation of](#)

[muscle twitching](#)

[prostration](#)

[temperature, elevated](#)

[thirsty](#)

[vomiting](#)

Notes on poisoning:

Human poisoning by the *Daphne* species can include minor irritation of the mouth region including pain, burning, and tingling. If the plant material is also chewed and ingested, more severe symptoms occur, including bloody diarrhea, abdominal pains, vomiting, and convulsions. In severe cases, prostration, hallucinations, shedding of the lining of the oral and mucous membranes, and renal damage can occur. In one case, a child was killed in Nova Scotia after ingesting berries (Fyles 1920). Ingestion may lead to muscular twitching and somnolence, which persists for days. Few cases of poisoning actually occur, but the consequences of ingestion can be serious (Frohne and Pfander 1983, Cooper and Johnson 1984, Lampe and McCann 1985, Fuller and McClintock 1985).

References:

Cooper, M. R., Johnson, A. W. 1984. Poisonous plants in Britain and their effects on animals and man. Her Majesty's Stationery Office, London, England. 305 pp.

Frohne, D., Pfander, H. J. 1983. A colour atlas of poisonous plants. Wolfe Publishing Ltd., London, England. 291 pp.

Fuller, T. C., McClintock, E. 1986. Poisonous plants of California. Univ. California Press, Berkeley, Calif., USA. 432 pp.

Lampe, K. F., McCann, M. A. 1985. AMA Handbook of poisonous and injurious plants. American Medical Assoc. Chicago, Ill., USA. 432 pp.

Swine

General symptoms of poisoning:

[death](#)

[vomiting](#)

Notes on poisoning:

A litter of 10-week-old pigs were given daphne berries and they died suddenly. The pigs had vomited before they died. Postmortem examination revealed white, burned patches in the mouth and an intensely inflamed stomach (Cooper and Johnson 1984).

References:

Cooper, M. R., Johnson, A. W. 1984. Poisonous plants in Britain and their effects on animals and man. Her Majesty's Stationery Office, London, England. 305 pp.

[Another search?](#)

[Français](#) | [Contact Us](#) | [Help](#) | [Search](#) | [Canada site](#)

[Coming Events](#) | [About CBIF](#) | [Links](#) | [Reports and Publications](#) | [Home](#)

Date modified: 2003-02-06

[Important Notices](#)



Français	Contact us	Help	Search	Canada site
Coming events	About CBIF	Links	Reports and publications	Home

Canadian Biodiversity Information Facility



Notes on poisoning: *Datura innoxia*

[Introduction](#)[Interactive](#)[All poisonous plants by Botanical name](#)[All poisonous plants by Common name](#)[Important WWW Poisonous Plants sites](#)

General poisoning notes:

Angel's trumpet (*Datura innoxia*) contains toxic alkaloids that have caused poisoning and death in humans and other animals. Most of the literature concerns poisoning by jimsonweed (*Datura stramonium*), but angel's trumpet should be considered poisonous as well. This plant is occasionally grown as an outdoor ornamental herb because of its spectacular tubular flowers. See additional information under general notes of [Datura stramonium](#).

References:

Cheeke, P. R., Shull, L. R. 1985. Natural toxicants in feeds and poisonous plants. AVI Publishing Company, Inc., Westport, Conn., USA. 492 pp.

Cooper, M. R., Johnson, A. W. 1984. Poisonous plants in Britain and their effects on animals and man. Her Majesty's Stationery Office, London, England. 305 pp.

Kingsbury, J. M. 1964. Poisonous plants of the United States and Canada. Prentice-Hall Inc., Englewood Cliffs, N.J., USA. 626 pp.

Lampe, K. F., McCann, M. A. 1985. AMA Handbook of poisonous and injurious plants. American Medical Assoc. Chicago, Ill., USA. 432 pp.

Nomenclature:

Scientific Name: *Datura innoxia* Mill.

Vernacular name(s): angel's trumpet

Scientific family name: *Solanaceae*

Vernacular family name: nightshade

Go to ITIS^{*ca} for more taxonomic information on: [Datura innoxia](#)

References:

Agriculture Quebec. 1975. Noms des maladies des plantes du Canada/ Names of plant diseases in Canada. , Quebec City, Que., Canada. 288 pp.

Alex, J. F., Cayouette, R., Mulligan, G. A. 1980. Common and botanical names of weeds in Canada/Noms populaire et scientifiques des plantes nuisibles du Canada. Revised. Agric. Can. Publ., Ottawa, Ont., Canada. 132 pp.

Bailey, L. H., Bailey, E. Z. 1976. Hortus third. Revised. MacMillan, New York, N.Y., USA. 1290 pp.

Scoggan, H. J. 1978, 1979. The flora of Canada. Nat. Mus. Nat. Sci. (Ottawa) Publ. Bot. 7(1)-7(4). 1711 pp.

Van Wijk, H. L. 1911. A dictionary of plant names. Martinus Nijhoff, The Hague, The Netherlands. 1444 pp.

Victorin, M. 1964. Flore Laurentienne. 2nd ed. Univ. Montreal, Montreal, Que., Canada. 952 pp.

Geographic Information

Plant or plant parts used in or around the home.

References:

Bailey, L. H., Bailey, E. Z. 1976. Hortus third. Revised. MacMillan, New York, N.Y., USA. 1290 pp.

Boivin, B. 1966, 1967. Énumération des plantes du Canada. Provencheria 6. Nat. Can. (Que.) 93: 253-274; 371-437; 583-646; 989-1063. 94: 131-157; 471-528; 625-655.

Image or illustration

Datura innoxia:

Images: images.google.com

Toxic parts:

all parts
leaves
seeds

References:

Cheeke, P. R., Shull, L. R. 1985. Natural toxicants in feeds and poisonous plants. AVI Publishing Company, Inc., Westport, Conn., USA. 492 pp.

Notes on Toxic plant chemicals:

This plant contains the tropane alkaloids atropine, hyoscyamine, and hyoscyamine. See additional information under general notes of [Datura stramonium](#).

Toxic plant chemicals:

hyoscyamine

References:

Cheeke, P. R., Shull, L. R. 1985. Natural toxicants in feeds and poisonous plants. AVI Publishing Company, Inc., Westport, Conn., USA. 492 pp.

Animals/Human Poisoning:

Note: When an animal is listed without additional information, the literature (as of 1993) contained no detailed explanation.

Cattle

General symptoms of poisoning:

[death](#)

[muscle twitching](#)

[nervousness](#)

Notes on poisoning:

All types of animals can be poisoned by angel's trumpet because it contains alkaloids. However, no definite cases of poisoning have been reported. The most likely animals to be poisoned are family pets that may have access to plants outside the house.

References:

Kingsbury, J. M. 1964. Poisonous plants of the United States and Canada. Prentice-Hall Inc., Englewood Cliffs, N.J., USA. 626 pp.

Humans

General symptoms of poisoning:

[agitation](#)

[choreiform movement](#)

[coma](#)

[drowsiness](#)

[hallucination](#)

[temperature, elevated](#)

References:

Cooper, M. R., Johnson, A. W. 1984. Poisonous plants in Britain and their effects on animals and man. Her Majesty's Stationery Office, London, England. 305 pp.

Lampe, K. F., McCann, M. A. 1985. AMA Handbook of poisonous and injurious plants. American Medical Assoc. Chicago, Ill., USA. 432 pp.

[Another search?](#)

[Français](#) | [Contact Us](#) | [Help](#) | [Search](#) | [Canada site](#)

[Coming Events](#) | [About CBIF](#) | [Links](#) | [Reports and Publications](#) |

[Home](#)

Date modified: 2003-02-06

[Important Notices](#)



Français	Contact us	Help	Search	Canada site
Coming events	About CBIF	Links	Reports and publications	Home

Canadian Biodiversity Information Facility



Notes on poisoning: *Datura stramonium*

[Introduction](#)[Interactive](#)[All poisonous plants by Botanical name](#)[All poisonous plants by Common name](#)[Important WWW Poisonous Plants sites](#)

General poisoning notes:

Jimsonweed (*Datura stramonium*) is a naturalized annual herb found across most of southern Canada. This plant contains toxic tropane alkaloids, which have caused poisoning and death in humans and other animals. Jimsonweed is named for a case of human poisoning in Jamestown, Va., when soldiers were poisoned by eating the plant in a salad and then suffered delirium and hallucinations. The seeds and leaves are deliberately used to induce intoxication. Children are attracted by the large flowers and become poisoned after sucking the nectar from the base of flowers or ingesting the seeds. Occurrences of human poisoning are more frequent than livestock poisoning in recent literature reports. Animals of all types can be poisoned. The literature mentions poisoning of cattle, goats, horses, poultry, sheep, and swine. Because of the plant's strong odor and unpleasant taste, animals consume it only when other food is not available. The seeds are sometimes milled with other seeds and have caused problems (Cooper and Johnson 1984, Cheeke and Schull 1985, Lampe and McCann 1985).

References:

Callahan, R., Piccola, F., Gensheimer, K., Parkin, W. E., Prusakowski, J., Scheiber, G., Henry, S. 1981. Epidemiologic notes and reports. Plant poisonings - New Jersey. U.S. Dep. Health Hum. M. M. W. R., 30: 65-67.

Cheeke, P. R., Shull, L. R. 1985. Natural toxicants in feeds and poisonous plants. AVI Publishing Company, Inc., Westport, Conn., USA. 492 pp.

Cooper, M. R., Johnson, A. W. 1984. Poisonous plants in Britain and their effects on animals and man. Her Majesty's Stationery Office, London, England. 305 pp.

El Dirdiri, N. I., Wasfi, I. A., Adam, S. E., Edds, G. T. 1981.

Toxicity of *Datura stramonium* to sheep and goats. Vet. Hum. Toxicol., 23: 241-246.

Goldberg, R. E. 1951. The jimsonweed menace. Today's Health, 29: 38-39, 66.

Hughes, J. D., Clark, J. A. 1939. *Stramonium* poisoning. J. Am. Med. Assoc., 112: 2500-2502.

Jacobziner, H., Raybin, H. W. 1961. Fatal salicylate intoxication and stramonium poisoning. N. Y. State J. Med., 61: 301-303.

Keeler, R. F. 1981. Absence of arthrogryposis in newborn Hampshire pigs from sows ingesting toxic levels of jimsonweed during gestation. Vet. Hum. Toxicol., 23: 413-415.

Lampe, K. F., McCann, M. A. 1985. AMA Handbook of poisonous and injurious plants. American Medical Assoc. Chicago, Ill., USA. 432 pp.

Mitchell, J. E., Mitchell, F. N. 1955. Jimson weed (*Datura stramonium*) poisoning in childhood. J. Pediatr., 47: 227-230.

Moore, D. W. 1976. The autumnal high: jimsonweed in North Carolina. N. C. Med. J., 37: 492-494.

Nelson, P. D., Mercer, H. D., Essig, H. W., Minyard, J. P. 1982. Jimson weed seed toxicity in cattle. Vet. Hum. Toxicol., 24: 321-325.

Stiles, F. C. 1951. Stramonium poisoning. J. Pediatr., 39: 354-356.

Nomenclature:

Scientific Name: *Datura stramonium* L.

Vernacular name(s): jimsonweed

Scientific family name: *Solanaceae*

Vernacular family name: nightshade

Go to ITIS^{*ca} for more taxonomic information on: [Datura stramonium](#)

References:

Agriculture Quebec. 1975. Noms des maladies des plantes du Canada/ Names of plant diseases in Canada. , Quebec City, Que., Canada. 288 pp.

Alex, J. F., Cayouette, R., Mulligan, G. A. 1980. Common and botanical names of weeds in Canada/Noms populaire et scientifiques des plantes nuisibles du Canada. Revised. Agric.

Can. Publ., Ottawa, Ont., Canada. 132 pp.

Bailey, L. H., Bailey, E. Z. 1976. Hortus third. Revised. MacMillan, New York, N.Y., USA. 1290 pp.

Scoggan, H. J. 1978, 1979. The flora of Canada. Nat. Mus. Nat. Sci. (Ottawa) Publ. Bot. 7(1)-7(4). 1711 pp.

Van Wijk, H. L. 1911. A dictionary of plant names. Martinus Nijhoff, The Hague, The Netherlands. 1444 pp.

Victorin, M. 1964. Flore Laurentienne. 2nd ed. Univ. Montreal, Montreal, Que., Canada. 952 pp.

Geographic Information

Alberta
New Brunswick
Nova Scotia
Ontario
Prince Edward Island
Quebec
Saskatchewan

References:

Bailey, L. H., Bailey, E. Z. 1976. Hortus third. Revised. MacMillan, New York, N.Y., USA. 1290 pp.

Boivin, B. 1966, 1967. Énumération des plantes du Canada. Provencheria 6. Nat. Can. (Que.) 93: 253-274; 371-437; 583-646; 989-1063. 94: 131-157; 471-528; 625-655.

Image or illustration

Datura stramonium:

Images: images.google.com

Notes on Poisonous plant parts:

The entire plant contains alkaloids, but the leaves and seeds are the usual sources of poisoning in humans and other animals. Even the nectar of this plant contains alkaloids that contaminate honey (Cooper and Johnson 1984).

Toxic parts:

all parts
flowers
leaves

mature fruit
seeds
stems

References:

- Callahan, R., Piccola, F., Gensheimer, K., Parkin, W. E., Prusakowski, J., Scheiber, G., Henry, S. 1981. Epidemiologic notes and reports. Plant poisonings - New Jersey. U.S. Dep. Health Hum. M. M. W. R., 30: 65-67.
- Cooper, M. R., Johnson, A. W. 1984. Poisonous plants in Britain and their effects on animals and man. Her Majesty's Stationery Office, London, England. 305 pp.
- El Dirdiri, N. I., Wasfi, I. A., Adam, S. E., Edds, G. T. 1981. Toxicity of *Datura stramonium* to sheep and goats. Vet. Hum. Toxicol., 23: 241-246.
- Hughes, J. D., Clark, J. A. 1939. *Stramonium* poisoning. J. Am. Med. Assoc., 112: 2500-2502.
- Jacobziner, H., Raybin, H. W. 1961. Fatal salicylate intoxication and stramonium poisoning. N. Y. State J. Med., 61: 301-303.
- Keeler, R. F. 1981. Absence of arthrogryposis in newborn Hampshire pigs from sows ingesting toxic levels of jimsonweed during gestation. Vet. Hum. Toxicol., 23: 413-415.
- Mitchell, J. E., Mitchell, F. N. 1955. Jimson weed (*Datura stramonium*) poisoning in childhood. J. Pediatr., 47: 227-230.
- Nelson, P. D., Mercer, H. D., Essig, H. W., Minyard, J. P. 1982. Jimson weed seed toxicity in cattle. Vet. Hum. Toxicol., 24: 321-325.
- Stiles, F. C. 1951. Stramonium poisoning. J. Pediatr., 39: 354-356.

Notes on Toxic plant chemicals:

Several tropane alkaloids including hyoscyamine, hyoscine (also called scopolamine), and traces of atropine are found in the plant. The total alkaloid content in the plant varies from 0.25 to 0.7%. The alkaloids are found even in the nectar and can contaminate honey (Cooper and Johnson 1984, Cheeke and Schull 1985).

Toxic plant chemicals:

atropine
hyoscine(scopolamine)
hyoscyamine

References:

Cheeke, P. R., Shull, L. R. 1985. Natural toxicants in feeds and poisonous plants. AVI Publishing Company, Inc., Westport, Conn., USA. 492 pp.

Cooper, M. R., Johnson, A. W. 1984. Poisonous plants in Britain and their effects on animals and man. Her Majesty's Stationery Office, London, England. 305 pp.

Jacobziner, H., Raybin, H. W. 1961. Fatal salicylate intoxication and stramonium poisoning. N. Y. State J. Med., 61: 301-303.

Keeler, R. F. 1981. Absence of arthrogryposis in newborn Hampshire pigs from sows ingesting toxic levels of jimsonweed during gestation. Vet. Hum. Toxicol., 23: 413-415.

Moore, D. W. 1976. The autumnal high: jimsonweed in North Carolina. N. C. Med. J., 37: 492-494.

Nelson, P. D., Mercer, H. D., Essig, H. W., Minyard, J. P. 1982. Jimson weed seed toxicity in cattle. Vet. Hum. Toxicol., 24: 321-325.

Animals/Human Poisoning:

Note: When an animal is listed without additional information, the literature (as of 1993) contained no detailed explanation.

Cattle

General symptoms of poisoning:

[anorexia](#)

[bloat](#)

[muzzle, dry](#)

[pupils, pinpoint](#)

[tenesmus](#)

Notes on poisoning:

Symptoms in cattle include incoordination, restlessness, and increased respiration rate. Nelson et al. (1982) conducted feeding experiments on heifers that were fed a normal diet with varying amounts of jimsonweed seeds added. The seeds contained 0.26% atropine and 0.55% hyoscyne. Death of cattle seemed unlikely because rumen atony and anorexia limited intake of the feed to below lethal levels. The toxic dosage is about 2.9 mg of atropine and 0.5 mg of hyoscyne per kilogram of body weight, which is about 107 seeds per kilogram of body weight.

References:

Cheeke, P. R., Shull, L. R. 1985. Natural toxicants in feeds and poisonous plants. AVI Publishing Company, Inc., Westport, Conn., USA. 492 pp.

Nelson, P. D., Mercer, H. D., Essig, H. W., Minyard, J. P. 1982. Jimson weed seed toxicity in cattle. Vet. Hum. Toxicol., 24: 321-325.

Chickens

General symptoms of poisoning:

[weight gain, reduced](#)

References:

Cheeke, P. R., Shull, L. R. 1985. Natural toxicants in feeds and poisonous plants. AVI Publishing Company, Inc., Westport, Conn., USA. 492 pp.

Goats

General symptoms of poisoning:

[breathing, rapid](#)

[death](#)

[drowsiness](#)

[incoordination](#)

[recumbency](#)

[reflex excitability](#)

[trembling](#)

[water intake, reduced](#)

Notes on poisoning:

Goats have been poisoned by consuming jimsonweed. Experimental feeding of fresh leaves and fruit caused locomotion disturbances, tremors, drowsiness, and recumbency. Postmortem findings showed lung congestion, hemorrhagic and fatty liver, and heart dilation with hemorrhaging. The renal cortex was pale yellow and the medulla hemorrhagic. The cells of many renal tubes had also degenerated (El Dirdiri et al. 1981).

References:

El Dirdiri, N. I., Wasfi, I. A., Adam, S. E., Edds, G. T. 1981. Toxicity of *Datura stramonium* to sheep and goats. Vet. Hum. Toxicol., 23: 241-246.

Horses

General symptoms of poisoning:

[anorexia](#)
[breathing, rapid](#)
[diarrhea](#)
[heart rate, elevated](#)
[pupil dilation](#)
[thirsty](#)

References:

Cheeke, P. R., Shull, L. R. 1985. Natural toxicants in feeds and poisonous plants. AVI Publishing Company, Inc., Westport, Conn., USA. 492 pp.

Humans

General symptoms of poisoning:

[agitation](#)
[babinski reflex](#)
[choreiform movement](#)
[confusion](#)
[convulsions](#)
[death](#)
[dizziness](#)
[drowsiness](#)
[faintness](#)
[gait, unsteady](#)
[hallucination](#)
[heart rate, elevated](#)
[inebriation](#)
[memory loss](#)
[mouth dry](#)
[nausea](#)
[pupil dilation](#)
[reflex excitability](#)
[skin, dry](#)
[skin, flushed](#)
[speech, slurred](#)
[temperature, elevated](#)
[thirsty](#)
[unconsciousness](#)
[urination, absent](#)

[vision, impaired](#)

Notes on poisoning:

Symptoms of *Datura* species poisoning include dry mouth, mydriasis, dry and warm skin, sometimes with reddening of the face and neck. Hallucinations are common, along with blurred vision, random movements, nausea, delirium, and sometimes coma and death. Tachycardia and elevated temperatures occur. Treatment with physostigmine is recommended at 0.5 mg for children and 2 mg for adults (Moore 1976, Cooper and Johnson 1984, Lampe and McCann 1985).

References:

- Callahan, R., Piccola, F., Gensheimer, K., Parkin, W. E., Prusakowski, J., Scheiber, G., Henry, S. 1981. Epidemiologic notes and reports. Plant poisonings - New Jersey. U.S. Dep. Health Hum. M. M. W. R., 30: 65-67.
- Cooper, M. R., Johnson, A. W. 1984. Poisonous plants in Britain and their effects on animals and man. Her Majesty's Stationery Office, London, England. 305 pp.
- Goldberg, R. E. 1951. The jimsonweed menace. Today's Health, 29: 38-39, 66.
- Hughes, J. D., Clark, J. A. 1939. *Stramonium* poisoning. J. Am. Med. Assoc., 112: 2500-2502.
- Jacobziner, H., Raybin, H. W. 1961. Fatal salicylate intoxication and stramonium poisoning. N. Y. State J. Med., 61: 301-303.
- Lampe, K. F., McCann, M. A. 1985. AMA Handbook of poisonous and injurious plants. American Medical Assoc. Chicago, Ill., USA. 432 pp.
- Mitchell, J. E., Mitchell, F. N. 1955. Jimson weed (*Datura stramonium*) poisoning in childhood. J. Pediatr., 47: 227-230.
- Moore, D. W. 1976. The autumnal high: jimsonweed in North Carolina. N. C. Med. J., 37: 492-494.
- Stiles, F. C. 1951. Stramonium poisoning. J. Pediatr., 39: 354-356.

Sheep

General symptoms of poisoning:

[ataxia](#)

[breathing, rapid](#)

[collapse](#)

[dyspnea](#)

[gait, unsteady](#)
[incoordination](#)
[recumbency](#)
[reflex excitability](#)
[trembling](#)
[water intake, reduced](#)

Notes on poisoning:

Jimsonweed poisoning in sheep causes symptoms such as locomotion disturbances, rapid respiration, inability to stand and death. Sheep that were experimentally fed fresh leaves and fruits became ill and died (El Dirdiri et al. 1981). Postmortem examination showed lung congestion, a dilated heart, and hemorrhagic, fatty liver. The renal cortex was pale yellow and the medulla was hemorrhagic. Sheep that received 10 g/kg/day died within 38 days.

References:

El Dirdiri, N. I., Wasfi, I. A., Adam, S. E., Edds, G. T. 1981. Toxicity of *Datura stramonium* to sheep and goats. *Vet. Hum. Toxicol.*, 23: 241-246.

Swine

General symptoms of poisoning:

[depression](#)
[gait, rigid](#)
[incoordination](#)
[lethargy](#)
[pupil dilation](#)

Notes on poisoning:

Swine exhibit symptoms of incoordination, stiff gait, pupil dilation, and drowsiness. Earlier reports had suggested that jimsonweed ingested by pregnant sows might cause arthrogryposis in newborn pigs, but Keeler (1981) determined that this was not the case after feeding experiments. Other studies have found that pigs tolerated, with little effect, and alkaloid intake of 2.2 mg/kg of body weight from seeds containing 0.2-0.6% alkaloid content. Because of the unpalatability of jimsonweed seeds, the feed is rejected and therefore lethal quantities are not likely to be ingested (Cheeke and Schull 1985).

References:

Keeler, R. F. 1981. Absence of arthrogryposis in newborn

Hampshire pigs from sows ingesting toxic levels of jimsonweed during gestation. *Vet. Hum. Toxicol.*, 23: 413-415.

[Another search?](#)

[Français](#) | [Contact Us](#) | [Help](#) | [Search](#) | [Canada site](#)

[Coming Events](#) | [About CBIF](#) | [Links](#) | [Reports and Publications](#) |

[Home](#)

Date modified: 2003-02-06

[Important Notices](#)



Français	Contact us	Help	Search	Canada site
Coming events	About CBIF	Links	Reports and publications	Home

Canadian Biodiversity Information Facility



Notes on poisoning: *Delphinium bicolor*

[Introduction](#)[Interactive](#)[All poisonous plants by Botanical name](#)[All poisonous plants by Common name](#)[Important WWW Poisonous Plants sites](#)

General poisoning notes:

Low larkspur (*Delphinium bicolor*) is a native herb found in southern parts of western Canada. This plant has poisoned cattle, symptoms are similar to those caused by tall larkspur ([Delphinium glaucum](#).)

References:

Olsen, J. D., Manners, G. D. 1989. Toxicology of diterpenoid alkaloids in rangeland larkspur (*Delphinium* spp.). Pages 291-326 in Cheeke, P. R., ed. Toxicants of plant origin. Vol. I. Alkaloids. CRC Press, Inc., Boca Raton, Fla., USA. 335 pp.

Nomenclature:

Scientific Name: *Delphinium bicolor* Nutt.

Vernacular name(s): low larkspur

Scientific family name: *Ranunculaceae*

Vernacular family name: crowfoot

Go to ITIS*^{ca} for more taxonomic information on: [Delphinium bicolor](#)

References:

Agriculture Quebec. 1975. Noms des maladies des plantes du Canada/ Names of plant diseases in Canada. , Quebec City, Que., Canada. 288 pp.

Alex, J. F., Cayouette, R., Mulligan, G. A. 1980. Common and botanical names of weeds in Canada/Noms populaire et scientifiques des plantes nuisibles du Canada. Revised. Agric. Can. Publ., Ottawa, Ont., Canada. 132 pp.

Bailey, L. H., Bailey, E. Z. 1976. Hortus third. Revised. MacMillan,

New York, N.Y., USA. 1290 pp.

Scoggan, H. J. 1978, 1979. The flora of Canada. Nat. Mus. Nat. Sci. (Ottawa) Publ. Bot. 7(1)-7(4). 1711 pp.

Van Wijk, H. L. 1911. A dictionary of plant names. Martinus Nijhoff, The Hague, The Netherlands. 1444 pp.

Victorin, M. 1964. Flore Laurentienne. 2nd ed. Univ. Montreal, Montreal, Que., Canada. 952 pp.

Geographic Information

Alberta

British Columbia

Saskatchewan

References:

Bailey, L. H., Bailey, E. Z. 1976. Hortus third. Revised. MacMillan, New York, N.Y., USA. 1290 pp.

Boivin, B. 1966, 1967. Énumération des plantes du Canada. Provencheria 6. Nat. Can. (Que.) 93: 253-274; 371-437; 583-646; 989-1063. 94: 131-157; 471-528; 625-655.

Image or illustration

Delphinium bicolor:

Images: images.google.com

Notes on Poisonous plant parts:

See additional information under general notes of [Delphinium glaucum](#).

Toxic parts:

leaves

seeds

References:

Olsen, J. D., Manners, G. D. 1989. Toxicology of diterpenoid alkaloids in rangeland larkspur (*Delphinium* spp.). Pages 291-326 in Cheeke, P. R., ed. Toxicants of plant origin. Vol. I. Alkaloids. CRC Press, Inc., Boca Raton, Fla., USA. 335 pp.

Notes on Toxic plant chemicals:

See additional information under general notes of [Delphinium glaucum](#).

Toxic plant chemicals:

methyllycaconitine

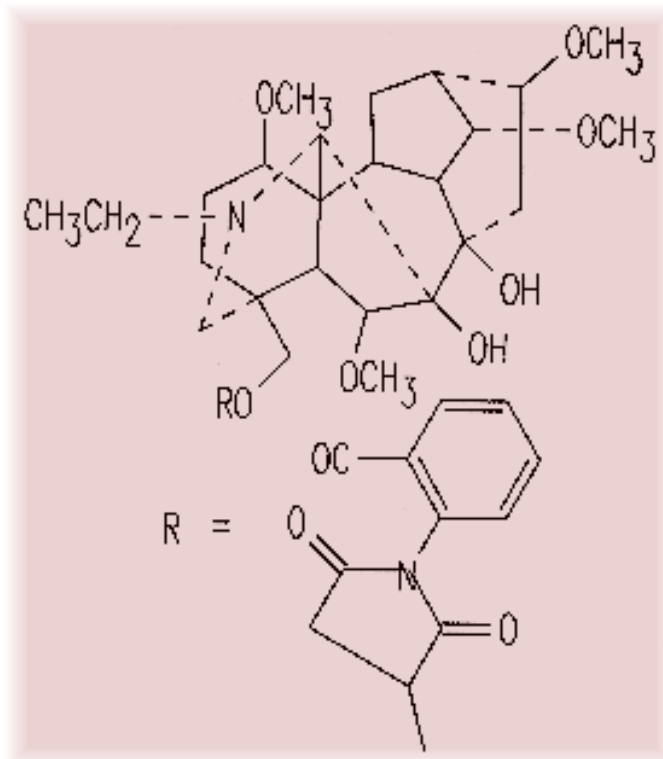

Chemical diagram(s) are courtesy of [Ruth McDiarmid](#), Biochemistry Technician, Kamloops Range Station, Agriculture and Agri-Food Canada, Kamloops, British Columbia, Canada.

References:

Olsen, J. D., Manners, G. D. 1989. Toxicology of diterpenoid alkaloids in rangeland larkspur (*Delphinium* spp.). Pages 291-326 in Cheeke, P. R., ed. Toxicants of plant origin. Vol. I. Alkaloids. CRC Press, Inc., Boca Raton, Fla., USA. 335 pp.

Animals/Human Poisoning:

Note: When an animal is listed without additional information, the literature (as of 1993) contained no detailed explanation.

Cattle

General symptoms of poisoning:

[bloat](#)

[constipation](#)

[death by asphyxiation](#)

[paralysis](#)

[salivation](#)

[weakness](#)

References:

Olsen, J. D., Manners, G. D. 1989. Toxicology of diterpenoid alkaloids in rangeland larkspur (*Delphinium* spp.). Pages 291-326 in Cheeke, P. R., ed. Toxicants of plant origin. Vol. I. Alkaloids. CRC Press, Inc., Boca Raton, Fla., USA. 335 pp.

Horses

Sheep

[Another search?](#)

[Français](#) | [Contact Us](#) | [Help](#) | [Search](#) | [Canada site](#)

[Coming Events](#) | [About CBIF](#) | [Links](#) | [Reports and Publications](#) | [Home](#)

Date modified: 2003-02-06

[Important Notices](#)



Français	Contact us	Help	Search	Canada site
Coming events	About CBIF	Links	Reports and publications	Home

Canadian Biodiversity Information Facility



Notes on poisoning: *Delphinium glaucum*

[Introduction](#)[Interactive](#)[All poisonous plants by Botanical name](#)[All poisonous plants by Common name](#)[Important WWW Poisonous Plants sites](#)

General poisoning notes:

Tall larkspur (*Delphinium glaucum*) is a native herb found in central and western Canada. The plant is poisonous to cattle and can be poisonous to horses and sheep when ingested in higher amounts. In an experiment with *Delphinium barbei* (not found in Canada), six times as much plant material (per kilogram of body weight) was needed to poison sheep than to poison cattle. Why cattle are sensitive to larkspur poisoning is not understood. The alkaloid methyllycaconitine causes curare-like effects on the skeletal muscles and can cause motor paralysis, followed by death from asphyxiation (Nation et al. 1982, Cheeke and Schull 1985, Olsen and Manners 1989).

References:

Cheeke, P. R., Shull, L. R. 1985. Natural toxicants in feeds and poisonous plants. AVI Publishing Company, Inc., Westport, Conn., USA. 492 pp.

Olsen, J. D., Manners, G. D. 1989. Toxicology of diterpenoid alkaloids in rangeland larkspur (*Delphinium* spp.). Pages 291-326 in Cheeke, P. R., ed. Toxicants of plant origin. Vol. I. Alkaloids. CRC Press, Inc., Boca Raton, Fla., USA. 335 pp.

Nomenclature:

Scientific Name: *Delphinium glaucum* S. Wats.

Vernacular name(s): tall larkspur

Scientific family name: *Ranunculaceae*

Vernacular family name: crowfoot

Go to ITIS*^{ca} for more taxonomic information on: [Delphinium glaucum](#)

References:

Agriculture Quebec. 1975. Noms des maladies des plantes du Canada/Names of plant diseases in Canada. , Quebec City, Que., Canada. 288 pp.

Alex, J. F., Cayouette, R., Mulligan, G. A. 1980. Common and botanical names of weeds in Canada/Noms populaire et scientifiques des plantes nuisibles du Canada. Revised. Agric. Can. Publ., Ottawa, Ont., Canada. 132 pp.

Bailey, L. H., Bailey, E. Z. 1976. Hortus third. Revised. MacMillan, New York, N.Y., USA. 1290 pp.

Scoggan, H. J. 1978, 1979. The flora of Canada. Nat. Mus. Nat. Sci. (Ottawa) Publ. Bot. 7(1)-7(4). 1711 pp.

Van Wijk, H. L. 1911. A dictionary of plant names. Martinus Nijhoff, The Hague, The Netherlands. 1444 pp.

Victorin, M. 1964. Flore Laurentienne. 2nd ed. Univ. Montreal, Montreal, Que., Canada. 952 pp.

Geographic Information

Alberta
British Columbia
Manitoba
Northwest Territories
Ontario
Quebec
Saskatchewan
Yukon Territory

References:

Bailey, L. H., Bailey, E. Z. 1976. Hortus third. Revised. MacMillan, New York, N.Y., USA. 1290 pp.

Boivin, B. 1966, 1967. Énumération des plantes du Canada. Provencheria 6. Nat. Can. (Que.) 93: 253-274; 371-437; 583-646; 989-1063. 94: 131-157; 471-528; 625-655.

Image or illustration

Delphinium glaucum:

Images: images.google.com

Notes on Poisonous plant parts:

All parts of larkspur plants contain alkaloids. Cattle have been poisoned after browsing on the aboveground plant material. Sheep and horses have been experimentally poisoned by various larkspur species, but they are much more tolerant of the toxic alkaloids (Olsen and Manners 1989).

Toxic parts:

all parts
leaves
seeds

References:

Looman, J. 1984. The biological flora of Canada. 5. *Delphinium glaucum* Watson, tall larkspur. Can. Field-Nat., 98: 345-361.

Olsen, J. D., Manners, G. D. 1989. Toxicology of diterpenoid alkaloids in rangeland larkspur (*Delphinium* spp.). Pages 291-326 in Cheeke, P. R., ed. Toxicants of plant origin. Vol. I. Alkaloids. CRC Press, Inc., Boca Raton, Fla., USA. 335 pp.

Notes on Toxic plant chemicals:

Methyllycaconitine, a diterpene alkaloid, is considered to be the most toxic of the alkaloids occurring in larkspurs that are likely to be grazed by cattle on rangelands. Many other alkaloids occur in larkspurs, but they are much less toxic than methyllycaconitine. The LD-50 of this chemical on mice is 3.2 mg/kg administered intravenously. It has a pronounced curare-like effect on skeletal muscle (Olsen and Manners 1989).

Toxic plant chemicals:

methyllycaconitine

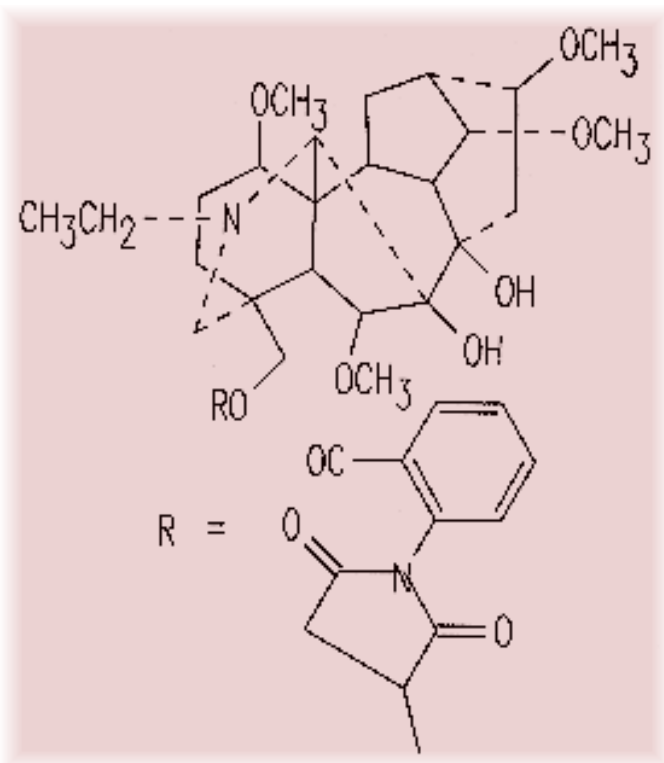

Chemical diagram(s) are courtesy of [Ruth McDiarmid](#), Biochemistry Technician, Kamloops Range Station, Agriculture and Agri-Food Canada, Kamloops, British Columbia, Canada.

References:

Looman, J. 1984. The biological flora of Canada. 5. *Delphinium glaucum* Watson, tall larkspur. Can. Field-Nat., 98: 345-361.

Olsen, J. D., Manners, G. D. 1989. Toxicology of diterpenoid alkaloids in rangeland larkspur (*Delphinium* spp.). Pages 291-326 in Cheeke, P. R., ed. Toxicants of plant origin. Vol. I. Alkaloids. CRC Press, Inc., Boca Raton, Fla., USA. 335 pp.

Animals/Human Poisoning:

Note: When an animal is listed without additional information, the literature (as of 1993) contained no detailed explanation.

Cattle

Horses

Sheep

[Another search?](#)

[Français](#) | [Contact Us](#) | [Help](#) | [Search](#) | [Canada site](#)

[Coming Events](#) | [About CBIF](#) | [Links](#) | [Reports and Publications](#) | [Home](#)

Date modified: 2003-02-06

[Important Notices](#)



Français	Contact us	Help	Search	Canada site
Coming events	About CBIF	Links	Reports and publications	Home

Canadian Biodiversity Information Facility



Notes on poisoning: *Delphinium menziesii*

[Introduction](#)[Interactive](#)[All poisonous plants by Botanical name](#)[All poisonous plants by Common name](#)[Important WWW Poisonous Plants sites](#)

General poisoning notes:

Menzies larkspur (*Delphinium menziesii*) is a native herb found on the rangelands of British Columbia. This plant has been implicated in poisoning rangeland cattle. Additional information can be found under general notes of tall larkspur (*Delphinium glaucum*).

References:

Cheeke, P. R., Shull, L. R. 1985. Natural toxicants in feeds and poisonous plants. AVI Publishing Company, Inc., Westport, Conn., USA. 492 pp.

Nomenclature:

Scientific Name: *Delphinium menziesii* DC.

Vernacular name(s): Menzies larkspur

Scientific family name: *Ranunculaceae*

Vernacular family name: crowfoot

Go to ITIS*^{ca} for more taxonomic information on: [Delphinium menziesii](#)

References:

Agriculture Quebec. 1975. Noms des maladies des plantes du Canada/ Names of plant diseases in Canada. , Quebec City, Que., Canada. 288 pp.

Alex, J. F., Cayouette, R., Mulligan, G. A. 1980. Common and botanical names of weeds in Canada/Noms populaire et scientifiques des plantes nuisibles du Canada. Revised. Agric. Can. Publ., Ottawa, Ont., Canada. 132 pp.

Bailey, L. H., Bailey, E. Z. 1976. Hortus third. Revised. MacMillan, New York, N.Y., USA. 1290 pp.

Scoggan, H. J. 1978, 1979. The flora of Canada. Nat. Mus. Nat. Sci. (Ottawa) Publ. Bot. 7(1)-7(4). 1711 pp.

Van Wijk, H. L. 1911. A dictionary of plant names. Martinus Nijhoff, The Hague, The Netherlands. 1444 pp.

Victorin, M. 1964. Flore Laurentienne. 2nd ed. Univ. Montreal, Montreal, Que., Canada. 952 pp.

Geographic Information

British Columbia

References:

Bailey, L. H., Bailey, E. Z. 1976. Hortus third. Revised. MacMillan, New York, N.Y., USA. 1290 pp.

Boivin, B. 1966, 1967. Énumération des plantes du Canada. Provencheria 6. Nat. Can. (Que.) 93: 253-274; 371-437; 583-646; 989-1063. 94: 131-157; 471-528; 625-655.

Image or illustration

Delphinium menziesii:

Images: images.google.com

Toxic parts:

all parts

leaves

seeds

References:

Cheeke, P. R., Shull, L. R. 1985. Natural toxicants in feeds and poisonous plants. AVI Publishing Company, Inc., Westport, Conn., USA. 492 pp.

Notes on Toxic plant chemicals:

See additional information under general notes of [Delphinium glaucum](#).

Toxic plant chemicals:

methyllycaconitine

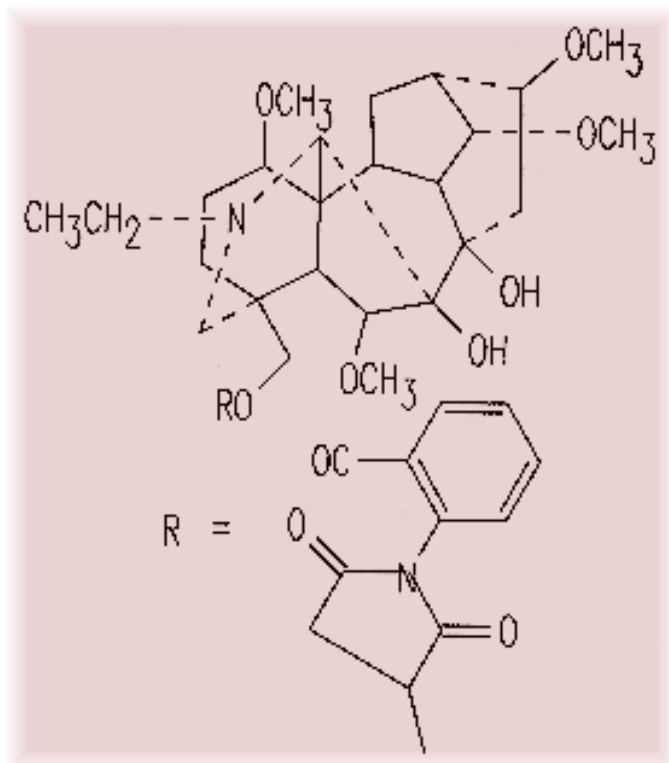

Chemical diagram(s) are courtesy of [Ruth McDiarmid](#), Biochemistry Technician, Kamloops Range Station, Agriculture and Agri-Food Canada, Kamloops, British Columbia, Canada.

References:

Cheeke, P. R., Shull, L. R. 1985. Natural toxicants in feeds and poisonous plants. AVI Publishing Company, Inc., Westport, Conn., USA. 492 pp.

Animals/Human Poisoning:

Note: When an animal is listed without additional information, the literature (as of 1993) contained no detailed explanation.

Cattle

General symptoms of poisoning:

[ataxia](#)

[bloat](#)

[constipation](#)

[death by asphyxiation](#)

References:

Cheeke, P. R., Shull, L. R. 1985. Natural toxicants in feeds and poisonous plants. AVI Publishing Company, Inc., Westport, Conn., USA. 492 pp.

Horses

Sheep

[Another search?](#)

[Français](#) | [Contact Us](#) | [Help](#) | [Search](#) | [Canada site](#)

[Coming Events](#) | [About CBIF](#) | [Links](#) | [Reports and Publications](#) | [Home](#)

Date modified: 2003-02-06

[Important Notices](#)



Français	Contact us	Help	Search	Canada site
Coming events	About CBIF	Links	Reports and publications	Home

Canadian Biodiversity Information Facility



Notes on poisoning: *Descurainia pinnata*

[Introduction](#)[Interactive](#)[All poisonous plants by Botanical name](#)[All poisonous plants by Common name](#)[Important WWW Poisonous Plants sites](#)

General poisoning notes:

Green tansy mustard (*Descurainia pinnata*) is a native herb found in fields and rangelands across central and western Canada.

Poisoning has occurred in cases where animals have fed almost exclusively on the plants over long periods. Cattle, goats, and horses have been poisoned (Kingsbury 1964, Staley 1976).



References:

Kingsbury, J. M. 1964. Poisonous plants of the United States and Canada. Prentice-Hall Inc., Englewood Cliffs, N.J., USA. 626 pp.

Staley, E. S. 1976. A treatment for tansy mustard poisoning. Bovine Pract., 11: 35.

Nomenclature:

Scientific Name: *Descurainia pinnata* (Walt.) Britt.

Vernacular name(s): green tansy mustard

Scientific family name: *Cruciferae*

Vernacular family name: mustard

Go to ITIS^{*ca} for more taxonomic information on: [Descurainia pinnata](#)

References:

Agriculture Quebec. 1975. Noms des maladies des plantes du Canada/ Names of plant diseases in Canada. , Quebec City, Que., Canada. 288 pp.

Alex, J. F., Cayouette, R., Mulligan, G. A. 1980. Common and botanical names of weeds in Canada/Noms populaire et

scientifiques des plantes nuisibles du Canada. Revised. Agric. Can. Publ., Ottawa, Ont., Canada. 132 pp.

Bailey, L. H., Bailey, E. Z. 1976. Hortus third. Revised. MacMillan, New York, N.Y., USA. 1290 pp.

Scoggan, H. J. 1978, 1979. The flora of Canada. Nat. Mus. Nat. Sci. (Ottawa) Publ. Bot. 7(1)-7(4). 1711 pp.

Van Wijk, H. L. 1911. A dictionary of plant names. Martinus Nijhoff, The Hague, The Netherlands. 1444 pp.

Victorin, M. 1964. Flore Laurentienne. 2nd ed. Univ. Montreal, Montreal, Que., Canada. 952 pp.

Geographic Information

Alberta
British Columbia
Manitoba
Northwest Territories
Ontario
Quebec
Saskatchewan

References:

Bailey, L. H., Bailey, E. Z. 1976. Hortus third. Revised. MacMillan, New York, N.Y., USA. 1290 pp.

Boivin, B. 1966, 1967. Énumération des plantes du Canada. Provencheria 6. Nat. Can. (Que.) 93: 253-274; 371-437; 583-646; 989-1063. 94: 131-157; 471-528; 625-655.

Image or illustration

Descurainia pinnata:

Images: images.google.com

Toxic parts:

leaves
seeds

References:

Staley, E. S. 1976. A treatment for tansy mustard poisoning. Bovine Pract., 11: 35.

Toxic plant chemicals:

unknown chemical

References:

Staley, E. S. 1976. A treatment for tansy mustard poisoning. Bovine Pract., 11: 35.

Animals/Human Poisoning:

Note: When an animal is listed without additional information, the literature (as of 1993) contained no detailed explanation.

Cattle

General symptoms of poisoning:

[blindness](#)

[death](#)

[weight loss](#)

Notes on poisoning:

Symptoms in cattle start with partial or complete blindness, followed by an inability to use the tongue or throat, leading to an inability to eat. Death occurs if treatment is not applied to recover the ability to eat and see. Treatment has included administering 9-14 L of water twice daily to improve digestion. More recent treatment involves intravenous injections of ethanol diluted in Ringers solution (Staley 1976).

References:

Kingsbury, J. M. 1964. Poisonous plants of the United States and Canada. Prentice-Hall Inc., Englewood Cliffs, N.J., USA. 626 pp.

Staley, E. S. 1976. A treatment for tansy mustard poisoning. Bovine Pract., 11: 35.

Goats

Horses

[Another search?](#)

[Français](#) | [Contact Us](#) | [Help](#) | [Search](#) | [Canada site](#)

[Coming Events](#) | [About CBIF](#) | [Links](#) | [Reports and Publications](#) | [Home](#)

Date modified: 2003-02-06

[Important Notices](#)



Français	Contact us	Help	Search	Canada site
Coming events	About CBIF	Links	Reports and publications	Home

Canadian Biodiversity Information Facility



Notes on poisoning: *Dicentra canadensis*

[Introduction](#)[Interactive](#)[All poisonous plants by Botanical name](#)[All poisonous plants by Common name](#)[Important WWW Poisonous Plants sites](#)

General poisoning notes:

Squirrel-corn (*Dicentra canadensis*) is a native herb found in rich woodlands in southern Ontario and Quebec. The plant contains alkaloids that are known to be toxic. However, feeding experiments on cattle using the aboveground parts, as well as the entire plant failed, to produce any symptoms other than slight restlessness and uneasiness (Black et al. 1923). See additional notes under general notes of [Dicentra cucullaria](#).

References:

Black, O. F., Eggleston, W. W., Kelly, J. W., Turner, H. C. 1923. Poisonous properties of *Bikukulla cucullaria* (Dutchman's-breeches) and *B. canadensis* (squirrel-corn). J. Agric. Res., 23: 69-78.

Nomenclature:

Scientific Name: *Dicentra canadensis* (Goldie) Walp.

Vernacular name(s): squirrel-corn

Scientific family name: *Fumariaceae*

Vernacular family name: frumitory

Go to ITIS*^{ca} for more taxonomic information on: [Dicentra canadensis](#)

References:

Agriculture Quebec. 1975. Noms des maladies des plantes du Canada/ Names of plant diseases in Canada. , Quebec City, Que., Canada. 288 pp.

Alex, J. F., Cayouette, R., Mulligan, G. A. 1980. Common and

botanical names of weeds in Canada/Noms populaire et scientifiques des plantes nuisibles du Canada. Revised. Agric. Can. Publ., Ottawa, Ont., Canada. 132 pp.

Bailey, L. H., Bailey, E. Z. 1976. Hortus third. Revised. MacMillan, New York, N.Y., USA. 1290 pp.

Scoggan, H. J. 1978, 1979. The flora of Canada. Nat. Mus. Nat. Sci. (Ottawa) Publ. Bot. 7(1)-7(4). 1711 pp.

Van Wijk, H. L. 1911. A dictionary of plant names. Martinus Nijhoff, The Hague, The Netherlands. 1444 pp.

Victorin, M. 1964. Flore Laurentienne. 2nd ed. Univ. Montreal, Montreal, Que., Canada. 952 pp.

Geographic Information

Ontario

Quebec

References:

Bailey, L. H., Bailey, E. Z. 1976. Hortus third. Revised. MacMillan, New York, N.Y., USA. 1290 pp.

Boivin, B. 1966, 1967. Énumération des plantes du Canada. Provencheria 6. Nat. Can. (Que.) 93: 253-274; 371-437; 583-646; 989-1063. 94: 131-157; 471-528; 625-655.

Image or illustration

Dicentra canadensis:

Images: images.google.com

Notes on Poisonous plant parts:

See additional information under general notes of [Dicentra cucullaria](#).

Toxic parts:

leaves

tubers

References:

Black, O. F., Eggleston, W. W., Kelly, J. W., Turner, H. C. 1923. Poisonous properties of *Bikukulla cucullaria* (Dutchman's-breeches) and *B. canadensis* (squirrel-corn). J.

Agric. Res., 23: 69-78.

Notes on Toxic plant chemicals:

Aporphine and protopine, which are isoquinoline alkaloids, have been found in *Dicentra* species. Several other alkaloids have also been found in the plants (Black et al. 1923).

Toxic plant chemicals:

aporphine

protopine

References:

Black, O. F., Eggleston, W. W., Kelly, J. W., Turner, H. C. 1923. Poisonous properties of *Bikukulla cucullaria* (Dutchman's-breeches) and *B. canadensis* (squirrel-corn). J. Agric. Res., 23: 69-78.

Animals/Human Poisoning:

Note: When an animal is listed without additional information, the literature (as of 1993) contained no detailed explanation.

Cattle

General symptoms of poisoning:

[restlessness](#)

References:

Black, O. F., Eggleston, W. W., Kelly, J. W., Turner, H. C. 1923. Poisonous properties of *Bikukulla cucullaria* (Dutchman's-breeches) and *B. canadensis* (squirrel-corn). J. Agric. Res., 23: 69-78.

[Another search?](#)

[Français](#) | [Contact Us](#) | [Help](#) | [Search](#) | [Canada site](#)

[Coming Events](#) | [About CBIF](#) | [Links](#) | [Reports and Publications](#) | [Home](#)

Date modified: 2003-02-06

[Important Notices](#)



Français	Contact us	Help	Search	Canada site
Coming events	About CBIF	Links	Reports and publications	Home

Canadian Biodiversity Information Facility



Notes on poisoning: *Dicentra cucullaria*

[Introduction](#)[Interactive](#)[All poisonous plants by Botanical name](#)[All poisonous plants by Common name](#)[Important WWW Poisonous Plants sites](#)

General poisoning notes:

Dutchman's-breeches (*Dicentra cucullaria*) is a native herb found in the rich woodlands of eastern Canada. The plant has been shown to cause poisoning when fed to cattle under experimental conditions. The underground tubers caused more severe symptoms. When plant tubers were fed at 2 kg/100 kg of animal weight, various symptoms occurred, including trembling and convulsions (Black et al. 1923). Poisoning may occur during the spring, when the ground is soft and the tubers might be dug up.

References:

Black, O. F., Eggleston, W. W., Kelly, J. W., Turner, H. C. 1923. Poisonous properties of *Bikukulla cucullaria* (Dutchman's-breeches) and *B. canadensis* (squirrel-corn). J. Agric. Res., 23: 69-78.

Nomenclature:

Scientific Name: *Dicentra cucullaria* (L.) Bernh.

Vernacular name(s): Dutchman's-breeches

Scientific family name: *Fumariaceae*

Vernacular family name: frumitory

Go to ITIS*^{ca} for more taxonomic information on: [Dicentra cucullaria](#)

References:

Agriculture Quebec. 1975. Noms des maladies des plantes du Canada/ Names of plant diseases in Canada. , Quebec City, Que.,

Canada. 288 pp.

Alex, J. F., Cayouette, R., Mulligan, G. A. 1980. Common and botanical names of weeds in Canada/Noms populaire et scientifiques des plantes nuisibles du Canada. Revised. Agric. Can. Publ., Ottawa, Ont., Canada. 132 pp.

Bailey, L. H., Bailey, E. Z. 1976. Hortus third. Revised. MacMillan, New York, N.Y., USA. 1290 pp.

Scoggan, H. J. 1978, 1979. The flora of Canada. Nat. Mus. Nat. Sci. (Ottawa) Publ. Bot. 7(1)-7(4). 1711 pp.

Van Wijk, H. L. 1911. A dictionary of plant names. Martinus Nijhoff, The Hague, The Netherlands. 1444 pp.

Victorin, M. 1964. Flore Laurentienne. 2nd ed. Univ. Montreal, Montreal, Que., Canada. 952 pp.

Geographic Information

New Brunswick
Nova Scotia
Ontario
Prince Edward Island
Quebec

References:

Bailey, L. H., Bailey, E. Z. 1976. Hortus third. Revised. MacMillan, New York, N.Y., USA. 1290 pp.

Boivin, B. 1966, 1967. Énumération des plantes du Canada. Provencheria 6. Nat. Can. (Que.) 93: 253-274; 371-437; 583-646; 989-1063. 94: 131-157; 471-528; 625-655.

Image or illustration

Dicentra cucullaria:

Images: images.google.com

Notes on Poisonous plant parts:

When the plant was fed to cattle during experiments the underground tubers caused more symptoms than the aboveground portion of the plant (Black et al. 1923).

Toxic parts:

leaves

tubers

References:

Black, O. F., Eggleston, W. W., Kelly, J. W., Turner, H. C. 1923. Poisonous properties of *Bikukulla cucullaria* (Dutchman's-breeches) and *B. canadensis* (squirrel-corn). J. Agric. Res., 23: 69-78.

Notes on Toxic plant chemicals:

Several isoquinoline alkaloids have been found in *Dicentra* species, including aporphine and protopine. The degree of toxicity of the various alkaloids is not known (Black et al. 1923). Protopine is also found in the opium poppy (*Papaver somniferum*).

Toxic plant chemicals:

aporphine
protopine

References:

Black, O. F., Eggleston, W. W., Kelly, J. W., Turner, H. C. 1923. Poisonous properties of *Bikukulla cucullaria* (Dutchman's-breeches) and *B. canadensis* (squirrel-corn). J. Agric. Res., 23: 69-78.

Animals/Human Poisoning:

Note: When an animal is listed without additional information, the literature (as of 1993) contained no detailed explanation.

Cattle

General symptoms of poisoning:

[breathing, labored](#)

[convulsions](#)

[mouth, frothing of](#)

[nervousness](#)

[opisthotonos](#)

[trembling](#)

Notes on poisoning:

Experimental feeding of cattle caused the animals to become nervous, run back and forth, violently eject stomach contents,

tremble, convulse, and fall down with the legs extended and rigid. The cattle were able to rise again and recover after a while (Black et al. 1923).

References:

Black, O. F., Eggleston, W. W., Kelly, J. W., Turner, H. C. 1923. Poisonous properties of *Bikukulla cucullaria* (Dutchman's-breeches) and *B. canadensis* (squirrel-corn). J. Agric. Res., 23: 69-78.

[Another search?](#)

[Français](#) | [Contact Us](#) | [Help](#) | [Search](#) | [Canada site](#)

[Coming Events](#) | [About CBIF](#) | [Links](#) | [Reports and Publications](#) |

[Home](#)

Date modified: 2003-02-06

[Important Notices](#)



Français	Contact us	Help	Search	Canada site
Coming events	About CBIF	Links	Reports and publications	Home

Canadian Biodiversity Information Facility



Notes on poisoning: *Dicentra formosa*

[Introduction](#)[Interactive](#)[All poisonous plants by Botanical name](#)[All poisonous plants by Common name](#)[Important WWW Poisonous Plants sites](#)

General poisoning notes:

Western bleedingheart (*Dicentra formosa*) is a native herb found in the rich forests of southwestern British Columbia. The plant contains the toxic alkaloid protopine and other alkaloids. This chemical is also found in the other *Dicentra* species. Experimental injection of plant extracts has caused poisoning and death in mice (Black et al. 1930).



References:

Black, O. F., Eggleston, W. W., Kelly, J. W. 1930. Toxicity of *Bikukulla formosa* (western bleedingheart). Vet. J., 40: 917-920.

Nomenclature:

Scientific Name: *Dicentra formosa* (Andr.) Walp.

Vernacular name(s): western bleedingheart

Scientific family name: *Fumariaceae*

Vernacular family name: frumitory

Go to ITIS^{*ca} for more taxonomic information on: [Dicentra formosa](#)

References:

Agriculture Quebec. 1975. Noms des maladies des plantes du Canada/ Names of plant diseases in Canada. , Quebec City, Que., Canada. 288 pp.

Alex, J. F., Cayouette, R., Mulligan, G. A. 1980. Common and botanical names of weeds in Canada/Noms populaire et scientifiques des plantes nuisibles du Canada. Revised. Agric. Can. Publ., Ottawa, Ont., Canada. 132 pp.

Bailey, L. H., Bailey, E. Z. 1976. Hortus third. Revised. MacMillan, New York, N.Y., USA. 1290 pp.

Scoggan, H. J. 1978, 1979. The flora of Canada. Nat. Mus. Nat. Sci. (Ottawa) Publ. Bot. 7(1)-7(4). 1711 pp.

Van Wijk, H. L. 1911. A dictionary of plant names. Martinus Nijhoff, The Hague, The Netherlands. 1444 pp.

Victorin, M. 1964. Flore Laurentienne. 2nd ed. Univ. Montreal, Montreal, Que., Canada. 952 pp.

Geographic Information

British Columbia

References:

Bailey, L. H., Bailey, E. Z. 1976. Hortus third. Revised. MacMillan, New York, N.Y., USA. 1290 pp.

Boivin, B. 1966, 1967. Énumération des plantes du Canada. Provencheria 6. Nat. Can. (Que.) 93: 253-274; 371-437; 583-646; 989-1063. 94: 131-157; 471-528; 625-655.

Image or illustration

Dicentra formosa:

Images: images.google.com

Toxic parts:

leaves

References:

Black, O. F., Eggleston, W. W., Kelly, J. W. 1930. Toxicity of *Bikukulla formosa* (western bleedingheart). Vet. J., 40: 917-920.

Toxic plant chemicals:

protopine

References:

Black, O. F., Eggleston, W. W., Kelly, J. W. 1930. Toxicity of *Bikukulla formosa* (western bleedingheart). Vet. J., 40: 917-920.

Animals/Human Poisoning:

Note: When an animal is listed without additional information, the literature (as of 1993) contained no detailed explanation.

Cattle

Rodents

General symptoms of poisoning:

[convulsions](#)

[death](#)

[drowsiness](#)

Notes on poisoning:

Postmortem examination of mice showed collapsed lungs, blue extremities, and a distended heart. Death was likely due to respiratory paralysis. The lethal dose from the crude alkaloids was determined to be between 2.5 and 5.0 mg for a 20-g mouse (Black et al. 1930).

References:

Black, O. F., Eggleston, W. W., Kelly, J. W. 1930. Toxicity of *Bikukulla formosa* (western bleedingheart). Vet. J., 40: 917-920.

[Another search?](#)

[Français](#) | [Contact Us](#) | [Help](#) | [Search](#) | [Canada site](#)

[Coming Events](#) | [About CBIF](#) | [Links](#) | [Reports and Publications](#) |

[Home](#)

Date modified: 2003-02-06

[Important Notices](#)



Français	Contact us	Help	Search	Canada site
Coming events	About CBIF	Links	Reports and publications	Home

Canadian Biodiversity Information Facility



Notes on poisoning: *Dictamnus albus*

[Introduction](#)[Interactive](#)[All poisonous plants by Botanical name](#)[All poisonous plants by Common name](#)[Important WWW Poisonous Plants sites](#)

General poisoning notes:

Gas plant (*Dictamnus albus*) has caused phytophotodermatitis in humans. In one case in Ottawa, a gardener suffered recurring skin eruptions for several summers. The original diagnosis was poison-ivy, but subsequent testing proved that the gas plant was causing the skin reactions. The plant juices are absorbed by the skin and, in the presence of long-wave ultraviolet light, cell damage occurs. Once this cause is recognized, careful avoidance of contact with the gas plant prevents further problems (Henderson and DesGroseilliers 1984). This is an uncommon and colorful plant found in Canadian herbaceous borders.

References:

Henderson, J. A., DesGroseilliers, J.-P. 1984. Gas plant (*Dictamnus albus*) phytophotodermatitis simulating poison ivy. Can. Med. Assoc. J., 130: 889-891.

Nomenclature:

Scientific Name: *Dictamnus albus* L.

Vernacular name(s): gas plant

Scientific family name: *Rutaceae*

Vernacular family name: rue

Go to ITIS^{*ca} for more taxonomic information on: [Dictamnus albus](#)

References:

Agriculture Quebec. 1975. Noms des maladies des plantes du Canada/ Names of plant diseases in Canada. , Quebec City, Que.,

Canada. 288 pp.

Alex, J. F., Cayouette, R., Mulligan, G. A. 1980. Common and botanical names of weeds in Canada/Noms populaire et scientifiques des plantes nuisibles du Canada. Revised. Agric. Can. Publ., Ottawa, Ont., Canada. 132 pp.

Bailey, L. H., Bailey, E. Z. 1976. Hortus third. Revised. MacMillan, New York, N.Y., USA. 1290 pp.

Scoggan, H. J. 1978, 1979. The flora of Canada. Nat. Mus. Nat. Sci. (Ottawa) Publ. Bot. 7(1)-7(4). 1711 pp.

Van Wijk, H. L. 1911. A dictionary of plant names. Martinus Nijhoff, The Hague, The Netherlands. 1444 pp.

Victorin, M. 1964. Flore Laurentienne. 2nd ed. Univ. Montreal, Montreal, Que., Canada. 952 pp.

Geographic Information

Plant or plant parts used in or around the home.

References:

Bailey, L. H., Bailey, E. Z. 1976. Hortus third. Revised. MacMillan, New York, N.Y., USA. 1290 pp.

Boivin, B. 1966, 1967. Énumération des plantes du Canada. Provencheria 6. Nat. Can. (Que.) 93: 253-274; 371-437; 583-646; 989-1063. 94: 131-157; 471-528; 625-655.

Image or illustration

Dictamnus albus:

Images: images.google.com

Notes on Poisonous plant parts:

Exposure to the plant juices is required, which occurs when weeding around the plant or cutting the flowers (Henderson and DesGroseilliers 1984).

Toxic parts:

plant juices

References:

Cheeke, P. R., Shull, L. R. 1985. Natural toxicants in feeds and

poisonous plants. AVI Publishing Company, Inc., Westport, Conn., USA. 492 pp.

Henderson, J. A., DesGroseilliers, J.-P. 1984. Gas plant (*Dictamnus albus*) phytophotodermatitis simulating poison ivy. Can. Med. Assoc. J., 130: 889-891.

Notes on Toxic plant chemicals:

Furocoumarins, which are derived from psoralen, are found in several of the plants that cause phytophotodermatitis. These compounds are primary photodynamic agents that absorb long-wave ultraviolet light at the surface of the skin and then cause cell damage (Henderson and DesGroseilliers 1984, Cheeke and Schull 1985).

Toxic plant chemicals:

furocoumarin

References:

Cheeke, P. R., Shull, L. R. 1985. Natural toxicants in feeds and poisonous plants. AVI Publishing Company, Inc., Westport, Conn., USA. 492 pp.

Henderson, J. A., DesGroseilliers, J.-P. 1984. Gas plant (*Dictamnus albus*) phytophotodermatitis simulating poison ivy. Can. Med. Assoc. J., 130: 889-891.

Animals/Human Poisoning:

Note: When an animal is listed without additional information, the literature (as of 1993) contained no detailed explanation.

Humans

General symptoms of poisoning:

[blistering](#)

[erythema](#)

References:

Henderson, J. A., DesGroseilliers, J.-P. 1984. Gas plant (*Dictamnus albus*) phytophotodermatitis simulating poison ivy. Can. Med. Assoc. J., 130: 889-891.

[Another search?](#)

[Français](#) | [Contact Us](#) | [Help](#) | [Search](#) | [Canada site](#)
[Coming Events](#) | [About CBIF](#) | [Links](#) | [Reports and Publications](#) |
[Home](#)

Date modified: 2003-02-06

[Important Notices](#)



Français	Contact us	Help	Search	Canada site
Coming events	About CBIF	Links	Reports and publications	Home

Canadian Biodiversity Information Facility



Notes on poisoning: *Dieffenbachia amoena*

[Introduction](#)

[Interactive](#)

[All poisonous plants by Botanical name](#)

[All poisonous plants by Common name](#)

[Important WWW Poisonous Plants sites](#)

General poisoning notes:

Giant dumbcane (*Dieffenbachia amoena*) is an indoor ornamental plant. Experimental work on rodents proved the toxicity of leaf and stem tissue from giant dumbcane. Death occurred after administration of 3.0 g of plant extract in 10.0 mL of liquid per 100 g of body weight (Der Marderosian et al. 1976).



References:

Der Marderosian, A. H., Giller, F. B., Roia, F. C. 1976. Phytochemical and toxicological screening of household ornamental plants potentially toxic to humans. 1. J. Toxicol. Environ. Health, 1: 939-953.

Nomenclature:

Scientific Name: *Dieffenbachia amoena* Gentil

Vernacular name(s): giant dumbcane

Scientific family name: *Araceae*

Vernacular family name: arum

References:

Agriculture Quebec. 1975. Noms des maladies des plantes du Canada/ Names of plant diseases in Canada. , Quebec City, Que., Canada. 288 pp.

Alex, J. F., Cayouette, R., Mulligan, G. A. 1980. Common and botanical names of weeds in Canada/Noms populaire et scientifiques des plantes nuisibles du Canada. Revised. Agric. Can. Publ., Ottawa, Ont., Canada. 132 pp.

Bailey, L. H., Bailey, E. Z. 1976. Hortus third. Revised.

MacMillan, New York, N.Y., USA. 1290 pp.

Scoggan, H. J. 1978, 1979. The flora of Canada. Nat. Mus. Nat. Sci. (Ottawa) Publ. Bot. 7(1)-7(4). 1711 pp.

Van Wijk, H. L. 1911. A dictionary of plant names. Martinus Nijhoff, The Hague, The Netherlands. 1444 pp.

Victorin, M. 1964. Flore Laurentienne. 2nd ed. Univ. Montreal, Montreal, Que., Canada. 952 pp.

Geographic Information

Plant or plant parts used in or around the home.

References:

Bailey, L. H., Bailey, E. Z. 1976. Hortus third. Revised. MacMillan, New York, N.Y., USA. 1290 pp.

Boivin, B. 1966, 1967. Énumération des plantes du Canada. Provencheria 6. Nat. Can. (Que.) 93: 253-274; 371-437; 583-646; 989-1063. 94: 131-157; 471-528; 625-655.

Image or illustration

Dieffenbachia amoena:

Images: images.google.com

Toxic parts:

leaves

stems

References:

Der Marderosian, A. H., Giller, F. B., Roia, F. C. 1976. Phytochemical and toxicological screening of household ornamental plants potentially toxic to humans. 1. J. Toxicol. Environ. Health, 1: 939-953.

Toxic plant chemicals:

oxalate

References:

Der Marderosian, A. H., Giller, F. B., Roia, F. C. 1976. Phytochemical and toxicological screening of household

ornamental plants potentially toxic to humans. 1. J. Toxicol. Environ. Health, 1: 939-953.

Animals/Human Poisoning:

Note: When an animal is listed without additional information, the literature (as of 1993) contained no detailed explanation.

Rodents

[Another search?](#)

[Français](#) | [Contact Us](#) | [Help](#) | [Search](#) | [Canada site](#)

[Coming Events](#) | [About CBIF](#) | [Links](#) | [Reports and Publications](#) | [Home](#)

Date modified: 2003-02-06

[Important Notices](#)



Français	Contact us	Help	Search	Canada site
Coming events	About CBIF	Links	Reports and publications	Home

Canadian Biodiversity Information Facility



Notes on poisoning: *Dieffenbachia bausei*

[Introduction](#)[Interactive](#)[All poisonous plants by Botanical name](#)[All poisonous plants by Common name](#)[Important WWW Poisonous Plants sites](#)

General poisoning notes:

Dumbcane (*Dieffenbachia bausei*) is an ornamental houseplant. Experimental work caused death in mice when leaf tissue extract was fed orally at the rate of 100 mg of lyophilized plant material (in distilled water) per 35 g of body weight (Der Marderosian et al. 1976).



References:

Der Marderosian, A. H., Giller, F. B., Roia, F. C. 1976. Phytochemical and toxicological screening of household ornamental plants potentially toxic to humans. 1. J. Toxicol. Environ. Health, 1: 939-953.

Nomenclature:

Scientific Name: *Dieffenbachia bausei* Regel

Vernacular name(s): dumbcane

Scientific family name: *Araceae*

Vernacular family name: arum

References:

Agriculture Quebec. 1975. Noms des maladies des plantes du Canada/ Names of plant diseases in Canada. , Quebec City, Que., Canada. 288 pp.

Alex, J. F., Cayouette, R., Mulligan, G. A. 1980. Common and botanical names of weeds in Canada/Noms populaire et scientifiques des plantes nuisibles du Canada. Revised. Agric. Can. Publ., Ottawa, Ont., Canada. 132 pp.

Bailey, L. H., Bailey, E. Z. 1976. Hortus third. Revised.

MacMillan, New York, N.Y., USA. 1290 pp.

Scoggan, H. J. 1978, 1979. The flora of Canada. Nat. Mus. Nat. Sci. (Ottawa) Publ. Bot. 7(1)-7(4). 1711 pp.

Van Wijk, H. L. 1911. A dictionary of plant names. Martinus Nijhoff, The Hague, The Netherlands. 1444 pp.

Victorin, M. 1964. Flore Laurentienne. 2nd ed. Univ. Montreal, Montreal, Que., Canada. 952 pp.

Geographic Information

Plant or plant parts used in or around the home.

References:

Bailey, L. H., Bailey, E. Z. 1976. Hortus third. Revised. MacMillan, New York, N.Y., USA. 1290 pp.

Boivin, B. 1966, 1967. Énumération des plantes du Canada. Provencheria 6. Nat. Can. (Que.) 93: 253-274; 371-437; 583-646; 989-1063. 94: 131-157; 471-528; 625-655.

Image or illustration

Dieffenbachia bausei:

Images: images.google.com

Toxic parts:

leaves

References:

Der Marderosian, A. H., Giller, F. B., Roia, F. C. 1976. Phytochemical and toxicological screening of household ornamental plants potentially toxic to humans. 1. J. Toxicol. Environ. Health, 1: 939-953.

Notes on Toxic plant chemicals:

See notes under [Dieffenbachia seguine](#) for additional information on toxic chemicals in *Dieffenbachia* spp.

Toxic plant chemicals:

oxalate

References:

Der Marderosian, A. H., Giller, F. B., Roia, F. C. 1976. Phytochemical and toxicological screening of household ornamental plants potentially toxic to humans. 1. J. Toxicol. Environ. Health, 1: 939-953.

Animals/Human Poisoning:

Note: When an animal is listed without additional information, the literature (as of 1993) contained no detailed explanation.

Rodents

[Another search?](#)

[Français](#) | [Contact Us](#) | [Help](#) | [Search](#) | [Canada site](#)

[Coming Events](#) | [About CBIF](#) | [Links](#) | [Reports and Publications](#) | [Home](#)

Date modified: 2003-02-06

[Important Notices](#)



Français	Contact us	Help	Search	Canada site
Coming events	About CBIF	Links	Reports and publications	Home

Canadian Biodiversity Information Facility



Notes on poisoning: *Dieffenbachia maculata*

[Introduction](#)[Interactive](#)[All poisonous plants by Botanical name](#)[All poisonous plants by Common name](#)[Important WWW Poisonous Plants sites](#)

General poisoning notes:

Spotted dumbcane (*Dieffenbachia maculata*) is an indoor ornamental. Experimental work with leaf and stem material caused death in mice and rats (Der Marderosian et al. 1976). Toxic symptoms have also occurred in humans and house pets. Chewing produces painful irritation of the mouth and throat. Symptoms may take several days to disappear. The insoluble oxalates do not cause systemic poisoning in humans (Lampe and McCann 1985).

References:

Der Marderosian, A. H., Giller, F. B., Roia, F. C. 1976. Phytochemical and toxicological screening of household ornamental plants potentially toxic to humans. 1. J. Toxicol. Environ. Health, 1: 939-953.

Nomenclature:

Scientific Name: *Dieffenbachia maculata* (Lodd.) G. Don

Vernacular name(s): spotted dumbcane

Scientific family name: *Araceae*

Vernacular family name: arum

Go to ITIS*^{ca} for more taxonomic information on: [Dieffenbachia maculata](#)

References:

Agriculture Quebec. 1975. Noms des maladies des plantes du Canada/ Names of plant diseases in Canada. , Quebec City, Que., Canada. 288 pp.

Alex, J. F., Cayouette, R., Mulligan, G. A. 1980. Common and botanical names of weeds in Canada/Noms populaire et scientifiques des plantes nuisibles du Canada. Revised. Agric. Can. Publ., Ottawa, Ont., Canada. 132 pp.

Bailey, L. H., Bailey, E. Z. 1976. Hortus third. Revised. MacMillan, New York, N.Y., USA. 1290 pp.

Scoggan, H. J. 1978, 1979. The flora of Canada. Nat. Mus. Nat. Sci. (Ottawa) Publ. Bot. 7(1)-7(4). 1711 pp.

Van Wijk, H. L. 1911. A dictionary of plant names. Martinus Nijhoff, The Hague, The Netherlands. 1444 pp.

Victorin, M. 1964. Flore Laurentienne. 2nd ed. Univ. Montreal, Montreal, Que., Canada. 952 pp.

Geographic Information

Plant or plant parts used in or around the home.

References:

Bailey, L. H., Bailey, E. Z. 1976. Hortus third. Revised. MacMillan, New York, N.Y., USA. 1290 pp.

Boivin, B. 1966, 1967. Énumération des plantes du Canada. Provencheria 6. Nat. Can. (Que.) 93: 253-274; 371-437; 583-646; 989-1063. 94: 131-157; 471-528; 625-655.

Image or illustration

Dieffenbachia maculata:

Images: images.google.com

Toxic parts:

leaves
stems

References:

Der Marderosian, A. H., Giller, F. B., Roia, F. C. 1976. Phytochemical and toxicological screening of household ornamental plants potentially toxic to humans. 1. J. Toxicol. Environ. Health, 1: 939-953.

Notes on Toxic plant chemicals:

See notes under [Dieffenbachia seguine](#) for additional information

on toxic chemicals in *Dieffenbachia* spp.

Toxic plant chemicals:

oxalate

References:

Der Marderosian, A. H., Giller, F. B., Roia, F. C. 1976. Phytochemical and toxicological screening of household ornamental plants potentially toxic to humans. 1. J. Toxicol. Environ. Health, 1: 939-953.

Animals/Human Poisoning:

Note: When an animal is listed without additional information, the literature (as of 1993) contained no detailed explanation.

Humans

General symptoms of poisoning:

[mouth, irritation of](#)

Notes on poisoning:

See additional notes under [Dieffenbachia seguine](#).

References:

Der Marderosian, A. H., Giller, F. B., Roia, F. C. 1976. Phytochemical and toxicological screening of household ornamental plants potentially toxic to humans. 1. J. Toxicol. Environ. Health, 1: 939-953.

Rodents

[Another search?](#)

[Français](#) | [Contact Us](#) | [Help](#) | [Search](#) | [Canada site](#)

[Coming Events](#) | [About CBIF](#) | [Links](#) | [Reports and Publications](#) |

[Home](#)

Date modified: 2003-02-06

[Important Notices](#)



Français	Contact us	Help	Search	Canada site
Coming events	About CBIF	Links	Reports and publications	Home

Canadian Biodiversity Information Facility



Notes on poisoning: *Dieffenbachia seguine*

[Introduction](#)[Interactive](#)[All poisonous plants by Botanical name](#)[All poisonous plants by Common name](#)[Important WWW Poisonous Plants sites](#)

General poisoning notes:

Mother-in-law plant (*Dieffenbachia seguine*) is an ornamental. Chewing dumbcanes (*Dieffenbachia* spp.) leaves or stems causes immediate pain and swelling in the mouth and throat. In severe cases, speech may become unintelligible, hence the name dumbcane. In the past these plants were used as a means of human torture. Family pets have also been poisoned after chewing on dumbcane plant material. The effects are almost instantaneous, before the plant material is actually ingested. The plant juices can also cause inflammation and contact dermatitis in some individuals (Arditti and Rodriguez 1982, Lampe and McCann 1985). Mrvos et al. (1990) determined that in many cases where people had contact with broken leaves of dumbcane plants, symptoms occurred within 5 min and were short and of minor consequence. The researchers concluded that concerns regarding oral complications may be exaggerated.

References:

Arditti, J., Rodriguez, E. 1982. *Dieffenbachia*: uses, abuses and toxic constituents: a review. *J. Ethnopharmacol.*, 5: 293-302.

Drach, G., Maloney, W. H. 1963. Toxicity of the common houseplant *Dieffenbachia*. *J. Am. Med. Assoc.*, 184: 1047-1048.

Hanna, G. 1986. Plant poisoning in canines and felines. *Vet. Hum. Toxicol.*, 28: 38-40.

Lampe, K. F., McCann, M. A. 1985. *AMA Handbook of poisonous and injurious plants*. American Medical Assoc. Chicago, Ill., USA. 432 pp.

Mrvos, R., Dean, B. S., Krenzelok, E. P. 1990. *Philodendron/Dieffenbachia* ingestions: are they a problem? *Vet. Hum. Toxicol.*, 32: 369.

Nomenclature:

Scientific Name: *Dieffenbachia seguine* (Jacq.) Schott

Vernacular name(s): mother-in-law plant

Scientific family name: *Araceae*

Vernacular family name: arum

Go to ITIS^{*ca} for more taxonomic information on: [Dieffenbachia seguine](#)

References:

Agriculture Quebec. 1975. Noms des maladies des plantes du Canada/ Names of plant diseases in Canada. , Quebec City, Que., Canada. 288 pp.

Alex, J. F., Cayouette, R., Mulligan, G. A. 1980. Common and botanical names of weeds in Canada/Noms populaire et scientifiques des plantes nuisibles du Canada. Revised. Agric. Can. Publ., Ottawa, Ont., Canada. 132 pp.

Bailey, L. H., Bailey, E. Z. 1976. Hortus third. Revised. MacMillan, New York, N.Y., USA. 1290 pp.

Scoggan, H. J. 1978, 1979. The flora of Canada. Nat. Mus. Nat. Sci. (Ottawa) Publ. Bot. 7(1)-7(4). 1711 pp.

Van Wijk, H. L. 1911. A dictionary of plant names. Martinus Nijhoff, The Hague, The Netherlands. 1444 pp.

Victorin, M. 1964. Flore Laurentienne. 2nd ed. Univ. Montreal, Montreal, Que., Canada. 952 pp.

Geographic Information

Plant or plant parts used in or around the home.

References:

Bailey, L. H., Bailey, E. Z. 1976. Hortus third. Revised. MacMillan, New York, N.Y., USA. 1290 pp.

Boivin, B. 1966, 1967. Énumération des plantes du Canada. Provencheria 6. Nat. Can. (Que.) 93: 253-274; 371-437; 583-646; 989-1063. 94: 131-157; 471-528; 625-655.

Image or illustration

Dieffenbachia seguine:

Images: images.google.com

Toxic parts:

leaves
stems

References:

Cheeke, P. R., Shull, L. R. 1985. Natural toxicants in feeds and poisonous plants. AVI Publishing Company, Inc., Westport, Conn., USA. 492 pp.

Walter, W. G., Khanna, P. N. 1972. Chemistry of the aroids 1. *Dieffenbachia seguine*, *amoena* and *picta*. Econ. Bot., 26: 364-372.

Notes on Toxic plant chemicals:

Dieffenbachia spp. contain calcium oxalate crystals, which are found in special cells called idioblasts; these cells have nozzle-like apertures at either end. The small needle-like crystals are small (0.2 mm long) and are forcibly extruded when the tissue is ruptured, as when chewed. This release of crystals from plant tissue can continue for several minutes. The initial sensation upon ingesting dumbcane tissue is one of pain (Dore 1963, Cheeke and Schull 1985). Proteolytic enzymes have also been found in dumbcanes and may account for some of the toxic effects (Walter and Khanna 1963, Arditti and Rodriguez 1982).

Toxic plant chemicals:

oxalate
proteolytic enzymes

References:

Arditti, J., Rodriguez, E. 1982. *Dieffenbachia*: uses, abuses and toxic constituents: a review. J. Ethnopharmacol., 5: 293-302.

Cheeke, P. R., Shull, L. R. 1985. Natural toxicants in feeds and poisonous plants. AVI Publishing Company, Inc., Westport, Conn., USA. 492 pp.

Walter, W. G., Khanna, P. N. 1972. Chemistry of the aroids 1. *Dieffenbachia seguine*, *amoena* and *picta*. Econ. Bot., 26: 364-372.

Animals/Human Poisoning:

Note: When an animal is listed without additional information, the literature (as of 1993) contained no detailed explanation.

Cats

General symptoms of poisoning:

[mouth, irritation of](#)
[salivation](#)

References:

Hanna, G. 1986. Plant poisoning in canines and felines. *Vet. Hum. Toxicol.*, 28: 38-40.

Dogs

Humans

General symptoms of poisoning:

[aphonia](#)
[breathing, labored](#)
[diarrhea](#)
[mouth, irritation of](#)
[salivation](#)
[vomiting](#)

Notes on poisoning:

Chewing dumbcane plants causes immediate intense pain and irritation of the lips, tongue, and mouth. There is edematous swelling of the oral mucosa. Bullae may form. Speech capability is often reduced or lost, a condition that can last for several days. The pain and irritation can also persist, and the edema can leave superficial necrosis. Excessive salivation is common. Treatment requires use of cool liquids; analgesics may be indicated (Arditti and Rodriguez 1982, Lampe and McCann 1985). Cut stem sections are particularly dangerous for nursery workers because of the possibility of getting plant juices into the eyes. Inflammation accompanied by intense pain, watering, and gross swelling can occur. Visual acuity may be reduced (Arditti and Rodriguez 1982).

References:

Arditti, J., Rodriguez, E. 1982. *Dieffenbachia*: uses, abuses and

toxic constituents: a review. *J. Ethnopharmacol.*, 5: 293-302.

Drach, G., Maloney, W. H. 1963. Toxicity of the common houseplant *Dieffenbachia*. *J. Am. Med. Assoc.*, 184: 1047-1048.

Lampe, K. F., McCann, M. A. 1985. *AMA Handbook of poisonous and injurious plants*. American Medical Assoc. Chicago, Ill., USA. 432 pp.

[Another search?](#)

[Français](#) | [Contact Us](#) | [Help](#) | [Search](#) | [Canada site](#)

[Coming Events](#) | [About CBIF](#) | [Links](#) | [Reports and Publications](#) |

[Home](#)

Date modified: 2003-02-06

[Important Notices](#)



Français	Contact us	Help	Search	Canada site
Coming events	About CBIF	Links	Reports and publications	Home

Canadian Biodiversity Information Facility



Notes on poisoning: *Digitalis purpurea*

[Introduction](#)[Interactive](#)[All poisonous plants by Botanical name](#)[All poisonous plants by Common name](#)[Important WWW Poisonous Plants sites](#)

General poisoning notes:

Foxglove (*Digitalis purpurea*) is an attractive biennial plant that is cultivated in Canada and is naturalized in several provinces. Upon ingestion, this plant can cause toxic reactions that lead to severe sickness and death in animals and in humans. Several important pharmaceutical drugs such as digitalis and digoxin are derived from this plant. The chemicals increase the force of contraction of the heart muscle and are therefore used in cases of heart congestion. Foxglove (*Digitalis purpurea*) is a naturalized herb found in eastern Canada and British Columbia. It is also a common outdoor ornamental. All classes of livestock are susceptible to poisoning by foxglove. However, because of the unpalatable nature of the plant, poisoning is infrequent, although when it does occur it is often severe and dramatic, frequently resulting in death. Human poisoning occurs rarely. However, poisoning was reported in the children who ate the flowers or drank water from vases. Accidentally including foxglove leaves in tea has led to poisoning and death. Cardiac glycosides are commonly described drugs that have a low margin of safety. Slight overdoses of prescribed medicine can cause symptoms of toxicity (Cooper and Johnson 1984, Cheeke and Schull 1985, Joubert 1989).

References:

- Cheeke, P. R., Shull, L. R. 1985. Natural toxicants in feeds and poisonous plants. AVI Publishing Company, Inc., Westport, Conn., USA. 492 pp.
- Cooper, M. R., Johnson, A. W. 1984. Poisonous plants in Britain and their effects on animals and man. Her Majesty's Stationery Office, London, England. 305 pp.
- Joubert, J. P. 1989. Cardiac glycosides. Pages 61-97 in Cheeke, P. R., ed. Toxicants of plant origin. Vol. II. Glycosides. CRC Press, Inc., Boca Raton, Fla., USA. 277 pp.
- Lampe, K. F., McCann, M. A. 1985. AMA Handbook of poisonous and

injurious plants. American Medical Assoc. Chicago, Ill., USA. 432 pp.

Parker, W. H. 1951. Foxglove (*Digitalis purpurea*) poisoning in turkeys. Vet. Rec., 63: 416.

Thomas, D. L., Quick, M. P., Morgan, R. P. 1987. Suspected foxglove (*Digitalis purpurea*) poisoning in a dairy cow. Vet. Rec., 120: 300-301.

Nomenclature:

Scientific Name: *Digitalis purpurea* L.

Vernacular name(s): foxglove

Scientific family name: *Scrophulariaceae*

Vernacular family name: frigwort

Go to ITIS*ca for more taxonomic information on: [Digitalis purpurea](#)

References:

Agriculture Quebec. 1975. Noms des maladies des plantes du Canada/ Names of plant diseases in Canada. , Quebec City, Que., Canada. 288 pp.

Alex, J. F., Cayouette, R., Mulligan, G. A. 1980. Common and botanical names of weeds in Canada/Noms populaire et scientifiques des plantes nuisibles du Canada. Revised. Agric. Can. Publ., Ottawa, Ont., Canada. 132 pp.

Bailey, L. H., Bailey, E. Z. 1976. Hortus third. Revised. MacMillan, New York, N.Y., USA. 1290 pp.

Scoggan, H. J. 1978, 1979. The flora of Canada. Nat. Mus. Nat. Sci. (Ottawa) Publ. Bot. 7(1)-7(4). 1711 pp.

Van Wijk, H. L. 1911. A dictionary of plant names. Martinus Nijhoff, The Hague, The Netherlands. 1444 pp.

Victorin, M. 1964. Flore Laurentienne. 2nd ed. Univ. Montreal, Montreal, Que., Canada. 952 pp.

Geographic Information

British Columbia

Newfoundland

Nova Scotia

Ontario

References:

Bailey, L. H., Bailey, E. Z. 1976. Hortus third. Revised. MacMillan, New York, N.Y., USA. 1290 pp.

Boivin, B. 1966, 1967. Énumération des plantes du Canada. Provencheria 6. Nat. Can. (Que.) 93: 253-274; 371-437; 583-646; 989-1063. 94: 131-157; 471-528; 625-655.

Image or illustration

Digitalis purpurea:

Images: images.google.com

Notes on Poisonous plant parts:

The entire plant contains toxic compounds. The leaves and seeds are used to produce digoxin and other cardenolides for pharmaceutical use. The chemicals do not lose their toxicity by drying, storage, boiling or incorporation in hay. The plants are unpalatable and are seldom eaten by animals (Cooper and Johnson 1984, Joubert 1989).

Toxic parts:

all parts
flowers
leaves
seeds
stems

References:

Cooper, M. R., Johnson, A. W. 1984. Poisonous plants in Britain and their effects on animals and man. Her Majesty's Stationery Office, London, England. 305 pp.

Joubert, J. P. 1989. Cardiac glycosides. Pages 61-97 in Cheeke, P. R., ed. Toxicants of plant origin. Vol. II. Glycosides. CRC Press, Inc., Boca Raton, Fla., USA. 277 pp.

Notes on Toxic plant chemicals:

Digitoxin is one of several cardiac glycosides found in foxglove and is considered the most toxic of these chemicals. The toxins are split by hydrolysis into a sugar and an aglycone (nonsugar compound). The aglycones have a direct effect on the muscles to the heart (Joubert 1989).

Toxic plant chemicals:

digitoxin

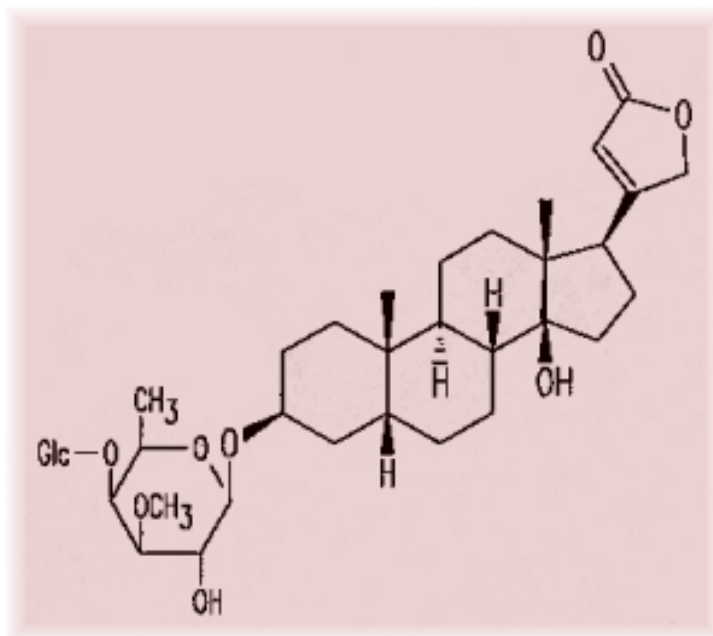

Chemical diagram(s) are courtesy of [Ruth McDiarmid](#), Biochemistry Technician, Kamloops Range Station, Agriculture and Agri-Food Canada, Kamloops, British Columbia, Canada.

References:

Joubert, J. P. 1989. Cardiac glycosides. Pages 61-97 in Cheeke, P. R., ed. Toxicants of plant origin. Vol. II. Glycosides. CRC Press, Inc., Boca Raton, Fla., USA. 277 pp.

Animals/Human Poisoning:

Note: When an animal is listed without additional information, the literature (as of 1993) contained no detailed explanation.

Cats

Cattle

General symptoms of poisoning:

[death](#)

[dyspnea](#)

[lungs, congestion of](#)

Notes on poisoning:

Dairy cattle have become poisoned after ingesting foxglove. Postmortem examination showed consolidation of the apical lobes of both lungs, with marked emphysema and bullae formation in the diaphragmatic lobes. Duodenal and jejunal mucosa were extremely congested and hemorrhagic. Some cattle recovered after treatment, whereas others took several days. One cow died 2 days after ingesting foxglove (Thomas et

al. 1987).

References:

Thomas, D. L., Quick, M. P., Morgan, R. P. 1987. Suspected foxglove (*Digitalis purpurea*) poisoning in a dairy cow. Vet. Rec., 120: 300-301.

Dogs

Goats

Horses

Humans

General symptoms of poisoning:

[abdominal pains](#)

[diarrhea](#)

[nausea](#)

Notes on poisoning:

Digitalis poisoning toxicity has a variable latent period depending on the quantity ingested. Gross disturbances in heartbeat and pulse are common. Most cases of human poisoning result from slight overdoses of prescribed drugs that contain digoxin or other related chemicals. Smith et al. (1982) describe the symptoms of digoxin and digitoxin toxicity, including nausea and severe vomiting. Many people develop hyperkalemia. Advanced cardiac rhythm disturbances are common, along with tachycardia and ventricular fibrillation. Treating patients with purified Fab fragments of digoxin-specific antibodies produces an initial favorable response and should lead to safe, effective reversal of life-threatening digitalis intoxication. Accidental ingestion of foxglove has occurred when the leaves were used in tea or when flowers were ingested (Cooper and Johnson 1984).

References:

Lampe, K. F., McCann, M. A. 1985. AMA Handbook of poisonous and injurious plants. American Medical Assoc. Chicago, Ill., USA. 432 pp.

Poultry

Sheep

Swine

General symptoms of poisoning:

[abdominal pains](#)

[convulsions](#)

[death](#)

[diarrhea](#)

Notes on poisoning:

General symptoms of foxglove poisoning for all types of animals include diarrhea, abdominal pain, irregular pulse, tremors, and convulsions. In severe cases, death occurs. Postmortem examination of pigs showed gastrointestinal inflammation, punctiform necrosis of the border of the spleen, and fatty degeneration of some nerve fibers in the heart. The presence of digitoxin in the body tissues confirms foxglove poisoning in animals (Cooper and Johnson 1984, Joubert 1989).

References:

Cooper, M. R., Johnson, A. W. 1984. Poisonous plants in Britain and their effects on animals and man. Her Majesty's Stationery Office, London, England. 305 pp.

Turkeys

General symptoms of poisoning:

[appetite, loss of](#)

[convulsions](#)

[death](#)

[drowsiness](#)

[pupil dilation](#)

Notes on poisoning:

Several turkeys died after ingesting foxglove leaves. Several turkeys slowly recovered. The crops were surgically removed from affected birds, a procedure which speeded up recovery time (Parker 1951).

References:

Parker, W. H. 1951. Foxglove (*Digitalis purpurea*) poisoning in turkeys. Vet. Rec., 63: 416.

[Another search?](#)

[Français](#) | [Contact Us](#) | [Help](#) | [Search](#) | [Canada site](#)

[Coming Events](#) | [About CBIF](#) | [Links](#) | [Reports and Publications](#) | [Home](#)

Date modified: 2003-02-06

[Important Notices](#)



Français	Contact us	Help	Search	Canada site
Coming events	About CBIF	Links	Reports and publications	Home

Canadian Biodiversity Information Facility



Notes on poisoning: *Dirca palustris*

[Introduction](#)

[Interactive](#)

[All poisonous plants by Botanical name](#)

[All poisonous plants by Common name](#)

[Important WWW Poisonous Plants sites](#)



General poisoning notes:

Leatherwood (*Dirca palustris*) is a native shrub found in parts of eastern Canada in woodlands. This shrub contains unknown poisonous chemicals that are most potent in the bark. Chewing the bark can cause severe burning in the mouth and can produce a nauseating taste; dermatitis can occur, especially during flowering and fruiting time (Fyles 1920, Lampe and McCann 1985).

References:

Fyles, F. 1920. Principal poisonous plants of Canada. Can. Dep. Agric. Exp. Farms. Bull. 39. 112 pp.

Lampe, K. F., McCann, M. A. 1985. AMA Handbook of poisonous and injurious plants. American Medical Assoc. Chicago, Ill., USA. 432 pp.

Nomenclature:

Scientific Name: *Dirca palustris* L.

Vernacular name(s): leatherwood

Scientific family name: *Thymelaeaceae*

Vernacular family name: mezereum

Go to ITIS^{*ca} for more taxonomic information on: [Dirca palustris](#)

References:

Agriculture Quebec. 1975. Noms des maladies des plantes du Canada/ Names of plant diseases in Canada. , Quebec City, Que., Canada. 288 pp.

Alex, J. F., Cayouette, R., Mulligan, G. A. 1980. Common and botanical names of weeds in Canada/Noms populaire et scientifiques des plantes nuisibles du Canada. Revised. Agric. Can. Publ., Ottawa, Ont., Canada. 132 pp.

Bailey, L. H., Bailey, E. Z. 1976. Hortus third. Revised. MacMillan, New York, N.Y., USA. 1290 pp.

Scoggan, H. J. 1978, 1979. The flora of Canada. Nat. Mus. Nat. Sci. (Ottawa) Publ. Bot. 7(1)-7(4). 1711 pp.

Van Wijk, H. L. 1911. A dictionary of plant names. Martinus Nijhoff, The Hague, The Netherlands. 1444 pp.

Victorin, M. 1964. Flore Laurentienne. 2nd ed. Univ. Montreal, Montreal, Que., Canada. 952 pp.

Geographic Information

New Brunswick

Ontario

Quebec

References:

Bailey, L. H., Bailey, E. Z. 1976. Hortus third. Revised. MacMillan, New York, N.Y., USA. 1290 pp.

Boivin, B. 1966, 1967. Énumération des plantes du Canada. Provencheria 6. Nat. Can. (Que.) 93: 253-274; 371-437; 583-646; 989-1063. 94: 131-157; 471-528; 625-655.

Image or illustration

Dirca palustris:

Images: images.google.com

Toxic parts:

bark

References:

Fyles, F. 1920. Principal poisonous plants of Canada. Can. Dep. Agric. Exp. Farms. Bull. 39. 112 pp.

Toxic plant chemicals:

unknown chemical

References:

Fyles, F. 1920. Principal poisonous plants of Canada. Can. Dep. Agric. Exp. Farms. Bull. 39. 112 pp.

Animals/Human Poisoning:

Note: When an animal is listed without additional information, the literature (as of 1993) contained no detailed explanation.

Humans

General symptoms of poisoning:

[blistering](#)
[mouth, irritation of](#)

References:

Fyles, F. 1920. Principal poisonous plants of Canada. Can. Dep. Agric. Exp. Farms. Bull. 39. 112 pp.

Lampe, K. F., McCann, M. A. 1985. AMA Handbook of poisonous and injurious plants. American Medical Assoc. Chicago, Ill., USA. 432 pp.

[Another search?](#)

[Français](#) | [Contact Us](#) | [Help](#) | [Search](#) | [Canada site](#)
[Coming Events](#) | [About CBIF](#) | [Links](#) | [Reports and Publications](#) | [Home](#)

Date modified: 2003-02-06

[Important Notices](#)



Français	Contact us	Help	Search	Canada site
Coming events	About CBIF	Links	Reports and publications	Home

Canadian Biodiversity Information Facility



Notes on poisoning: *Echium vulgare*

[Introduction](#)[Interactive](#)[All poisonous plants by Botanical name](#)[All poisonous plants by Common name](#)[Important WWW Poisonous Plants sites](#)

General poisoning notes:

Blueweed (*Echium vulgare*) is a naturalized biennial herb found in fields and waste places across Canada. The bristly hairs on this plant cause skin irritation. There is no mention of whether the irritation is purely mechanical or whether it is caused by chemicals in the hairs on the leaves and stems. This plant may also contain pyrrolizidine alkaloids including heliosupine (Cheeke 1989, Cooper and Johnson 1984). Poisoning by this plant has not been reported. Purple bugloss (*Echium lycopsis* L. = *Echium plantagineum* L.) has been collected in Canada on a couple of occasions, but it does not persist. This species does contain several pyrrolizidine alkaloids, including echimidine, echiumine, and heliotrine. The plant has caused death of horses and liver damage of sheep in Australia (Cooper and Johnson 1984, Cheeke 1989). Lampe and McCann (1985) discuss toxicity of both species to humans after ingestion of herbal teas containing *Echium* spp. Chronic consumption can cause veno-occlusive disease of the liver (Budd-Chiari syndrome), with hepatic vein thrombosis leading to cirrhosis. Purple bugloss (*Echium lycopsis*), which is discussed above, contains chemicals that can cause this type of problem. However, it does not appear to persist in Canada. There is no information in the literature on blueweed causing such poisoning, but it may contain pyrrolizidine alkaloids (Cheeke 1989). Caution is obviously warranted. Teas containing either of these plants should not be used by humans.

References:

Cheeke, P. R. 1989. Pyrrolizidine alkaloid toxicity and metabolism in laboratory animals and livestock. Pages 1-22 in Cheeke, P. R., ed. Toxicants of plant origin. Vol. I. Alkaloids. CRC Press, Inc., Boca Raton, Fla., USA. 335 pp.

Cooper, M. R., Johnson, A. W. 1984. Poisonous plants in Britain

and their effects on animals and man. Her Majesty's Stationery Office, London, England. 305 pp.

Lampe, K. F., McCann, M. A. 1985. AMA Handbook of poisonous and injurious plants. American Medical Assoc. Chicago, Ill., USA. 432 pp.

Nomenclature:

Scientific Name: *Echium vulgare* L.

Vernacular name(s): blueweed

Scientific family name: *Boraginaceae*

Vernacular family name: borage

Go to ITIS^{*ca} for more taxonomic information on: [Echium vulgare](#)

References:

Agriculture Quebec. 1975. Noms des maladies des plantes du Canada/ Names of plant diseases in Canada. , Quebec City, Que., Canada. 288 pp.

Alex, J. F., Cayouette, R., Mulligan, G. A. 1980. Common and botanical names of weeds in Canada/Noms populaire et scientifiques des plantes nuisibles du Canada. Revised. Agric. Can. Publ., Ottawa, Ont., Canada. 132 pp.

Bailey, L. H., Bailey, E. Z. 1976. Hortus third. Revised. MacMillan, New York, N.Y., USA. 1290 pp.

Scoggan, H. J. 1978, 1979. The flora of Canada. Nat. Mus. Nat. Sci. (Ottawa) Publ. Bot. 7(1)-7(4). 1711 pp.

Van Wijk, H. L. 1911. A dictionary of plant names. Martinus Nijhoff, The Hague, The Netherlands. 1444 pp.

Victorin, M. 1964. Flore Laurentienne. 2nd ed. Univ. Montreal, Montreal, Que., Canada. 952 pp.

Geographic Information

Alberta
British Columbia
Manitoba
New Brunswick
Newfoundland
Nova Scotia
Ontario
Quebec

Saskatchewan

References:

Bailey, L. H., Bailey, E. Z. 1976. Hortus third. Revised. MacMillan, New York, N.Y., USA. 1290 pp.

Boivin, B. 1966, 1967. Énumération des plantes du Canada. Provencheria 6. Nat. Can. (Que.) 93: 253-274; 371-437; 583-646; 989-1063. 94: 131-157; 471-528; 625-655.

Image or illustration

Echium vulgare:

Images: images.google.com

Notes on Poisonous plant parts:

The bristly hairs covering the stem and leaves produce severe inflammation when they break off and become imbedded in the skin (Muenscher 1975).

Toxic parts:

hairs

References:

Lampe, K. F., McCann, M. A. 1985. AMA Handbook of poisonous and injurious plants. American Medical Assoc. Chicago, Ill., USA. 432 pp.

Notes on Toxic plant chemicals:

Cheeke (1989) mentions that blueweed contains pyrrolizidine alkaloids, but no further information is given. Another member of the genus (*Echium lycopsis*) contains several alkaloids that have caused poisoning of animals in Australia.

Toxic plant chemicals:

unknown chemical

References:

Lampe, K. F., McCann, M. A. 1985. AMA Handbook of poisonous and injurious plants. American Medical Assoc. Chicago, Ill., USA. 432 pp.

Animals/Human Poisoning:

Note: When an animal is listed without additional information, the literature (as of 1993) contained no detailed explanation.

Humans

General symptoms of poisoning:

[itchiness](#)

Notes on poisoning:

The hairs on blueweed cause intense itchiness and skin irritation (Muenscher 1975).

References:

Lampe, K. F., McCann, M. A. 1985. AMA Handbook of poisonous and injurious plants. American Medical Assoc. Chicago, Ill., USA. 432 pp.

[Another search?](#)

[Français](#) | [Contact Us](#) | [Help](#) | [Search](#) | [Canada site](#)

[Coming Events](#) | [About CBIF](#) | [Links](#) | [Reports and Publications](#) |

[Home](#)

Date modified: 2003-02-06

[Important Notices](#)



Français	Contact us	Help	Search	Canada site
Coming events	About CBIF	Links	Reports and publications	Home

Canadian Biodiversity Information Facility



Notes on poisoning: *Equisetum arvense*

[Introduction](#)[Interactive](#)[All poisonous plants by Botanical name](#)[All poisonous plants by Common name](#)[Important WWW Poisonous Plants sites](#)

General poisoning notes:

Field horsetail (*Equisetum arvense*) is a native plant growing across Canada. This plant contains thiaminase which causes thiamine deficiency in horses. Ruminants are not generally affected by problems of thiamine deficiency because it is made in the rumen. However, some cattle were reported to have symptoms. In Canada, horses have been poisoned by ingesting field horsetail (Henderson et al. 1952, Cheeke and Schull 1985).

References:

[Cody, W. J.](#), Wagner, V. 1981. The biology of Canadian weeds. 49. *Equisetum arvense* L., 61: 123-133.

Henderson, J. A., Evans, E. V., McIntosh, R. A. 1951. The antithiamine action to *Equisetum*. J. Am. Vet. Med. Assoc., 120: 375-378.

Nomenclature:

Scientific Name: *Equisetum arvense* L.

Vernacular name(s): field horsetail

Scientific family name: *Equisetaceae*

Vernacular family name: horsetail

Go to ITIS^{*ca} for more taxonomic information on: [Equisetum arvense](#)

References:

Agriculture Quebec. 1975. Noms des maladies des plantes du Canada/ Names of plant diseases in Canada. , Quebec City, Que., Canada. 288 pp.

Alex, J. F., Cayouette, R., Mulligan, G. A. 1980. Common and botanical names of weeds in Canada/Noms populaire et scientifiques des plantes nuisibles du Canada. Revised. Agric. Can. Publ., Ottawa, Ont., Canada. 132 pp.

Bailey, L. H., Bailey, E. Z. 1976. Hortus third. Revised. MacMillan, New York, N.Y., USA. 1290 pp.

Scoggan, H. J. 1978, 1979. The flora of Canada. Nat. Mus. Nat. Sci. (Ottawa) Publ. Bot. 7(1)-7(4). 1711 pp.

Van Wijk, H. L. 1911. A dictionary of plant names. Martinus Nijhoff, The Hague, The Netherlands. 1444 pp.

Victorin, M. 1964. Flore Laurentienne. 2nd ed. Univ. Montreal, Montreal, Que., Canada. 952 pp.

Geographic Information

Alberta
British Columbia
Labrador
Manitoba
New Brunswick
Newfoundland
Northwest Territories
Nova Scotia
Ontario
Prince Edward Island
Quebec
Saskatchewan
Yukon Territory

References:

Bailey, L. H., Bailey, E. Z. 1976. Hortus third. Revised. MacMillan, New York, N.Y., USA. 1290 pp.

Boivin, B. 1966, 1967. Énumération des plantes du Canada. Provencheria 6. Nat. Can. (Que.) 93: 253-274; 371-437; 583-646; 989-1063. 94: 131-157; 471-528; 625-655.

Image or illustration

Equisetum arvense:

Images: images.google.com

Notes on Poisonous plant parts:

The horsetails have separate fertile and sterile fronds. Field horsetail has a fertile frond that is flesh-colored and appears before the green sterile frond.

Toxic parts:

leaves
stems

References:

Cheeke, P. R., Shull, L. R. 1985. Natural toxicants in feeds and poisonous plants. AVI Publishing Company, Inc., Westport, Conn., USA. 492 pp.

Notes on Toxic plant chemicals:

Thiaminase is an enzyme that splits thiamine, a B vitamin, making it inactive. Thiamine is involved in decarboxylation reactions in animal bodies. Deficiency of thiamine leads to accumulation of pyruvate in the blood, with a resulting impairment in energy metabolism and cellular shortage of ATP. Hay that contains horsetail at a level of 20% or more may produce symptoms of thiamine deficiency in horses in 2-5 weeks (Cheeke and Schull 1985).

Toxic plant chemicals:

thiaminase

References:

Cheeke, P. R., Shull, L. R. 1985. Natural toxicants in feeds and poisonous plants. AVI Publishing Company, Inc., Westport, Conn., USA. 492 pp.

Animals/Human Poisoning:

Note: When an animal is listed without additional information, the literature (as of 1993) contained no detailed explanation.

Cattle

Horses

Sheep

[Another search?](#)

[Français](#) | [Contact Us](#) | [Help](#) | [Search](#) | [Canada site](#)

[Coming Events](#) | [About CBIF](#) | [Links](#) | [Reports and Publications](#) |

[Home](#)

Date modified: 2003-02-06

[Important Notices](#)



Français	Contact us	Help	Search	Canada site
Coming events	About CBIF	Links	Reports and publications	Home

Canadian Biodiversity Information Facility



Notes on poisoning: *Equisetum palustre*

[Introduction](#)[Interactive](#)[All poisonous plants by Botanical name](#)[All poisonous plants by Common name](#)[Important WWW Poisonous Plants sites](#)

General poisoning notes:

Marsh horsetail (*Equisetum palustre*) is a native horsetail growing across Canada. This plant has poisoned cattle and, rarely, sheep. In addition to thiaminase, it contains an alkaloid, that causes the toxicity (Kingsbury 1964, Cooper and Johnson 1984).



References:

Cooper, M. R., Johnson, A. W. 1984. Poisonous plants in Britain and their effects on animals and man. Her Majesty's Stationery Office, London, England. 305 pp.

Frohne, D., Pfander, H. J. 1983. A colour atlas of poisonous plants. Wolfe Publishing Ltd., London, England. 291 pp.

Kingsbury, J. M. 1964. Poisonous plants of the United States and Canada. Prentice-Hall Inc., Englewood Cliffs, N.J., USA. 626 pp.

Nomenclature:

Scientific Name: *Equisetum palustre* L.

Vernacular name(s): marsh horsetail

Scientific family name: *Equisetaceae*

Vernacular family name: horsetail

Go to ITIS^{*ca} for more taxonomic information on: [Equisetum palustre](#)

References:

Agriculture Quebec. 1975. Noms des maladies des plantes du Canada/ Names of plant diseases in Canada. , Quebec City, Que.,

Canada. 288 pp.

Alex, J. F., Cayouette, R., Mulligan, G. A. 1980. Common and botanical names of weeds in Canada/Noms populaire et scientifiques des plantes nuisibles du Canada. Revised. Agric. Can. Publ., Ottawa, Ont., Canada. 132 pp.

Bailey, L. H., Bailey, E. Z. 1976. Hortus third. Revised. MacMillan, New York, N.Y., USA. 1290 pp.

Scoggan, H. J. 1978, 1979. The flora of Canada. Nat. Mus. Nat. Sci. (Ottawa) Publ. Bot. 7(1)-7(4). 1711 pp.

Van Wijk, H. L. 1911. A dictionary of plant names. Martinus Nijhoff, The Hague, The Netherlands. 1444 pp.

Victorin, M. 1964. Flore Laurentienne. 2nd ed. Univ. Montreal, Montreal, Que., Canada. 952 pp.

Geographic Information

Alberta
British Columbia
Manitoba
New Brunswick
Newfoundland
Northwest Territories
Nova Scotia
Ontario
Prince Edward Island
Quebec
Saskatchewan
Yukon Territory

References:

Bailey, L. H., Bailey, E. Z. 1976. Hortus third. Revised. MacMillan, New York, N.Y., USA. 1290 pp.

Boivin, B. 1966, 1967. Énumération des plantes du Canada. Provencheria 6. Nat. Can. (Que.) 93: 253-274; 371-437; 583-646; 989-1063. 94: 131-157; 471-528; 625-655.

Image or illustration

Equisetum palustre:

Images: images.google.com

Notes on Poisonous plant parts:

Marsh horsetail has separate fertile and sterile stems. Unlike field horsetail, both types of fronds are greenish, with the added fruiting sporangia body on top of the fertile frond.

Toxic parts:

leaves
stems

References:

Frohne, D., Pfander, H. J. 1983. A colour atlas of poisonous plants. Wolfe Publishing Ltd., London, England. 291 pp.

Notes on Toxic plant chemicals:

Palustrine, an alkaloid, has been found in marsh horsetail. This alkaloid may contribute to the poisoning of cattle by this plant. Thiaminase activity is usually not a problem in ruminants because thiamine is produced in the rumen. Therefore, the presence of alkaloids is suspected to cause the toxic responses. The alkaloid content varies greatly (96-302 mg/100 g of dry weight). Frosted plant material quickly loses most of its alkaloid content, whereas air-dried marsh horsetail can keep its alkaloid content for years (Frohne and Pfander 1983).

Toxic plant chemicals:

palustrine
thiaminase

References:

Frohne, D., Pfander, H. J. 1983. A colour atlas of poisonous plants. Wolfe Publishing Ltd., London, England. 291 pp.

Animals/Human Poisoning:

Note: When an animal is listed without additional information, the literature (as of 1993) contained no detailed explanation.

Cattle

General symptoms of poisoning:

[diarrhea](#)

References:

Kingsbury, J. M. 1964. Poisonous plants of the United States and Canada. Prentice-Hall Inc., Englewood Cliffs, N.J., USA. 626 pp.

Horses

Sheep

General symptoms of poisoning:

[diarrhea](#)
[muscle, weakness of](#)
[sweating](#)

References:

Cooper, M. R., Johnson, A. W. 1984. Poisonous plants in Britain and their effects on animals and man. Her Majesty's Stationery Office, London, England. 305 pp.

Kingsbury, J. M. 1964. Poisonous plants of the United States and Canada. Prentice-Hall Inc., Englewood Cliffs, N.J., USA. 626 pp.

[Another search?](#)

[Français](#) | [Contact Us](#) | [Help](#) | [Search](#) | [Canada site](#)

[Coming Events](#) | [About CBIF](#) | [Links](#) | [Reports and Publications](#) |

[Home](#)

Date modified: 2003-02-06

[Important Notices](#)



Français	Contact us	Help	Search	Canada site
Coming events	About CBIF	Links	Reports and publications	Home

Canadian Biodiversity Information Facility



Notes on poisoning: *Erysimum cheiranthoides*

[Introduction](#)[Interactive](#)[All poisonous plants by Botanical name](#)[All poisonous plants by Common name](#)[Important WWW Poisonous Plants sites](#)

General poisoning notes:

Wormseed mustard (*Erysimum cheiranthoides*) is a naturalized herb found across Canada in fields and waste places. It contains large quantities of glucosinolates, which release allyl isothiocyanate upon hydrolysis. Cattle and swine were poisoned in Canada when feeds were contaminated with sufficient quantities of seed from wormseed mustard plants (Kingsbury 1964, Palechek 1986).

References:



Kingsbury, J. M. 1964. Poisonous plants of the United States and Canada. Prentice-Hall Inc., Englewood Cliffs, N.J., USA. 626 pp.

Palechek, N. 1986. Toxic weed seeds in cattle feed. Can. Vet. J., 26: A10.

Nomenclature:

Scientific Name: *Erysimum cheiranthoides* L.

Vernacular name(s): wormseed mustard

Scientific family name: *Cruciferae*

Vernacular family name: mustard

Go to ITIS*^{ca} for more taxonomic information on: [Erysimum cheiranthoides](#)

References:

Agriculture Quebec. 1975. Noms des maladies des plantes du Canada/ Names of plant diseases in Canada. , Quebec City, Que., Canada. 288 pp.

Alex, J. F., Cayouette, R., Mulligan, G. A. 1980. Common and

botanical names of weeds in Canada/Noms populaire et scientifiques des plantes nuisibles du Canada. Revised. Agric. Can. Publ., Ottawa, Ont., Canada. 132 pp.

Bailey, L. H., Bailey, E. Z. 1976. Hortus third. Revised. MacMillan, New York, N.Y., USA. 1290 pp.

Scoggan, H. J. 1978, 1979. The flora of Canada. Nat. Mus. Nat. Sci. (Ottawa) Publ. Bot. 7(1)-7(4). 1711 pp.

Van Wijk, H. L. 1911. A dictionary of plant names. Martinus Nijhoff, The Hague, The Netherlands. 1444 pp.

Victorin, M. 1964. Flore Laurentienne. 2nd ed. Univ. Montreal, Montreal, Que., Canada. 952 pp.

Geographic Information

Alberta
British Columbia
Manitoba
New Brunswick
Newfoundland
Northwest Territories
Nova Scotia
Ontario
Prince Edward Island
Quebec
Saskatchewan
Yukon Territory

References:

Bailey, L. H., Bailey, E. Z. 1976. Hortus third. Revised. MacMillan, New York, N.Y., USA. 1290 pp.

Boivin, B. 1966, 1967. Énumération des plantes du Canada. Provencheria 6. Nat. Can. (Que.) 93: 253-274; 371-437; 583-646; 989-1063. 94: 131-157; 471-528; 625-655.

Image or illustration

Erysimum cheiranthoides:

Images: images.google.com

Toxic parts:

seeds

References:

Kingsbury, J. M. 1964. Poisonous plants of the United States and Canada. Prentice-Hall Inc., Englewood Cliffs, N.J., USA. 626 pp.

Palechek, N. 1986. Toxic weed seeds in cattle feed. Can. Vet. J., 26: A10.

Toxic plant chemicals:

glucosinolates

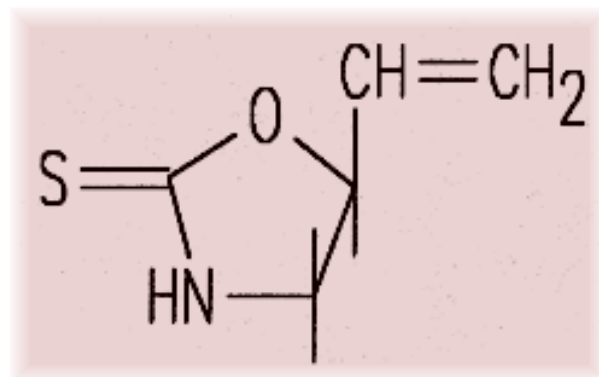

glucosinolates

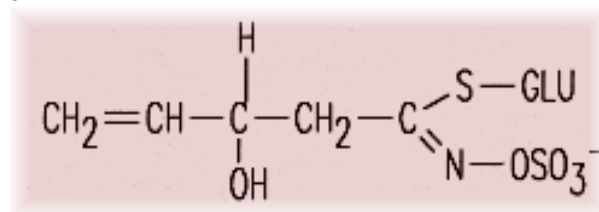

glucosinolates

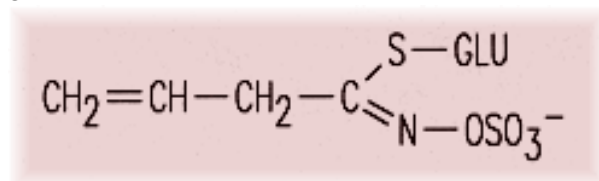

Chemical diagram(s) are courtesy of [Ruth McDiarmid](#), Biochemistry Technician, Kamloops Range Station, Agriculture and Agri-Food Canada, Kamloops, British Columbia, Canada.

References:

Kingsbury, J. M. 1964. Poisonous plants of the United States and Canada. Prentice-Hall Inc., Englewood Cliffs, N.J., USA. 626 pp.

Palechek, N. 1986. Toxic weed seeds in cattle feed. Can. Vet. J., 26: A10.

Animals/Human Poisoning:

Note: When an animal is listed without additional information, the literature (as of 1993) contained no detailed explanation.

Cattle

General symptoms of poisoning:

[colic](#)

[depression](#)

References:

Palechek, N. 1986. Toxic weed seeds in cattle feed. Can. Vet. J., 26: A10.

Swine

General symptoms of poisoning:

[death](#)

Notes on poisoning:

Swine died after ingesting food that contained 1.7% seeds of the plant by weight (Kingsbury 1964).

References:

Kingsbury, J. M. 1964. Poisonous plants of the United States and Canada. Prentice-Hall Inc., Englewood Cliffs, N.J., USA. 626 pp.

[Another search?](#)

[Français](#) | [Contact Us](#) | [Help](#) | [Search](#) | [Canada site](#)

[Coming Events](#) | [About CBIF](#) | [Links](#) | [Reports and Publications](#) |

[Home](#)

Date modified: 2003-02-06

[Important Notices](#)



Français	Contact us	Help	Search	Canada site
Coming events	About CBIF	Links	Reports and publications	Home

Canadian Biodiversity Information Facility



Notes on poisoning: *Euonymus atropurpureus*

[Introduction](#)[Interactive](#)[All poisonous plants by Botanical name](#)[All poisonous plants by Common name](#)[Important WWW Poisonous Plants sites](#)

General poisoning notes:

Burningbush (*Euonymus atropurpureus*) is an ornamental shrub that grows across southern Canada. Several reviews have noted that this plant is poisonous, but documented cases appear to refer to the closely related European spindletree (*Euonymus europaeus*). See additional information under general notes on the European spindletree. Children who ingest the seeds should be attended to. Children and horses have been poisoned by ingesting the European spindletree. Symptoms of poisoning of children and horses are discussed under that plant as well.

References:

Kingsbury, J. M. 1964. Poisonous plants of the United States and Canada. Prentice-Hall Inc., Englewood Cliffs, N.J., USA. 626 pp.

Nomenclature:

Scientific Name: *Euonymus atropurpureus* Jacq.

Vernacular name(s): burningbush

Scientific family name: *Celastraceae*

Vernacular family name: stafftree

Go to ITIS^{*ca} for more taxonomic information on: [Euonymus atropurpureus](#)

References:

Agriculture Quebec. 1975. Noms des maladies des plantes du Canada/ Names of plant diseases in Canada. , Quebec City, Que., Canada. 288 pp.

Alex, J. F., Cayouette, R., Mulligan, G. A. 1980. Common and

botanical names of weeds in Canada/Noms populaire et scientifiques des plantes nuisibles du Canada. Revised. Agric. Can. Publ., Ottawa, Ont., Canada. 132 pp.

Bailey, L. H., Bailey, E. Z. 1976. Hortus third. Revised. MacMillan, New York, N.Y., USA. 1290 pp.

Scoggan, H. J. 1978, 1979. The flora of Canada. Nat. Mus. Nat. Sci. (Ottawa) Publ. Bot. 7(1)-7(4). 1711 pp.

Van Wijk, H. L. 1911. A dictionary of plant names. Martinus Nijhoff, The Hague, The Netherlands. 1444 pp.

Victorin, M. 1964. Flore Laurentienne. 2nd ed. Univ. Montreal, Montreal, Que., Canada. 952 pp.

Geographic Information

Plant or plant parts used in or around the home.

References:

Bailey, L. H., Bailey, E. Z. 1976. Hortus third. Revised. MacMillan, New York, N.Y., USA. 1290 pp.

Boivin, B. 1966, 1967. Énumération des plantes du Canada. Provencheria 6. Nat. Can. (Que.) 93: 253-274; 371-437; 583-646; 989-1063. 94: 131-157; 471-528; 625-655.

Image or illustration

Euonymus atropurpureus:

Images: images.google.com

Toxic parts:

bark
leaves
seeds

References:

Kingsbury, J. M. 1964. Poisonous plants of the United States and Canada. Prentice-Hall Inc., Englewood Cliffs, N.J., USA. 626 pp.

Toxic plant chemicals:

evomonoside

References:

Kingsbury, J. M. 1964. Poisonous plants of the United States and Canada. Prentice-Hall Inc., Englewood Cliffs, N.J., USA. 626 pp.

Animals/Human Poisoning:

Note: When an animal is listed without additional information, the literature (as of 1993) contained no detailed explanation.

Horses

Humans

[Another search?](#)

[Français](#) | [Contact Us](#) | [Help](#) | [Search](#) | [Canada site](#)

[Coming Events](#) | [About CBIF](#) | [Links](#) | [Reports and Publications](#) | [Home](#)

Date modified: 2003-02-06

[Important Notices](#)



Français	Contact us	Help	Search	Canada site
Coming events	About CBIF	Links	Reports and publications	Home

Canadian Biodiversity Information Facility



Notes on poisoning: *Euonymus europaeus*

[Introduction](#)[Interactive](#)[All poisonous plants by Botanical name](#)[All poisonous plants by Common name](#)[Important WWW Poisonous Plants sites](#)

General poisoning notes:

European spindletree (*Euonymus europaeus*) is an ornamental shrub that can grow in the warmer parts of Canada. The shrub has poisoned children as well as goats, horses, and sheep. Children are attracted to the mature fleshy orange fruits, which contain seeds with cardiac glycosides and alkaloids. Children have become quite ill. Fatal poisoning has occurred in two horses after they ingested shoots of this plant (Frohne and Pfander 1983, Cooper and Johnson 1984, Lampe and McCann 1985).

References:

Cooper, M. R., Johnson, A. W. 1984. Poisonous plants in Britain and their effects on animals and man. Her Majesty's Stationery Office, London, England. 305 pp.

Frohne, D., Pfander, H. J. 1983. A colour atlas of poisonous plants. Wolfe Publishing Ltd., London, England. 291 pp.

Lampe, K. F., McCann, M. A. 1985. AMA Handbook of poisonous and injurious plants. American Medical Assoc. Chicago, Ill., USA. 432 pp.

Nomenclature:

Scientific Name: *Euonymus europaeus* L.

Vernacular name(s): European spindletree

Scientific family name: *Celastraceae*

Vernacular family name: stafftree

Go to ITIS^{*ca} for more taxonomic information on: [Euonymus europaeus](#)

References:

Agriculture Quebec. 1975. Noms des maladies des plantes du Canada/ Names of plant diseases in Canada. , Quebec City, Que., Canada. 288 pp.

Alex, J. F., Cayouette, R., Mulligan, G. A. 1980. Common and botanical names of weeds in Canada/Noms populaire et scientifiques des plantes nuisibles du Canada. Revised. Agric. Can. Publ., Ottawa, Ont., Canada. 132 pp.

Bailey, L. H., Bailey, E. Z. 1976. Hortus third. Revised. MacMillan, New York, N.Y., USA. 1290 pp.

Scoggan, H. J. 1978, 1979. The flora of Canada. Nat. Mus. Nat. Sci. (Ottawa) Publ. Bot. 7(1)-7(4). 1711 pp.

Van Wijk, H. L. 1911. A dictionary of plant names. Martinus Nijhoff, The Hague, The Netherlands. 1444 pp.

Victorin, M. 1964. Flore Laurentienne. 2nd ed. Univ. Montreal, Montreal, Que., Canada. 952 pp.

Geographic Information

Plant or plant parts used in or around the home.

References:

Bailey, L. H., Bailey, E. Z. 1976. Hortus third. Revised. MacMillan, New York, N.Y., USA. 1290 pp.

Boivin, B. 1966, 1967. Énumération des plantes du Canada. Provencheria 6. Nat. Can. (Que.) 93: 253-274; 371-437; 583-646; 989-1063. 94: 131-157; 471-528; 625-655.

Image or illustration

Euonymus europaeus:

Images: images.google.com

Notes on Poisonous plant parts:

The conspicuous fruiting structures of the European spindle tree entice children to eat them. The seeds contain toxins that have caused poisoning of children (Frohne and Pfander 1983).

Toxic parts:

bark

leaves

seeds

References:

Frohne, D., Pfander, H. J. 1983. A colour atlas of poisonous plants. Wolfe Publishing Ltd., London, England. 291 pp.

Notes on Toxic plant chemicals:

Several cardiac glycosides have been found in the seeds, including evomonoside, whose aglycone is digitoxigenin. Alkaloids also make up about 0.1% of the seeds, including evonine. The toxicity of the alkaloidal fraction has not been studied. Cardiac glycosides are also found in the leaves and bark (the alkaloid content is too low to be of any consequence) (Frohne and Pfander 1983, Lampe and McCann 1985).

Toxic plant chemicals:

evomonoside

evonine

References:

Frohne, D., Pfander, H. J. 1983. A colour atlas of poisonous plants. Wolfe Publishing Ltd., London, England. 291 pp.

Lampe, K. F., McCann, M. A. 1985. AMA Handbook of poisonous and injurious plants. American Medical Assoc. Chicago, Ill., USA. 432 pp.

Animals/Human Poisoning:

Note: When an animal is listed without additional information, the literature (as of 1993) contained no detailed explanation.

Goats

Horses

General symptoms of poisoning:

[constipation](#)

[death](#)

[heart rate, elevated](#)

Notes on poisoning:

In one case in Europe, two horses had access to the shoots of European spindletree and they ingested large quantities of them. The animals suffered paralysis of the digestive tract. The pulse was rapid and the horses died within 4 days. Postmortem examination showed inflammation of the intestines (Cooper and Johnson 1984).

References:

Cooper, M. R., Johnson, A. W. 1984. Poisonous plants in Britain and their effects on animals and man. Her Majesty's Stationery Office, London, England. 305 pp.

Humans

General symptoms of poisoning:

[convulsions](#)

[death](#)

[diarrhea](#)

[hallucination](#)

[vomiting](#)

Notes on poisoning:

Children are attracted to the bright orange fruits, which contain toxic seeds. Symptoms occur 10-12 h after ingestion and include diarrhea, vomiting, stimulation of the heart and, in more severe cases, hallucination and loss of consciousness. In one fatal case, the child had blood-stained diarrhea and convulsions before death (Cooper and Johnson 1984).

References:

Cooper, M. R., Johnson, A. W. 1984. Poisonous plants in Britain and their effects on animals and man. Her Majesty's Stationery Office, London, England. 305 pp.

Sheep

[Another search?](#)

[Français](#) | [Contact Us](#) | [Help](#) | [Search](#) | [Canada site](#)

[Coming Events](#) | [About CBIF](#) | [Links](#) | [Reports and Publications](#) | [Home](#)

Date modified: 2003-02-06

[Important Notices](#)



Français	Contact us	Help	Search	Canada site
Coming events	About CBIF	Links	Reports and publications	Home

Canadian Biodiversity Information Facility



Notes on poisoning: *Eupatorium rugosum*

[Introduction](#)

[Interactive](#)

[All poisonous plants by Botanical name](#)

[All poisonous plants by Common name](#)

[Important WWW Poisonous Plants sites](#)



General poisoning notes:

White snakeroot (*Eupatorium rugosum*) is a native herb that grows in rich soils in eastern Canada. This plant has caused illness and death of humans and several types of livestock. Large losses of human life occurred in the 19th century from the mysterious milk sickness. Mortality ranged from 10 to 25%, and the population of entire villages left a location because they could not find the cause of the disease. It was later discovered that cattle had ingested white snakeroot and that a toxin was subsequently passed through the milk to humans and was toxic. With modern collection and combination techniques, milk sickness from commercial milk sources is no longer a problem. However, the resurgence of small-scale farming and home milk production may result in occasional cases of milk sickness (Kingsbury 1964, Stotts 1984, Cheeke and Schull 1985, Beier and Norman 1990).

Several types of herbivorous livestock have also been poisoned by ingesting white snakeroot, resulting in a disease called trembles. Cattle, goats, horses, sheep, and swine have shown toxic reactions. Suckling animals can develop milk sickness as well. Trembles was more of a problem in the past, before the increased use of herbicides and prepared feeds. Poisoning was also more frequent when animals were allowed to range through bushlots. The amount of white snakeroot that must be ingested before death is variable, ranging from 1 to 20%. Symptoms can occur within a few days or up to 3 weeks later. Daily intake rates of 0.5-1.5% of body weight generally leads to the onset of symptoms. Drying the plant material does not completely remove the danger to animals (Doyle and Walkley 1949, Kingsbury 1964, Cheeke and Schull 1985, Beier and Norman 1990).

Additional care must be taken with milk from cattle or goats that may have ingested white snakeroot. Many articles state that a lactating animal does not always show symptoms. However, milk from that animal can still cause milk sickness. Calves, humans,

and cats have been poisoned in such cases. Dogs given the milk are also be at risk. Experimental work has shown that trembles can occur in rabbits and guinea pigs. White snakeroot grows in rich moist open woods and along water courses. Animals should not be allowed to graze this plant.

References:

Beier, R. C., Norman, J. O. 1990. The toxic factor in white snakeroot: identity, analysis and prevention. *Vet. Hum. Toxicol.*, 32: 81-88.

Cheeke, P. R., Shull, L. R. 1985. Natural toxicants in feeds and poisonous plants. AVI Publishing Company, Inc., Westport, Conn., USA. 492 pp.

Couch, J. F. 1927. The toxic constituent of richweed or white snakeroot (*Eupatorium urticaefolium*). *J. Agric. Res.*, 35: 547-576.

Doyle, L. P., Walkey, F. L. 1949. White snakeroot (*Eupatorium urticaefolium*) poisoning in livestock. *Purdue Univ. Agric. Exp. Stn. Bull.*, 270. 14 pp.

Kingsbury, J. M. 1964. Poisonous plants of the United States and Canada. Prentice-Hall Inc., Englewood Cliffs, N.J., USA. 626 pp.

Olson, C. T., Keller, W. C., Gerken, D. F., Reed, S. M. 1984. Suspected tremetol poisoning in horses. *J. Am. Vet. Med. Assoc.*, 185: 1001-1003.

Stotts, R. 1984. White snakeroot toxicity in dairy cattle. *Vet. Med. Small Anim. Clin.*, 79: 118-120.

Nomenclature:

Scientific Name: *Eupatorium rugosum* Houtt.

Vernacular name(s): white snakeroot

Scientific family name: *Compositae*

Vernacular family name: composite

Go to ITIS^{*ca} for more taxonomic information on: [Eupatorium rugosum](#)

References:

Agriculture Quebec. 1975. Noms des maladies des plantes du Canada/ Names of plant diseases in Canada. , Quebec City, Que., Canada. 288 pp.

Alex, J. F., Cayouette, R., Mulligan, G. A. 1980. Common and

botanical names of weeds in Canada/Noms populaire et scientifiques des plantes nuisibles du Canada. Revised. Agric. Can. Publ., Ottawa, Ont., Canada. 132 pp.

Bailey, L. H., Bailey, E. Z. 1976. Hortus third. Revised. MacMillan, New York, N.Y., USA. 1290 pp.

Scoggan, H. J. 1978, 1979. The flora of Canada. Nat. Mus. Nat. Sci. (Ottawa) Publ. Bot. 7(1)-7(4). 1711 pp.

Van Wijk, H. L. 1911. A dictionary of plant names. Martinus Nijhoff, The Hague, The Netherlands. 1444 pp.

Victorin, M. 1964. Flore Laurentienne. 2nd ed. Univ. Montreal, Montreal, Que., Canada. 952 pp.

Geographic Information

New Brunswick
Nova Scotia
Ontario
Prince Edward Island
Quebec

References:

Bailey, L. H., Bailey, E. Z. 1976. Hortus third. Revised. MacMillan, New York, N.Y., USA. 1290 pp.

Boivin, B. 1966, 1967. Énumération des plantes du Canada. Provencheria 6. Nat. Can. (Que.) 93: 253-274; 371-437; 583-646; 989-1063. 94: 131-157; 471-528; 625-655.

Image or illustration

Eupatorium rugosum:

Images: images.google.com

Toxic parts:

leaves
stems

References:

Doyle, L. P., Walkey, F. L. 1949. White snakeroot (*Eupatorium urticaefolium*) poisoning in livestock. Purdue Univ. Agric. Exp. Stn. Bull., 270. 14 pp.

Kaufmann, G. W. 1982. Seasonal variation of tremetol concentrations found in white snakeroot, *Eupatorium rugosum*

Houtt (Compositae). Proc. Iowa Acad. Sci., 89: 151-152.

Olson, C. T., Keller, W. C., Gerken, D. F., Reed, S. M. 1984. Suspected tremetol poisoning in horses. J. Am. Vet. Med. Assoc., 185: 1001-1003.

Notes on Toxic plant chemicals:

Tremetol is a secondary aromatic alcohol with a sterol and ketone fraction. One of these ketones, tremetone, has been tested on chickens, with negative results, but was toxic to goldfish in experimental studies. In Iowa the concentration of tremetol was found to be highest during the summer (Kaufmann 1982).

Toxic plant chemicals:

tremetol

References:

Couch, J. F. 1927. The toxic constituent of richweed or white snakeroot (*Eupatorium urticaefolium*). J. Agric. Res., 35: 547-576.

Kaufmann, G. W. 1982. Seasonal variation of tremetol concentrations found in white snakeroot, *Eupatorium rugosum* Houtt (Compositae). Proc. Iowa Acad. Sci., 89: 151-152.

Animals/Human Poisoning:

Note: When an animal is listed without additional information, the literature (as of 1993) contained no detailed explanation.

Cattle

General symptoms of poisoning:

[appetite, loss of](#)

[ataxia](#)

[brain, congestion of](#)

[breathing, rapid](#)

[coma](#)

[constipation](#)

[death](#)

[depression](#)

[gait, unsteady](#)

[lungs, congestion of](#)

[nasal discharge](#)

[nausea](#)
[prostration](#)
[recumbency](#)
[trembling](#)
[urine, yellowish](#)
[vomiting](#)
[weakness](#)

References:

Doyle, L. P., Walkey, F. L. 1949. White snakeroot (*Eupatorium urticaefolium*) poisoning in livestock. Purdue Univ. Agric. Exp. Stn. Bull., 270. 14 pp.

Stotts, R. 1984. White snakeroot toxicity in dairy cattle. Vet. Med. Small Anim. Clin., 79: 118-120.

Dogs

Goats

Horses

General symptoms of poisoning:

[breathing, labored](#)
[breathing, rapid](#)
[breathing, shallow](#)
[constipation](#)
[death](#)
[depression](#)
[gait, rigid](#)
[lungs, congestion of](#)
[nasal discharge](#)
[prostration](#)
[pupil dilation](#)
[recumbency](#)
[sweating](#)
[trembling](#)

References:

Doyle, L. P., Walkey, F. L. 1949. White snakeroot (*Eupatorium urticaefolium*) poisoning in livestock. Purdue Univ. Agric. Exp. Stn. Bull., 270. 14 pp.

Olson, C. T., Keller, W. C., Gerken, D. F., Reed, S. M. 1984. Suspected tremetol poisoning in horses. J. Am. Vet. Med. Assoc.,

185: 1001-1003.

Humans

Rabbits

Sheep

General symptoms of poisoning:

[acidosis](#)

[death](#)

[nervousness](#)

[trembling](#)

References:

Couch, J. F. 1927. The toxic constituent of richweed or white snakeroot (*Eupatorium urticaefolium*). J. Agric. Res., 35: 547-576.

Kingsbury, J. M. 1964. Poisonous plants of the United States and Canada. Prentice-Hall Inc., Englewood Cliffs, N.J., USA. 626 pp.

[Another search?](#)

[Français](#) | [Contact Us](#) | [Help](#) | [Search](#) | [Canada site](#)

[Coming Events](#) | [About CBIF](#) | [Links](#) | [Reports and Publications](#) |

[Home](#)

Date modified: 2003-02-06

[Important Notices](#)



Français	Contact us	Help	Search	Canada site
Coming events	About CBIF	Links	Reports and publications	Home

Canadian Biodiversity Information Facility



Notes on poisoning: *Euphorbia cyparissias*

[Introduction](#)[Interactive](#)[All poisonous plants by Botanical name](#)[All poisonous plants by Common name](#)[Important WWW Poisonous Plants sites](#)

General poisoning notes:

Cypress spurge (*Euphorbia cyparissias*) is a naturalized herb found across southern Canada. Ingesting the plant has caused loss of cattle in New York State. This plant is usually avoided by livestock but is ingested if incorporated with hay. The plant is abundant in some locations in southern Ontario. Some humans are sensitive to the irritant latex and may develop inflammation.

References:

Frohne, D., Pfander, H. J. 1983. A colour atlas of poisonous plants. Wolfe Publishing Ltd., London, England. 291 pp.

Kingsbury, J. M. 1964. Poisonous plants of the United States and Canada. Prentice-Hall Inc., Englewood Cliffs, N.J., USA. 626 pp.

Stahevitch, A. E., Crompton, C. W., Wojtas, W. A. 1988. The biology of Canadian weeds. 85. *Euphorbia cyparissias* L. Can. J. Plant Sci., 68: 175-191.

Nomenclature:

Scientific Name: *Euphorbia cyparissias* L.

Vernacular name(s): cypress spurge

Scientific family name: *Euphorbiaceae*

Vernacular family name: spurge

Go to ITIS^{*ca} for more taxonomic information on: [Euphorbia cyparissias](#)

References:

Agriculture Quebec. 1975. Noms des maladies des plantes du

Canada/ Names of plant diseases in Canada. , Quebec City, Que., Canada. 288 pp.

Alex, J. F., Cayouette, R., Mulligan, G. A. 1980. Common and botanical names of weeds in Canada/Noms populaire et scientifiques des plantes nuisibles du Canada. Revised. Agric. Can. Publ., Ottawa, Ont., Canada. 132 pp.

Bailey, L. H., Bailey, E. Z. 1976. Hortus third. Revised. MacMillan, New York, N.Y., USA. 1290 pp.

Scoggan, H. J. 1978, 1979. The flora of Canada. Nat. Mus. Nat. Sci. (Ottawa) Publ. Bot. 7(1)-7(4). 1711 pp.

Van Wijk, H. L. 1911. A dictionary of plant names. Martinus Nijhoff, The Hague, The Netherlands. 1444 pp.

Victorin, M. 1964. Flore Laurentienne. 2nd ed. Univ. Montreal, Montreal, Que., Canada. 952 pp.

Geographic Information

British Columbia
Manitoba
New Brunswick
Newfoundland
Nova Scotia
Ontario
Prince Edward Island
Quebec

References:

Bailey, L. H., Bailey, E. Z. 1976. Hortus third. Revised. MacMillan, New York, N.Y., USA. 1290 pp.

Boivin, B. 1966, 1967. Énumération des plantes du Canada. Provencheria 6. Nat. Can. (Que.) 93: 253-274; 371-437; 583-646; 989-1063. 94: 131-157; 471-528; 625-655.

Image or illustration

Euphorbia cyparissias:

Images: images.google.com

Notes on Poisonous plant parts:

The toxic compounds are found in the latex and seeds (Frohne and Pfander 1983).

Toxic parts:

latex
seeds

References:

Frohne, D., Pfander, H. J. 1983. A colour atlas of poisonous plants. Wolfe Publishing Ltd., London, England. 291 pp.

Notes on Toxic plant chemicals:

Unknown ingenanes, toxic diterpenes, are found in this plant (Frohne and Pfander 1983).

Toxic plant chemicals:

5-deoxyingenol

References:

Frohne, D., Pfander, H. J. 1983. A colour atlas of poisonous plants. Wolfe Publishing Ltd., London, England. 291 pp.

Animals/Human Poisoning:

Note: When an animal is listed without additional information, the literature (as of 1993) contained no detailed explanation.

Cattle

General symptoms of poisoning:

[collapse](#)
[death](#)
[diarrhea](#)
[weakness](#)

Notes on poisoning:

Cattle that have ingested hay containing large amounts of cypress spurge have had diarrhea followed by weakness, collapse, and death (Kingsbury 1964).

References:

Kingsbury, J. M. 1964. Poisonous plants of the United States and Canada. Prentice-Hall Inc., Englewood Cliffs, N.J., USA. 626 pp.

Horses

Humans

General symptoms of poisoning:

[blistering](#)

References:

Frohne, D., Pfander, H. J. 1983. A colour atlas of poisonous plants. Wolfe Publishing Ltd., London, England. 291 pp.

Sheep

[Another search?](#)

[Français](#) | [Contact Us](#) | [Help](#) | [Search](#) | [Canada site](#)

[Coming Events](#) | [About CBIF](#) | [Links](#) | [Reports and Publications](#) |

[Home](#)

Date modified: 2003-02-06

[Important Notices](#)



Français	Contact us	Help	Search	Canada site
Coming events	About CBIF	Links	Reports and publications	Home

Canadian Biodiversity Information Facility



Notes on poisoning: *Euphorbia esula*

[Introduction](#)[Interactive](#)[All poisonous plants by Botanical name](#)[All poisonous plants by Common name](#)[Important WWW Poisonous Plants sites](#)

General poisoning notes:

Leafy spurge (*Euphorbia esula*) is a naturalized herb that grows across southern Canada. The plant is usually not ingested by livestock, but if large amounts are incorporated in hay, poisoning can occur. Sheep are more resistant to leafy spurge, but collapse and death have occurred (Kingsbury 1964). Some humans can develop dermatitis and irritation from the latex.

References:

Kingsbury, J. M. 1964. Poisonous plants of the United States and Canada. Prentice-Hall Inc., Englewood Cliffs, N.J., USA. 626 pp.

Nomenclature:

Scientific Name: *Euphorbia esula* L.

Vernacular name(s): leafy spurge

Scientific family name: *Euphorbiaceae*

Vernacular family name: spurge

Go to ITIS^{*ca} for more taxonomic information on: [Euphorbia esula](#)

References:

Agriculture Quebec. 1975. Noms des maladies des plantes du Canada/ Names of plant diseases in Canada. , Quebec City, Que., Canada. 288 pp.

Alex, J. F., Cayouette, R., Mulligan, G. A. 1980. Common and botanical names of weeds in Canada/Noms populaire et scientifiques des plantes nuisibles du Canada. Revised. Agric. Can. Publ., Ottawa, Ont., Canada. 132 pp.

Bailey, L. H., Bailey, E. Z. 1976. Hortus third. Revised. MacMillan, New York, N.Y., USA. 1290 pp.

Scoggan, H. J. 1978, 1979. The flora of Canada. Nat. Mus. Nat. Sci. (Ottawa) Publ. Bot. 7(1)-7(4). 1711 pp.

Van Wijk, H. L. 1911. A dictionary of plant names. Martinus Nijhoff, The Hague, The Netherlands. 1444 pp.

Victorin, M. 1964. Flore Laurentienne. 2nd ed. Univ. Montreal, Montreal, Que., Canada. 952 pp.

Geographic Information

Alberta
British Columbia
Manitoba
Nova Scotia
Ontario
Prince Edward Island
Quebec
Saskatchewan

References:

Bailey, L. H., Bailey, E. Z. 1976. Hortus third. Revised. MacMillan, New York, N.Y., USA. 1290 pp.

Boivin, B. 1966, 1967. Énumération des plantes du Canada. Provencheria 6. Nat. Can. (Que.) 93: 253-274; 371-437; 583-646; 989-1063. 94: 131-157; 471-528; 625-655.

Image or illustration

Euphorbia esula:

Images: images.google.com

Toxic parts:

latex

References:

Seip, E. H., Hecker, E. 1982. Skin irritant ingenol esters from *Euphorbia esula*. Planta Med., 46: 215-218.

Notes on Toxic plant chemicals:

Seip and Hecker (1982) found ingenol derivatives, which are

diterpenes, to be the irritant factors in leafy spurge. Some of the chemicals were weak tumor promoters.

Toxic plant chemicals:

5-deoxyingenol

References:

Seip, E. H., Hecker, E. 1982. Skin irritant ingenol esters from *Euphorbia esula*. *Planta Med.*, 46: 215-218.

Animals/Human Poisoning:

Note: When an animal is listed without additional information, the literature (as of 1993) contained no detailed explanation.

Cattle

Horses

Humans

Sheep

General symptoms of poisoning:

[blistering](#)

[death](#)

References:

Kingsbury, J. M. 1964. *Poisonous plants of the United States and Canada*. Prentice-Hall Inc., Englewood Cliffs, N.J., USA. 626 pp.

[Another search?](#)

[Français](#) | [Contact Us](#) | [Help](#) | [Search](#) | [Canada site](#)

[Coming Events](#) | [About CBIF](#) | [Links](#) | [Reports and Publications](#) |

[Home](#)

Date modified: 2003-02-06

[Important Notices](#)



Français	Contact us	Help	Search	Canada site
Coming events	About CBIF	Links	Reports and publications	Home

Canadian Biodiversity Information Facility



Notes on poisoning: *Euphorbia helioscopia*

[Introduction](#)[Interactive](#)[All poisonous plants by Botanical name](#)[All poisonous plants by Common name](#)[Important WWW Poisonous Plants sites](#)

General poisoning notes:

Sun spurge (*Euphorbia helioscopia*) is a naturalized herb occasionally found in southern Canada. The latex contains a strong irritant that causes burning and swelling in animals that ingest it. Sheep were poisoned and a human child died after ingesting the plant. This plant can cause irritation to livestock that ingestion it.



References:

Cooper, M. R., Johnson, A. W. 1984. Poisonous plants in Britain and their effects on animals and man. Her Majesty's Stationery Office, London, England. 305 pp.

Nomenclature:

Scientific Name: *Euphorbia helioscopia* L.

Vernacular name(s): sun spurge

Scientific family name: *Euphorbiaceae*

Vernacular family name: spurge

Go to ITIS*^{ca} for more taxonomic information on: [Euphorbia helioscopia](#)

References:

Agriculture Quebec. 1975. Noms des maladies des plantes du Canada/ Names of plant diseases in Canada. , Quebec City, Que., Canada. 288 pp.

Alex, J. F., Cayouette, R., Mulligan, G. A. 1980. Common and botanical names of weeds in Canada/Noms populaire et scientifiques des plantes nuisibles du Canada. Revised. Agric.

Can. Publ., Ottawa, Ont., Canada. 132 pp.

Bailey, L. H., Bailey, E. Z. 1976. Hortus third. Revised. MacMillan, New York, N.Y., USA. 1290 pp.

Scoggan, H. J. 1978, 1979. The flora of Canada. Nat. Mus. Nat. Sci. (Ottawa) Publ. Bot. 7(1)-7(4). 1711 pp.

Van Wijk, H. L. 1911. A dictionary of plant names. Martinus Nijhoff, The Hague, The Netherlands. 1444 pp.

Victorin, M. 1964. Flore Laurentienne. 2nd ed. Univ. Montreal, Montreal, Que., Canada. 952 pp.

Geographic Information

Plant or plant parts used in or around the home.

References:

Bailey, L. H., Bailey, E. Z. 1976. Hortus third. Revised. MacMillan, New York, N.Y., USA. 1290 pp.

Boivin, B. 1966, 1967. Énumération des plantes du Canada. Provencheria 6. Nat. Can. (Que.) 93: 253-274; 371-437; 583-646; 989-1063. 94: 131-157; 471-528; 625-655.

Image or illustration

Euphorbia helioscopia:

Images: images.google.com

Toxic parts:

latex

References:

Cooper, M. R., Johnson, A. W. 1984. Poisonous plants in Britain and their effects on animals and man. Her Majesty's Stationery Office, London, England. 305 pp.

Toxic plant chemicals:

12-deoxyphorbol

References:

Cooper, M. R., Johnson, A. W. 1984. Poisonous plants in Britain and their effects on animals and man. Her Majesty's Stationery

Office, London, England. 305 pp.

Frohne, D., Pfander, H. J. 1983. A colour atlas of poisonous plants. Wolfe Publishing Ltd., London, England. 291 pp.

Animals/Human Poisoning:

Note: When an animal is listed without additional information, the literature (as of 1993) contained no detailed explanation.

Humans

Sheep

General symptoms of poisoning:

[abdominal pains](#)

[coma](#)

[death](#)

[diarrhea](#)

[lungs, congestion of](#)

[mouth, irritation of](#)

[salivation](#)

[vomiting](#)

Notes on poisoning:

In Britain, sheep that had ingested sun spurge experienced severe swelling and inflammation of the mouth, diarrhea, and salivation. The animals recovered fully when moved to new pasture that did not contain this plant (Cooper and Johnson 1984). One of two children died after sucking the juice of sun spurge. Symptoms included burning of the mouth, esophagus, and stomach, salivation, vomiting, narrowing of the pupils, and lung edema. One child went into a coma before death (Cooper and Johnson 1984).

References:

Cooper, M. R., Johnson, A. W. 1984. Poisonous plants in Britain and their effects on animals and man. Her Majesty's Stationery Office, London, England. 305 pp.

[Another search?](#)

[Français](#) | [Contact Us](#) | [Help](#) | [Search](#) | [Canada site](#)

[Coming Events](#) | [About CBIF](#) | [Links](#) | [Reports and Publications](#) |

[Home](#)

Date modified: 2003-02-06

[Important Notices](#)



Français	Contact us	Help	Search	Canada site
Coming events	About CBIF	Links	Reports and publications	Home

Canadian Biodiversity Information Facility



Notes on poisoning: *Euphorbia lactea*

[Introduction](#)[Interactive](#)[All poisonous plants by Botanical name](#)[All poisonous plants by Common name](#)[Important WWW Poisonous Plants sites](#)

General poisoning notes:

Candelabra-cactus (*Euphorbia lactea*) is an indoor ornamental plant. The latex (juice) of the plant contains an intense irritant that causes problems when the latex comes in contact with mucous membranes and eyes. Severe eye problems have also been experimentally produced in dogs. Ingestion should be avoided by children and family pets.

References:

Crowder, J. I., Sexton, R. R. 1964. Keratoconjunctivitis resulting from the sap of candelabra cactus and the pencil tree. Arch. Ophthalmol., 72: 476-484.

Nomenclature:

Scientific Name: *Euphorbia lactea* Haw.

Vernacular name(s): candelabra-cactus

Scientific family name: *Euphorbiaceae*

Vernacular family name: spurge

Go to ITIS^{*ca} for more taxonomic information on: [Euphorbia lactea](#)

References:

Agriculture Quebec. 1975. Noms des maladies des plantes du Canada/ Names of plant diseases in Canada. , Quebec City, Que., Canada. 288 pp.

Alex, J. F., Cayouette, R., Mulligan, G. A. 1980. Common and botanical names of weeds in Canada/Noms populaire et scientifiques des plantes nuisibles du Canada. Revised. Agric.

Can. Publ., Ottawa, Ont., Canada. 132 pp.

Bailey, L. H., Bailey, E. Z. 1976. Hortus third. Revised. MacMillan, New York, N.Y., USA. 1290 pp.

Scoggan, H. J. 1978, 1979. The flora of Canada. Nat. Mus. Nat. Sci. (Ottawa) Publ. Bot. 7(1)-7(4). 1711 pp.

Van Wijk, H. L. 1911. A dictionary of plant names. Martinus Nijhoff, The Hague, The Netherlands. 1444 pp.

Victorin, M. 1964. Flore Laurentienne. 2nd ed. Univ. Montreal, Montreal, Que., Canada. 952 pp.

Geographic Information

Plant or plant parts used in or around the home.

References:

Bailey, L. H., Bailey, E. Z. 1976. Hortus third. Revised. MacMillan, New York, N.Y., USA. 1290 pp.

Boivin, B. 1966, 1967. Énumération des plantes du Canada. Provencheria 6. Nat. Can. (Que.) 93: 253-274; 371-437; 583-646; 989-1063. 94: 131-157; 471-528; 625-655.

Image or illustration

Euphorbia lactea:

Images: images.google.com

Toxic parts:

latex

References:

Crowder, J. I., Sexton, R. R. 1964. Keratoconjunctivitis resulting from the sap of candelabra cactus and the pencil tree. Arch. Ophthalmol., 72: 476-484.

Animals/Human Poisoning:

Note: When an animal is listed without additional information, the literature (as of 1993) contained no detailed explanation.

Humans

General symptoms of poisoning:

[keratoconjunctivitis](#)

Notes on poisoning:

The milky sap of candelabra-cactus contains an irritant that can cause intense burning and keratoconjunctivitis if a drop gets into the eyes. In one case, a man felt intense pain in his eye followed by mild conjunctival hyperemia and punctate staining of the cornea. Within 24 h the patient had copious mucous discharge, marked conjunctival edema, swollen lids, and severe pain in the eye. A few days later the eye began to heal, with complete recovery after a couple of weeks. Experiments on dogs resulted in similar symptoms, with eventual clearing of the eyes (Crowder and Sexton 1964).

References:

Crowder, J. I., Sexton, R. R. 1964. Keratoconjunctivitis resulting from the sap of candelabra cactus and the pencil tree. Arch. Ophthalmol., 72: 476-484.

[Another search?](#)

[Français](#) | [Contact Us](#) | [Help](#) | [Search](#) | [Canada site](#)

[Coming Events](#) | [About CBIF](#) | [Links](#) | [Reports and Publications](#) | [Home](#)

Date modified: 2003-02-06

[Important Notices](#)



Français	Contact us	Help	Search	Canada site
Coming events	About CBIF	Links	Reports and publications	Home

Canadian Biodiversity Information Facility



Notes on poisoning: *Euphorbia lathyris*

[Introduction](#)[Interactive](#)[All poisonous plants by Botanical name](#)[All poisonous plants by Common name](#)[Important WWW Poisonous Plants sites](#)

General poisoning notes:

Caper spurge (*Euphorbia lathyris*) is an outdoor ornamental that has become naturalized in British Columbia. This plant contains an irritant toxin in the latex. Humans have been poisoned after ingesting the seed capsules, which resemble capers, a different plant. Goats apparently eat this plant without experiencing great problems, but the toxin can accumulate and can be passed through the milk (Fuller and McClintock 1986).

References:

Cooper, M. R., Johnson, A. W. 1984. Poisonous plants in Britain and their effects on animals and man. Her Majesty's Stationery Office, London, England. 305 pp.

Fuller, T. C., McClintock, E. 1986. Poisonous plants of California. Univ. California Press, Berkeley, Calif., USA. 432 pp.

Nomenclature:

Scientific Name: *Euphorbia lathyris* L.

Vernacular name(s): caper spurge

Scientific family name: *Euphorbiaceae*

Vernacular family name: spurge

Go to ITIS^{*ca} for more taxonomic information on: [Euphorbia lathyris](#)

References:

Agriculture Quebec. 1975. Noms des maladies des plantes du Canada/ Names of plant diseases in Canada. , Quebec City, Que., Canada. 288 pp.

Alex, J. F., Cayouette, R., Mulligan, G. A. 1980. Common and botanical names of weeds in Canada/Noms populaire et scientifiques des plantes nuisibles du Canada. Revised. Agric. Can. Publ., Ottawa, Ont., Canada. 132 pp.

Bailey, L. H., Bailey, E. Z. 1976. Hortus third. Revised. MacMillan, New York, N.Y., USA. 1290 pp.

Scoggan, H. J. 1978, 1979. The flora of Canada. Nat. Mus. Nat. Sci. (Ottawa) Publ. Bot. 7(1)-7(4). 1711 pp.

Van Wijk, H. L. 1911. A dictionary of plant names. Martinus Nijhoff, The Hague, The Netherlands. 1444 pp.

Victorin, M. 1964. Flore Laurentienne. 2nd ed. Univ. Montreal, Montreal, Que., Canada. 952 pp.

Geographic Information

British Columbia

References:

Bailey, L. H., Bailey, E. Z. 1976. Hortus third. Revised. MacMillan, New York, N.Y., USA. 1290 pp.

Boivin, B. 1966, 1967. Énumération des plantes du Canada. Provencheria 6. Nat. Can. (Que.) 93: 253-274; 371-437; 583-646; 989-1063. 94: 131-157; 471-528; 625-655.

Image or illustration

Euphorbia lathyris:

Images: images.google.com

Toxic parts:

latex

References:

Cooper, M. R., Johnson, A. W. 1984. Poisonous plants in Britain and their effects on animals and man. Her Majesty's Stationery Office, London, England. 305 pp.

Notes on Toxic plant chemicals:

Caper spurge contains unidentified ingenol derivatives that are toxic diterpenes. The activity of the toxins are not affected by

drying or storage (Frohne and Pfander 1983, Cooper and Johnson 1984).

Toxic plant chemicals:

5-deoxyingenol

References:

Cooper, M. R., Johnson, A. W. 1984. Poisonous plants in Britain and their effects on animals and man. Her Majesty's Stationery Office, London, England. 305 pp.

Frohne, D., Pfander, H. J. 1983. A colour atlas of poisonous plants. Wolfe Publishing Ltd., London, England. 291 pp.

Animals/Human Poisoning:

Note: When an animal is listed without additional information, the literature (as of 1993) contained no detailed explanation.

Goats

Humans

General symptoms of poisoning:

[abdominal pains](#)

[diarrhea](#)

[vomiting](#)

Notes on poisoning:

Caper spurge has seed capsules that resemble true capers. In Europe, adults were poisoned when they mistakenly ingested caper spurge. They experienced intense burning of the mouth and stomach, abdominal pains, diarrhea, and eventual recovery. The latex is corrosive and causes skin irritation (Cooper and Johnson 1984, Fuller and McClintock 1986).

References:

Cooper, M. R., Johnson, A. W. 1984. Poisonous plants in Britain and their effects on animals and man. Her Majesty's Stationery Office, London, England. 305 pp.

Fuller, T. C., McClintock, E. 1986. Poisonous plants of California. Univ. California Press, Berkeley, Calif., USA. 432 pp.

[Another search?](#)

[Français](#) | [Contact Us](#) | [Help](#) | [Search](#) | [Canada site](#)
[Coming Events](#) | [About CBIF](#) | [Links](#) | [Reports and Publications](#) |
[Home](#)

Date modified: 2003-02-06

[Important Notices](#)



Français	Contact us	Help	Search	Canada site
Coming events	About CBIF	Links	Reports and publications	Home

Canadian Biodiversity Information Facility



Notes on poisoning: *Euphorbia milii*

[Introduction](#)[Interactive](#)[All poisonous plants by Botanical name](#)[All poisonous plants by Common name](#)[Important WWW Poisonous Plants sites](#)

General poisoning notes:

Crown-of-thorns (*Euphorbia milii*) is an indoor ornamental plant. The plant contains caustic and irritant chemicals in the latex. This plant should not be ingested nor should the juice be rubbed on the skin or in the eyes. Family pets should not be allowed to ingest this plant.



References:

- Fuller, T. C., McClintock, E. 1986. Poisonous plants of California. Univ. California Press, Berkeley, Calif., USA. 432 pp.
- Kingsbury, J. M. 1964. Poisonous plants of the United States and Canada. Prentice-Hall Inc., Englewood Cliffs, N.J., USA. 626 pp.

Nomenclature:

Scientific Name: *Euphorbia milii* Ch. des Moulins

Vernacular name(s): crown-of-thorns

Scientific family name: *Euphorbiaceae*

Vernacular family name: spurge

Go to ITIS^{*ca} for more taxonomic information on: [Euphorbia milii](#)

References:

- Agriculture Quebec. 1975. Noms des maladies des plantes du Canada/ Names of plant diseases in Canada. , Quebec City, Que., Canada. 288 pp.
- Alex, J. F., Cayouette, R., Mulligan, G. A. 1980. Common and botanical names of weeds in Canada/Noms populaire et

scientifiques des plantes nuisibles du Canada. Revised. Agric. Can. Publ., Ottawa, Ont., Canada. 132 pp.

Bailey, L. H., Bailey, E. Z. 1976. Hortus third. Revised. MacMillan, New York, N.Y., USA. 1290 pp.

Scoggan, H. J. 1978, 1979. The flora of Canada. Nat. Mus. Nat. Sci. (Ottawa) Publ. Bot. 7(1)-7(4). 1711 pp.

Van Wijk, H. L. 1911. A dictionary of plant names. Martinus Nijhoff, The Hague, The Netherlands. 1444 pp.

Victorin, M. 1964. Flore Laurentienne. 2nd ed. Univ. Montreal, Montreal, Que., Canada. 952 pp.

Geographic Information

Plant or plant parts used in or around the home.

References:

Bailey, L. H., Bailey, E. Z. 1976. Hortus third. Revised. MacMillan, New York, N.Y., USA. 1290 pp.

Boivin, B. 1966, 1967. Énumération des plantes du Canada. Provencheria 6. Nat. Can. (Que.) 93: 253-274; 371-437; 583-646; 989-1063. 94: 131-157; 471-528; 625-655.

Image or illustration

Euphorbia milii:

Images: images.google.com

Toxic parts:

latex

References:

Frohne, D., Pfander, H. J. 1983. A colour atlas of poisonous plants. Wolfe Publishing Ltd., London, England. 291 pp.

Notes on Toxic plant chemicals:

Unknown ingenol derivatives of toxic diterpenes are found in the latex of crown-of-thorns and have irritant properties (Frohne and Pfander 1983).

Toxic plant chemicals:

5-deoxyingenol

References:

Frohne, D., Pfander, H. J. 1983. A colour atlas of poisonous plants. Wolfe Publishing Ltd., London, England. 291 pp.

Animals/Human Poisoning:

Note: When an animal is listed without additional information, the literature (as of 1993) contained no detailed explanation.

Humans

General symptoms of poisoning:

[abdominal pains](#)

[blistering](#)

[mouth, irritation of](#)

Notes on poisoning:

Crown-of-thorns contains an irritant in the latex that causes skin irritation and problems on mucous membranes and eye tissue. Ingestion can cause irritation of the mouth and stomach, and abdominal pains (Fuller and McClintock 1986).

References:

Fuller, T. C., McClintock, E. 1986. Poisonous plants of California. Univ. California Press, Berkeley, Calif., USA. 432 pp.

Kingsbury, J. M. 1964. Poisonous plants of the United States and Canada. Prentice-Hall Inc., Englewood Cliffs, N.J., USA. 626 pp.

[Another search?](#)

[Français](#) | [Contact Us](#) | [Help](#) | [Search](#) | [Canada site](#)

[Coming Events](#) | [About CBIF](#) | [Links](#) | [Reports and Publications](#) |

[Home](#)

Date modified: 2003-02-06

[Important Notices](#)



Français	Contact us	Help	Search	Canada site
Coming events	About CBIF	Links	Reports and publications	Home

Canadian Biodiversity Information Facility



Notes on poisoning: *Euphorbia peplus*

[Introduction](#)[Interactive](#)[All poisonous plants by Botanical name](#)[All poisonous plants by Common name](#)[Important WWW Poisonous Plants sites](#)

General poisoning notes:

Petty spurge (*Euphorbia peplus*) is a naturalized herb found across Canada. This plant contains a caustic and irritant chemical in the latex, which causes burning and inflammation of skin and eyes. Ingestion results in complications. Family pets should not be allowed to ingest this plant. Experimental poisoning occurred in a calf that was fed petty spurge (Kingsbury 1964).

References:

- Fuller, T. C., McClintock, E. 1986. Poisonous plants of California. Univ. California Press, Berkeley, Calif., USA. 432 pp.
- Kingsbury, J. M. 1964. Poisonous plants of the United States and Canada. Prentice-Hall Inc., Englewood Cliffs, N.J., USA. 626 pp.

Nomenclature:

Scientific Name: *Euphorbia peplus* L.

Vernacular name(s): petty spurge

Scientific family name: *Euphorbiaceae*

Vernacular family name: spurge

Go to ITIS^{*ca} for more taxonomic information on: [Euphorbia peplus](#)

References:

Agriculture Quebec. 1975. Noms des maladies des plantes du Canada/ Names of plant diseases in Canada. , Quebec City, Que., Canada. 288 pp.

Alex, J. F., Cayouette, R., Mulligan, G. A. 1980. Common and

botanical names of weeds in Canada/Noms populaire et scientifiques des plantes nuisibles du Canada. Revised. Agric. Can. Publ., Ottawa, Ont., Canada. 132 pp.

Bailey, L. H., Bailey, E. Z. 1976. Hortus third. Revised. MacMillan, New York, N.Y., USA. 1290 pp.

Scoggan, H. J. 1978, 1979. The flora of Canada. Nat. Mus. Nat. Sci. (Ottawa) Publ. Bot. 7(1)-7(4). 1711 pp.

Van Wijk, H. L. 1911. A dictionary of plant names. Martinus Nijhoff, The Hague, The Netherlands. 1444 pp.

Victorin, M. 1964. Flore Laurentienne. 2nd ed. Univ. Montreal, Montreal, Que., Canada. 952 pp.

Geographic Information

British Columbia
Manitoba
New Brunswick
Newfoundland
Nova Scotia
Ontario
Prince Edward Island
Quebec
Saskatchewan

References:

Bailey, L. H., Bailey, E. Z. 1976. Hortus third. Revised. MacMillan, New York, N.Y., USA. 1290 pp.

Boivin, B. 1966, 1967. Énumération des plantes du Canada. Provencheria 6. Nat. Can. (Que.) 93: 253-274; 371-437; 583-646; 989-1063. 94: 131-157; 471-528; 625-655.

Image or illustration

Euphorbia peplus:

Images: images.google.com

Toxic parts:

latex

References:

Fuller, T. C., McClintock, E. 1986. Poisonous plants of California. Univ. California Press, Berkeley, Calif., USA. 432 pp.

Notes on Toxic plant chemicals:

Petty spurge contains a toxic diterpene, 5-deoxyingenol, as well as ingenol (Frohne and Pfander 1983).

Toxic plant chemicals:

5-deoxyingenol

References:

Frohne, D., Pfander, H. J. 1983. A colour atlas of poisonous plants. Wolfe Publishing Ltd., London, England. 291 pp.

Animals/Human Poisoning:

Note: When an animal is listed without additional information, the literature (as of 1993) contained no detailed explanation.

Cattle

General symptoms of poisoning:

[salivation](#)

Notes on poisoning:

Experimental feeding of petty spurge caused blood-stained feces and excessive salivation in a calf (Kingsbury 1964).

References:

Kingsbury, J. M. 1964. Poisonous plants of the United States and Canada. Prentice-Hall Inc., Englewood Cliffs, N.J., USA. 626 pp.

Humans

General symptoms of poisoning:

[eye, discharge of](#)
[mouth, irritation of](#)

Notes on poisoning:

Skin and mucous membrane irritation result from contact with the latex. Severe eye irritation also occurs (Fuller and McClintock 1986).

References:

Fuller, T. C., McClintock, E. 1986. Poisonous plants of California. Univ. California Press, Berkeley, Calif., USA. 432 pp.

[Another search?](#)

[Français](#) | [Contact Us](#) | [Help](#) | [Search](#) | [Canada site](#)

[Coming Events](#) | [About CBIF](#) | [Links](#) | [Reports and Publications](#) | [Home](#)

Date modified: 2003-02-06

[Important Notices](#)



Français	Contact us	Help	Search	Canada site
Coming events	About CBIF	Links	Reports and publications	Home

Canadian Biodiversity Information Facility



Notes on poisoning: *Euphorbia pulcherrima*

[Introduction](#)[Interactive](#)[All poisonous plants by Botanical name](#)[All poisonous plants by Common name](#)[Important WWW Poisonous Plants sites](#)

General poisoning notes:

Poinsettia (*Euphorbia pulcherrima*) is a popular Christmas plant grown for its red leafy bracts. It has been listed as a known toxic plant that has caused a loss of human life. The case cited in all literature is based on the death of a child in Hawaii who ingested a leaf of poinsettia. The author of that report said that the incident was based on hearsay (Stone and Collins 1971). Various studies have not found any of the toxic diterpenes that occur in the latex of other spurges (*Euphorbia* spp.). Extensive studies on rats that were fed "extraordinarily" high doses of poinsettia showed no mortality, no symptoms of toxicity, and no changes in normal behaviour (Stone and Collins 1971). Klug et al. (1990) reviewed 353 calls to poison control centres and found that nausea and vomiting were cited in 0.02% of the cases with rash and sneezing cited in 0.0028%. An older dog that ingested poinsettia reportedly experienced protracted vomiting, followed by renal failure, coma, and death. This is the only case in the literature of death to an animal. Case histories show that some humans develop a sensitivity to the latex, resulting in dermatitis. Short exposures to poinsettia in a few cases have led to bouts of vomiting, but no substantiated cases of death can be found in the literature. Poinsettia should no longer be regarded as a severely toxic plant.

References:

- Klug, S., Saleem, G., Hocharuk, L., Marcus, S. 1990. Toxicity potential of poinsettia, is the plant really toxic? *Vet. Hum. Toxicol.*, 32: 368.
- Santucci, B., Picardo, M., Cristaudo, A. 1985. Contact dermatitis from *Euphorbia pulcherrima*. *Contact Dermatitis*, 12: 285-286.
- Spoerke, D. G., Smolinske, S. C. 1990. Toxicity of houseplants. CRC Press, Inc., Boca Raton, Fla., USA. 335 pp.
- Stone, R. P., Collins, W. J. 1971. *Euphorbia pulcherrima*:

toxicity to rats. *Toxicon*, 9: 301-302.

Nomenclature:

Scientific Name: *Euphorbia pulcherrima* Willd. ex Klotzsch

Vernacular name(s): poinsettia

Scientific family name: *Euphorbiaceae*

Vernacular family name: spurge

Go to ITIS^{*ca} for more taxonomic information on: [Euphorbia pulcherrima](#)

References:

Agriculture Quebec. 1975. Noms des maladies des plantes du Canada/ Names of plant diseases in Canada. , Quebec City, Que., Canada. 288 pp.

Alex, J. F., Cayouette, R., Mulligan, G. A. 1980. Common and botanical names of weeds in Canada/Noms populaire et scientifiques des plantes nuisibles du Canada. Revised. Agric. Can. Publ., Ottawa, Ont., Canada. 132 pp.

Bailey, L. H., Bailey, E. Z. 1976. Hortus third. Revised. MacMillan, New York, N.Y., USA. 1290 pp.

Scoggan, H. J. 1978, 1979. The flora of Canada. Nat. Mus. Nat. Sci. (Ottawa) Publ. Bot. 7(1)-7(4). 1711 pp.

Van Wijk, H. L. 1911. A dictionary of plant names. Martinus Nijhoff, The Hague, The Netherlands. 1444 pp.

Victorin, M. 1964. Flore Laurentienne. 2nd ed. Univ. Montreal, Montreal, Que., Canada. 952 pp.

Geographic Information

Plant or plant parts used in or around the home.

References:

Bailey, L. H., Bailey, E. Z. 1976. Hortus third. Revised. MacMillan, New York, N.Y., USA. 1290 pp.

Boivin, B. 1966, 1967. Énumération des plantes du Canada. Provencheria 6. Nat. Can. (Que.) 93: 253-274; 371-437; 583-646; 989-1063. 94: 131-157; 471-528; 625-655.

Image or illustration

Euphorbia pulcherrima:

Images: images.google.com

Notes on Poisonous plant parts:

A few people have a positive reaction to the latex and to aqueous extracts of plant material (Santucci et al. 1985).

Toxic parts:

latex
leaves
stems

References:

Santucci, B., Picardo, M., Cristaudo, A. 1985. Contact dermatitis from *Euphorbia pulcherrima*. Contact Dermatitis, 12: 285-286.

Notes on Toxic plant chemicals:

The latex does not contain any diterpenes. The plant contains an unidentified chemical, which causes dermatitis in a few sensitive individuals (Santucci et al. 1985).

Toxic plant chemicals:

unknown chemical

References:

Santucci, B., Picardo, M., Cristaudo, A. 1985. Contact dermatitis from *Euphorbia pulcherrima*. Contact Dermatitis, 12: 285-286.

Animals/Human Poisoning:

Note: When an animal is listed without additional information, the literature (as of 1993) contained no detailed explanation.

Dogs

General symptoms of poisoning:

[coma](#)

[death](#)

[kidney failure](#)

[vomiting](#)

References:

Klug, S., Saleem, G., Hocharuk, L., Marcus, S. 1990. Toxicity potential of poinsettia, is the plant really toxic? Vet. Hum. Toxicol., 32: 368.

Humans

General symptoms of poisoning:

[eczema](#)

[nausea](#)

[vomiting](#)

Notes on poisoning:

The most severe symptoms of poinsettia ingestion substantiated in the literature are a few cases of nausea and vomiting, with an occasional rash (Klug et al. 1990).

References:

Klug, S., Saleem, G., Hocharuk, L., Marcus, S. 1990. Toxicity potential of poinsettia, is the plant really toxic? Vet. Hum. Toxicol., 32: 368.

Santucci, B., Picardo, M., Cristaudo, A. 1985. Contact dermatitis from *Euphorbia pulcherrima*. Contact Dermatitis, 12: 285-286.

Rodents

[Another search?](#)

[Français](#) | [Contact Us](#) | [Help](#) | [Search](#) | [Canada site](#)

[Coming Events](#) | [About CBIF](#) | [Links](#) | [Reports and Publications](#) | [Home](#)

Date modified: 2003-02-06

[Important Notices](#)



Français	Contact us	Help	Search	Canada site
Coming events	About CBIF	Links	Reports and publications	Home

Canadian Biodiversity Information Facility



Notes on poisoning: *Euphorbia tirucalli*

[Introduction](#)

[Interactive](#)

[All poisonous plants by Botanical name](#)

[All poisonous plants by Common name](#)

[Important WWW Poisonous Plants sites](#)



General poisoning notes:

Penciltree (*Euphorbia tirucalli*) is an attractive indoor ornamental tree. The plant contains caustic and irritant chemicals in the latex which cause reactions with the skin, mucous membranes, and the eyes. Severe burning and inflammation result after the latex comes into contact with the skin. Ingestion causes burning and irritation of the mouth and stomach, accompanied by pain and perhaps diarrhea. Apparently, injudicious medicinal use of the latex of this plant has caused fatalities in East Africa (Fuller and McClintock 1986). Family pets should not be allowed to ingest the plant.

References:

Crowder, J. I., Sexton, R. R. 1964. Keratoconjunctivitis resulting from the sap of candelabra cactus and the pencil tree. Arch. Ophthalmol., 72: 476-484.

Fuller, T. C., McClintock, E. 1986. Poisonous plants of California. Univ. California Press, Berkeley, Calif., USA. 432 pp.

Nomenclature:

Scientific Name: *Euphorbia tirucalli* L.

Vernacular name(s): penciltree

Scientific family name: *Euphorbiaceae*

Vernacular family name: spurge

Go to ITIS^{*ca} for more taxonomic information on: [Euphorbia tirucalli](#)

References:

Agriculture Quebec. 1975. Noms des maladies des plantes du Canada/ Names of plant diseases in Canada. , Quebec City, Que., Canada. 288 pp.

Alex, J. F., Cayouette, R., Mulligan, G. A. 1980. Common and botanical names of weeds in Canada/Noms populaire et scientifiques des plantes nuisibles du Canada. Revised. Agric. Can. Publ., Ottawa, Ont., Canada. 132 pp.

Bailey, L. H., Bailey, E. Z. 1976. Hortus third. Revised. MacMillan, New York, N.Y., USA. 1290 pp.

Scoggan, H. J. 1978, 1979. The flora of Canada. Nat. Mus. Nat. Sci. (Ottawa) Publ. Bot. 7(1)-7(4). 1711 pp.

Van Wijk, H. L. 1911. A dictionary of plant names. Martinus Nijhoff, The Hague, The Netherlands. 1444 pp.

Victorin, M. 1964. Flore Laurentienne. 2nd ed. Univ. Montreal, Montreal, Que., Canada. 952 pp.

Geographic Information

Plant or plant parts used in or around the home.

References:

Bailey, L. H., Bailey, E. Z. 1976. Hortus third. Revised. MacMillan, New York, N.Y., USA. 1290 pp.

Boivin, B. 1966, 1967. Énumération des plantes du Canada. Provencheria 6. Nat. Can. (Que.) 93: 253-274; 371-437; 583-646; 989-1063. 94: 131-157; 471-528; 625-655.

Image or illustration

Euphorbia tirucalli:

Images: images.google.com

Toxic parts:

latex

References:

Fürstenberger, G., Hecker, E. 1986. On the active principles of the Euphorbiaceae, XII. Highly unsaturated irritant diterpene esters from *Euphorbia tirucalli* originating from Madagascar. J. Nat. Prod. (Lloydia), 49: 386-397.

Notes on Toxic plant chemicals:

Toxic ingenol and 4-deoxyingenol are diterpenes that have been isolated from the latex of pencil tree (Frohne and Pfander 1983; Fürstenberger and Hecker 1986).

Toxic plant chemicals:

4-deoxyingenol

References:

Fürstenberger, G., Hecker, E. 1986. On the active principles of the Euphorbiaceae, XII. Highly unsaturated irritant diterpene esters from *Euphorbia tirucalli* originating from Madagascar. J. Nat. Prod. (Lloydia), 49: 386-397.

Animals/Human Poisoning:

Note: When an animal is listed without additional information, the literature (as of 1993) contained no detailed explanation.

Humans

General symptoms of poisoning:

[blindness, temporary](#)
[keratoconjunctivitis](#)

Notes on poisoning:

Pencil tree latex causes keratoconjunctivitis if it gets into the eyes. The symptoms include immediate burning pain of the eyeball and eyelids, tearing, and photophobia. These symptoms are followed by 8-12 h of chemosis of the lids and conjunctiva, with blurred vision and increased pain. Erosion of the corneal epithelium, decreased visual acuity, and corneal edema occur (Crowder and Sexton 1964).

References:

Crowder, J. I., Sexton, R. R. 1964. Keratoconjunctivitis resulting from the sap of candelabra cactus and the pencil tree. Arch. Ophthalmol., 72: 476-484.

[Another search?](#)

[Français](#) | [Contact Us](#) | [Help](#) | [Search](#) | [Canada site](#)
[Coming Events](#) | [About CBIF](#) | [Links](#) | [Reports and Publications](#) |
[Home](#)

Date modified: 2003-02-06

[Important Notices](#)



Français	Contact us	Help	Search	Canada site
Coming events	About CBIF	Links	Reports and publications	Home

Canadian Biodiversity Information Facility



Notes on poisoning: *Fagopyrum esculentum*

[Introduction](#)[Interactive](#)[All poisonous plants by Botanical name](#)[All poisonous plants by Common name](#)[Important WWW Poisonous Plants sites](#)

General poisoning notes:

Buckwheat (*Fagopyrum esculentum*) is cultivated in Canada as a crop for fodder and for the production of buckwheat honey.

Ingesting entire plants, dried or fresh, has caused photosensitization in animals with exposed or light-colored skin including cattle, goats, sheep, swine, and turkeys. Exposure to the sun is necessary. This plant is considered to be a primary photosensitizer, although jaundice has occurred concurrently, which indicates secondary involvement of the liver (Cooper and Johnson 1984, Cheeke and Schull 1985). Buckwheat has been found to be an effective replacement for wheat or barley in rations for swine (Anderson and Bowland 1981). Closely related tartary buckwheat (*Fagopyrum tataricum* L.) is also a satisfactory grain replacement in ruminant animals (Nicholson et al. 1976).

Humans can be sensitized to dust from buckwheat flour after long exposure. Asthma is the usual response, although rare individuals may manifest food allergy reactions after ingesting food products containing buckwheat flour. Photosensitization has not occurred in humans (Blumstein 1936).

References:

Anderson, D. M., Bowland, J. P. 1981. Evaluation of buckwheat (*Fagopyrum esculentum*) in diets of growing pigs. Proc. Am. Soc. Anim. Sci. West. Br., 32: 422-425.

Blumstein, G. I. 1936. Buckwheat sensitivity. J. Allergy, 7: 74-79.

Cheeke, P. R., Shull, L. R. 1985. Natural toxicants in feeds and poisonous plants. AVI Publishing Company, Inc., Westport, Conn., USA. 492 pp.

Cooper, M. R., Johnson, A. W. 1984. Poisonous plants in Britain and their effects on animals and man. Her Majesty's Stationery Office, London, England. 305 pp.

Nicholson, J. W., McQueen, R., Grant, E. A., Burgess, P. L. 1976. The feeding value of tartary buckwheat for ruminants. *Can. J. Anim. Sci.*, 56: 803-808.

Nomenclature:

Scientific Name: *Fagopyrum esculentum* Moench

Vernacular name(s): buckwheat

Scientific family name: *Polygonaceae*

Vernacular family name: buckwheat

Go to ITIS^{*ca} for more taxonomic information on: [Fagopyrum esculentum](#)

References:

Agriculture Quebec. 1975. Noms des maladies des plantes du Canada/ Names of plant diseases in Canada. , Quebec City, Que., Canada. 288 pp.

Alex, J. F., Cayouette, R., Mulligan, G. A. 1980. Common and botanical names of weeds in Canada/Noms populaire et scientifiques des plantes nuisibles du Canada. Revised. Agric. Can. Publ., Ottawa, Ont., Canada. 132 pp.

Bailey, L. H., Bailey, E. Z. 1976. Hortus third. Revised. MacMillan, New York, N.Y., USA. 1290 pp.

Scoggan, H. J. 1978, 1979. The flora of Canada. Nat. Mus. Nat. Sci. (Ottawa) Publ. Bot. 7(1)-7(4). 1711 pp.

Van Wijk, H. L. 1911. A dictionary of plant names. Martinus Nijhoff, The Hague, The Netherlands. 1444 pp.

Victorin, M. 1964. Flore Laurentienne. 2nd ed. Univ. Montreal, Montreal, Que., Canada. 952 pp.

Geographic Information

Plant or plant parts used in or around the home.

References:

Bailey, L. H., Bailey, E. Z. 1976. Hortus third. Revised. MacMillan, New York, N.Y., USA. 1290 pp.

Boivin, B. 1966, 1967. Énumération des plantes du Canada. Provencheria 6. *Nat. Can. (Que.)* 93: 253-274; 371-437; 583-646; 989-1063. 94: 131-157; 471-528; 625-655.

Image or illustration

Fagopyrum esculentum:

Images: images.google.com

Notes on Poisonous plant parts:

Little fagopyrin occurs in the seeds, but ingesting the entire plant, either green or dried, can cause serious photosensitization in livestock (Johnson 1989).

Toxic parts:

all parts
leaves
seeds
stems

References:

Johnson, A. E. 1983. Photosensitizing toxins from plants and their biologic effects. Pages 345-359 in Keeler, R. F., Tu, A. T., eds. Handbook of natural toxins. Vol. 1. Plant and Fungal toxins. Marcel Dekker, Inc., New York, N.Y., USA. 934 pp.

Notes on Toxic plant chemicals:

Fagopyrin, probably a derivative of naphthodianthrone, is closely related to hypericin, which is found in St. John's-wort (*[Hypericum perforatum](#)*). The absorption spectra of these chemicals is in the range of 540-610 nm (Johnson 1983).

Toxic plant chemicals:

fagopyrin

References:

Johnson, A. E. 1983. Photosensitizing toxins from plants and their biologic effects. Pages 345-359 in Keeler, R. F., Tu, A. T., eds. Handbook of natural toxins. Vol. 1. Plant and Fungal toxins. Marcel Dekker, Inc., New York, N.Y., USA. 934 pp.

Animals/Human Poisoning:

Note: When an animal is listed without additional information,

the literature (as of 1993) contained no detailed explanation.

Cattle

General symptoms of poisoning:

[recumbency](#)

[skin, peeling of](#)

[thirsty](#)

[weakness](#)

References:

Cooper, M. R., Johnson, A. W. 1984. Poisonous plants in Britain and their effects on animals and man. Her Majesty's Stationery Office, London, England. 305 pp.

Goats

General symptoms of poisoning:

[blistering](#)

[skin, peeling of](#)

References:

Cooper, M. R., Johnson, A. W. 1984. Poisonous plants in Britain and their effects on animals and man. Her Majesty's Stationery Office, London, England. 305 pp.

Humans

Sheep

General symptoms of poisoning:

[blistering](#)

[paralysis](#)

[recumbency](#)

[skin, peeling of](#)

References:

Cooper, M. R., Johnson, A. W. 1984. Poisonous plants in Britain and their effects on animals and man. Her Majesty's Stationery Office, London, England. 305 pp.

Swine

General symptoms of poisoning:

[blistering](#)
[skin, peeling of](#)

References:

Cooper, M. R., Johnson, A. W. 1984. Poisonous plants in Britain and their effects on animals and man. Her Majesty's Stationery Office, London, England. 305 pp.

Turkeys

General symptoms of poisoning:

[incoordination](#)
[skin, peeling of](#)

References:

Cooper, M. R., Johnson, A. W. 1984. Poisonous plants in Britain and their effects on animals and man. Her Majesty's Stationery Office, London, England. 305 pp.

[Another search?](#)

[Français](#) | [Contact Us](#) | [Help](#) | [Search](#) | [Canada site](#)

[Coming Events](#) | [About CBIF](#) | [Links](#) | [Reports and Publications](#) | [Home](#)

Date modified: 2003-02-06

[Important Notices](#)



Français	Contact us	Help	Search	Canada site
Coming events	About CBIF	Links	Reports and publications	Home

Canadian Biodiversity Information Facility



Notes on poisoning: *Galanthus nivalis*

[Introduction](#)

[Interactive](#)

[All poisonous plants by Botanical name](#)

[All poisonous plants by Common name](#)

[Important WWW Poisonous Plants sites](#)



General poisoning notes:

Snowdrop (*Galanthus nivalis*) is an outdoor ornamental spring flower. This plant contains the alkaloid lycorine, which can cause poisoning. Some individuals were poisoned after ingesting the bulbs as emergency food in Holland during World War II. Large amounts of bulbs need to be ingested to produce toxic reactions (Lampe and McCann 1985, Fuller and McClintock 1986).

References:

Frohne, D., Pfander, H. J. 1983. A colour atlas of poisonous plants. Wolfe Publishing Ltd., London, England. 291 pp.

Fuller, T. C., McClintock, E. 1986. Poisonous plants of California. Univ. California Press, Berkeley, Calif., USA. 432 pp.

Nomenclature:

Scientific Name: *Galanthus nivalis* L.

Vernacular name(s): snowdrop

Scientific family name: *Amaryllidaceae*

Vernacular family name: amaryllis

Go to ITIS^{*ca} for more taxonomic information on: [Galanthus nivalis](#)

References:

Agriculture Quebec. 1975. Noms des maladies des plantes du Canada/ Names of plant diseases in Canada. , Quebec City, Que., Canada. 288 pp.

Alex, J. F., Cayouette, R., Mulligan, G. A. 1980. Common and

botanical names of weeds in Canada/Noms populaire et scientifiques des plantes nuisibles du Canada. Revised. Agric. Can. Publ., Ottawa, Ont., Canada. 132 pp.

Bailey, L. H., Bailey, E. Z. 1976. Hortus third. Revised. MacMillan, New York, N.Y., USA. 1290 pp.

Scoggan, H. J. 1978, 1979. The flora of Canada. Nat. Mus. Nat. Sci. (Ottawa) Publ. Bot. 7(1)-7(4). 1711 pp.

Van Wijk, H. L. 1911. A dictionary of plant names. Martinus Nijhoff, The Hague, The Netherlands. 1444 pp.

Victorin, M. 1964. Flore Laurentienne. 2nd ed. Univ. Montreal, Montreal, Que., Canada. 952 pp.

Geographic Information

Plant or plant parts used in or around the home.

References:

Bailey, L. H., Bailey, E. Z. 1976. Hortus third. Revised. MacMillan, New York, N.Y., USA. 1290 pp.

Boivin, B. 1966, 1967. Énumération des plantes du Canada. Provencheria 6. Nat. Can. (Que.) 93: 253-274; 371-437; 583-646; 989-1063. 94: 131-157; 471-528; 625-655.

Image or illustration

Galanthus nivalis:

Images: images.google.com

Toxic parts:

bulbs

References:

Frohne, D., Pfander, H. J. 1983. A colour atlas of poisonous plants. Wolfe Publishing Ltd., London, England. 291 pp.

Toxic plant chemicals:

lycorine

References:

Frohne, D., Pfander, H. J. 1983. A colour atlas of poisonous

plants. Wolfe Publishing Ltd., London, England. 291 pp.

Animals/Human Poisoning:

Note: When an animal is listed without additional information, the literature (as of 1993) contained no detailed explanation.

Humans

General symptoms of poisoning:

[diarrhea](#)

[nausea](#)

[vomiting](#)

References:

Frohne, D., Pfander, H. J. 1983. A colour atlas of poisonous plants. Wolfe Publishing Ltd., London, England. 291 pp.

[Another search?](#)

[Français](#) | [Contact Us](#) | [Help](#) | [Search](#) | [Canada site](#)

[Coming Events](#) | [About CBIF](#) | [Links](#) | [Reports and Publications](#) |

[Home](#)

Date modified: 2003-02-06

[Important Notices](#)



Français	Contact us	Help	Search	Canada site
Coming events	About CBIF	Links	Reports and publications	Home

Canadian Biodiversity Information Facility



Notes on poisoning: *Ginkgo biloba*

[Introduction](#)[Interactive](#)[All poisonous plants by Botanical name](#)[All poisonous plants by Common name](#)[Important WWW Poisonous Plants sites](#)

General poisoning notes:

Ginkgo (*Ginkgo biloba*) is an ornamental tree growing in the warmer parts of Canada. This plant is of botanical interest because it is the sole survivor of the order Ginkgoales, with fossil evidence tracing back over 200 million years. The tree now survives only in cultivation. The trees are planted for their beautifully shaped leaves, which turn an attractive yellow in autumn. Usually only male trees are planted because the fleshy pulp on the fruits develop an obnoxious smell resembling rancid butter when the pulp is deteriorating on the ground. The interior kernel of the fruit is considered a delicacy by people of Chinese, Japanese, and southeast Asian descent. Contact dermatitis occurs in sensitive individuals when they remove the fleshy pulp from the seeds in the autumn. Children who handle the attractive yellow fruits may develop dermatitis. The pulp is also used as a folk medicine in China and Japan. The crude extract contains a toxin that causes convulsions and death if used in excess. This type of poisoning is unlikely unless the extract (gin-nan) is available in Canada.

References:

Lepoittevin, J.-P., Benezra, C., Asakawa, Y. 1989. Allergic contact dermatitis to *Ginkgo biloba* L.: relationship with urushiol. Arch. Dermatol. Res., 281: 227-230.

Tomb, R. R., Fousereau, J., Sell, Y. 1988. Mini-epidemic of contact dermatitis from ginkgo tree fruit (*Ginkgo biloba* L.). Contact Dermatitis, 19: 281-283.

Wada, K., Ishigaki, S., Ueda, K., Take, Y., Sasaki, K., Sakata, M., Haga, M. 1988. Studies on the constitution of edible and medicinal plants. 1. Isolation and identification of 4-O-methylpyridoxine, toxic principle from the seed of *Ginkgo biloba* L. Chem. Pharm. Bull. (Tokyo), 36: 1779-1782.

Nomenclature:

Scientific Name: *Ginkgo biloba* L.

References:

Agriculture Quebec. 1975. Noms des maladies des plantes du Canada/ Names of plant diseases in Canada. , Quebec City, Que., Canada. 288 pp.

Alex, J. F., Cayouette, R., Mulligan, G. A. 1980. Common and botanical names of weeds in Canada/Noms populaire et scientifiques des plantes nuisibles du Canada. Revised. Agric. Can. Publ., Ottawa, Ont., Canada. 132 pp.

Bailey, L. H., Bailey, E. Z. 1976. Hortus third. Revised. MacMillan, New York, N.Y., USA. 1290 pp.

Scoggan, H. J. 1978, 1979. The flora of Canada. Nat. Mus. Nat. Sci. (Ottawa) Publ. Bot. 7(1)-7(4). 1711 pp.

Van Wijk, H. L. 1911. A dictionary of plant names. Martinus Nijhoff, The Hague, The Netherlands. 1444 pp.

Victorin, M. 1964. Flore Laurentienne. 2nd ed. Univ. Montreal, Montreal, Que., Canada. 952 pp.

Geographic Information

Plant or plant parts used in or around the home.

References:

Bailey, L. H., Bailey, E. Z. 1976. Hortus third. Revised. MacMillan, New York, N.Y., USA. 1290 pp.

Boivin, B. 1966, 1967. Énumération des plantes du Canada. Provencheria 6. Nat. Can. (Que.) 93: 253-274; 371-437; 583-646; 989-1063. 94: 131-157; 471-528; 625-655.

Image or illustration

Ginkgo biloba:

Images: images.google.com

Notes on Poisonous plant parts:

The endosperm (the food storage tissues) of the seeds contains a chemical that can cause convulsions and death in humans if taken

in excessive quantities. The Chinese and Japanese use a crude extract of ginkgo seed, called gin-nan, as an antitussive and expectorant in folk medicine. Excessive use of this extract has caused gin-nan food poisoning in China and Japan. Some deaths have occurred. Ginkgo seeds can be obtained in specialized food stores, and ginkgo trees grow and bear fruit at least in some areas of the country, such as Ottawa. The seeds are often picked by Chinese and Japanese for food consumption. The seed coat and the fruit pulp of ginkgo can cause allergic contact dermatitis. This most often happens when the fruit pulp is removed to get at the seed, which is considered a delicacy in Chinese and Japanese cooking (Nakamura 1985).

Toxic parts:

mature fruit
seeds

References:

Lepoittevin, J.-P., Benezra, C., Asakawa, Y. 1989. Allergic contact dermatitis to *Ginkgo biloba* L.: relationship with urushiol. Arch. Dermatol. Res., 281: 227-230.

Tomb, R. R., Foussereau, J., Sell, Y. 1988. Mini-epidemic of contact dermatitis from ginkgo tree fruit (*Ginkgo biloba* L.). Contact Dermatitis, 19: 281-283.

Wada, K., Ishigaki, S., Ueda, K., Take, Y., Sasaki, K., Sakata, M., Haga, M. 1988. Studies on the constitution of edible and medicinal plants. 1. Isolation and identification of 4-O-methylpyridoxine, toxic principle from the seed of *Ginkgo biloba* L. Chem. Pharm. Bull. (Tokyo), 36: 1779-1782.

Notes on Toxic plant chemicals:

4-O-Methylpyridoxine is a chemical that has an antivitamin B6 activity. This chemical is found in the endosperm (the food storage tissue) of the seeds. The chemical causes convulsions in guinea pigs at oral doses of 11 mg/kg. 4-O-Methylpyridoxine also inhibits the formation of 4-aminobutyric acid from glutamate, which might induce seizures (Wada et al. 1988). Ginkgolic acids 1 are aromatic compounds found in the pulpy exterior of the fruit of ginkgo. These chemicals cause allergic contact dermatitis. Lepoittevin et al. (1989) determined that despite the close structure between ginkgolic acids 1 and the components of urushiol 4 (the allergen of poison-ivy), the hypothesis that the acids transform into catechol 4 in vivo (as with poison-ivy) cannot be supported. Cross-reactivity between ginkgo and urushiol did not occur when tested on guinea pigs.

Toxic plant chemicals:

ginkgolic acids 1
4-O-methylpyridoxine

References:

Lepoittevin, J.-P., Benezra, C., Asakawa, Y. 1989. Allergic contact dermatitis to *Ginkgo biloba* L.: relationship with urushiol. Arch. Dermatol. Res., 281: 227-230.

Wada, K., Ishigaki, S., Ueda, K., Take, Y., Sasaki, K., Sakata, M., Haga, M. 1988. Studies on the constitution of edible and medicinal plants. 1. Isolation and identification of 4-O-methylpyridoxine, toxic principle from the seed of *Ginkgo biloba* L. Chem. Pharm. Bull. (Tokyo), 36: 1779-1782.

Animals/Human Poisoning:

Note: When an animal is listed without additional information, the literature (as of 1993) contained no detailed explanation.

Humans

General symptoms of poisoning:

[convulsions](#)

[death](#)

[erythema](#)

[unconsciousness](#)

Notes on poisoning:

A crude extract of ginkgo seeds is used in folk medicine in China and Japan. Excessive use can cause convulsions, unconsciousness, and death. Infants are especially vulnerable (Wada et al. 1988).

References:

Lepoittevin, J.-P., Benezra, C., Asakawa, Y. 1989. Allergic contact dermatitis to *Ginkgo biloba* L.: relationship with urushiol. Arch. Dermatol. Res., 281: 227-230.

Tomb, R. R., Foussereau, J., Sell, Y. 1988. Mini-epidemic of contact dermatitis from ginkgo tree fruit (*Ginkgo biloba* L.). Contact Dermatitis, 19: 281-283.

Wada, K., Ishigaki, S., Ueda, K., Take, Y., Sasaki, K., Sakata, M., Haga, M. 1988. Studies on the constitution of edible and medicinal plants. 1. Isolation and identification of

4-O-methylpyridoxine, toxic principle from the seed of *Ginkgo biloba* L. Chem. Pharm. Bull. (Tokyo), 36: 1779-1782.

[Another search?](#)

[Français](#) | [Contact Us](#) | [Help](#) | [Search](#) | [Canada site](#)

[Coming Events](#) | [About CBIF](#) | [Links](#) | [Reports and Publications](#) |

[Home](#)

Date modified: 2003-02-06

[Important Notices](#)



Français	Contact us	Help	Search	Canada site
Coming events	About CBIF	Links	Reports and publications	Home

Canadian Biodiversity Information Facility



Notes on poisoning: *Glechoma hederacea*

[Introduction](#)[Interactive](#)[All poisonous plants by Botanical name](#)[All poisonous plants by Common name](#)[Important WWW Poisonous Plants sites](#)

General poisoning notes:

Ground-ivy (*Glechoma hederacea*) is a creeping ground cover that can grow abundantly in uncultivated damp or shaded ground around houses and garden areas. This plant contains an irritant oil that is toxic to horses if they ingest large quantities of the fresh or dried plant. In one case in Canada the death of horses was reported (Fyles 1920, Fuller and McClintock 1986).



References:

- Fuller, T. C., McClintock, E. 1986. Poisonous plants of California. Univ. California Press, Berkeley, Calif., USA. 432 pp.
- Fyles, F. 1920. Principal poisonous plants of Canada. Can. Dep. Agric. Exp. Farms. Bull. 39. 112 pp.

Nomenclature:

Scientific Name: *Glechoma hederacea* L.

Vernacular name(s): ground-ivy

Scientific family name: *Labiatae*

Vernacular family name: mint

Go to ITIS^{*ca} for more taxonomic information on: [Glechoma hederacea](#)

References:

Agriculture Quebec. 1975. Noms des maladies des plantes du Canada/ Names of plant diseases in Canada. , Quebec City, Que., Canada. 288 pp.

Alex, J. F., Cayouette, R., Mulligan, G. A. 1980. Common and

botanical names of weeds in Canada/Noms populaire et scientifiques des plantes nuisibles du Canada. Revised. Agric. Can. Publ., Ottawa, Ont., Canada. 132 pp.

Bailey, L. H., Bailey, E. Z. 1976. Hortus third. Revised. MacMillan, New York, N.Y., USA. 1290 pp.

Scoggan, H. J. 1978, 1979. The flora of Canada. Nat. Mus. Nat. Sci. (Ottawa) Publ. Bot. 7(1)-7(4). 1711 pp.

Van Wijk, H. L. 1911. A dictionary of plant names. Martinus Nijhoff, The Hague, The Netherlands. 1444 pp.

Victorin, M. 1964. Flore Laurentienne. 2nd ed. Univ. Montreal, Montreal, Que., Canada. 952 pp.

Geographic Information

Alberta
British Columbia
Manitoba
New Brunswick
Newfoundland
Nova Scotia
Ontario
Prince Edward Island
Quebec
Saskatchewan

References:

Bailey, L. H., Bailey, E. Z. 1976. Hortus third. Revised. MacMillan, New York, N.Y., USA. 1290 pp.

Boivin, B. 1966, 1967. Énumération des plantes du Canada. Provencheria 6. Nat. Can. (Que.) 93: 253-274; 371-437; 583-646; 989-1063. 94: 131-157; 471-528; 625-655.

Image or illustration

Glechoma hederacea:

Images: images.google.com

Toxic parts:

leaves
stems

References:

Fyles, F. 1920. Principal poisonous plants of Canada. Can. Dep. Agric. Exp. Farms. Bull. 39. 112 pp.

Toxic plant chemicals:

unknown chemical

References:

Fyles, F. 1920. Principal poisonous plants of Canada. Can. Dep. Agric. Exp. Farms. Bull. 39. 112 pp.

Animals/Human Poisoning:

Note: When an animal is listed without additional information, the literature (as of 1993) contained no detailed explanation.

Horses

General symptoms of poisoning:

[cyanosis](#)

[dyspnea](#)

[lungs, congestion of](#)

[pupil dilation](#)

[salivation](#)

[sweating](#)

Notes on poisoning:

In Prince Edward Island two horses ingested large quantities of ground-ivy in November when the ivy provided an abundance of green foliage. The horses panted continually and died within a week. One horse would lie down and the other horse would not. In Europe, horses have been reported to ingest large amounts of fresh or dried ground-ivy, with subsequent poisoning. Apparently, cattle and sheep were not poisoned after they ingested the plant (Fyles 1920).

References:

Fyles, F. 1920. Principal poisonous plants of Canada. Can. Dep. Agric. Exp. Farms. Bull. 39. 112 pp.

[Another search?](#)

[Français](#) | [Contact Us](#) | [Help](#) | [Search](#) | [Canada site](#)
[Coming Events](#) | [About CBIF](#) | [Links](#) | [Reports and Publications](#) |
[Home](#)

Date modified: 2003-02-06

[Important Notices](#)



Français	Contact us	Help	Search	Canada site
Coming events	About CBIF	Links	Reports and publications	Home

Canadian Biodiversity Information Facility



Notes on poisoning: *Gloriosa superba*

[Introduction](#)[Interactive](#)[All poisonous plants by Botanical name](#)[All poisonous plants by Common name](#)[Important WWW Poisonous Plants sites](#)

General poisoning notes:

Glory lily (*Gloriosa superba*) is a rarely grown indoor ornamental vine best suited to greenhouses. Ingesting the tubers causes severe poisoning in humans. The plant contains two alkaloids, including colchicine, which cause severe gastroenteritis, vomiting, and possible unconsciousness. Severe hair loss is a consistent symptom of colchicine poisoning. Complete recovery is slow (Gooneratne 1966, Angunawela and Fernando 1971, Lampe and McCann 1985).

References:

Angunawela, R. M., Fernando, H. A. 1971. Acute ascending polyneuropathy and dermatitis following poisoning by tubers of *Gloriosa superba*. Ceylon Med. J., 16: 233-235.

Gooneratne, B. W. 1966. Massive generalized alopecia after poisoning by *Gloriosa superba*. Br. Med. J., 1: 1023-1024.

Lampe, K. F., McCann, M. A. 1985. AMA Handbook of poisonous and injurious plants. American Medical Assoc. Chicago, Ill., USA. 432 pp.

Nomenclature:

Scientific Name: *Gloriosa superba* L.

Vernacular name(s): glory lily

Scientific family name: *Liliaceae*

Vernacular family name: lily

Go to ITIS^{*ca} for more taxonomic information on: [Gloriosa superba](#)

References:

Agriculture Quebec. 1975. Noms des maladies des plantes du Canada/ Names of plant diseases in Canada. , Quebec City, Que., Canada. 288 pp.

Alex, J. F., Cayouette, R., Mulligan, G. A. 1980. Common and botanical names of weeds in Canada/Noms populaire et scientifiques des plantes nuisibles du Canada. Revised. Agric. Can. Publ., Ottawa, Ont., Canada. 132 pp.

Bailey, L. H., Bailey, E. Z. 1976. Hortus third. Revised. MacMillan, New York, N.Y., USA. 1290 pp.

Scoggan, H. J. 1978, 1979. The flora of Canada. Nat. Mus. Nat. Sci. (Ottawa) Publ. Bot. 7(1)-7(4). 1711 pp.

Van Wijk, H. L. 1911. A dictionary of plant names. Martinus Nijhoff, The Hague, The Netherlands. 1444 pp.

Victorin, M. 1964. Flore Laurentienne. 2nd ed. Univ. Montreal, Montreal, Que., Canada. 952 pp.

Geographic Information

Plant or plant parts used in or around the home.

References:

Bailey, L. H., Bailey, E. Z. 1976. Hortus third. Revised. MacMillan, New York, N.Y., USA. 1290 pp.

Boivin, B. 1966, 1967. Énumération des plantes du Canada. Provencheria 6. Nat. Can. (Que.) 93: 253-274; 371-437; 583-646; 989-1063. 94: 131-157; 471-528; 625-655.

Image or illustration

Gloriosa superba:

Images: images.google.com

Toxic parts:

tubers

References:

Angunawela, R. M., Fernando, H. A. 1971. Acute ascending polyneuropathy and dermatitis following poisoning by tubers of *Gloriosa superba*. Ceylon Med. J., 16: 233-235.

Gooneratne, B. W. 1966. Massive generalized alopecia after poisoning by *Gloriosa superba*. Br. Med. J., 1: 1023-1024.

Notes on Toxic plant chemicals:

Two alkaloids, colchicine and gloriosine, are found in the tubers of glory lily. In one case, a young women ingested 125 g of tubers containing 0.3% colchicine. She ingested the equivalent of 350 mg of colchicine and within 2 h she was vomiting, becoming unconscious by the next day (Gooneratne 1966).

Toxic plant chemicals:

colchicine
gloriosine

References:

Angunawela, R. M., Fernando, H. A. 1971. Acute ascending polyneuropathy and dermatitis following poisoning by tubers of *Gloriosa superba*. Ceylon Med. J., 16: 233-235.

Gooneratne, B. W. 1966. Massive generalized alopecia after poisoning by *Gloriosa superba*. Br. Med. J., 1: 1023-1024.

Animals/Human Poisoning:

Note: When an animal is listed without additional information, the literature (as of 1993) contained no detailed explanation.

Humans

General symptoms of poisoning:

[alopecia](#)
[dehydration](#)
[diarrhea](#)
[hemoglobinuria](#)
[unconsciousness](#)
[vomiting](#)
[weakness](#)

Notes on poisoning:

Ingesting the tubers causes severe vomiting, abdominal pain, severe and bloody diarrhea, vaginal bleeding, weakness, and retention of urine and waste. Swelling of the lower or upper limbs may occur. Partial to complete hair loss occurs, sometimes on all parts of the body. Recover is slow, because colchicine is slowly

secreted from the system. Treatment includes fluid retention, monitoring of renal function and blood pressure, and treatment for diarrhea (Gooneratne 1966, Angunawela and Fernando 1971, Lampe and McCann 1985).

References:

Angunawela, R. M., Fernando, H. A. 1971. Acute ascending polyneuropathy and dermatitis following poisoning by tubers of *Gloriosa superba*. Ceylon Med. J., 16: 233-235.

Gooneratne, B. W. 1966. Massive generalized alopecia after poisoning by *Gloriosa superba*. Br. Med. J., 1: 1023-1024.

Lampe, K. F., McCann, M. A. 1985. AMA Handbook of poisonous and injurious plants. American Medical Assoc. Chicago, Ill., USA. 432 pp.

[Another search?](#)

[Français](#) | [Contact Us](#) | [Help](#) | [Search](#) | [Canada site](#)

[Coming Events](#) | [About CBIF](#) | [Links](#) | [Reports and Publications](#) | [Home](#)

Date modified: 2003-02-06

[Important Notices](#)



Français	Contact us	Help	Search	Canada site
Coming events	About CBIF	Links	Reports and publications	Home

Canadian Biodiversity Information Facility



Notes on poisoning: *Glyceria grandis*

[Introduction](#)[Interactive](#)[All poisonous plants by Botanical name](#)[All poisonous plants by Common name](#)[Important WWW Poisonous Plants sites](#)

General poisoning notes:

Tall manna grass (*Glyceria grandis*) is a native and naturalized grass found across Canada. This plant has caused sickness and death in a herd of cattle in British Columbia. The poisoning took place early in the season, suggesting that the amount of cyanogenic potential decreases in the plant later in the season (Puls et al. 1978).

References:

Puls, R., Newschwander, F. P., Greenway, J. A. 1978. Cyanide poisoning from *Glyceria grandis* S. Wats. ex Gray (tall mannagrass) in a British Columbia beef herd. Can. Vet. J., 19: 264-265.

Nomenclature:

Scientific Name: *Glyceria grandis* S. Wats.

Vernacular name(s): tall manna grass

Scientific family name: *Gramineae*

Vernacular family name: grass

Go to ITIS*^{ca} for more taxonomic information on: [Glyceria grandis](#)

References:

Agriculture Quebec. 1975. Noms des maladies des plantes du Canada/ Names of plant diseases in Canada. , Quebec City, Que., Canada. 288 pp.

Alex, J. F., Cayouette, R., Mulligan, G. A. 1980. Common and botanical names of weeds in Canada/Noms populaire et

scientifiques des plantes nuisibles du Canada. Revised. Agric. Can. Publ., Ottawa, Ont., Canada. 132 pp.

Bailey, L. H., Bailey, E. Z. 1976. Hortus third. Revised. MacMillan, New York, N.Y., USA. 1290 pp.

Scoggan, H. J. 1978, 1979. The flora of Canada. Nat. Mus. Nat. Sci. (Ottawa) Publ. Bot. 7(1)-7(4). 1711 pp.

Van Wijk, H. L. 1911. A dictionary of plant names. Martinus Nijhoff, The Hague, The Netherlands. 1444 pp.

Victorin, M. 1964. Flore Laurentienne. 2nd ed. Univ. Montreal, Montreal, Que., Canada. 952 pp.

Geographic Information

Alberta
British Columbia
Manitoba
New Brunswick
Northwest Territories
Ontario
Prince Edward Island
Quebec
Saskatchewan

References:

Bailey, L. H., Bailey, E. Z. 1976. Hortus third. Revised. MacMillan, New York, N.Y., USA. 1290 pp.

Boivin, B. 1966, 1967. Énumération des plantes du Canada. Provencheria 6. Nat. Can. (Que.) 93: 253-274; 371-437; 583-646; 989-1063. 94: 131-157; 471-528; 625-655.

Image or illustration

Glyceria grandis:

Images: images.google.com

Toxic parts:

leaves
stems

References:

Puls, R., Newschwander, F. P., Greenway, J. A. 1978. Cyanide poisoning from *Glyceria grandis* S. Wats. ex Gray (tall

mannagrass) in a British Columbia beef herd. Can. Vet. J., 19: 264-265.

Notes on Toxic plant chemicals:

An unknown cyanogenic glycoside that can be converted to cyanide in the animal body is found in tall manna grass. Cyanide in concentrations of more than 10 ppm was detected in whole blood taken from poisoned cattle (Puls et al. 1978).

Toxic plant chemicals:

unknown chemical

References:

Puls, R., Newschwander, F. P., Greenway, J. A. 1978. Cyanide poisoning from *Glyceria grandis* S. Wats. ex Gray (tall mannagrass) in a British Columbia beef herd. Can. Vet. J., 19: 264-265.

Animals/Human Poisoning:

Note: When an animal is listed without additional information, the literature (as of 1993) contained no detailed explanation.

Cattle

General symptoms of poisoning:

[death](#)

[gait, staggering](#)

[liver, congestion of](#)

Notes on poisoning:

Symptoms included staggering and death. The liver was congested and lung lobes showed interlobular edema and slight emphysema. Animals that were staggering, but did not fall, recovered (Puls et al. 1978).

References:

Puls, R., Newschwander, F. P., Greenway, J. A. 1978. Cyanide poisoning from *Glyceria grandis* S. Wats. ex Gray (tall mannagrass) in a British Columbia beef herd. Can. Vet. J., 19: 264-265.

[Another search?](#)

[Français](#) | [Contact Us](#) | [Help](#) | [Search](#) | [Canada site](#)
[Coming Events](#) | [About CBIF](#) | [Links](#) | [Reports and Publications](#) |
[Home](#)

Date modified: 2003-02-06

[Important Notices](#)



Français	Contact us	Help	Search	Canada site
Coming events	About CBIF	Links	Reports and publications	Home

Canadian Biodiversity Information Facility



Notes on poisoning: *Gutierrezia sarothrae*

[Introduction](#)

[Interactive](#)

[All poisonous plants by Botanical name](#)

[All poisonous plants by Common name](#)

[Important WWW Poisonous Plants sites](#)



General poisoning notes:

Broom snakeweed (*Gutierrezia sarothrae*) is a native perennial found in western rangelands. This plant has caused acute toxicity and abortion in cattle, which has also been experimentally induced in goats and sheep. The plant is more toxic during the early stages of growth and if it grows on poor, sandy soils. Major losses of cattle through acute toxicity and abortion have occurred in the southern United States, in Texas, and in New Mexico (Kingsbury 1964, Molyneux et al. 1980).

References:

Kingsbury, J. M. 1964. Poisonous plants of the United States and Canada. Prentice-Hall Inc., Englewood Cliffs, N.J., USA. 626 pp.

Molyneux, R. J., Stevens, K. L., James, L. F. 1980. Chemistry of toxic range plants. Volatile constituents of broomweed (*Gutierrezia sarothrae*). J. Agric. Food Chem., 28: 1332-1333.

Ralphs, M. H. 1985. Poisonous plants: the snakeweeds. Rangelands, 7(2): 63-65.

Nomenclature:

Scientific Name: *Gutierrezia sarothrae* (Pursh) Britton & Rusby

Vernacular name(s): broom snakeweed

Scientific family name: *Compositae*

Vernacular family name: composite

Go to ITIS^{*ca} for more taxonomic information on: [Gutierrezia sarothrae](#)

References:

Agriculture Quebec. 1975. Noms des maladies des plantes du Canada/ Names of plant diseases in Canada. , Quebec City, Que., Canada. 288 pp.

Alex, J. F., Cayouette, R., Mulligan, G. A. 1980. Common and botanical names of weeds in Canada/Noms populaire et scientifiques des plantes nuisibles du Canada. Revised. Agric. Can. Publ., Ottawa, Ont., Canada. 132 pp.

Bailey, L. H., Bailey, E. Z. 1976. Hortus third. Revised. MacMillan, New York, N.Y., USA. 1290 pp.

Scoggan, H. J. 1978, 1979. The flora of Canada. Nat. Mus. Nat. Sci. (Ottawa) Publ. Bot. 7(1)-7(4). 1711 pp.

Van Wijk, H. L. 1911. A dictionary of plant names. Martinus Nijhoff, The Hague, The Netherlands. 1444 pp.

Victorin, M. 1964. Flore Laurentienne. 2nd ed. Univ. Montreal, Montreal, Que., Canada. 952 pp.

Geographic Information

Alberta
Manitoba
Saskatchewan

References:

Bailey, L. H., Bailey, E. Z. 1976. Hortus third. Revised. MacMillan, New York, N.Y., USA. 1290 pp.

Boivin, B. 1966, 1967. Énumération des plantes du Canada. Provencheria 6. Nat. Can. (Que.) 93: 253-274; 371-437; 583-646; 989-1063. 94: 131-157; 471-528; 625-655.

Image or illustration

Gutierrezia sarothrae:

Images: images.google.com

Notes on Poisonous plant parts:

As little as 9 kg of fresh broom snakeweed has produced abortion in cattle within 7 days. Death has been experimentally produced in cattle, sheep, and goats by feeding fresh plants equivalent to 10-20% of body weight for 3 days to 2 weeks (Kingsbury 1964).

Toxic parts:

leaves
stems

References:

Kingsbury, J. M. 1964. Poisonous plants of the United States and Canada. Prentice-Hall Inc., Englewood Cliffs, N.J., USA. 626 pp.

Molyneux, R. J., Stevens, K. L., James, L. F. 1980. Chemistry of toxic range plants. Volatile constituents of broomweed (*Gutierrezia sarothrae*). J. Agric. Food Chem., 28: 1332-1333.

Notes on Toxic plant chemicals:

The essential oil contains monoterpenes, such as alpha-pinene and geraniol, and sesquiterpenes, such as gamma-humulene. However, Molyneux et al. (1980) do not believe that these chemicals contribute to the abortifacient nature of broom snakeweed. Saponins are believed to be the cause of the toxicity to animals and may also be implicated in the abortifacient fraction (Cheeke and Schull 1985).

Toxic plant chemicals:

alpha-pinene
gamma-humulene

References:

Molyneux, R. J., Stevens, K. L., James, L. F. 1980. Chemistry of toxic range plants. Volatile constituents of broomweed (*Gutierrezia sarothrae*). J. Agric. Food Chem., 28: 1332-1333.

Animals/Human Poisoning:

Note: When an animal is listed without additional information, the literature (as of 1993) contained no detailed explanation.

Cattle

General symptoms of poisoning:

[abortion](#)

[anorexia](#)

[appetite, loss of](#)

[constipation](#)

[death](#)

[diarrhea](#)

[muzzle, crusty](#)

[urination, frequent](#)

Notes on poisoning:

Acute toxicity includes symptoms of listlessness, anorexia, rough coat, diarrhea or constipation, vaginal discharge, and hematuria. Cattle produce a nasal discharge, and the muzzle becomes crusty. Lesions include those of gastroenteritis and degeneration of the kidneys and liver. Severe toxic nephritis with necrosis occurs in serious cases. The spleen may be congested and the uterus, edematous. Abortion is a major result of poisoning. Premature calves are weak or are dead at birth with retained placenta. The pregnant cow may experience swelling of the vulva and early udder development (Kingsbury 1964, Molyneux et al. 1980, Ralphs 1985).

References:

Kingsbury, J. M. 1964. Poisonous plants of the United States and Canada. Prentice-Hall Inc., Englewood Cliffs, N.J., USA. 626 pp.

Ralphs, M. H. 1985. Poisonous plants: the snakeweeds. Rangelands, 7(2): 63-65.

Goats

General symptoms of poisoning:

[abortion](#)

[death](#)

References:

Kingsbury, J. M. 1964. Poisonous plants of the United States and Canada. Prentice-Hall Inc., Englewood Cliffs, N.J., USA. 626 pp.

Sheep

General symptoms of poisoning:

[abortion](#)

[anorexia](#)

[constipation](#)

[death](#)

[diarrhea](#)

[icterus](#)

[weakness](#)

Notes on poisoning:

Symptoms of broom snakeweed poisoning in sheep are similar to those in cattle and include anorexia, rough coat, diarrhea or constipation, vaginal discharge, and hematuria. Sheep display minor icterus. Lesions include those of gastroenteritis and degeneration of the liver and kidneys. Toxic nephritis is found in severe cases. Abortion also occurs, but less frequently than in cattle (Kingsbury 1964).

References:

Kingsbury, J. M. 1964. Poisonous plants of the United States and Canada. Prentice-Hall Inc., Englewood Cliffs, N.J., USA. 626 pp.

[Another search?](#)

[Français](#) | [Contact Us](#) | [Help](#) | [Search](#) | [Canada site](#)

[Coming Events](#) | [About CBIF](#) | [Links](#) | [Reports and Publications](#) | [Home](#)

Date modified: 2003-02-06

[Important Notices](#)



Français	Contact us	Help	Search	Canada site
Coming events	About CBIF	Links	Reports and publications	Home

Canadian Biodiversity Information Facility



Notes on poisoning: *Gymnocladus dioicus*

[Introduction](#)[Interactive](#)[All poisonous plants by Botanical name](#)[All poisonous plants by Common name](#)[Important WWW Poisonous Plants sites](#)

General poisoning notes:

Kentucky coffeetree (*Gymnocladus dioicus*) is a tree that is occasionally planted as an ornamental in the warmer parts of Canada. The seeds and fruit pulp of this tree have poisoned humans and cattle. The foliage has caused the death of sheep in Maryland (Reynard and Norton 1942, Lampe and McCann 1985).



References:

Hill, S. R., Duke, P. K. 1986. 100 poisonous plants of Maryland. Univ. MD. Coop. Ext. Serv. Bull., 314. 55 pp.

Lampe, K. F., McCann, M. A. 1985. AMA Handbook of poisonous and injurious plants. American Medical Assoc. Chicago, Ill., USA. 432 pp.

Reynard, G. B., Norton, J. B. 1942. Poisonous plants of Maryland in relation to livestock. Univ. MD. Agric. Exp. Stn. Bull., A10. 312 pp.

Nomenclature:

Scientific Name: *Gymnocladus dioicus* (L.) K. Koch

Vernacular name(s): Kentucky coffeetree

Scientific family name: *Leguminosae*

Vernacular family name: pea

Go to ITIS^{*ca} for more taxonomic information on: [Gymnocladus dioicus](#)

References:

Agriculture Quebec. 1975. Noms des maladies des plantes du

Canada/ Names of plant diseases in Canada. , Quebec City, Que., Canada. 288 pp.

Alex, J. F., Cayouette, R., Mulligan, G. A. 1980. Common and botanical names of weeds in Canada/Noms populaire et scientifiques des plantes nuisibles du Canada. Revised. Agric. Can. Publ., Ottawa, Ont., Canada. 132 pp.

Bailey, L. H., Bailey, E. Z. 1976. Hortus third. Revised. MacMillan, New York, N.Y., USA. 1290 pp.

Scoggan, H. J. 1978, 1979. The flora of Canada. Nat. Mus. Nat. Sci. (Ottawa) Publ. Bot. 7(1)-7(4). 1711 pp.

Van Wijk, H. L. 1911. A dictionary of plant names. Martinus Nijhoff, The Hague, The Netherlands. 1444 pp.

Victorin, M. 1964. Flore Laurentienne. 2nd ed. Univ. Montreal, Montreal, Que., Canada. 952 pp.

Geographic Information

Plant or plant parts used in or around the home.

References:

Bailey, L. H., Bailey, E. Z. 1976. Hortus third. Revised. MacMillan, New York, N.Y., USA. 1290 pp.

Boivin, B. 1966, 1967. Énumération des plantes du Canada. Provencheria 6. Nat. Can. (Que.) 93: 253-274; 371-437; 583-646; 989-1063. 94: 131-157; 471-528; 625-655.

Image or illustration

Gymnocladus dioica:

Images: images.google.com

Notes on Poisonous plant parts:

The seeds contain a low concentration of the alkaloid cytisine, and chewing one or two seeds would not be enough to produce toxic results. This tree is an ornamental that survives and produces seeds in the warmer parts of the country; it grows successfully in Ottawa. In feeding experiments the foliage has proved to be toxic to sheep and the seeds to cattle (Reynard and Norton 1942, Lampe and McCann 1985).

Toxic parts:

leaves
seeds

References:

Lampe, K. F., McCann, M. A. 1985. AMA Handbook of poisonous and injurious plants. American Medical Assoc. Chicago, Ill., USA. 432 pp.

Reynard, G. B., Norton, J. B. 1942. Poisonous plants of Maryland in relation to livestock. Univ. MD. Agric. Exp. Stn. Bull., A10. 312 pp.

Toxic plant chemicals:

cytisine

References:

Lampe, K. F., McCann, M. A. 1985. AMA Handbook of poisonous and injurious plants. American Medical Assoc. Chicago, Ill., USA. 432 pp.

Animals/Human Poisoning:

Note: When an animal is listed without additional information, the literature (as of 1993) contained no detailed explanation.

Cattle

General symptoms of poisoning:

[lungs, congestion of](#)

Notes on poisoning:

Experimental feeding of seeds to cattle has caused congestion of the lungs and the fourth stomach (Reynard and Norton 1942).

References:

Reynard, G. B., Norton, J. B. 1942. Poisonous plants of Maryland in relation to livestock. Univ. MD. Agric. Exp. Stn. Bull., A10. 312 pp.

Humans

General symptoms of poisoning:

[coma](#)

[diarrhea](#)

[gastroenteritis](#)

[nausea](#)

[sweating](#)

References:

Lampe, K. F., McCann, M. A. 1985. AMA Handbook of poisonous and injurious plants. American Medical Assoc. Chicago, Ill., USA. 432 pp.

Sheep

General symptoms of poisoning:

[death](#)

Notes on poisoning:

In one case in Maryland, 11 sheep died within 24 h of ingesting fresh cuttings from the Kentucky coffeetree (Hill and Duke 1985).

References:

Hill, S. R., Duke, P. K. 1986. 100 poisonous plants of Maryland. Univ. MD. Coop. Ext. Serv. Bull., 314. 55 pp.

[Another search?](#)

[Français](#) | [Contact Us](#) | [Help](#) | [Search](#) | [Canada site](#)

[Coming Events](#) | [About CBIF](#) | [Links](#) | [Reports and Publications](#) |

[Home](#)

Date modified: 2003-02-06

[Important Notices](#)



Français	Contact us	Help	Search	Canada site
Coming events	About CBIF	Links	Reports and publications	Home

Canadian Biodiversity Information Facility



Notes on poisoning: *Hedera helix*

[Introduction](#)

[Interactive](#)

[All poisonous plants by Botanical name](#)

[All poisonous plants by Common name](#)

[Important WWW Poisonous Plants sites](#)



General poisoning notes:

English ivy (*Hedera helix*) is an indoor and outdoor ornamental vine. This plant contains saponins, which have caused poisoning in cattle, dogs, sheep, and humans. Two chemicals in the sap can also cause severe contact dermatitis in sensitive humans. Cases of poisoning are found in older European literature; the plant grows naturally in Europe. Cattle that ingested large quantities of the vines were ill for a few days. Humans who ingested the berries have shown symptoms, including coma. Dermatitis is rare but can be severe. Weeping lesions and blisters respond slowly to treatment (Cooper and Johnson 1984, Massmanian et al. 1980). Family pets should not be allowed to eat English ivy leaves.

References:

Boyle, J., Harman, R. M. 1985. Contact dermatitis to *Hedera helix* (common ivy). *Contact Dermatitis*, 12: 111-112.

Cooper, M. R., Johnson, A. W. 1984. Poisonous plants in Britain and their effects on animals and man. Her Majesty's Stationery Office, London, England. 305 pp.

Frohne, D., Pfander, H. J. 1983. A colour atlas of poisonous plants. Wolfe Publishing Ltd., London, England. 291 pp.

Massmanian, A., Valcuende Caverro, F., Ramirez Bosca, A., Castells Rodellas, A. 1988. Contact dermatitis from variegated ivy (*Hedera helix* subsp. *canariensis* Willd.). *Contact Dermatitis*, 18: 247-248.

Mitchell, J. C. 1981. Allergic contact dermatitis from *Hedera helix* and *Brassaia actinophylla* (Araliaceae). *Contact Dermatitis*, 7: 158-159.

Spoerke, D. G., Smolinske, S. C. 1990. Toxicity of houseplants. CRC Press, Inc., Boca Raton, Fla., USA. 335 pp.

Nomenclature:

Scientific Name: *Hedera helix* L.

Vernacular name(s): English ivy

Scientific family name: *Araliaceae*

Vernacular family name: aralia

Go to ITIS^{*ca} for more taxonomic information on: [Hedera helix](#)

References:

Agriculture Quebec. 1975. Noms des maladies des plantes du Canada/ Names of plant diseases in Canada. , Quebec City, Que., Canada. 288 pp.

Alex, J. F., Cayouette, R., Mulligan, G. A. 1980. Common and botanical names of weeds in Canada/Noms populaire et scientifiques des plantes nuisibles du Canada. Revised. Agric. Can. Publ., Ottawa, Ont., Canada. 132 pp.

Bailey, L. H., Bailey, E. Z. 1976. Hortus third. Revised. MacMillan, New York, N.Y., USA. 1290 pp.

Scoggan, H. J. 1978, 1979. The flora of Canada. Nat. Mus. Nat. Sci. (Ottawa) Publ. Bot. 7(1)-7(4). 1711 pp.

Van Wijk, H. L. 1911. A dictionary of plant names. Martinus Nijhoff, The Hague, The Netherlands. 1444 pp.

Victorin, M. 1964. Flore Laurentienne. 2nd ed. Univ. Montreal, Montreal, Que., Canada. 952 pp.

Geographic Information

Plant or plant parts used in or around the home.

References:

Bailey, L. H., Bailey, E. Z. 1976. Hortus third. Revised. MacMillan, New York, N.Y., USA. 1290 pp.

Boivin, B. 1966, 1967. Énumération des plantes du Canada. Provencheria 6. Nat. Can. (Que.) 93: 253-274; 371-437; 583-646; 989-1063. 94: 131-157; 471-528; 625-655.

Image or illustration

Hedera helix:

Images: images.google.com

Notes on Poisonous plant parts:

The sap contained in the leaves and stems of English ivy can cause dermatitis and irritation in sensitive humans. The dermatitis usually occurs after pruning the plant (Massmanian et al. 1988). The leaves and fruit contain saponins that hydrolyze into toxic hederin compounds. These toxins have caused poisoning in animals and humans (Cooper and Johnson 1984).

Toxic parts:

leaves
mature fruit
plant juices

References:

Boyle, J., Harman, R. M. 1985. Contact dermatitis to *Hedera helix* (common ivy). *Contact Dermatitis*, 12: 111-112.

Cooper, M. R., Johnson, A. W. 1984. Poisonous plants in Britain and their effects on animals and man. Her Majesty's Stationery Office, London, England. 305 pp.

Massmanian, A., Valcuende Caverro, F., Ramirez Bosca, A., Castells Rodellas, A. 1988. Contact dermatitis from variegated ivy (*Hedera helix* subsp. *canariensis* Willd.). *Contact Dermatitis*, 18: 247-248.

Notes on Toxic plant chemicals:

English ivy contains hederasaponins, which undergo partial hydrolysis to form toxic substances (micro-hederin and beta-hederin). These toxins can cause poisoning in humans and other animals if ingested in sufficient quantities. English ivy also contains allergenic and irritant chemicals, falcarinol and didehydrofalcarinol, which cause intense burning and dermatitis in sensitive humans (Cooper and Johnson 1984; Massmanian et al. 1988).

Toxic plant chemicals:

didehydrofalcarinol
falcarinol
hederasaponins

References:

Cooper, M. R., Johnson, A. W. 1984. Poisonous plants in Britain and their effects on animals and man. Her Majesty's Stationery Office, London, England. 305 pp.

Massmanian, A., Valcuende Cavero, F., Ramirez Bosca, A., Castells Rodellas, A. 1988. Contact dermatitis from variegated ivy (*Hedera helix* subsp. *canariensis* Willd.). Contact Dermatitis, 18: 247-248.

Animals/Human Poisoning:

Note: When an animal is listed without additional information, the literature (as of 1993) contained no detailed explanation.

Cattle

Dogs

General symptoms of poisoning:

[agitation](#)

[diarrhea](#)

[muscle spasms](#)

[paralysis](#)

[vomiting](#)

References:

Cooper, M. R., Johnson, A. W. 1984. Poisonous plants in Britain and their effects on animals and man. Her Majesty's Stationery Office, London, England. 305 pp.

Humans

General symptoms of poisoning:

[blisters, weeping](#)

[breathing, labored](#)

[coma](#)

[convulsions](#)

[diarrhea](#)

[erythema](#)

[muscle spasms](#)

[paralysis](#)

[vomiting](#)

Notes on poisoning:

Cattle that ingested large quantities of English ivy vine became ill and excitable, started staggering, and bellowed loudly. The odor of crushed ivy leaves was on the breath and in the milk. Recovery was quick and complete in three days (Cooper and Johnson 1984). English ivy berries are often listed as being poisonous to children, and cases of English ivy poisoning are listed in older European literature. Symptoms of ingestion included laboured breathing, coma, convulsions, and excitation (Cooper and Johnson 1984). Frohne and Pfander (1983) state that the ripe berries are dry and taste bitter. Large quantities are unlikely to be consumed by children.

References:

Boyle, J., Harman, R. M. 1985. Contact dermatitis to *Hedera helix* (common ivy). *Contact Dermatitis*, 12: 111-112.

Cooper, M. R., Johnson, A. W. 1984. Poisonous plants in Britain and their effects on animals and man. Her Majesty's Stationery Office, London, England. 305 pp.

Massmanian, A., Valcuende Cavero, F., Ramirez Bosca, A., Castells Rodellas, A. 1988. Contact dermatitis from variegated ivy (*Hedera helix* subsp. *canariensis* Willd.). *Contact Dermatitis*, 18: 247-248.

Sheep

[Another search?](#)

[Français](#) | [Contact Us](#) | [Help](#) | [Search](#) | [Canada site](#)

[Coming Events](#) | [About CBIF](#) | [Links](#) | [Reports and Publications](#) | [Home](#)

Date modified: 2003-02-06

[Important Notices](#)



Français	Contact us	Help	Search	Canada site
Coming events	About CBIF	Links	Reports and publications	Home

Canadian Biodiversity Information Facility



Notes on poisoning: *Helenium autumnale*

[Introduction](#)

[Interactive](#)

[All poisonous plants by Botanical name](#)

[All poisonous plants by Common name](#)

[Important WWW Poisonous Plants sites](#)



General poisoning notes:

Sneezeweed (*Helenium autumnale*) is a native herb found in parts of central and western Canada. This plant causes illness and occasional death in cattle and horses. It has been proved to be experimentally toxic to dogs but it is very unlikely that dogs would voluntarily ingest it. The plant is well-named because it is highly irritating to the nose, eyes, and stomach (Kingsbury 1964, Cheeke and Schull 1985, Fuller and McClintock 1986, Herz 1988).

References:

Cheeke, P. R., Shull, L. R. 1985. Natural toxicants in feeds and poisonous plants. AVI Publishing Company, Inc., Westport, Conn., USA. 492 pp.

Fuller, T. C., McClintock, E. 1986. Poisonous plants of California. Univ. California Press, Berkeley, Calif., USA. 432 pp.

Herz, W. 1978. Sesquiterpene lactones from livestock poisons. Pages 487-497 in Keeler, R. F., Van Kampen, K. R., James, L. F., eds. Effects of poisonous plants on livestock. Academic Press, New York, N.Y., USA. 600 pp.

Kingsbury, J. M. 1964. Poisonous plants of the United States and Canada. Prentice-Hall Inc., Englewood Cliffs, N.J., USA. 626 pp.

Nomenclature:

Scientific Name: *Helenium autumnale* L.

Vernacular name(s): sneezeweed

Scientific family name: *Compositae*

Vernacular family name: composite

Go to ITIS^{*ca} for more taxonomic information on: [Helenium autumnale](#)

References:

Agriculture Quebec. 1975. Noms des maladies des plantes du Canada/ Names of plant diseases in Canada. , Quebec City, Que., Canada. 288 pp.

Alex, J. F., Cayouette, R., Mulligan, G. A. 1980. Common and botanical names of weeds in Canada/Noms populaire et scientifiques des plantes nuisibles du Canada. Revised. Agric. Can. Publ., Ottawa, Ont., Canada. 132 pp.

Bailey, L. H., Bailey, E. Z. 1976. Hortus third. Revised. MacMillan, New York, N.Y., USA. 1290 pp.

Scoggan, H. J. 1978, 1979. The flora of Canada. Nat. Mus. Nat. Sci. (Ottawa) Publ. Bot. 7(1)-7(4). 1711 pp.

Van Wijk, H. L. 1911. A dictionary of plant names. Martinus Nijhoff, The Hague, The Netherlands. 1444 pp.

Victorin, M. 1964. Flore Laurentienne. 2nd ed. Univ. Montreal, Montreal, Que., Canada. 952 pp.

Geographic Information

Alberta
British Columbia
Manitoba
Northwest Territories
Ontario
Quebec
Saskatchewan

References:

Bailey, L. H., Bailey, E. Z. 1976. Hortus third. Revised. MacMillan, New York, N.Y., USA. 1290 pp.

Boivin, B. 1966, 1967. Énumération des plantes du Canada. Provencheria 6. Nat. Can. (Que.) 93: 253-274; 371-437; 583-646; 989-1063. 94: 131-157; 471-528; 625-655.

Image or illustration

Helenium autumnale:

Images: images.google.com

Toxic parts:

leaves
stems

References:

Herz, W. 1978. Sesquiterpene lactones from livestock poisons. Pages 487-497 in Keeler, R. F., Van Kampen, K. R., James, L. F., eds. Effects of poisonous plants on livestock. Academic Press, New York, N.Y., USA. 600 pp.

Notes on Toxic plant chemicals:

Helenalin, a sesquiterpene lactone, is the major toxin found in sneezeweed. The LD-50 for helenalin is between 85 and 150 mg/kg, given orally to sheep. This compound contains a seven-membered ring, a lactone structure, and an exocyclic methylene group (Cheeke and Schull 1985, Herz 1988).

Toxic plant chemicals:

helenalin

References:

Herz, W. 1978. Sesquiterpene lactones from livestock poisons. Pages 487-497 in Keeler, R. F., Van Kampen, K. R., James, L. F., eds. Effects of poisonous plants on livestock. Academic Press, New York, N.Y., USA. 600 pp.

Animals/Human Poisoning:

Note: When an animal is listed without additional information, the literature (as of 1993) contained no detailed explanation.

Cattle

General symptoms of poisoning:

[breathing, labored](#)

[convulsions](#)

[death](#)

[incoordination](#)

[mouth, frothing of](#)

Notes on poisoning:

Sneezeweed causes poisoning and death in cattle. Symptoms

include frothing at the mouth, incoordination, and convulsions. The plant is highly irritating to the nose, eyes, and stomach. Cows that ingest this plant produce bitter-tasting milk (Kingsbury 1964, Fuller and McClintock 1986).

References:

Cheeke, P. R., Shull, L. R. 1985. Natural toxicants in feeds and poisonous plants. AVI Publishing Company, Inc., Westport, Conn., USA. 492 pp.

Herz, W. 1978. Sesquiterpene lactones from livestock poisons. Pages 487-497 in Keeler, R. F., Van Kampen, K. R., James, L. F., eds. Effects of poisonous plants on livestock. Academic Press, New York, N.Y., USA. 600 pp.

Kingsbury, J. M. 1964. Poisonous plants of the United States and Canada. Prentice-Hall Inc., Englewood Cliffs, N.J., USA. 626 pp.

Horses

General symptoms of poisoning:

[convulsions](#)

[incoordination](#)

[weakness](#)

References:

Fuller, T. C., McClintock, E. 1986. Poisonous plants of California. Univ. California Press, Berkeley, Calif., USA. 432 pp.

Herz, W. 1978. Sesquiterpene lactones from livestock poisons. Pages 487-497 in Keeler, R. F., Van Kampen, K. R., James, L. F., eds. Effects of poisonous plants on livestock. Academic Press, New York, N.Y., USA. 600 pp.

Humans

[Another search?](#)

[Français](#) | [Contact Us](#) | [Help](#) | [Search](#) | [Canada site](#)

[Coming Events](#) | [About CBIF](#) | [Links](#) | [Reports and Publications](#) |

[Home](#)

Date modified: 2003-02-06

[Important Notices](#)



Français	Contact us	Help	Search	Canada site
Coming events	About CBIF	Links	Reports and publications	Home

Canadian Biodiversity Information Facility



Notes on poisoning: *Helenium flexuosum*

[Introduction](#)[Interactive](#)[All poisonous plants by Botanical name](#)[All poisonous plants by Common name](#)[Important WWW Poisonous Plants sites](#)

General poisoning notes:

Naked-flowered sneezeweed (*Helenium flexuosum*) is a native herb found in Ontario and Quebec. This plant has caused poisoning in horses and sheep and, experimentally, in calves. It contains sesquiterpene lactones.



References:

Kingsbury, J. M. 1964. Poisonous plants of the United States and Canada. Prentice-Hall Inc., Englewood Cliffs, N.J., USA. 626 pp.

Nomenclature:

Scientific Name: *Helenium flexuosum* Raf.

Vernacular name(s): naked-flowered sneezeweed

Scientific family name: *Compositae*

Vernacular family name: composite

Go to ITIS^{*ca} for more taxonomic information on: [Helenium flexuosum](#)

References:

Agriculture Quebec. 1975. Noms des maladies des plantes du Canada/ Names of plant diseases in Canada. , Quebec City, Que., Canada. 288 pp.

Alex, J. F., Cayouette, R., Mulligan, G. A. 1980. Common and botanical names of weeds in Canada/Noms populaire et scientifiques des plantes nuisibles du Canada. Revised. Agric. Can. Publ., Ottawa, Ont., Canada. 132 pp.

Bailey, L. H., Bailey, E. Z. 1976. Hortus third. Revised.

MacMillan, New York, N.Y., USA. 1290 pp.

Scoggan, H. J. 1978, 1979. The flora of Canada. Nat. Mus. Nat. Sci. (Ottawa) Publ. Bot. 7(1)-7(4). 1711 pp.

Van Wijk, H. L. 1911. A dictionary of plant names. Martinus Nijhoff, The Hague, The Netherlands. 1444 pp.

Victorin, M. 1964. Flore Laurentienne. 2nd ed. Univ. Montreal, Montreal, Que., Canada. 952 pp.

Geographic Information

Ontario

Quebec

References:

Bailey, L. H., Bailey, E. Z. 1976. Hortus third. Revised. MacMillan, New York, N.Y., USA. 1290 pp.

Boivin, B. 1966, 1967. Énumération des plantes du Canada. Provencheria 6. Nat. Can. (Que.) 93: 253-274; 371-437; 583-646; 989-1063. 94: 131-157; 471-528; 625-655.

Image or illustration

Helenium flexuosum:

Images: images.google.com

Toxic parts:

leaves

stems

References:

Herz, W. 1978. Sesquiterpene lactones from livestock poisons. Pages 487-497 in Keeler, R. F., Van Kampen, K. R., James, L. F., eds. Effects of poisonous plants on livestock. Academic Press, New York, N.Y., USA. 600 pp.

Notes on Toxic plant chemicals:

Flexuosin A and B are closely related to the chemical helenalin, which is found in sneezeweed (*Helenium autumnale*). These are all sesquiterpene lactones (Herz 1988).

Toxic plant chemicals:

flexuosin A

flexuosin B

References:

Herz, W. 1978. Sesquiterpene lactones from livestock poisons. Pages 487-497 in Keeler, R. F., Van Kampen, K. R., James, L. F., eds. Effects of poisonous plants on livestock. Academic Press, New York, N.Y., USA. 600 pp.

Animals/Human Poisoning:

Note: When an animal is listed without additional information, the literature (as of 1993) contained no detailed explanation.

Cattle

Horses

Sheep

General symptoms of poisoning:

[convulsions](#)

[dyspnea](#)

[weakness](#)

Notes on poisoning:

Horses are more susceptible than sheep to poisoning by naked-flowered sneezeweed (Kingsbury 1964).

References:

Kingsbury, J. M. 1964. Poisonous plants of the United States and Canada. Prentice-Hall Inc., Englewood Cliffs, N.J., USA. 626 pp.

[Another search?](#)

[Français](#) | [Contact Us](#) | [Help](#) | [Search](#) | [Canada site](#)

[Coming Events](#) | [About CBIF](#) | [Links](#) | [Reports and Publications](#) | [Home](#)

Date modified: 2003-02-06

[Important Notices](#)



Français	Contact us	Help	Search	Canada site
Coming events	About CBIF	Links	Reports and publications	Home

Canadian Biodiversity Information Facility



Notes on poisoning: *Helianthus annuus*

[Introduction](#)[Interactive](#)[All poisonous plants by Botanical name](#)[All poisonous plants by Common name](#)[Important WWW Poisonous Plants sites](#)

General poisoning notes:

Sunflower (*Helianthus annuus*) causes allergic contact dermatitis in sensitive individuals after contact with the sesquiterpene lactones contained in fragile, multicellular, capitate glandular hairs (Hausen and Spring 1989). Cattle have been poisoned in Europe after ingesting plants that did not have mature seeds. This is a result of nitrate toxicity, which has caused sickness and death (Cooper and Johnson 1984).

References:

Cooper, M. R., Johnson, A. W. 1984. Poisonous plants in Britain and their effects on animals and man. Her Majesty's Stationery Office, London, England. 305 pp.

Hausen, B. M., Spring, O. 1989. Sunflower allergy. On the constituents of the trichomes of *Helianthus annuus* L. (Compositae). Contact Dermatitis, 20: 326-334.

Nomenclature:

Scientific Name: *Helianthus annuus* L.

Vernacular name(s): sunflower

Scientific family name: *Compositae*

Vernacular family name: composite

Go to ITIS*^{ca} for more taxonomic information on: [Helianthus annuus](#)

References:

Agriculture Quebec. 1975. Noms des maladies des plantes du Canada/ Names of plant diseases in Canada. , Quebec City, Que.,

Canada. 288 pp.

Alex, J. F., Cayouette, R., Mulligan, G. A. 1980. Common and botanical names of weeds in Canada/Noms populaire et scientifiques des plantes nuisibles du Canada. Revised. Agric. Can. Publ., Ottawa, Ont., Canada. 132 pp.

Bailey, L. H., Bailey, E. Z. 1976. Hortus third. Revised. MacMillan, New York, N.Y., USA. 1290 pp.

Scoggan, H. J. 1978, 1979. The flora of Canada. Nat. Mus. Nat. Sci. (Ottawa) Publ. Bot. 7(1)-7(4). 1711 pp.

Van Wijk, H. L. 1911. A dictionary of plant names. Martinus Nijhoff, The Hague, The Netherlands. 1444 pp.

Victorin, M. 1964. Flore Laurentienne. 2nd ed. Univ. Montreal, Montreal, Que., Canada. 952 pp.

Geographic Information

References:

Bailey, L. H., Bailey, E. Z. 1976. Hortus third. Revised. MacMillan, New York, N.Y., USA. 1290 pp.

Boivin, B. 1966, 1967. Énumération des plantes du Canada. Provencheria 6. Nat. Can. (Que.) 93: 253-274; 371-437; 583-646; 989-1063. 94: 131-157; 471-528; 625-655.

Image or illustration

Helianthus annuus:

Images: images.google.com

Toxic parts:

hairs

References:

Hausen, B. M., Spring, O. 1989. Sunflower allergy. On the constituents of the trichomes of *Helianthus annuus* L. (Compositae). Contact Dermatitis, 20: 326-334.

Notes on Toxic plant chemicals:

Sunflower contains several sesquiterpene lactones, including the most active chemical, 1-O-methyl-4,5-dihydroxyniveusin A, in the hemiketal form. The complete mixture of sesquiterpene lactones

contributes to the allergic response in humans. These chemicals are found in the capitata glands on sunflower leaves (Hausen and Spring 1989). Sunflowers can also accumulate toxic amounts of nitrates, which have poisoned cattle in Europe (Cooper and Johnson 1984).

Toxic plant chemicals:

-dihydroniveusin A
nitrate

References:

Cooper, M. R., Johnson, A. W. 1984. Poisonous plants in Britain and their effects on animals and man. Her Majesty's Stationery Office, London, England. 305 pp.

Hausen, B. M., Spring, O. 1989. Sunflower allergy. On the constituents of the trichomes of *Helianthus annuus* L. (Compositae). Contact Dermatitis, 20: 326-334.

Animals/Human Poisoning:

Note: When an animal is listed without additional information, the literature (as of 1993) contained no detailed explanation.

Cattle

General symptoms of poisoning:

[agitation](#)

[collapse](#)

[death](#)

[lungs, congestion of](#)

Notes on poisoning:

Cattle that ingest sunflower plants that have not formed mature seeds develop nitrate poisoning. Symptoms include circulatory failure, swaying of hind quarters, excitation, and collapse 1-3 h after ingestion. Postmortem findings include lung edema, small hemorrhages and congestion of intestinal blood vessels, and dark-colored blood (Cooper and Johnson 1984).

References:

Cooper, M. R., Johnson, A. W. 1984. Poisonous plants in Britain and their effects on animals and man. Her Majesty's Stationery Office, London, England. 305 pp.

Humans

General symptoms of poisoning:

[eczema](#)

[erythema](#)

References:

Hausen, B. M., Spring, O. 1989. Sunflower allergy. On the constituents of the trichomes of *Helianthus annuus* L. (Compositae). Contact Dermatitis, 20: 326-334.

[Another search?](#)

[Français](#) | [Contact Us](#) | [Help](#) | [Search](#) | [Canada site](#)

[Coming Events](#) | [About CBIF](#) | [Links](#) | [Reports and Publications](#) |

[Home](#)

Date modified: 2003-02-06

[Important Notices](#)



Français	Contact us	Help	Search	Canada site
Coming events	About CBIF	Links	Reports and publications	Home

Canadian Biodiversity Information Facility



Notes on poisoning:

Heliotropium

curassavicum

[Introduction](#)[Interactive](#)[All poisonous plants by Botanical name](#)[All poisonous plants by Common name](#)[Important WWW Poisonous Plants sites](#)

General poisoning notes:



Spatulate-leaved heliotrope (*Heliotropium curassavicum*) is a native herb found in southern parts of western Canada. This plant contains pyrrolizidine alkaloids. It and other members of the genus (*Heliotropium species*) are used in herbal teas and have been used in several parts of the world for medicinal reasons. Over consumption of such teas may cause veno-occlusive disease of the liver (Budd-Chiari syndrome), with hepatic vein thrombosis (Lampe and McCann 1985, Huxtable 1989).

References:

Huxtable, R. J. 1989. Human health implications of pyrrolizidine alkaloids and herbs containing them. Pages 41-86 in Cheeke, P. R., ed. Toxicants of plant origin. Vol. I. Alkaloids. CRC Press, Inc., Boca Raton, Fla., USA. 335 pp.

Lampe, K. F., McCann, M. A. 1985. AMA Handbook of poisonous and injurious plants. American Medical Assoc. Chicago, Ill., USA. 432 pp.

Nomenclature:

Scientific Name: *Heliotropium curassavicum* L.

Vernacular name(s): spatulate-leaved heliotrope

Scientific family name: *Boraginaceae*

Vernacular family name: borage

Go to ITIS^{*ca} for more taxonomic information on: [Heliotropium curassavicum](#)

References:

Agriculture Quebec. 1975. Noms des maladies des plantes du Canada/ Names of plant diseases in Canada. , Quebec City, Que., Canada. 288 pp.

Alex, J. F., Cayouette, R., Mulligan, G. A. 1980. Common and botanical names of weeds in Canada/Noms populaire et scientifiques des plantes nuisibles du Canada. Revised. Agric. Can. Publ., Ottawa, Ont., Canada. 132 pp.

Bailey, L. H., Bailey, E. Z. 1976. Hortus third. Revised. MacMillan, New York, N.Y., USA. 1290 pp.

Scoggan, H. J. 1978, 1979. The flora of Canada. Nat. Mus. Nat. Sci. (Ottawa) Publ. Bot. 7(1)-7(4). 1711 pp.

Van Wijk, H. L. 1911. A dictionary of plant names. Martinus Nijhoff, The Hague, The Netherlands. 1444 pp.

Victorin, M. 1964. Flore Laurentienne. 2nd ed. Univ. Montreal, Montreal, Que., Canada. 952 pp.

Geographic Information

Alberta
Manitoba
Saskatchewan

References:

Bailey, L. H., Bailey, E. Z. 1976. Hortus third. Revised. MacMillan, New York, N.Y., USA. 1290 pp.

Boivin, B. 1966, 1967. Énumération des plantes du Canada. Provencheria 6. Nat. Can. (Que.) 93: 253-274; 371-437; 583-646; 989-1063. 94: 131-157; 471-528; 625-655.

Image or illustration

Heliotropium curassavicum:

Images: images.google.com

Toxic parts:

leaves

References:

Huxtable, R. J. 1989. Human health implications of pyrrolizidine alkaloids and herbs containing them. Pages 41-86 in Cheeke, P.

R., ed. Toxicants of plant origin. Vol. I. Alkaloids. CRC Press, Inc., Boca Raton, Fla., USA. 335 pp.

Notes on Toxic plant chemicals:

The heliotropes contain hepatotoxic pyrrolizidine alkaloids of the nonacyclic diester type. These alkaloids can cause veno-occlusive disease (Huxtable 1989).

Toxic plant chemicals:

unknown chemical

References:

Huxtable, R. J. 1989. Human health implications of pyrrolizidine alkaloids and herbs containing them. Pages 41-86 in Cheeke, P. R., ed. Toxicants of plant origin. Vol. I. Alkaloids. CRC Press, Inc., Boca Raton, Fla., USA. 335 pp.

Animals/Human Poisoning:

Note: When an animal is listed without additional information, the literature (as of 1993) contained no detailed explanation.

Humans

General symptoms of poisoning:

[abdominal pains](#)

[anorexia](#)

[ascites](#)

[death](#)

[diarrhea](#)

[liver, cirrhosis of](#)

[nausea](#)

[vomiting](#)

Notes on poisoning:

Symptoms of over-consumption of these plants may result in veno-occlusive disease of the liver. This is accompanied by abdominal pain and ascites. Cirrhosis of the liver can result. Other results are hepatomegaly and splenomegaly. Death may result. There is no specific treatment for toxin-induced hepatic veno-occlusive disease (Lampe and McCann 1985, Huxtable 1989).

References:

Huxtable, R. J. 1989. Human health implications of pyrrolizidine alkaloids and herbs containing them. Pages 41-86 in Cheeke, P. R., ed. Toxicants of plant origin. Vol. I. Alkaloids. CRC Press, Inc., Boca Raton, Fla., USA. 335 pp.

Lampe, K. F., McCann, M. A. 1985. AMA Handbook of poisonous and injurious plants. American Medical Assoc. Chicago, Ill., USA. 432 pp.

[Another search?](#)

[Français](#) | [Contact Us](#) | [Help](#) | [Search](#) | [Canada site](#)

[Coming Events](#) | [About CBIF](#) | [Links](#) | [Reports and Publications](#) | [Home](#)

Date modified: 2003-02-06

[Important Notices](#)



Français	Contact us	Help	Search	Canada site
Coming events	About CBIF	Links	Reports and publications	Home

Canadian Biodiversity Information Facility



Notes on poisoning:

Heracleum

mantegazzianum

[Introduction](#)[Interactive](#)[All poisonous plants by Botanical name](#)[All poisonous plants by Common name](#)[Important WWW Poisonous Plants sites](#)

General poisoning notes:

Giant hogweed (*Heracleum mantegazzianum*) is naturalized in south central Ontario. It has caused photosensitization in children after exposure to the plant followed by sunlight (Morton 1975). This plant has also been introduced into New York State, where children have also contracted dermatitis from it (Gunby 1980).

References:



Anon. 1970. The giant hogweed. *Lancet*, 2: 32.

Drever, J. C., Hunter, J. A. 1970. Hazards of giant hogweed. *Br. Med. J.*, 3: 109.

Gunby, P. 1980. Keep away from that 'tree', folks! *J. Am. Med. Assoc.*, 244: 2596.

Morton, J. K. 1975. The giant cow parsnip, *Heracleum mantegazzianum* Umbelliferae, in Canada. *Can. Field-Nat.*, 89: 183-184.

Nomenclature:

Scientific Name: *Heracleum mantegazzianum* Somm. & Levier

Vernacular name(s): giant hogweed

Scientific family name: *Umbelliferae*

Vernacular family name: parsley

Go to ITIS^{*ca} for more taxonomic information on: [Heracleum mantegazzianum](#)

References:

Agriculture Quebec. 1975. Noms des maladies des plantes du Canada/ Names of plant diseases in Canada. , Quebec City, Que., Canada. 288 pp.

Alex, J. F., Cayouette, R., Mulligan, G. A. 1980. Common and botanical names of weeds in Canada/Noms populaire et scientifiques des plantes nuisibles du Canada. Revised. Agric. Can. Publ., Ottawa, Ont., Canada. 132 pp.

Bailey, L. H., Bailey, E. Z. 1976. Hortus third. Revised. MacMillan, New York, N.Y., USA. 1290 pp.

Scoggan, H. J. 1978, 1979. The flora of Canada. Nat. Mus. Nat. Sci. (Ottawa) Publ. Bot. 7(1)-7(4). 1711 pp.

Van Wijk, H. L. 1911. A dictionary of plant names. Martinus Nijhoff, The Hague, The Netherlands. 1444 pp.

Victorin, M. 1964. Flore Laurentienne. 2nd ed. Univ. Montreal, Montreal, Que., Canada. 952 pp.

Geographic Information

Ontario

References:

Bailey, L. H., Bailey, E. Z. 1976. Hortus third. Revised. MacMillan, New York, N.Y., USA. 1290 pp.

Boivin, B. 1966, 1967. Énumération des plantes du Canada. Provencheria 6. Nat. Can. (Que.) 93: 253-274; 371-437; 583-646; 989-1063. 94: 131-157; 471-528; 625-655.

Image or illustration

Heracleum mantegazzianum:

Images: images.google.com

Toxic parts:

all parts
plant juices
stems

References:

Anon. 1970. The giant hogweed. Lancet, 2: 32.

Drever, J. C., Hunter, J. A. 1970. Hazards of giant hogweed. Br. Med. J., 3: 109.

Gunby, P. 1980. Keep away from that 'tree', folks! J. Am. Med. Assoc., 244: 2596.

Morton, J. K. 1975. The giant cow parsnip, *Heracleum mantegazzianum* Umbelliferae, in Canada. Can. Field-Nat., 89: 183-184.

Notes on Toxic plant chemicals:

Giant hogweed contains furocoumarins (psoralens), which make human skin hypersensitive to sunlight, causing cellular damage at the surface. They absorb long-wave ultraviolet light and become photodynamic (Cooper and Johnson 1984).

Toxic plant chemicals:

furocoumarin

References:

Cooper, M. R., Johnson, A. W. 1984. Poisonous plants in Britain and their effects on animals and man. Her Majesty's Stationery Office, London, England. 305 pp.

Drever, J. C., Hunter, J. A. 1970. Hazards of giant hogweed. Br. Med. J., 3: 109.

Animals/Human Poisoning:

Note: When an animal is listed without additional information, the literature (as of 1993) contained no detailed explanation.

Humans

General symptoms of poisoning:

[blistering](#)
[erythema](#)
[skin, brown pigment of](#)

Notes on poisoning:

Symptoms of phytophotosensitization include serious and extensive weeping blisters. The lesions often occur in a line where the person has brushed aside the stems. The bullae can be massive and irritating, and brown pigmentation may remain for years after healing (Morton 1975, Gunby 1980).

References:

Anon. 1970. The giant hogweed. *Lancet*, 2: 32.

Drever, J. C., Hunter, J. A. 1970. Hazards of giant hogweed. *Br. Med. J.*, 3: 109.

Gunby, P. 1980. Keep away from that 'tree', folks! *J. Am. Med. Assoc.*, 244: 2596.

Morton, J. K. 1975. The giant cow parsnip, *Heracleum mantegazzianum* Umbelliferae, in Canada. *Can. Field-Nat.*, 89: 183-184.

[Another search?](#)

[Français](#) | [Contact Us](#) | [Help](#) | [Search](#) | [Canada site](#)

[Coming Events](#) | [About CBIF](#) | [Links](#) | [Reports and Publications](#) |

[Home](#)

Date modified: 2003-02-06

[Important Notices](#)



Français	Contact us	Help	Search	Canada site
Coming events	About CBIF	Links	Reports and publications	Home

Canadian Biodiversity Information Facility



Notes on poisoning: *Humulus lupulus*

[Introduction](#)[Interactive](#)[All poisonous plants by Botanical name](#)[All poisonous plants by Common name](#)[Important WWW Poisonous Plants sites](#)

General poisoning notes:

Hop (*Humulus lupulus*) is cultivated for its use in beer-making. It is also used as an ornamental vine in many areas. Hop pickers can develop dermatitis from working with common hop plants (Raith and Jager 1984, Fuller and McClintock 1986).



References:

- Fuller, T. C., McClintock, E. 1986. Poisonous plants of California. Univ. California Press, Berkeley, Calif., USA. 432 pp.
- Raith, L., Jager, K. 1984. Hop allergy. Contact Dermatitis, 11: 53.

Nomenclature:

Scientific Name: *Humulus lupulus* L.

Vernacular name(s): common hop

Scientific family name: *Cannabaceae*

Vernacular family name: hemp

Go to ITIS*^{ca} for more taxonomic information on: [Humulus lupulus](#)

References:

Agriculture Quebec. 1975. Noms des maladies des plantes du Canada/ Names of plant diseases in Canada. , Quebec City, Que., Canada. 288 pp.

Alex, J. F., Cayouette, R., Mulligan, G. A. 1980. Common and botanical names of weeds in Canada/Noms populaire et scientifiques des plantes nuisibles du Canada. Revised. Agric.

Can. Publ., Ottawa, Ont., Canada. 132 pp.

Bailey, L. H., Bailey, E. Z. 1976. Hortus third. Revised. MacMillan, New York, N.Y., USA. 1290 pp.

Scoggan, H. J. 1978, 1979. The flora of Canada. Nat. Mus. Nat. Sci. (Ottawa) Publ. Bot. 7(1)-7(4). 1711 pp.

Van Wijk, H. L. 1911. A dictionary of plant names. Martinus Nijhoff, The Hague, The Netherlands. 1444 pp.

Victorin, M. 1964. Flore Laurentienne. 2nd ed. Univ. Montreal, Montreal, Que., Canada. 952 pp.

Geographic Information

British Columbia

Manitoba

New Brunswick

Nova Scotia

Ontario

Prince Edward Island

Quebec

Saskatchewan

References:

Bailey, L. H., Bailey, E. Z. 1976. Hortus third. Revised. MacMillan, New York, N.Y., USA. 1290 pp.

Boivin, B. 1966, 1967. Énumération des plantes du Canada. Provencheria 6. Nat. Can. (Que.) 93: 253-274; 371-437; 583-646; 989-1063. 94: 131-157; 471-528; 625-655.

Image or illustration

Humulus lupulus:

Images: images.google.com

Notes on Poisonous plant parts:

In addition to allergic responses, the hairs on the leaves may cause mechanical abrasion of the skin (Fuller and McClintock 1986).

Toxic parts:

leaves

mature fruit

References:

Fuller, T. C., McClintock, E. 1986. Poisonous plants of California. Univ. California Press, Berkeley, Calif., USA. 432 pp.

Toxic plant chemicals:

unknown chemical

References:

Fuller, T. C., McClintock, E. 1986. Poisonous plants of California. Univ. California Press, Berkeley, Calif., USA. 432 pp.

Animals/Human Poisoning:

Note: When an animal is listed without additional information, the literature (as of 1993) contained no detailed explanation.

Humans

General symptoms of poisoning:

[blistering](#)

[conjunctivitis](#)

[erythema](#)

References:

Fuller, T. C., McClintock, E. 1986. Poisonous plants of California. Univ. California Press, Berkeley, Calif., USA. 432 pp.

Raith, L., Jager, K. 1984. Hop allergy. Contact Dermatitis, 11: 53.

[Another search?](#)

[Français](#) | [Contact Us](#) | [Help](#) | [Search](#) | [Canada site](#)

[Coming Events](#) | [About CBIF](#) | [Links](#) | [Reports and Publications](#) | [Home](#)

Date modified: 2003-02-06

[Important Notices](#)



Français	Contact us	Help	Search	Canada site
Coming events	About CBIF	Links	Reports and publications	Home

Canadian Biodiversity Information Facility



Notes on poisoning: *Hyacinthoides nonscripta*

[Introduction](#)[Interactive](#)[All poisonous plants by Botanical name](#)[All poisonous plants by Common name](#)[Important WWW Poisonous Plants sites](#)

General poisoning notes:

English bluebell (*Endymion non-scriptus*) is an ornamental bulb plant that is grown outdoors and forced indoors for its early spring flowers. This species was formerly included under the genus *Scilla*. The plant contains glycosides, which are chemically similar to the cardiac glycoside digitalis. Cattle, a horse, and humans were poisoned after ingesting this plant. Children or family pets should be prevented from chewing the plants (Cooper and Johnson 1984).

References:

Cooper, M. R., Johnson, A. W. 1984. Poisonous plants in Britain and their effects on animals and man. Her Majesty's Stationery Office, London, England. 305 pp.

Nomenclature:

Scientific Name: *Hyacinthoides nonscripta* (L.) Garcke

Vernacular name(s): English bluebell

Scientific family name: *Liliaceae*

Vernacular family name: lily

Go to ITIS^{*ca} for more taxonomic information on: [Hyacinthoides nonscripta](#)

References:

Agriculture Quebec. 1975. Noms des maladies des plantes du Canada/ Names of plant diseases in Canada. , Quebec City, Que., Canada. 288 pp.

Alex, J. F., Cayouette, R., Mulligan, G. A. 1980. Common and

botanical names of weeds in Canada/Noms populaire et scientifiques des plantes nuisibles du Canada. Revised. Agric. Can. Publ., Ottawa, Ont., Canada. 132 pp.

Bailey, L. H., Bailey, E. Z. 1976. Hortus third. Revised. MacMillan, New York, N.Y., USA. 1290 pp.

Scoggan, H. J. 1978, 1979. The flora of Canada. Nat. Mus. Nat. Sci. (Ottawa) Publ. Bot. 7(1)-7(4). 1711 pp.

Van Wijk, H. L. 1911. A dictionary of plant names. Martinus Nijhoff, The Hague, The Netherlands. 1444 pp.

Victorin, M. 1964. Flore Laurentienne. 2nd ed. Univ. Montreal, Montreal, Que., Canada. 952 pp.

Geographic Information

Plant or plant parts used in or around the home.

References:

Bailey, L. H., Bailey, E. Z. 1976. Hortus third. Revised. MacMillan, New York, N.Y., USA. 1290 pp.

Boivin, B. 1966, 1967. Énumération des plantes du Canada. Provencheria 6. Nat. Can. (Que.) 93: 253-274; 371-437; 583-646; 989-1063. 94: 131-157; 471-528; 625-655.

Image or illustration

Hyacinthoides nonscripta:

Images: images.google.com

Toxic parts:

all parts
bulbs
flowers
leaves

References:

Cooper, M. R., Johnson, A. W. 1984. Poisonous plants in Britain and their effects on animals and man. Her Majesty's Stationery Office, London, England. 305 pp.

Notes on Toxic plant chemicals:

The plant contains glycosides, generally termed scillarens, which

are similar to the cardiac glycoside digitalis (Cooper and Johnson 1984).

Toxic plant chemicals:

unknown chemical

References:

Cooper, M. R., Johnson, A. W. 1984. Poisonous plants in Britain and their effects on animals and man. Her Majesty's Stationery Office, London, England. 305 pp.

Animals/Human Poisoning:

Note: When an animal is listed without additional information, the literature (as of 1993) contained no detailed explanation.

Cattle

General symptoms of poisoning:

[breathing, shallow](#)

[heart rate, slow](#)

[lethargy](#)

[temperature, depressed](#)

Notes on poisoning:

A group of cows and calves in Britain grazed on English bluebells and a few days later became dull and lethargic, chewed intermittently, and produced hard, dry feces. Temperature and respiration were decreased and heart beat became erratic. Lactating cows became dry. Recovery was slow when the cows were removed from the plants and given extra feed (Cooper and Johnson 1984).

References:

Cooper, M. R., Johnson, A. W. 1984. Poisonous plants in Britain and their effects on animals and man. Her Majesty's Stationery Office, London, England. 305 pp.

Horses

General symptoms of poisoning:

[abdominal pains](#)

[diarrhea](#)

[skin, cold and moist
temperature, depressed
urination, absent
vomiting](#)

Notes on poisoning:

A horse that ate several bulbs of English bluebell became ill within 6 h. Symptoms included initial choking, abdominal pain, slow pulse, low temperature, and cold, clammy skin. Within 10 h the animal produced dark-colored diarrhea with blood and ceased urinating. The horse recovered slowly, passing blood-stained urine for several days (Cooper and Johnson 1984).

References:

Cooper, M. R., Johnson, A. W. 1984. Poisonous plants in Britain and their effects on animals and man. Her Majesty's Stationery Office, London, England. 305 pp.

Humans

General symptoms of poisoning:

[abdominal pains](#)
[diarrhea](#)
[heart rate, slow](#)
[skin, flushed](#)

References:

Cooper, M. R., Johnson, A. W. 1984. Poisonous plants in Britain and their effects on animals and man. Her Majesty's Stationery Office, London, England. 305 pp.

[Another search?](#)

[Français](#) | [Contact Us](#) | [Help](#) | [Search](#) | [Canada site](#)
[Coming Events](#) | [About CBIF](#) | [Links](#) | [Reports and Publications](#) | [Home](#)

Date modified: 2003-02-06

[Important Notices](#)



Français	Contact us	Help	Search	Canada site
Coming events	About CBIF	Links	Reports and publications	Home

Canadian Biodiversity Information Facility



Notes on poisoning: *Hydrangea macrophylla*

[Introduction](#)[Interactive](#)[All poisonous plants by Botanical name](#)[All poisonous plants by Common name](#)[Important WWW Poisonous Plants sites](#)

General poisoning notes:

Hydrangea (*Hydrangea macrophylla*) is an outdoor ornamental that is grown in the warmer parts of Canada. This plant has poisoned humans after they ingested the flower buds. Sensitive individuals can develop dermatitis after exposure to hydrangea. Older case reports of poisoning of horses and cattle appear in the literature, but no recent reports are available (Apted 1973, Bruynzeel 1986, Fuller and McClintock 1986).

References:

Apted, J. H. 1973. Phytodermatitis from hydrangeas. Arch. Dermatol., 108: 427.

Bruynzeel, D. P. 1986. Allergic contact dermatitis to hydrangea. Contact Dermatitis, 14: 128.

Cooper, M. R., Johnson, A. W. 1984. Poisonous plants in Britain and their effects on animals and man. Her Majesty's Stationery Office, London, England. 305 pp.

Fuller, T. C., McClintock, E. 1986. Poisonous plants of California. Univ. California Press, Berkeley, Calif., USA. 432 pp.

Nomenclature:

Scientific Name: *Hydrangea macrophylla* (Thunb.) Ser.

Vernacular name(s): hydrangea

Scientific family name: *Saxifragaceae*

Vernacular family name: saxifrage

Go to ITIS^{*ca} for more taxonomic information on: [Hydrangea macrophylla](#)

References:

Agriculture Quebec. 1975. Noms des maladies des plantes du Canada/ Names of plant diseases in Canada. , Quebec City, Que., Canada. 288 pp.

Alex, J. F., Cayouette, R., Mulligan, G. A. 1980. Common and botanical names of weeds in Canada/Noms populaire et scientifiques des plantes nuisibles du Canada. Revised. Agric. Can. Publ., Ottawa, Ont., Canada. 132 pp.

Bailey, L. H., Bailey, E. Z. 1976. Hortus third. Revised. MacMillan, New York, N.Y., USA. 1290 pp.

Scoggan, H. J. 1978, 1979. The flora of Canada. Nat. Mus. Nat. Sci. (Ottawa) Publ. Bot. 7(1)-7(4). 1711 pp.

Van Wijk, H. L. 1911. A dictionary of plant names. Martinus Nijhoff, The Hague, The Netherlands. 1444 pp.

Victorin, M. 1964. Flore Laurentienne. 2nd ed. Univ. Montreal, Montreal, Que., Canada. 952 pp.

Geographic Information

Plant or plant parts used in or around the home.

References:

Bailey, L. H., Bailey, E. Z. 1976. Hortus third. Revised. MacMillan, New York, N.Y., USA. 1290 pp.

Boivin, B. 1966, 1967. Énumération des plantes du Canada. Provencheria 6. Nat. Can. (Que.) 93: 253-274; 371-437; 583-646; 989-1063. 94: 131-157; 471-528; 625-655.

Image or illustration

Hydrangea macrophylla:

Images: images.google.com

Toxic parts:

flower buds
leaves

References:

Der Marderosian, A. H., Giller, F. B., Roia, F. C. 1976. Phytochemical and toxicological screening of household ornamental plants potentially toxic to humans. 1. J. Toxicol.

Environ. Health, 1: 939-953.

Notes on Toxic plant chemicals:

Hydragin, a cyanogenetic glycoside, is presumed to be responsible for toxicity because it can release hydrocyanic acid upon hydrolysis. Der Marderosian and Roia (1976) administered 3 g of plant extract intraperitoneally, in 10 mL of liquid suspension per 100 g of body weight. All rats died when given extracts from hydrangea flowers and leaves. No mice died when orally fed 100 mg of flower material per 35 g body weight.

Toxic plant chemicals:

hydragin

References:

Der Marderosian, A. H., Giller, F. B., Roia, F. C. 1976. Phytochemical and toxicological screening of household ornamental plants potentially toxic to humans. 1. J. Toxicol. Environ. Health, 1: 939-953.

Lampe, K. F., McCann, M. A. 1985. AMA Handbook of poisonous and injurious plants. American Medical Assoc. Chicago, Ill., USA. 432 pp.

Animals/Human Poisoning:

Note: When an animal is listed without additional information, the literature (as of 1993) contained no detailed explanation.

Cattle

General symptoms of poisoning:

[abdominal pains](#)

[breathing, labored](#)

[diarrhea](#)

References:

Cooper, M. R., Johnson, A. W. 1984. Poisonous plants in Britain and their effects on animals and man. Her Majesty's Stationery Office, London, England. 305 pp.

Horses

General symptoms of poisoning:

[diarrhea](#)

Notes on poisoning:

A horse that ingested hydrangea experienced contraction of the abdominal muscles, diarrhea, and stiffness of limbs (Cooper and Johnson 1984).

References:

Cooper, M. R., Johnson, A. W. 1984. Poisonous plants in Britain and their effects on animals and man. Her Majesty's Stationery Office, London, England. 305 pp.

Humans

General symptoms of poisoning:

[abdominal pains](#)

[coma](#)

[diarrhea](#)

[erythema](#)

[gastroenteritis](#)

[lethargy](#)

[vomiting](#)

Notes on poisoning:

Ingesting hydrangea flower buds has resulted in poisoning (Fuller and McClintock 1986).

References:

Apted, J. H. 1973. Phytodermatitis from hydrangeas. Arch. Dermatol., 108: 427.

Fuller, T. C., McClintock, E. 1986. Poisonous plants of California. Univ. California Press, Berkeley, Calif., USA. 432 pp.

[Another search?](#)

[Français](#) | [Contact Us](#) | [Help](#) | [Search](#) | [Canada site](#)

[Coming Events](#) | [About CBIF](#) | [Links](#) | [Reports and Publications](#) |

[Home](#)

Date modified: 2003-02-06

[Important Notices](#)



Français	Contact us	Help	Search	Canada site
Coming events	About CBIF	Links	Reports and publications	Home

Canadian Biodiversity Information Facility



Notes on poisoning: *Hymenoxys richardsonii*

[Introduction](#)[Interactive](#)[All poisonous plants by Botanical name](#)[All poisonous plants by Common name](#)[Important WWW Poisonous Plants sites](#)

General poisoning notes:

Colorado rubberweed (*Hymenoxys richardsonii*) is a native herb found in the southern prairies. This plant has caused poisoning and death in sheep, goats, and occasionally cattle. Sheep and goats consume this plant when there is little else to eat. Poisoning is therefore most frequent in spring and late autumn, when other forage is reduced. Cattle are poisoned less frequently because they find the plant unpalatable (Cheeke and Schull 1985).

References:

Cheeke, P. R., Shull, L. R. 1985. Natural toxicants in feeds and poisonous plants. AVI Publishing Company, Inc., Westport, Conn., USA. 492 pp.

Parker, K. W. 1936. Prevention of death losses in sheep on areas infested with pingue (*Actinea richardsoni*). N. M. Agric. Exp. Stn. Bull., 241. 53 pp.

Nomenclature:

Scientific Name: *Hymenoxys richardsonii* (Hook.) Cockerell

Vernacular name(s): Colorado rubberweed

Scientific family name: *Compositae*

Vernacular family name: composite

Go to ITIS*^{ca} for more taxonomic information on: [Hymenoxys richardsonii](#)

References:

Agriculture Quebec. 1975. Noms des maladies des plantes du Canada/ Names of plant diseases in Canada. , Quebec City, Que.,

Canada. 288 pp.

Alex, J. F., Cayouette, R., Mulligan, G. A. 1980. Common and botanical names of weeds in Canada/Noms populaire et scientifiques des plantes nuisibles du Canada. Revised. Agric. Can. Publ., Ottawa, Ont., Canada. 132 pp.

Bailey, L. H., Bailey, E. Z. 1976. Hortus third. Revised. MacMillan, New York, N.Y., USA. 1290 pp.

Scoggan, H. J. 1978, 1979. The flora of Canada. Nat. Mus. Nat. Sci. (Ottawa) Publ. Bot. 7(1)-7(4). 1711 pp.

Van Wijk, H. L. 1911. A dictionary of plant names. Martinus Nijhoff, The Hague, The Netherlands. 1444 pp.

Victorin, M. 1964. Flore Laurentienne. 2nd ed. Univ. Montreal, Montreal, Que., Canada. 952 pp.

Geographic Information

Alberta
Saskatchewan

References:

Bailey, L. H., Bailey, E. Z. 1976. Hortus third. Revised. MacMillan, New York, N.Y., USA. 1290 pp.

Boivin, B. 1966, 1967. Énumération des plantes du Canada. Provencheria 6. Nat. Can. (Que.) 93: 253-274; 371-437; 583-646; 989-1063. 94: 131-157; 471-528; 625-655.

Image or illustration

Hymenoxys richardsonii:

Images: images.google.com

Toxic parts:

all parts
leaves
stems

References:

Cheeke, P. R., Shull, L. R. 1985. Natural toxicants in feeds and poisonous plants. AVI Publishing Company, Inc., Westport, Conn., USA. 492 pp.

Notes on Toxic plant chemicals:

Hymenovin (hymenoxon) is a sesquiterpene lactone that contains an alpha-methylene-gamma-lactone moiety. This moiety inhibits the enzymatic capability of adenylate cyclase by alkylation of its thiol group. The inhibition can disrupt the cellular transmission of external signals to the internal regulatory proteins. Mercaptans, such as cysteine, may be used in treatment by partly detoxifying the moiety before it can damage cellular enzymes (Elissalde and Ivie 1987). The oral LD-50 of hymenovin (hymenoxon) is 2.9-8.5 g/kg in sheep (Cheeke and Schull 1985).

Toxic plant chemicals:

hymenovin

References:

Cheeke, P. R., Shull, L. R. 1985. Natural toxicants in feeds and poisonous plants. AVI Publishing Company, Inc., Westport, Conn., USA. 492 pp.

Elissalde, M. H., Ivie, G. W. 1987. Inhibition of macrophage adenylate cyclase by the alpha-methylene-gamma-lactone moiety of sesquiterpene lactones from forage plants. Am. J. Vet. Res., 48: 148-152.

Animals/Human Poisoning:

Note: When an animal is listed without additional information, the literature (as of 1993) contained no detailed explanation.

Cattle

Goats

Sheep

General symptoms of poisoning:

[death](#)

[kidney, congestion of](#)

[liver, congestion of](#)

[lungs, congestion of](#)

[vomiting](#)

Notes on poisoning:

Symptoms of ingestion include violent vomiting, hence the name

spewing sickness. Sheep may have a green stain around the mouth. Vomited material can be inhaled, which can lead to inhalation pneumonia, permanent lung damage, or death. Lesions in the gastrointestinal tract, liver and kidney congestion, and lung damage occur. Frequent coughing and sneezing occur (Parker, Cheeke and Schull 1985).

References:

Cheeke, P. R., Shull, L. R. 1985. Natural toxicants in feeds and poisonous plants. AVI Publishing Company, Inc., Westport, Conn., USA. 492 pp.

Parker, K. W. 1936. Prevention of death losses in sheep on areas infested with pingue (*Actinea richardsoni*). N. M. Agric. Exp. Stn. Bull., 241. 53 pp.

[Another search?](#)

[Français](#) | [Contact Us](#) | [Help](#) | [Search](#) | [Canada site](#)

[Coming Events](#) | [About CBIF](#) | [Links](#) | [Reports and Publications](#) | [Home](#)

Date modified: 2003-02-06

[Important Notices](#)



Français	Contact us	Help	Search	Canada site
Coming events	About CBIF	Links	Reports and publications	Home

Canadian Biodiversity Information Facility



Notes on poisoning: *Hyoscyamus niger*

[Introduction](#)[Interactive](#)[All poisonous plants by Botanical name](#)[All poisonous plants by Common name](#)[Important WWW Poisonous Plants sites](#)

General poisoning notes:

Black henbane (*Hyoscyamus niger*) is a naturalized herb found across parts of southern Canada. This plant contains several alkaloids, and it has caused rare poisoning in humans, cattle, poultry, and swine. Human poisoning has been accidental or purposeful because of its reported medicinal or hallucinogenic properties. Black henbane has been used medicinally since ancient times to help with a variety of health problems and as a preventative. Its hallucinogenic effects have led people to eat the seed or chew the flowers, often with detrimental results. Ingestion causes anticholinergic syndrome with stimulatory and hallucinatory effects (Hocking 1947, Spoerke et al. 1987). Cattle have been poisoned in Europe after ingesting black henbane that was included in forage. The alkaloid content is retained upon drying, and ingestion is said to taint the milk of cows. Poultry have died after ingesting the seeds, and pigs have died after eating the roots (Cooper and Johnson 1984, Spoerke et al. 1987).

References:

Cooper, M. R., Johnson, A. W. 1984. Poisonous plants in Britain and their effects on animals and man. Her Majesty's Stationery Office, London, England. 305 pp.

Hocking, G. M. 1947. Henbane - healing herb of Hercules and of Apollo. Econ. Bot., 1: 306-316.

Spoerke, D. G., Hall, A. H., Dodson, C. D., Stermitz, F. R., Swanson, C. H., Rumack, B. H. 1987. Mystery root ingestion. J. Emerg. Med., 5: 385-388.

Nomenclature:

Scientific Name: *Hyoscyamus niger* L.

Vernacular name(s): black henbane

Scientific family name: *Solanaceae*

Vernacular family name: nightshade

Go to ITIS^{*ca} for more taxonomic information on: [Hyoscyamus niger](#)

References:

Agriculture Quebec. 1975. Noms des maladies des plantes du Canada/ Names of plant diseases in Canada. , Quebec City, Que., Canada. 288 pp.

Alex, J. F., Cayouette, R., Mulligan, G. A. 1980. Common and botanical names of weeds in Canada/Noms populaire et scientifiques des plantes nuisibles du Canada. Revised. Agric. Can. Publ., Ottawa, Ont., Canada. 132 pp.

Bailey, L. H., Bailey, E. Z. 1976. Hortus third. Revised. MacMillan, New York, N.Y., USA. 1290 pp.

Scoggan, H. J. 1978, 1979. The flora of Canada. Nat. Mus. Nat. Sci. (Ottawa) Publ. Bot. 7(1)-7(4). 1711 pp.

Van Wijk, H. L. 1911. A dictionary of plant names. Martinus Nijhoff, The Hague, The Netherlands. 1444 pp.

Victorin, M. 1964. Flore Laurentienne. 2nd ed. Univ. Montreal, Montreal, Que., Canada. 952 pp.

Geographic Information

Alberta
Manitoba
New Brunswick
Nova Scotia
Ontario
Quebec
Saskatchewan

References:

Bailey, L. H., Bailey, E. Z. 1976. Hortus third. Revised. MacMillan, New York, N.Y., USA. 1290 pp.

Boivin, B. 1966, 1967. Énumération des plantes du Canada. Provencheria 6. Nat. Can. (Que.) 93: 253-274; 371-437; 583-646; 989-1063. 94: 131-157; 471-528; 625-655.

Image or illustration

Hyoscyamus niger:

Images: images.google.com

Notes on Poisonous plant parts:

All parts of the plant contain alkaloids in varying quantities (see the additional notes under chemicals). Ingestion of four flowers has caused some symptoms in humans (Frohne and Pfander 1983, Spoerke et al. 1987).

Toxic parts:

all parts
flowers
leaves
roots
seeds

References:

Frohne, D., Pfander, H. J. 1983. A colour atlas of poisonous plants. Wolfe Publishing Ltd., London, England. 291 pp.

Notes on Toxic plant chemicals:

Hyoscyamine, hyoscyne, and atropine can all be found in black henbane. The alkaloid content has been measured at 0.08% (roots), 0.17% (leaves), and 0.3% (seeds). The major affect of hyoscyamine is depression of the central nervous system (Frohne and Pfander 1983; Cooper and Johnson 1984).

Toxic plant chemicals:

atropine
hyoscyne(scopolamine)
hyoscyamine

References:

Cooper, M. R., Johnson, A. W. 1984. Poisonous plants in Britain and their effects on animals and man. Her Majesty's Stationery Office, London, England. 305 pp.

Frohne, D., Pfander, H. J. 1983. A colour atlas of poisonous plants. Wolfe Publishing Ltd., London, England. 291 pp.

Animals/Human Poisoning:

Note: When an animal is listed without additional information, the literature (as of 1993) contained no detailed explanation.

Cattle

General symptoms of poisoning:

[bloat](#)

[breathing, labored](#)

[convulsions](#)

[cyanosis](#)

[heart rate, elevated](#)

[incoordination](#)

[pupil dilation](#)

[restlessness](#)

Notes on poisoning:

Symptoms of ingestion include restlessness, excitation, convulsions, pupil dilation, difficulty in breathing, increased heart rate, and bloat. Postmortem examination showed degeneration of heart muscle and cyanosis of mucous membranes (Cooper and Johnson 1984).

References:

Cooper, M. R., Johnson, A. W. 1984. Poisonous plants in Britain and their effects on animals and man. Her Majesty's Stationery Office, London, England. 305 pp.

Humans

General symptoms of poisoning:

[coma](#)

[confusion](#)

[death](#)

[hallucination](#)

[mouth dry](#)

[nausea](#)

[pupil dilation](#)

[skin, flushed](#)

[vomiting](#)

Notes on poisoning:

Symptoms of poisoning include thirst, dry mouth, dilated pupils,

warm and flushed skin, and hallucinations. Purposeless movements, such as picking at the air, have been observed. Heart rate is elevated. These are the symptoms that occur after the roots are ingested. Ingesting the flowers has caused agitation, restlessness, dry skin, and pupil dilation (Spoerke et al. 1987).

References:

Hocking, G. M. 1947. Henbane - healing herb of Hercules and of Apollo. *Econ. Bot.*, 1: 306-316.

Spoerke, D. G., Hall, A. H., Dodson, C. D., Stermitz, F. R., Swanson, C. H., Rumack, B. H. 1987. Mystery root ingestion. *J. Emerg. Med.*, 5: 385-388.

Poultry

Swine

[Another search?](#)

[Français](#) | [Contact Us](#) | [Help](#) | [Search](#) | [Canada site](#)

[Coming Events](#) | [About CBIF](#) | [Links](#) | [Reports and Publications](#) |

[Home](#)

Date modified: 2003-02-06

[Important Notices](#)



Français	Contact us	Help	Search	Canada site
Coming events	About CBIF	Links	Reports and publications	Home

Canadian Biodiversity Information Facility



Notes on poisoning: *Hypericum perforatum*

[Introduction](#)[Interactive](#)[All poisonous plants by Botanical name](#)[All poisonous plants by Common name](#)[Important WWW Poisonous Plants sites](#)

General poisoning notes:

St. John's-wort (*Hypericum perforatum*) is a naturalized herb found in eastern Canada and British Columbia. The plant contains hypericin, which is a primary photosensitizing chemical. Ingestion has caused skin problems in cattle, horses, rabbits, sheep, and swine. The skin problems occur on white or light-colored skin; dark skin is not affected. Severe symptoms such as convulsions, staggering, and coma have occurred in some animals. Loss of wool quality occurs in sheep, and the meat of affected animals is of poor quality. This plant is widespread in Canada. The reaction is more severe if fresh plants are eaten, but dried plants can also cause photosensitization, even though 80% of the hypericin is lost (Araya and Ford 1981, Cooper and Johnson 1984, Crompton et al. 1988).

References:

- Araya, O. S., Ford, E. J. 1981. An investigation of the type of photosensitization caused by the ingestion of St John's wort (*Hypericum perforatum*) by calves. J. Comp. Pathol., 91: 135-141.
- Cooper, M. R., Johnson, A. W. 1984. Poisonous plants in Britain and their effects on animals and man. Her Majesty's Stationery Office, London, England. 305 pp.
- Crompton, C. W., Hall, I. V., Jensen, K. I., Hildebrand, P. D. 1988. The biology of Canadian weeds. 83. *Hypericum perforatum* L. Can. J. Plant Sci., 68: 149-162.

Nomenclature:

Scientific Name: *Hypericum perforatum* L.

Vernacular name(s): St. John's-wort

Scientific family name: *Guttiferae*

Vernacular family name: St. John's-wort

Go to ITIS^{*ca} for more taxonomic information on: [Hypericum perforatum](#)

References:

Agriculture Quebec. 1975. Noms des maladies des plantes du Canada/ Names of plant diseases in Canada. , Quebec City, Que., Canada. 288 pp.

Alex, J. F., Cayouette, R., Mulligan, G. A. 1980. Common and botanical names of weeds in Canada/Noms populaire et scientifiques des plantes nuisibles du Canada. Revised. Agric. Can. Publ., Ottawa, Ont., Canada. 132 pp.

Bailey, L. H., Bailey, E. Z. 1976. Hortus third. Revised. MacMillan, New York, N.Y., USA. 1290 pp.

Scoggan, H. J. 1978, 1979. The flora of Canada. Nat. Mus. Nat. Sci. (Ottawa) Publ. Bot. 7(1)-7(4). 1711 pp.

Van Wijk, H. L. 1911. A dictionary of plant names. Martinus Nijhoff, The Hague, The Netherlands. 1444 pp.

Victorin, M. 1964. Flore Laurentienne. 2nd ed. Univ. Montreal, Montreal, Que., Canada. 952 pp.

Geographic Information

British Columbia
New Brunswick
Newfoundland
Nova Scotia
Ontario
Prince Edward Island
Quebec

References:

Bailey, L. H., Bailey, E. Z. 1976. Hortus third. Revised. MacMillan, New York, N.Y., USA. 1290 pp.

Boivin, B. 1966, 1967. Énumération des plantes du Canada. Provencheria 6. Nat. Can. (Que.) 93: 253-274; 371-437; 583-646; 989-1063. 94: 131-157; 471-528; 625-655.

Image or illustration

Hypericum perforatum:

Images: images.google.com

Toxic parts:

flowers
leaves

References:

Araya, O. S., Ford, E. J. 1981. An investigation of the type of photosensitization caused by the ingestion of St John's wort (*Hypericum perforatum*) by calves. J. Comp. Pathol., 91: 135-141.

Notes on Toxic plant chemicals:

Hypericin, a fluorescent pigment, is regarded as a derivative of naphthodianthrone. The pigment is contained in small black dots that are just visible to the naked eye on leaves and petals. The chemical is a primary photosensitizer because the photodynamic action occurs in the skin (Araya and Ford 1981).

Toxic plant chemicals:

hypericin

References:

Araya, O. S., Ford, E. J. 1981. An investigation of the type of photosensitization caused by the ingestion of St John's wort (*Hypericum perforatum*) by calves. J. Comp. Pathol., 91: 135-141.

Animals/Human Poisoning:

Note: When an animal is listed without additional information, the literature (as of 1993) contained no detailed explanation.

Cattle

General symptoms of poisoning:

[muzzle, dry](#)

[restlessness](#)

[skin, dry](#)

References:

Araya, O. S., Ford, E. J. 1981. An investigation of the type of photosensitization caused by the ingestion of St John's wort (*Hypericum perforatum*) by calves. J. Comp. Pathol., 91: 135-141.

Horses

General symptoms of poisoning:

[appetite, loss of](#)

[coma](#)

[gait, staggering](#)

[skin, peeling of](#)

References:

Cooper, M. R., Johnson, A. W. 1984. Poisonous plants in Britain and their effects on animals and man. Her Majesty's Stationery Office, London, England. 305 pp.

Rabbits

General symptoms of poisoning:

[death](#)

[liver, cirrhosis of](#)

[skin, peeling of](#)

References:

Cooper, M. R., Johnson, A. W. 1984. Poisonous plants in Britain and their effects on animals and man. Her Majesty's Stationery Office, London, England. 305 pp.

Sheep

General symptoms of poisoning:

[convulsions](#)

[erythema](#)

[skin, peeling of](#)

References:

Cooper, M. R., Johnson, A. W. 1984. Poisonous plants in Britain and their effects on animals and man. Her Majesty's Stationery Office, London, England. 305 pp.

Swine

General symptoms of poisoning:

[skin, flushed](#)

[skin, peeling of](#)

References:

Cooper, M. R., Johnson, A. W. 1984. Poisonous plants in Britain and their effects on animals and man. Her Majesty's Stationery Office, London, England. 305 pp.

[Another search?](#)

[Français](#) | [Contact Us](#) | [Help](#) | [Search](#) | [Canada site](#)

[Coming Events](#) | [About CBIF](#) | [Links](#) | [Reports and Publications](#) | [Home](#)

Date modified: 2003-02-06

[Important Notices](#)



Français	Contact us	Help	Search	Canada site
Coming events	About CBIF	Links	Reports and publications	Home

Canadian Biodiversity Information Facility



Notes on poisoning: *Ilex aquifolium*

[Introduction](#)[Interactive](#)[All poisonous plants by Botanical name](#)[All poisonous plants by Common name](#)[Important WWW Poisonous Plants sites](#)

General poisoning notes:

English holly (*Ilex aquifolium*) has been implicated in cases where children have eaten the berries. Kingsbury (1969) noted that the often-quoted fatal dosage of 20-30 berries comes from European literature before 1889 and that this quantity has not been confirmed. Modern references show that symptoms are usually confined to vomiting and diarrhea (Cooper and Johnson 1984, Lampe and McCann 1985). This holly is used as an outdoor ornamental, and the glossy green leaves and red berries may be sold as Christmas decorations.

References:



Cooper, M. R., Johnson, A. W. 1984. Poisonous plants in Britain and their effects on animals and man. Her Majesty's Stationery Office, London, England. 305 pp.

Kingsbury, J. M. 1969. Phytotoxicity 1. Major problems associated with poisonous plants. Clin. Pharmacol. Ther., 10: 163-169.

Lampe, K. F., McCann, M. A. 1985. AMA Handbook of poisonous and injurious plants. American Medical Assoc. Chicago, Ill., USA. 432 pp.

Nomenclature:

Scientific Name: *Ilex aquifolium* L.

Vernacular name(s): English holly

Scientific family name: *Aquifoliaceae*

Vernacular family name: holly

Go to ITIS*^{ca} for more taxonomic information on: [Ilex aquifolium](#)

References:

Agriculture Quebec. 1975. Noms des maladies des plantes du Canada/ Names

of plant diseases in Canada. , Quebec City, Que., Canada. 288 pp.

Alex, J. F., Cayouette, R., Mulligan, G. A. 1980. Common and botanical names of weeds in Canada/Noms populaire et scientifiques des plantes nuisibles du Canada. Revised. Agric. Can. Publ., Ottawa, Ont., Canada. 132 pp.

Bailey, L. H., Bailey, E. Z. 1976. Hortus third. Revised. MacMillan, New York, N.Y., USA. 1290 pp.

Scoggan, H. J. 1978, 1979. The flora of Canada. Nat. Mus. Nat. Sci. (Ottawa) Publ. Bot. 7(1)-7(4). 1711 pp.

Van Wijk, H. L. 1911. A dictionary of plant names. Martinus Nijhoff, The Hague, The Netherlands. 1444 pp.

Victorin, M. 1964. Flore Laurentienne. 2nd ed. Univ. Montreal, Montreal, Que., Canada. 952 pp.

Geographic Information

British Columbia

References:

Bailey, L. H., Bailey, E. Z. 1976. Hortus third. Revised. MacMillan, New York, N.Y., USA. 1290 pp.

Boivin, B. 1966, 1967. Énumération des plantes du Canada. Provencheria 6. Nat. Can. (Que.) 93: 253-274; 371-437; 583-646; 989-1063. 94: 131-157; 471-528; 625-655.

Image or illustration

Ilex aquifolium:

Images: images.google.com

Toxic parts:

mature fruit

References:

Willems, M. 1988. A cyanogenic glucoside from *Ilex aquifolium*. Phytochemistry (Oxf.), 27: 1852-1853.

Notes on Toxic plant chemicals:

Ilicin, a glycoside, has been implicated as the toxic substance in in holly berries (Rodrigues et al. 1984). A cyanogenic glycoside,

(2-beta-D-glucopyranosyloxy-p-hydroxy-6,7-dihydromandelonitrile) has also been isolated from the berries of English holly. The chemical also occurs in lower concentrations in the leaves and stems. A common name for this chemical has not been established yet (Willems 1988).

Toxic plant chemicals:

-dihydromandelonitrile
ilicin

References:

Willems, M. 1988. A cyanogenic glucoside from *Ilex aquifolium*. *Phytochemistry* (Oxf.), 27: 1852-1853.

Animals/Human Poisoning:

Note: When an animal is listed without additional information, the literature (as of 1993) contained no detailed explanation.

Humans

General symptoms of poisoning:

[diarrhea](#)

[nausea](#)

[vomiting](#)

Notes on poisoning:

Symptoms include multiple episodes of vomiting, nausea, and diarrhea. If a large number of berries are ingested, vomiting should be induced with an emetic. Conservative management is generally adequate (Cooper and Johnson 1984, Lampe and McCann 1985).

References:

Cooper, M. R., Johnson, A. W. 1984. Poisonous plants in Britain and their effects on animals and man. Her Majesty's Stationery Office, London, England. 305 pp.

Lampe, K. F., McCann, M. A. 1985. AMA Handbook of poisonous and injurious plants. American Medical Assoc. Chicago, Ill., USA. 432 pp.

[Another search?](#)

[Français](#) | [Contact Us](#) | [Help](#) | [Search](#) | [Canada site](#)

[Coming Events](#) | [About CBIF](#) | [Links](#) | [Reports and Publications](#) | [Home](#)

Date modified: 2003-02-06

[Important Notices](#)



Français	Contact us	Help	Search	Canada site
Coming events	About CBIF	Links	Reports and publications	Home

Canadian Biodiversity Information Facility



Notes on poisoning: *Ilex opaca*

[Introduction](#)

[Interactive](#)

[All poisonous plants by Botanical name](#)

[All poisonous plants by Common name](#)

[Important WWW Poisonous Plants sites](#)

General poisoning notes:

American holly (*Ilex opaca*) is an ornamental shrub that provides glossy green leaves and red berries used in Christmas decorations. Ingested berries have been implicated in cases of poisoning of children. The symptoms included vomiting and diarrhea (Rodrigues et al. 1984, Lampe and McCann 1985).



References:

Lampe, K. F., McCann, M. A. 1985. AMA Handbook of poisonous and injurious plants. American Medical Assoc. Chicago, Ill., USA. 432 pp.

Rodrigues, T. D., Johnson, P. N., Jeffrey, L. P. 1984. Hollyberry ingestion. Case report. Vet. Hum. Toxicol., 26: 157-158.

Nomenclature:

Scientific Name: *Ilex opaca* Ait.

Vernacular name(s): American holly

Scientific family name: *Aquifoliaceae*

Vernacular family name: holly

Go to ITIS^{*ca} for more taxonomic information on: [Ilex opaca](#)

References:

Agriculture Quebec. 1975. Noms des maladies des plantes du Canada/ Names of plant diseases in Canada. , Quebec City, Que., Canada. 288 pp.

Alex, J. F., Cayouette, R., Mulligan, G. A. 1980. Common and botanical names of weeds in Canada/Noms populaire et

scientifiques des plantes nuisibles du Canada. Revised. Agric. Can. Publ., Ottawa, Ont., Canada. 132 pp.

Bailey, L. H., Bailey, E. Z. 1976. Hortus third. Revised. MacMillan, New York, N.Y., USA. 1290 pp.

Scoggan, H. J. 1978, 1979. The flora of Canada. Nat. Mus. Nat. Sci. (Ottawa) Publ. Bot. 7(1)-7(4). 1711 pp.

Van Wijk, H. L. 1911. A dictionary of plant names. Martinus Nijhoff, The Hague, The Netherlands. 1444 pp.

Victorin, M. 1964. Flore Laurentienne. 2nd ed. Univ. Montreal, Montreal, Que., Canada. 952 pp.

Geographic Information

Plant or plant parts used in or around the home.

References:

Bailey, L. H., Bailey, E. Z. 1976. Hortus third. Revised. MacMillan, New York, N.Y., USA. 1290 pp.

Boivin, B. 1966, 1967. Énumération des plantes du Canada. Provencheria 6. Nat. Can. (Que.) 93: 253-274; 371-437; 583-646; 989-1063. 94: 131-157; 471-528; 625-655.

Image or illustration

Ilex opaca:

Images: images.google.com

Toxic parts:

mature fruit

References:

Rodrigues, T. D., Johnson, P. N., Jeffrey, L. P. 1984. Hollyberry ingestion. Case report. Vet. Hum. Toxicol., 26: 157-158.

Notes on Toxic plant chemicals:

Ilicin is a crude extract that is a bitter glycoside. This extract has been implicated as the poisonous substance (Rodrigues et al. 1984).

Toxic plant chemicals:

ilicin

References:

Rodrigues, T. D., Johnson, P. N., Jeffrey, L. P. 1984. Hollyberry ingestion. Case report. Vet. Hum. Toxicol., 26: 157-158.

Animals/Human Poisoning:

Note: When an animal is listed without additional information, the literature (as of 1993) contained no detailed explanation.

Humans

General symptoms of poisoning:

[diarrhea](#)

[drowsiness](#)

[vomiting](#)

Notes on poisoning:

Ingestion of a "handful" of berries caused repeated vomiting, green, watery diarrhea, and passage of green semisoft stools. The drowsiness might have been associated with the ipecac-induced vomiting. Ingestion of berries usually results in mild symptoms unless a lot of berries are eaten. Children are more likely to eat the berries (Rodrigues et al. 1984).

References:

Rodrigues, T. D., Johnson, P. N., Jeffrey, L. P. 1984. Hollyberry ingestion. Case report. Vet. Hum. Toxicol., 26: 157-158.

[Another search?](#)

[Français](#) | [Contact Us](#) | [Help](#) | [Search](#) | [Canada site](#)

[Coming Events](#) | [About CBIF](#) | [Links](#) | [Reports and Publications](#) |

[Home](#)

Date modified: 2003-02-06

[Important Notices](#)



Français	Contact us	Help	Search	Canada site
Coming events	About CBIF	Links	Reports and publications	Home

Canadian Biodiversity Information Facility



Notes on poisoning: *Ipomoea tricolor*

[Introduction](#)[Interactive](#)[All poisonous plants by Botanical name](#)[All poisonous plants by Common name](#)[Important WWW Poisonous Plants sites](#)

General poisoning notes:

Hallucinations are the predominant effect after ingesting morning glory seeds. Ingesting 200-300 seeds produces an effect equivalent to 300 micro g of LSD. Vivid visual and tactile hallucinations, as well as increased awareness of colors have been described. Symptoms include facial flushing, nausea, mydriasis, diarrhea, and hypotension (Spoerke and Smolinske 1990).

Ipomoea tricolor has a long history of use as a human hallucinogen in southern Mexico, where the seeds were used in the preparation of a drink (Fuller and McClintock 1986). A single undocumented case of poisoning of a pet cat (after ingestion of seeds) has come to our attention. The cat showed erratic behavior and "looked like a lunatic". There was no apparent permanent damage afterwards. Several cultivars of *Ipomoea tricolor* are available in Canadian garden catalogs for home gardeners and, with few exceptions, no mention is made of any potential toxic affects from ingesting the seeds of these plants. Sample cultivars are "Heavenly Blue", "Pearly Gates", and "Scarlet O'Hara". The total alkaloid content is shown to vary, depending on the cultivar grown. It is advisable to remove and destroy the fruiting parts as they develop to avoid ingestion by children or pets.

References:

Fuller, T. C., McClintock, E. 1986. Poisonous plants of California. Univ. California Press, Berkeley, Calif., USA. 432 pp.

Spoerke, D. G., Smolinske, S. C. 1990. Toxicity of houseplants. CRC Press, Inc., Boca Raton, Fla., USA. 335 pp.

Nomenclature:

Vernacular name(s): morning glory

Scientific family name:

Vernacular family name: morning-glory

Go to ITIS^{*ca} for more taxonomic information on: [Ipomoea tricolor](#)

References:

Agriculture Quebec. 1975. Noms des maladies des plantes du Canada/ Names of plant diseases in Canada. , Quebec City, Que., Canada. 288 pp.

Alex, J. F., Cayouette, R., Mulligan, G. A. 1980. Common and botanical names of weeds in Canada/Noms populaire et scientifiques des plantes nuisibles du Canada. Revised. Agric. Can. Publ., Ottawa, Ont., Canada. 132 pp.

Bailey, L. H., Bailey, E. Z. 1976. Hortus third. Revised. MacMillan, New York, N.Y., USA. 1290 pp.

Scoggan, H. J. 1978, 1979. The flora of Canada. Nat. Mus. Nat. Sci. (Ottawa) Publ. Bot. 7(1)-7(4). 1711 pp.

Van Wijk, H. L. 1911. A dictionary of plant names. Martinus Nijhoff, The Hague, The Netherlands. 1444 pp.

Victorin, M. 1964. Flore Laurentienne. 2nd ed. Univ. Montreal, Montreal, Que., Canada. 952 pp.

Geographic Information

Plant or plant parts used in or around the home.

References:

Bailey, L. H., Bailey, E. Z. 1976. Hortus third. Revised. MacMillan, New York, N.Y., USA. 1290 pp.

Boivin, B. 1966, 1967. Énumération des plantes du Canada. Provencheria 6. Nat. Can. (Que.) 93: 253-274; 371-437; 583-646; 989-1063. 94: 131-157; 471-528; 625-655.

Image or illustration

Ipomoea tricolor:

Images: images.google.com

Notes on Poisonous plant parts:

The embryo of the seeds, and not the shell, contains the toxic chemicals. Ingesting 200-300 seeds can cause problems in adult

humans (Spoerke and Smolinske 1990).

Toxic parts:

seeds

References:

Spoerke, D. G., Smolinske, S. C. 1990. Toxicity of houseplants. CRC Press, Inc., Boca Raton, Fla., USA. 335 pp.

Notes on Toxic plant chemicals:

The seed embryos contain several indole alkaloids that have hallucinogenic activity. These include d-lysergic acid amide (0.035%), d-isolysergic acid amide (0.005%), and elymoclavine (0.005%). The total alkaloid content varies with different plant cultivars. For instance, the cultivar "Pearly Gates" had 0.041%, whereas "Scarlet O'Hara" had 0.002% total alkaloids (Spoerke and Smolinske 1990).

Toxic plant chemicals:

d-isolysergic acid amide

d-lysergic acid amide

elymoclavine

References:

Spoerke, D. G., Smolinske, S. C. 1990. Toxicity of houseplants. CRC Press, Inc., Boca Raton, Fla., USA. 335 pp.

Animals/Human Poisoning:

Note: When an animal is listed without additional information, the literature (as of 1993) contained no detailed explanation.

Cats

General symptoms of poisoning:

[pupil dilation](#)

Notes on poisoning:

In an undocumented case, a pet cat was attracted to the fruiting capsule of a morning glory vine growing on an apartment balcony. The dry fruiting capsule contained seeds that rattled in the wind. The cat ate an unknown quantity of seeds and later was

noted to run around chasing nothing. It meowed a lot and its eyes did not appear to focus on anything. The owner remarked that the cat "looked like a lunatic". There were no apparent lasting symptoms.

References:

Fuller, T. C., McClintock, E. 1986. Poisonous plants of California. Univ. California Press, Berkeley, Calif., USA. 432 pp.

Humans

General symptoms of poisoning:

[blood pressure, low](#)

[diarrhea](#)

[hallucination](#)

[nausea](#)

[pupil dilation](#)

Notes on poisoning:

In one reported case of deliberate ingestion of 250 seeds of morning glory, a 20-year-old women developed inappropriate responses and weeping. The pupils were dilated, the face flushed, and hyper- active reflexes were noted. After 5 h, anxiety, and increased awareness of colors was recorded, but without hallucinations. Diarrhea was noted after 9 h. Hypotension occurred intermittently. After 2 days most of the symptoms had disappeared, with the exception of dilated pupils and increased deep tendon reflexes (Spoerke and Smolinske 1990).

References:

Spoerke, D. G., Smolinske, S. C. 1990. Toxicity of houseplants. CRC Press, Inc., Boca Raton, Fla., USA. 335 pp.

[Another search?](#)

[Français](#) | [Contact Us](#) | [Help](#) | [Search](#) | [Canada site](#)

[Coming Events](#) | [About CBIF](#) | [Links](#) | [Reports and Publications](#) | [Home](#)

Date modified: 2003-02-06

[Important Notices](#)



Français	Contact us	Help	Search	Canada site
Coming events	About CBIF	Links	Reports and publications	Home

Canadian Biodiversity Information Facility



Notes on poisoning: *Iris pseudacorus*

[Introduction](#)

[Interactive](#)

[All poisonous plants by Botanical name](#)

[All poisonous plants by Common name](#)

[Important WWW Poisonous Plants sites](#)



General poisoning notes:

Yellow iris (*Iris pseudacorus*) is a naturalized plant found in wet areas in parts of southern Canada. This plant has poisoned cattle and swine and may cause similar symptoms in humans if the rhizomes are ingested. The plant juices can cause dermatitis in sensitive humans. In British Columbia cattle were poisoned by a cultivated blue-flowered *Iris* species. The symptoms of that poisoning are described under this species (Bruce 1920, Cooper and Johnson 1984).

References:

Bruce, E. A. 1920. Iris poisoning of calves. J. Am. Vet. Med. Assoc., 56: 72-74.

Cooper, M. R., Johnson, A. W. 1984. Poisonous plants in Britain and their effects on animals and man. Her Majesty's Stationery Office, London, England. 305 pp.

Nomenclature:

Scientific Name: *Iris pseudacorus* L.

Vernacular name(s): yellow iris

Scientific family name: *Iridaceae*

Vernacular family name: iris

Go to ITIS*^{ca} for more taxonomic information on: [Iris pseudacorus](#)

References:

Agriculture Quebec. 1975. Noms des maladies des plantes du Canada/ Names of plant diseases in Canada. , Quebec City, Que.,

Canada. 288 pp.

Alex, J. F., Cayouette, R., Mulligan, G. A. 1980. Common and botanical names of weeds in Canada/Noms populaire et scientifiques des plantes nuisibles du Canada. Revised. Agric. Can. Publ., Ottawa, Ont., Canada. 132 pp.

Bailey, L. H., Bailey, E. Z. 1976. Hortus third. Revised. MacMillan, New York, N.Y., USA. 1290 pp.

Scoggan, H. J. 1978, 1979. The flora of Canada. Nat. Mus. Nat. Sci. (Ottawa) Publ. Bot. 7(1)-7(4). 1711 pp.

Van Wijk, H. L. 1911. A dictionary of plant names. Martinus Nijhoff, The Hague, The Netherlands. 1444 pp.

Victorin, M. 1964. Flore Laurentienne. 2nd ed. Univ. Montreal, Montreal, Que., Canada. 952 pp.

Geographic Information

British Columbia

Manitoba

Nova Scotia

Ontario

Prince Edward Island

Quebec

References:

Bailey, L. H., Bailey, E. Z. 1976. Hortus third. Revised. MacMillan, New York, N.Y., USA. 1290 pp.

Boivin, B. 1966, 1967. Énumération des plantes du Canada. Provencheria 6. Nat. Can. (Que.) 93: 253-274; 371-437; 583-646; 989-1063. 94: 131-157; 471-528; 625-655.

Image or illustration

Iris pseudacorus:

Images: images.google.com

Notes on Poisonous plant parts:

Ingesting the rhizome causes poisoning in animals, and the plant juices cause dermatitis in sensitive individuals (Cooper and Johnson 1984).

Toxic parts:

plant juices
rhizome

References:

Cooper, M. R., Johnson, A. W. 1984. Poisonous plants in Britain and their effects on animals and man. Her Majesty's Stationery Office, London, England. 305 pp.

Notes on Toxic plant chemicals:

The toxin in Iris species has not been confirmed, but a glycoside, iridin (or irisin), has been implicated (Cooper and Johnson 1984).

Toxic plant chemicals:

iridin

References:

Cooper, M. R., Johnson, A. W. 1984. Poisonous plants in Britain and their effects on animals and man. Her Majesty's Stationery Office, London, England. 305 pp.

Animals/Human Poisoning:

Note: When an animal is listed without additional information, the literature (as of 1993) contained no detailed explanation.

Cattle

General symptoms of poisoning:

[abdominal pains](#)

[blistering](#)

[death](#)

[diarrhea](#)

[mouth, irritation of](#)

[recumbency](#)

[salivation](#)

Notes on poisoning:

Ingesting yellow flag rhizome has apparently caused diarrhea and bloody feces in cattle in Europe. The toxin can survive drying because yellow flag in hay causes diarrhea (Cooper and Johnson

1984).

In a case in British Columbia, cattle ingested rhizomes from an unidentified blue-flowered cultivated *Iris* species. Three calves showed symptoms and died within 4 days. Initial symptoms included recumbency and excessive salivation. The glands of the head and throat became hard and enlarged. Raised sores appeared on the lips and muzzle, becoming yellowish scabs that irritated animals. Acute abdominal pain occurred, and bloody feces were passed. Death followed. Postmortem findings showed irritation of the lower stomachs and intestines. The kidneys, liver, and spleen were very dark-colored. Unfortunately, the identity of this iris was never determined (Bruce 1920). Livestock should be denied access to any *Iris* species that grow in the wild or in gardens, because ingestion may cause poisoning.

References:

Bruce, E. A. 1920. Iris poisoning of calves. *J. Am. Vet. Med. Assoc.*, 56: 72-74.

Cooper, M. R., Johnson, A. W. 1984. Poisonous plants in Britain and their effects on animals and man. Her Majesty's Stationery Office, London, England. 305 pp.

Humans

General symptoms of poisoning:

[blistering](#)

References:

Cooper, M. R., Johnson, A. W. 1984. Poisonous plants in Britain and their effects on animals and man. Her Majesty's Stationery Office, London, England. 305 pp.

Swine

General symptoms of poisoning:

[abortion](#)

[death](#)

[diarrhea](#)

Notes on poisoning:

Swine that ingest rhizomes suffer diarrhea; one sow hemorrhaged, aborted, and died (Cooper and Johnson 1984).

References:

Cooper, M. R., Johnson, A. W. 1984. Poisonous plants in Britain and their effects on animals and man. Her Majesty's Stationery Office, London, England. 305 pp.

[Another search?](#)

[Français](#) | [Contact Us](#) | [Help](#) | [Search](#) | [Canada site](#)

[Coming Events](#) | [About CBIF](#) | [Links](#) | [Reports and Publications](#) |

[Home](#)

Date modified: 2003-02-06

[Important Notices](#)



Français	Contact us	Help	Search	Canada site
Coming events	About CBIF	Links	Reports and publications	Home

Canadian Biodiversity Information Facility



Notes on poisoning: *Iris versicolor*

[Introduction](#)

[Interactive](#)

[All poisonous plants by Botanical name](#)

[All poisonous plants by Common name](#)

[Important WWW Poisonous Plants sites](#)



General poisoning notes:

Blue flag (*Iris versicolor*) is a native herb found in eastern and central Canada. This plant has been mentioned as causing poisoning in humans and animals, but case reports have not been found. The plant juice can cause dermatitis in sensitive individuals. Other iris species have also been implicated in poisoning of animals and in causing dermatitis in humans (see additional information under [Iris pseudacorus](#)). Because of the potential for poisoning, care should be taken to prevent access by livestock to blue flag, which grows in moist soils near rivers, lakes, and marshes (Fyles 1920, Cooper and Johnson 1984).

References:

Cooper, M. R., Johnson, A. W. 1984. Poisonous plants in Britain and their effects on animals and man. Her Majesty's Stationery Office, London, England. 305 pp.

Fyles, F. 1920. Principal poisonous plants of Canada. Can. Dep. Agric. Exp. Farms. Bull. 39. 112 pp.

Nomenclature:

Scientific Name: *Iris versicolor* L.

Vernacular name(s): blue flag iris

Scientific family name: *Iridaceae*

Vernacular family name: iris

Go to ITIS*^{ca} for more taxonomic information on: [Iris versicolor](#)

References:

Agriculture Quebec. 1975. Noms des maladies des plantes du

Canada/ Names of plant diseases in Canada. , Quebec City, Que., Canada. 288 pp.

Alex, J. F., Cayouette, R., Mulligan, G. A. 1980. Common and botanical names of weeds in Canada/Noms populaire et scientifiques des plantes nuisibles du Canada. Revised. Agric. Can. Publ., Ottawa, Ont., Canada. 132 pp.

Bailey, L. H., Bailey, E. Z. 1976. Hortus third. Revised. MacMillan, New York, N.Y., USA. 1290 pp.

Scoggan, H. J. 1978, 1979. The flora of Canada. Nat. Mus. Nat. Sci. (Ottawa) Publ. Bot. 7(1)-7(4). 1711 pp.

Van Wijk, H. L. 1911. A dictionary of plant names. Martinus Nijhoff, The Hague, The Netherlands. 1444 pp.

Victorin, M. 1964. Flore Laurentienne. 2nd ed. Univ. Montreal, Montreal, Que., Canada. 952 pp.

Geographic Information

British Columbia
Labrador
Manitoba
New Brunswick
Newfoundland
Northwest Territories
Nova Scotia
Ontario
Prince Edward Island
Quebec
Saskatchewan

References:

Bailey, L. H., Bailey, E. Z. 1976. Hortus third. Revised. MacMillan, New York, N.Y., USA. 1290 pp.

Boivin, B. 1966, 1967. Énumération des plantes du Canada. Provencheria 6. Nat. Can. (Que.) 93: 253-274; 371-437; 583-646; 989-1063. 94: 131-157; 471-528; 625-655.

Image or illustration

Iris versicolor:

Images: images.google.com

Toxic parts:

rhizome

References:

Cooper, M. R., Johnson, A. W. 1984. Poisonous plants in Britain and their effects on animals and man. Her Majesty's Stationery Office, London, England. 305 pp.

Fyles, F. 1920. Principal poisonous plants of Canada. Can. Dep. Agric. Exp. Farms. Bull. 39. 112 pp.

Notes on Toxic plant chemicals:

A glycoside, iridin (or irisin), has been implicated as the toxic compound in iris species, although this has not been confirmed (Fyles 1920, Cooper and Johnson 1984).

Toxic plant chemicals:

iridin

References:

Cooper, M. R., Johnson, A. W. 1984. Poisonous plants in Britain and their effects on animals and man. Her Majesty's Stationery Office, London, England. 305 pp.

Fyles, F. 1920. Principal poisonous plants of Canada. Can. Dep. Agric. Exp. Farms. Bull. 39. 112 pp.

Animals/Human Poisoning:

Note: When an animal is listed without additional information, the literature (as of 1993) contained no detailed explanation.

Cattle

Humans

General symptoms of poisoning:

[abdominal pains](#)

[nausea](#)

[vomiting](#)

References:

Cooper, M. R., Johnson, A. W. 1984. Poisonous plants in Britain and their effects on animals and man. Her Majesty's Stationery Office, London, England. 305 pp.

Fyles, F. 1920. Principal poisonous plants of Canada. Can. Dep. Agric. Exp. Farms. Bull. 39. 112 pp.

[Another search?](#)

[Français](#) | [Contact Us](#) | [Help](#) | [Search](#) | [Canada site](#)

[Coming Events](#) | [About CBIF](#) | [Links](#) | [Reports and Publications](#) |

[Home](#)

Date modified: 2003-02-06

[Important Notices](#)



Français	Contact us	Help	Search	Canada site
Coming events	About CBIF	Links	Reports and publications	Home

Canadian Biodiversity Information Facility



Notes on poisoning: *Iva xanthifolia*

[Introduction](#)

[Interactive](#)

[All poisonous plants by Botanical name](#)

[All poisonous plants by Common name](#)

[Important WWW Poisonous Plants sites](#)

General poisoning notes:

False ragweed (*Iva xanthifolia*) is a native herb found across southern Canada. The plant can cause dermatitis in sensitive humans after they come in contact with the leaves. Lactating cows that ingest the leaves produce bitter-tasting milk (Muenscher 1975, Mitchell and Rook 1979).



References:

Muenscher, W. C. 1975. Poisonous plants of the United States. Revised. Collier Books, New York, N.Y., USA. 277 pp.

Nomenclature:

Scientific Name: *Iva xanthifolia* Nutt.

Vernacular name(s): false ragweed

Scientific family name: *Compositae*

Vernacular family name: composite

Go to ITIS^{*ca} for more taxonomic information on: [Iva xanthifolia](#)

References:

Agriculture Quebec. 1975. Noms des maladies des plantes du Canada/ Names of plant diseases in Canada. , Quebec City, Que., Canada. 288 pp.

Alex, J. F., Cayouette, R., Mulligan, G. A. 1980. Common and botanical names of weeds in Canada/Noms populaire et scientifiques des plantes nuisibles du Canada. Revised. Agric. Can. Publ., Ottawa, Ont., Canada. 132 pp.

Bailey, L. H., Bailey, E. Z. 1976. Hortus third. Revised.

MacMillan, New York, N.Y., USA. 1290 pp.

Scoggan, H. J. 1978, 1979. The flora of Canada. Nat. Mus. Nat. Sci. (Ottawa) Publ. Bot. 7(1)-7(4). 1711 pp.

Van Wijk, H. L. 1911. A dictionary of plant names. Martinus Nijhoff, The Hague, The Netherlands. 1444 pp.

Victorin, M. 1964. Flore Laurentienne. 2nd ed. Univ. Montreal, Montreal, Que., Canada. 952 pp.

Geographic Information

Alberta

British Columbia

Manitoba

New Brunswick

Nova Scotia

Ontario

Prince Edward Island

Quebec

Saskatchewan

References:

Bailey, L. H., Bailey, E. Z. 1976. Hortus third. Revised. MacMillan, New York, N.Y., USA. 1290 pp.

Boivin, B. 1966, 1967. Énumération des plantes du Canada. Provencheria 6. Nat. Can. (Que.) 93: 253-274; 371-437; 583-646; 989-1063. 94: 131-157; 471-528; 625-655.

Image or illustration

Iva xanthifolia:

Images: images.google.com

Toxic parts:

leaves

References:

Mitchell, J. C., Rook, A. 1979. Botanical dermatology. Greenglass Ltd, Vancouver, B.C., Canada. 787 pp.

Muenschler, W. C. 1975. Poisonous plants of the United States. Revised. Collier Books, New York, N.Y., USA. 277 pp.

Notes on Toxic plant chemicals:

Mitchell and Rook (1979) report that potentially allergenic sesquiterpene lactones have been isolated from some members of the genus *Iva*.

Toxic plant chemicals:

unknown chemical

References:

Mitchell, J. C., Rook, A. 1979. Botanical dermatology. Greenglass Ltd, Vancouver, B.C., Canada. 787 pp.

Animals/Human Poisoning:

Note: When an animal is listed without additional information, the literature (as of 1993) contained no detailed explanation.

Humans

General symptoms of poisoning:

[erythema](#)

References:

Muenschler, W. C. 1975. Poisonous plants of the United States. Revised. Collier Books, New York, N.Y., USA. 277 pp.

[Another search?](#)

[Français](#) | [Contact Us](#) | [Help](#) | [Search](#) | [Canada site](#)

[Coming Events](#) | [About CBIF](#) | [Links](#) | [Reports and Publications](#) |

[Home](#)

Date modified: 2003-02-06

[Important Notices](#)



Français	Contact us	Help	Search	Canada site
Coming events	About CBIF	Links	Reports and publications	Home

Canadian Biodiversity Information Facility



Notes on poisoning: *Juglans nigra*

[Introduction](#)[Interactive](#)[All poisonous plants by Botanical name](#)[All poisonous plants by Common name](#)[Important WWW Poisonous Plants sites](#)

General poisoning notes:

Black walnut (*Juglans nigra*) is native to southwestern Ontario and has been planted as a cultivated tree. The shavings of wood from this tree have caused laminitis in horses in the United States. Black walnut shavings are less likely to be used as bedding in Canada because the tree is not common here. However, if bedding is obtained from a hardwood mill or furniture manufacturing plant, sufficient black black walnut shavings may be present to cause problems. Reforestation of black walnut has been attempted in southern Ontario by leaving nuts for squirrels to gather in the autumn. The squirrel bury them for the winter, allowing many black walnut trees to germinate by this method. Pollen of black walnut has been implicated in causing laminitis in horses (MacDaniels 1983, Minnick et al. 1987).

References:

Galey, F. D., Whiteley, H. E., Goetz, T. E., Kuenstler, A. R., Davis, C. A., Beasley, V. R. 1991. Black walnut (*Juglans nigra*) Toxicosis: a model for equine laminitis. *J. Comp. Pathol.*, 104: 313-326.

MacDaniels, L. H. 1983. Perspective on the black walnut toxicity problem - apparent allergies to man and horse. *Cornell Vet.*, 73: 204-207.

Minnick, P. D., Brown, C. M., Braselton, W. E., Meerdink, G. L., Slanker, M. R. 1987. The induction of equine laminitis with an aqueous extract of the heartwood of black walnut (*Juglans nigra*). *Vet. Hum. Toxicol.*, 29: 230-233.

True, R. G., Lowe, J. E. 1980. Induced juglone toxicosis in ponies and horses. *Am. J. Vet. Res.*, 41: 944-945.

Nomenclature:

Scientific Name: *Juglans nigra* L.

Vernacular name(s): black walnut

Scientific family name: *Juglandaceae*

Vernacular family name: walnut

Go to ITIS^{*ca} for more taxonomic information on: [Juglans nigra](#)

References:

Agriculture Quebec. 1975. Noms des maladies des plantes du Canada/ Names of plant diseases in Canada. , Quebec City, Que., Canada. 288 pp.

Alex, J. F., Cayouette, R., Mulligan, G. A. 1980. Common and botanical names of weeds in Canada/Noms populaire et scientifiques des plantes nuisibles du Canada. Revised. Agric. Can. Publ., Ottawa, Ont., Canada. 132 pp.

Bailey, L. H., Bailey, E. Z. 1976. Hortus third. Revised. MacMillan, New York, N.Y., USA. 1290 pp.

Scoggan, H. J. 1978, 1979. The flora of Canada. Nat. Mus. Nat. Sci. (Ottawa) Publ. Bot. 7(1)-7(4). 1711 pp.

Van Wijk, H. L. 1911. A dictionary of plant names. Martinus Nijhoff, The Hague, The Netherlands. 1444 pp.

Victorin, M. 1964. Flore Laurentienne. 2nd ed. Univ. Montreal, Montreal, Que., Canada. 952 pp.

Geographic Information

Ontario

References:

Bailey, L. H., Bailey, E. Z. 1976. Hortus third. Revised. MacMillan, New York, N.Y., USA. 1290 pp.

Boivin, B. 1966, 1967. Énumération des plantes du Canada. Provencheria 6. Nat. Can. (Que.) 93: 253-274; 371-437; 583-646; 989-1063. 94: 131-157; 471-528; 625-655.

Image or illustration

Juglans nigra:

Images: images.google.com

Notes on Poisonous plant parts:

Wood shavings of black walnut have caused symptoms in horses. The chemical juglone has not been found in appreciable amounts in the wood. Other chemicals are probably involved in causing symptoms in horses from wood shavings (Minnick et al. 1987).

Toxic parts:

bark
mature fruit
wood

References:

Minnick, P. D., Brown, C. M., Braselton, W. E., Meerdink, G. L., Slanker, M. R. 1987. The induction of equine laminitis with an aqueous extract of the heartwood of black walnut (*Juglans nigra*). Vet. Hum. Toxicol., 29: 230-233.

Notes on Toxic plant chemicals:

Juglone, a naphthoquinone, has been found in the bark, nuts, and roots of black walnut. Pure juglone is less potent than a crude extract of the plant in inducing toxic effects. Additional compounds seem to be involved in causing more severe cases. Two ponies given 1 g of pure juglone orally developed mild laminitis that disappeared within 24 h (Minnick et al. 1987).

Toxic plant chemicals:

juglone

References:

Minnick, P. D., Brown, C. M., Braselton, W. E., Meerdink, G. L., Slanker, M. R. 1987. The induction of equine laminitis with an aqueous extract of the heartwood of black walnut (*Juglans nigra*). Vet. Hum. Toxicol., 29: 230-233.

True, R. G., Lowe, J. E. 1980. Induced juglone toxicosis in ponies and horses. Am. J. Vet. Res., 41: 944-945.

Animals/Human Poisoning:

Note: When an animal is listed without additional information,

the literature (as of 1993) contained no detailed explanation.

Horses

General symptoms of poisoning:

[ataxia](#)

[breathing, rapid](#)

[depression](#)

[laminitis](#)

[lethargy](#)

[recumbency](#)

References:

Galey, F. D., Whiteley, H. E., Goetz, T. E., Kuenstler, A. R., Davis, C. A., Beasley, V. R. 1991. Black walnut (*Juglans nigra*) Toxicosis: a model for equine laminitis. J. Comp. Pathol., 104: 313-326.

MacDaniels, L. H. 1983. Perspective on the black walnut toxicity problem - apparent allergies to man and horse. Cornell Vet., 73: 204-207.

Minnick, P. D., Brown, C. M., Braselton, W. E., Meerdink, G. L., Slanker, M. R. 1987. The induction of equine laminitis with an aqueous extract of the heartwood of black walnut (*Juglans nigra*). Vet. Hum. Toxicol., 29: 230-233.

True, R. G., Lowe, J. E. 1980. Induced juglone toxicosis in ponies and horses. Am. J. Vet. Res., 41: 944-945.

[Another search?](#)

[Français](#) | [Contact Us](#) | [Help](#) | [Search](#) | [Canada site](#)

[Coming Events](#) | [About CBIF](#) | [Links](#) | [Reports and Publications](#) | [Home](#)

Date modified: 2003-02-06

[Important Notices](#)



Français	Contact us	Help	Search	Canada site
Coming events	About CBIF	Links	Reports and publications	Home

Canadian Biodiversity Information Facility



Notes on poisoning: *Kalanchoe* *daigremontiana*

[Introduction](#)[Interactive](#)[All poisonous plants by Botanical name](#)[All poisonous plants by Common name](#)[Important WWW Poisonous Plants sites](#)

General poisoning notes:

Devil's-backbone (*Kalanchoe daigremontiana*) is an indoor ornamental plant. This plant contains a cardiac glycoside that has caused experimental toxicity and death in chicks and mice. It has caused illness in pets, such as rabbits and mice. Dogs and cats are also at risk from ingesting plant material. The plants should be kept away from children, as well. Devil's-backbone produces plantlets along the leaf margins, which fall off and become new plants. These plantlets can be found in profusion around the pot in which an adult devil's-backbone is growing. Children and family pets have easy access to these plantlets. Several other species of *Kalanchoe* may be found growing as houseplants in Canada. Tests have shown that some of them may also contain toxic bufadienolide compounds. These compounds were only recently discovered (Williams and Smith 1985, Joubert 1989), and so caution should be exercised with all species. Some members of the genus *Kalanchoe* have caused poisoning of sheep and cattle in South Africa and Australia, where they are native or naturalized (Cheeke and Schull 1985, Williams and Smith 1985).

References:

Cheeke, P. R., Shull, L. R. 1985. Natural toxicants in feeds and poisonous plants. AVI Publishing Company, Inc., Westport, Conn., USA. 492 pp.

Fuller, T. C., McClintock, E. 1986. Poisonous plants of California. Univ. California Press, Berkeley, Calif., USA. 432 pp.

Joubert, J. P. 1989. Cardiac glycosides. Pages 61-97 in Cheeke, P. R., ed. Toxicants of plant origin. Vol. II. Glycosides. CRC Press, Inc., Boca Raton, Fla., USA. 277 pp.

Wagner, H., Fischer, M., Lotter, H. 1985. Isolation and structure

determination of daigremontianin, a novel bufadienolide from *Kalanchoe daigremontiana*. *Planta Med.*, 33: 169-171.

Williams, M. C., Smith, M. C. 1984. Toxicity of *Kalanchoe* spp. to chicks. *Am. J. Vet. Res.*, 45: 543-546.

Nomenclature:

Scientific Name: *Kalanchoe daigremontiana* Hamet & Perr.

Vernacular name(s): Devil's-backbone

Scientific family name: *Crassulaceae*

Vernacular family name: orpine

Go to ITIS*^{ca} for more taxonomic information on: [Kalanchoe daigremontiana](#)

References:

Agriculture Quebec. 1975. Noms des maladies des plantes du Canada/ Names of plant diseases in Canada. , Quebec City, Que., Canada. 288 pp.

Alex, J. F., Cayouette, R., Mulligan, G. A. 1980. Common and botanical names of weeds in Canada/Noms populaire et scientifiques des plantes nuisibles du Canada. Revised. Agric. Can. Publ., Ottawa, Ont., Canada. 132 pp.

Bailey, L. H., Bailey, E. Z. 1976. Hortus third. Revised. MacMillan, New York, N.Y., USA. 1290 pp.

Scoggan, H. J. 1978, 1979. The flora of Canada. Nat. Mus. Nat. Sci. (Ottawa) Publ. Bot. 7(1)-7(4). 1711 pp.

Van Wijk, H. L. 1911. A dictionary of plant names. Martinus Nijhoff, The Hague, The Netherlands. 1444 pp.

Victorin, M. 1964. Flore Laurentienne. 2nd ed. Univ. Montreal, Montreal, Que., Canada. 952 pp.

Geographic Information

Plant or plant parts used in or around the home.

References:

Bailey, L. H., Bailey, E. Z. 1976. Hortus third. Revised. MacMillan, New York, N.Y., USA. 1290 pp.

Boivin, B. 1966, 1967. Énumération des plantes du Canada. Provencheria 6. Nat. Can. (Que.) 93: 253-274; 371-437; 583-646;

989-1063. 94: 131-157; 471-528; 625-655.

Image or illustration

Kalanchoe daigremontiana:

Images: images.google.com

Notes on Poisonous plant parts:

Williams and Smith (1984) found that the leaves contained more toxin than the stems.

Toxic parts:

leaves

stems

References:

Joubert, J. P. 1989. Cardiac glycosides. Pages 61-97 in Cheeke, P. R., ed. Toxicants of plant origin. Vol. II. Glycosides. CRC Press, Inc., Boca Raton, Fla., USA. 277 pp.

Wagner, H., Fischer, M., Lotter, H. 1985. Isolation and structure determination of daigremontianin, a novel bufadienolide from *Kalanchoe daigremontiana*. *Planta Med.*, 33: 169-171.

Williams, M. C., Smith, M. C. 1984. Toxicity of *Kalanchoe* spp. to chicks. *Am. J. Vet. Res.*, 45: 543-546.

Notes on Toxic plant chemicals:

Daigremontianin is a bufadienolide. Bufadienolides are cardiac glycosides that are similar to cardenolides, differing only in the structure of the C-17 substituent on the D ring. This chemical has been found to be toxic in experiments on mice (Wagner et al. 1985).

Toxic plant chemicals:

daigremontianin

References:

Wagner, H., Fischer, M., Lotter, H. 1985. Isolation and structure determination of daigremontianin, a novel bufadienolide from *Kalanchoe daigremontiana*. *Planta Med.*, 33: 169-171.

Animals/Human Poisoning:

Note: When an animal is listed without additional information, the literature (as of 1993) contained no detailed explanation.

Cats

General symptoms of poisoning:

[breathing, labored](#)

[convulsions](#)

[paralysis](#)

References:

Fuller, T. C., McClintock, E. 1986. Poisonous plants of California. Univ. California Press, Berkeley, Calif., USA. 432 pp.

Chickens

General symptoms of poisoning:

[breathing, labored](#)

[convulsions](#)

[death](#)

[depression](#)

[incoordination](#)

[muscle twitching](#)

[paralysis](#)

[trembling](#)

Notes on poisoning:

Experimental feeding of leaf extracts to chicks caused depression, closed eyes, ruffled and drooping feathers, twitching of the neck and head, and often spiralling of the head over the back. In severe cases, convulsions, paralysis, neck and limb tremors, and death occurred. A dosage of 8 mg/g of body weight caused mild symptoms; dosages between 12-20 mg/g of body weight caused some deaths. Stem extracts produced less severe symptoms and no deaths, even when fed at the equivalent of 20 mg/g of body weight (Williams and Smith 1984).

References:

Fuller, T. C., McClintock, E. 1986. Poisonous plants of California. Univ. California Press, Berkeley, Calif., USA. 432 pp.

Williams, M. C., Smith, M. C. 1984. Toxicity of *Kalanchoe* spp.

to chicks. Am. J. Vet. Res., 45: 543-546.

Rabbits

General symptoms of poisoning:

[breathing, rapid](#)

[opisthotonos](#)

[paralysis](#)

Notes on poisoning:

A pet rabbit ate three-quarters of a leaf and became depressed and torpid; it subsequently experienced rapid breathing and teeth grinding. It fell down when attempting to walk. Paralysis followed. An injection of atropine was administered, and the rabbit recovered fully within 9 h (Williams and Smith 1984).

References:

Williams, M. C., Smith, M. C. 1984. Toxicity of *Kalanchoe* spp. to chicks. Am. J. Vet. Res., 45: 543-546.

Rodents

General symptoms of poisoning:

[muscle spasms](#)

[paralysis](#)

Notes on poisoning:

In motility tests, mice experimentally fed the chemical daigremontianin at dosages of 0.1-0.5 mg/kg experienced a strong sedative effect. Higher concentrations resulted in paralysis and spasmodic muscular contractions (Wagner et al. 1985).

References:

Wagner, H., Fischer, M., Lotter, H. 1985. Isolation and structure determination of daigremontianin, a novel bufadienolide from *Kalanchoe daigremontiana*. Planta Med., 33: 169-171.

[Another search?](#)

[Français](#) | [Contact Us](#) | [Help](#) | [Search](#) | [Canada site](#)

[Coming Events](#) | [About CBIF](#) | [Links](#) | [Reports and Publications](#) |

[Home](#)

Date modified: 2003-02-06

[Important Notices](#)



Français	Contact us	Help	Search	Canada site
Coming events	About CBIF	Links	Reports and publications	Home

Canadian Biodiversity Information Facility



Notes on poisoning: *Kalmia angustifolia*

[Introduction](#)

[Interactive](#)

[All poisonous plants by Botanical name](#)

[All poisonous plants by Common name](#)

[Important WWW Poisonous Plants sites](#)

General poisoning notes:

Sheep-laurel (*Kalmia angustifolia*) is a native shrub found in eastern Canada in boggy areas. This plant contains a toxin that has poisoned cattle, goats, and sheep as well as humans. Poisoning rarely happens in the wild. Other animals have been poisoned by sheep-laurel, including zebras at a zoo, as well as horses. Meat of chickens that had ingested sheep-laurel may be toxic to other animals. The nectar contains the toxin that results in toxic honey (Marsh 1930, Kingsbury 1964, Verlangieri 1976, Lampe and McCann 1985).



References:

Kingsbury, J. M. 1964. Poisonous plants of the United States and Canada. Prentice-Hall Inc., Englewood Cliffs, N.J., USA. 626 pp.

Lampe, K. F., McCann, M. A. 1985. AMA Handbook of poisonous and injurious plants. American Medical Assoc. Chicago, Ill., USA. 432 pp.

Marsh, C. D. 1930. Mountain-laurel (*Kalmia latifolia*) and sheep laurel (*Kalmia angustifolia*) as stock-poisoning plants. U. S. Dept. Agric. Tech. Bull., 219. 22 pp.

Pritchard, W. R. 1956. Laurel (*Kalmia angustifolia*) poisoning of sheep. N. Am. Vet., 37: 461-462.

Verlangieri, A. J., Gawlikowski, J. N., Shapiro, R. 1976. Acute toxicity of *Kalmia angustifolia*, (sheep laurel) extracts in the rat. Vet. Toxicol., 18: 122-124.

Nomenclature:

Scientific Name: *Kalmia angustifolia* L.

Vernacular name(s): sheep-laurel

Scientific family name: *Ericaceae*

Vernacular family name: heath

Go to ITIS^{*ca} for more taxonomic information on: [Kalmia angustifolia](#)

References:

Agriculture Quebec. 1975. Noms des maladies des plantes du Canada/ Names of plant diseases in Canada. , Quebec City, Que., Canada. 288 pp.

Alex, J. F., Cayouette, R., Mulligan, G. A. 1980. Common and botanical names of weeds in Canada/Noms populaire et scientifiques des plantes nuisibles du Canada. Revised. Agric. Can. Publ., Ottawa, Ont., Canada. 132 pp.

Bailey, L. H., Bailey, E. Z. 1976. Hortus third. Revised. MacMillan, New York, N.Y., USA. 1290 pp.

Scoggan, H. J. 1978, 1979. The flora of Canada. Nat. Mus. Nat. Sci. (Ottawa) Publ. Bot. 7(1)-7(4). 1711 pp.

Van Wijk, H. L. 1911. A dictionary of plant names. Martinus Nijhoff, The Hague, The Netherlands. 1444 pp.

Victorin, M. 1964. Flore Laurentienne. 2nd ed. Univ. Montreal, Montreal, Que., Canada. 952 pp.

Geographic Information

New Brunswick

Newfoundland

Nova Scotia

Ontario

Prince Edward Island

Quebec

References:

Bailey, L. H., Bailey, E. Z. 1976. Hortus third. Revised. MacMillan, New York, N.Y., USA. 1290 pp.

Boivin, B. 1966, 1967. Énumération des plantes du Canada. Provencheria 6. Nat. Can. (Que.) 93: 253-274; 371-437; 583-646; 989-1063. 94: 131-157; 471-528; 625-655.

Image or illustration

Kalmia angustifolia:

Images: images.google.com

Notes on Poisonous plant parts:

The entire plant is poisonous, including the nectar and honey made from it (Pritchard 1956, Kingsbury 1964).

Toxic parts:

all parts
flowers
leaves
mature fruit
stems

References:

Pritchard, W. R. 1956. Laurel (*Kalmia angustifolia*) poisoning of sheep. N. Am. Vet., 37: 461-462.

Verlangieri, A. J., Gawlikowski, J. N., Shapiro, R. 1976. Acute toxicity of *Kalmia angustifolia*, (sheep laurel) extracts in the rat. Vet. Toxicol., 18: 122-124.

Notes on Toxic plant chemicals:

Andromedotoxin and resins derived from diterpenes are the toxic compounds found in all the toxic species of the heath plant family. The toxin is found even in the nectar of flowers (Fuller and McClintock 1986). Experimental poisoning of rats using leaf extracts resulted in an average LD-50 (female) of 8.2 g of green leaves per kilogram body weight. The leaves were toxic only in the spring. Leaves of plants growing in wet areas were more toxic than those growing in dry areas (Verlangieri et al. 1976).

Toxic plant chemicals:

andromedotoxins

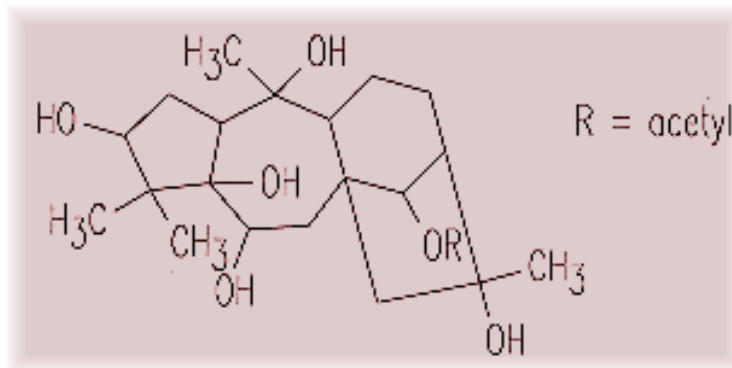

Chemical diagram(s) are courtesy of [Ruth McDiarmid](#), Biochemistry Technician, Kamloops Range Station, Agriculture and Agri-Food Canada,

Kamploops, British Columbia, Canada.

References:

Verlangieri, A. J., Gawlikowski, J. N., Shapiro, R. 1976. Acute toxicity of *Kalmia angustifolia*, (sheep laurel) extracts in the rat. *Vet. Toxicol.*, 18: 122-124.

Animals/Human Poisoning:

Note: When an animal is listed without additional information, the literature (as of 1993) contained no detailed explanation.

Cattle

General symptoms of poisoning:

[breathing, shallow](#)

[diarrhea](#)

[gait, staggering](#)

[incoordination](#)

[recumbency](#)

[salivation](#)

[vomiting](#)

Notes on poisoning:

Experimental poisoning of cattle showed symptoms, including soft feces, salivation, vomiting, diarrhea, and incoordination. Consuming green leaves equivalent to 0.2% of an animal's body weight was determined to cause toxic signs in cattle (Marsh 1930). A few cattle in the field were poisoned after ingesting sheep-laurel (Kingsbury 1964).

References:

Kingsbury, J. M. 1964. *Poisonous plants of the United States and Canada*. Prentice-Hall Inc., Englewood Cliffs, N.J., USA. 626 pp.

Marsh, C. D. 1930. Mountain-laurel (*Kalmia latifolia*) and sheep laurel (*Kalmia angustifolia*) as stock-poisoning plants. *U. S. Dept. Agric. Tech. Bull.*, 219. 22 pp.

Goats

General symptoms of poisoning:

[incoordination](#)

[recumbency](#)

[vomiting](#)

[weakness](#)

Notes on poisoning:

Experimental poisoning of goats fed green leaves resulted in symptoms, including profuse vomiting, staggering, recumbency, weakness, shallow breath, and teeth grinding. Sheep-laurel causes toxic signs in goats if ingested green material equaled at least 0.25% of animal body weight (Marsh 1930).

References:

Kingsbury, J. M. 1964. Poisonous plants of the United States and Canada. Prentice-Hall Inc., Englewood Cliffs, N.J., USA. 626 pp.

Humans

General symptoms of poisoning:

[coma](#)

References:

Lampe, K. F., McCann, M. A. 1985. AMA Handbook of poisonous and injurious plants. American Medical Assoc. Chicago, Ill., USA. 432 pp.

Rodents

General symptoms of poisoning:

[coma](#)

[convulsions](#)

[death](#)

[nasal discharge](#)

[paralysis](#)

[salivation](#)

[vomiting](#)

References:

Verlangieri, A. J., Gawlikowski, J. N., Shapiro, R. 1976. Acute toxicity of *Kalmia angustifolia*, (sheep laurel) extracts in the rat. Vet. Toxicol., 18: 122-124.

Sheep

General symptoms of poisoning:

[ataxia](#)

[coma](#)

[convulsions](#)

[death](#)

[depression](#)

[dyspnea](#)

[headache](#)

[nasal discharge](#)

[pupil dilation](#)

[recumbency](#)

[salivation](#)

[vomiting](#)

Notes on poisoning:

Experimental poisoning of a goat caused symptoms of poisoning similar to those seen in sheep. A dosage of green leaves equal to 0.5% of an animal's body weight caused symptoms to occur (Clawson 1933).

References:

Kingsbury, J. M. 1964. Poisonous plants of the United States and Canada. Prentice-Hall Inc., Englewood Cliffs, N.J., USA. 626 pp.

Pritchard, W. R. 1956. Laurel (*Kalmia angustifolia*) poisoning of sheep. N. Am. Vet., 37: 461-462.

[Another search?](#)

[Français](#) | [Contact Us](#) | [Help](#) | [Search](#) | [Canada site](#)

[Coming Events](#) | [About CBIF](#) | [Links](#) | [Reports and Publications](#) | [Home](#)

Date modified: 2003-02-06

[Important Notices](#)



Français	Contact us	Help	Search	Canada site
Coming events	About CBIF	Links	Reports and publications	Home

Canadian Biodiversity Information Facility



Notes on poisoning: *Kalmia polifolia*

[Introduction](#)

[Interactive](#)

[All poisonous plants by Botanical name](#)

[All poisonous plants by Common name](#)

[Important WWW Poisonous Plants sites](#)

General poisoning notes:

Bog-laurel (*Kalmia polifolia*) is a native shrub found across Canada in boggy areas. The plant has caused experimental poisoning in cattle, goats, and sheep, with sheep being most susceptible. Suspected poisoning of cattle and sheep in the west have been reported. Bog-laurel is less toxic than sheep-laurel (*Kalmia angustifolia*). Only the western variety of bog-laurel (*Kalmia polifolia* var. *microphylla*) has been tested for toxicity. However, the plant should be considered potentially toxic through its entire range in Canada (Clawson 1933, Kingsbury 1964, Lampe and McCann 1985).



References:

Clawson, A. B. 1933. Alpine kalmia (*Kalmia microphylla*) as a stock-poisoning plant. U. S. Dep. Agric. Tech. Bull., 391. 10 pp.

Kingsbury, J. M. 1964. Poisonous plants of the United States and Canada. Prentice-Hall Inc., Englewood Cliffs, N.J., USA. 626 pp.

Lampe, K. F., McCann, M. A. 1985. AMA Handbook of poisonous and injurious plants. American Medical Assoc. Chicago, Ill., USA. 432 pp.

Nomenclature:

Scientific Name: *Kalmia polifolia* Wang

Vernacular name(s): bog-laurel

Scientific family name: *Ericaceae*

Vernacular family name: heath

Go to ITIS*^{ca} for more taxonomic information on: [Kalmia polifolia](#)

References:

- Agriculture Quebec. 1975. Noms des maladies des plantes du Canada/ Names of plant diseases in Canada. , Quebec City, Que., Canada. 288 pp.
- Alex, J. F., Cayouette, R., Mulligan, G. A. 1980. Common and botanical names of weeds in Canada/Noms populaire et scientifiques des plantes nuisibles du Canada. Revised. Agric. Can. Publ., Ottawa, Ont., Canada. 132 pp.
- Bailey, L. H., Bailey, E. Z. 1976. Hortus third. Revised. MacMillan, New York, N.Y., USA. 1290 pp.
- Scoggan, H. J. 1978, 1979. The flora of Canada. Nat. Mus. Nat. Sci. (Ottawa) Publ. Bot. 7(1)-7(4). 1711 pp.
- Van Wijk, H. L. 1911. A dictionary of plant names. Martinus Nijhoff, The Hague, The Netherlands. 1444 pp.
- Victorin, M. 1964. Flore Laurentienne. 2nd ed. Univ. Montreal, Montreal, Que., Canada. 952 pp.

Geographic Information

Alberta
British Columbia
Labrador
Manitoba
New Brunswick
Newfoundland
Northwest Territories
Nova Scotia
Ontario
Prince Edward Island
Quebec
Saskatchewan
Yukon Territory

References:

- Bailey, L. H., Bailey, E. Z. 1976. Hortus third. Revised. MacMillan, New York, N.Y., USA. 1290 pp.
- Boivin, B. 1966, 1967. Énumération des plantes du Canada. Provencheria 6. Nat. Can. (Que.) 93: 253-274; 371-437; 583-646; 989-1063. 94: 131-157; 471-528; 625-655.

Image or illustration

Kalmia polifolia:

Images: images.google.com

Notes on Poisonous plant parts:

All parts of the plant are poisonous including the nectar, which can result in poisonous honey. The leaves have been used in experiments to poison livestock (Clawson 1933, Fuller and McClintock 1986).

Toxic parts:

all parts
leaves
stems

References:

Clawson, A. B. 1933. Alpine kalmia (*Kalmia microphylla*) as a stock-poisoning plant. U. S. Dep. Agric. Tech. Bull., 391. 10 pp.

Fuller, T. C., McClintock, E. 1986. Poisonous plants of California. Univ. California Press, Berkeley, Calif., USA. 432 pp.

Notes on Toxic plant chemicals:

Andromedotoxins (grayanotoxins) are resins derived from diterpenes. Several have been found in many members of the heath family and are toxic if sufficient vegetation is eaten (Kakisawa et al. 1965, Fuller and McClintock 1986).

Toxic plant chemicals:

andromedotoxins

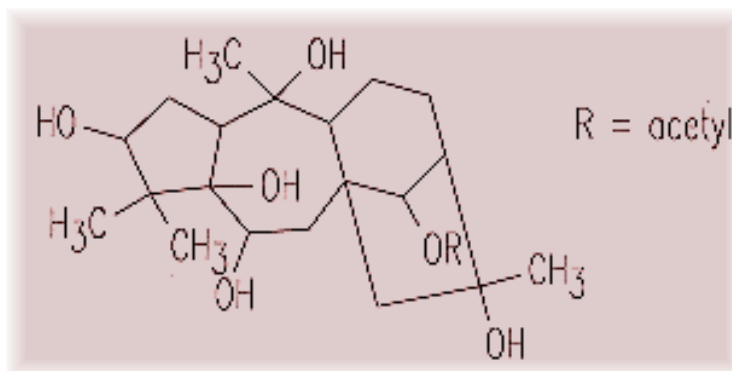

Chemical diagram(s) are courtesy of [Ruth McDiarmid](#), Biochemistry Technician, Kamloops Range Station, Agriculture and Agri-Food Canada, Kamloops, British Columbia, Canada.

References:

Clawson, A. B. 1933. Alpine kalmia (*Kalmia microphylla*) as a

stock-poisoning plant. U. S. Dep. Agric. Tech. Bull., 391. 10 pp.

Fuller, T. C., McClintock, E. 1986. Poisonous plants of California. Univ. California Press, Berkeley, Calif., USA. 432 pp.

Kakisawa, H., Kozima, T., Yanai, M., Nakanishi, K. 1965. Stereochemistry of grayanotoxins. Tetrahedron, 21: 3091-3104.

Animals/Human Poisoning:

Note: When an animal is listed without additional information, the literature (as of 1993) contained no detailed explanation.

Cattle

Goats

General symptoms of poisoning:

[depression](#)

[nausea](#)

[salivation](#)

[vomiting](#)

Notes on poisoning:

Experimental poisoning of sheep caused such symptoms as depression, salivation, loss of appetite, and vomiting. Grating of teeth and frequent vomiting was noticed in more severe cases. Pulse and body temperature was affected very little. A dosage of green leaves equal to 0.3% of an animal's body weight can cause a toxic response. A dosage of 2% of an animal's body weight caused severe sickness in sheep (Clawson 1933).

References:

Clawson, A. B. 1933. Alpine kalmia (*Kalmia microphylla*) as a stock-poisoning plant. U. S. Dep. Agric. Tech. Bull., 391. 10 pp.

Kingsbury, J. M. 1964. Poisonous plants of the United States and Canada. Prentice-Hall Inc., Englewood Cliffs, N.J., USA. 626 pp.

Sheep

General symptoms of poisoning:

[depression](#)

[gait, staggering](#)

[nausea](#)

[recumbency](#)

[salivation](#)

[vomiting](#)

Notes on poisoning:

Experimental poisoning of sheep caused such symptoms as depression, salivation, loss of appetite, and vomiting. Grating of teeth and frequent vomiting was noticed in more severe cases. Pulse and body temperature was affected very little. A dosage of green leaves equal to 0.3% of an animal's body weight can cause a toxic response. A dosage of 2% of an animal's body weight caused severe sickness in sheep (Clawson 1933).

References:

Clawson, A. B. 1933. Alpine kalmia (*Kalmia microphylla*) as a stock-poisoning plant. U. S. Dep. Agric. Tech. Bull., 391. 10 pp.

Kingsbury, J. M. 1964. Poisonous plants of the United States and Canada. Prentice-Hall Inc., Englewood Cliffs, N.J., USA. 626 pp.

[Another search?](#)

[Français](#) | [Contact Us](#) | [Help](#) | [Search](#) | [Canada site](#)

[Coming Events](#) | [About CBIF](#) | [Links](#) | [Reports and Publications](#) | [Home](#)

Date modified: 2003-02-06

[Important Notices](#)



Français	Contact us	Help	Search	Canada site
Coming events	About CBIF	Links	Reports and publications	Home

Canadian Biodiversity Information Facility



Notes on poisoning: *Kochia scoparia*

[Introduction](#)[Interactive](#)[All poisonous plants by Botanical name](#)[All poisonous plants by Common name](#)[Important WWW Poisonous Plants sites](#)

General poisoning notes:

Kochia (Kochia scoparia) is both naturalized and cultivated as an outdoor ornamental in various parts of Canada. Ingestion has caused poisoning in cattle, horses, and sheep. Hepatogenous photosensitivity and liver damage often occur together, along with the outward signs of photosensitization. In addition, polioencephalomalacia, toxic hepatitis, and nephrosis can occur. *Kochia* has been examined as a forage crop because it is very drought-tolerant. Toxicity varies from one year to the next. Increased rainfall has raised the oxalate content of the plants. Oxalates are at least partly responsible for the complicated toxic affects of *kochia* ingestion (Galitzer and Oehme 1978, Dickie and Berryman 1979, Thilsted et al. 1989).

References:

Dickie, C. W., Berryman, J. R. 1979. Polioencephalomalacia and photosensitization associated with *Kochia scoparia* consumption in range cattle. J. Am. Vet. Med. Assoc., 175: 463-465.

Dickie, C. W., James, L. F. 1983. *Kochia scoparia* poisoning in cattle. J. Am. Vet. Med. Assoc., 183: 765-768.

Galitzer, S. J., Oehme, F. W. 1978. *Kochia scoparia* (L.) Schrad toxicity in cattle: a literature review. Vet. Hum. Toxicol., 20: 421-423.

Johnson, A. E. 1983. Photosensitizing toxins from plants and their biologic effects. Pages 345-359 in Keeler, R. F., Tu, A. T., eds. Handbook of natural toxins. Vol. 1. Plant and Fungal toxins. Marcel Dekker, Inc., New York, N.Y., USA. 934 pp.

Thilsted, J., Hibbs, C., Kiesling, H., Hallford, D., Kirksey, R., Meininger, A., Tompkins, J. 1989. *Kochia (Kochia scoparia)* toxicosis in cattle: results of four experimental grazing trials. Vet. Hum. Toxicol., 31: 34-41.

Nomenclature:

Scientific Name: *Kochia scoparia* (L.) Schrad.

Vernacular name(s): kochia

Scientific family name: *Chenopodiaceae*

Vernacular family name: goosefoot

Go to ITIS^{*ca} for more taxonomic information on: [Kochia scoparia](#)

References:

Agriculture Quebec. 1975. Noms des maladies des plantes du Canada/ Names of plant diseases in Canada. , Quebec City, Que., Canada. 288 pp.

Alex, J. F., Cayouette, R., Mulligan, G. A. 1980. Common and botanical names of weeds in Canada/Noms populaire et scientifiques des plantes nuisibles du Canada. Revised. Agric. Can. Publ., Ottawa, Ont., Canada. 132 pp.

Bailey, L. H., Bailey, E. Z. 1976. Hortus third. Revised. MacMillan, New York, N.Y., USA. 1290 pp.

Scoggan, H. J. 1978, 1979. The flora of Canada. Nat. Mus. Nat. Sci. (Ottawa) Publ. Bot. 7(1)-7(4). 1711 pp.

Van Wijk, H. L. 1911. A dictionary of plant names. Martinus Nijhoff, The Hague, The Netherlands. 1444 pp.

Victorin, M. 1964. Flore Laurentienne. 2nd ed. Univ. Montreal, Montreal, Que., Canada. 952 pp.

Geographic Information

Alberta
British Columbia
Manitoba
Nova Scotia
Ontario
Quebec
Saskatchewan

References:

Bailey, L. H., Bailey, E. Z. 1976. Hortus third. Revised. MacMillan, New York, N.Y., USA. 1290 pp.

Boivin, B. 1966, 1967. Énumération des plantes du Canada.

Provencheria 6. Nat. Can. (Que.) 93: 253-274; 371-437; 583-646; 989-1063. 94: 131-157; 471-528; 625-655.

Image or illustration

Kochia scoparia:

Images: images.google.com

Toxic parts:

flowers
leaves
seeds

References:

Dickie, C. W., Berryman, J. R. 1979. Polioencephalomalacia and photosensitization associated with *Kochia scoparia* consumption in range cattle. J. Am. Vet. Med. Assoc., 175: 463-465.

Dickie, C. W., James, L. F. 1983. *Kochia scoparia* poisoning in cattle. J. Am. Vet. Med. Assoc., 183: 765-768.

Thilsted, J., Hibbs, C., Kiesling, H., Hallford, D., Kirksey, R., Meininger, A., Tompkins, J. 1989. *Kochia (Kochia scoparia)* toxicosis in cattle: results of four experimental grazing trials. Vet. Hum. Toxicol., 31: 34-41.

Notes on Toxic plant chemicals:

Kochia has been found to contain total oxalates of up to 11.4% and maximum soluble oxalates of 4.7%. This level of soluble oxalates is sufficient to cause some of the signs of toxicity seen in poisoning. In addition, saponins and alkaloids have been described that may contribute to the complex symptoms of *kochia* ingestion (Dickie et al. 1989, Thilsted et al. 1989).

Toxic plant chemicals:

oxalate

References:

Dickie, C. W., Gerlach, M. L., Hamar, D. W. 1989. *Kochia scoparia* oxalate content. Vet. Hum. Toxicol., 31: 240-242.

Thilsted, J., Hibbs, C., Kiesling, H., Hallford, D., Kirksey, R., Meininger, A., Tompkins, J. 1989. *Kochia (Kochia scoparia)* toxicosis in cattle: results of four experimental grazing trials. Vet.

Animals/Human Poisoning:

Note: When an animal is listed without additional information, the literature (as of 1993) contained no detailed explanation.

Cattle

General symptoms of poisoning:

[anorexia](#)

[ataxia](#)

[blindness](#)

[breathing, labored](#)

[death](#)

[dehydration](#)

[depression](#)

[diarrhea](#)

[erythema](#)

[eye, discharge of](#)

[eyelids, swollen](#)

[eyes, rolling](#)

[head, movement of](#)

[icterus](#)

[incoordination](#)

[itchiness](#)

[lacrimation, severe](#)

[lethargy](#)

[liver, congestion of](#)

[lungs, congestion of](#)

[muscle spasms](#)

[muscle, weakness of](#)

[muzzle, crusty](#)

[nephrosis, severe](#)

[opisthotonos](#)

[polioencephalomalacia](#)

[recumbency, ventral](#)

[reflex excitability](#)

[salivation](#)

[skin, peeling of](#)

[teat necrosis of](#)

[urine, coffee-colored](#)

Notes on poisoning:

In addition to photosensitization, symptoms can include ataxia,

incoordination, muscular spasms, recumbency, and death. Because kochia causes hepatogenous photosensitization, disseminated jaundice is often seen along with enlarged fatty liver (Galitzer and Oehme 1978, Johnson 1983).

References:

Dickie, C. W., Berryman, J. R. 1979. Polioencephalomalacia and photosensitization associated with *Kochia scoparia* consumption in range cattle. J. Am. Vet. Med. Assoc., 175: 463-465.

Dickie, C. W., James, L. F. 1983. *Kochia scoparia* poisoning in cattle. J. Am. Vet. Med. Assoc., 183: 765-768.

Galitzer, S. J., Oehme, F. W. 1978. *Kochia scoparia* (L.) Schrad toxicity in cattle: a literature review. Vet. Hum. Toxicol., 20: 421-423.

Thilsted, J., Hibbs, C., Kiesling, H., Hallford, D., Kirksey, R., Meininger, A., Tompkins, J. 1989. Kochia (*Kochia scoparia*) toxicosis in cattle: results of four experimental grazing trials. Vet. Hum. Toxicol., 31: 34-41.

[Another search?](#)

[Français](#) | [Contact Us](#) | [Help](#) | [Search](#) | [Canada site](#)

[Coming Events](#) | [About CBIF](#) | [Links](#) | [Reports and Publications](#) | [Home](#)

Date modified: 2003-02-06

[Important Notices](#)



Français	Contact us	Help	Search	Canada site
Coming events	About CBIF	Links	Reports and publications	Home

Canadian Biodiversity Information Facility



Notes on poisoning: *Laburnum anagyroides*

[Introduction](#)[Interactive](#)[All poisonous plants by Botanical name](#)[All poisonous plants by Common name](#)[Important WWW Poisonous Plants sites](#)

General poisoning notes:

Golden-chain (*Laburnum anagyroides*) is an outdoor ornamental that survives only in southwestern Ontario and coastal British Columbia. This plant contains cytisine, an alkaloid, which has caused poisoning and death in cattle, dogs, horses, swine, and humans after twigs, fruit pods, and seeds were ingested. Most of the cases of poisoning are found in European literature. Children and family pets should be prevented from ingesting the pods or seeds (Cooper and Johnson 1984, Lampe and McCann 1985, Fuller and McClintock 1986).

References:

- Cooper, M. R., Johnson, A. W. 1984. Poisonous plants in Britain and their effects on animals and man. Her Majesty's Stationery Office, London, England. 305 pp.
- Fuller, T. C., McClintock, E. 1986. Poisonous plants of California. Univ. California Press, Berkeley, Calif., USA. 432 pp.
- Lampe, K. F., McCann, M. A. 1985. AMA Handbook of poisonous and injurious plants. American Medical Assoc. Chicago, Ill., USA. 432 pp.

Nomenclature:

Scientific Name: *Laburnum anagyroides* Medic.

Vernacular name(s): golden-chain

Scientific family name: *Leguminosae*

Vernacular family name: pea

Go to ITIS*^{ca} for more taxonomic information on: [Laburnum anagyroides](#)

References:

Agriculture Quebec. 1975. Noms des maladies des plantes du Canada/ Names of plant diseases in Canada. , Quebec City, Que., Canada. 288 pp.

Alex, J. F., Cayouette, R., Mulligan, G. A. 1980. Common and botanical names of weeds in Canada/Noms populaire et scientifiques des plantes nuisibles du Canada. Revised. Agric. Can. Publ., Ottawa, Ont., Canada. 132 pp.

Bailey, L. H., Bailey, E. Z. 1976. Hortus third. Revised. MacMillan, New York, N.Y., USA. 1290 pp.

Scoggan, H. J. 1978, 1979. The flora of Canada. Nat. Mus. Nat. Sci. (Ottawa) Publ. Bot. 7(1)-7(4). 1711 pp.

Van Wijk, H. L. 1911. A dictionary of plant names. Martinus Nijhoff, The Hague, The Netherlands. 1444 pp.

Victorin, M. 1964. Flore Laurentienne. 2nd ed. Univ. Montreal, Montreal, Que., Canada. 952 pp.

Geographic Information

Plant or plant parts used in or around the home.

References:

Bailey, L. H., Bailey, E. Z. 1976. Hortus third. Revised. MacMillan, New York, N.Y., USA. 1290 pp.

Boivin, B. 1966, 1967. Énumération des plantes du Canada. Provencheria 6. Nat. Can. (Que.) 93: 253-274; 371-437; 583-646; 989-1063. 94: 131-157; 471-528; 625-655.

Image or illustration

Laburnum anagyroides:

Images: images.google.com

Notes on Poisonous plant parts:

All parts of the plant contain the alkaloid cytisine, but the bark and seeds have the highest amount of the chemical. The leaves become less toxic as the fruit pods develop, which become more toxic (Cooper and Johnson 1984).

Toxic parts:

all parts
bark
leaves
seeds

References:

Cooper, M. R., Johnson, A. W. 1984. Poisonous plants in Britain and their effects on animals and man. Her Majesty's Stationery Office, London, England. 305 pp.

Toxic plant chemicals:

cytisine

References:

Cooper, M. R., Johnson, A. W. 1984. Poisonous plants in Britain and their effects on animals and man. Her Majesty's Stationery Office, London, England. 305 pp.

Animals/Human Poisoning:

Note: When an animal is listed without additional information, the literature (as of 1993) contained no detailed explanation.

Cattle

General symptoms of poisoning:

[death](#)
[gait, unsteady](#)
[muscle spasms](#)
[recumbency](#)

Notes on poisoning:

Ingesting twigs and pods of golden-chain have produced toxic symptoms including stiff, unsteady gait, violent tremors, recumbency, and death. Milk yield has been reduced, and large yellow clots were found in the milk (Cooper and Johnson 1984).

References:

Cooper, M. R., Johnson, A. W. 1984. Poisonous plants in Britain and their effects on animals and man. Her Majesty's Stationery Office, London, England. 305 pp.

Dogs

General symptoms of poisoning:

[convulsions](#)

[death](#)

Notes on poisoning:

Dogs that were poisoned experienced convulsions and died after chewing golden-chain sticks (Cooper and Johnson 1984).

References:

Cooper, M. R., Johnson, A. W. 1984. Poisonous plants in Britain and their effects on animals and man. Her Majesty's Stationery Office, London, England. 305 pp.

Horses

General symptoms of poisoning:

[abdominal pains](#)

[coma](#)

[death](#)

[incoordination](#)

[muscle spasms](#)

References:

Cooper, M. R., Johnson, A. W. 1984. Poisonous plants in Britain and their effects on animals and man. Her Majesty's Stationery Office, London, England. 305 pp.

Humans

General symptoms of poisoning:

[abdominal pains](#)

[confusion](#)

[death](#)

[dizziness](#)

[drowsiness](#)

[headache](#)

[mouth, irritation of](#)

[nausea](#)

[temperature, elevated](#)

[vomiting](#)

Notes on poisoning:

Most cases of human poisoning occur when children eat the pods or seeds by mistake. Symptoms develop rapidly within half an hour because cytisine is rapidly absorbed through mucous membranes of the mouth, stomach, and intestine. Nausea, vomiting, pupil dilation, weakness, breathing difficulty, dizziness, and muscular incoordination can result. Ingesting large quantities can be fatal. In one case, a man ingested 23 pods of golden-chain and died. Toxicological analysis showed that 35-50 mg of cytisine had been absorbed (Cooper and Johnson 1984, Fuller and McClintock 1986).

References:

Cooper, M. R., Johnson, A. W. 1984. Poisonous plants in Britain and their effects on animals and man. Her Majesty's Stationery Office, London, England. 305 pp.

Fuller, T. C., McClintock, E. 1986. Poisonous plants of California. Univ. California Press, Berkeley, Calif., USA. 432 pp.

Swine

General symptoms of poisoning:

[diarrhea](#)

References:

Cooper, M. R., Johnson, A. W. 1984. Poisonous plants in Britain and their effects on animals and man. Her Majesty's Stationery Office, London, England. 305 pp.

[Another search?](#)

[Français](#) | [Contact Us](#) | [Help](#) | [Search](#) | [Canada site](#)

[Coming Events](#) | [About CBIF](#) | [Links](#) | [Reports and Publications](#) |

[Home](#)

Date modified: 2003-02-06

[Important Notices](#)



Français	Contact us	Help	Search	Canada site
Coming events	About CBIF	Links	Reports and publications	Home

Canadian Biodiversity Information Facility



Notes on poisoning: *Lactuca scariola*

[Introduction](#)[Interactive](#)[All poisonous plants by Botanical name](#)[All poisonous plants by Common name](#)[Important WWW Poisonous Plants sites](#)

General poisoning notes:

Prickly lettuce (*Lactuca scariola*) is a naturalized herb found across parts of southern Canada. In the western United States, cattle developed pulmonary emphysema after ingesting the plant. The injury appears to be associated with a deficiency, because the toxicity develops after the cattle have fed on dry rangelands. When they are subsequently moved to lush, autumn pasture, some cattle feed ravenously on the prickly lettuce regrowth and, in a few days, the symptoms may develop (Beath et al. 1953).

References:

Beath, O. A., Gilbert, C. S., Eppson, H. F., Rosenfeld, I. 1953. Poisonous plants and livestock poisoning. Wyo. Agric. Exp. Stn. Bull., 324. 94 pp.

Nomenclature:

Scientific Name: *Lactuca scariola* L.

Vernacular name(s): prickly lettuce

Scientific family name: *Compositae*

Vernacular family name: composite

Go to ITIS^{*ca} for more taxonomic information on: [Lactuca scariola](#)

References:

Agriculture Quebec. 1975. Noms des maladies des plantes du Canada/ Names of plant diseases in Canada. , Quebec City, Que., Canada. 288 pp.

Alex, J. F., Cayouette, R., Mulligan, G. A. 1980. Common and

botanical names of weeds in Canada/Noms populaire et scientifiques des plantes nuisibles du Canada. Revised. Agric. Can. Publ., Ottawa, Ont., Canada. 132 pp.

Bailey, L. H., Bailey, E. Z. 1976. Hortus third. Revised. MacMillan, New York, N.Y., USA. 1290 pp.

Scoggan, H. J. 1978, 1979. The flora of Canada. Nat. Mus. Nat. Sci. (Ottawa) Publ. Bot. 7(1)-7(4). 1711 pp.

Van Wijk, H. L. 1911. A dictionary of plant names. Martinus Nijhoff, The Hague, The Netherlands. 1444 pp.

Victorin, M. 1964. Flore Laurentienne. 2nd ed. Univ. Montreal, Montreal, Que., Canada. 952 pp.

Geographic Information

Manitoba
New Brunswick
Nova Scotia
Ontario
Prince Edward Island
Quebec

References:

Bailey, L. H., Bailey, E. Z. 1976. Hortus third. Revised. MacMillan, New York, N.Y., USA. 1290 pp.

Boivin, B. 1966, 1967. Énumération des plantes du Canada. Provencheria 6. Nat. Can. (Que.) 93: 253-274; 371-437; 583-646; 989-1063. 94: 131-157; 471-528; 625-655.

Image or illustration

Lactuca scariola:

Images: images.google.com

Notes on Poisonous plant parts:

Mature plants and dried plant material are reported to be harmless. Regrowth of the plants in autumn has caused poisoning in field cases in the western rangelands of the United States (Beath et al. 1953).

Toxic parts:

young shoots

References:

Beath, O. A., Gilbert, C. S., Eppson, H. F., Rosenfeld, I. 1953. Poisonous plants and livestock poisoning. Wyo. Agric. Exp. Stn. Bull., 324. 94 pp.

Toxic plant chemicals:

unknown chemical

References:

Beath, O. A., Gilbert, C. S., Eppson, H. F., Rosenfeld, I. 1953. Poisonous plants and livestock poisoning. Wyo. Agric. Exp. Stn. Bull., 324. 94 pp.

Animals/Human Poisoning:

Note: When an animal is listed without additional information, the literature (as of 1993) contained no detailed explanation.

Cattle

General symptoms of poisoning:

[breathing, labored](#)

[emphysema](#)

[weakness](#)

Notes on poisoning:

Symptoms include pulmonary emphysema, characterized by weakness and difficult breathing. Postmortem examination shows the lung tissue inflamed, with almost complete destruction of the air-cell tissue (Beath et al. 1953).

References:

Beath, O. A., Gilbert, C. S., Eppson, H. F., Rosenfeld, I. 1953. Poisonous plants and livestock poisoning. Wyo. Agric. Exp. Stn. Bull., 324. 94 pp.

[Another search?](#)

[Français](#) | [Contact Us](#) | [Help](#) | [Search](#) | [Canada site](#)

[Coming Events](#) | [About CBIF](#) | [Links](#) | [Reports and Publications](#) | [Home](#)

Date modified: 2003-02-06

[Important Notices](#)



Français	Contact us	Help	Search	Canada site
Coming events	About CBIF	Links	Reports and publications	Home

Canadian Biodiversity Information Facility



Notes on poisoning: *Lantana camara*

[Introduction](#)[Interactive](#)[All poisonous plants by Botanical name](#)[All poisonous plants by Common name](#)[Important WWW Poisonous Plants sites](#)

General poisoning notes:

Yellow sage (*Lantana camara*) is occasionally sold as a houseplant and may also be planted outdoors in the summer in Canada. Children who ingested green berries became ill and died. In warmer parts of the world (e.g., Florida, Australia), the plant grows outside and becomes weedy. Livestock have been poisoned after ingesting the entire plants. Importantly, livestock that ingest berries exhibit symptoms that are different from those of children who ingest the berries. Livestock do not normally encounter this plant in Canada, but the symptoms of poisoning are included under cattle. Sheep and goats have also been poisoned. Care should be taken to keep children as well as family pets away from this plant (Wolfson and Solomons 1964, McLennan and Amos 1989, Spoerke and Smolinske 1990). Cats and dogs that have access to yellow sage indoors can become poisoned if they ingest the immature berries of foliage of this plant. No records were found in the literature of toxicity in pets from yellow sage ingestion.

References:

McLennan, M. W., Amos, M. L. 1989. Treatment of lantana poisoning in cattle. *Aust. Vet. J.*, 66: 93-94.

Spoerke, D. G., Smolinske, S. C. 1990. Toxicity of houseplants. CRC Press, Inc., Boca Raton, Fla., USA. 335 pp.

Wolfson, S. L., Solomons, T. W. 1964. Poisoning by fruit of *Lantana camara*. *Am. J. Dis. Child.*, 107: 109-112.

Nomenclature:

Scientific Name: *Lantana camara* L.

Vernacular name(s): yellow sage

Scientific family name: *Verbenaceae*

Vernacular family name: vervain

Go to ITIS^{*ca} for more taxonomic information on: [Lantana camara](#)

References:

Agriculture Quebec. 1975. Noms des maladies des plantes du Canada/ Names of plant diseases in Canada. , Quebec City, Que., Canada. 288 pp.

Alex, J. F., Cayouette, R., Mulligan, G. A. 1980. Common and botanical names of weeds in Canada/Noms populaire et scientifiques des plantes nuisibles du Canada. Revised. Agric. Can. Publ., Ottawa, Ont., Canada. 132 pp.

Bailey, L. H., Bailey, E. Z. 1976. Hortus third. Revised. MacMillan, New York, N.Y., USA. 1290 pp.

Scoggan, H. J. 1978, 1979. The flora of Canada. Nat. Mus. Nat. Sci. (Ottawa) Publ. Bot. 7(1)-7(4). 1711 pp.

Van Wijk, H. L. 1911. A dictionary of plant names. Martinus Nijhoff, The Hague, The Netherlands. 1444 pp.

Victorin, M. 1964. Flore Laurentienne. 2nd ed. Univ. Montreal, Montreal, Que., Canada. 952 pp.

Geographic Information

Plant or plant parts used in or around the home.

References:

Bailey, L. H., Bailey, E. Z. 1976. Hortus third. Revised. MacMillan, New York, N.Y., USA. 1290 pp.

Boivin, B. 1966, 1967. Énumération des plantes du Canada. Provencheria 6. Nat. Can. (Que.) 93: 253-274; 371-437; 583-646; 989-1063. 94: 131-157; 471-528; 625-655.

Image or illustration

Lantana camara:

Images: images.google.com

Notes on Poisonous plant parts:

Ingesting the leaves has caused poisoning in livestock in areas

where the plant can survive outdoors, such as Florida and Australia. Young children who ingested the green berries became ill and died (Wolfson and Solomons 1964, McLennan and Amos 1989).

Toxic parts:

immature fruit
leaves

References:

McLennan, M. W., Amos, M. L. 1989. Treatment of lantana poisoning in cattle. Aust. Vet. J., 66: 93-94.

Sharma, O. P., Dawra, R. K., Makkar, H. P. 1989. Toxicity of isolated lantana (*Lantana camara* L.) constituents to male and female guinea pigs. Vet. Hum. Toxicol., 31: 10-13.

Notes on Toxic plant chemicals:

Lantadene A and lantadene B, which are pentacyclic triterpenes, have been suspected as the toxic constituents of yellow sage leaves. However, there are conflicting findings on the chemical toxins and their toxic affects on animals. Sharma et al. (1989) found that crystal polymorphism in the triterpenoids changes the toxicity (polyhedral crystals are toxic to guinea pigs and rod-shaped crystals are not). In addition, the toxic component of the berries has not been defined. The plant also contains a fish poison, lancamarone, that is present in the greatest concentration in the summer. The effects of this chemical on mammals have not been studied (Spoerke and Smolinske 1990).

Toxic plant chemicals:

lantadene A & B

References:

Sharma, O. P., Dawra, R. K., Makkar, H. P. 1989. Toxicity of isolated lantana (*Lantana camara* L.) constituents to male and female guinea pigs. Vet. Hum. Toxicol., 31: 10-13.

Animals/Human Poisoning:

Note: When an animal is listed without additional information, the literature (as of 1993) contained no detailed explanation.

Cats

Cattle

General symptoms of poisoning:

[appetite, loss of](#)

[dehydration](#)

[jaundice](#)

[urine, yellowish](#)

References:

Spoerke, D. G., Smolinske, S. C. 1990. Toxicity of houseplants. CRC Press, Inc., Boca Raton, Fla., USA. 335 pp.

Dogs

Goats

Humans

General symptoms of poisoning:

[ataxia](#)

[breathing, labored](#)

[cyanosis](#)

[death](#)

[diarrhea](#)

[lethargy](#)

[liver, congestion of](#)

[pupil dilation](#)

[pupils, pinpoint](#)

[unconsciousness](#)

[vomiting](#)

[weakness](#)

Notes on poisoning:

Ingesting the green berries of yellow sage produces the following symptoms: vomiting, diarrhea, weakness, lethargy, cyanosis, slow labored breathing, dilated pupils, ataxia, coma, and depressed deep tendon reflexes. Postmortem findings showed congestion of the lungs and kidneys. The small intestines were dilated. These symptoms all occurred after an unknown quantity of the immature green berries was ingested. The rough texture of the leaves and stems discourages children from ingesting them. Humans have therefore not shown the photosensitivity and liver problems that occur when livestock ingest entire plants. Lavage

should be done quickly to reduce or prevent symptoms. Several authors have reported that the ripe berries are nontoxic to humans (Wolfson and Solomons 1964, Spoerke and Smolinske 1990).

References:

Spoerke, D. G., Smolinske, S. C. 1990. Toxicity of houseplants. CRC Press, Inc., Boca Raton, Fla., USA. 335 pp.

Wolfson, S. L., Solomons, T. W. 1964. Poisoning by fruit of *Lantana camara*. Am. J. Dis. Child., 107: 109-112.

Sheep

[Another search?](#)

[Français](#) | [Contact Us](#) | [Help](#) | [Search](#) | [Canada site](#)

[Coming Events](#) | [About CBIF](#) | [Links](#) | [Reports and Publications](#) |

[Home](#)

Date modified: 2003-02-06

[Important Notices](#)



Français	Contact us	Help	Search	Canada site
Coming events	About CBIF	Links	Reports and publications	Home

Canadian Biodiversity Information Facility



Notes on poisoning: *Laportea canadensis*

[Introduction](#)[Interactive](#)[All poisonous plants by Botanical name](#)[All poisonous plants by Common name](#)[Important WWW Poisonous Plants sites](#)

General poisoning notes:

Canada nettle (*Laportea canadensis*) is found in moist woods and along streams. This plant has stinging hairs on the leaves and stem that readily penetrate thin-skinned areas on humans. The tips of the hairs break off, allowing the contained liquid to penetrate the body. Intense localized itching results. Applying water to the surface of the affected area can increase the sensation; this problem may persist for several weeks. In Australia, other members of the genus *Laportea* have caused severe reactions in humans, and a death was reported in New Guinea after severe exposure. Livestock have responded frantically to contact with these plants in Australia. Canada nettle can cause reactions in animals upon exposure in Canada. Avoid this plant if possible (MacFarlane 1963, Mitchell and Rook 1979).

References:

MacFarlane, W. V. 1963. The stinging properties of *Laportea*. *Econ. Bot.*, 17: 303-311.

Nomenclature:

Scientific Name: *Laportea canadensis* (L.) Gaud.

Vernacular name(s): Canada nettle

Scientific family name: *Urticaceae*

Vernacular family name: nettle

Go to ITIS*^{ca} for more taxonomic information on: [Laportea canadensis](#)

References:

Agriculture Quebec. 1975. Noms des maladies des plantes du Canada/ Names of plant diseases in Canada. , Quebec City, Que., Canada. 288 pp.

Alex, J. F., Cayouette, R., Mulligan, G. A. 1980. Common and botanical names of weeds in Canada/Noms populaire et scientifiques des plantes nuisibles du Canada. Revised. Agric. Can. Publ., Ottawa, Ont., Canada. 132 pp.

Bailey, L. H., Bailey, E. Z. 1976. Hortus third. Revised. MacMillan, New York, N.Y., USA. 1290 pp.

Scoggan, H. J. 1978, 1979. The flora of Canada. Nat. Mus. Nat. Sci. (Ottawa) Publ. Bot. 7(1)-7(4). 1711 pp.

Van Wijk, H. L. 1911. A dictionary of plant names. Martinus Nijhoff, The Hague, The Netherlands. 1444 pp.

Victorin, M. 1964. Flore Laurentienne. 2nd ed. Univ. Montreal, Montreal, Que., Canada. 952 pp.

Geographic Information

Manitoba
New Brunswick
Nova Scotia
Ontario
Quebec
Saskatchewan

References:

Bailey, L. H., Bailey, E. Z. 1976. Hortus third. Revised. MacMillan, New York, N.Y., USA. 1290 pp.

Boivin, B. 1966, 1967. Énumération des plantes du Canada. Provencheria 6. Nat. Can. (Que.) 93: 253-274; 371-437; 583-646; 989-1063. 94: 131-157; 471-528; 625-655.

Image or illustration

Laportea canadensis:

Images: images.google.com

Notes on Poisonous plant parts:

Canada nettle is covered with stinging hairs on the leaves and stem. The tips of the hairs are readily fractured on contact with

skin, allowing the internal liquid to be injected into the local body area. The hairs are sharply pointed, allowing ready penetration of thinner skinned portions of the body (MacFarlane 1963).

Toxic parts:

hairs

References:

MacFarlane, W. V. 1963. The stinging properties of *Laportea*. Econ. Bot., 17: 303-311.

Notes on Toxic plant chemicals:

The active ingredient in the stinging hairs is not known. The chemicals acetylcholine, histamine, and 5-hydroxytryptamine, which cause the stinging of hairs from the closely related American stinging nettle (*Urtica dioica*), are not the primary toxic chemicals in Canada nettle. Some studies on native Australian *Laportea* species have shown that no detectable loss of activity occurs after 46 years in a dry state. Immersion in boiling water for 10 min does not deactivate the chemical. In fact, the pain is intensified in humans if the affected area is exposed to water, a reaction that may last for many weeks (MacFarlane 1963).

Toxic plant chemicals:

unknown chemical

References:

MacFarlane, W. V. 1963. The stinging properties of *Laportea*. Econ. Bot., 17: 303-311.

Animals/Human Poisoning:

Note: When an animal is listed without additional information, the literature (as of 1993) contained no detailed explanation.

Humans

General symptoms of poisoning:

[erythema](#)

[itchiness](#)

[pain](#)

[skin, flushed](#)

Notes on poisoning:

Canada nettle hairs induce localized pain and discomfort as well as erythema, reddening, and localized sweating. The pain may persist for weeks. Canada nettle differs from American stinging nettle (*Urtica dioica*) in that the intense pain can persist for weeks or months (MacFarlane 1963, Mitchell and Rook 1979).

References:

MacFarlane, W. V. 1963. The stinging properties of *Laportea*. Econ. Bot., 17: 303-311.

[Another search?](#)

[Français](#) | [Contact Us](#) | [Help](#) | [Search](#) | [Canada site](#)

[Coming Events](#) | [About CBIF](#) | [Links](#) | [Reports and Publications](#) | [Home](#)

Date modified: 2003-02-06

[Important Notices](#)



Français	Contact us	Help	Search	Canada site
Coming events	About CBIF	Links	Reports and publications	Home

Canadian Biodiversity Information Facility



Notes on poisoning: *Lathyrus odoratus*

[Introduction](#)[Interactive](#)[All poisonous plants by Botanical name](#)[All poisonous plants by Common name](#)[Important WWW Poisonous Plants sites](#)

General poisoning notes:

Sweet pea (*Lathyrus odoratus*) is a summer annual commonly cultivated because of its beautiful fragrant flowers. The pods and seeds contain BAPN (beta-aminopropionitrile), which causes osteolathyrism, a syndrome characterized by skeletal deformities and aortic rupture. This chemical was first extracted from sweet pea plants and has since been found in some other members of the genus *Lathyrus*. Horses are more susceptible to this syndrome than other livestock. Most of the information on osteolathyrism is based on experimental work. This problem has not occurred in humans; instead, see neurolathyrins under grass pea ([Lathyrus sativus](#)). In Canada, ingesting enough sweet pea to cause osteolathyrism is not likely (Selye 1957, Cheeke and Schull 1985).



References:

Cheeke, P. R., Shull, L. R. 1985. Natural toxicants in feeds and poisonous plants. AVI Publishing Company, Inc., Westport, Conn., USA. 492 pp.

Lalich, J. J., Barnett, B. D., Bird, H. R. 1957. Production of aortic rupture in turkey poultts fed beta-aminopropionitrile. Arch. Pathol., 64: 643-648.

Selye, H. 1957. Lathyrism. Rev. Can. Biol., 16: 1-82.

Simpson, C. F., Cardeilhac, P. T. 1983. Mortality, hemodynamics, an aortic properties among male and female turkeys fed beta-aminopropionitrile (41541). Proc. Soc. Exp. Biol. Med., 172: 168-172.

Nomenclature:

Scientific Name: *Lathyrus odoratus* L.

Vernacular name(s): sweet pea

Scientific family name: *Leguminosae*

Vernacular family name: pea

Go to ITIS^{*ca} for more taxonomic information on: [Lathyrus odoratus](#)

References:

Agriculture Quebec. 1975. Noms des maladies des plantes du Canada/ Names of plant diseases in Canada. , Quebec City, Que., Canada. 288 pp.

Alex, J. F., Cayouette, R., Mulligan, G. A. 1980. Common and botanical names of weeds in Canada/Noms populaire et scientifiques des plantes nuisibles du Canada. Revised. Agric. Can. Publ., Ottawa, Ont., Canada. 132 pp.

Bailey, L. H., Bailey, E. Z. 1976. Hortus third. Revised. MacMillan, New York, N.Y., USA. 1290 pp.

Scoggan, H. J. 1978, 1979. The flora of Canada. Nat. Mus. Nat. Sci. (Ottawa) Publ. Bot. 7(1)-7(4). 1711 pp.

Van Wijk, H. L. 1911. A dictionary of plant names. Martinus Nijhoff, The Hague, The Netherlands. 1444 pp.

Victorin, M. 1964. Flore Laurentienne. 2nd ed. Univ. Montreal, Montreal, Que., Canada. 952 pp.

Geographic Information

Plant or plant parts used in or around the home.

References:

Bailey, L. H., Bailey, E. Z. 1976. Hortus third. Revised. MacMillan, New York, N.Y., USA. 1290 pp.

Boivin, B. 1966, 1967. Énumération des plantes du Canada. Provencheria 6. Nat. Can. (Que.) 93: 253-274; 371-437; 583-646; 989-1063. 94: 131-157; 471-528; 625-655.

Image or illustration

Lathyrus odoratus:

Images: images.google.com

Toxic parts:

seeds

References:

Roy, D. N., Spencer, P. S. 1989. Lathyrogens. Pages 169-201 in Cheeke, P. R., ed. Toxicants of plant origin. Vol. III. Proteins and amino acids. CRC Press, Inc., Boca Raton, Fla., USA. 271 pp.

Toxic plant chemicals:

beta-aminopropionitrile

References:

Roy, D. N., Spencer, P. S. 1989. Lathyrogens. Pages 169-201 in Cheeke, P. R., ed. Toxicants of plant origin. Vol. III. Proteins and amino acids. CRC Press, Inc., Boca Raton, Fla., USA. 271 pp.

Animals/Human Poisoning:

Note: When an animal is listed without additional information, the literature (as of 1993) contained no detailed explanation.

Horses

General symptoms of poisoning:

[aneurysm](#)

[gait, rigid](#)

[scoliosis](#)

Notes on poisoning:

Literature reports of osteolathyrism show that horses are particularly susceptible. Symptoms include skeletal deformity, such as long bone curvature, kyphosis, scoliosis, osteoporosis, and poor development of connective tissue. Aortic rupture also occurs. These effects are due to defective synthesis of collagen and elastin tissue caused by BAPN (Cheeke and Schull 1985).

References:

Cheeke, P. R., Shull, L. R. 1985. Natural toxicants in feeds and poisonous plants. AVI Publishing Company, Inc., Westport, Conn., USA. 492 pp.

Rodents

General symptoms of poisoning:

[abortion](#)

[aneurysm](#)

[bones, fragile](#)

Notes on poisoning:

Experimental feeding of sweet pea seeds to rats has caused symptoms of osteolathyrism, including the production of fragile bones, muscle atrophy, fatty bone marrow, hernias, thin skin, and scoliosis (Selye 1957, Cheeke and Schull 1985).

References:

Selye, H. 1957. Lathyrism. Rev. Can. Biol., 16: 1-82.

Turkeys

General symptoms of poisoning:

[aneurysm](#)

Notes on poisoning:

Experimental feeding of the toxic chemical beta-aminopropionitrile (BAPN) caused aortic dissecting aneurysms in turkey poults. Mortality was quite high as a result. See additional information under general notes of [Lathyrus sativus](#) (Lalich et al. 1957, Simpson and Cardeilhac 1983).

References:

Lalich, J. J., Barnett, B. D., Bird, H. R. 1957. Production of aortic rupture in turkey poults fed beta-aminopropionitrile. Arch. Pathol., 64: 643-648.

Simpson, C. F., Cardeilhac, P. T. 1983. Mortality, hemodynamics, an aortic properties among male and female turkeys fed beta-aminopropionitrile (41541). Proc. Soc. Exp. Biol. Med., 172: 168-172.

[Another search?](#)

[Français](#) | [Contact Us](#) | [Help](#) | [Search](#) | [Canada site](#)

[Coming Events](#) | [About CBIF](#) | [Links](#) | [Reports and Publications](#) | [Home](#)

Date modified: 2003-02-06

[Important Notices](#)



Français	Contact us	Help	Search	Canada site
Coming events	About CBIF	Links	Reports and publications	Home

Canadian Biodiversity Information Facility



Notes on poisoning: *Lathyrus sativus*

[Introduction](#)[Interactive](#)[All poisonous plants by Botanical name](#)[All poisonous plants by Common name](#)[Important WWW Poisonous Plants sites](#)

General poisoning notes:

Grass pea (*Lathyrus sativa*) has been used as a food and forage crop in Europe and Asia, where ingesting the seeds for 3-6 months can cause neurolathyrism, a syndrome characterized by muscular rigidity, weakness, and paralysis of the leg muscles. In severe cases, victims may be reduced to crawling. Young men between 20 and 30 years old are primarily affected. Livestock may also develop paralysis if they ingest grass pea for a long time. Neurolathyrism still occurs in India, where grass pea is used as flour (Cooper and Johnson 1984, Roy and Spencer 1989). Poisoning from grass pea is unlikely in Canada. However, some other *Lathyrus* species that occur in Canada may also contain BOAA.

References:

- Cooper, M. R., Johnson, A. W. 1984. Poisonous plants in Britain and their effects on animals and man. Her Majesty's Stationery Office, London, England. 305 pp.
- Liener, I. E. 1989. Antinutritional factors. Pages 339-382 in Matthews, R. H., ed. Legumes: chemistry, technology, and human nutrition. Marcel Dekker, Inc., New York, N.Y., USA. 934 pp.
- Roy, D. N., Spencer, P. S. 1989. Lathyrogens. Pages 169-201 in Cheeke, P. R., ed. Toxicants of plant origin. Vol. III. Proteins and amino acids. CRC Press, Inc., Boca Raton, Fla., USA. 271 pp.
- Selye, H. 1957. Lathyrism. Rev. Can. Biol., 16: 1-82.

Nomenclature:

Scientific Name: *Lathyrus sativus* L.

Vernacular name(s): grass pea

Scientific family name: *Leguminosae*

Vernacular family name: pea

Go to ITIS^{*ca} for more taxonomic information on: [Lathyrus sativus](#)

References:

Agriculture Quebec. 1975. Noms des maladies des plantes du Canada/ Names of plant diseases in Canada. , Quebec City, Que., Canada. 288 pp.

Alex, J. F., Cayouette, R., Mulligan, G. A. 1980. Common and botanical names of weeds in Canada/Noms populaire et scientifiques des plantes nuisibles du Canada. Revised. Agric. Can. Publ., Ottawa, Ont., Canada. 132 pp.

Bailey, L. H., Bailey, E. Z. 1976. Hortus third. Revised. MacMillan, New York, N.Y., USA. 1290 pp.

Scoggan, H. J. 1978, 1979. The flora of Canada. Nat. Mus. Nat. Sci. (Ottawa) Publ. Bot. 7(1)-7(4). 1711 pp.

Van Wijk, H. L. 1911. A dictionary of plant names. Martinus Nijhoff, The Hague, The Netherlands. 1444 pp.

Victorin, M. 1964. Flore Laurentienne. 2nd ed. Univ. Montreal, Montreal, Que., Canada. 952 pp.

Geographic Information

Plant or plant parts used in or around the home.

References:

Bailey, L. H., Bailey, E. Z. 1976. Hortus third. Revised. MacMillan, New York, N.Y., USA. 1290 pp.

Boivin, B. 1966, 1967. Énumération des plantes du Canada. Provencheria 6. Nat. Can. (Que.) 93: 253-274; 371-437; 583-646; 989-1063. 94: 131-157; 471-528; 625-655.

Image or illustration

Lathyrus sativus:

Images: images.google.com

Toxic parts:

mature fruit

seeds

References:

Roy, D. N., Spencer, P. S. 1989. Lathyrogens. Pages 169-201 in Cheeke, P. R., ed. Toxicants of plant origin. Vol. III. Proteins and amino acids. CRC Press, Inc., Boca Raton, Fla., USA. 271 pp.

Notes on Toxic plant chemicals:

BOAA (beta-N-oxalylamino-L-alanine) is generally regarded as the cause of neurolathyrism, although the exact nomenclature is still under study. The concentration of BOAA in the seed varies from 0.1 to 2.5%. This variation may help explain the conflicting reports of toxicity (Roy and Spencer 1989).

Toxic plant chemicals:

beta-N-oxalylamino-L-alanine

References:

Roy, D. N., Spencer, P. S. 1989. Lathyrogens. Pages 169-201 in Cheeke, P. R., ed. Toxicants of plant origin. Vol. III. Proteins and amino acids. CRC Press, Inc., Boca Raton, Fla., USA. 271 pp.

Animals/Human Poisoning:

Note: When an animal is listed without additional information, the literature (as of 1993) contained no detailed explanation.

Humans

General symptoms of poisoning:

[paralysis](#)

References:

Selye, H. 1957. Lathyrism. Rev. Can. Biol., 16: 1-82.

[Another search?](#)

[Français](#) | [Contact Us](#) | [Help](#) | [Search](#) | [Canada site](#)

[Coming Events](#) | [About CBIF](#) | [Links](#) | [Reports and Publications](#) | [Home](#)

Date modified: 2003-02-06

[Important Notices](#)



Français	Contact us	Help	Search	Canada site
Coming events	About CBIF	Links	Reports and publications	Home

Canadian Biodiversity Information Facility



Notes on poisoning: *Leonurus cardiaca*

[Introduction](#)[Interactive](#)[All poisonous plants by Botanical name](#)[All poisonous plants by Common name](#)[Important WWW Poisonous Plants sites](#)

General poisoning notes:

Motherwort (*Leonurus cardiaca*) is a naturalized herb that is weedy in flower and fruit gardens. This plant can cause dermatitis in sensitive individuals. A fragrant lemon-scented oil caused photosensitivity when ingested (Muenscher 1975, Mitchell and Rook 1979).



References:

Mitchell, J. C., Rook, A. 1979. Botanical dermatology. Greenglass Ltd, Vancouver, B.C., Canada. 787 pp.

Muenscher, W. C. 1975. Poisonous plants of the United States. Revised. Collier Books, New York, N.Y., USA. 277 pp.

Nomenclature:

Scientific Name: *Leonurus cardiaca* L.

Vernacular name(s): motherwort

Scientific family name: *Labiatae*

Vernacular family name: mint

Go to ITIS^{*ca} for more taxonomic information on: [Leonurus cardiaca](#)

References:

Agriculture Quebec. 1975. Noms des maladies des plantes du Canada/ Names of plant diseases in Canada. , Quebec City, Que., Canada. 288 pp.

Alex, J. F., Cayouette, R., Mulligan, G. A. 1980. Common and botanical names of weeds in Canada/Noms populaire et

scientifiques des plantes nuisibles du Canada. Revised. Agric. Can. Publ., Ottawa, Ont., Canada. 132 pp.

Bailey, L. H., Bailey, E. Z. 1976. Hortus third. Revised. MacMillan, New York, N.Y., USA. 1290 pp.

Scoggan, H. J. 1978, 1979. The flora of Canada. Nat. Mus. Nat. Sci. (Ottawa) Publ. Bot. 7(1)-7(4). 1711 pp.

Van Wijk, H. L. 1911. A dictionary of plant names. Martinus Nijhoff, The Hague, The Netherlands. 1444 pp.

Victorin, M. 1964. Flore Laurentienne. 2nd ed. Univ. Montreal, Montreal, Que., Canada. 952 pp.

Geographic Information

British Columbia
Manitoba
New Brunswick
Nova Scotia
Ontario
Prince Edward Island
Quebec
Saskatchewan

References:

Bailey, L. H., Bailey, E. Z. 1976. Hortus third. Revised. MacMillan, New York, N.Y., USA. 1290 pp.

Boivin, B. 1966, 1967. Énumération des plantes du Canada. Provencheria 6. Nat. Can. (Que.) 93: 253-274; 371-437; 583-646; 989-1063. 94: 131-157; 471-528; 625-655.

Image or illustration

Leonurus cardiaca:

Images: images.google.com

Toxic parts:

leaves

References:

Mitchell, J. C., Rook, A. 1979. Botanical dermatology. Greenglass Ltd, Vancouver, B.C., Canada. 787 pp.

Notes on Toxic plant chemicals:

A fragrant lemon-scented oil from the plant can cause photosensitization (Mitchell and Rook 1979).

Toxic plant chemicals:

unknown chemical

References:

Mitchell, J. C., Rook, A. 1979. Botanical dermatology. Greenglass Ltd, Vancouver, B.C., Canada. 787 pp.

Animals/Human Poisoning:

Note: When an animal is listed without additional information, the literature (as of 1993) contained no detailed explanation.

Humans

[Another search?](#)

[Français](#) | [Contact Us](#) | [Help](#) | [Search](#) | [Canada site](#)

[Coming Events](#) | [About CBIF](#) | [Links](#) | [Reports and Publications](#) |

[Home](#)

Date modified: 2003-02-06

[Important Notices](#)



Français	Contact us	Help	Search	Canada site
Coming events	About CBIF	Links	Reports and publications	Home

Canadian Biodiversity Information Facility



Notes on poisoning: *Ligustrum vulgare*

[Introduction](#)[Interactive](#)[All poisonous plants by Botanical name](#)[All poisonous plants by Common name](#)[Important WWW Poisonous Plants sites](#)

General poisoning notes:

Common privet (*Ligustrum vulgare*) is an ornamental shrub that is often planted as a hedge, and therefore the flowers and berries are trimmed. In older European literature, ingesting the berries has been noted to cause sickness in children. In more recent cases of ingestion by children, symptoms included only vomiting and diarrhea, after up to 12 berries were eaten (Frohne and Pfander 1983). Reynard and Norton (1942) cite the case of sheep that died after ingesting the trimmings from a hedge of a related privet (*Ligustrum ovalifolium*).

References:

Frohne, D., Pfander, H. J. 1983. A colour atlas of poisonous plants. Wolfe Publishing Ltd., London, England. 291 pp.

Nomenclature:

Scientific Name: *Ligustrum vulgare* L.

Vernacular name(s): common privet

Scientific family name: *Oleaceae*

Vernacular family name: olive

Go to ITIS^{*ca} for more taxonomic information on: [Ligustrum vulgare](#)

References:

Agriculture Quebec. 1975. Noms des maladies des plantes du Canada/ Names of plant diseases in Canada. , Quebec City, Que., Canada. 288 pp.

Alex, J. F., Cayouette, R., Mulligan, G. A. 1980. Common and

botanical names of weeds in Canada/Noms populaire et scientifiques des plantes nuisibles du Canada. Revised. Agric. Can. Publ., Ottawa, Ont., Canada. 132 pp.

Bailey, L. H., Bailey, E. Z. 1976. Hortus third. Revised. MacMillan, New York, N.Y., USA. 1290 pp.

Scoggan, H. J. 1978, 1979. The flora of Canada. Nat. Mus. Nat. Sci. (Ottawa) Publ. Bot. 7(1)-7(4). 1711 pp.

Van Wijk, H. L. 1911. A dictionary of plant names. Martinus Nijhoff, The Hague, The Netherlands. 1444 pp.

Victorin, M. 1964. Flore Laurentienne. 2nd ed. Univ. Montreal, Montreal, Que., Canada. 952 pp.

Geographic Information

Plant or plant parts used in or around the home.

References:

Bailey, L. H., Bailey, E. Z. 1976. Hortus third. Revised. MacMillan, New York, N.Y., USA. 1290 pp.

Boivin, B. 1966, 1967. Énumération des plantes du Canada. Provencheria 6. Nat. Can. (Que.) 93: 253-274; 371-437; 583-646; 989-1063. 94: 131-157; 471-528; 625-655.

Image or illustration

Ligustrum vulgare:

Images: images.google.com

Toxic parts:

mature fruit

References:

Frohne, D., Pfander, H. J. 1983. A colour atlas of poisonous plants. Wolfe Publishing Ltd., London, England. 291 pp.

Notes on Toxic plant chemicals:

Unknown chemicals are involved in common privet poisoning. Frohne and Pfander (1983) note that lignan glycosides, saponins, and seco- iridoid bitter substances are likely involved.

Toxic plant chemicals:

unknown chemical

References:

Frohne, D., Pfander, H. J. 1983. A colour atlas of poisonous plants. Wolfe Publishing Ltd., London, England. 291 pp.

Animals/Human Poisoning:

Note: When an animal is listed without additional information, the literature (as of 1993) contained no detailed explanation.

Humans

General symptoms of poisoning:

[diarrhea](#)

[vomiting](#)

Notes on poisoning:

In recent reports the berries of common privet produced symptoms of diarrhea and vomiting only. In older literature, death was reported. Gastroenteritis may persist for 48-72 h. (Frohne and Pfander 1983, Lampe and McCann 1985).

References:

Frohne, D., Pfander, H. J. 1983. A colour atlas of poisonous plants. Wolfe Publishing Ltd., London, England. 291 pp.

[Another search?](#)

[Français](#) | [Contact Us](#) | [Help](#) | [Search](#) | [Canada site](#)

[Coming Events](#) | [About CBIF](#) | [Links](#) | [Reports and Publications](#) | [Home](#)

Date modified: 2003-02-06

[Important Notices](#)



Français	Contact us	Help	Search	Canada site
Coming events	About CBIF	Links	Reports and publications	Home

Canadian Biodiversity Information Facility



Notes on poisoning: *Linaria vulgaris*

[Introduction](#)[Interactive](#)[All poisonous plants by Botanical name](#)[All poisonous plants by Common name](#)[Important WWW Poisonous Plants sites](#)

General poisoning notes:

Yellow toadflax (*Linaria vulgaris*) is an introduced herb that is widely naturalized across Canada. This plant contains several compounds, including glucosides and the cyanogenic glucoside prunasin. The plant is regarded as toxic to livestock in Europe. Cattle generally avoid grazing stands of this plant, but there is more potential for poisoning when the animals are provided with hay that has a high content of yellow toadflax. No definitive records of poisoning are found in the literature. Other members of the genus are found in Canada as well, including the introduced Dalmatian toadflax (*Linaria dalmatica*). For safety's sake, hay should not be fed to livestock if it contains a high content of these plants.

References:

Kingsbury, J. M. 1964. Poisonous plants of the United States and Canada. Prentice-Hall Inc., Englewood Cliffs, N.J., USA. 626 pp.

Sticher, O. 1971. Isolation of antirrinocide from *Linaria vulgaris*. Phytochemistry (Oxf.), 10: 1974-1975.

Nomenclature:

Scientific Name: *Linaria vulgaris* Mill.

Vernacular name(s): yellow toadflax

Scientific family name: *Scrophulariaceae*

Vernacular family name: frigwort

Go to ITIS^{*ca} for more taxonomic information on: [Linaria vulgaris](#)

References:

Agriculture Quebec. 1975. Noms des maladies des plantes du Canada/ Names of plant diseases in Canada. , Quebec City, Que., Canada. 288 pp.

Alex, J. F., Cayouette, R., Mulligan, G. A. 1980. Common and botanical names of weeds in Canada/Noms populaire et scientifiques des plantes nuisibles du Canada. Revised. Agric. Can. Publ., Ottawa, Ont., Canada. 132 pp.

Bailey, L. H., Bailey, E. Z. 1976. Hortus third. Revised. MacMillan, New York, N.Y., USA. 1290 pp.

Scoggan, H. J. 1978, 1979. The flora of Canada. Nat. Mus. Nat. Sci. (Ottawa) Publ. Bot. 7(1)-7(4). 1711 pp.

Van Wijk, H. L. 1911. A dictionary of plant names. Martinus Nijhoff, The Hague, The Netherlands. 1444 pp.

Victorin, M. 1964. Flore Laurentienne. 2nd ed. Univ. Montreal, Montreal, Que., Canada. 952 pp.

Geographic Information

Alberta
British Columbia
Labrador
Manitoba
New Brunswick
Newfoundland
Northwest Territories
Nova Scotia
Ontario
Prince Edward Island
Quebec
Saskatchewan

References:

Bailey, L. H., Bailey, E. Z. 1976. Hortus third. Revised. MacMillan, New York, N.Y., USA. 1290 pp.

Boivin, B. 1966, 1967. Énumération des plantes du Canada. Provencheria 6. Nat. Can. (Que.) 93: 253-274; 371-437; 583-646; 989-1063. 94: 131-157; 471-528; 625-655.

Image or illustration

Linaria vulgaris:

Images: images.google.com

Toxic parts:

leaves

References:

Sticher, O. 1971. Isolation of antirrinocide from *Linaria vulgaris*. *Phytochemistry (Oxf.)*, 10: 1974-1975.

Notes on Toxic plant chemicals:

Yellow toadflax contains several chemicals, including the cyanogenic glycoside prunasin. It also contains a glucoside, antirrinocide (Sticher 1974; Conn 1981).

Toxic plant chemicals:

antirrinocide

prunasin

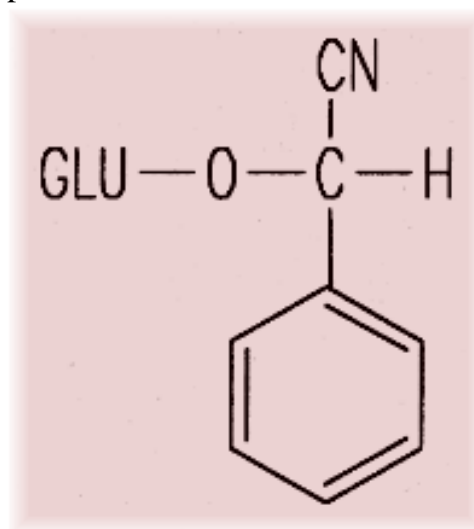

Chemical diagram(s) are courtesy of [Ruth McDiarmid](#), Biochemistry Technician, Kamloops Range Station, Agriculture and Agri-Food Canada, Kamloops, British Columbia, Canada.

References:

Conn, E. E. 1981. Cyanogenic glycosides. Pages 479-501 in Stumpf, P. K., Conn, E. E., eds. *The biochemistry of plants*. Vol. 7. Secondary plant products. Academic Press, New York, N.Y., USA. 600 pp.

Sticher, O. 1971. Isolation of antirrinocide from *Linaria vulgaris*. *Phytochemistry (Oxf.)*, 10: 1974-1975.

Animals/Human Poisoning:

Note: When an animal is listed without additional information, the literature (as of 1993) contained no detailed explanation.

Cattle

General symptoms of poisoning:

[breathing, rapid](#)

[cyanosis](#)

[dyspnea](#)

[gait, staggering](#)

[paralysis](#)

Notes on poisoning:

General symptoms of cyanide poisoning are listed above. These symptoms have not been reported in the literature for ingestion of yellow toadflax. The general symptoms for cyanide poisoning were taken from Kingsbury (1964).

References:

Kingsbury, J. M. 1964. Poisonous plants of the United States and Canada. Prentice-Hall Inc., Englewood Cliffs, N.J., USA. 626 pp.

[Another search?](#)

[Français](#) | [Contact Us](#) | [Help](#) | [Search](#) | [Canada site](#)

[Coming Events](#) | [About CBIF](#) | [Links](#) | [Reports and Publications](#) |

[Home](#)

Date modified: 2003-02-06

[Important Notices](#)



Français	Contact us	Help	Search	Canada site
Coming events	About CBIF	Links	Reports and publications	Home

Canadian Biodiversity Information Facility



Notes on poisoning: *Lobelia cardinalis*

[Introduction](#)[Interactive](#)[All poisonous plants by Botanical name](#)[All poisonous plants by Common name](#)[Important WWW Poisonous Plants sites](#)

General poisoning notes:

Cardinalflower (*Lobelia cardinalis*) is a native herb that grows along riverbanks and is occasionally found in garden flower beds as a perennial. This plant contains lobeline, which caused poisoning when misused as a home medicine. See the notes under Indian-tobacco ([Lobelia inflata](#)) for more information.



References:

Lampe, K. F., McCann, M. A. 1985. AMA Handbook of poisonous and injurious plants. American Medical Assoc. Chicago, Ill., USA. 432 pp.

Nomenclature:

Scientific Name: *Lobelia cardinalis* L.

Vernacular name(s): cardinalflower

Scientific family name: *Campanulaceae*

Vernacular family name: bellflower

Go to ITIS^{*ca} for more taxonomic information on: [Lobelia cardinalis](#)

References:

Agriculture Quebec. 1975. Noms des maladies des plantes du Canada/ Names of plant diseases in Canada. , Quebec City, Que., Canada. 288 pp.

Alex, J. F., Cayouette, R., Mulligan, G. A. 1980. Common and botanical names of weeds in Canada/Noms populaire et scientifiques des plantes nuisibles du Canada. Revised. Agric. Can. Publ., Ottawa, Ont., Canada. 132 pp.

Bailey, L. H., Bailey, E. Z. 1976. Hortus third. Revised. MacMillan, New York, N.Y., USA. 1290 pp.

Scoggan, H. J. 1978, 1979. The flora of Canada. Nat. Mus. Nat. Sci. (Ottawa) Publ. Bot. 7(1)-7(4). 1711 pp.

Van Wijk, H. L. 1911. A dictionary of plant names. Martinus Nijhoff, The Hague, The Netherlands. 1444 pp.

Victorin, M. 1964. Flore Laurentienne. 2nd ed. Univ. Montreal, Montreal, Que., Canada. 952 pp.

Geographic Information

New Brunswick
Ontario
Quebec

References:

Bailey, L. H., Bailey, E. Z. 1976. Hortus third. Revised. MacMillan, New York, N.Y., USA. 1290 pp.

Boivin, B. 1966, 1967. Énumération des plantes du Canada. Provencheria 6. Nat. Can. (Que.) 93: 253-274; 371-437; 583-646; 989-1063. 94: 131-157; 471-528; 625-655.

Image or illustration

Lobelia cardinalis:

Images: images.google.com

Toxic parts:

leaves
stems

References:

Lampe, K. F., McCann, M. A. 1985. AMA Handbook of poisonous and injurious plants. American Medical Assoc. Chicago, Ill., USA. 432 pp.

Toxic plant chemicals:

lobeline

References:

Lampe, K. F., McCann, M. A. 1985. AMA Handbook of poisonous and injurious plants. American Medical Assoc. Chicago, Ill., USA. 432 pp.

Animals/Human Poisoning:

Note: When an animal is listed without additional information, the literature (as of 1993) contained no detailed explanation.

Humans

[Another search?](#)

[Français](#) | [Contact Us](#) | [Help](#) | [Search](#) | [Canada site](#)

[Coming Events](#) | [About CBIF](#) | [Links](#) | [Reports and Publications](#) |

[Home](#)

Date modified: 2003-02-06

[Important Notices](#)



Français	Contact us	Help	Search	Canada site
Coming events	About CBIF	Links	Reports and publications	Home

Canadian Biodiversity Information Facility



Notes on poisoning: *Lobelia inflata*

[Introduction](#)[Interactive](#)[All poisonous plants by Botanical name](#)[All poisonous plants by Common name](#)[Important WWW Poisonous Plants sites](#)

General poisoning notes:

Indian-tobacco (*Lobelia inflata*) is a herb native to Canada. In the past, aboriginal people smoked its dried leaves. This plant and related *Lobelia* species were used as medicinal plants. Overdoses led to cases of poisoning, which resulted in fatalities. No modern cases of poisoning are found in the literature. The dried leaves of *Lobelia* may be found in health food stores as a herbal medicine (Lampe and McCann 1985).

References:

Lampe, K. F., McCann, M. A. 1985. AMA Handbook of poisonous and injurious plants. American Medical Assoc. Chicago, Ill., USA. 432 pp.

Nomenclature:

Scientific Name: *Lobelia inflata* L.

Vernacular name(s): Indian-tobacco

Scientific family name: *Campanulaceae*

Vernacular family name: bellflower

Go to ITIS^{*ca} for more taxonomic information on: [Lobelia inflata](#)

References:

Agriculture Quebec. 1975. Noms des maladies des plantes du Canada/ Names of plant diseases in Canada. , Quebec City, Que., Canada. 288 pp.

Alex, J. F., Cayouette, R., Mulligan, G. A. 1980. Common and botanical names of weeds in Canada/Noms populaire et scientifiques des plantes nuisibles du Canada. Revised. Agric.

Can. Publ., Ottawa, Ont., Canada. 132 pp.

Bailey, L. H., Bailey, E. Z. 1976. Hortus third. Revised. MacMillan, New York, N.Y., USA. 1290 pp.

Scoggan, H. J. 1978, 1979. The flora of Canada. Nat. Mus. Nat. Sci. (Ottawa) Publ. Bot. 7(1)-7(4). 1711 pp.

Van Wijk, H. L. 1911. A dictionary of plant names. Martinus Nijhoff, The Hague, The Netherlands. 1444 pp.

Victorin, M. 1964. Flore Laurentienne. 2nd ed. Univ. Montreal, Montreal, Que., Canada. 952 pp.

Geographic Information

British Columbia
New Brunswick
Nova Scotia
Ontario
Prince Edward Island
Quebec

References:

Bailey, L. H., Bailey, E. Z. 1976. Hortus third. Revised. MacMillan, New York, N.Y., USA. 1290 pp.

Boivin, B. 1966, 1967. Énumération des plantes du Canada. Provencheria 6. Nat. Can. (Que.) 93: 253-274; 371-437; 583-646; 989-1063. 94: 131-157; 471-528; 625-655.

Image or illustration

Lobelia inflata:

Images: images.google.com

Toxic parts:

leaves
stems

References:

Lampe, K. F., McCann, M. A. 1985. AMA Handbook of poisonous and injurious plants. American Medical Assoc. Chicago, Ill., USA. 432 pp.

Notes on Toxic plant chemicals:

Lobeline is one of several alkaloids found in Indian-tobacco and other *Lobelia* species. This extract has been used in home medicine for various purposes. Overdoses have resulted in cases of poisoning, including death. The dry leaves of *Lobelia* may be sold in health food stores as a herbal remedy.

Toxic plant chemicals:

lobeline

References:

Lampe, K. F., McCann, M. A. 1985. AMA Handbook of poisonous and injurious plants. American Medical Assoc. Chicago, Ill., USA. 432 pp.

Animals/Human Poisoning:

Note: When an animal is listed without additional information, the literature (as of 1993) contained no detailed explanation.

Humans

General symptoms of poisoning:

[collapse](#)

[coma](#)

[death](#)

[pain](#)

[paralysis](#)

[sweating](#)

[vomiting](#)

Notes on poisoning:

In overdoses of the plant extract, symptoms included vomiting, sweating, pain, paralysis, depressed temperature, rapid but feeble pulse, coma, and death (Kingsbury 1964).

References:

Lampe, K. F., McCann, M. A. 1985. AMA Handbook of poisonous and injurious plants. American Medical Assoc. Chicago, Ill., USA. 432 pp.

[Another search?](#)

[Français](#) | [Contact Us](#) | [Help](#) | [Search](#) | [Canada site](#)
[Coming Events](#) | [About CBIF](#) | [Links](#) | [Reports and Publications](#) |
[Home](#)

Date modified: 2003-02-06

[Important Notices](#)



Français	Contact us	Help	Search	Canada site
Coming events	About CBIF	Links	Reports and publications	Home

Canadian Biodiversity Information Facility



Notes on poisoning: *Lobelia siphilitica*

[Introduction](#)[Interactive](#)[All poisonous plants by Botanical name](#)[All poisonous plants by Common name](#)[Important WWW Poisonous Plants sites](#)

General poisoning notes:

Blue cardinalflower (*Lobelia siphilitica*) is a native herb found along wet river banks in southern Ontario. This plant contains an alkaloid, lobeline, that caused poisoning when the extract was used as a home remedy. For more information, see the notes under Indian- tobacco ([Lobelia inflata](#)).



References:

Lampe, K. F., McCann, M. A. 1985. AMA Handbook of poisonous and injurious plants. American Medical Assoc. Chicago, Ill., USA. 432 pp.

Nomenclature:

Scientific Name: *Lobelia siphilitica* L.

Vernacular name(s): blue cardinalflower

Scientific family name: *Campanulaceae*

Vernacular family name: bellflower

Go to ITIS^{*ca} for more taxonomic information on: [Lobelia siphilitica](#)

References:

Agriculture Quebec. 1975. Noms des maladies des plantes du Canada/ Names of plant diseases in Canada. , Quebec City, Que., Canada. 288 pp.

Alex, J. F., Cayouette, R., Mulligan, G. A. 1980. Common and botanical names of weeds in Canada/Noms populaire et scientifiques des plantes nuisibles du Canada. Revised. Agric. Can. Publ., Ottawa, Ont., Canada. 132 pp.

Bailey, L. H., Bailey, E. Z. 1976. Hortus third. Revised. MacMillan, New York, N.Y., USA. 1290 pp.

Scoggan, H. J. 1978, 1979. The flora of Canada. Nat. Mus. Nat. Sci. (Ottawa) Publ. Bot. 7(1)-7(4). 1711 pp.

Van Wijk, H. L. 1911. A dictionary of plant names. Martinus Nijhoff, The Hague, The Netherlands. 1444 pp.

Victorin, M. 1964. Flore Laurentienne. 2nd ed. Univ. Montreal, Montreal, Que., Canada. 952 pp.

Geographic Information

Ontario

References:

Bailey, L. H., Bailey, E. Z. 1976. Hortus third. Revised. MacMillan, New York, N.Y., USA. 1290 pp.

Boivin, B. 1966, 1967. Énumération des plantes du Canada. Provencheria 6. Nat. Can. (Que.) 93: 253-274; 371-437; 583-646; 989-1063. 94: 131-157; 471-528; 625-655.

Image or illustration

Lobelia siphilitica:

Images: images.google.com

Toxic parts:

leaves

stems

References:

Lampe, K. F., McCann, M. A. 1985. AMA Handbook of poisonous and injurious plants. American Medical Assoc. Chicago, Ill., USA. 432 pp.

Toxic plant chemicals:

lobeline

References:

Lampe, K. F., McCann, M. A. 1985. AMA Handbook of poisonous and injurious plants. American Medical Assoc.

Chicago, Ill., USA. 432 pp.

Animals/Human Poisoning:

Note: When an animal is listed without additional information, the literature (as of 1993) contained no detailed explanation.

Humans

[Another search?](#)

[Français](#) | [Contact Us](#) | [Help](#) | [Search](#) | [Canada site](#)

[Coming Events](#) | [About CBIF](#) | [Links](#) | [Reports and Publications](#) |

[Home](#)

Date modified: 2003-02-06

[Important Notices](#)



Français	Contact us	Help	Search	Canada site
Coming events	About CBIF	Links	Reports and publications	Home

Canadian Biodiversity Information Facility



Notes on poisoning: *Lonicera tatarica*

[Introduction](#)[Interactive](#)[All poisonous plants by Botanical name](#)[All poisonous plants by Common name](#)[Important WWW Poisonous Plants sites](#)

General poisoning notes:

Tartarian honeysuckle (*Lonicera tatarica*) is an ornamental shrub that has become naturalized throughout much of southern Canada. In European literature this plant have been implicated in the poisoning of children. See additional notes under fly honeysuckle, ([Lonicera xylosteum](#)).



References:

Frohne, D., Pfander, H. J. 1983. A colour atlas of poisonous plants. Wolfe Publishing Ltd., London, England. 291 pp.

Nomenclature:

Scientific Name: *Lonicera tatarica* L.

Vernacular name(s): Tartarian honeysuckle

Scientific family name: *Caprifoliaceae*

Vernacular family name: honeysuckle

Go to ITIS^{*ca} for more taxonomic information on: [Lonicera tatarica](#)

References:

Agriculture Quebec. 1975. Noms des maladies des plantes du Canada/ Names of plant diseases in Canada. , Quebec City, Que., Canada. 288 pp.

Alex, J. F., Cayouette, R., Mulligan, G. A. 1980. Common and botanical names of weeds in Canada/Noms populaire et scientifiques des plantes nuisibles du Canada. Revised. Agric. Can. Publ., Ottawa, Ont., Canada. 132 pp.

Bailey, L. H., Bailey, E. Z. 1976. Hortus third. Revised. MacMillan, New York, N.Y., USA. 1290 pp.

Scoggan, H. J. 1978, 1979. The flora of Canada. Nat. Mus. Nat. Sci. (Ottawa) Publ. Bot. 7(1)-7(4). 1711 pp.

Van Wijk, H. L. 1911. A dictionary of plant names. Martinus Nijhoff, The Hague, The Netherlands. 1444 pp.

Victorin, M. 1964. Flore Laurentienne. 2nd ed. Univ. Montreal, Montreal, Que., Canada. 952 pp.

Geographic Information

Alberta
Manitoba
New Brunswick
Ontario
Quebec
Saskatchewan

References:

Bailey, L. H., Bailey, E. Z. 1976. Hortus third. Revised. MacMillan, New York, N.Y., USA. 1290 pp.

Boivin, B. 1966, 1967. Énumération des plantes du Canada. Provencheria 6. Nat. Can. (Que.) 93: 253-274; 371-437; 583-646; 989-1063. 94: 131-157; 471-528; 625-655.

Image or illustration

Lonicera tatarica:

Images: images.google.com

Notes on Poisonous plant parts:

Ingesting the berries has caused mild toxicity in children (Frohne and Pfander 1983).

Toxic parts:

mature fruit

References:

Frohne, D., Pfander, H. J. 1983. A colour atlas of poisonous plants. Wolfe Publishing Ltd., London, England. 291 pp.

Notes on Toxic plant chemicals:

The toxic compounds are unknown, but they are suspected to be saponins (Frohne and Pfander 1983).

Toxic plant chemicals:

unknown chemical

References:

Frohne, D., Pfander, H. J. 1983. A colour atlas of poisonous plants. Wolfe Publishing Ltd., London, England. 291 pp.

Animals/Human Poisoning:

Note: When an animal is listed without additional information, the literature (as of 1993) contained no detailed explanation.

Humans

[Another search?](#)

[Français](#) | [Contact Us](#) | [Help](#) | [Search](#) | [Canada site](#)

[Coming Events](#) | [About CBIF](#) | [Links](#) | [Reports and Publications](#) |

[Home](#)

Date modified: 2003-02-06

[Important Notices](#)



Français	Contact us	Help	Search	Canada site
Coming events	About CBIF	Links	Reports and publications	Home

Canadian Biodiversity Information Facility



Notes on poisoning: *Lonicera xylosteum*

[Introduction](#)[Interactive](#)[All poisonous plants by Botanical name](#)[All poisonous plants by Common name](#)[Important WWW Poisonous Plants sites](#)

General poisoning notes:

Fly honeysuckle (*Lonicera xylosteum*) is cultivated in southwestern Quebec and southern Ontario. This ornamental shrub has been implicated in cases of poisoning of children in Europe. Recent literature indicates that cases of poisoning are rare, and the symptoms are considered mild. Experimental poisoning of rabbits has caused mild symptoms. Injecting fruit extracts at high doses has caused sickness and death in mice. Ingesting a large number of berries (ca. 30) may cause abdominal pain and vomiting in children (Frohne and Pfander 1983). Additional species of cultivated honeysuckle have also been implicated in cases of human poisoning. Woodbine (*Lonicera periclymenum*) may be poisonous. This climbing honeysuckle is occasionally planted. See the general notes under Tartarian honeysuckle, ([Lonicera tatarica](#)).

References:

Frohne, D., Pfander, H. J. 1983. A colour atlas of poisonous plants. Wolfe Publishing Ltd., London, England. 291 pp.

Lampe, K. F., McCann, M. A. 1985. AMA Handbook of poisonous and injurious plants. American Medical Assoc. Chicago, Ill., USA. 432 pp.

Nomenclature:

Scientific Name: *Lonicera xylosteum* L.

Vernacular name(s): fly honeysuckle

Scientific family name: *Caprifoliaceae*

Vernacular family name: honeysuckle

Go to ITIS*^{ca} for more taxonomic information on: [Lonicera](#)

[xylosteum](#)

References:

Agriculture Quebec. 1975. Noms des maladies des plantes du Canada/ Names of plant diseases in Canada. , Quebec City, Que., Canada. 288 pp.

Alex, J. F., Cayouette, R., Mulligan, G. A. 1980. Common and botanical names of weeds in Canada/Noms populaire et scientifiques des plantes nuisibles du Canada. Revised. Agric. Can. Publ., Ottawa, Ont., Canada. 132 pp.

Bailey, L. H., Bailey, E. Z. 1976. Hortus third. Revised. MacMillan, New York, N.Y., USA. 1290 pp.

Scoggan, H. J. 1978, 1979. The flora of Canada. Nat. Mus. Nat. Sci. (Ottawa) Publ. Bot. 7(1)-7(4). 1711 pp.

Van Wijk, H. L. 1911. A dictionary of plant names. Martinus Nijhoff, The Hague, The Netherlands. 1444 pp.

Victorin, M. 1964. Flore Laurentienne. 2nd ed. Univ. Montreal, Montreal, Que., Canada. 952 pp.

Geographic Information

Ontario

Quebec

References:

Bailey, L. H., Bailey, E. Z. 1976. Hortus third. Revised. MacMillan, New York, N.Y., USA. 1290 pp.

Boivin, B. 1966, 1967. Énumération des plantes du Canada. Provencheria 6. Nat. Can. (Que.) 93: 253-274; 371-437; 583-646; 989-1063. 94: 131-157; 471-528; 625-655.

Image or illustration

Lonicera xylosteum:

Images: images.google.com

Notes on Poisonous plant parts:

The berries have been implicated in cases of toxicity in Europe. In North America no cases of poisoning occurred after children ingested the berries (Lampe and McCann 1985).

Toxic parts:

mature fruit

References:

Frohne, D., Pfander, H. J. 1983. A colour atlas of poisonous plants. Wolfe Publishing Ltd., London, England. 291 pp.

Notes on Toxic plant chemicals:

The toxin is unknown, but saponins are thought to be responsible for the cases of poisoning. Traces of alkaloids were also found (Frohne and Pfander 1983).

Toxic plant chemicals:

unknown chemical

References:

Frohne, D., Pfander, H. J. 1983. A colour atlas of poisonous plants. Wolfe Publishing Ltd., London, England. 291 pp.

Animals/Human Poisoning:

Note: When an animal is listed without additional information, the literature (as of 1993) contained no detailed explanation.

Humans

General symptoms of poisoning:

[abdominal pains](#)

[diarrhea](#)

[vomiting](#)

Notes on poisoning:

Symptoms of ingestion include abdominal pain, diarrhea, and vomiting. More severe symptoms have been listed in early European literature, but severe toxicity has not been conclusively documented (Frohne and Pfander 1983).

References:

Frohne, D., Pfander, H. J. 1983. A colour atlas of poisonous plants. Wolfe Publishing Ltd., London, England. 291 pp.

Rabbits

General symptoms of poisoning:

[diarrhea](#)

Notes on poisoning:

Experimental feeding of berries (dry weight at 25 g/kg of body weight) to rabbits caused diarrhea and lack of movement within 24 h Frohne and Pfander 1983).

References:

Frohne, D., Pfander, H. J. 1983. A colour atlas of poisonous plants. Wolfe Publishing Ltd., London, England. 291 pp.

Rodents

General symptoms of poisoning:

[death](#)

[drowsiness](#)

Notes on poisoning:

Mice experimentally injected with berry extract (dry weight at 20-40 g/kg of body weight) experienced brief excitation, followed by drowsiness, abdominal spasms, and equilibrium and respiratory problems. Death sometimes followed in 10 min to several hours. A connection was made between saponin content and toxicity (Frohne and Pfander 1983).

References:

Frohne, D., Pfander, H. J. 1983. A colour atlas of poisonous plants. Wolfe Publishing Ltd., London, England. 291 pp.

[Another search?](#)

[Français](#) | [Contact Us](#) | [Help](#) | [Search](#) | [Canada site](#)

[Coming Events](#) | [About CBIF](#) | [Links](#) | [Reports and Publications](#) | [Home](#)

Date modified: 2003-02-06

[Important Notices](#)



Français	Contact us	Help	Search	Canada site
Coming events	About CBIF	Links	Reports and publications	Home

Canadian Biodiversity Information Facility



Notes on poisoning: *Lupinus argenteus*

[Introduction](#)[Interactive](#)[All poisonous plants by Botanical name](#)[All poisonous plants by Common name](#)[Important WWW Poisonous Plants sites](#)

General poisoning notes:

Silvery lupine (*Lupinus argenteus*) is a western range plant that has caused sickness and death in sheep in western North America. Ingestion of this plant by pregnant cattle can also cause teratogenic effects in calves (Cheeke and Schull 1985, Keeler 1989). See additional notes under silky lupine ([Lupinus sericeus](#)).



References:

Cheeke, P. R., Shull, L. R. 1985. Natural toxicants in feeds and poisonous plants. AVI Publishing Company, Inc., Westport, Conn., USA. 492 pp.

Keeler, R. F. 1989. Quinolizidine alkaloids in range and grain lupins. Pages 133-167 in Cheeke, P. R., ed. Toxicants of plant origin. Vol. I. Alkaloids. CRC Press, Inc., Boca Raton, Fla., USA. 335 pp.

Nomenclature:

Scientific Name: *Lupinus argenteus* Pursh

Vernacular name(s): silvery lupine

Scientific family name: *Leguminosae*

Vernacular family name: pea

Go to ITIS*^{ca} for more taxonomic information on: [Lupinus argenteus](#)

References:

Agriculture Quebec. 1975. Noms des maladies des plantes du Canada/ Names of plant diseases in Canada. , Quebec City, Que., Canada. 288 pp.

Alex, J. F., Cayouette, R., Mulligan, G. A. 1980. Common and botanical names of weeds in Canada/Noms populaire et scientifiques des plantes nuisibles du Canada. Revised. Agric. Can. Publ., Ottawa, Ont., Canada. 132 pp.

Bailey, L. H., Bailey, E. Z. 1976. Hortus third. Revised. MacMillan, New York, N.Y., USA. 1290 pp.

Scoggan, H. J. 1978, 1979. The flora of Canada. Nat. Mus. Nat. Sci. (Ottawa) Publ. Bot. 7(1)-7(4). 1711 pp.

Van Wijk, H. L. 1911. A dictionary of plant names. Martinus Nijhoff, The Hague, The Netherlands. 1444 pp.

Victorin, M. 1964. Flore Laurentienne. 2nd ed. Univ. Montreal, Montreal, Que., Canada. 952 pp.

Geographic Information

Alberta
British Columbia
Manitoba
Saskatchewan

References:

Bailey, L. H., Bailey, E. Z. 1976. Hortus third. Revised. MacMillan, New York, N.Y., USA. 1290 pp.

Boivin, B. 1966, 1967. Énumération des plantes du Canada. Provencheria 6. Nat. Can. (Que.) 93: 253-274; 371-437; 583-646; 989-1063. 94: 131-157; 471-528; 625-655.

Image or illustration

Lupinus argenteus:

Images: images.google.com

Notes on Poisonous plant parts:

The concentration of anagryne decreases in the leaves once the seeds begin to form, and then is greatest in the seeds. Total alkaloid content is greatest in the seeds. See notes under silky lupine (*Lupinus sericeus*) for additional information.

Toxic parts:

leaves
seeds

References:

Keeler, R. F. 1989. Quinolizidine alkaloids in range and grain lupins. Pages 133-167 in Cheeke, P. R., ed. Toxicants of plant origin. Vol. I. Alkaloids. CRC Press, Inc., Boca Raton, Fla., USA. 335 pp.

Notes on Toxic plant chemicals:

Two alkaloids, lupanine and sparteine, (both quinolizidine alkaloids), are probably involved in causing poisoning in sheep (Keeler 1989). This species also has been found to contain 3.34 g/kg of anagryne, exceeding the minimum level of 1.44 g/kg needed to cause crooked calf disease (Davis 1982, Davis and Stout 1986).

Toxic plant chemicals:

anagryne

lupanine

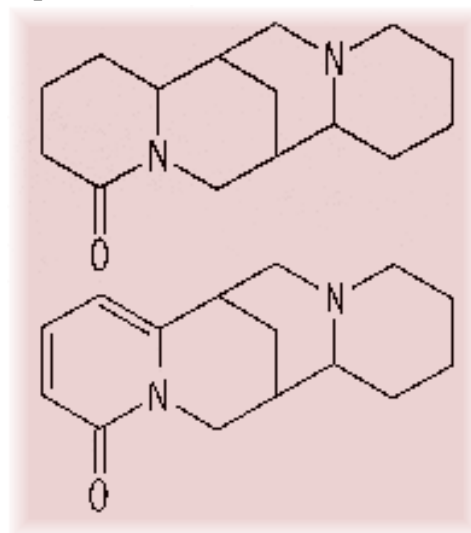

Chemical diagram(s) are courtesy of [Ruth McDiarmid](#), Biochemistry Technician, Kamloops Range Station, Agriculture and Agri-Food Canada, Kamloops, British Columbia, Canada.

References:

Davis, A. M., Stout, D. M. 1986. Anagryne in western American lupines. *J. Range Manage.*, 39: 29-30.

Davis, A. M. 1982. The occurrence of anagryne in a collection of western American lupines. *J. Range Manage.*, 35: 81-84.

Keeler, R. F. 1989. Quinolizidine alkaloids in range and grain lupins. Pages 133-167 in Cheeke, P. R., ed. Toxicants of plant origin. Vol. I. Alkaloids. CRC Press, Inc., Boca Raton, Fla.,

USA. 335 pp.

Animals/Human Poisoning:

Note: When an animal is listed without additional information, the literature (as of 1993) contained no detailed explanation.

Cattle

General symptoms of poisoning:

[arthrogryposis](#)

[palatoschisis](#)

[scoliosis](#)

[torticollis](#)

References:

Keeler, R. F. 1989. Quinolizidine alkaloids in range and grain lupins. Pages 133-167 in Cheeke, P. R., ed. Toxicants of plant origin. Vol. I. Alkaloids. CRC Press, Inc., Boca Raton, Fla., USA. 335 pp.

Sheep

General symptoms of poisoning:

[breathing, labored](#)

[coma](#)

[convulsions](#)

[death by asphyxiation](#)

[trembling](#)

Notes on poisoning:

Symptoms of ingestion include labored breathing, which may be accompanied by snoring, trembling, convulsions, coma, and death from respiratory paralysis (Keeler 1989). See additional notes under silky lupine [Lupinus sericeus](#)).

References:

Keeler, R. F. 1989. Quinolizidine alkaloids in range and grain lupins. Pages 133-167 in Cheeke, P. R., ed. Toxicants of plant origin. Vol. I. Alkaloids. CRC Press, Inc., Boca Raton, Fla., USA. 335 pp.

[Another search?](#)

[Français](#) | [Contact Us](#) | [Help](#) | [Search](#) | [Canada site](#)
[Coming Events](#) | [About CBIF](#) | [Links](#) | [Reports and Publications](#) |
[Home](#)

Date modified: 2003-02-06

[Important Notices](#)



Français	Contact us	Help	Search	Canada site
Coming events	About CBIF	Links	Reports and publications	Home

Canadian Biodiversity Information Facility



Notes on poisoning: *Lupinus burkei*

[Introduction](#)[Interactive](#)[All poisonous plants by Botanical name](#)[All poisonous plants by Common name](#)[Important WWW Poisonous Plants sites](#)

General poisoning notes:

Burkes" lupine (*Lupinus burkei*) is a native herb found in southern British Columbia. Chemical analysis of aboveground plant material has shown that this species can occasionally contain enough of the chemical anagyrene to cause teratogenic effects in calves if the plant is ingested maternally between day 40 and day 70 of gestation. The literature does not include cases of poisoning or teratogenic problems caused by this plant. See additional notes under silky lupine ([Lupinus sericeus](#)).

References:

Davis, A. M., Stout, D. M. 1986. Anagyrene in western American lupines. J. Range Manage., 39: 29-30.

Nomenclature:

Scientific Name: *Lupinus burkei* S. Wats.

Vernacular name(s): Burke's lupine

Scientific family name: *Leguminosae*

Vernacular family name: pea

Go to ITIS*^{ca} for more taxonomic information on: [Lupinus burkei](#)

References:

Agriculture Quebec. 1975. Noms des maladies des plantes du Canada/ Names of plant diseases in Canada. , Quebec City, Que., Canada. 288 pp.

Alex, J. F., Cayouette, R., Mulligan, G. A. 1980. Common and botanical names of weeds in Canada/Noms populaire et

scientifiques des plantes nuisibles du Canada. Revised. Agric. Can. Publ., Ottawa, Ont., Canada. 132 pp.

Bailey, L. H., Bailey, E. Z. 1976. Hortus third. Revised. MacMillan, New York, N.Y., USA. 1290 pp.

Scoggan, H. J. 1978, 1979. The flora of Canada. Nat. Mus. Nat. Sci. (Ottawa) Publ. Bot. 7(1)-7(4). 1711 pp.

Van Wijk, H. L. 1911. A dictionary of plant names. Martinus Nijhoff, The Hague, The Netherlands. 1444 pp.

Victorin, M. 1964. Flore Laurentienne. 2nd ed. Univ. Montreal, Montreal, Que., Canada. 952 pp.

Geographic Information

Alberta

British Columbia

References:

Bailey, L. H., Bailey, E. Z. 1976. Hortus third. Revised. MacMillan, New York, N.Y., USA. 1290 pp.

Boivin, B. 1966, 1967. Énumération des plantes du Canada. Provencheria 6. Nat. Can. (Que.) 93: 253-274; 371-437; 583-646; 989-1063. 94: 131-157; 471-528; 625-655.

Image or illustration

Lupinus burkei:

Images: images.google.com

Toxic parts:

leaves

stems

References:

Davis, A. M., Stout, D. M. 1986. Anagryne in western American lupines. J. Range Manage., 39: 29-30.

Notes on Toxic plant chemicals:

Burke's lupine contains anagryne, which has been measured in amounts exceeding the minimum (1.44 g/kg) required to cause teratogenic effects in calves (Davis and Stout 1986). See additional notes under silky lupine [Lupinus sericeus](#).

Toxic plant chemicals:

anagyrine

References:

Davis, A. M., Stout, D. M. 1986. Anagyrine in western American lupines. *J. Range Manage.*, 39: 29-30.

Animals/Human Poisoning:

Note: When an animal is listed without additional information, the literature (as of 1993) contained no detailed explanation.

Cattle

[Another search?](#)

[Français](#) | [Contact Us](#) | [Help](#) | [Search](#) | [Canada site](#)

[Coming Events](#) | [About CBIF](#) | [Links](#) | [Reports and Publications](#) | [Home](#)

Date modified: 2003-02-06

[Important Notices](#)



Français	Contact us	Help	Search	Canada site
Coming events	About CBIF	Links	Reports and publications	Home

Canadian Biodiversity Information Facility



Notes on poisoning: *Lupinus polyphyllus*

[Introduction](#)[Interactive](#)[All poisonous plants by Botanical name](#)[All poisonous plants by Common name](#)[Important WWW Poisonous Plants sites](#)

General poisoning notes:

Large-leaved lupine (*Lupinus polyphyllus*) is a native of British Columbia and has been introduced in eastern Canada. This species has been used in developing many of the cultivars of lupines grown in gardens. Davis and Stout (1986) measured quantities of anagryne that exceeded the minimum necessary to cause crooked calf disease (teratogenic deformities) in calves. The literature does not include any documented cases. Care should be taken to prevent pregnant cattle from feeding on this lupine from day 40 to day 70 of gestation. See additional notes under silky lupine (*Lupinus sericeus*).

References:

Davis, A. M., Stout, D. M. 1986. Anagryne in western American lupines. *J. Range Manage.*, 39: 29-30.

Keeler, R. F. 1989. Quinolizidine alkaloids in range and grain lupins. Pages 133-167 in Cheeke, P. R., ed. *Toxicants of plant origin*. Vol. I. Alkaloids. CRC Press, Inc., Boca Raton, Fla., USA. 335 pp.

Nomenclature:

Scientific Name: *Lupinus polyphyllus* Lindl.

Vernacular name(s): large-leaved lupine

Scientific family name: *Leguminosae*

Vernacular family name: pea

Go to ITIS^{*ca} for more taxonomic information on: [Lupinus polyphyllus](#)

References:

Agriculture Quebec. 1975. Noms des maladies des plantes du Canada/ Names of plant diseases in Canada. , Quebec City, Que., Canada. 288 pp.

Alex, J. F., Cayouette, R., Mulligan, G. A. 1980. Common and botanical names of weeds in Canada/Noms populaire et scientifiques des plantes nuisibles du Canada. Revised. Agric. Can. Publ., Ottawa, Ont., Canada. 132 pp.

Bailey, L. H., Bailey, E. Z. 1976. Hortus third. Revised. MacMillan, New York, N.Y., USA. 1290 pp.

Scoggan, H. J. 1978, 1979. The flora of Canada. Nat. Mus. Nat. Sci. (Ottawa) Publ. Bot. 7(1)-7(4). 1711 pp.

Van Wijk, H. L. 1911. A dictionary of plant names. Martinus Nijhoff, The Hague, The Netherlands. 1444 pp.

Victorin, M. 1964. Flore Laurentienne. 2nd ed. Univ. Montreal, Montreal, Que., Canada. 952 pp.

Geographic Information

British Columbia
New Brunswick
Nova Scotia
Ontario
Prince Edward Island
Quebec

References:

Bailey, L. H., Bailey, E. Z. 1976. Hortus third. Revised. MacMillan, New York, N.Y., USA. 1290 pp.

Boivin, B. 1966, 1967. Énumération des plantes du Canada. Provencheria 6. Nat. Can. (Que.) 93: 253-274; 371-437; 583-646; 989-1063. 94: 131-157; 471-528; 625-655.

Image or illustration

Lupinus polyphyllus:

Images: images.google.com

Toxic parts:

leaves
stems

References:

Davis, A. M., Stout, D. M. 1986. Anagryne in western American lupines. *J. Range Manage.*, 39: 29-30.

Notes on Toxic plant chemicals:

Anagryne, a quinolizidine alkaloid, has been measured in amounts exceeding the minimum 1.44 g/kg required to cause teratogenic effects. A measurement of 6.10 g/kg is reported by Davis and Stout (1986) in the aboveground portion of a plant.

Toxic plant chemicals:

anagryne

References:

Davis, A. M., Stout, D. M. 1986. Anagryne in western American lupines. *J. Range Manage.*, 39: 29-30.

Animals/Human Poisoning:

Note: When an animal is listed without additional information, the literature (as of 1993) contained no detailed explanation.

Cattle

General symptoms of poisoning:

[arthrogryposis](#)

[palatoschisis](#)

[scoliosis](#)

[torticollis](#)

References:

Keeler, R. F. 1989. Quinolizidine alkaloids in range and grain lupins. Pages 133-167 in Cheeke, P. R., ed. *Toxicants of plant origin. Vol. I. Alkaloids.* CRC Press, Inc., Boca Raton, Fla., USA. 335 pp.

[Another search?](#)

[Français](#) | [Contact Us](#) | [Help](#) | [Search](#) | [Canada site](#)

[Coming Events](#) | [About CBIF](#) | [Links](#) | [Reports and Publications](#) | [Home](#)

Date modified: 2003-02-06

[Important Notices](#)



Français	Contact us	Help	Search	Canada site
Coming events	About CBIF	Links	Reports and publications	Home

Canadian Biodiversity Information Facility



Notes on poisoning: *Lupinus pusillus*

[Introduction](#)[Interactive](#)[All poisonous plants by Botanical name](#)[All poisonous plants by Common name](#)[Important WWW Poisonous Plants sites](#)

General poisoning notes:

Small lupine (*Lupine pusillus*) is a native herb in the southern prairies. This species has been involved in poisoning of sheep (Fuller and McClintock 1986). See additional information under silky lupine [Lupinus sericeus](#)).



References:

Fuller, T. C., McClintock, E. 1986. Poisonous plants of California. Univ. California Press, Berkeley, Calif., USA. 432 pp.

Nomenclature:

Scientific Name: *Lupinus pusillus* Pursh

Vernacular name(s): small lupine

Scientific family name: *Leguminosae*

Vernacular family name: pea

Go to ITIS*^{ca} for more taxonomic information on: [Lupinus pusillus](#)

References:

Agriculture Quebec. 1975. Noms des maladies des plantes du Canada/ Names of plant diseases in Canada. , Quebec City, Que., Canada. 288 pp.

Alex, J. F., Cayouette, R., Mulligan, G. A. 1980. Common and botanical names of weeds in Canada/Noms populaire et scientifiques des plantes nuisibles du Canada. Revised. Agric. Can. Publ., Ottawa, Ont., Canada. 132 pp.

Bailey, L. H., Bailey, E. Z. 1976. Hortus third. Revised.

MacMillan, New York, N.Y., USA. 1290 pp.

Scoggan, H. J. 1978, 1979. The flora of Canada. Nat. Mus. Nat. Sci. (Ottawa) Publ. Bot. 7(1)-7(4). 1711 pp.

Van Wijk, H. L. 1911. A dictionary of plant names. Martinus Nijhoff, The Hague, The Netherlands. 1444 pp.

Victorin, M. 1964. Flore Laurentienne. 2nd ed. Univ. Montreal, Montreal, Que., Canada. 952 pp.

Geographic Information

Alberta

Saskatchewan

References:

Bailey, L. H., Bailey, E. Z. 1976. Hortus third. Revised. MacMillan, New York, N.Y., USA. 1290 pp.

Boivin, B. 1966, 1967. Énumération des plantes du Canada. Provencheria 6. Nat. Can. (Que.) 93: 253-274; 371-437; 583-646; 989-1063. 94: 131-157; 471-528; 625-655.

Image or illustration

Lupinus pusillus:

Images: images.google.com

Toxic parts:

leaves

seeds

References:

Kingsbury, J. M. 1964. Poisonous plants of the United States and Canada. Prentice-Hall Inc., Englewood Cliffs, N.J., USA. 626 pp.

Notes on Toxic plant chemicals:

Small lupine contains quinolizidine alkaloids, which have resulted in poisoning (Kingsbury 1964, Fuller and McClintock 1986).

Toxic plant chemicals:

unknown chemical

References:

Fuller, T. C., McClintock, E. 1986. Poisonous plants of California. Univ. California Press, Berkeley, Calif., USA. 432 pp.

Kingsbury, J. M. 1964. Poisonous plants of the United States and Canada. Prentice-Hall Inc., Englewood Cliffs, N.J., USA. 626 pp.

Animals/Human Poisoning:

Note: When an animal is listed without additional information, the literature (as of 1993) contained no detailed explanation.

Sheep

General symptoms of poisoning:

[breathing, labored](#)

[coma](#)

[convulsions](#)

[depression](#)

[muscle twitching](#)

References:

Fuller, T. C., McClintock, E. 1986. Poisonous plants of California. Univ. California Press, Berkeley, Calif., USA. 432 pp.

[Another search?](#)

[Français](#) | [Contact Us](#) | [Help](#) | [Search](#) | [Canada site](#)

[Coming Events](#) | [About CBIF](#) | [Links](#) | [Reports and Publications](#) | [Home](#)

Date modified: 2003-02-06

[Important Notices](#)



Français	Contact us	Help	Search	Canada site
Coming events	About CBIF	Links	Reports and publications	Home

Canadian Biodiversity Information Facility



Notes on poisoning: *Lupinus sericeus*

[Introduction](#)[Interactive](#)[All poisonous plants by Botanical name](#)[All poisonous plants by Common name](#)[Important WWW Poisonous Plants sites](#)

General poisoning notes:

Silky lupine (*Lupinus sericeus*) is a native herb of western Canada. This lupine has caused poisoning and death in cattle, goats, horses, and sheep. Sheep eat the plants more readily than do other animals and are therefore more commonly poisoned. Cattle also suffer from crooked calf disease, a teratogenic syndrome caused by maternal ingestion of certain lupines between day 40 and day 70 of gestation. The calves can suffer from arthrogryposis, scoliosis, and other deformities. Humans are also at risk from lupine toxins. In one case in California, a child was born with limb deformities. The family raised milk goats that had also given birth to kids with deformed limbs, and a dog gave birth to deformed pups. All had ingested the goat's milk during pregnancy. Anagyrine in a local lupine species was believed to cause the problem. Tests showed that lactating goats that ingest lupine seeds pass anagyrine in the milk. Edible lupine seeds are being marketed in health food stores. In Edmonton (Smith 1987), a woman suffered mild dizziness and incoordination after ingesting the seeds. She did not follow specific instructions to soak and boil the seeds in several changes of water, which is necessary to remove the toxins.

References:

Keeler, R. F. 1989. Quinolizidine alkaloids in range and grain lupins. Pages 133-167 in Cheeke, P. R., ed. Toxicants of plant origin. Vol. I. Alkaloids. CRC Press, Inc., Boca Raton, Fla., USA. 335 pp.

Kingsbury, J. M. 1964. Poisonous plants of the United States and Canada. Prentice-Hall Inc., Englewood Cliffs, N.J., USA. 626 pp.

Nomenclature:

Scientific Name: *Lupinus sericeus* Pursh

Vernacular name(s): silky lupine

Scientific family name: *Leguminosae*

Vernacular family name: pea

Go to ITIS^{*ca} for more taxonomic information on: [Lupinus sericeus](#)

References:

Agriculture Quebec. 1975. Noms des maladies des plantes du Canada/ Names of plant diseases in Canada. , Quebec City, Que., Canada. 288 pp.

Alex, J. F., Cayouette, R., Mulligan, G. A. 1980. Common and botanical names of weeds in Canada/Noms populaire et scientifiques des plantes nuisibles du Canada. Revised. Agric. Can. Publ., Ottawa, Ont., Canada. 132 pp.

Bailey, L. H., Bailey, E. Z. 1976. Hortus third. Revised. MacMillan, New York, N.Y., USA. 1290 pp.

Scoggan, H. J. 1978, 1979. The flora of Canada. Nat. Mus. Nat. Sci. (Ottawa) Publ. Bot. 7(1)-7(4). 1711 pp.

Van Wijk, H. L. 1911. A dictionary of plant names. Martinus Nijhoff, The Hague, The Netherlands. 1444 pp.

Victorin, M. 1964. Flore Laurentienne. 2nd ed. Univ. Montreal, Montreal, Que., Canada. 952 pp.

Geographic Information

Alberta
British Columbia
Yukon Territory

References:

Bailey, L. H., Bailey, E. Z. 1976. Hortus third. Revised. MacMillan, New York, N.Y., USA. 1290 pp.

Boivin, B. 1966, 1967. Énumération des plantes du Canada. Provencheria 6. Nat. Can. (Que.) 93: 253-274; 371-437; 583-646; 989-1063. 94: 131-157; 471-528; 625-655.

Image or illustration

Lupinus sericeus:

Images: images.google.com

Notes on Poisonous plant parts:

The teratogenic alkaloid anagyrine is highest in the seeds, pods, and young leaves. The quinolizidine alkaloids implicated in lupine poisoning and death are found mostly in the seeds and pods. Large quantities of the plant material must be ingested in a short time. The alkaloids remain after drying, so that hay containing sufficient quantities of lupine can be toxic (Kingsbury 1964, Keeler 1989).

Toxic parts:

leaves
mature fruit
seeds
stems

References:

Davis, A. M., Stout, D. M. 1986. Anagyrine in western American lupines. *J. Range Manage.*, 39: 29-30.

Keeler, R. F. 1989. Quinolizidine alkaloids in range and grain lupins. Pages 133-167 in Cheeke, P. R., ed. *Toxicants of plant origin. Vol. I. Alkaloids.* CRC Press, Inc., Boca Raton, Fla., USA. 335 pp.

Kingsbury, J. M. 1964. *Poisonous plants of the United States and Canada.* Prentice-Hall Inc., Englewood Cliffs, N.J., USA. 626 pp.

Notes on Toxic plant chemicals:

Silky lupine contains two major quinolizidine alkaloids, lupanine and sparteine. These alkaloids and their derivatives cause poisoning and death in livestock. This species also contains a teratogenic chemical, anagyrine, which causes birth deformities in calves after maternal ingestion of the plants between day 40 and day 70. Amounts of up to 6.84 g/kg have been measured, which exceeds the minimum of 1.44 g/kg required to cause crooked calf disease (Davis and Stout 1986, Keeler 1989). The LD-50 of lupanine by oral ingestion in rats is 1464 mg/kg. This alkaloid is rapidly cleared from the body (Pettersen et al. 1987).

Toxic plant chemicals:

anagyrine
lupanine

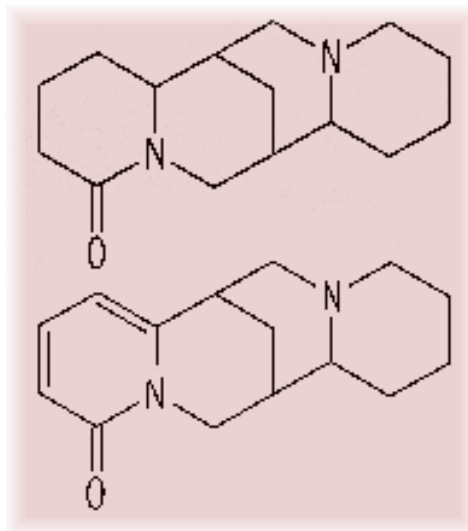

sparteine

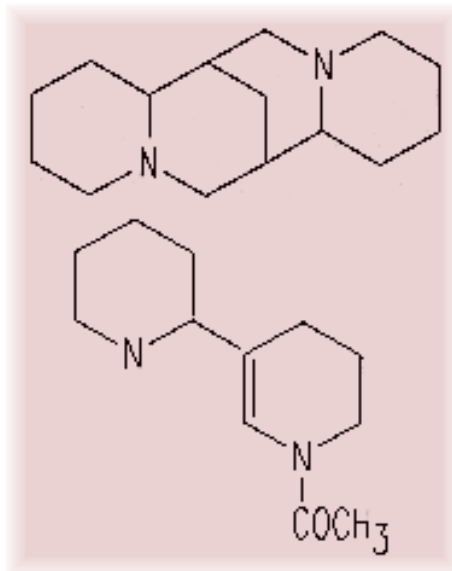

Chemical diagram(s) are courtesy of [Ruth McDiarmid](#), Biochemistry Technician, Kamloops Range Station, Agriculture and Agri-Food Canada, Kamloops, British Columbia, Canada.

References:

Davis, A. M., Stout, D. M. 1986. Anagryne in western American lupines. *J. Range Manage.*, 39: 29-30.

Keeler, R. F. 1989. Quinolizidine alkaloids in range and grain lupins. Pages 133-167 in Cheeke, P. R., ed. *Toxicants of plant origin. Vol. I. Alkaloids.* CRC Press, Inc., Boca Raton, Fla., USA. 335 pp.

Petterson, D. S., Ellis, Z. L., Harris, D. J., Spadek, Z. E. 1987. Acute toxicity of the major alkaloids of cultivated *Lupinus angustifolius* seed to rats. *J. Appl. Toxicol.*, 7: 51-53.

Animals/Human Poisoning:

Note: When an animal is listed without additional information, the literature (as of 1993) contained no detailed explanation.

Cattle

General symptoms of poisoning:

[arthrogryposis](#)

[breathing, labored](#)

[convulsions](#)

[palatoschisis](#)

[scoliosis](#)

[torticollis](#)

[trembling](#)

Notes on poisoning:

Cattle do not eat lupines as readily as sheep and therefore seldom ingest lethal quantities. Symptoms are similar to those of sheep (Kingsbury 1964).

References:

Keeler, R. F. 1989. Quinolizidine alkaloids in range and grain lupins. Pages 133-167 in Cheeke, P. R., ed. Toxicants of plant origin. Vol. I. Alkaloids. CRC Press, Inc., Boca Raton, Fla., USA. 335 pp.

Kingsbury, J. M. 1964. Poisonous plants of the United States and Canada. Prentice-Hall Inc., Englewood Cliffs, N.J., USA. 626 pp.

Horses

General symptoms of poisoning:

[breathing, labored](#)

[convulsions](#)

[trembling](#)

Notes on poisoning:

Horses do not ingest lupines as readily as do sheep. Toxic symptoms therefore seldom appear in horses. Symptoms are similar to those seen in sheep (Kingsbury 1964).

References:

Kingsbury, J. M. 1964. Poisonous plants of the United States and

Humans

General symptoms of poisoning:

[dizziness](#)

[incoordination](#)

Notes on poisoning:

Smith (1987) reports the case of a woman who complained of dizziness and incoordination after ingesting edible lupine seeds purchased in Edmonton. The women had not followed the cooking instructions, which required soaking and boiling the seeds in several changes of water. The toxic alkaloids are removed through several stages of cooking; the process must be continued until no bitterness is left. In lupine seeds a lethal dose of lupanine has been determined to be about 100 mg/kg. If not properly cooked, 10 g of seeds may liberate more than 100 mg of lupanine. Keeler (1989) discusses a possible link between ingesting goat's milk and the occurrence of birth deformities in a baby. The goats may have been eating a lupine species that contained the teratogenic chemical anagyrene, which was passed through the woman when she drank goat's milk during pregnancy.

References:

Keeler, R. F. 1989. Quinolizidine alkaloids in range and grain lupins. Pages 133-167 in Cheeke, P. R., ed. Toxicants of plant origin. Vol. I. Alkaloids. CRC Press, Inc., Boca Raton, Fla., USA. 335 pp.

Sheep

General symptoms of poisoning:

[breathing, labored](#)

[coma](#)

[convulsions](#)

[death by asphyxiation](#)

[depression](#)

[dyspnea](#)

Notes on poisoning:

Symptoms of lupine ingestion in sheep include labored breathing, depression, coma (often with snoring), and death from asphyxiation. Tremors and convulsions may occur. The animal may butt other sheep or stand leaning against an object. Teeth

grinding and frothing have been observed. Sheep consume lupine more readily than do other livestock and are therefore the major species susceptible to lupine toxicity. Ingesting seeds equal to 0.25-0.5% of body weight can cause poisoning (Keeler 1964).

References:

Kingsbury, J. M. 1964. Poisonous plants of the United States and Canada. Prentice-Hall Inc., Englewood Cliffs, N.J., USA. 626 pp.

[Another search?](#)

[Français](#) | [Contact Us](#) | [Help](#) | [Search](#) | [Canada site](#)

[Coming Events](#) | [About CBIF](#) | [Links](#) | [Reports and Publications](#) | [Home](#)

Date modified: 2003-02-06

[Important Notices](#)



Français	Contact us	Help	Search	Canada site
Coming events	About CBIF	Links	Reports and publications	Home

Canadian Biodiversity Information Facility



Notes on poisoning: *Maclura pomifera*

[Introduction](#)[Interactive](#)[All poisonous plants by Botanical name](#)[All poisonous plants by Common name](#)[Important WWW Poisonous Plants sites](#)

General poisoning notes:

Osage-orange (*Maclura pomifera*) is occasionally planted as an ornamental shrub in the warmest parts of Canada. The milky sap causes dermatitis in sensitive individuals. It is unclear whether the sap is an irritant, is sensitizing, or both (Muenscher 1975, Mitchell and Rook 1979).



References:

Muenscher, W. C. 1975. Poisonous plants of the United States. Revised. Collier Books, New York, N.Y., USA. 277 pp.

Nomenclature:

Scientific Name: *Maclura pomifera* (Raf.) C. K. Schneid.

Vernacular name(s): Osage-orange

Scientific family name: *Moraceae*

Vernacular family name: mulberry

Go to ITIS^{*ca} for more taxonomic information on: [Maclura pomifera](#)

References:

Agriculture Quebec. 1975. Noms des maladies des plantes du Canada/ Names of plant diseases in Canada. , Quebec City, Que., Canada. 288 pp.

Alex, J. F., Cayouette, R., Mulligan, G. A. 1980. Common and botanical names of weeds in Canada/Noms populaire et scientifiques des plantes nuisibles du Canada. Revised. Agric. Can. Publ., Ottawa, Ont., Canada. 132 pp.

Bailey, L. H., Bailey, E. Z. 1976. Hortus third. Revised. MacMillan, New York, N.Y., USA. 1290 pp.

Scoggan, H. J. 1978, 1979. The flora of Canada. Nat. Mus. Nat. Sci. (Ottawa) Publ. Bot. 7(1)-7(4). 1711 pp.

Van Wijk, H. L. 1911. A dictionary of plant names. Martinus Nijhoff, The Hague, The Netherlands. 1444 pp.

Victorin, M. 1964. Flore Laurentienne. 2nd ed. Univ. Montreal, Montreal, Que., Canada. 952 pp.

Geographic Information

Plant or plant parts used in or around the home.

References:

Bailey, L. H., Bailey, E. Z. 1976. Hortus third. Revised. MacMillan, New York, N.Y., USA. 1290 pp.

Boivin, B. 1966, 1967. Énumération des plantes du Canada. Provencheria 6. Nat. Can. (Que.) 93: 253-274; 371-437; 583-646; 989-1063. 94: 131-157; 471-528; 625-655.

Image or illustration

Maclura pomifera:

Images: images.google.com

Notes on Poisonous plant parts:

A milky juice is contained in the leaves, stems, and large fruit of this plant. Some humans are sensitive to the plant juice (Muenscher 1975).

Toxic parts:

plant juices

References:

Muenscher, W. C. 1975. Poisonous plants of the United States. Revised. Collier Books, New York, N.Y., USA. 277 pp.

Toxic plant chemicals:

unknown chemical

References:

Muenschler, W. C. 1975. Poisonous plants of the United States. Revised. Collier Books, New York, N.Y., USA. 277 pp.

Animals/Human Poisoning:

Note: When an animal is listed without additional information, the literature (as of 1993) contained no detailed explanation.

Humans

[Another search?](#)

[Français](#) | [Contact Us](#) | [Help](#) | [Search](#) | [Canada site](#)

[Coming Events](#) | [About CBIF](#) | [Links](#) | [Reports and Publications](#) | [Home](#)

Date modified: 2003-02-06

[Important Notices](#)



Français	Contact us	Help	Search	Canada site
Coming events	About CBIF	Links	Reports and publications	Home

Canadian Biodiversity Information Facility



Notes on poisoning: *Mangifera indica*

[Introduction](#)[Interactive](#)[All poisonous plants by Botanical name](#)[All poisonous plants by Common name](#)[Important WWW Poisonous Plants sites](#)

General poisoning notes:

Mango (*Mangifera indica*) is a tropical fruit that is seasonally available in Canadian food stores. The skin of the fruit and the petiole, by which the fruit is attached to the stem, contain oleoresins. These chemicals are cross-reactive to the catechols contained in poison-ivy plants and in other members of *Rhus* species that cause dermatitis. Humans who are sensitized and develop dermatitis from these plants should be cautious about touching the skin of mangoes. The shells of cashews (*Anacardium occidentale*) are also cross-reactive with catechols of *Rhus* species. However, cashews shells are removed before the nuts are sold in Canada (Kingsbury 1964, Geller 1989).

References:

Geller, M. 1989. Poison ivy, mangoes, cashews, and dermatitis. *Ann. Intern. Med.*, 110: 1036-1037.

Kingsbury, J. M. 1964. *Poisonous plants of the United States and Canada*. Prentice-Hall Inc., Englewood Cliffs, N.J., USA. 626 pp.

Nomenclature:

Scientific Name: *Mangifera indica* L.

Vernacular name(s): mango

Scientific family name: *Anacardiaceae*

Vernacular family name: cashew

Go to ITIS^{*ca} for more taxonomic information on: [Mangifera indica](#)

References:

Agriculture Quebec. 1975. Noms des maladies des plantes du Canada/ Names of plant diseases in Canada. , Quebec City, Que., Canada. 288 pp.

Alex, J. F., Cayouette, R., Mulligan, G. A. 1980. Common and botanical names of weeds in Canada/Noms populaire et scientifiques des plantes nuisibles du Canada. Revised. Agric. Can. Publ., Ottawa, Ont., Canada. 132 pp.

Bailey, L. H., Bailey, E. Z. 1976. Hortus third. Revised. MacMillan, New York, N.Y., USA. 1290 pp.

Scoggan, H. J. 1978, 1979. The flora of Canada. Nat. Mus. Nat. Sci. (Ottawa) Publ. Bot. 7(1)-7(4). 1711 pp.

Van Wijk, H. L. 1911. A dictionary of plant names. Martinus Nijhoff, The Hague, The Netherlands. 1444 pp.

Victorin, M. 1964. Flore Laurentienne. 2nd ed. Univ. Montreal, Montreal, Que., Canada. 952 pp.

Geographic Information

Plant or plant parts used in or around the home.

References:

Bailey, L. H., Bailey, E. Z. 1976. Hortus third. Revised. MacMillan, New York, N.Y., USA. 1290 pp.

Boivin, B. 1966, 1967. Énumération des plantes du Canada. Provencheria 6. Nat. Can. (Que.) 93: 253-274; 371-437; 583-646; 989-1063. 94: 131-157; 471-528; 625-655.

Image or illustration

Mangifera indica:

Images: images.google.com

Notes on Poisonous plant parts:

The skin of the fruit and the petiole, by which the fruit is attached to the stem, contain oleoresins (Geller 1989).

Toxic parts:

skin of fruit

References:

Geller, M. 1989. Poison ivy, mangoes, cashews, and dermatitis. *Ann. Intern. Med.*, 110: 1036-1037.

Notes on Toxic plant chemicals:

The oleoresins of the fruit peel (skin) of mango are cross-reactive with the catechols of poison-ivy, [Rhus spp.](#) (Geller 1989).

Toxic plant chemicals:

oleoresin

References:

Geller, M. 1989. Poison ivy, mangoes, cashews, and dermatitis. *Ann. Intern. Med.*, 110: 1036-1037.

Animals/Human Poisoning:

Note: When an animal is listed without additional information, the literature (as of 1993) contained no detailed explanation.

Humans

General symptoms of poisoning:

[blisters, weeping](#)

[erythema](#)

References:

Geller, M. 1989. Poison ivy, mangoes, cashews, and dermatitis. *Ann. Intern. Med.*, 110: 1036-1037.

[Another search?](#)

[Français](#) | [Contact Us](#) | [Help](#) | [Search](#) | [Canada site](#)

[Coming Events](#) | [About CBIF](#) | [Links](#) | [Reports and Publications](#) |

[Home](#)

Date modified: 2003-02-06

[Important Notices](#)



Français	Contact us	Help	Search	Canada site
Coming events	About CBIF	Links	Reports and publications	Home

Canadian Biodiversity Information Facility



Notes on poisoning: *Medicago sativa*

[Introduction](#)[Interactive](#)[All poisonous plants by
Botanical name](#)[All poisonous plants by
Common name](#)[Important WWW Poisonous
Plants sites](#)

General poisoning notes:

Alfalfa (*Medicago sativa*) is an important forage and silage crop in Canada. However, under some circumstances, alfalfa can cause a variety of different toxic problems. Ingesting rapidly growing alfalfa at the vegetative to mid-bud stage can cause bloat in cattle and sheep (Hall and Majak 1989). Alfalfa has also caused photosensitization in cattle with white skin (MacDonald 1954). Alfalfa contains phytoestrogens which cause infertility in animals, including cattle and sheep. These compounds are also contained in some alfalfa pills that are found in health food stores, and these may cause problems in some cases (Cheeke and Schull 1985). Alfalfa also contains saponins that can interfere with the growth of poultry and thus reduce egg-laying (Fuller and McClintock 1986, Oakenfull and Sidhu 1989). Low saponin cultivars have been developed.

References:

- Adams, N. R. 1989. Phytoestrogens. Pages 23-51 in Cheeke, P. R., ed. Toxicants of plant origin. Vol. IV. Phenolics. CRC Press, Inc., Boca Raton, Fla., USA. 232 pp.
- Cheeke, P. R., Shull, L. R. 1985. Natural toxicants in feeds and poisonous plants. AVI Publishing Company, Inc., Westport, Conn., USA. 492 pp.
- Fuller, T. C., McClintock, E. 1986. Poisonous plants of California. Univ. California Press, Berkeley, Calif., USA. 432 pp.
- Hall, J. W., Majak, W. 1989. Plant and animal factors in legume bloat. Pages 93-106 in Cheeke, P. R., ed. Toxicants of plant origin. Vol. III. Proteins and amino acids. CRC Press, Inc., Boca Raton, Fla., USA. 271 pp.
- MacDonald, H. E. 1954. Photosensitization. Can. J. Comp. Med., 18: 228.
- Oakenfull, D., Sidhu, G. S. 1989. Saponins. Pages 97-143 in Cheeke, P. R., ed. Toxicants of plant origin. Vol. II. Glycosides. CRC Press, Inc.,

Boca Raton, Fla., USA. 277 pp.

Nomenclature:

Scientific Name: *Medicago sativa* L.

Vernacular name(s): alfalfa

Scientific family name: *Leguminosae*

Vernacular family name: pea

Go to ITIS*^{ca} for more taxonomic information on: [Medicago sativa](#)

References:

Agriculture Quebec. 1975. Noms des maladies des plantes du Canada/
Names of plant diseases in Canada. , Quebec City, Que., Canada. 288 pp.

Alex, J. F., Cayouette, R., Mulligan, G. A. 1980. Common and botanical
names of weeds in Canada/Noms populaire et scientifiques des plantes
nuisibles du Canada. Revised. Agric. Can. Publ., Ottawa, Ont., Canada.
132 pp.

Bailey, L. H., Bailey, E. Z. 1976. Hortus third. Revised. MacMillan, New
York, N.Y., USA. 1290 pp.

Scoggan, H. J. 1978, 1979. The flora of Canada. Nat. Mus. Nat. Sci.
(Ottawa) Publ. Bot. 7(1)-7(4). 1711 pp.

Van Wijk, H. L. 1911. A dictionary of plant names. Martinus Nijhoff,
The Hague, The Netherlands. 1444 pp.

Victorin, M. 1964. Flore Laurentienne. 2nd ed. Univ. Montreal,
Montreal, Que., Canada. 952 pp.

Geographic Information

Alberta
British Columbia
Manitoba
New Brunswick
Northwest Territories
Nova Scotia
Ontario
Prince Edward Island
Quebec
Saskatchewan

References:

Bailey, L. H., Bailey, E. Z. 1976. Hortus third. Revised. MacMillan, New

York, N.Y., USA. 1290 pp.

Boivin, B. 1966, 1967. Énumération des plantes du Canada. Provencheria 6. Nat. Can. (Que.) 93: 253-274; 371-437; 583-646; 989-1063. 94: 131-157; 471-528; 625-655.

Image or illustration

Medicago sativa:

Images: images.google.com

Toxic parts:

leaves

stems

References:

Fuller, T. C., McClintock, E. 1986. Poisonous plants of California. Univ. California Press, Berkeley, Calif., USA. 432 pp.

Notes on Toxic plant chemicals:

Alfalfa contains two phytoestrogenic compounds, coumestrol and coumestan. These compounds can cause fertility problems in sheep and cattle. Alfalfa also contains bloat-causing proteins. Saponins, such as medicagenic acid, can cause growth reduction in poultry (Adams 1989, Hall and Majak 1989, Oakenfull and Sidhu 1989).

Toxic plant chemicals:

coumestan

coumestrol

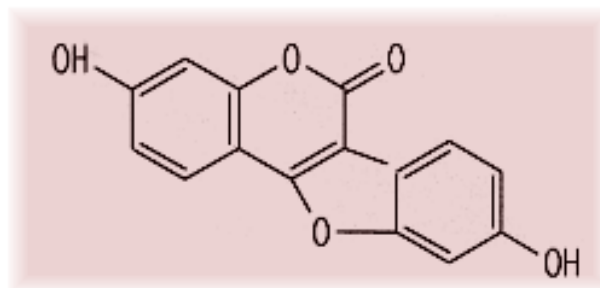

medicagenic acid

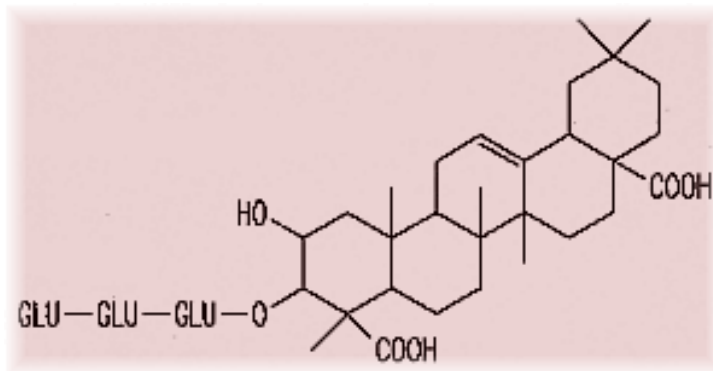

Chemical diagram(s) are courtesy of [Ruth McDiarmid](#), Biochemistry Technician, Kamloops Range Station, Agriculture and Agri-Food Canada, Kamloops, British Columbia, Canada.

References:

Adams, N. R. 1989. Phytoestrogens. Pages 23-51 in Cheeke, P. R., ed. Toxicants of plant origin. Vol. IV. Phenolics. CRC Press, Inc., Boca Raton, Fla., USA. 232 pp.

Fuller, T. C., McClintock, E. 1986. Poisonous plants of California. Univ. California Press, Berkeley, Calif., USA. 432 pp.

Oakenfull, D., Sidhu, G. S. 1989. Saponins. Pages 97-143 in Cheeke, P. R., ed. Toxicants of plant origin. Vol. II. Glycosides. CRC Press, Inc., Boca Raton, Fla., USA. 277 pp.

Animals/Human Poisoning:

Note: When an animal is listed without additional information, the literature (as of 1993) contained no detailed explanation.

Cattle

General symptoms of poisoning:

[bloat](#)

[infertility](#)

Notes on poisoning:

Cattle are especially susceptible to bloat after ingesting rapidly growing alfalfa in the vegetative to mid-bud stage of growth. The formation of stable foam bubbles is recognized as being affected by the concentration of cytoplasmic proteins, which is in turn affected by rumen pH, and the colloidal suspension of chloroplast particles from the plant; the stability is controlled by ion concentration (Hall and Majak 1989). Alfalfa also contains phytoestrogens, which have caused infertility problems in dairy cattle because of cystic ovaries and irregular estrous cycles. Precocious development of mammary glands also occurs, as well as genital

formation in heifers. The coumestan chemicals suppress estrous and inhibit ovulation (Cheeke and Schull 1985, Adams 1989).

References:

Adams, N. R. 1989. Phytoestrogens. Pages 23-51 in Cheeke, P. R., ed. Toxicants of plant origin. Vol. IV. Phenolics. CRC Press, Inc., Boca Raton, Fla., USA. 232 pp.

Cheeke, P. R., Shull, L. R. 1985. Natural toxicants in feeds and poisonous plants. AVI Publishing Company, Inc., Westport, Conn., USA. 492 pp.

Fuller, T. C., McClintock, E. 1986. Poisonous plants of California. Univ. California Press, Berkeley, Calif., USA. 432 pp.

Hall, J. W., Majak, W. 1989. Plant and animal factors in legume bloat. Pages 93-106 in Cheeke, P. R., ed. Toxicants of plant origin. Vol. III. Proteins and amino acids. CRC Press, Inc., Boca Raton, Fla., USA. 271 pp.

Chickens

General symptoms of poisoning:

[weight gain, reduced](#)

References:

Oakenfull, D., Sidhu, G. S. 1989. Saponins. Pages 97-143 in Cheeke, P. R., ed. Toxicants of plant origin. Vol. II. Glycosides. CRC Press, Inc., Boca Raton, Fla., USA. 277 pp.

Humans

General symptoms of poisoning:

[infertility](#)

Notes on poisoning:

Alfalfa tablets are available in health food stores as a dietary supplement for humans. The benefits of the tablets are not clear. Measurements of the phytoestrogen content of some commercial brands have ranged from 20 to 190 ppm. This level of intake, in conjunction with other sources of estrogen (such as birth control pills and estrogen replacement therapy), may be potentially harmful (Cheeke and Schull 1985).

References:

Cheeke, P. R., Shull, L. R. 1985. Natural toxicants in feeds and poisonous plants. AVI Publishing Company, Inc., Westport, Conn., USA.

492 pp.

Sheep

General symptoms of poisoning:

[bloat](#)

[erythema](#)

[infertility](#)

[skin, peeling of](#)

References:

Cheeke, P. R., Shull, L. R. 1985. Natural toxicants in feeds and poisonous plants. AVI Publishing Company, Inc., Westport, Conn., USA. 492 pp.

MacDonald, H. E. 1954. Photosensitization. Can. J. Comp. Med., 18: 228.

[Another search?](#)

[Français](#) | [Contact Us](#) | [Help](#) | [Search](#) | [Canada site](#)

[Coming Events](#) | [About CBIF](#) | [Links](#) | [Reports and Publications](#) | [Home](#)

Date modified: 2003-02-06

[Important Notices](#)



Français	Contact us	Help	Search	Canada site
Coming events	About CBIF	Links	Reports and publications	Home



Notes on poisoning: *Melilotus alba*

[Introduction](#)

[Interactive](#)

[All poisonous plants by Botanical name](#)

[All poisonous plants by Common name](#)

[Important WWW Poisonous Plants sites](#)



General poisoning notes:

White sweet-clover (*Melilotus alba*) is a cultivated and naturalized plant that occurs as a weed across most of Canada. This plant contains a glycoside with a coumarin fraction. When sweet-clover is harvested for feed, the succulent stems usually mold before drying. The molds metabolize the glycoside into dicoumarol, which interrupts vitamin K activation of prothrombin, necessary in blood clotting. Levels of dicoumarol at more than 10 ppm are suspected of possible poisoning. Dicoumarol levels are usually higher in small and round bales than in stacks. Cattle, horses, and sheep have been poisoned. However, cattle are almost exclusively poisoned by sweet-clover (Blakely 1985, Cheeke and Schull 1985).

References:

- Alstad, A. D., Casper, H. H., Johnson, L. J. 1985. Vitamin K treatment of sweet clover poisoning in calves. J. Am. Vet. Med. Assoc., 187: 729-731.
- Blakley, B. R. 1985. Moldy sweet clover (dicoumarol) poisoning in Saskatchewan cattle. Can. Vet. J., 26: 357-360.
- McDonald, G. K. 1980. Moldy sweetclover poisoning in a horse. Can. Vet. J., 21: 250-251.
- Radostits, O. M., Searcy, G. P., Mitchall, K. G. 1980. Moldy sweetclover poisoning in cattle. Can. Vet. J., 21: 155-158.
- Turkington, R. A., Cavers, P. B., Rempel, E. 1978. The biology of Canadian weeds. 29. *Melilotus alba* Desr. and *M. officinalis* (L.) Lam. Can. J. Plant Sci., 58: 523-537.

Nomenclature:

Scientific Name: *Melilotus alba* Desr.

Vernacular name(s): white sweet-clover

Scientific family name: *Leguminosae*

Vernacular family name: pea

Go to ITIS^{*ca} for more taxonomic information on: [Melilotus alba](#)

References:

Agriculture Quebec. 1975. Noms des maladies des plantes du Canada/ Names of plant diseases in Canada. , Quebec City, Que., Canada. 288 pp.

Alex, J. F., Cayouette, R., Mulligan, G. A. 1980. Common and botanical names of weeds in Canada/Noms populaire et scientifiques des plantes nuisibles du Canada. Revised. Agric. Can. Publ., Ottawa, Ont., Canada. 132 pp.

Bailey, L. H., Bailey, E. Z. 1976. Hortus third. Revised. MacMillan, New York, N.Y., USA. 1290 pp.

Scoggan, H. J. 1978, 1979. The flora of Canada. Nat. Mus. Nat. Sci. (Ottawa) Publ. Bot. 7(1)-7(4). 1711 pp.

Van Wijk, H. L. 1911. A dictionary of plant names. Martinus Nijhoff, The Hague, The Netherlands. 1444 pp.

Victorin, M. 1964. Flore Laurentienne. 2nd ed. Univ. Montreal, Montreal, Que., Canada. 952 pp.

Geographic Information

Alberta
British Columbia
Labrador
Manitoba
New Brunswick
Northwest Territories
Nova Scotia
Ontario
Prince Edward Island
Quebec
Saskatchewan
Yukon Territory

References:

Bailey, L. H., Bailey, E. Z. 1976. Hortus third. Revised. MacMillan, New York, N.Y., USA. 1290 pp.

Boivin, B. 1966, 1967. Énumération des plantes du Canada. Provencheria 6. Nat. Can. (Que.) 93: 253-274; 371-437; 583-646;

Image or illustration

Melilotus alba:

Images: images.google.com

Notes on Poisonous plant parts:

Moldy sweet-clover is produced through insufficient drying of bales and silage. Dicoumarol production by molds is not likely to occur if animals ingest living plants.

Toxic parts:

leaves
stems

References:

Cheeke, P. R., Shull, L. R. 1985. Natural toxicants in feeds and poisonous plants. AVI Publishing Company, Inc., Westport, Conn., USA. 492 pp.

Notes on Toxic plant chemicals:

A glycoside, melilotoside, contains an ether and coumarin. The coumarin is metabolized by various molds (e.g., *Penicillium* spp.) into dicoumarol. Dicoumarol inhibits vitamin K, which causes hemorrhaging. Sweet-clover has a succulent stem, which makes molding common after cutting. Round bales have been found to have significantly higher dicoumarol (mean of 22.9 +/- 3.10 mg/kg) than stacks of silage (means 1.8 of +/- 6.3 and 0.6 +/- 2.1 mg/kg). The outer parts of round bales had a higher concentration of dicoumarol (Benson et al. 1981, Cheeke and Schull 1985).

Toxic plant chemicals:

dicoumarol

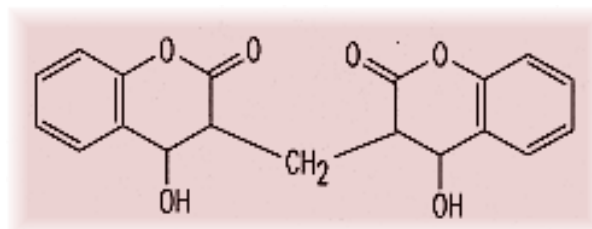

melilotoside

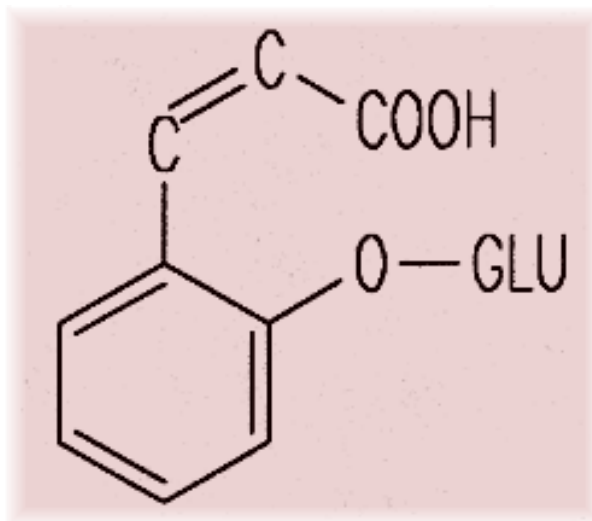

Chemical diagram(s) are courtesy of [Ruth McDiarmid](#), Biochemistry Technician, Kamloops Range Station, Agriculture and Agri-Food Canada, Kamloops, British Columbia, Canada.

References:

Benson, M. E., Casper, H. H., Johnson, L. J. 1981. Occurrence and range of dicumarol concentrations in sweet clover. *Am. J. Vet. Res.*, 42: 2014-2015.

Cheeke, P. R., Shull, L. R. 1985. Natural toxicants in feeds and poisonous plants. AVI Publishing Company, Inc., Westport, Conn., USA. 492 pp.

Animals/Human Poisoning:

Note: When an animal is listed without additional information, the literature (as of 1993) contained no detailed explanation.

Cattle

General symptoms of poisoning:

[abortion](#)

[anemia](#)

[heart rate, elevated](#)

[hemorrhage](#)

Notes on poisoning:

Symptoms of moldy sweet-clover poisoning may appear without any obvious cause. Trauma and surgery are often followed by severe hemorrhage and death. Hemorrhage may result after uncomplicated parturition. Newborn calves may die during the first few days of life if their dams have been fed on toxic feed. In Saskatchewan 286 animals from 56 herds were affected in 1983. The mortality rate was

12.1%. Aborted fetuses and calves less than 2 weeks old were affected most often. Poisoning usually occurred between January to April. Sweet-clover fed as bales was more of a problem than when fed as silage (Radostits et al. 1980, Blakely 1985). Treatment using vitamin K1 was effective at dosages of 1.1-3.3 mg/kg of body weight after poisoning by sweet-clover containing dicoumarol at a minimum of 90 ppm. Vitamin K3 was ineffective as treatment (Alstad et al. 1985).

References:

Alstad, A. D., Casper, H. H., Johnson, L. J. 1985. Vitamin K treatment of sweet clover poisoning in calves. J. Am. Vet. Med. Assoc., 187: 729-731.

Blakley, B. R. 1985. Moldy sweet clover (dicoumarol) poisoning in Saskatchewan cattle. Can. Vet. J., 26: 357-360.

Radostits, O. M., Searcy, G. P., Mitchall, K. G. 1980. Moldy sweetclover poisoning in cattle. Can. Vet. J., 21: 155-158.

Horses

General symptoms of poisoning:

[anemia](#)

[hemorrhage](#)

Notes on poisoning:

In one case in Saskatchewan, a Percheron mare was anemic and was hemorrhaging from the left nostril at 60 drops per min. Mucous membranes were blanched. Subcutaneous edema extended from the intermandibular space to the pectoral region. The animal was treated with an injection of 4.2 g of menadione sodium bisulphate and with 4 L of whole blood preserved in acid citrate dextrose solution. Complete recovery resulted. The mare had been fed weathered sweet-clover hay free-choice with access to pasture (McDonald 1980).

References:

McDonald, G. K. 1980. Moldy sweetclover poisoning in a horse. Can. Vet. J., 21: 250-251.

[Another search?](#)

[Français](#) | [Contact Us](#) | [Help](#) | [Search](#) | [Canada site](#)

[Coming Events](#) | [About CBIF](#) | [Links](#) | [Reports and Publications](#) |

[Home](#)

Date modified: 2003-02-06

[Important Notices](#)



Français	Contact us	Help	Search	Canada site
Coming events	About CBIF	Links	Reports and publications	Home

Canadian Biodiversity Information Facility



Notes on poisoning: *Melilotus officinalis*

[Introduction](#)

[Interactive](#)

[All poisonous plants by Botanical name](#)

[All poisonous plants by Common name](#)

[Important WWW Poisonous Plants sites](#)

General poisoning notes:

Yellow sweet-clover (*Melilotus officinalis*) is cultivated and naturalized across most of Canada. When cut for feed, molding usually occurs because of the succulent stems. The molds can metabolize coumarin which is hydrolyzed from a plant glycoside. Dicoumarol is produced, which is toxic to animals. See notes under white sweet-clover ([Melilotus alba](#)).

References:



Cheeke, P. R., Shull, L. R. 1985. Natural toxicants in feeds and poisonous plants. AVI Publishing Company, Inc., Westport, Conn., USA. 492 pp.

McDonald, G. K. 1980. Moldy sweetclover poisoning in a horse. Can. Vet. J., 21: 250-251.

Radostits, O. M., Searcy, G. P., Mitchall, K. G. 1980. Moldy sweetclover poisoning in cattle. Can. Vet. J., 21: 155-158.

Turkington, R. A., Cavers, P. B., Rempel, E. 1978. The biology of Canadian weeds. 29. *Melilotus alba* Desr. and *M. officinalis* (L.) Lam. Can. J. Plant Sci., 58: 523-537.

Nomenclature:

Scientific Name: *Melilotus officinalis* (L.) Lam.

Vernacular name(s): yellow sweet-clover

Scientific family name: *Leguminosae*

Vernacular family name: pea

Go to ITIS*^{ca} for more taxonomic information on: [Melilotus officinalis](#)

References:

Agriculture Quebec. 1975. Noms des maladies des plantes du Canada/ Names of plant diseases in Canada. , Quebec City, Que., Canada. 288 pp.

Alex, J. F., Cayouette, R., Mulligan, G. A. 1980. Common and botanical names of weeds in Canada/Noms populaire et scientifiques des plantes nuisibles du Canada. Revised. Agric. Can. Publ., Ottawa, Ont., Canada. 132 pp.

Bailey, L. H., Bailey, E. Z. 1976. Hortus third. Revised. MacMillan, New York, N.Y., USA. 1290 pp.

Scoggan, H. J. 1978, 1979. The flora of Canada. Nat. Mus. Nat. Sci. (Ottawa) Publ. Bot. 7(1)-7(4). 1711 pp.

Van Wijk, H. L. 1911. A dictionary of plant names. Martinus Nijhoff, The Hague, The Netherlands. 1444 pp.

Victorin, M. 1964. Flore Laurentienne. 2nd ed. Univ. Montreal, Montreal, Que., Canada. 952 pp.

Geographic Information

Alberta
British Columbia
Manitoba
New Brunswick
Newfoundland
Northwest Territories
Nova Scotia
Ontario
Prince Edward Island
Quebec
Saskatchewan
Yukon Territory

References:

Bailey, L. H., Bailey, E. Z. 1976. Hortus third. Revised. MacMillan, New York, N.Y., USA. 1290 pp.

Boivin, B. 1966, 1967. Énumération des plantes du Canada. Provencheria 6. Nat. Can. (Que.) 93: 253-274; 371-437; 583-646; 989-1063. 94: 131-157; 471-528; 625-655.

Image or illustration

Melilotus officinalis:

Images: images.google.com

Toxic parts:

leaves
stems

References:

Cheeke, P. R., Shull, L. R. 1985. Natural toxicants in feeds and poisonous plants. AVI Publishing Company, Inc., Westport, Conn., USA. 492 pp.

Notes on Toxic plant chemicals:

A glycoside, melilotoside, hydrolyzes to coumarin. Coumarin is metabolized by molds into dicoumarol, which interrupts vitamin K use in animals. Blood-clotting abilities are affected. See additional notes under white sweet-clover ([Melilotus alba](#)).

Toxic plant chemicals:

dicoumarol

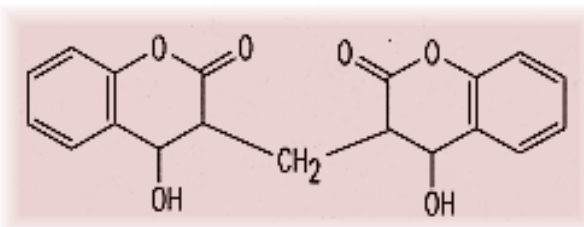

melilotoside

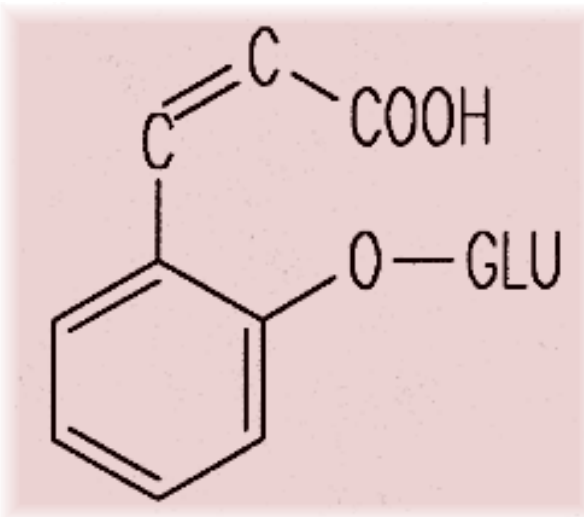

Chemical diagram(s) are courtesy of [Ruth McDiarmid](#), Biochemistry Technician, Kamloops Range Station, Agriculture and Agri-Food Canada, Kamloops, British Columbia, Canada.

References:

Cheeke, P. R., Shull, L. R. 1985. Natural toxicants in feeds and poisonous plants. AVI Publishing Company, Inc., Westport, Conn., USA. 492 pp.

Animals/Human Poisoning:

Note: When an animal is listed without additional information, the literature (as of 1993) contained no detailed explanation.

Cattle

General symptoms of poisoning:

[anemia](#)

[hemorrhage](#)

Notes on poisoning:

See notes under white sweet-clover ([Melilotus alba](#)).

References:

Cheeke, P. R., Shull, L. R. 1985. Natural toxicants in feeds and poisonous plants. AVI Publishing Company, Inc., Westport, Conn., USA. 492 pp.

Radostits, O. M., Searcy, G. P., Mitchall, K. G. 1980. Moldy sweetclover poisoning in cattle. Can. Vet. J., 21: 155-158.

Horses

General symptoms of poisoning:

[anemia](#)

[hemorrhage](#)

Notes on poisoning:

See notes under white sweet-clover ([Melilotus alba](#)).

References:

McDonald, G. K. 1980. Moldy sweetclover poisoning in a horse. Can. Vet. J., 21: 250-251.

[Another search?](#)

[Français](#) | [Contact Us](#) | [Help](#) | [Search](#) | [Canada site](#)
[Coming Events](#) | [About CBIF](#) | [Links](#) | [Reports and Publications](#) |
[Home](#)

Date modified: 2003-02-06

[Important Notices](#)



Français	Contact us	Help	Search	Canada site
Coming events	About CBIF	Links	Reports and publications	Home

Canadian Biodiversity Information Facility



Notes on poisoning: *Menispermum canadense*

[Introduction](#)[Interactive](#)[All poisonous plants by Botanical name](#)[All poisonous plants by Common name](#)[Important WWW Poisonous Plants sites](#)

General poisoning notes:

Moonseed (*Menispermum canadense*) is a native vine found in south-central Canada. In Pennsylvania the fruits of this plant have apparently killed children (Gress 1935, Lampe and McCann 1985).



References:

Gress, E. M. 1935. Poisonous plants of Pennsylvania. Penn. Dep. Agric. Gen. Bull., 531. 51 pp.

Lampe, K. F., McCann, M. A. 1985. AMA Handbook of poisonous and injurious plants. American Medical Assoc. Chicago, Ill., USA. 432 pp.

Nomenclature:

Scientific Name: *Menispermum canadense* L.

Vernacular name(s): moonseed

Scientific family name: *Menispermaceae*

Vernacular family name: moonseed

Go to ITIS^{*ca} for more taxonomic information on: [Menispermum canadense](#)

References:

Agriculture Quebec. 1975. Noms des maladies des plantes du Canada/ Names of plant diseases in Canada. , Quebec City, Que., Canada. 288 pp.

Alex, J. F., Cayouette, R., Mulligan, G. A. 1980. Common and botanical names of weeds in Canada/Noms populaire et

scientifiques des plantes nuisibles du Canada. Revised. Agric. Can. Publ., Ottawa, Ont., Canada. 132 pp.

Bailey, L. H., Bailey, E. Z. 1976. Hortus third. Revised. MacMillan, New York, N.Y., USA. 1290 pp.

Scoggan, H. J. 1978, 1979. The flora of Canada. Nat. Mus. Nat. Sci. (Ottawa) Publ. Bot. 7(1)-7(4). 1711 pp.

Van Wijk, H. L. 1911. A dictionary of plant names. Martinus Nijhoff, The Hague, The Netherlands. 1444 pp.

Victorin, M. 1964. Flore Laurentienne. 2nd ed. Univ. Montreal, Montreal, Que., Canada. 952 pp.

Geographic Information

Manitoba

Ontario

Quebec

References:

Bailey, L. H., Bailey, E. Z. 1976. Hortus third. Revised. MacMillan, New York, N.Y., USA. 1290 pp.

Boivin, B. 1966, 1967. Énumération des plantes du Canada. Provencheria 6. Nat. Can. (Que.) 93: 253-274; 371-437; 583-646; 989-1063. 94: 131-157; 471-528; 625-655.

Image or illustration

Menispermum canadense:

Images: images.google.com

Toxic parts:

mature fruit

References:

Gress, E. M. 1935. Poisonous plants of Pennsylvania. Penn. Dep. Agric. Gen. Bull., 531. 51 pp.

Lampe, K. F., McCann, M. A. 1985. AMA Handbook of poisonous and injurious plants. American Medical Assoc. Chicago, Ill., USA. 432 pp.

Notes on Toxic plant chemicals:

Moonseed contains alkaloids that may be responsible for the toxicity of the fruit to humans (Lampe and McCann 1985). Acutumine, an alkaloid, has been found in the aboveground part of moonseed, but has not been proved to cause the toxicity. Other alkaloids have also been found in the rhizomes (Doskotch and Knapp 1971).

Toxic plant chemicals:

acutumine
unknown chemical

References:

Doskotch, R. W., Knapp, J. E. 1971. Alkaloids from *Menispermum canadense*. *Lloydia* (Cinci), 34: 292-300.

Lampe, K. F., McCann, M. A. 1985. *AMA Handbook of poisonous and injurious plants*. American Medical Assoc. Chicago, Ill., USA. 432 pp.

Animals/Human Poisoning:

Note: When an animal is listed without additional information, the literature (as of 1993) contained no detailed explanation.

Humans

General symptoms of poisoning:

[convulsions](#)

[death](#)

Notes on poisoning:

Gress (1935) describes a case where children ingested moonseed berries and later died. Lampe and McCann (1985) state that convulsions may result when the berries are ingested.

References:

Gress, E. M. 1935. *Poisonous plants of Pennsylvania*. Penn. Dep. Agric. Gen. Bull., 531. 51 pp.

[Another search?](#)

[Français](#) | [Contact Us](#) | [Help](#) | [Search](#) | [Canada site](#)
[Coming Events](#) | [About CBIF](#) | [Links](#) | [Reports and Publications](#) |
[Home](#)

Date modified: 2003-02-06

[Important Notices](#)



Français	Contact us	Help	Search	Canada site
Coming events	About CBIF	Links	Reports and publications	Home

Canadian Biodiversity Information Facility



Notes on poisoning: *Menziesia ferruginea*

[Introduction](#)[Interactive](#)[All poisonous plants by
Botanical name](#)[All poisonous plants by
Common name](#)[Important WWW Poisonous
Plants sites](#)

General poisoning notes:

Western minniebush (*Menziesia ferruginea*) is a native shrub found in western Canada. This plant has occasionally been implicated in cases of sheep poisoning. Feeding experiments have shown that it does cause poisoning in sheep. It is considered less toxic than some other members of the heath family, such as *Kalmia* spp. and *Rhododendron* spp. (Marsh 1914, Kingsbury 1964).

References:



Kingsbury, J. M. 1964. Poisonous plants of the United States and Canada. Prentice-Hall Inc., Englewood Cliffs, N.J., USA. 626 pp.

Marsh, C. D. 1914. *Menziesia*, a new stock-poisoning plant of the northwestern states. U.S. Dep. Agric. Bur. Plant Ind., 16. 3 pp.

Nomenclature:

Scientific Name: *Menziesia ferruginea* Sm.

Vernacular name(s): western minniebush

Scientific family name: *Ericaceae*

Vernacular family name: heath

Go to ITIS*^{ca} for more taxonomic information on: [Menziesia ferruginea](#)

References:

Agriculture Quebec. 1975. Noms des maladies des plantes du Canada/ Names of plant diseases in Canada. , Quebec City, Que., Canada. 288 pp.

Alex, J. F., Cayouette, R., Mulligan, G. A. 1980. Common and botanical names of weeds in Canada/Noms populaire et scientifiques des plantes nuisibles du Canada. Revised. Agric. Can. Publ., Ottawa, Ont., Canada.

132 pp.

Bailey, L. H., Bailey, E. Z. 1976. Hortus third. Revised. MacMillan, New York, N.Y., USA. 1290 pp.

Scoggan, H. J. 1978, 1979. The flora of Canada. Nat. Mus. Nat. Sci. (Ottawa) Publ. Bot. 7(1)-7(4). 1711 pp.

Van Wijk, H. L. 1911. A dictionary of plant names. Martinus Nijhoff, The Hague, The Netherlands. 1444 pp.

Victorin, M. 1964. Flore Laurentienne. 2nd ed. Univ. Montreal, Montreal, Que., Canada. 952 pp.

Geographic Information

Alberta
British Columbia

References:

Bailey, L. H., Bailey, E. Z. 1976. Hortus third. Revised. MacMillan, New York, N.Y., USA. 1290 pp.

Boivin, B. 1966, 1967. Énumération des plantes du Canada. Provencheria 6. Nat. Can. (Que.) 93: 253-274; 371-437; 583-646; 989-1063. 94: 131-157; 471-528; 625-655.

Image or illustration

Menziesia ferruginea:

Images: images.google.com

Toxic parts:

leaves

References:

Fuller, T. C., McClintock, E. 1986. Poisonous plants of California. Univ. California Press, Berkeley, Calif., USA. 432 pp.

Marsh, C. D. 1914. *Menziesia*, a new stock-poisoning plant of the northwestern states. U.S. Dep. Agric. Bur. Plant Ind., 16. 3 pp.

Notes on Toxic plant chemicals:

Andromedotoxins (grayanotoxins) are diterpenoid alkaloids. These toxins are common to all poisonous members of the heath family (including *Kalmia* spp. and *Rhododendron* spp.).

Toxic plant chemicals:

andromedotoxins

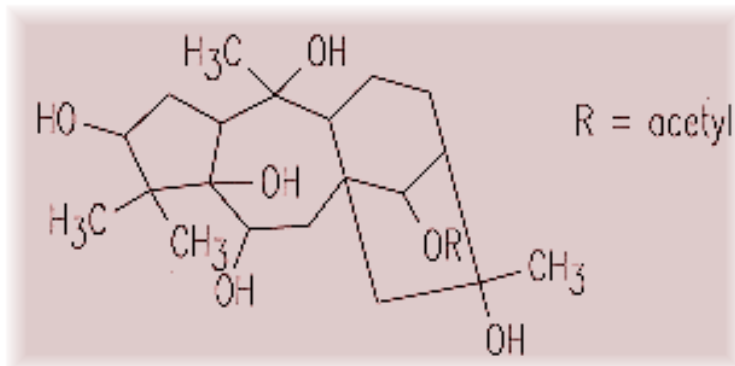

Chemical diagram(s) are courtesy of [Ruth McDiarmid](#), Biochemistry Technician, Kamloops Range Station, Agriculture and Agri-Food Canada, Kamloops, British Columbia, Canada.

References:

Fuller, T. C., McClintock, E. 1986. Poisonous plants of California. Univ. California Press, Berkeley, Calif., USA. 432 pp.

Animals/Human Poisoning:

Note: When an animal is listed without additional information, the literature (as of 1993) contained no detailed explanation.

Sheep

General symptoms of poisoning:

[breathing, labored](#)

[gait, staggering](#)

[mouth, frothing of](#)

[nausea](#)

[paralysis](#)

[salivation](#)

[weakness](#)

References:

Marsh, C. D. 1914. *Menziesia*, a new stock-poisoning plant of the northwestern states. U.S. Dep. Agric. Bur. Plant Ind., 16. 3 pp.

[Another search?](#)

[Français](#) | [Contact Us](#) | [Help](#) | [Search](#) | [Canada site](#)

[Coming Events](#) | [About CBIF](#) | [Links](#) | [Reports and Publications](#) | [Home](#)

Date modified: 2003-02-06

[Important Notices](#)



Français	Contact us	Help	Search	Canada site
Coming events	About CBIF	Links	Reports and publications	Home

Canadian Biodiversity Information Facility



Notes on poisoning: *Monstera deliciosa*

[Introduction](#)[Interactive](#)[All poisonous plants by Botanical name](#)[All poisonous plants by Common name](#)[Important WWW Poisonous Plants sites](#)

General poisoning notes:

Swiss-cheese plant (*Monstera deliciosa*) is an indoor ornamental. The leaves can cause problems if chewed by humans or family pets. Experimental rats and mice died after they were fed plant extracts (Der Marderosian et al. 1976, Lampe and McCann 1985).



References:

Der Marderosian, A. H., Giller, F. B., Roia, F. C. 1976. Phytochemical and toxicological screening of household ornamental plants potentially toxic to humans. 1. *J. Toxicol. Environ. Health*, 1: 939-953.

Lampe, K. F., McCann, M. A. 1985. *AMA Handbook of poisonous and injurious plants*. American Medical Assoc. Chicago, Ill., USA. 432 pp.

Mitchell, J. C., Rook, A. 1979. *Botanical dermatology*. Greenglass Ltd, Vancouver, B.C., Canada. 787 pp.

Nomenclature:

Scientific Name: *Monstera deliciosa* Liebm.

Vernacular name(s): Swiss-cheese plant

Scientific family name: *Araceae*

Vernacular family name: arum

Go to ITIS^{*ca} for more taxonomic information on: [Monstera deliciosa](#)

References:

Agriculture Quebec. 1975. Noms des maladies des plantes du

Canada/ Names of plant diseases in Canada. , Quebec City, Que., Canada. 288 pp.

Alex, J. F., Cayouette, R., Mulligan, G. A. 1980. Common and botanical names of weeds in Canada/Noms populaire et scientifiques des plantes nuisibles du Canada. Revised. Agric. Can. Publ., Ottawa, Ont., Canada. 132 pp.

Bailey, L. H., Bailey, E. Z. 1976. Hortus third. Revised. MacMillan, New York, N.Y., USA. 1290 pp.

Scoggan, H. J. 1978, 1979. The flora of Canada. Nat. Mus. Nat. Sci. (Ottawa) Publ. Bot. 7(1)-7(4). 1711 pp.

Van Wijk, H. L. 1911. A dictionary of plant names. Martinus Nijhoff, The Hague, The Netherlands. 1444 pp.

Victorin, M. 1964. Flore Laurentienne. 2nd ed. Univ. Montreal, Montreal, Que., Canada. 952 pp.

Geographic Information

Plant or plant parts used in or around the home.

References:

Bailey, L. H., Bailey, E. Z. 1976. Hortus third. Revised. MacMillan, New York, N.Y., USA. 1290 pp.

Boivin, B. 1966, 1967. Énumération des plantes du Canada. Provencheria 6. Nat. Can. (Que.) 93: 253-274; 371-437; 583-646; 989-1063. 94: 131-157; 471-528; 625-655.

Image or illustration

Monstera deliciosa:

Images: images.google.com

Toxic parts:

leaves

References:

Der Marderosian, A. H., Giller, F. B., Roia, F. C. 1976. Phytochemical and toxicological screening of household ornamental plants potentially toxic to humans. 1. J. Toxicol. Environ. Health, 1: 939-953.

Lampe, K. F., McCann, M. A. 1985. AMA Handbook of poisonous and injurious plants. American Medical Assoc.

Chicago, Ill., USA. 432 pp.

Animals/Human Poisoning:

Note: When an animal is listed without additional information, the literature (as of 1993) contained no detailed explanation.

Humans

General symptoms of poisoning:

[aphonia](#)

[blistering](#)

[hoarseness](#)

[mouth, irritation of](#)

[urticaria](#)

Notes on poisoning:

Chewing the leaf causes severe pain and irritation, along with blistering and edema of mouth tissue. Hoarseness and loss of voice can also occur. The insoluble oxalates do not cause systemic poisoning in humans (Lampe and McCann 1985). Ingesting the ripened fruit can cause rapidly developing urticaria (hives) in sensitive individuals (Mitchell and Rook 1979). The ripe fruit is edible but is not normally produced indoors in Canada.

References:

Lampe, K. F., McCann, M. A. 1985. AMA Handbook of poisonous and injurious plants. American Medical Assoc. Chicago, Ill., USA. 432 pp.

Mitchell, J. C., Rook, A. 1979. Botanical dermatology. Greenglass Ltd, Vancouver, B.C., Canada. 787 pp.

Rodents

[Another search?](#)

[Français](#) | [Contact Us](#) | [Help](#) | [Search](#) | [Canada site](#)

[Coming Events](#) | [About CBIF](#) | [Links](#) | [Reports and Publications](#) | [Home](#)

Date modified: 2003-02-06

[Important Notices](#)



Français	Contact us	Help	Search	Canada site
Coming events	About CBIF	Links	Reports and publications	Home

Canadian Biodiversity Information Facility



Notes on poisoning: *Narcissus poeticus*

[Introduction](#)[Interactive](#)[All poisonous plants by Botanical name](#)[All poisonous plants by Common name](#)[Important WWW Poisonous Plants sites](#)

General poisoning notes:

Narcissus (*Narcissus poeticus*) is an ornamental bulb that is planted outdoors as a perennial and is occasionally used indoors as a winter forced flower. This plant contains allergens in the aboveground plant parts, which cause dermatitis in sensitive humans. Ingesting the bulbs can cause poisoning in humans and has also poisoned some cattle. Family pets could be at risk if they ingest quantities of this plant. Serious cases of poisoning are rare. Humans have been poisoned only when the bulbs were mistaken for onions (Mitchell and Rook 1979, Litovitz and Fahey 1982, Cooper and Johnson 1984). See notes under daffodil ([Narcissus pseudonarcissus](#)) for more information.

References:

Cooper, M. R., Johnson, A. W. 1984. Poisonous plants in Britain and their effects on animals and man. Her Majesty's Stationery Office, London, England. 305 pp.

Lampe, K. F., McCann, M. A. 1985. AMA Handbook of poisonous and injurious plants. American Medical Assoc. Chicago, Ill., USA. 432 pp.

Litovitz, T. L., Fahey, B. A. 1982. Please don't eat the daffodils. N. Eng. J. Med., 306: 547.

Mitchell, J. C., Rook, A. 1979. Botanical dermatology. Greenglass Ltd, Vancouver, B.C., Canada. 787 pp.

Nomenclature:

Scientific Name: *Narcissus poeticus* L.

Vernacular name(s): narcissus

Scientific family name: *Amaryllidaceae*

Vernacular family name: amaryllis

Go to ITIS^{*ca} for more taxonomic information on: [Narcissus poeticus](#)

References:

Agriculture Quebec. 1975. Noms des maladies des plantes du Canada/ Names of plant diseases in Canada. , Quebec City, Que., Canada. 288 pp.

Alex, J. F., Cayouette, R., Mulligan, G. A. 1980. Common and botanical names of weeds in Canada/Noms populaire et scientifiques des plantes nuisibles du Canada. Revised. Agric. Can. Publ., Ottawa, Ont., Canada. 132 pp.

Bailey, L. H., Bailey, E. Z. 1976. Hortus third. Revised. MacMillan, New York, N.Y., USA. 1290 pp.

Scoggan, H. J. 1978, 1979. The flora of Canada. Nat. Mus. Nat. Sci. (Ottawa) Publ. Bot. 7(1)-7(4). 1711 pp.

Van Wijk, H. L. 1911. A dictionary of plant names. Martinus Nijhoff, The Hague, The Netherlands. 1444 pp.

Victorin, M. 1964. Flore Laurentienne. 2nd ed. Univ. Montreal, Montreal, Que., Canada. 952 pp.

Geographic Information

Plant or plant parts used in or around the home.

References:

Bailey, L. H., Bailey, E. Z. 1976. Hortus third. Revised. MacMillan, New York, N.Y., USA. 1290 pp.

Boivin, B. 1966, 1967. Énumération des plantes du Canada. Provencheria 6. Nat. Can. (Que.) 93: 253-274; 371-437; 583-646; 989-1063. 94: 131-157; 471-528; 625-655.

Image or illustration

Narcissus poeticus:

Images: images.google.com

Notes on Poisonous plant parts:

See notes under daffodil ([Narcissus pseudonarcissus](#)) for more information.

Toxic parts:

bulbs
flowers
leaves

References:

Lampe, K. F., McCann, M. A. 1985. AMA Handbook of poisonous and injurious plants. American Medical Assoc. Chicago, Ill., USA. 432 pp.

Notes on Toxic plant chemicals:

The bulbs contain oxalate crystals as well as an alkaloid lycorine, which cause toxic problems. Unknown allergens in the leaves and flowers cause dermatitis in sensitive individuals (Mitchell and Rook 1979).

Toxic plant chemicals:

lycorine
oxalate

References:

Lampe, K. F., McCann, M. A. 1985. AMA Handbook of poisonous and injurious plants. American Medical Assoc. Chicago, Ill., USA. 432 pp.

Animals/Human Poisoning:

Note: When an animal is listed without additional information, the literature (as of 1993) contained no detailed explanation.

Cattle

General symptoms of poisoning:

[convulsions](#)
[gastroenteritis](#)

Notes on poisoning:

In World War II, cattle were fed bulbs of daffodils, with toxic results. Ingesting narcissus bulbs can have similar results. The animals were given these plants because of scarce food supplies (Cooper and Johnson 1984).

References:

Cooper, M. R., Johnson, A. W. 1984. Poisonous plants in Britain and their effects on animals and man. Her Majesty's Stationery Office, London, England. 305 pp.

Humans

General symptoms of poisoning:

[dizziness](#)

[eczema](#)

[erythema](#)

[nausea](#)

[skin, flushed](#)

[vomiting](#)

Notes on poisoning:

Symptoms of ingesting narcissus bulbs include lightheadedness, nausea, and vomiting. More severe symptoms are rare because of rapid emesis (Litovitz and Fahey 1982).

References:

Litovitz, T. L., Fahey, B. A. 1982. Please don't eat the daffodils. N. Eng. J. Med., 306: 547.

Mitchell, J. C., Rook, A. 1979. Botanical dermatology. Greenglass Ltd, Vancouver, B.C., Canada. 787 pp.

[Another search?](#)

[Français](#) | [Contact Us](#) | [Help](#) | [Search](#) | [Canada site](#)

[Coming Events](#) | [About CBIF](#) | [Links](#) | [Reports and Publications](#) |

[Home](#)

Date modified: 2003-02-06

[Important Notices](#)



Français	Contact us	Help	Search	Canada site
Coming events	About CBIF	Links	Reports and publications	Home



Notes on poisoning:

Narcissus

pseudonarcissus

[Introduction](#)

[Interactive](#)

[All poisonous plants by Botanical name](#)

[All poisonous plants by Common name](#)

[Important WWW Poisonous Plants sites](#)



General poisoning notes:

Daffodil (*Narcissus pseudonarcissus*) is an ornamental that is planted outdoors as a spring-flowering perennial. It may be used indoors as a forced flower during the winter. The aboveground parts cause dermatitis in sensitive individuals. The bulbs can also cause dermatitis. Humans have been poisoned after ingesting bulbs thought to be onions, as have cattle when they were fed bulbs instead of feed in times of scarcity. Family pets may be at risk if they ingest daffodils (Mitchell and Rook 1979, Litovitz and Fahey 1982, Cooper and Johnson 1984).

References:

Cooper, M. R., Johnson, A. W. 1984. Poisonous plants in Britain and their effects on animals and man. Her Majesty's Stationery Office, London, England. 305 pp.

Gonçalo, S., Freitas, J. D., Sousa, I. 1987. Contact dermatitis and respiratory symptoms and *Narcissus pseudonarcissus*. Contact Dermatitis, 16: 115-116.

Litovitz, T. L., Fahey, B. A. 1982. Please don't eat the daffodils. N. Eng. J. Med., 306: 547.

Mitchell, J. C., Rook, A. 1979. Botanical dermatology. Greenglass Ltd, Vancouver, B.C., Canada. 787 pp.

Nomenclature:

Scientific Name: *Narcissus pseudonarcissus* L.

Vernacular name(s): daffodil

Scientific family name: *Amaryllidaceae*

Vernacular family name: amaryllis

Go to ITIS^{*ca} for more taxonomic information on: [Narcissus pseudonarcissus](#)

References:

Agriculture Quebec. 1975. Noms des maladies des plantes du Canada/ Names of plant diseases in Canada. , Quebec City, Que., Canada. 288 pp.

Alex, J. F., Cayouette, R., Mulligan, G. A. 1980. Common and botanical names of weeds in Canada/Noms populaire et scientifiques des plantes nuisibles du Canada. Revised. Agric. Can. Publ., Ottawa, Ont., Canada. 132 pp.

Bailey, L. H., Bailey, E. Z. 1976. Hortus third. Revised. MacMillan, New York, N.Y., USA. 1290 pp.

Scoggan, H. J. 1978, 1979. The flora of Canada. Nat. Mus. Nat. Sci. (Ottawa) Publ. Bot. 7(1)-7(4). 1711 pp.

Van Wijk, H. L. 1911. A dictionary of plant names. Martinus Nijhoff, The Hague, The Netherlands. 1444 pp.

Victorin, M. 1964. Flore Laurentienne. 2nd ed. Univ. Montreal, Montreal, Que., Canada. 952 pp.

Geographic Information

Plant or plant parts used in or around the home.

References:

Bailey, L. H., Bailey, E. Z. 1976. Hortus third. Revised. MacMillan, New York, N.Y., USA. 1290 pp.

Boivin, B. 1966, 1967. Énumération des plantes du Canada. Provencheria 6. Nat. Can. (Que.) 93: 253-274; 371-437; 583-646; 989-1063. 94: 131-157; 471-528; 625-655.

Image or illustration

Narcissus pseudonarcissus:

Images: images.google.com

Notes on Poisonous plant parts:

The bulbs of narcissus are toxic if ingested. All parts of the plant can cause allergic dermatitis in sensitive humans (Mitchell and Rook

1979).

Toxic parts:

bulbs
flowers
leaves
stems

References:

Gonçalo, S., Freitas, J. D., Sousa, I. 1987. Contact dermatitis and respiratory symptoms and *Narcissus pseudonarcissus*. Contact Dermatitis, 16: 115-116.

Lampe, K. F., McCann, M. A. 1985. AMA Handbook of poisonous and injurious plants. American Medical Assoc. Chicago, Ill., USA. 432 pp.

Mitchell, J. C., Rook, A. 1979. Botanical dermatology. Greenglass Ltd, Vancouver, B.C., Canada. 787 pp.

Toxic plant chemicals:

lycorine

References:

Lampe, K. F., McCann, M. A. 1985. AMA Handbook of poisonous and injurious plants. American Medical Assoc. Chicago, Ill., USA. 432 pp.

Animals/Human Poisoning:

Note: When an animal is listed without additional information, the literature (as of 1993) contained no detailed explanation.

Cattle

General symptoms of poisoning:

[convulsions](#)
[drowsiness](#)
[gastroenteritis](#)

Notes on poisoning:

During World War II, cattle were fed daffodil bulbs because of scarce feed. They developed seizures, sedation, hypotension, and gastrointestinal and hepatic degeneration. Animal poisoning is more

severe than human poisoning because humans develop rapid emesis (Litovitz and Fahey 1982, Cooper and Johnson 1984).

References:

Cooper, M. R., Johnson, A. W. 1984. Poisonous plants in Britain and their effects on animals and man. Her Majesty's Stationery Office, London, England. 305 pp.

Litovitz, T. L., Fahey, B. A. 1982. Please don't eat the daffodils. N. Eng. J. Med., 306: 547.

Humans

General symptoms of poisoning:

[abdominal pains](#)

[conjunctivitis](#)

[diarrhea](#)

[dizziness](#)

[dyspnea](#)

[eczema](#)

[erythema](#)

[hoarseness](#)

[itchiness](#)

[nausea](#)

[vomiting](#)

Notes on poisoning:

Ingesting daffodil bulbs produces the following symptoms: abdominal pains, vomiting, nausea, lightheadedness, shivering, and sometimes diarrhea. Because emesis is rapid, more severe symptoms do not usually occur. Ingesting bulbs is rare (Litovitz and Fahey 1982, Lampe and McCann 1985).

References:

Gonçalo, S., Freitas, J. D., Sousa, I. 1987. Contact dermatitis and respiratory symptoms and *Narcissus pseudonarcissus*. Contact Dermatitis, 16: 115-116.

Litovitz, T. L., Fahey, B. A. 1982. Please don't eat the daffodils. N. Eng. J. Med., 306: 547.

Mitchell, J. C., Rook, A. 1979. Botanical dermatology. Greenglass Ltd, Vancouver, B.C., Canada. 787 pp.

[Another search?](#)

[Français](#) | [Contact Us](#) | [Help](#) | [Search](#) | [Canada site](#)
[Coming Events](#) | [About CBIF](#) | [Links](#) | [Reports and Publications](#) |
[Home](#)

Date modified: 2003-02-06

[Important Notices](#)



Français	Contact us	Help	Search	Canada site
Coming events	About CBIF	Links	Reports and publications	Home

Canadian Biodiversity Information Facility



Notes on poisoning: *Nerium oleander*

[Introduction](#)[Interactive](#)[All poisonous plants by Botanical name](#)[All poisonous plants by Common name](#)[Important WWW Poisonous Plants sites](#)

General poisoning notes:

Oleander (*Nerium oleander*) is an ornamental indoor shrub found in Canadian homes and offices. This plant is quite toxic if the leaves or stems are ingested. Humans have died after eating meat that was skewered with oleander stems. Ingesting a single leaf may be toxic to a person. The dry leaves remain toxic. Cattle, horses, and sheep have been poisoned experimentally (Wilson 1909, Kingsbury 1964). Livestock are not likely to have access to oleander in Canada. Children and family pets should be prevented from ingesting green or dry leaves, chewing stems, or sucking the nectar from flowers.

References:

Kingsbury, J. M. 1964. Poisonous plants of the United States and Canada. Prentice-Hall Inc., Englewood Cliffs, N.J., USA. 626 pp.

Wilson, F. W. 1909. Oleander poisoning of livestock. Univ. Ariz. Agric. Exp. Stn. Bull., 59. 383-397 pp.

Nomenclature:

Scientific Name: *Nerium oleander* L.

Vernacular name(s): oleander

Scientific family name: *Apocynaceae*

Vernacular family name: dogbane

Go to ITIS^{*ca} for more taxonomic information on: [Nerium oleander](#)

References:

Agriculture Quebec. 1975. Noms des maladies des plantes du

Canada/ Names of plant diseases in Canada. , Quebec City, Que., Canada. 288 pp.

Alex, J. F., Cayouette, R., Mulligan, G. A. 1980. Common and botanical names of weeds in Canada/Noms populaire et scientifiques des plantes nuisibles du Canada. Revised. Agric. Can. Publ., Ottawa, Ont., Canada. 132 pp.

Bailey, L. H., Bailey, E. Z. 1976. Hortus third. Revised. MacMillan, New York, N.Y., USA. 1290 pp.

Scoggan, H. J. 1978, 1979. The flora of Canada. Nat. Mus. Nat. Sci. (Ottawa) Publ. Bot. 7(1)-7(4). 1711 pp.

Van Wijk, H. L. 1911. A dictionary of plant names. Martinus Nijhoff, The Hague, The Netherlands. 1444 pp.

Victorin, M. 1964. Flore Laurentienne. 2nd ed. Univ. Montreal, Montreal, Que., Canada. 952 pp.

Geographic Information

Plant or plant parts used in or around the home.

References:

Bailey, L. H., Bailey, E. Z. 1976. Hortus third. Revised. MacMillan, New York, N.Y., USA. 1290 pp.

Boivin, B. 1966, 1967. Énumération des plantes du Canada. Provencheria 6. Nat. Can. (Que.) 93: 253-274; 371-437; 583-646; 989-1063. 94: 131-157; 471-528; 625-655.

Image or illustration

Nerium oleander:

Images: images.google.com

Toxic parts:

all parts
flowers
leaves
stems
young shoots

References:

Fuller, T. C., McClintock, E. 1986. Poisonous plants of California. Univ. California Press, Berkeley, Calif., USA. 432 pp.

Notes on Toxic plant chemicals:

Oleandrin, a cardiac glycoside, is found throughout the plant, including the nectar of the flowers. Smoke from burning twigs is said to be toxic (Fuller and McClintock 1986).

Toxic plant chemicals:

oleandrin

References:

Fuller, T. C., McClintock, E. 1986. Poisonous plants of California. Univ. California Press, Berkeley, Calif., USA. 432 pp.

Animals/Human Poisoning:

Note: When an animal is listed without additional information, the literature (as of 1993) contained no detailed explanation.

Cattle

General symptoms of poisoning:

[breathing, rapid](#)

[death](#)

[heart rate, elevated](#)

[mouth, irritation of](#)

[pupil dilation](#)

Notes on poisoning:

Experimental poisoning of cattle has shown symptoms that include elevated breathing and heart rate. If a large dose is given, the heart action becomes so low that a pulse is almost undetectable. Green leaves at a rate of as little as 0.005% of a cow's body weight can cause death (Wilson 1909, Kingsbury 1964).

References:

Kingsbury, J. M. 1964. Poisonous plants of the United States and Canada. Prentice-Hall Inc., Englewood Cliffs, N.J., USA. 626 pp.

Wilson, F. W. 1909. Oleander poisoning of livestock. Univ. Ariz. Agric. Exp. Stn. Bull., 59. 383-397 pp.

Horses

General symptoms of poisoning:

[breathing, rapid](#)

[death](#)

[mouth, irritation of](#)

[pupil dilation](#)

Notes on poisoning:

Experimental poisoning of horses with fresh oleander leaves resulted in toxic symptoms, including elevated breathing and pulse, greenish feces, some abdominal pain, cold extremities, and a swollen and irritated mouth and tongue. A dose of green leaves equal to 0.005% of a horse's body weight is sufficient to kill a horse (Wilson 1909, Kingsbury 1964).

References:

Kingsbury, J. M. 1964. Poisonous plants of the United States and Canada. Prentice-Hall Inc., Englewood Cliffs, N.J., USA. 626 pp.

Wilson, F. W. 1909. Oleander poisoning of livestock. Univ. Ariz. Agric. Exp. Stn. Bull., 59. 383-397 pp.

Humans

General symptoms of poisoning:

[abdominal pains](#)

[coma](#)

[death](#)

[diarrhea](#)

[dizziness](#)

[drowsiness](#)

[dyspnea](#)

[mouth, irritation of](#)

[nausea](#)

Notes on poisoning:

Humans have been poisoned from using the twigs of oleander to skewer meat or roast frankfurters. Ingesting a single green or dry leaf may cause poisoning. Symptoms include dizziness, abdominal pain, vomiting, unconsciousness, bloody stools, and light and rapid pulse. Death has occurred in some cases. Symptoms occur several hours after ingesting a toxic dose (Wilson 1909, Kingsbury 1964).

References:

Kingsbury, J. M. 1964. Poisonous plants of the United States and Canada. Prentice-Hall Inc., Englewood Cliffs, N.J., USA. 626 pp.

Wilson, F. W. 1909. Oleander poisoning of livestock. Univ. Ariz. Agric. Exp. Stn. Bull., 59. 383-397 pp.

Sheep

General symptoms of poisoning:

[breathing, rapid](#)

[death](#)

[mouth, irritation of](#)

Notes on poisoning:

Experimental feeding of green oleander leaves has caused elevated breathing, partial unconsciousness, sore mouth and nostrils, discolored mucous membranes, and death (dose: 0.015% body weight of green leaves). Cold extremities and gastroenteritis also occur (Wilson 1909, Kingsbury 1964).

References:

Kingsbury, J. M. 1964. Poisonous plants of the United States and Canada. Prentice-Hall Inc., Englewood Cliffs, N.J., USA. 626 pp.

Wilson, F. W. 1909. Oleander poisoning of livestock. Univ. Ariz. Agric. Exp. Stn. Bull., 59. 383-397 pp.

[Another search?](#)

[Français](#) | [Contact Us](#) | [Help](#) | [Search](#) | [Canada site](#)

[Coming Events](#) | [About CBIF](#) | [Links](#) | [Reports and Publications](#) | [Home](#)

Date modified: 2003-02-06

[Important Notices](#)



Français	Contact us	Help	Search	Canada site
Coming events	About CBIF	Links	Reports and publications	Home

Canadian Biodiversity Information Facility



Notes on poisoning: *Nicotiana tabacum*

[Introduction](#)[Interactive](#)[All poisonous plants by Botanical name](#)[All poisonous plants by Common name](#)[Important WWW Poisonous Plants sites](#)

General poisoning notes:

Tobacco (*Nicotiana tabacum*) is cultivated in some areas of Canada as a commercial crop for the tobacco industry.

Teratogenic problems have occurred in the United States when pregnant swine were allowed to forage on tobacco stalks. The sows showed no toxic signs. Pregnant swine should be denied access to tobacco plants. Rare cases of human dermatitis from contact with tobacco leaves have been reported (Bush and Crowe 1989, Gonçalo et al. 1990).

References:

Bush, L. P., Crowe, M. W. 1989. *Nicotiana* alkaloids. Pages 87-107 in Cheeke, P. R., ed. Toxicants of plant origin. Vol. I. Alkaloids. CRC Press, Inc., Boca Raton, Fla., USA. 335 pp.

Crowe, M. W., Swerczek, T. W. 1974. Congenital arthrogryposis in offspring of sows fed tobacco (*Nicotiana tabacum*). *Am. J. Vet. Res.*, 35: 1071-1073.

Crowe, M. W. 1969. Skeletal anomalies in pigs associated with tobacco. *Mod. Vet. Pract.*, 50-13: 54-55.

Gonçalo, M., Couto, J., Gonçalo, S. 1990. Allergic contact dermatitis from *Nicotiana tabacum*. *Contact Dermatitis*, 22: 188-189.

Nomenclature:

Scientific Name: *Nicotiana tabacum* L.

Vernacular name(s): tobacco

Scientific family name: *Solanaceae*

Vernacular family name: nightshade

Go to ITIS^{*ca} for more taxonomic information on: [Nicotiana tabacum](#)

References:

Agriculture Quebec. 1975. Noms des maladies des plantes du Canada/ Names of plant diseases in Canada. , Quebec City, Que., Canada. 288 pp.

Alex, J. F., Cayouette, R., Mulligan, G. A. 1980. Common and botanical names of weeds in Canada/Noms populaire et scientifiques des plantes nuisibles du Canada. Revised. Agric. Can. Publ., Ottawa, Ont., Canada. 132 pp.

Bailey, L. H., Bailey, E. Z. 1976. Hortus third. Revised. MacMillan, New York, N.Y., USA. 1290 pp.

Scoggan, H. J. 1978, 1979. The flora of Canada. Nat. Mus. Nat. Sci. (Ottawa) Publ. Bot. 7(1)-7(4). 1711 pp.

Van Wijk, H. L. 1911. A dictionary of plant names. Martinus Nijhoff, The Hague, The Netherlands. 1444 pp.

Victorin, M. 1964. Flore Laurentienne. 2nd ed. Univ. Montreal, Montreal, Que., Canada. 952 pp.

Geographic Information

Plant or plant parts used in or around the home.

References:

Bailey, L. H., Bailey, E. Z. 1976. Hortus third. Revised. MacMillan, New York, N.Y., USA. 1290 pp.

Boivin, B. 1966, 1967. Énumération des plantes du Canada. Provencheria 6. Nat. Can. (Que.) 93: 253-274; 371-437; 583-646; 989-1063. 94: 131-157; 471-528; 625-655.

Image or illustration

Nicotiana tabacum:

Images: images.google.com

Notes on Poisonous plant parts:

The left-over stalks of tobacco plants that remain in the field have caused teratogenic problems. Problems are related to high-yield tobacco crops where heavy fertilization produces yields of dry leaf that exceed 1300 kg/0.40 ha. Experimental feeding of

aqueous filtrate of the leaves and juice of tobacco stalks has also caused teratogenic problems in swine (Crowe and Swerczek 1974).

Toxic parts:

leaves
stems

References:

Crowe, M. W., Swerczek, T. W. 1974. Congenital arthrogryposis in offspring of sows fed tobacco (*Nicotiana tabacum*). Am. J. Vet. Res., 35: 1071-1073.

Notes on Toxic plant chemicals:

Pyridine alkaloids such as anabasine, anatabine, and perhaps anabasine, are responsible for teratogenic problems in swine. Anabasine is the major alkaloid of related *Nicotiana glauca*, in the southern United States, and it has caused teratogenic problems in calves, sheep, and swine. However, anabasine is found in much smaller quantities in tobacco. Anatabine and perhaps anabaseine are therefore believed to be involved in the teratogenic effects on swine (Bush and Crowe 1989).

Toxic plant chemicals:

anabasine
anatabine

References:

Bush, L. P., Crowe, M. W. 1989. *Nicotiana* alkaloids. Pages 87-107 in Cheeke, P. R., ed. Toxicants of plant origin. Vol. I. Alkaloids. CRC Press, Inc., Boca Raton, Fla., USA. 335 pp.

Animals/Human Poisoning:

Note: When an animal is listed without additional information, the literature (as of 1993) contained no detailed explanation.

Humans

General symptoms of poisoning:

[eczema](#)

References:

Gonçalo, M., Couto, J., Gonçalo, S. 1990. Allergic contact dermatitis from *Nicotiana tabacum*. Contact Dermatitis, 22: 188-189.

Swine

General symptoms of poisoning:

[arthrogryposis](#)

Notes on poisoning:

Pregnant sows that ingested tobacco stalks between day 10 and day 50 of gestation developed arthrogryposis, often involving all limbs of the pigs. Occasionally, vertebral column arching has occurred (Crowe 1969, Crowe and Swerczek 1974, Bush and Crowe 1989).

References:

Crowe, M. W., Swerczek, T. W. 1974. Congenital arthrogryposis in offspring of sows fed tobacco (*Nicotiana tabacum*). Am. J. Vet. Res., 35: 1071-1073.

[Another search?](#)

[Français](#) | [Contact Us](#) | [Help](#) | [Search](#) | [Canada site](#)

[Coming Events](#) | [About CBIF](#) | [Links](#) | [Reports and Publications](#) | [Home](#)

Date modified: 2003-02-06

[Important Notices](#)



Français	Contact us	Help	Search	Canada site
Coming events	About CBIF	Links	Reports and publications	Home

Canadian Biodiversity Information Facility



Notes on poisoning: *Onoclea sensibilis*

[Introduction](#)[Interactive](#)[All poisonous plants by Botanical name](#)[All poisonous plants by Common name](#)[Important WWW Poisonous Plants sites](#)

General poisoning notes:

Sensitive fern (*Onoclea sensibilis*) is a native plant that is found through eastern Canada into Manitoba. The plant, often abundant in low, wet areas, has been implicated in the poisoning and death of horses in field cases. Only one set of experimental poisonings has been undertaken, but the resulting symptoms were similar when horses were fed hay containing sensitive fern (Waller et al. 1944).

References:

Waller, E. F., Prince, F. S., Hodgson, A. R., Colovos, N. F. 1944. Sensitive-fern poisoning of horses. Univ. N. H. Agric. Stn. Tech. Bull., 83. 7 pp.

Nomenclature:

Scientific Name: *Onoclea sensibilis* L.

Vernacular name(s): sensitive fern

Scientific family name: *Polypodiaceae*

Vernacular family name: ffern

Go to ITIS*^{ca} for more taxonomic information on: [Onoclea sensibilis](#)

References:

Agriculture Quebec. 1975. Noms des maladies des plantes du Canada/ Names of plant diseases in Canada. , Quebec City, Que., Canada. 288 pp.

Alex, J. F., Cayouette, R., Mulligan, G. A. 1980. Common and botanical names of weeds in Canada/Noms populaire et

scientifiques des plantes nuisibles du Canada. Revised. Agric. Can. Publ., Ottawa, Ont., Canada. 132 pp.

Bailey, L. H., Bailey, E. Z. 1976. Hortus third. Revised. MacMillan, New York, N.Y., USA. 1290 pp.

Scoggan, H. J. 1978, 1979. The flora of Canada. Nat. Mus. Nat. Sci. (Ottawa) Publ. Bot. 7(1)-7(4). 1711 pp.

Van Wijk, H. L. 1911. A dictionary of plant names. Martinus Nijhoff, The Hague, The Netherlands. 1444 pp.

Victorin, M. 1964. Flore Laurentienne. 2nd ed. Univ. Montreal, Montreal, Que., Canada. 952 pp.

Geographic Information

Labrador
Manitoba
New Brunswick
Nova Scotia
Ontario
Prince Edward Island
Quebec

References:

Bailey, L. H., Bailey, E. Z. 1976. Hortus third. Revised. MacMillan, New York, N.Y., USA. 1290 pp.

Boivin, B. 1966, 1967. Énumération des plantes du Canada. Provencheria 6. Nat. Can. (Que.) 93: 253-274; 371-437; 583-646; 989-1063. 94: 131-157; 471-528; 625-655.

Image or illustration

Onoclea sensibilis:

Images: images.google.com

Notes on Poisonous plant parts:

When the fronds (aboveground leaves) are included in hay, they produce toxic symptoms in horses. The fertile fronds (spore-bearing stalks) are also included in hay. A literature search did not reveal any reports on the toxin, nor was the plant organ that contains the toxin identified.

Toxic parts:

leaves

References:

Waller, E. F., Prince, F. S., Hodgson, A. R., Colovos, N. F. 1944. Sensitive-fern poisoning of horses. Univ. N. H. Agric. Stn. Tech. Bull., 83. 7 pp.

Toxic plant chemicals:

unknown chemical

References:

Waller, E. F., Prince, F. S., Hodgson, A. R., Colovos, N. F. 1944. Sensitive-fern poisoning of horses. Univ. N. H. Agric. Stn. Tech. Bull., 83. 7 pp.

Animals/Human Poisoning:

Note: When an animal is listed without additional information, the literature (as of 1993) contained no detailed explanation.

Horses

General symptoms of poisoning:

[brain, congestion of](#)

[colic](#)

[death](#)

[falling down](#)

[gait, unsteady](#)

[icterus](#)

[incoordination](#)

Notes on poisoning:

Ingesting hay containing sensitive fern produces the following symptoms: difficulty in eating, falling down, walking as if blind, rubbing against objects, and death. Postmortem examination showed extreme icterus, swollen liver, paralysis of the alimentary tract, and brain edema. Old horses are more affected than younger ones. Horses that are worked and are fed a grain supplement, in addition to hay that includes the fern, are not affected. Recovery may occur if the horses are given good hay and grain before serious nervous symptoms develop (Waller et al. 1944).

References:

Waller, E. F., Prince, F. S., Hodgson, A. R., Colovos, N. F. 1944.

Sensitive-fern poisoning of horses. Univ. N. H. Agric. Stn. Tech. Bull., 83. 7 pp.

[Another search?](#)

[Français](#) | [Contact Us](#) | [Help](#) | [Search](#) | [Canada site](#)

[Coming Events](#) | [About CBIF](#) | [Links](#) | [Reports and Publications](#) |

[Home](#)

Date modified: 2003-02-06

[Important Notices](#)



Français	Contact us	Help	Search	Canada site
Coming events	About CBIF	Links	Reports and publications	Home

Canadian Biodiversity Information Facility



Notes on poisoning: *Ornithogalum umbellatum*

[Introduction](#)[Interactive](#)[All poisonous plants by Botanical name](#)[All poisonous plants by Common name](#)[Important WWW Poisonous Plants sites](#)

General poisoning notes:

Star-of-Bethlehem (*Ornithogalum umbellatum*), an outdoor ornamental flower, contains glycosides similar to digitalis. In some countries children have been poisoned after ingesting the flowers or bulbs. Ingesting two bulbs by an adult caused shortness of breath. The bulbs contain the highest quantity of these toxins. Cattle in South Africa (the native region for star-of-Bethlehem) have been poisoned, resulting in permanent blindness and death after ingestion. Children and family pets should be prevented from ingesting material from this plant (Cooper and Johnson 1984, Lampe and McCann 1985, Spoerke and Smolinske 1990).

References:

Cooper, M. R., Johnson, A. W. 1984. Poisonous plants in Britain and their effects on animals and man. Her Majesty's Stationery Office, London, England. 305 pp.

Lampe, K. F., McCann, M. A. 1985. AMA Handbook of poisonous and injurious plants. American Medical Assoc. Chicago, Ill., USA. 432 pp.

Spoerke, D. G., Smolinske, S. C. 1990. Toxicity of houseplants. CRC Press, Inc., Boca Raton, Fla., USA. 335 pp.

Nomenclature:

Scientific Name: *Ornithogalum umbellatum* L.

Vernacular name(s): star-of-Bethlehem

Scientific family name: *Liliaceae*

Vernacular family name: lily

Go to ITIS^{*ca} for more taxonomic information on: [Ornithogalum umbellatum](#)

References:

Agriculture Quebec. 1975. Noms des maladies des plantes du Canada/ Names of plant diseases in Canada. , Quebec City, Que., Canada. 288 pp.

Alex, J. F., Cayouette, R., Mulligan, G. A. 1980. Common and botanical names of weeds in Canada/Noms populaire et scientifiques des plantes nuisibles du Canada. Revised. Agric. Can. Publ., Ottawa, Ont., Canada. 132 pp.

Bailey, L. H., Bailey, E. Z. 1976. Hortus third. Revised. MacMillan, New York, N.Y., USA. 1290 pp.

Scoggan, H. J. 1978, 1979. The flora of Canada. Nat. Mus. Nat. Sci. (Ottawa) Publ. Bot. 7(1)-7(4). 1711 pp.

Van Wijk, H. L. 1911. A dictionary of plant names. Martinus Nijhoff, The Hague, The Netherlands. 1444 pp.

Victorin, M. 1964. Flore Laurentienne. 2nd ed. Univ. Montreal, Montreal, Que., Canada. 952 pp.

Geographic Information

Plant or plant parts used in or around the home.

References:

Bailey, L. H., Bailey, E. Z. 1976. Hortus third. Revised. MacMillan, New York, N.Y., USA. 1290 pp.

Boivin, B. 1966, 1967. Énumération des plantes du Canada. Provencheria 6. Nat. Can. (Que.) 93: 253-274; 371-437; 583-646; 989-1063. 94: 131-157; 471-528; 625-655.

Image or illustration

Ornithogalum umbellatum:

Images: images.google.com

Toxic parts:

bulbs
flowers

References:

Lampe, K. F., McCann, M. A. 1985. AMA Handbook of poisonous and injurious plants. American Medical Assoc. Chicago, Ill., USA. 432 pp.

Notes on Toxic plant chemicals:

Two digitalis-like glycosides, convallatoxin and convalloside, are found through the plant but are concentrated in the bulbs and the flowers (Lampe and McCann 1985).

Toxic plant chemicals:

convallatoxin
convalloside

References:

Lampe, K. F., McCann, M. A. 1985. AMA Handbook of poisonous and injurious plants. American Medical Assoc. Chicago, Ill., USA. 432 pp.

Animals/Human Poisoning:

Note: When an animal is listed without additional information, the literature (as of 1993) contained no detailed explanation.

Humans

General symptoms of poisoning:

[diarrhea](#)

[nausea](#)

Notes on poisoning:

Symptoms of ingestion include pain in the mouth, nausea, abdominal pain, and diarrhea. Stomach lavage or use of emetics is recommended (Cooper and Johnson 1984, Lampe and McCann 1985).

References:

Cooper, M. R., Johnson, A. W. 1984. Poisonous plants in Britain and their effects on animals and man. Her Majesty's Stationery Office, London, England. 305 pp.

Lampe, K. F., McCann, M. A. 1985. AMA Handbook of

poisonous and injurious plants. American Medical Assoc.
Chicago, Ill., USA. 432 pp.

[Another search?](#)

[Français](#) | [Contact Us](#) | [Help](#) | [Search](#) | [Canada site](#)

[Coming Events](#) | [About CBIF](#) | [Links](#) | [Reports and Publications](#) |

[Home](#)

Date modified: 2003-02-06

[Important Notices](#)



Français	Contact us	Help	Search	Canada site
Coming events	About CBIF	Links	Reports and publications	Home

Canadian Biodiversity Information Facility



Notes on poisoning: *Oxytropis lambertii*

[Introduction](#)[Interactive](#)[All poisonous plants by Botanical name](#)[All poisonous plants by Common name](#)[Important WWW Poisonous Plants sites](#)

General poisoning notes:

Purple locoweed (*Oxytropis lambertii*) is found in the southern parts of Manitoba and Saskatchewan. This species can cause locoism, a chronic disease that results after long-term grazing. The plant contains swainsonine, an alkaloid, which results in cellular dysfunction through a long biological process. Affected animals show nervous system impairment, with symptoms such as dullness and excitement, as well as immune system impairment. Abortion and congenital birth deformities may occur. Animals affected include cattle, horses, and sheep. Animals may become habituated to locoweed. Death can result (James 1983, Cheeke and Schull 1985).

References:

Cheeke, P. R., Shull, L. R. 1985. Natural toxicants in feeds and poisonous plants. AVI Publishing Company, Inc., Westport, Conn., USA. 492 pp.

James, L. F. 1983. Neurotoxins and other toxins from *Astragalus* and related genera. Pages 445-462 in Keeler, R. F., Tu, A. T., eds. Handbook of natural toxins. Vol. 1. Plant and Fungal toxins. Marcel Dekker, Inc., New York, N.Y., USA. 934 pp.

Nomenclature:

Scientific Name: *Oxytropis lambertii* Pursh

Vernacular name(s): purple locoweed

Scientific family name: *Leguminosae*

Vernacular family name: pea

Go to ITIS*^{ca} for more taxonomic information on: [Oxytropis lambertii](#)

References:

Agriculture Quebec. 1975. Noms des maladies des plantes du Canada/ Names of plant diseases in Canada. , Quebec City, Que., Canada. 288 pp.

Alex, J. F., Cayouette, R., Mulligan, G. A. 1980. Common and botanical names of weeds in Canada/Noms populaire et scientifiques des plantes nuisibles du Canada. Revised. Agric. Can. Publ., Ottawa, Ont., Canada. 132 pp.

Bailey, L. H., Bailey, E. Z. 1976. Hortus third. Revised. MacMillan, New York, N.Y., USA. 1290 pp.

Scoggan, H. J. 1978, 1979. The flora of Canada. Nat. Mus. Nat. Sci. (Ottawa) Publ. Bot. 7(1)-7(4). 1711 pp.

Van Wijk, H. L. 1911. A dictionary of plant names. Martinus Nijhoff, The Hague, The Netherlands. 1444 pp.

Victorin, M. 1964. Flore Laurentienne. 2nd ed. Univ. Montreal, Montreal, Que., Canada. 952 pp.

Geographic Information

Manitoba
Saskatchewan

References:

Bailey, L. H., Bailey, E. Z. 1976. Hortus third. Revised. MacMillan, New York, N.Y., USA. 1290 pp.

Boivin, B. 1966, 1967. Énumération des plantes du Canada. Provencheria 6. Nat. Can. (Que.) 93: 253-274; 371-437; 583-646; 989-1063. 94: 131-157; 471-528; 625-655.

Image or illustration

Oxytropis lambertii:

Images: images.google.com

Notes on Poisonous plant parts:

The blooms of locoweeds contain more swainsonine than the leaves. The immature pods contain less swainsonine than the blooms, but this amount increases with the maturity of the seeds (Ralphs et al. 1986).

Toxic parts:

flowers
leaves
mature fruit

References:

James, L. F. 1983. Neurotoxins and other toxins from *Astragalus* and related genera. Pages 445-462 in Keeler, R. F., Tu, A. T., eds. Handbook of natural toxins. Vol. 1. Plant and Fungal toxins. Marcel Dekker, Inc., New York, N.Y., USA. 934 pp.

Ralphs, M. H., James, L. F., Pfister, J. A. 1986. Utilization of white locoweed (*Oxytropis sericea* Nutt.) by range cattle. J. Range Manage., 39: 344-347.

Notes on Toxic plant chemicals:

Swainsonine, an indolizidine alkaloid, inhibits alpha-mannosidase in the animal's body, which results in eventual disruption of cellular function when inhibited (Cheeke and Schull 1985).

Toxic plant chemicals:

swainsonine

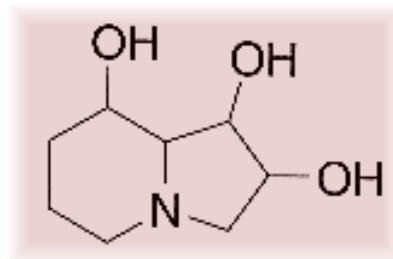

Chemical diagram(s) are courtesy of [Ruth McDiarmid](#), Biochemistry Technician, Kamloops Range Station, Agriculture and Agri-Food Canada, Kamloops, British Columbia, Canada.

References:

James, L. F. 1983. Neurotoxins and other toxins from *Astragalus* and related genera. Pages 445-462 in Keeler, R. F., Tu, A. T., eds. Handbook of natural toxins. Vol. 1. Plant and Fungal toxins. Marcel Dekker, Inc., New York, N.Y., USA. 934 pp.

Animals/Human Poisoning:

Note: When an animal is listed without additional information,

the literature (as of 1993) contained no detailed explanation.

Cattle

General symptoms of poisoning:

[abortion](#)

[agitation](#)

[carpal joint, flexure](#)

[death](#)

[depression](#)

References:

Cheeke, P. R., Shull, L. R. 1985. Natural toxicants in feeds and poisonous plants. AVI Publishing Company, Inc., Westport, Conn., USA. 492 pp.

James, L. F. 1983. Neurotoxins and other toxins from *Astragalus* and related genera. Pages 445-462 in Keeler, R. F., Tu, A. T., eds. Handbook of natural toxins. Vol. 1. Plant and Fungal toxins. Marcel Dekker, Inc., New York, N.Y., USA. 934 pp.

Horses

General symptoms of poisoning:

[agitation](#)

[death](#)

[depression](#)

References:

Cheeke, P. R., Shull, L. R. 1985. Natural toxicants in feeds and poisonous plants. AVI Publishing Company, Inc., Westport, Conn., USA. 492 pp.

Sheep

General symptoms of poisoning:

[abortion](#)

[agitation](#)

[carpal joint, flexure](#)

[death](#)

[incoordination](#)

References:

Cheeke, P. R., Shull, L. R. 1985. Natural toxicants in feeds and poisonous plants. AVI Publishing Company, Inc., Westport, Conn., USA. 492 pp.

[Another search?](#)

[Français](#) | [Contact Us](#) | [Help](#) | [Search](#) | [Canada site](#)

[Coming Events](#) | [About CBIF](#) | [Links](#) | [Reports and Publications](#) |

[Home](#)

Date modified: 2003-02-06

[Important Notices](#)



Français	Contact us	Help	Search	Canada site
Coming events	About CBIF	Links	Reports and publications	Home

Canadian Biodiversity Information Facility



Notes on poisoning: *Oxytropis sericea*

[Introduction](#)[Interactive](#)[All poisonous plants by Botanical name](#)[All poisonous plants by Common name](#)[Important WWW Poisonous Plants sites](#)

General poisoning notes:

Locoweed (*Oxytropis sericea*) is a native herb in western Canada. This plant has caused a number of problems in cattle, horses, and sheep. Swainsonine, an indolizidine alkaloid, inhibits alpha-mannosidase in animal bodies, which can lead to disruption of cellular function. Locoism is a chronic disease that causes depression, incoordination, and nervousness under stress. Death can result. The cellular problems occur most readily in tissues of the nervous system. Pregnant animals often abort or give birth to young with congenital deformities. Congestive right heart disease occurs at high altitudes (above 2190 m) in cattle. Right ventricular hypertrophy and dilation, subcutaneous edema, and pulmonary hypertension are significant symptoms (James 1983, Cheeke and Schull 1985, James et al. 1986, Panter et al. 1988).

References:

Cheeke, P. R., Shull, L. R. 1985. Natural toxicants in feeds and poisonous plants. AVI Publishing Company, Inc., Westport, Conn., USA. 492 pp.

James, L. F., Hartley, W. J., Nielsen, D., Allen, S., Panter, K. E. 1986. Locoweed (*Oxytropis sericea*) poisoning and congestive heart failure in cattle. J. Am. Vet. Med. Assoc., 189: 1549-1556.

James, L. F. 1983. Neurotoxins and other toxins from *Astragalus* and related genera. Pages 445-462 in Keeler, R. F., Tu, A. T., eds. Handbook of natural toxins. Vol. 1. Plant and Fungal toxins. Marcel Dekker, Inc., New York, N.Y., USA. 934 pp.

Panter, K. E., James, L. F., Nielson, D., Molyneux, R. J., Ralphs, M. H. 1988. The relationship of *Oxytropis sericea* (green and dry) and *Astragalus lentiginosus* with high mountain disease in cattle. Vet. Hum. Toxicol., 30: 318-323.

Ralphs, M. H., James, L. F., Nielsen, D. B., Panter, K. E. 1984.

Management practices reduce cattle loss to locoweed on high mountain range. *Rangelands*, 6: 175-177.

Ralphs, M. H., James, L. F., Pfister, J. A. 1986. Utilization of white locoweed (*Oxytropis sericea* Nutt.) by range cattle. *J. Range Manage.*, 39: 344-347.

Nomenclature:

Scientific Name: *Oxytropis sericea* Nutt.

Vernacular name(s): locoweed (*Oxytropis sericea*)

Scientific family name: *Leguminosae*

Vernacular family name: pea

Go to ITIS^{*ca} for more taxonomic information on: [Oxytropis sericea](#)

References:

Agriculture Quebec. 1975. Noms des maladies des plantes du Canada/ Names of plant diseases in Canada. , Quebec City, Que., Canada. 288 pp.

Alex, J. F., Cayouette, R., Mulligan, G. A. 1980. Common and botanical names of weeds in Canada/Noms populaire et scientifiques des plantes nuisibles du Canada. Revised. Agric. Can. Publ., Ottawa, Ont., Canada. 132 pp.

Bailey, L. H., Bailey, E. Z. 1976. Hortus third. Revised. MacMillan, New York, N.Y., USA. 1290 pp.

Scoggan, H. J. 1978, 1979. The flora of Canada. Nat. Mus. Nat. Sci. (Ottawa) Publ. Bot. 7(1)-7(4). 1711 pp.

Van Wijk, H. L. 1911. A dictionary of plant names. Martinus Nijhoff, The Hague, The Netherlands. 1444 pp.

Victorin, M. 1964. Flore Laurentienne. 2nd ed. Univ. Montreal, Montreal, Que., Canada. 952 pp.

Geographic Information

Alberta
British Columbia
Saskatchewan
Yukon Territory

References:

Bailey, L. H., Bailey, E. Z. 1976. Hortus third. Revised.

MacMillan, New York, N.Y., USA. 1290 pp.

Boivin, B. 1966, 1967. Énumération des plantes du Canada. Provencheria 6. Nat. Can. (Que.) 93: 253-274; 371-437; 583-646; 989-1063. 94: 131-157; 471-528; 625-655.

Image or illustration

Oxytropis sericea:

Images: images.google.com

Notes on Poisonous plant parts:

The blooms and mature fruit of locoweed have higher quantities of the toxin swainsonine than do the leaves. The concentration of this toxin remains constant in leaves throughout the grazing season (Ralphs et al. 1986.)

Toxic parts:

flowers
leaves
mature fruit
seeds
stems

References:

James, L. F., Hartley, W. J., Nielsen, D., Allen, S., Panter, K. E. 1986. Locoweed (*Oxytropis sericea*) poisoning and congestive heart failure in cattle. J. Am. Vet. Med. Assoc., 189: 1549-1556.

James, L. F. 1983. Neurotoxins and other toxins from *Astragalus* and related genera. Pages 445-462 in Keeler, R. F., Tu, A. T., eds. Handbook of natural toxins. Vol. 1. Plant and Fungal toxins. Marcel Dekker, Inc., New York, N.Y., USA. 934 pp.

Panter, K. E., James, L. F., Nielson, D., Molyneux, R. J., Ralphs, M. H. 1988. The relationship of *Oxytropis sericea* (green and dry) and *Astragalus lentiginosus* with high mountain disease in cattle. Vet. Hum. Toxicol., 30: 318-323.

Ralphs, M. H., James, L. F., Nielsen, D. B., Panter, K. E. 1984. Management practices reduce cattle loss to locoweed on high mountain range. Rangelands, 6: 175-177.

Ralphs, M. H., James, L. F., Pfister, J. A. 1986. Utilization of white locoweed (*Oxytropis sericea* Nutt.) by range cattle. J. Range Manage., 39: 344-347.

Notes on Toxic plant chemicals:

Swainsonine, an indolizidine alkaloid, inhibits alpha-mannosidase in the animal's body. Inhibition results in the accumulation of oligosaccharides in cells because glycosidases remove their respective sugars until a mannose residue is reached. Hydrolysis of the carbohydrate then stops. Eventually disruption of cellular function results. The effect of swainsonine on alpha-mannosidase is reversible when locoweed is no longer consumed. However, advanced clinical signs are irreversible because axon degeneration occurs. The central nervous system is most sensitive to mannose accumulation (Cheeke and Schull 1985).

Toxic plant chemicals:

slaframine

swainsonine

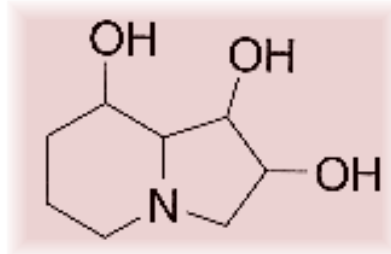

Chemical diagram(s) are courtesy of [Ruth McDiarmid](#), Biochemistry Technician, Kamloops Range Station, Agriculture and Agri-Food Canada, Kamloops, British Columbia, Canada.

References:

Cheeke, P. R., Shull, L. R. 1985. Natural toxicants in feeds and poisonous plants. AVI Publishing Company, Inc., Westport, Conn., USA. 492 pp.

Molyneux, R. J., James, L. F. 1982. Loco intoxication: indolizidine alkaloids of spotted locoweed (*Astragalus lentiginosus*). Science (Wash. D. C.), 216: 190-191.

Ralphs, M. H., James, L. F., Pfister, J. A. 1986. Utilization of white locoweed (*Oxytropis sericea* Nutt.) by range cattle. J. Range Manage., 39: 344-347.

Animals/Human Poisoning:

Note: When an animal is listed without additional information, the literature (as of 1993) contained no detailed explanation.

Cattle

General symptoms of poisoning:

[abdominal edema](#)

[belligerence](#)

[coat, rough and dry](#)

[death](#)

[depression](#)

[diarrhea](#)

[duodenum, edema of](#)

[eyes, dull](#)

[gall bladder, enlarged](#)

[incoordination](#)

[jaw \(lower\), edema of](#)

[thorax \(ventral\),edema](#)

[throat, edema of](#)

[ventricular\(right\),edema](#)

References:

Cheeke, P. R., Shull, L. R. 1985. Natural toxicants in feeds and poisonous plants. AVI Publishing Company, Inc., Westport, Conn., USA. 492 pp.

James, L. F., Hartley, W. J., Nielsen, D., Allen, S., Panter, K. E. 1986. Locoweed (*Oxytropis sericea*) poisoning and congestive heart failure in cattle. J. Am. Vet. Med. Assoc., 189: 1549-1556.

Panter, K. E., James, L. F., Nielson, D., Molyneux, R. J., Ralphs, M. H. 1988. The relationship of *Oxytropis sericea* (green and dry) and *Astragalus lentiginosus* with high mountain disease in cattle. Vet. Hum. Toxicol., 30: 318-323.

Ralphs, M. H., James, L. F., Nielsen, D. B., Panter, K. E. 1984. Management practices reduce cattle loss to locoweed on high mountain range. Rangelands, 6: 175-177.

Horses

General symptoms of poisoning:

[arthrogryposis](#)

[coat, rough and dry](#)

[depression](#)

[gait, unsteady](#)

[incoordination](#)

[nervousness](#)

References:

James, L. F. 1983. Neurotoxins and other toxins from *Astragalus* and related genera. Pages 445-462 in Keeler, R. F., Tu, A. T., eds. Handbook of natural toxins. Vol. 1. Plant and Fungal toxins. Marcel Dekker, Inc., New York, N.Y., USA. 934 pp.

Sheep

General symptoms of poisoning:

[abortion](#)

[carpal joint, flexure](#)

[coat, rough and dry](#)

[death](#)

[depression](#)

[eyes, dull](#)

[incoordination](#)

[nervousness](#)

[recumbency](#)

References:

Cheeke, P. R., Shull, L. R. 1985. Natural toxicants in feeds and poisonous plants. AVI Publishing Company, Inc., Westport, Conn., USA. 492 pp.

[Another search?](#)

[Français](#) | [Contact Us](#) | [Help](#) | [Search](#) | [Canada site](#)

[Coming Events](#) | [About CBIF](#) | [Links](#) | [Reports and Publications](#) | [Home](#)

Date modified: 2003-02-06

[Important Notices](#)



Français	Contact us	Help	Search	Canada site
Coming events	About CBIF	Links	Reports and publications	Home

Canadian Biodiversity Information Facility



Notes on poisoning: *Papaver nudicaule*

[Introduction](#)[Interactive](#)[All poisonous plants by Botanical name](#)[All poisonous plants by Common name](#)[Important WWW Poisonous Plants sites](#)

General poisoning notes:

Iceland poppy (*Papaver nudicaule*) is an ornamental outdoor plant that occasionally escapes from cultivation. The plant contains alkaloids that may cause problems in animals that ingest it. Horses, cattle, and sheep were poisoned when discarded plants were given to livestock (Cooper and Johnson 1984).



References:

Cooper, M. R., Johnson, A. W. 1984. Poisonous plants in Britain and their effects on animals and man. Her Majesty's Stationery Office, London, England. 305 pp.

Kingsbury, J. M. 1964. Poisonous plants of the United States and Canada. Prentice-Hall Inc., Englewood Cliffs, N.J., USA. 626 pp.

Nomenclature:

Scientific Name: *Papaver nudicaule* L.

Vernacular name(s): Iceland poppy

Scientific family name: *Papaveraceae*

Vernacular family name: poppy

Go to ITIS^{*ca} for more taxonomic information on: [Papaver nudicaule](#)

References:

Agriculture Quebec. 1975. Noms des maladies des plantes du Canada/ Names of plant diseases in Canada. , Quebec City, Que., Canada. 288 pp.

Alex, J. F., Cayouette, R., Mulligan, G. A. 1980. Common and

botanical names of weeds in Canada/Noms populaire et scientifiques des plantes nuisibles du Canada. Revised. Agric. Can. Publ., Ottawa, Ont., Canada. 132 pp.

Bailey, L. H., Bailey, E. Z. 1976. Hortus third. Revised. MacMillan, New York, N.Y., USA. 1290 pp.

Scoggan, H. J. 1978, 1979. The flora of Canada. Nat. Mus. Nat. Sci. (Ottawa) Publ. Bot. 7(1)-7(4). 1711 pp.

Van Wijk, H. L. 1911. A dictionary of plant names. Martinus Nijhoff, The Hague, The Netherlands. 1444 pp.

Victorin, M. 1964. Flore Laurentienne. 2nd ed. Univ. Montreal, Montreal, Que., Canada. 952 pp.

Geographic Information

Plant or plant parts used in or around the home.

References:

Bailey, L. H., Bailey, E. Z. 1976. Hortus third. Revised. MacMillan, New York, N.Y., USA. 1290 pp.

Boivin, B. 1966, 1967. Énumération des plantes du Canada. Provencheria 6. Nat. Can. (Que.) 93: 253-274; 371-437; 583-646; 989-1063. 94: 131-157; 471-528; 625-655.

Image or illustration

Papaver nudicaule:

Images: images.google.com

Toxic parts:

all parts
plant juices

References:

Kingsbury, J. M. 1964. Poisonous plants of the United States and Canada. Prentice-Hall Inc., Englewood Cliffs, N.J., USA. 626 pp.

Notes on Toxic plant chemicals:

Physiological alkaloids have been found in Iceland poppy (Kingsbury 1964).

Toxic plant chemicals:

unknown chemical

References:

Kingsbury, J. M. 1964. Poisonous plants of the United States and Canada. Prentice-Hall Inc., Englewood Cliffs, N.J., USA. 626 pp.

Animals/Human Poisoning:

Note: When an animal is listed without additional information, the literature (as of 1993) contained no detailed explanation.

Cattle

General symptoms of poisoning:

[bloat](#)

[incoordination](#)

[muscle spasms](#)

[muscle twitching](#)

[nervousness](#)

[recumbency](#)

[restlessness](#)

Notes on poisoning:

Symptoms are similar in all species that have been poisoned, including initial restlessness and excitement followed by incoordination, spasms, falling, and bloat in some cases. Milk yield may be reduced (Cooper and Johnson 1984).

References:

Cooper, M. R., Johnson, A. W. 1984. Poisonous plants in Britain and their effects on animals and man. Her Majesty's Stationery Office, London, England. 305 pp.

Horses

General symptoms of poisoning:

[bloat](#)

[incoordination](#)

[muscle spasms](#)

[muscle twitching](#)

[nervousness](#)

[recumbency](#)

Notes on poisoning:

Symptoms of poisoning include restlessness, incoordination, stiffness, muscular twitching, falling, and bloat. This poppy has rarely proved fatal (Cooper and Johnson 1984).

References:

Cooper, M. R., Johnson, A. W. 1984. Poisonous plants in Britain and their effects on animals and man. Her Majesty's Stationery Office, London, England. 305 pp.

Sheep

General symptoms of poisoning:

[bloat](#)

[incoordination](#)

[muscle spasms](#)

[nervousness](#)

[recumbency](#)

Notes on poisoning:

Symptoms include restlessness, incoordination, muscular twitching, and falling down. Milk yield can remain depressed for long periods (Cooper and Johnson 1984).

References:

Cooper, M. R., Johnson, A. W. 1984. Poisonous plants in Britain and their effects on animals and man. Her Majesty's Stationery Office, London, England. 305 pp.

[Another search?](#)

[Français](#) | [Contact Us](#) | [Help](#) | [Search](#) | [Canada site](#)

[Coming Events](#) | [About CBIF](#) | [Links](#) | [Reports and Publications](#) |

[Home](#)

Date modified: 2003-02-06

[Important Notices](#)



Français	Contact us	Help	Search	Canada site
Coming events	About CBIF	Links	Reports and publications	Home

Canadian Biodiversity Information Facility



Notes on poisoning: *Papaver orientale*

[Introduction](#)[Interactive](#)[All poisonous plants by Botanical name](#)[All poisonous plants by Common name](#)[Important WWW Poisonous Plants sites](#)

General poisoning notes:

Oriental poppy (*Papaver orientale*) is a perennial ornamental herb that is commonly planted in flower beds. This plant contains some alkaloidal chemicals that may be physiologically active in animals, but no cases of poisoning have occurred under natural conditions. During fall and spring clean-up, all old flower heads and pods should be picked up so that they are not left for animals to eat (Kingsbury 1964).

References:

Kingsbury, J. M. 1964. Poisonous plants of the United States and Canada. Prentice-Hall Inc., Englewood Cliffs, N.J., USA. 626 pp.

Nomenclature:

Scientific Name: *Papaver orientale* L.

Vernacular name(s): Oriental poppy

Scientific family name: *Papaveraceae*

Vernacular family name: poppy

Go to ITIS*^{ca} for more taxonomic information on: [Papaver orientale](#)

References:

Agriculture Quebec. 1975. Noms des maladies des plantes du Canada/ Names of plant diseases in Canada. , Quebec City, Que., Canada. 288 pp.

Alex, J. F., Cayouette, R., Mulligan, G. A. 1980. Common and botanical names of weeds in Canada/Noms populaire et scientifiques des plantes nuisibles du Canada. Revised. Agric.

Can. Publ., Ottawa, Ont., Canada. 132 pp.

Bailey, L. H., Bailey, E. Z. 1976. Hortus third. Revised. MacMillan, New York, N.Y., USA. 1290 pp.

Scoggan, H. J. 1978, 1979. The flora of Canada. Nat. Mus. Nat. Sci. (Ottawa) Publ. Bot. 7(1)-7(4). 1711 pp.

Van Wijk, H. L. 1911. A dictionary of plant names. Martinus Nijhoff, The Hague, The Netherlands. 1444 pp.

Victorin, M. 1964. Flore Laurentienne. 2nd ed. Univ. Montreal, Montreal, Que., Canada. 952 pp.

Geographic Information

Plant or plant parts used in or around the home.

References:

Bailey, L. H., Bailey, E. Z. 1976. Hortus third. Revised. MacMillan, New York, N.Y., USA. 1290 pp.

Boivin, B. 1966, 1967. Énumération des plantes du Canada. Provencheria 6. Nat. Can. (Que.) 93: 253-274; 371-437; 583-646; 989-1063. 94: 131-157; 471-528; 625-655.

Image or illustration

Papaver orientale:

Images: images.google.com

Toxic parts:

all parts
plant juices

References:

Kingsbury, J. M. 1964. Poisonous plants of the United States and Canada. Prentice-Hall Inc., Englewood Cliffs, N.J., USA. 626 pp.

Notes on Toxic plant chemicals:

Some alkaloidal chemicals that may be physiologically active have been found in Oriental poppy (Kingsbury 1964).

Toxic plant chemicals:

unknown chemical

References:

Cooper, M. R., Johnson, A. W. 1984. Poisonous plants in Britain and their effects on animals and man. Her Majesty's Stationery Office, London, England. 305 pp.

Kingsbury, J. M. 1964. Poisonous plants of the United States and Canada. Prentice-Hall Inc., Englewood Cliffs, N.J., USA. 626 pp.

Animals/Human Poisoning:

Note: When an animal is listed without additional information, the literature (as of 1993) contained no detailed explanation.

Cattle

[Another search?](#)

[Français](#) | [Contact Us](#) | [Help](#) | [Search](#) | [Canada site](#)

[Coming Events](#) | [About CBIF](#) | [Links](#) | [Reports and Publications](#) |

[Home](#)

Date modified: 2003-02-06

[Important Notices](#)



Français	Contact us	Help	Search	Canada site
Coming events	About CBIF	Links	Reports and publications	Home

Canadian Biodiversity Information Facility



Notes on poisoning: *Papaver rhoeas*

[Introduction](#)[Interactive](#)[All poisonous plants by Botanical name](#)[All poisonous plants by Common name](#)[Important WWW Poisonous Plants sites](#)

General poisoning notes:

Corn poppy (*Papaver rhoeas*) is an ornamental herb that has become naturalized in some provinces. This plant has poisoned cattle according to early European literature. No recent cases have been described, but the plant may be potentially poisonous if animals ingest it (Cooper and Johnson 1984).



References:

Cooper, M. R., Johnson, A. W. 1984. Poisonous plants in Britain and their effects on animals and man. Her Majesty's Stationery Office, London, England. 305 pp.

Nomenclature:

Scientific Name: *Papaver rhoeas* L.

Vernacular name(s): corn poppy

Scientific family name: *Papaveraceae*

Vernacular family name: poppy

Go to ITIS^{*ca} for more taxonomic information on: [Papaver rhoeas](#)

References:

Agriculture Quebec. 1975. Noms des maladies des plantes du Canada/ Names of plant diseases in Canada. , Quebec City, Que., Canada. 288 pp.

Alex, J. F., Cayouette, R., Mulligan, G. A. 1980. Common and botanical names of weeds in Canada/Noms populaire et scientifiques des plantes nuisibles du Canada. Revised. Agric. Can. Publ., Ottawa, Ont., Canada. 132 pp.

Bailey, L. H., Bailey, E. Z. 1976. Hortus third. Revised. MacMillan, New York, N.Y., USA. 1290 pp.

Scoggan, H. J. 1978, 1979. The flora of Canada. Nat. Mus. Nat. Sci. (Ottawa) Publ. Bot. 7(1)-7(4). 1711 pp.

Van Wijk, H. L. 1911. A dictionary of plant names. Martinus Nijhoff, The Hague, The Netherlands. 1444 pp.

Victorin, M. 1964. Flore Laurentienne. 2nd ed. Univ. Montreal, Montreal, Que., Canada. 952 pp.

Geographic Information

Plant or plant parts used in or around the home.

References:

Bailey, L. H., Bailey, E. Z. 1976. Hortus third. Revised. MacMillan, New York, N.Y., USA. 1290 pp.

Boivin, B. 1966, 1967. Énumération des plantes du Canada. Provencheria 6. Nat. Can. (Que.) 93: 253-274; 371-437; 583-646; 989-1063. 94: 131-157; 471-528; 625-655.

Image or illustration

Papaver rhoeas:

Images: images.google.com

Toxic parts:

all parts
plant juices

References:

Cooper, M. R., Johnson, A. W. 1984. Poisonous plants in Britain and their effects on animals and man. Her Majesty's Stationery Office, London, England. 305 pp.

Notes on Toxic plant chemicals:

Rhoadine, an alkaloid, and other alkaloids are found in corn poppy (Cooper and Johnson 1984).

Toxic plant chemicals:

rhoadine

References:

Cooper, M. R., Johnson, A. W. 1984. Poisonous plants in Britain and their effects on animals and man. Her Majesty's Stationery Office, London, England. 305 pp.

Animals/Human Poisoning:

Note: When an animal is listed without additional information, the literature (as of 1993) contained no detailed explanation.

Cattle

General symptoms of poisoning:

[incoordination](#)

[recumbency](#)

[restlessness](#)

Notes on poisoning:

Symptoms of poisoning are similar to those caused by other poppy species, including restlessness, incoordination, muscle spasms, and falling down (Cooper and Johnson 1984).

References:

Cooper, M. R., Johnson, A. W. 1984. Poisonous plants in Britain and their effects on animals and man. Her Majesty's Stationery Office, London, England. 305 pp.

[Another search?](#)

[Français](#) | [Contact Us](#) | [Help](#) | [Search](#) | [Canada site](#)

[Coming Events](#) | [About CBIF](#) | [Links](#) | [Reports and Publications](#) |

[Home](#)

Date modified: 2003-02-06

[Important Notices](#)



Français	Contact us	Help	Search	Canada site
Coming events	About CBIF	Links	Reports and publications	Home

Canadian Biodiversity Information Facility



Notes on poisoning: Papaver somniferum

[Introduction](#)[Interactive](#)[All poisonous plants by Botanical name](#)[All poisonous plants by Common name](#)[Important WWW Poisonous Plants sites](#)

General poisoning notes:

Opium poppy (*Papaver somniferum*) is an ornamental flower that can still be found around some older homes. The plant persists by setting seed each year. This plant is the source of pharmacological and recreational drugs, as well as the poppy seeds that are used for oil and as a condiment on bagels, cakes, and other foods. Cattle have been poisoned in Europe after ingesting either stalks with pods that were being discarded or seed residue left over from oil extraction. Humans are either poisoned or addicted by various contained and derived chemicals found in the opium poppy (Frohne and Pfander 1983, Cooper and Johnson 1984). It is important to note that poppy seeds sold in stores are harmless, as the toxins have been destroyed by heat (Fuller and McClintock 1986).

References:

Cooper, M. R., Johnson, A. W. 1984. Poisonous plants in Britain and their effects on animals and man. Her Majesty's Stationery Office, London, England. 305 pp.

Frohne, D., Pfander, H. J. 1983. A colour atlas of poisonous plants. Wolfe Publishing Ltd., London, England. 291 pp.

Fuller, T. C., McClintock, E. 1986. Poisonous plants of California. Univ. California Press, Berkeley, Calif., USA. 432 pp.

Nomenclature:

Scientific Name: *Papaver somniferum* L.

Vernacular name(s): opium poppy

Scientific family name: *Papaveraceae*

Vernacular family name: poppy

Go to ITIS^{*ca} for more taxonomic information on: [Papaver somniferum](#)

References:

Agriculture Quebec. 1975. Noms des maladies des plantes du Canada/ Names of plant diseases in Canada. , Quebec City, Que., Canada. 288 pp.

Alex, J. F., Cayouette, R., Mulligan, G. A. 1980. Common and botanical names of weeds in Canada/Noms populaire et scientifiques des plantes nuisibles du Canada. Revised. Agric. Can. Publ., Ottawa, Ont., Canada. 132 pp.

Bailey, L. H., Bailey, E. Z. 1976. Hortus third. Revised. MacMillan, New York, N.Y., USA. 1290 pp.

Scoggan, H. J. 1978, 1979. The flora of Canada. Nat. Mus. Nat. Sci. (Ottawa) Publ. Bot. 7(1)-7(4). 1711 pp.

Van Wijk, H. L. 1911. A dictionary of plant names. Martinus Nijhoff, The Hague, The Netherlands. 1444 pp.

Victorin, M. 1964. Flore Laurentienne. 2nd ed. Univ. Montreal, Montreal, Que., Canada. 952 pp.

Geographic Information

Plant or plant parts used in or around the home.

References:

Bailey, L. H., Bailey, E. Z. 1976. Hortus third. Revised. MacMillan, New York, N.Y., USA. 1290 pp.

Boivin, B. 1966, 1967. Énumération des plantes du Canada. Provencheria 6. Nat. Can. (Que.) 93: 253-274; 371-437; 583-646; 989-1063. 94: 131-157; 471-528; 625-655.

Image or illustration

Papaver somniferum:

Images: images.google.com

Toxic parts:

all parts
immature fruit
plant juices

References:

Cooper, M. R., Johnson, A. W. 1984. Poisonous plants in Britain and their effects on animals and man. Her Majesty's Stationery Office, London, England. 305 pp.

Notes on Toxic plant chemicals:

Opium poppy contains a crude resin, opium, that is found throughout the plant but is concentrated in the unripe seed pod in the milky sap. Medicinal drugs, such as morphine and codeine, as well as other alkaloids, such as papaverine and protopine, are found in opium poppy (Cooper and Johnson 1984).

Toxic plant chemicals:

codine
morphine
protopine

References:

Cooper, M. R., Johnson, A. W. 1984. Poisonous plants in Britain and their effects on animals and man. Her Majesty's Stationery Office, London, England. 305 pp.

Animals/Human Poisoning:

Note: When an animal is listed without additional information, the literature (as of 1993) contained no detailed explanation.

Cattle

General symptoms of poisoning:

[ataxia](#)
[breathing, rapid](#)
[gastroenteritis](#)
[nervousness](#)

Notes on poisoning:

Cattle that ingested plant material of opium poppy exhibited symptoms of restlessness and constant motion. Continuous lowing occurred. Feeding, rumination, and lactation ceased. Animals went into a deep sleep. Affected animals are an economic loss because of the slow recovery and reduced milk yield. Postmortem examination showed inflammation of the kidneys and intestines, with yellowing of the liver (Cooper and

Johnson 1984).

References:

Cooper, M. R., Johnson, A. W. 1984. Poisonous plants in Britain and their effects on animals and man. Her Majesty's Stationery Office, London, England. 305 pp.

Humans

General symptoms of poisoning:

[cyanosis](#)

[death by asphyxiation](#)

[eczema](#)

[headache](#)

[pupils, pinpoint](#)

[sweating](#)

References:

Cooper, M. R., Johnson, A. W. 1984. Poisonous plants in Britain and their effects on animals and man. Her Majesty's Stationery Office, London, England. 305 pp.

Frohne, D., Pfander, H. J. 1983. A colour atlas of poisonous plants. Wolfe Publishing Ltd., London, England. 291 pp.

Fuller, T. C., McClintock, E. 1986. Poisonous plants of California. Univ. California Press, Berkeley, Calif., USA. 432 pp.

[Another search?](#)

[Français](#) | [Contact Us](#) | [Help](#) | [Search](#) | [Canada site](#)

[Coming Events](#) | [About CBIF](#) | [Links](#) | [Reports and Publications](#) | [Home](#)

Date modified: 2003-02-06

[Important Notices](#)



Français	Contact us	Help	Search	Canada site
Coming events	About CBIF	Links	Reports and publications	Home

Canadian Biodiversity Information Facility



Notes on poisoning: *Parthenocissus* *quinquefolia*

[Introduction](#)[Interactive](#)[All poisonous plants by Botanical name](#)[All poisonous plants by Common name](#)[Important WWW Poisonous Plants sites](#)

General poisoning notes:

Virginia creeper (*Parthenocissus quinquefolia*) is a native climbing vine found in eastern Canada. It is also used as an ornamental climber on trellises and building walls. Children who ingested berries and leaves have reportedly been poisoned and have died. Some authors view these reports as circumstantial. However, this plant should be considered as potentially toxic if ingested (Warren 1912, Kingsbury 1964, Fuller and McClintock 1986).

References:

- Fuller, T. C., McClintock, E. 1986. Poisonous plants of California. Univ. California Press, Berkeley, Calif., USA. 432 pp.
- Kingsbury, J. M. 1964. Poisonous plants of the United States and Canada. Prentice-Hall Inc., Englewood Cliffs, N.J., USA. 626 pp.
- Warren, L. E. 1912. A note on the poisonous properties of *Parthenocissus quinquefolia*. Merck's Rep., 21: 123.

Nomenclature:

Scientific Name: *Parthenocissus quinquefolia* (L.) Planch.

Vernacular name(s): Virginia creeper

Scientific family name: *Vitaceae*

Vernacular family name: grape

Go to ITIS*^{ca} for more taxonomic information on: [Parthenocissus quinquefolia](#)

References:

Agriculture Quebec. 1975. Noms des maladies des plantes du Canada/ Names of plant diseases in Canada. , Quebec City, Que., Canada. 288 pp.

Alex, J. F., Cayouette, R., Mulligan, G. A. 1980. Common and botanical names of weeds in Canada/Noms populaire et scientifiques des plantes nuisibles du Canada. Revised. Agric. Can. Publ., Ottawa, Ont., Canada. 132 pp.

Bailey, L. H., Bailey, E. Z. 1976. Hortus third. Revised. MacMillan, New York, N.Y., USA. 1290 pp.

Scoggan, H. J. 1978, 1979. The flora of Canada. Nat. Mus. Nat. Sci. (Ottawa) Publ. Bot. 7(1)-7(4). 1711 pp.

Van Wijk, H. L. 1911. A dictionary of plant names. Martinus Nijhoff, The Hague, The Netherlands. 1444 pp.

Victorin, M. 1964. Flore Laurentienne. 2nd ed. Univ. Montreal, Montreal, Que., Canada. 952 pp.

Geographic Information

Ontario
Prince Edward Island
Quebec

References:

Bailey, L. H., Bailey, E. Z. 1976. Hortus third. Revised. MacMillan, New York, N.Y., USA. 1290 pp.

Boivin, B. 1966, 1967. Énumération des plantes du Canada. Provencheria 6. Nat. Can. (Que.) 93: 253-274; 371-437; 583-646; 989-1063. 94: 131-157; 471-528; 625-655.

Image or illustration

Parthenocissus quinquefolia:

Images: images.google.com

Toxic parts:

leaves
mature fruit

References:

Warren, L. E. 1912. A note on the poisonous properties of

Parthenocissus quinquefolia. Merck's Rep., 21: 123.

Notes on Toxic plant chemicals:

Raphide crystals of calcium oxalate have been reported in the leaves and berries of Virginia creeper. Fuller and McClintock (1986) stated that the quantities are small and that the irritant effect is usually not significant.

Toxic plant chemicals:

oxalate

References:

Fuller, T. C., McClintock, E. 1986. Poisonous plants of California. Univ. California Press, Berkeley, Calif., USA. 432 pp.

Warren, L. E. 1912. A note on the poisonous properties of *Parthenocissus quinquefolia*. Merck's Rep., 21: 123.

Animals/Human Poisoning:

Note: When an animal is listed without additional information, the literature (as of 1993) contained no detailed explanation.

Humans

General symptoms of poisoning:

[death](#)

[tenesmus](#)

[vomiting](#)

Notes on poisoning:

Cases have been reported of illness and death resulting after berries of Virginia creeper were ingested. In another case, two children became ill after swallowing the juice from chewed leaves. Symptoms included vomiting, purging, and tenesmus. The children collapsed and were in stupor for 2 h. A dozen ripe berries were fed to a guinea pig, which died within 36 h (Warren 1912). Modern reports view these cases as circumstantial. The amounts of oxalate contained in the plant is usually not significant (Kingsbury 1964, Fuller and McClintock 1986).

References:

Fuller, T. C., McClintock, E. 1986. Poisonous plants of

California. Univ. California Press, Berkeley, Calif., USA. 432 pp.

Kingsbury, J. M. 1964. Poisonous plants of the United States and Canada. Prentice-Hall Inc., Englewood Cliffs, N.J., USA. 626 pp.

Warren, L. E. 1912. A note on the poisonous properties of *Parthenocissus quinquefolia*. Merck's Rep., 21: 123.

[Another search?](#)

[Français](#) | [Contact Us](#) | [Help](#) | [Search](#) | [Canada site](#)

[Coming Events](#) | [About CBIF](#) | [Links](#) | [Reports and Publications](#) |

[Home](#)

Date modified: 2003-02-06

[Important Notices](#)



Français	Contact us	Help	Search	Canada site
Coming events	About CBIF	Links	Reports and publications	Home

Canadian Biodiversity Information Facility



Notes on poisoning: *Pastinaca sativa*

[Introduction](#)[Interactive](#)[All poisonous plants by Botanical name](#)[All poisonous plants by Common name](#)[Important WWW Poisonous Plants sites](#)

General poisoning notes:

Parsnip (*Pastinaca sativa*) is a cultivated and a naturalized herb in much of Canada. The plant juices can cause photodermatitis in some individuals after exposure to sunlight. Exposure to leaves, stems, and peeling roots can cause the problem. The edible roots contain enough furocoumarins to be physiologically active in some cases. These toxins are mutagenic (even in the dark) inducing melanization in human skin. Photodermatitis from this plant is often confused with poison-ivy dermatitis (Mitchell and Rook 1979, Ivie et al. 1981).

References:

Ivie, G. W., Holt, D. L., Ivey, M. C. 1981. Natural toxicants in human foods: psoralens in raw and cooked parsnip root. *Science* (Wash D. C.), 213: 909-910.

Mitchell, J. C., Rook, A. 1979. *Botanical dermatology*. Greenglass Ltd, Vancouver, B.C., Canada. 787 pp.

Nomenclature:

Scientific Name: *Pastinaca sativa* L.

Vernacular name(s): wild parsnip

Scientific family name: *Umbelliferae*

Vernacular family name: parsley

Go to ITIS^{*ca} for more taxonomic information on: [Pastinaca sativa](#)

References:

Agriculture Quebec. 1975. Noms des maladies des plantes du

Canada/ Names of plant diseases in Canada. , Quebec City, Que., Canada. 288 pp.

Alex, J. F., Cayouette, R., Mulligan, G. A. 1980. Common and botanical names of weeds in Canada/Noms populaire et scientifiques des plantes nuisibles du Canada. Revised. Agric. Can. Publ., Ottawa, Ont., Canada. 132 pp.

Bailey, L. H., Bailey, E. Z. 1976. Hortus third. Revised. MacMillan, New York, N.Y., USA. 1290 pp.

Scoggan, H. J. 1978, 1979. The flora of Canada. Nat. Mus. Nat. Sci. (Ottawa) Publ. Bot. 7(1)-7(4). 1711 pp.

Van Wijk, H. L. 1911. A dictionary of plant names. Martinus Nijhoff, The Hague, The Netherlands. 1444 pp.

Victorin, M. 1964. Flore Laurentienne. 2nd ed. Univ. Montreal, Montreal, Que., Canada. 952 pp.

Geographic Information

Alberta
British Columbia
Labrador
Manitoba
New Brunswick
Newfoundland
Nova Scotia
Ontario
Prince Edward Island
Quebec
Saskatchewan
Yukon Territory

References:

Bailey, L. H., Bailey, E. Z. 1976. Hortus third. Revised. MacMillan, New York, N.Y., USA. 1290 pp.

Boivin, B. 1966, 1967. Énumération des plantes du Canada. Provencheria 6. Nat. Can. (Que.) 93: 253-274; 371-437; 583-646; 989-1063. 94: 131-157; 471-528; 625-655.

Image or illustration

Pastinaca sativa:

Images: images.google.com

Notes on Poisonous plant parts:

Exposure to the plant juices in the leaves, stems, or roots can result in dermatitis caused by phototoxic furocoumarins. Wetness of the skin accentuates the results. Ingesting large quantities of parsnip root may expose people to sufficient quantities of psoralens to have physiological effects. Parsnips produce much higher concentrations of these toxins in response to disease infection (Mitchell and Rook 1979, Ivie et al. 1981).

Toxic parts:

plant juices
roots

References:

Ivie, G. W., Holt, D. L., Ivey, M. C. 1981. Natural toxicants in human foods: psoralens in raw and cooked parsnip root. *Science* (Wash D. C.), 213: 909-910.

Mitchell, J. C., Rook, A. 1979. *Botanical dermatology*. Greenglass Ltd, Vancouver, B.C., Canada. 787 pp.

Notes on Toxic plant chemicals:

Three furocoumarins (psoralen, xanthotoxin, bergapten) are found in parsnip roots. These chemicals are phototoxic, mutagenic, and photo-carcinogenic. The cumulative concentration is about 40 ppm. Consumption of 0.1 kg of parsnip could expose a person to 4-5 mg of psoralens, a level that may cause some physiological effects. These chemicals are potent photosensitizers and are highly mutagenic in long-wavelength ultraviolet light (Ivie et al. 1981).

Toxic plant chemicals:

furocoumarin

References:

Ivie, G. W., Holt, D. L., Ivey, M. C. 1981. Natural toxicants in human foods: psoralens in raw and cooked parsnip root. *Science* (Wash D. C.), 213: 909-910.

Animals/Human Poisoning:

Note: When an animal is listed without additional information,

the literature (as of 1993) contained no detailed explanation.

Humans

General symptoms of poisoning:

[blistering](#)

[erythema](#)

References:

Ivie, G. W., Holt, D. L., Ivey, M. C. 1981. Natural toxicants in human foods: psoralens in raw and cooked parsnip root. Science (Wash D. C.), 213: 909-910.

[Another search?](#)

[Français](#) | [Contact Us](#) | [Help](#) | [Search](#) | [Canada site](#)

[Coming Events](#) | [About CBIF](#) | [Links](#) | [Reports and Publications](#) | [Home](#)

Date modified: 2003-02-06

[Important Notices](#)



Français	Contact us	Help	Search	Canada site
Coming events	About CBIF	Links	Reports and publications	Home

Canadian Biodiversity Information Facility



Notes on poisoning: *Persea americana*

[Introduction](#)[Interactive](#)[All poisonous plants by Botanical name](#)[All poisonous plants by Common name](#)[Important WWW Poisonous Plants sites](#)

General poisoning notes:

Avocado (*Persea americana*) is a common exotic fruit. The seeds are often planted to produce foliage plants in households. In California, Guatemalan cultivars have caused toxic affects in cattle, goats, rabbits, canaries, and fish. Family pets should be prevented from ingesting the leaves. The seeds have caused toxicity and death in canaries and have experimentally poisoned mice. Leaves should not be allowed to fall accidentally into fish tanks (Hurt 1943, Fuller and McClintock 1986).

References:

Appleman, D. 1944. Preliminary report on toxicity of avocado leaves. Calif. Avocado Soc. Yearbook, 1944: 37.

Fuller, T. C., McClintock, E. 1986. Poisonous plants of California. Univ. California Press, Berkeley, Calif., USA. 432 pp.

Hurt, L. M. 1943. Avocado poisoning. LA. County Livestock Dep. Ann. Rep., 1943: 43-44.

Nomenclature:

Scientific Name: *Persea americana* Mill.

Vernacular name(s): avocado

Scientific family name: *Lauraceae*

Vernacular family name: laurel

Go to ITIS*^{ca} for more taxonomic information on: [Persea americana](#)

References:

Agriculture Quebec. 1975. Noms des maladies des plantes du Canada/ Names of plant diseases in Canada. , Quebec City, Que., Canada. 288 pp.

Alex, J. F., Cayouette, R., Mulligan, G. A. 1980. Common and botanical names of weeds in Canada/Noms populaire et scientifiques des plantes nuisibles du Canada. Revised. Agric. Can. Publ., Ottawa, Ont., Canada. 132 pp.

Bailey, L. H., Bailey, E. Z. 1976. Hortus third. Revised. MacMillan, New York, N.Y., USA. 1290 pp.

Scoggan, H. J. 1978, 1979. The flora of Canada. Nat. Mus. Nat. Sci. (Ottawa) Publ. Bot. 7(1)-7(4). 1711 pp.

Van Wijk, H. L. 1911. A dictionary of plant names. Martinus Nijhoff, The Hague, The Netherlands. 1444 pp.

Victorin, M. 1964. Flore Laurentienne. 2nd ed. Univ. Montreal, Montreal, Que., Canada. 952 pp.

Geographic Information

Plant or plant parts used in or around the home.

References:

Bailey, L. H., Bailey, E. Z. 1976. Hortus third. Revised. MacMillan, New York, N.Y., USA. 1290 pp.

Boivin, B. 1966, 1967. Énumération des plantes du Canada. Provencheria 6. Nat. Can. (Que.) 93: 253-274; 371-437; 583-646; 989-1063. 94: 131-157; 471-528; 625-655.

Image or illustration

Persea americana:

Images: images.google.com

Notes on Poisonous plant parts:

Ingesting the leaves, branches, or seeds has caused lung congestion and udder inflammation (Fuller and McClintock 1986).

Toxic parts:

leaves

seeds

twigs

References:

Fuller, T. C., McClintock, E. 1986. Poisonous plants of California. Univ. California Press, Berkeley, Calif., USA. 432 pp.

Toxic plant chemicals:

unknown chemical

References:

Fuller, T. C., McClintock, E. 1986. Poisonous plants of California. Univ. California Press, Berkeley, Calif., USA. 432 pp.

Animals/Human Poisoning:

Note: When an animal is listed without additional information, the literature (as of 1993) contained no detailed explanation.

Cattle

General symptoms of poisoning:

[mastitis](#)

Notes on poisoning:

Ingesting avocado leaves and bark has caused lung congestion, mastitis, tissue edema, milk reduction, and death (when large quantities of leaves were consumed). Other mammal species that were poisoned after ingesting avocado showed similar symptoms (Hurt 1943).

References:

Fuller, T. C., McClintock, E. 1986. Poisonous plants of California. Univ. California Press, Berkeley, Calif., USA. 432 pp.

Hurt, L. M. 1943. Avocado poisoning. LA. County Livestock Dep. Ann. Rep., 1943: 43-44.

Goats

General symptoms of poisoning:

[mastitis](#)

References:

Hurt, L. M. 1943. Avocado poisoning. LA. County Livestock Dep. Ann. Rep., 1943: 43-44.

Rabbits

General symptoms of poisoning:

[death](#)

[death by asphyxiation](#)

[mastitis](#)

Notes on poisoning:

Rabbits were poisoned when given access to avocado leaves. The rabbits developed mastitis and dried up. Experimental feeding of "Fuerte," a Guatemalan avocado cultivar, has caused poisoning and death in rabbits. Mexican cultivars have not caused poisoning (Hurt 1943, Appleman 1944).

References:

Appleman, D. 1944. Preliminary report on toxicity of avocado leaves. Calif. Avocado Soc. Yearbook, 1944: 37.

Hurt, L. M. 1943. Avocado poisoning. LA. County Livestock Dep. Ann. Rep., 1943: 43-44.

[Another search?](#)

[Français](#) | [Contact Us](#) | [Help](#) | [Search](#) | [Canada site](#)

[Coming Events](#) | [About CBIF](#) | [Links](#) | [Reports and Publications](#) |

[Home](#)

Date modified: 2003-02-06

[Important Notices](#)



Français	Contact us	Help	Search	Canada site
Coming events	About CBIF	Links	Reports and publications	Home

Canadian Biodiversity Information Facility



Notes on poisoning: *Phacelia campanularia*

[Introduction](#)[Interactive](#)[All poisonous plants by Botanical name](#)[All poisonous plants by Common name](#)[Important WWW Poisonous Plants sites](#)

General poisoning notes:

California bluebell (*Phacelia campanularia*) has been found near Fort Saskatchewan, Alta., where it was probably introduced. This plant causes dermatitis that is similar to poison-ivy dermatitis. The plants in Alberta have caused at least one case of dermatitis (Hardwick, personal communication). If these plants expand their range, more people may develop dermatitis (Munz 1965, Mitchell and Rook 1979).

References:

Mitchell, J. C., Rook, A. 1979. Botanical dermatology. Greenglass Ltd, Vancouver, B.C., Canada. 787 pp.

Munz, P. A. 1965. Dermatitis produced by phacelia (Hydrophyllaceae). Science (Wash. D. C.), 76: 194.

Nomenclature:

Scientific Name: *Phacelia campanularia* A. Gray

Vernacular name(s): California bluebell

Scientific family name: *Hydrophyllaceae*

Vernacular family name: waterleaf

Go to ITIS^{*ca} for more taxonomic information on: [Phacelia campanularia](#)

References:

Agriculture Quebec. 1975. Noms des maladies des plantes du Canada/ Names of plant diseases in Canada. , Quebec City, Que., Canada. 288 pp.

Alex, J. F., Cayouette, R., Mulligan, G. A. 1980. Common and botanical names of weeds in Canada/Noms populaire et scientifiques des plantes nuisibles du Canada. Revised. Agric. Can. Publ., Ottawa, Ont., Canada. 132 pp.

Bailey, L. H., Bailey, E. Z. 1976. Hortus third. Revised. MacMillan, New York, N.Y., USA. 1290 pp.

Scoggan, H. J. 1978, 1979. The flora of Canada. Nat. Mus. Nat. Sci. (Ottawa) Publ. Bot. 7(1)-7(4). 1711 pp.

Van Wijk, H. L. 1911. A dictionary of plant names. Martinus Nijhoff, The Hague, The Netherlands. 1444 pp.

Victorin, M. 1964. Flore Laurentienne. 2nd ed. Univ. Montreal, Montreal, Que., Canada. 952 pp.

Geographic Information

Alberta

References:

Bailey, L. H., Bailey, E. Z. 1976. Hortus third. Revised. MacMillan, New York, N.Y., USA. 1290 pp.

Boivin, B. 1966, 1967. Énumération des plantes du Canada. Provencheria 6. Nat. Can. (Que.) 93: 253-274; 371-437; 583-646; 989-1063. 94: 131-157; 471-528; 625-655.

Image or illustration

Phacelia campanularia:

Images: images.google.com

Notes on Poisonous plant parts:

The viscid glandular hairs on the plants stain the skin brown, and the sap causes dermatitis (Munz 1965).

Toxic parts:

hairs

References:

Munz, P. A. 1965. Dermatitis produced by phacelia (Hydrophyllaceae). Science (Wash. D. C.), 76: 194.

Toxic plant chemicals:

unknown chemical

References:

Munz, P. A. 1965. Dermatitis produced by phacelia (Hydrophyllaceae). Science (Wash. D. C.), 76: 194.

Animals/Human Poisoning:

Note: When an animal is listed without additional information, the literature (as of 1993) contained no detailed explanation.

Humans

General symptoms of poisoning:

[blistering](#)

[erythema](#)

[itchiness](#)

References:

Munz, P. A. 1965. Dermatitis produced by phacelia (Hydrophyllaceae). Science (Wash. D. C.), 76: 194.

[Another search?](#)

[Français](#) | [Contact Us](#) | [Help](#) | [Search](#) | [Canada site](#)

[Coming Events](#) | [About CBIF](#) | [Links](#) | [Reports and Publications](#) |

[Home](#)

Date modified: 2003-02-06

[Important Notices](#)



Français	Contact us	Help	Search	Canada site
Coming events	About CBIF	Links	Reports and publications	Home

Canadian Biodiversity Information Facility



Notes on poisoning: *Phalaris arundinacea*

[Introduction](#)[Interactive](#)[All poisonous plants by Botanical name](#)[All poisonous plants by Common name](#)[Important WWW Poisonous Plants sites](#)

General poisoning notes:

Reed canarygrass (*Phalaris arundinacea*) is cultivated and has also escaped across much of southern Canada. The plant grows well in poorly drained soils subject to prolonged flooding. The plant has caused animal performance lower than the nutritional composition of the plant suggests. Sheep in New Zealand exhibited Phalaris staggers, which includes distress, convulsions, and death. No cases of this have been reported in North America (Majak et al. 1979, Cheeke and Schull 1985).

References:

Cheeke, P. R., Shull, L. R. 1985. Natural toxicants in feeds and poisonous plants. AVI Publishing Company, Inc., Westport, Conn., USA. 492 pp.

Corcuera, L. J. 1989. Indole alkaloids from *Phalaris* and other gramineae. Pages 169-177 in Cheeke, P. R., ed. Toxicants of plant origin. Vol. I. Alkaloids. CRC Press, Inc., Boca Raton, Fla., USA. 335 pp.

Nomenclature:

Scientific Name: *Phalaris arundinacea* L.

Vernacular name(s): reed canarygrass

Scientific family name: *Gramineae*

Vernacular family name: grass

Go to ITIS*^{ca} for more taxonomic information on: [Phalaris arundinacea](#)

References:

Agriculture Quebec. 1975. Noms des maladies des plantes du Canada/ Names of plant diseases in Canada. , Quebec City, Que., Canada. 288 pp.

Alex, J. F., Cayouette, R., Mulligan, G. A. 1980. Common and botanical names of weeds in Canada/Noms populaire et scientifiques des plantes nuisibles du Canada. Revised. Agric. Can. Publ., Ottawa, Ont., Canada. 132 pp.

Bailey, L. H., Bailey, E. Z. 1976. Hortus third. Revised. MacMillan, New York, N.Y., USA. 1290 pp.

Scoggan, H. J. 1978, 1979. The flora of Canada. Nat. Mus. Nat. Sci. (Ottawa) Publ. Bot. 7(1)-7(4). 1711 pp.

Van Wijk, H. L. 1911. A dictionary of plant names. Martinus Nijhoff, The Hague, The Netherlands. 1444 pp.

Victorin, M. 1964. Flore Laurentienne. 2nd ed. Univ. Montreal, Montreal, Que., Canada. 952 pp.

Geographic Information

Alberta
British Columbia
Manitoba
New Brunswick
Newfoundland
Northwest Territories
Nova Scotia
Ontario
Prince Edward Island
Quebec
Saskatchewan

References:

Bailey, L. H., Bailey, E. Z. 1976. Hortus third. Revised. MacMillan, New York, N.Y., USA. 1290 pp.

Boivin, B. 1966, 1967. Énumération des plantes du Canada. Provencheria 6. Nat. Can. (Que.) 93: 253-274; 371-437; 583-646; 989-1063. 94: 131-157; 471-528; 625-655.

Image or illustration

Phalaris arundinacea:

Images: images.google.com

Toxic parts:

leaves

References:

Corcuera, L. J. 1989. Indole alkaloids from *Phalaris* and other gramineae. Pages 169-177 in Cheeke, P. R., ed. Toxicants of plant origin. Vol. I. Alkaloids. CRC Press, Inc., Boca Raton, Fla., USA. 335 pp.

Notes on Toxic plant chemicals:

Several indole alkaloids are found in reed canarygrass, including hordenine, gramine and 5-methoxy-N-methyltryptamine. Other indole alkaloids were also found. In the interior of British Columbia the concentration of the latter two was found to increase towards the end of the growing season. Differences were also found in various cultivars. Cultural practices and environmental factors such as moisture stress may also increase the amount of alkaloids (Majak et al. 1979, Corcuera 1989).

Toxic plant chemicals:

gramine
hordenine
5MMethyltryptamine

References:

Corcuera, L. J. 1989. Indole alkaloids from *Phalaris* and other gramineae. Pages 169-177 in Cheeke, P. R., ed. Toxicants of plant origin. Vol. I. Alkaloids. CRC Press, Inc., Boca Raton, Fla., USA. 335 pp.

Animals/Human Poisoning:

Note: When an animal is listed without additional information, the literature (as of 1993) contained no detailed explanation.

Cattle

General symptoms of poisoning:

[convulsions](#)

[death](#)

[incoordination](#)

[muscle spasms](#)

[weight gain, reduced](#)

Notes on poisoning:

Sheep in New Zealand have developed *Phalaris* staggers. Symptoms include incoordination, stiff stilted gait, muscle spasms, convulsions, recumbency, and death. Similar symptoms have not been recorded in North America. Gross lesions are found in the nervous system, including gray to blue discoloration of the brain stem and yellow brown granules in the cytoplasm of nerve cells (Cheeke and Schull 1985).

References:

Corcuera, L. J. 1989. Indole alkaloids from *Phalaris* and other gramineae. Pages 169-177 in Cheeke, P. R., ed. Toxicants of plant origin. Vol. I. Alkaloids. CRC Press, Inc., Boca Raton, Fla., USA. 335 pp.

Sheep

General symptoms of poisoning:

[coma](#)

References:

Cheeke, P. R., Shull, L. R. 1985. Natural toxicants in feeds and poisonous plants. AVI Publishing Company, Inc., Westport, Conn., USA. 492 pp.

[Another search?](#)

[Français](#) | [Contact Us](#) | [Help](#) | [Search](#) | [Canada site](#)

[Coming Events](#) | [About CBIF](#) | [Links](#) | [Reports and Publications](#) |

[Home](#)

Date modified: 2003-02-06

[Important Notices](#)



Français	Contact us	Help	Search	Canada site
Coming events	About CBIF	Links	Reports and publications	Home

Canadian Biodiversity Information Facility



Notes on poisoning: *Philodendron cordatum*

[Introduction](#)[Interactive](#)[All poisonous plants by Botanical name](#)[All poisonous plants by Common name](#)[Important WWW Poisonous Plants sites](#)

General poisoning notes:

Philodendron (*Philodendron cordatum*) is an indoor ornamental. Philodendrons can cause poisoning in humans and pets because of the oxalates. See additional general notes under [Philodendron scandens](#).



References:

Ayres, S. Jr, Ayres, S. 1958. Philodendron as a cause of contact dermatitis. Arch. Dermatol., 78: 330-333.

Dorsey, C. 1958. *Philodendron* dermatitis. Calif. Med., 88: 329-330.

Lampe, K. F., McCann, M. A. 1985. AMA Handbook of poisonous and injurious plants. American Medical Assoc. Chicago, Ill., USA. 432 pp.

McIntire, M. S., Guest, J. R., Porterfield, J. F. 1990. Philodendron - an infant death. Clin. Toxicol., 28: 177-183.

Nomenclature:

Scientific Name: *Philodendron cordatum* (Vell.) Kunth.

Vernacular name(s): philodendron

Scientific family name: *Araceae*

Vernacular family name: arum

Go to ITIS*^{ca} for more taxonomic information on: [Philodendron cordatum](#)

References:

Agriculture Quebec. 1975. Noms des maladies des plantes du Canada/ Names of plant diseases in Canada. , Quebec City, Que., Canada. 288 pp.

Alex, J. F., Cayouette, R., Mulligan, G. A. 1980. Common and botanical names of weeds in Canada/Noms populaire et scientifiques des plantes nuisibles du Canada. Revised. Agric. Can. Publ., Ottawa, Ont., Canada. 132 pp.

Bailey, L. H., Bailey, E. Z. 1976. Hortus third. Revised. MacMillan, New York, N.Y., USA. 1290 pp.

Scoggan, H. J. 1978, 1979. The flora of Canada. Nat. Mus. Nat. Sci. (Ottawa) Publ. Bot. 7(1)-7(4). 1711 pp.

Van Wijk, H. L. 1911. A dictionary of plant names. Martinus Nijhoff, The Hague, The Netherlands. 1444 pp.

Victorin, M. 1964. Flore Laurentienne. 2nd ed. Univ. Montreal, Montreal, Que., Canada. 952 pp.

Geographic Information

Plant or plant parts used in or around the home.

References:

Bailey, L. H., Bailey, E. Z. 1976. Hortus third. Revised. MacMillan, New York, N.Y., USA. 1290 pp.

Boivin, B. 1966, 1967. Énumération des plantes du Canada. Provencheria 6. Nat. Can. (Que.) 93: 253-274; 371-437; 583-646; 989-1063. 94: 131-157; 471-528; 625-655.

Image or illustration

Philodendron cordatum:

Images: images.google.com

Toxic parts:

leaves
plant juices

References:

Ayres, S. Jr, Ayres, S. 1958. Philodendron as a cause of contact dermatitis. Arch. Dermatol., 78: 330-333.

Dorsey, C. 1958. *Philodendron* dermatitis. Calif. Med., 88: 329-330.

Toxic plant chemicals:

oxalate

References:

Lampe, K. F., McCann, M. A. 1985. AMA Handbook of poisonous and injurious plants. American Medical Assoc. Chicago, Ill., USA. 432 pp.

Animals/Human Poisoning:

Note: When an animal is listed without additional information, the literature (as of 1993) contained no detailed explanation.

Humans

General symptoms of poisoning:

[erythema](#)

[itchiness](#)

References:

Ayres, S. Jr, Ayres, S. 1958. *Philodendron* as a cause of contact dermatitis. Arch. Dermatol., 78: 330-333.

Dorsey, C. 1958. *Philodendron* dermatitis. Calif. Med., 88: 329-330.

[Another search?](#)

[Français](#) | [Contact Us](#) | [Help](#) | [Search](#) | [Canada site](#)

[Coming Events](#) | [About CBIF](#) | [Links](#) | [Reports and Publications](#) |

[Home](#)

Date modified: 2003-02-06

[Important Notices](#)



Français	Contact us	Help	Search	Canada site
Coming events	About CBIF	Links	Reports and publications	Home

Canadian Biodiversity Information Facility



Notes on poisoning: *Philodendron scandens*

[Introduction](#)[Interactive](#)[All poisonous plants by Botanical name](#)[All poisonous plants by Common name](#)[Important WWW Poisonous Plants sites](#)

General poisoning notes:

Heart-leaved philodendron (*Philodendron scandens*) is an ornamental. Chewing the leaves of philodendrons results in painful burning and swelling of the mouth parts because of the oxalates. Contact dermatitis also occurs (Lampe and McCann 1985). A recent survey showed that even though 67% of 188 cases involved philodendrons, only one case developed minor symptoms (Mrvos et al. 1990). McIntire et al. (1990) describe the death of an infant after it had ingested a philodendron. The child had ulceration of lips and tongue as well as esophageal erosion. Death was caused by cardiac arrest secondary to vagotonia resulting from esophageal erosions. Family pets can also exhibit signs of toxicity if they chew on leaves of philodendrons. Hanna (1986) lists several symptoms attributable to ingestion of these plants by pets. However, Sellers et al. (1977) conducted laboratory feeding studies on cats and concluded that signs of acute toxicity were not found upon necropsy, even when large quantities of leaves were ingested. Experimental work on mice and rats showed that death occurred when the rodents were given extracts from leaves and stems (Der Marderosian et al. 1976).

References:

Der Marderosian, A. H., Giller, F. B., Roia, F. C. 1976. Phytochemical and toxicological screening of household ornamental plants potentially toxic to humans. 1. J. Toxicol. Environ. Health, 1: 939-953.

Hanna, G. 1986. Plant poisoning in canines and felines. Vet. Hum. Toxicol., 28: 38-40.

Lampe, K. F., McCann, M. A. 1985. AMA Handbook of poisonous and injurious plants. American Medical Assoc. Chicago, Ill., USA. 432 pp.

McIntire, M. S., Guest, J. R., Porterfield, J. F. 1990. Philodendron

- an infant death. Clin. Toxicol., 28: 177-183.

Mrvos, R., Dean, B. S., Krenzelok, E. P. 1990. *Philodendron/Dieffenbachia* ingestions: are they a problem? Vet. Hum. Toxicol., 32: 369.

Sellers, S. J., King, M., Aronson, C. E., Der Marderosian, A. 1977. Toxicologic assessment of *Philodendron oxycardium* Schott (Araceae) in domestic cats. Vet. Hum. Toxicol., 19: 92-96.

Nomenclature:

Scientific Name: *Philodendron scandens* C. Koch & H. Sello

Vernacular name(s): heart-leaved philodendron

Scientific family name: *Araceae*

Vernacular family name: arum

Go to ITIS^{*ca} for more taxonomic information on: [Philodendron scandens](#)

References:

Agriculture Quebec. 1975. Noms des maladies des plantes du Canada/ Names of plant diseases in Canada. , Quebec City, Que., Canada. 288 pp.

Alex, J. F., Cayouette, R., Mulligan, G. A. 1980. Common and botanical names of weeds in Canada/Noms populaire et scientifiques des plantes nuisibles du Canada. Revised. Agric. Can. Publ., Ottawa, Ont., Canada. 132 pp.

Bailey, L. H., Bailey, E. Z. 1976. Hortus third. Revised. MacMillan, New York, N.Y., USA. 1290 pp.

Scoggan, H. J. 1978, 1979. The flora of Canada. Nat. Mus. Nat. Sci. (Ottawa) Publ. Bot. 7(1)-7(4). 1711 pp.

Van Wijk, H. L. 1911. A dictionary of plant names. Martinus Nijhoff, The Hague, The Netherlands. 1444 pp.

Victorin, M. 1964. Flore Laurentienne. 2nd ed. Univ. Montreal, Montreal, Que., Canada. 952 pp.

Geographic Information

Plant or plant parts used in or around the home.

References:

Bailey, L. H., Bailey, E. Z. 1976. Hortus third. Revised.

MacMillan, New York, N.Y., USA. 1290 pp.

Boivin, B. 1966, 1967. Énumération des plantes du Canada. Provencheria 6. Nat. Can. (Que.) 93: 253-274; 371-437; 583-646; 989-1063. 94: 131-157; 471-528; 625-655.

Image or illustration

Philodendron scandens:

Images: images.google.com

Toxic parts:

leaves

References:

Lampe, K. F., McCann, M. A. 1985. AMA Handbook of poisonous and injurious plants. American Medical Assoc. Chicago, Ill., USA. 432 pp.

Toxic plant chemicals:

oxalate

References:

Sellers, S. J., King, M., Aronson, C. E., Der Marderosian, A. 1977. Toxicologic assessment of *Philodendron oxycardium* Schott (Araceae) in domestic cats. Vet. Hum. Toxicol., 19: 92-96.

Animals/Human Poisoning:

Note: When an animal is listed without additional information, the literature (as of 1993) contained no detailed explanation.

Cats

General symptoms of poisoning:

[nephritis](#)

[nervousness](#)

[opisthotonos](#)

[temperature, elevated](#)

[trembling](#)

References:

Hanna, G. 1986. Plant poisoning in canines and felines. *Vet. Hum. Toxicol.*, 28: 38-40.

Sellers, S. J., King, M., Aronson, C. E., Der Marderosian, A. 1977. Toxicologic assessment of *Philodendron oxycardium* Schott (Araceae) in domestic cats. *Vet. Hum. Toxicol.*, 19: 92-96.

Humans

General symptoms of poisoning:

[mouth, irritation of](#)

Notes on poisoning:

Painful burning and swelling of lips, mouth, tongue, and throat can develop quickly after chewing of leaves. Contact dermatitis can also occur. Treatment includes administering cool liquids. The insoluble oxalates do not produce systemic poisoning in humans (Lampe and McCann 1985).

References:

Lampe, K. F., McCann, M. A. 1985. *AMA Handbook of poisonous and injurious plants*. American Medical Assoc. Chicago, Ill., USA. 432 pp.

McIntire, M. S., Guest, J. R., Porterfield, J. F. 1990. *Philodendron* - an infant death. *Clin. Toxicol.*, 28: 177-183.

Rodents

General symptoms of poisoning:

[death](#)

References:

Der Marderosian, A. H., Giller, F. B., Roia, F. C. 1976. Phytochemical and toxicological screening of household ornamental plants potentially toxic to humans. 1. *J. Toxicol. Environ. Health*, 1: 939-953.

[Another search?](#)

[Français](#) | [Contact Us](#) | [Help](#) | [Search](#) | [Canada site](#)

[Coming Events](#) | [About CBIF](#) | [Links](#) | [Reports and Publications](#) |

[Home](#)

Date modified: 2003-02-06

[Important Notices](#)



Français	Contact us	Help	Search	Canada site
Coming events	About CBIF	Links	Reports and publications	Home

Canadian Biodiversity Information Facility



Notes on poisoning: *Phoradendron flavescens*

[Introduction](#)[Interactive](#)[All poisonous plants by Botanical name](#)[All poisonous plants by Common name](#)[Important WWW Poisonous Plants sites](#)

General poisoning notes:

American mistletoe (*Phoradendron flavescens*) is the familiar mistletoe of Christmas. Ingesting a large number of the berries or tea made from the berries has led to poisoning and death in humans. Mistletoe, used as decorations at Christmas, should be kept out of the reach of children and family pets (Kingsbury 1964, Fuller and McClintock 1986).



References:

- Fuller, T. C., McClintock, E. 1986. Poisonous plants of California. Univ. California Press, Berkeley, Calif., USA. 432 pp.
- Kingsbury, J. M. 1964. Poisonous plants of the United States and Canada. Prentice-Hall Inc., Englewood Cliffs, N.J., USA. 626 pp.

Nomenclature:

Scientific Name: *Phoradendron flavescens* (Pursh) Nutt.

Vernacular name(s): American mistletoe

Scientific family name: *Loranthaceae*

Vernacular family name: mistletoe

Go to ITIS^{*ca} for more taxonomic information on: [Phoradendron flavescens](#)

References:

Agriculture Quebec. 1975. Noms des maladies des plantes du Canada/ Names of plant diseases in Canada. , Quebec City, Que., Canada. 288 pp.

Alex, J. F., Cayouette, R., Mulligan, G. A. 1980. Common and

botanical names of weeds in Canada/Noms populaire et scientifiques des plantes nuisibles du Canada. Revised. Agric. Can. Publ., Ottawa, Ont., Canada. 132 pp.

Bailey, L. H., Bailey, E. Z. 1976. Hortus third. Revised. MacMillan, New York, N.Y., USA. 1290 pp.

Scoggan, H. J. 1978, 1979. The flora of Canada. Nat. Mus. Nat. Sci. (Ottawa) Publ. Bot. 7(1)-7(4). 1711 pp.

Van Wijk, H. L. 1911. A dictionary of plant names. Martinus Nijhoff, The Hague, The Netherlands. 1444 pp.

Victorin, M. 1964. Flore Laurentienne. 2nd ed. Univ. Montreal, Montreal, Que., Canada. 952 pp.

Geographic Information

Plant or plant parts used in or around the home.

References:

Bailey, L. H., Bailey, E. Z. 1976. Hortus third. Revised. MacMillan, New York, N.Y., USA. 1290 pp.

Boivin, B. 1966, 1967. Énumération des plantes du Canada. Provencheria 6. Nat. Can. (Que.) 93: 253-274; 371-437; 583-646; 989-1063. 94: 131-157; 471-528; 625-655.

Image or illustration

Phoradendron flavescens:

Images: images.google.com

Toxic parts:

all parts
leaves
mature fruit

References:

Fuller, T. C., McClintock, E. 1986. Poisonous plants of California. Univ. California Press, Berkeley, Calif., USA. 432 pp.

Notes on Toxic plant chemicals:

American mistletoe contains two amines, beta-phenylethylamine and tyramine, as well as a lectin, phoratoxin. These chemicals are probably responsible for toxic reactions after ingestion (Fuller

and McClintock 1986).

Toxic plant chemicals:

beta-phenylethylamine

phoratoxin

tryamine

References:

Fuller, T. C., McClintock, E. 1986. Poisonous plants of California. Univ. California Press, Berkeley, Calif., USA. 432 pp.

Animals/Human Poisoning:

Note: When an animal is listed without additional information, the literature (as of 1993) contained no detailed explanation.

Humans

General symptoms of poisoning:

[cardiac arrest](#)

[death](#)

[gastroenteritis](#)

Notes on poisoning:

Ingesting a few berries causes abdominal pain and diarrhea. Tea made from the berries caused death about 10 h after symptoms of acute gastroenteritis, followed by cardiovascular collapse. Plant material has slowed the heartbeat in a way similar to digitalis (Kingsbury 1964, Fuller and McClintock 1986).

References:

Fuller, T. C., McClintock, E. 1986. Poisonous plants of California. Univ. California Press, Berkeley, Calif., USA. 432 pp.

Kingsbury, J. M. 1964. Poisonous plants of the United States and Canada. Prentice-Hall Inc., Englewood Cliffs, N.J., USA. 626 pp.

[Another search?](#)

[Français](#) | [Contact Us](#) | [Help](#) | [Search](#) | [Canada site](#)

[Coming Events](#) | [About CBIF](#) | [Links](#) | [Reports and Publications](#) |

[Home](#)

Date modified: 2003-02-06

[Important Notices](#)



Français	Contact us	Help	Search	Canada site
Coming events	About CBIF	Links	Reports and publications	Home



Notes on poisoning: *Physalis alkekengi*

[Introduction](#)

[Interactive](#)

[All poisonous plants by Botanical name](#)

[All poisonous plants by Common name](#)

[Important WWW Poisonous Plants sites](#)

General poisoning notes:

Chinese-lantern (*Physalis alkekengi*) is an outdoor ornamental grown for its lantern-shaped fruit cover (pericarp). The enclosed immature fruits contain sufficient quantities of solanine to cause gastroenteritis and diarrhea in children. The mature fruits are apparently edible (Lampe and McCann 1985).

References:

Lampe, K. F., McCann, M. A. 1985. AMA Handbook of poisonous and injurious plants. American Medical Assoc. Chicago, Ill., USA. 432 pp.



Nomenclature:

Scientific Name: *Physalis alkekengi* L.

Vernacular name(s): Chinese-lantern

Scientific family name: *Solanaceae*

Vernacular family name: nightshade

Go to ITIS^{*ca} for more taxonomic information on: [Physalis alkekengi](#)

References:

Agriculture Quebec. 1975. Noms des maladies des plantes du Canada/ Names of plant diseases in Canada. , Quebec City, Que., Canada. 288 pp.

Alex, J. F., Cayouette, R., Mulligan, G. A. 1980. Common and botanical names of weeds in Canada/Noms populaire et scientifiques des plantes nuisibles du Canada. Revised. Agric. Can. Publ., Ottawa, Ont., Canada. 132 pp.

Bailey, L. H., Bailey, E. Z. 1976. Hortus third. Revised. MacMillan, New York, N.Y., USA. 1290 pp.

Scoggan, H. J. 1978, 1979. The flora of Canada. Nat. Mus. Nat. Sci. (Ottawa) Publ. Bot. 7(1)-7(4). 1711 pp.

Van Wijk, H. L. 1911. A dictionary of plant names. Martinus Nijhoff, The Hague, The Netherlands. 1444 pp.

Victorin, M. 1964. Flore Laurentienne. 2nd ed. Univ. Montreal, Montreal, Que., Canada. 952 pp.

Geographic Information

Plant or plant parts used in or around the home.

References:

Bailey, L. H., Bailey, E. Z. 1976. Hortus third. Revised. MacMillan, New York, N.Y., USA. 1290 pp.

Boivin, B. 1966, 1967. Énumération des plantes du Canada. Provencheria 6. Nat. Can. (Que.) 93: 253-274; 371-437; 583-646; 989-1063. 94: 131-157; 471-528; 625-655.

Image or illustration

Physalis alkekengi:

Images: images.google.com

Toxic parts:

immature fruit

References:

Lampe, K. F., McCann, M. A. 1985. AMA Handbook of poisonous and injurious plants. American Medical Assoc. Chicago, Ill., USA. 432 pp.

Notes on Toxic plant chemicals:

Solanine, a bitter glycoalkaloid, is found in the immature berries. Ripe fruit is apparently edible (Lampe and McCann 1985, Fuller and McClintock 1986).

Toxic plant chemicals:

solanine

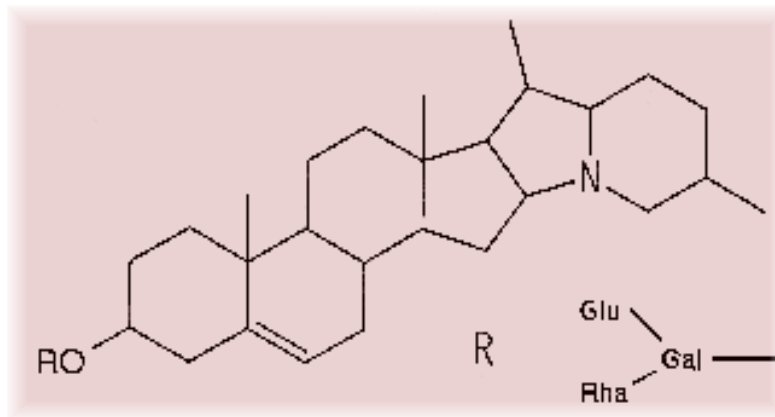

Chemical diagram(s) are courtesy of [Ruth McDiarmid](#), Biochemistry Technician, Kamloops Range Station, Agriculture and Agri-Food Canada, Kamloops, British Columbia, Canada.

References:

Fuller, T. C., McClintock, E. 1986. Poisonous plants of California. Univ. California Press, Berkeley, Calif., USA. 432 pp.

Lampe, K. F., McCann, M. A. 1985. AMA Handbook of poisonous and injurious plants. American Medical Assoc. Chicago, Ill., USA. 432 pp.

Animals/Human Poisoning:

Note: When an animal is listed without additional information, the literature (as of 1993) contained no detailed explanation.

Humans

General symptoms of poisoning:

[diarrhea](#)

[fever](#)

[gastroenteritis](#)

Notes on poisoning:

Symptoms include diarrhea, gastroenteritis, fever, and a scratchy feeling at the back of the throat a few hours after ingestion (Lampe and McCann 1985).

References:

Lampe, K. F., McCann, M. A. 1985. AMA Handbook of poisonous and injurious plants. American Medical Assoc. Chicago, Ill., USA. 432 pp.

[Another search?](#)

[Français](#) | [Contact Us](#) | [Help](#) | [Search](#) | [Canada site](#)

[Coming Events](#) | [About CBIF](#) | [Links](#) | [Reports and Publications](#) | [Home](#)

Date modified: 2003-02-06

[Important Notices](#)



Français	Contact us	Help	Search	Canada site
Coming events	About CBIF	Links	Reports and publications	Home



Notes on poisoning: *Physalis peruviana*

[Introduction](#)

[Interactive](#)

[All poisonous plants by Botanical name](#)

[All poisonous plants by Common name](#)

[Important WWW Poisonous Plants sites](#)

General poisoning notes:

Ground-cherry (*Physalis peruviana*) is an ornamental herb that is grown for its ripe fruits, which are used for making preserves. The immature fruits contain sufficient solanine to cause gastroenteritis and diarrhea if ingested. Children should be discouraged from eating the fruits (Lampe and McCann 1985).

References:

Lampe, K. F., McCann, M. A. 1985. AMA Handbook of poisonous and injurious plants. American Medical Assoc. Chicago, Ill., USA. 432 pp.



Nomenclature:

Scientific Name: *Physalis peruviana* L.

Vernacular name(s): ground-cherry

Scientific family name: *Solanaceae*

Vernacular family name: nightshade

Go to ITIS^{*ca} for more taxonomic information on: [Physalis peruviana](#)

References:

Agriculture Quebec. 1975. Noms des maladies des plantes du Canada/ Names of plant diseases in Canada. , Quebec City, Que., Canada. 288 pp.

Alex, J. F., Cayouette, R., Mulligan, G. A. 1980. Common and botanical names of weeds in Canada/Noms populaire et scientifiques des plantes nuisibles du Canada. Revised. Agric. Can. Publ., Ottawa, Ont., Canada. 132 pp.

Bailey, L. H., Bailey, E. Z. 1976. Hortus third. Revised. MacMillan, New York, N.Y., USA. 1290 pp.

Scoggan, H. J. 1978, 1979. The flora of Canada. Nat. Mus. Nat. Sci. (Ottawa) Publ. Bot. 7(1)-7(4). 1711 pp.

Van Wijk, H. L. 1911. A dictionary of plant names. Martinus Nijhoff, The Hague, The Netherlands. 1444 pp.

Victorin, M. 1964. Flore Laurentienne. 2nd ed. Univ. Montreal, Montreal, Que., Canada. 952 pp.

Geographic Information

Plant or plant parts used in or around the home.

References:

Bailey, L. H., Bailey, E. Z. 1976. Hortus third. Revised. MacMillan, New York, N.Y., USA. 1290 pp.

Boivin, B. 1966, 1967. Énumération des plantes du Canada. Provencheria 6. Nat. Can. (Que.) 93: 253-274; 371-437; 583-646; 989-1063. 94: 131-157; 471-528; 625-655.

Image or illustration

Physalis peruviana:

Images: images.google.com

Toxic parts:

immature fruit

References:

Lampe, K. F., McCann, M. A. 1985. AMA Handbook of poisonous and injurious plants. American Medical Assoc. Chicago, Ill., USA. 432 pp.

Notes on Toxic plant chemicals:

Solanine, a bitter glycoalkaloid, is found in the unripened berries (Lampe and McCann 1985).

Toxic plant chemicals:

solanine

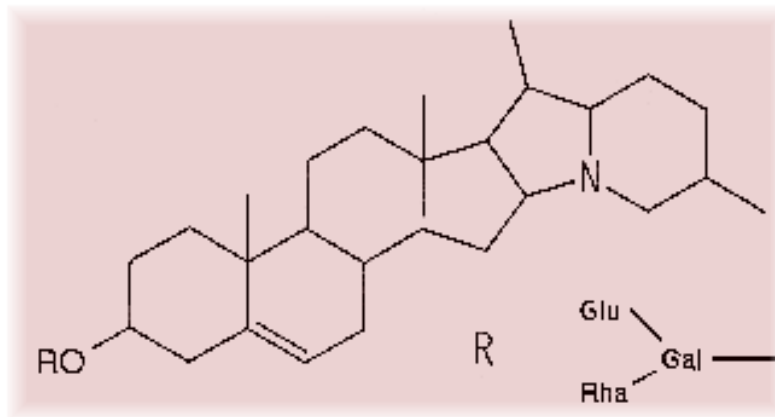

Chemical diagram(s) are courtesy of [Ruth McDiarmid](#), Biochemistry Technician, Kamloops Range Station, Agriculture and Agri-Food Canada, Kamloops, British Columbia, Canada.

References:

Lampe, K. F., McCann, M. A. 1985. AMA Handbook of poisonous and injurious plants. American Medical Assoc. Chicago, Ill., USA. 432 pp.

Animals/Human Poisoning:

Note: When an animal is listed without additional information, the literature (as of 1993) contained no detailed explanation.

Humans

General symptoms of poisoning:

[diarrhea](#)

[fever](#)

[gastroenteritis](#)

Notes on poisoning:

Symptoms of ingestion include gastroenteritis, diarrhea, and fever, with a scratchy feeling in the throat a few hours after ingestion. Children are more susceptible to poisoning than adults (Lampe and McCann 1985).

References:

Lampe, K. F., McCann, M. A. 1985. AMA Handbook of poisonous and injurious plants. American Medical Assoc. Chicago, Ill., USA. 432 pp.

[Another search?](#)

[Français](#) | [Contact Us](#) | [Help](#) | [Search](#) | [Canada site](#)

[Coming Events](#) | [About CBIF](#) | [Links](#) | [Reports and Publications](#) | [Home](#)

Date modified: 2003-02-06

[Important Notices](#)



Français	Contact us	Help	Search	Canada site
Coming events	About CBIF	Links	Reports and publications	Home



Notes on poisoning: *Phytolacca americana*

[Introduction](#)

[Interactive](#)

[All poisonous plants by Botanical name](#)

[All poisonous plants by Common name](#)

[Important WWW Poisonous Plants sites](#)



General poisoning notes:

Pokeweed (*Phytolacca americana*) is a native herb found in the southwestern parts of Ontario and Quebec. The young shoots are used as poke salad and the leaves as a folk medicine or tea. In both cases, the plant material should be boiled at least twice to get rid of the toxin, according to literature reports. Failure to do so has caused poisoning in humans. Ingesting a few berries does not cause problems, but larger quantities, if uncooked, can be toxic to humans. Cattle, horses, sheep, and particularly swine, have been poisoned by ingesting pokeweed plant material. The berries have poisoned young turkeys experimentally (Patterson 1929, Barnett 1975, Callahan et al. 1981, Cooper and Johnson 1984).

References:

- Barnett, B. D. 1975. Toxicity of pokeberries (fruit of *Phytolacca americana* Large) for turkey poults. *Poult. Sci.*, 54: 1215-1217.
- Callahan, R., Piccola, F., Gensheimer, K., Parkin, W. E., Prusakowski, J., Scheiber, G., Henry, S. 1981. Epidemiologic notes and reports. *Plant poisonings - New Jersey*. U.S. Dep. Health Hum. M. M. W. R., 30: 65-67.
- Cooper, M. R., Johnson, A. W. 1984. *Poisonous plants in Britain and their effects on animals and man*. Her Majesty's Stationery Office, London, England. 305 pp.
- Jaackle, K. A., Freemon, F. R. 1981. Pokeweed poisoning. *South. Med. J.*, 74: 639-640.
- Lawrence, R. A. 1990. The clinical effects of pokeweed root ingestion upon 32 adults. *Vet. Hum. Toxicol.*, 32: 369.
- Lewis, W. H., Smith, P. R. 1979. Poke root herbal tea poisoning. *J. Am. Med. Assoc.*, 242: 2759-2760.
- Patterson, F. D. 1929. Pokeweed causes heavy losses in swine herd.

Vet. Med. Small Anim. Clin., 24: 114.

Stein, Z. L. 1979. Pokeweed-induced gastroenteritis. Am. J. Hosp. Pharm., 36: 1303.

Nomenclature:

Scientific Name: *Phytolacca americana* L.

Vernacular name(s): pokeweed

Scientific family name: *Phytolaccaceae*

Vernacular family name: pokeweed

Go to ITIS*^{ca} for more taxonomic information on: [Phytolacca americana](#)

References:

Agriculture Quebec. 1975. Noms des maladies des plantes du Canada/ Names of plant diseases in Canada. , Quebec City, Que., Canada. 288 pp.

Alex, J. F., Cayouette, R., Mulligan, G. A. 1980. Common and botanical names of weeds in Canada/Noms populaire et scientifiques des plantes nuisibles du Canada. Revised. Agric. Can. Publ., Ottawa, Ont., Canada. 132 pp.

Bailey, L. H., Bailey, E. Z. 1976. Hortus third. Revised. MacMillan, New York, N.Y., USA. 1290 pp.

Scoggan, H. J. 1978, 1979. The flora of Canada. Nat. Mus. Nat. Sci. (Ottawa) Publ. Bot. 7(1)-7(4). 1711 pp.

Van Wijk, H. L. 1911. A dictionary of plant names. Martinus Nijhoff, The Hague, The Netherlands. 1444 pp.

Victorin, M. 1964. Flore Laurentienne. 2nd ed. Univ. Montreal, Montreal, Que., Canada. 952 pp.

Geographic Information

Ontario

Quebec

References:

Bailey, L. H., Bailey, E. Z. 1976. Hortus third. Revised. MacMillan, New York, N.Y., USA. 1290 pp.

Boivin, B. 1966, 1967. Énumération des plantes du Canada. Provencheria 6. Nat. Can. (Que.) 93: 253-274; 371-437; 583-646;

989-1063. 94: 131-157; 471-528; 625-655.

Image or illustration

Phytolacca americana:

Images: images.google.com

Notes on Poisonous plant parts:

Leaves, young shoots, and roots are poisonous. The berries are considered relatively nontoxic to humans, although toxicity to animals and humans has been reported. Barnett (1974) describes experimental poisoning and death in turkey poults.

Toxic parts:

all parts
leaves
mature fruit
roots
stems
young shoots

References:

- Barnett, B. D. 1975. Toxicity of pokeberries (fruit of *Phytolacca americana* Large) for turkey poults. *Poult. Sci.*, 54: 1215-1217.
- Callahan, R., Piccola, F., Gensheimer, K., Parkin, W. E., Prusakowski, J., Scheiber, G., Henry, S. 1981. Epidemiologic notes and reports. *Plant poisonings - New Jersey*. U.S. Dep. Health Hum. M. M. W. R., 30: 65-67.
- Jaeckle, K. A., Freemon, F. R. 1981. Pokeweed poisoning. *South. Med. J.*, 74: 639-640.
- Lawrence, R. A. 1990. The clinical effects of pokeweed root ingestion upon 32 adults. *Vet. Hum. Toxicol.*, 32: 369.
- Lewis, W. H., Smith, P. R. 1979. Poke root herbal tea poisoning. *J. Am. Med. Assoc.*, 242: 2759-2760.
- Patterson, F. D. 1929. Pokeweed causes heavy losses in swine herd. *Vet. Med. Small Anim. Clin.*, 24: 114.
- Stein, Z. L. 1979. Pokeweed-induced gastroenteritis. *Am. J. Hosp. Pharm.*, 36: 1303.

Notes on Toxic plant chemicals:

Phytolaccatoxin, a triterpene saponin, has been implicated in pokeweed toxicity. The toxin is water-soluble, which has led to the common assumption that boiling the plant material twice will get rid of toxicity. Such treatment is usually sufficient to remove the toxin (Lampe and McCann 1985).

Toxic plant chemicals:

phytolaccatoxin

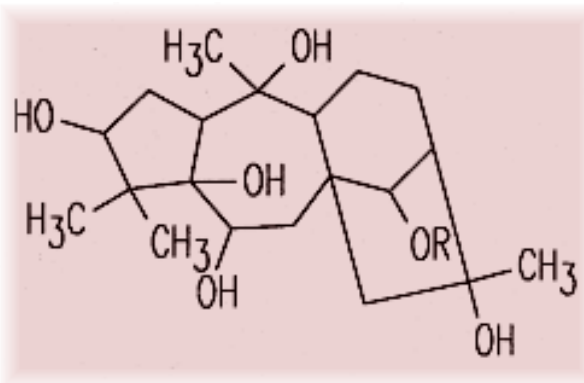

phytolaccigenin

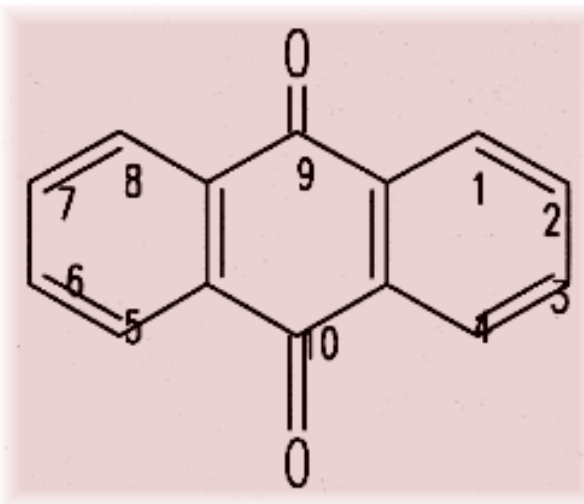

Chemical diagram(s) are courtesy of [Ruth McDiarmid](#), Biochemistry Technician, Kamloops Range Station, Agriculture and Agri-Food Canada, Kamloops, British Columbia, Canada.

References:

Lampe, K. F., McCann, M. A. 1985. AMA Handbook of poisonous and injurious plants. American Medical Assoc. Chicago, Ill., USA. 432 pp.

Lewis, W. H., Smith, P. R. 1979. Poke root herbal tea poisoning. J. Am. Med. Assoc., 242: 2759-2760.

Animals/Human Poisoning:

Note: When an animal is listed without additional information, the literature (as of 1993) contained no detailed explanation.

Cattle

General symptoms of poisoning:

[abortion](#)

[coma](#)

[convulsions](#)

[diarrhea](#)

[vomiting](#)

References:

Cooper, M. R., Johnson, A. W. 1984. Poisonous plants in Britain and their effects on animals and man. Her Majesty's Stationery Office, London, England. 305 pp.

Horses

General symptoms of poisoning:

[convulsions](#)

[diarrhea](#)

[gastroenteritis](#)

[salivation](#)

[vomiting](#)

References:

Cooper, M. R., Johnson, A. W. 1984. Poisonous plants in Britain and their effects on animals and man. Her Majesty's Stationery Office, London, England. 305 pp.

Humans

General symptoms of poisoning:

[abdominal pains](#)

[blood pressure, low](#)

[breathing, rapid](#)

[confusion](#)

[diarrhea](#)

[dizziness](#)

[gastroenteritis](#)
[headache](#)
[heart rate, elevated](#)
[nausea](#)
[salivation](#)
[stomach cramps](#)
[stool, bloody](#)
[sweating](#)
[thirsty](#)
[trembling](#)
[unconsciousness](#)
[urinary incontinence](#)
[vomiting](#)
[weakness](#)

Notes on poisoning:

Symptoms of toxicity include sweating, bloody diarrhea, abdominal pains, weakness, incontinence, vomiting, salivation, unconsciousness, tremors, and blurred vision. Ingesting the leaves or young shoots causes toxicity. Sometimes tea made from the leaves can cause poisoning. Symptomatic treatment and replacement of fluids are recommended (Callahan et al. 1981, Jaeckle and Freemon 1981).

References:

Callahan, R., Piccola, F., Gensheimer, K., Parkin, W. E., Prusakowski, J., Scheiber, G., Henry, S. 1981. Epidemiologic notes and reports. Plant poisonings - New Jersey. U.S. Dep. Health Hum. M. M. W. R., 30: 65-67.

Jaeckle, K. A., Freemon, F. R. 1981. Pokeweed poisoning. South. Med. J., 74: 639-640.

Lawrence, R. A. 1990. The clinical effects of pokeweed root ingestion upon 32 adults. Vet. Hum. Toxicol., 32: 369.

Lewis, W. H., Smith, P. R. 1979. Poke root herbal tea poisoning. J. Am. Med. Assoc., 242: 2759-2760.

Stein, Z. L. 1979. Pokeweed-induced gastroenteritis. Am. J. Hosp. Pharm., 36: 1303.

Sheep

General symptoms of poisoning:

[diarrhea](#)
[drowsiness](#)
[gastroenteritis](#)

[vomiting](#)

References:

Cooper, M. R., Johnson, A. W. 1984. Poisonous plants in Britain and their effects on animals and man. Her Majesty's Stationery Office, London, England. 305 pp.

Swine

General symptoms of poisoning:

[death](#)

[gait, unsteady](#)

[gastroenteritis](#)

[liver, congestion of](#)

[muscle twitching](#)

[paralysis, posterior](#)

Notes on poisoning:

Swine are most frequently poisoned by pokeweed. Symptoms include staggering, vomiting, posterior paralysis, tremors, and death. Post-mortem findings show swollen, dark liver and severe hemorrhagic gastritis (Patterson 1929).

References:

Patterson, F. D. 1929. Pokeweed causes heavy losses in swine herd. Vet. Med. Small Anim. Clin., 24: 114.

Turkeys

General symptoms of poisoning:

[ascites](#)

[gall bladder, enlarged](#)

[hock, swollen](#)

[weight gain, reduced](#)

Notes on poisoning:

Experimental feeding of mashed berries to turkey poults caused weight-gain reduction, ascites, and swollen hocks, causing unsteadiness. Enlarged gall bladder filled with brown fluid was common in dead birds. Wild birds ingest the berries and spread seeds; no toxic cases have been mentioned. Chickens are not poisoned by the berries (Barnett 1975, Cooper and Johnson 1984).

References:

Barnett, B. D. 1975. Toxicity of pokeberries (fruit of *Phytolacca americana* Large) for turkey poults. *Poult. Sci.*, 54: 1215-1217.

[Another search?](#)

[Français](#) | [Contact Us](#) | [Help](#) | [Search](#) | [Canada site](#)

[Coming Events](#) | [About CBIF](#) | [Links](#) | [Reports and Publications](#) |

[Home](#)

Date modified: 2003-02-06

[Important Notices](#)



Français	Contact us	Help	Search	Canada site
Coming events	About CBIF	Links	Reports and publications	Home

Canadian Biodiversity Information Facility



Notes on poisoning: *Pinus ponderosa*

[Introduction](#)[Interactive](#)[All poisonous plants by Botanical name](#)[All poisonous plants by Common name](#)[Important WWW Poisonous Plants sites](#)

General poisoning notes:

Ponderosa pine (*Pinus ponderosa*) is a native tree in British Columbia. Pregnant cows that ingest the needles abort within 2 days to 2 weeks. Calves near full term may be born in good condition. Cows in the third trimester are affected; the problem usually occurs during winter and spring, when forage is scarce. Cows may retain the placenta. If medical attention is not given, a high degree of fatality can occur. Annual losses in the entire western United States have been estimated at 4.5 million dollars. This problem has also occurred in British Columbia (MacDonald 1952, Stevenson et al. 1972, Gartner et al. 1988, Lacey et al. 1988).

References:

Gartner, F. R., Johnson, F. D., Morgan, P. 1988. Cattle abortion from ponderosa pine needles: ecological and range management considerations. Pages 71-94 in James, L. F., Ralphs, M. H., Nielsen, D. B., eds. The ecology and economic impact of poisonous plants on livestock production. Westview Press, Boulder, Colo., USA. 428 pp.

James, L. F., Call, J. W. 1972. Pine-needle (*Pinus ponderosa*) - induced abortion in range cattle. Cornell Vet., 62: 519-524.

Lacey, J. R., James, L. F., Short, R. E. 1988. Ponderosa pine: economic impact. Pages 95-106 in James, L. F., Ralphs, M. H., Nielsen, D. B., eds. The ecology and economic impact of poisonous plants on livestock production. Westview Press, Boulder, Colo., USA. 428 pp.

MacDonald, M. A. 1952. Pine needle abortion in range beef cattle. J. Range Manage., 5: 150-155.

Molyneux, R. J., Baker, D. C., Short, R. E. 1988. Effects of various parts of the ponderosa pine on bovine pregnancy. J.

Anim. Sci., 66(1): 372.

Murdoch, W. J., Becerra, V. M., Mills, K. W., Robinson, J. L. 1989. Evaluation of histopathologic and physiologic changes in cows having premature births after consuming ponderosa pine needles. Am. J. Vet. Res., 50: 285-289.

Nomenclature:

Scientific Name: *Pinus ponderosa* Dougl.

Vernacular name(s): ponderosa pine

Scientific family name: *Pinaceae*

Vernacular family name: pine

Go to ITIS^{*ca} for more taxonomic information on: [Pinus ponderosa](#)

References:

Agriculture Quebec. 1975. Noms des maladies des plantes du Canada/ Names of plant diseases in Canada. , Quebec City, Que., Canada. 288 pp.

Alex, J. F., Cayouette, R., Mulligan, G. A. 1980. Common and botanical names of weeds in Canada/Noms populaire et scientifiques des plantes nuisibles du Canada. Revised. Agric. Can. Publ., Ottawa, Ont., Canada. 132 pp.

Bailey, L. H., Bailey, E. Z. 1976. Hortus third. Revised. MacMillan, New York, N.Y., USA. 1290 pp.

Scoggan, H. J. 1978, 1979. The flora of Canada. Nat. Mus. Nat. Sci. (Ottawa) Publ. Bot. 7(1)-7(4). 1711 pp.

Van Wijk, H. L. 1911. A dictionary of plant names. Martinus Nijhoff, The Hague, The Netherlands. 1444 pp.

Victorin, M. 1964. Flore Laurentienne. 2nd ed. Univ. Montreal, Montreal, Que., Canada. 952 pp.

Geographic Information

British Columbia

References:

Bailey, L. H., Bailey, E. Z. 1976. Hortus third. Revised. MacMillan, New York, N.Y., USA. 1290 pp.

Boivin, B. 1966, 1967. Énumération des plantes du Canada.

Provencheria 6. Nat. Can. (Que.) 93: 253-274; 371-437; 583-646; 989-1063. 94: 131-157; 471-528; 625-655.

Image or illustration

Pinus ponderosa:

Images: images.google.com

Toxic parts:

needles (pine)

young shoots

References:

Gartner, F. R., Johnson, F. D., Morgan, P. 1988. Cattle abortion from ponderosa pine needles: ecological and range management considerations. Pages 71-94 in James, L. F., Ralphs, M. H., Nielsen, D. B., eds. The ecology and economic impact of poisonous plants on livestock production. Westview Press, Boulder, Colo., USA. 428 pp.

James, L. F., Call, J. W. 1972. Pine-needle (*Pinus ponderosa*) - induced abortion in range cattle. Cornell Vet., 62: 519-524.

MacDonald, M. A. 1952. Pine needle abortion in range beef cattle. J. Range Manage., 5: 150-155.

Molyneux, R. J., Baker, D. C., Short, R. E. 1988. Effects of various parts of the ponderosa pine on bovine pregnancy. J. Anim. Sci., 66(1): 372.

Murdoch, W. J., Becerra, V. M., Mills, K. W., Robinson, J. L. 1989. Evaluation of histopathologic and physiologic changes in cows having premature births after consuming ponderosa pine needles. Am. J. Vet. Res., 50: 285-289.

Notes on Toxic plant chemicals:

Although no chemical has been proved to cause toxicity and abortion in cattle, several toxic compounds have been suspected, including diterpene resin acids. Additional factors such as stage of gestation when ingestion occurs, environmental stress, and condition of the cow compound the problem. Inducting experimental abortion has not been consistent (Gartner et al. 1988).

Toxic plant chemicals:

unknown chemical

References:

Gartner, F. R., Johnson, F. D., Morgan, P. 1988. Cattle abortion from ponderosa pine needles: ecological and range management considerations. Pages 71-94 in James, L. F., Ralphs, M. H., Nielsen, D. B., eds. The ecology and economic impact of poisonous plants on livestock production. Westview Press, Boulder, Colo., USA. 428 pp.

Animals/Human Poisoning:

Note: When an animal is listed without additional information, the literature (as of 1993) contained no detailed explanation.

Cattle

General symptoms of poisoning:

[abortion](#)

[cervix dilation,narrow](#)

[death](#)

[fetus, dead](#)

[metritis septic](#)

[parturition, early](#)

[placenta, persistent](#)

[progesterone,decreased](#)

[uterine hemorrhage](#)

References:

James, L. F., Call, J. W. 1972. Pine-needle (*Pinus ponderosa*) - induced abortion in range cattle. Cornell Vet., 62: 519-524.

MacDonald, M. A. 1952. Pine needle abortion in range beef cattle. J. Range Manage., 5: 150-155.

Molyneux, R. J., Baker, D. C., Short, R. E. 1988. Effects of various parts of the ponderosa pine on bovine pregnancy. J. Anim. Sci., 66(1): 372.

Murdoch, W. J., Becerra, V. M., Mills, K. W., Robinson, J. L. 1989. Evaluation of histopathologic and physiologic changes in cows having premature births after consuming ponderosa pine needles. Am. J. Vet. Res., 50: 285-289.

[Another search?](#)

[Français](#) | [Contact Us](#) | [Help](#) | [Search](#) | [Canada site](#)
[Coming Events](#) | [About CBIF](#) | [Links](#) | [Reports and Publications](#) |
[Home](#)

Date modified: 2003-02-06

[Important Notices](#)



Français	Contact us	Help	Search	Canada site
Coming events	About CBIF	Links	Reports and publications	Home

Canadian Biodiversity Information Facility



Notes on poisoning: *Podophyllum peltatum*

[Introduction](#)[Interactive](#)[All poisonous plants by Botanical name](#)[All poisonous plants by Common name](#)[Important WWW Poisonous Plants sites](#)

General poisoning notes:

May-apple (*Podophyllum peltatum*) is a native herb of moist woods in parts of southeastern Canada. May-apple extracts have been used in folk medicine and pharmaceuticals. Misuse has caused toxic reactions and even fatalities. Workers in the extraction process have developed dermatitis. Ingesting the ripe fruit may, at worst, cause catharsis. Cattle, sheep, and swine have been poisoned after ingesting may-apple vegetation (McIntosh 1928, Rosenstein et al. 1976).

References:

- Cassidy, D. E., Drewry, J., Fanning, J. P. 1982. *Podophyllum* toxicity: a report of a fatal case and a review of the literature. J. Toxicol. Clin. Toxicol., 19: 35-44.
- Kingsbury, J. M. 1964. Poisonous plants of the United States and Canada. Prentice-Hall Inc., Englewood Cliffs, N.J., USA. 626 pp.
- McIntosh, R. A. 1928. May apple poisoning in a cow. Ont. Vet. Coll. Rep., 29: 18-20.
- Rosenstein, G., Rosenstein, H., Freeman, M., Weston, N. 1976. Podophyllum - a dangerous laxative. Pediatrics, 57: 419-421.

Nomenclature:

Scientific Name: *Podophyllum peltatum* L.

Vernacular name(s): May-apple

Scientific family name: *Berberidaceae*

Vernacular family name: barberry

Go to ITIS*^{ca} for more taxonomic information on: [Podophyllum](#)

[peltatum](#)

References:

Agriculture Quebec. 1975. Noms des maladies des plantes du Canada/ Names of plant diseases in Canada. , Quebec City, Que., Canada. 288 pp.

Alex, J. F., Cayouette, R., Mulligan, G. A. 1980. Common and botanical names of weeds in Canada/Noms populaire et scientifiques des plantes nuisibles du Canada. Revised. Agric. Can. Publ., Ottawa, Ont., Canada. 132 pp.

Bailey, L. H., Bailey, E. Z. 1976. Hortus third. Revised. MacMillan, New York, N.Y., USA. 1290 pp.

Scoggan, H. J. 1978, 1979. The flora of Canada. Nat. Mus. Nat. Sci. (Ottawa) Publ. Bot. 7(1)-7(4). 1711 pp.

Van Wijk, H. L. 1911. A dictionary of plant names. Martinus Nijhoff, The Hague, The Netherlands. 1444 pp.

Victorin, M. 1964. Flore Laurentienne. 2nd ed. Univ. Montreal, Montreal, Que., Canada. 952 pp.

Geographic Information

Nova Scotia

Ontario

Quebec

References:

Bailey, L. H., Bailey, E. Z. 1976. Hortus third. Revised. MacMillan, New York, N.Y., USA. 1290 pp.

Boivin, B. 1966, 1967. Énumération des plantes du Canada. Provencheria 6. Nat. Can. (Que.) 93: 253-274; 371-437; 583-646; 989-1063. 94: 131-157; 471-528; 625-655.

Image or illustration

Podophyllum peltatum:

Images: images.google.com

Notes on Poisonous plant parts:

All parts of the plant contain toxic chemicals, although the fruit may cause only slight catharsis. alpha- and beta-peltatin are found in the rhizomes (Rosenstein et al. 1976, Lampe and McCann

1986).

Toxic parts:

all parts

leaves

stems

References:

Lampe, K. F., McCann, M. A. 1985. AMA Handbook of poisonous and injurious plants. American Medical Assoc. Chicago, Ill., USA. 432 pp.

Rosenstein, G., Rosenstein, H., Freeman, M., Weston, N. 1976. Podophyllum - a dangerous laxative. Pediatrics, 57: 419-421.

Notes on Toxic plant chemicals:

The purgative podophylloresin, the glucoside of podophyllotoxin, and alpha- and beta-peltatin produce toxic reactions in animals. The LD-50 of podophyllotoxin, administered orally to mice, is 90 mg/kg (Rosenstein et al. 1976, Lampe and McCann 1986).

Toxic plant chemicals:

alpha- and beta- peltatin

podophylloresin

References:

Lampe, K. F., McCann, M. A. 1985. AMA Handbook of poisonous and injurious plants. American Medical Assoc. Chicago, Ill., USA. 432 pp.

Rosenstein, G., Rosenstein, H., Freeman, M., Weston, N. 1976. Podophyllum - a dangerous laxative. Pediatrics, 57: 419-421.

Animals/Human Poisoning:

Note: When an animal is listed without additional information, the literature (as of 1993) contained no detailed explanation.

Cattle

General symptoms of poisoning:

[agitation](#)

[lacrimation, severe](#)

[pupil dilation](#)

[salivation](#)

Notes on poisoning:

A cow in Ontario experienced toxic symptoms after ingesting may-apple. The symptoms included salivation, moaning, excitation, swollen eyes and muzzle, lacrimation, pupil dilation, and congestion of all visible mucous membranes (McIntosh 1928).

References:

McIntosh, R. A. 1928. May apple poisoning in a cow. Ont. Vet. Coll. Rep., 29: 18-20.

Humans

General symptoms of poisoning:

[catharsis](#)

[coma](#)

[confusion](#)

[conjunctivitis](#)

[death](#)

[erythema](#)

[gastroenteritis](#)

[vomiting](#)

Notes on poisoning:

In humans most cases of poisoning from May-apple have resulted from the use or handling of the pharmaceutical extracts from the plant. Because of its irritant qualities, may-apple has been used topically to remove papilloma and warts. It has also been used as an abortifacient, as shown experimentally with mice and rabbits. The use of these extracts as a laxative in pregnancy has been discouraged. The extracts have been shown to have an antimitotic capacity. In a case of suicide, a man ingested a bottle containing 10-11 g of podophyllum extract. Initially he experienced few symptoms, but after 10 h the patient became confused and comatose; respiration was assisted and the man died after 39 h (Rosenstein et al. 1976, Cassidy et al. 1982).

References:

Cassidy, D. E., Drewry, J., Fanning, J. P. 1982. *Podophyllum* toxicity: a report of a fatal case and a review of the literature. J. Toxicol. Clin. Toxicol., 19: 35-44.

Rosenstein, G., Rosenstein, H., Freeman, M., Weston, N. 1976.

Podophyllum - a dangerous laxative. Pediatrics, 57: 419-421.

Swine

General symptoms of poisoning:

[death](#)

Notes on poisoning:

Deaths were reported after few symptoms in swine that ingested young shoots of May-apple (Kingsbury 1964).

References:

Kingsbury, J. M. 1964. Poisonous plants of the United States and Canada. Prentice-Hall Inc., Englewood Cliffs, N.J., USA. 626 pp.

McIntosh, R. A. 1928. May apple poisoning in a cow. Ont. Vet. Coll. Rep., 29: 18-20.

[Another search?](#)

[Français](#) | [Contact Us](#) | [Help](#) | [Search](#) | [Canada site](#)

[Coming Events](#) | [About CBIF](#) | [Links](#) | [Reports and Publications](#) |

[Home](#)

Date modified: 2003-02-06

[Important Notices](#)



Français	Contact us	Help	Search	Canada site
Coming events	About CBIF	Links	Reports and publications	Home

Canadian Biodiversity Information Facility



Notes on poisoning: *Primula obconica*

[Introduction](#)[Interactive](#)[All poisonous plants by Botanical name](#)[All poisonous plants by Common name](#)[Important WWW Poisonous Plants sites](#)

General poisoning notes:

Primula (*Primula obconica*) is an ornamental herb that may be grown indoors or outdoors. Sensitized humans develop dermatitis from exposure to the allergen contained in hairs on leaves and other plant parts. Pollen also can cause dermatitis. Some other species of the genus *Primula* can cause dermatitis as well (Mitchell and Rook 1979).

References:

Fernandez De Corr,s, L., Leanizbarrutia, I., Munoz, D., Bernaola, G., Fernandez, E. 1987. Contact dermatitis from a neighbour's primula. *Contact Dermatitis*, 16: 234-235.

Mitchell, J. C., Rook, A. 1979. *Botanical dermatology*. Greenglass Ltd, Vancouver, B.C., Canada. 787 pp.

Spoerke, D. G., Smolinske, S. C. 1990. *Toxicity of houseplants*. CRC Press, Inc., Boca Raton, Fla., USA. 335 pp.

Nomenclature:

Scientific Name: *Primula obconica* Hance.

Vernacular name(s): primula

Scientific family name: *Primulaceae*

Vernacular family name: primrose

References:

Agriculture Quebec. 1975. *Noms des maladies des plantes du Canada/ Names of plant diseases in Canada*. , Quebec City, Que., Canada. 288 pp.

Alex, J. F., Cayouette, R., Mulligan, G. A. 1980. Common and botanical names of weeds in Canada/Noms populaire et scientifiques des plantes nuisibles du Canada. Revised. Agric. Can. Publ., Ottawa, Ont., Canada. 132 pp.

Bailey, L. H., Bailey, E. Z. 1976. Hortus third. Revised. MacMillan, New York, N.Y., USA. 1290 pp.

Scoggan, H. J. 1978, 1979. The flora of Canada. Nat. Mus. Nat. Sci. (Ottawa) Publ. Bot. 7(1)-7(4). 1711 pp.

Van Wijk, H. L. 1911. A dictionary of plant names. Martinus Nijhoff, The Hague, The Netherlands. 1444 pp.

Victorin, M. 1964. Flore Laurentienne. 2nd ed. Univ. Montreal, Montreal, Que., Canada. 952 pp.

Geographic Information

Plant or plant parts used in or around the home.

References:

Bailey, L. H., Bailey, E. Z. 1976. Hortus third. Revised. MacMillan, New York, N.Y., USA. 1290 pp.

Boivin, B. 1966, 1967. Énumération des plantes du Canada. Provencheria 6. Nat. Can. (Que.) 93: 253-274; 371-437; 583-646; 989-1063. 94: 131-157; 471-528; 625-655.

Image or illustration

Primula obconica:

Images: images.google.com

Notes on Poisonous plant parts:

Minute glandular hairs accumulate the allergen, which is exuded in tiny drops. The hairs are most common on the leaves but are also found on other plant parts. The pollen grains can also cause dermatitis (Mitchell and Rook 1979).

Toxic parts:

flowers
hairs
leaves

References:

Mitchell, J. C., Rook, A. 1979. Botanical dermatology. Greenglass Ltd, Vancouver, B.C., Canada. 787 pp.

Notes on Toxic plant chemicals:

Primin, a quinone, is the allergen in primula. This chemical is found in minute (0.05-0.3 mm long) glandular hairs. The concentrated allergen accumulates as irregular resinous drops on the hairs. Highly sensitive people may react to 20 micro gm of the allergen. The allergen content of primula is highest between April and August, when grown outdoors (Mitchell and Rook 1979).

Toxic plant chemicals:

primin

References:

Mitchell, J. C., Rook, A. 1979. Botanical dermatology. Greenglass Ltd, Vancouver, B.C., Canada. 787 pp.

Animals/Human Poisoning:

Note: When an animal is listed without additional information, the literature (as of 1993) contained no detailed explanation.

Humans

General symptoms of poisoning:

[blistering](#)

[conjunctivitis](#)

[eczema](#)

[erythema](#)

[fever](#)

References:

Fernandez De Corr,s, L., Leanizbarrutia, I., Munoz, D., Bernaola, G., Fernandez, E. 1987. Contact dermatitis from a neighbour's primula. Contact Dermatitis, 16: 234-235.

[Another search?](#)

[Français](#) | [Contact Us](#) | [Help](#) | [Search](#) | [Canada site](#)
[Coming Events](#) | [About CBIF](#) | [Links](#) | [Reports and Publications](#) |
[Home](#)

Date modified: 2003-02-06

[Important Notices](#)



Français	Contact us	Help	Search	Canada site
Coming events	About CBIF	Links	Reports and publications	Home

Canadian Biodiversity Information Facility



Notes on poisoning: *Prunus pensylvanica*

[Introduction](#)[Interactive](#)[All poisonous plants by Botanical name](#)[All poisonous plants by Common name](#)[Important WWW Poisonous Plants sites](#)

General poisoning notes:

Pin cherry (*Prunus pensylvanica*) is a native tree found throughout most of Canada. The leaves have an average N rate of 91 mg/100 g, with as much as 143 mg/100 g recorded. These levels are potentially lethal to livestock if ingested. M. Pitcher (personal communication) notes that captive moose in Newfoundland and Alberta nature parks and zoos regurgitate a gray, chalky, paste-like substance when fed pin cherry browse mixed with their normal browse, white birch (*Betula papyrifera*). Livestock that ingest pin cherry plant material can be poisoned (Kingsbury 1964).

References:

Kingsbury, J. M. 1964. Poisonous plants of the United States and Canada. Prentice-Hall Inc., Englewood Cliffs, N.J., USA. 626 pp.

Nomenclature:

Scientific Name: *Prunus pensylvanica* L. f.

Vernacular name(s): pin cherry

Scientific family name: *Rosaceae*

Vernacular family name: rose

Go to ITIS*^{ca} for more taxonomic information on: [Prunus pensylvanica](#)

References:

Agriculture Quebec. 1975. Noms des maladies des plantes du Canada/ Names of plant diseases in Canada. , Quebec City, Que., Canada. 288 pp.

Alex, J. F., Cayouette, R., Mulligan, G. A. 1980. Common and

botanical names of weeds in Canada/Noms populaire et scientifiques des plantes nuisibles du Canada. Revised. Agric. Can. Publ., Ottawa, Ont., Canada. 132 pp.

Bailey, L. H., Bailey, E. Z. 1976. Hortus third. Revised. MacMillan, New York, N.Y., USA. 1290 pp.

Scoggan, H. J. 1978, 1979. The flora of Canada. Nat. Mus. Nat. Sci. (Ottawa) Publ. Bot. 7(1)-7(4). 1711 pp.

Van Wijk, H. L. 1911. A dictionary of plant names. Martinus Nijhoff, The Hague, The Netherlands. 1444 pp.

Victorin, M. 1964. Flore Laurentienne. 2nd ed. Univ. Montreal, Montreal, Que., Canada. 952 pp.

Geographic Information

Alberta
British Columbia
Labrador
Manitoba
New Brunswick
Northwest Territories
Nova Scotia
Ontario
Prince Edward Island
Quebec
Saskatchewan

References:

Bailey, L. H., Bailey, E. Z. 1976. Hortus third. Revised. MacMillan, New York, N.Y., USA. 1290 pp.

Boivin, B. 1966, 1967. Énumération des plantes du Canada. Provencheria 6. Nat. Can. (Que.) 93: 253-274; 371-437; 583-646; 989-1063. 94: 131-157; 471-528; 625-655.

Image or illustration

Prunus pensylvanica:

Images: images.google.com

Toxic parts:

leaves

References:

Kingsbury, J. M. 1964. Poisonous plants of the United States and Canada. Prentice-Hall Inc., Englewood Cliffs, N.J., USA. 626 pp.

Toxic plant chemicals:

amygdalin

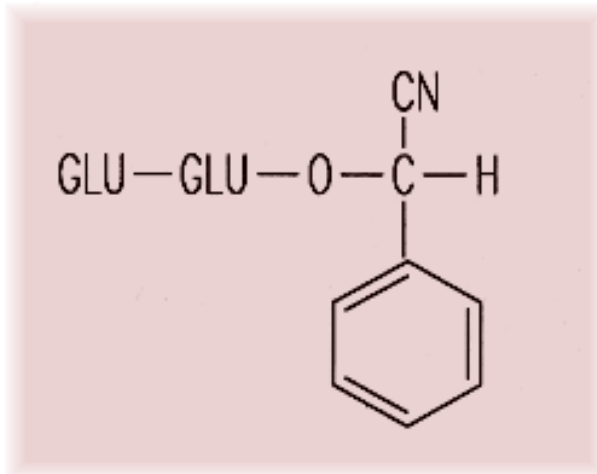

prunasin

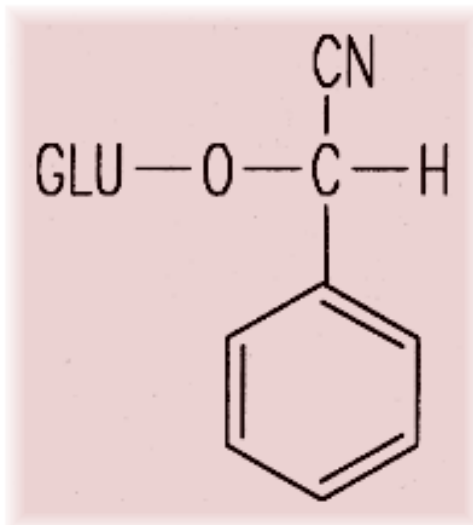

Chemical diagram(s) are courtesy of [Ruth McDiarmid](#), Biochemistry Technician, Kamloops Range Station, Agriculture and Agri-Food Canada, Kamloops, British Columbia, Canada.

References:

Cheeke, P. R., Shull, L. R. 1985. Natural toxicants in feeds and poisonous plants. AVI Publishing Company, Inc., Westport, Conn., USA. 492 pp.

Animals/Human Poisoning:

Note: When an animal is listed without additional information, the literature (as of 1993) contained no detailed explanation.

Moose

General symptoms of poisoning:

[vomiting](#)

Notes on poisoning:

M. Pitcher (personal communication) states that captive moose develop an adverse reaction to pin cherry when the plant is inadvertently mixed with their usual browse, white birch (*Betula papyrifera*). The moose regurgitate a gray, chalky paste-like substance. This has been noted both in Newfoundland and Alberta.

References:

Kingsbury, J. M. 1964. Poisonous plants of the United States and Canada. Prentice-Hall Inc., Englewood Cliffs, N.J., USA. 626 pp.

[Another search?](#)

[Français](#) | [Contact Us](#) | [Help](#) | [Search](#) | [Canada site](#)

[Coming Events](#) | [About CBIF](#) | [Links](#) | [Reports and Publications](#) |

[Home](#)

Date modified: 2003-02-06

[Important Notices](#)



Français	Contact us	Help	Search	Canada site
Coming events	About CBIF	Links	Reports and publications	Home

Canadian Biodiversity Information Facility



Notes on poisoning: *Prunus serotina*

[Introduction](#)[Interactive](#)[All poisonous plants by Botanical name](#)[All poisonous plants by Common name](#)[Important WWW Poisonous Plants sites](#)

General poisoning notes:

Black cherry (*Prunus serotina*) is a native tree found in eastern Canada. It is occasionally cultivated as an ornamental. The plant contains chemicals that can release hydrogen cyanide in animals. All types of animals can be poisoned by ingesting leaves and twigs. There have been claims of children dying after ingesting an excessive number of seeds, found in the berries. Cyanide poisoning interferes with respiration and blood circulation; death is often swift (Kingsbury 1964, Cheeke 1983, Cheeke and Schull 1985).



References:

- Cheeke, P. R., Shull, L. R. 1985. Natural toxicants in feeds and poisonous plants. AVI Publishing Company, Inc., Westport, Conn., USA. 492 pp.
- Hardin, J. W., Arena, J. M. 1969. Human poisoning from native and cultivated plants. Duke University Press, Durham, N.C., USA. 167 pp.
- Keeler, R. F. 1983. Naturally occurring teratogens from plants. Pages 161-199 in Keeler, R. F., Tu, A. T., eds. Handbook of natural toxins. Vol. 1. Plant and Fungal toxins. Marcel Dekker, Inc., New York, N.Y., USA. 934 pp.
- Kingsbury, J. M. 1964. Poisonous plants of the United States and Canada. Prentice-Hall Inc., Englewood Cliffs, N.J., USA. 626 pp.
- Lampe, K. F., McCann, M. A. 1985. AMA Handbook of poisonous and injurious plants. American Medical Assoc. Chicago, Ill., USA. 432 pp.
- Mulligan, G. A., Munro, D. B. 1981. The biology of Canadian weeds. 51. *Prunus virginiana* L. and *P. serotina* Ehrh. Can. J. Plant Sci., 61: 977-992.

Nomenclature:

Scientific Name: *Prunus serotina* Ehrh.

Vernacular name(s): black cherry

Scientific family name: *Rosaceae*

Vernacular family name: rose

Go to ITIS^{*ca} for more taxonomic information on: [Prunus serotina](#)

References:

Agriculture Quebec. 1975. Noms des maladies des plantes du Canada/ Names of plant diseases in Canada. , Quebec City, Que., Canada. 288 pp.

Alex, J. F., Cayouette, R., Mulligan, G. A. 1980. Common and botanical names of weeds in Canada/Noms populaire et scientifiques des plantes nuisibles du Canada. Revised. Agric. Can. Publ., Ottawa, Ont., Canada. 132 pp.

Bailey, L. H., Bailey, E. Z. 1976. Hortus third. Revised. MacMillan, New York, N.Y., USA. 1290 pp.

Scoggan, H. J. 1978, 1979. The flora of Canada. Nat. Mus. Nat. Sci. (Ottawa) Publ. Bot. 7(1)-7(4). 1711 pp.

Van Wijk, H. L. 1911. A dictionary of plant names. Martinus Nijhoff, The Hague, The Netherlands. 1444 pp.

Victorin, M. 1964. Flore Laurentienne. 2nd ed. Univ. Montreal, Montreal, Que., Canada. 952 pp.

Geographic Information

New Brunswick

Nova Scotia

Ontario

Quebec

References:

Bailey, L. H., Bailey, E. Z. 1976. Hortus third. Revised. MacMillan, New York, N.Y., USA. 1290 pp.

Boivin, B. 1966, 1967. Énumération des plantes du Canada. Provencheria 6. Nat. Can. (Que.) 93: 253-274; 371-437; 583-646; 989-1063. 94: 131-157; 471-528; 625-655.

Image or illustration

Prunus serotina:

Images: images.google.com

Notes on Poisonous plant parts:

The leaves of black cherry contain on average of 212 mg hydrocyanic acid (HCN) per 100 g of fresh leaves. A lethal dose of HCN for humans is between 0.5 and 0.35 mg/kg of body weight. The lethal dose of HCN for cattle and sheep is about 2.0 mg/kg of body weight (Kingsbury 1964).

Toxic parts:

leaves

seeds

twigs

References:

Kingsbury, J. M. 1964. Poisonous plants of the United States and Canada. Prentice-Hall Inc., Englewood Cliffs, N.J., USA. 626 pp.

Notes on Toxic plant chemicals:

Two cyanogenic glycosides are found in black cherry. Amygdalin and prunasin are found in the leaves, twigs, and seeds (Cheeke and Schull 1985). Hydrogen cyanide is formed when the glycosides are hydrolyzed by plant enzymes after damage or by rumen organisms. Majak et al. (1990) found that cyanide production is most rapid in cattle that had been starved for a day. High rates of cyanide production were obtained in the rumen after the animal ingested fresh alfalfa and cubed alfalfa hay.

Toxic plant chemicals:

amygdalin

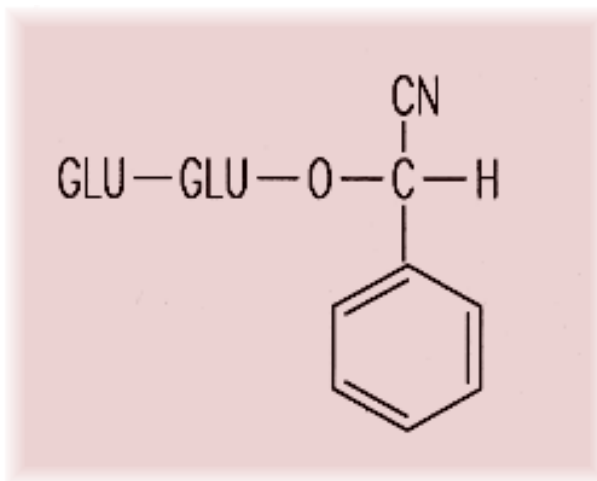

prunasin

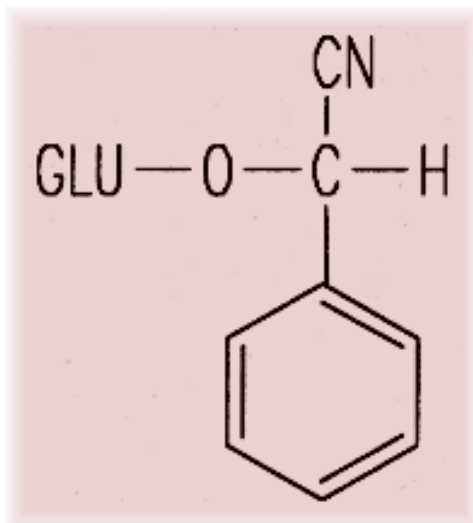

Chemical diagram(s) are courtesy of [Ruth McDiarmid](#), Biochemistry Technician, Kamloops Range Station, Agriculture and Agri-Food Canada, Kamloops, British Columbia, Canada.

References:

Cheeke, P. R., Shull, L. R. 1985. Natural toxicants in feeds and poisonous plants. AVI Publishing Company, Inc., Westport, Conn., USA. 492 pp.

Majak, W., McDiarmid, R. E., Hall, J. W., Cheng, K.-J. 1990. Factors that determine rates of cyanogenesis in bovine ruminal fluid in vitro. J. Anim. Sci., 68: 1648-1655.

Animals/Human Poisoning:

Note: When an animal is listed without additional information, the literature (as of 1993) contained no detailed explanation.

Cattle

General symptoms of poisoning:

[breathing, labored](#)

[death by asphyxiation](#)

[gait, staggering](#)

[muscle spasms](#)

[pupil dilation](#)

Notes on poisoning:

Symptoms of cyanide poisoning are common to all animals. Symptoms may be minimal, with difficult breathing followed by death. Other signs of toxicity may include a short period of stimulation followed by slow pulse, dilated pupils, spasms, staggering, loss of consciousness, and death, which results from asphyxiation. Postmortem findings include bright red blood and congestion of internal organs (Kingsbury 1964, Scimeca and Oehme 1985).

References:

Cheeke, P. R., Shull, L. R. 1985. Natural toxicants in feeds and poisonous plants. AVI Publishing Company, Inc., Westport, Conn., USA. 492 pp.

Kingsbury, J. M. 1964. Poisonous plants of the United States and Canada. Prentice-Hall Inc., Englewood Cliffs, N.J., USA. 626 pp.

Horses

General symptoms of poisoning:

[breathing, labored](#)

[coma](#)

[death by asphyxiation](#)

[dyspnea](#)

[gait, staggering](#)

[muscle spasms](#)

[paralysis](#)

Notes on poisoning:

See notes under cattle for more information.

References:

Kingsbury, J. M. 1964. Poisonous plants of the United States and Canada. Prentice-Hall Inc., Englewood Cliffs, N.J., USA. 626 pp.

Humans

General symptoms of poisoning:

[abdominal pains](#)

[coma](#)

[death](#)

[lethargy](#)

[sweating](#)

[vomiting](#)

Notes on poisoning:

Ingesting large quantities of berries has caused poisoning, because of the toxin in the seeds. Children have been poisoned by chewing twigs or drinking tea made from the leaves. Symptoms include difficult breathing, voice paralysis, twitching, spasms, coma of short duration, and death. Cyanide poisoning can occur quickly, with few symptoms (Hardin and Arena 1969).

References:

Hardin, J. W., Arena, J. M. 1969. Human poisoning from native and cultivated plants. Duke University Press, Durham, N.C., USA. 167 pp.

Lampe, K. F., McCann, M. A. 1985. AMA Handbook of poisonous and injurious plants. American Medical Assoc. Chicago, Ill., USA. 432 pp.

Sheep

General symptoms of poisoning:

[breathing, labored](#)

[coma](#)

[convulsions](#)

[death by asphyxiation](#)

[gait, staggering](#)

[muscle spasms](#)

[paralysis](#)

[unconsciousness](#)

Notes on poisoning:

See notes under cattle for more information.

References:

Kingsbury, J. M. 1964. Poisonous plants of the United States and

Canada. Prentice-Hall Inc., Englewood Cliffs, N.J., USA. 626 pp.

Swine

General symptoms of poisoning:

[limbs,lateral rotation](#)

References:

Keeler, R. F. 1983. Naturally occurring teratogens from plants. Pages 161-199 in Keeler, R. F., Tu, A. T., eds. Handbook of natural toxins. Vol. 1. Plant and Fungal toxins. Marcel Dekker, Inc., New York, N.Y., USA. 934 pp.

[Another search?](#)

[Français](#) | [Contact Us](#) | [Help](#) | [Search](#) | [Canada site](#)

[Coming Events](#) | [About CBIF](#) | [Links](#) | [Reports and Publications](#) |

[Home](#)

Date modified: 2003-02-06

[Important Notices](#)



Français	Contact us	Help	Search	Canada site
Coming events	About CBIF	Links	Reports and publications	Home

Canadian Biodiversity Information Facility



Notes on poisoning: *Prunus virginiana*

[Introduction](#)[Interactive](#)[All poisonous plants by Botanical name](#)[All poisonous plants by Common name](#)[Important WWW Poisonous Plants sites](#)

General poisoning notes:

Chokecherry (*Prunus virginiana*) is a native shrub or small tree found through most of Canada. Children have been poisoned and have died after ingesting large quantities of berries, which contain the seeds. All types of livestock can be poisoned by ingesting the plant material. Cattle and sheep have been poisoned by red chokecherry (Pardee 1847, Kingsbury 1964). Related species, including peach (*Prunus persica*) and apricot (*Prunus armeniaca*), have pits with enough toxin to cause poisoning and death in humans and animals.



References:

Kingsbury, J. M. 1964. Poisonous plants of the United States and Canada. Prentice-Hall Inc., Englewood Cliffs, N.J., USA. 626 pp.

Mulligan, G. A., Munro, D. B. 1981. The biology of Canadian weeds. 51. *Prunus virginiana* L. and *P. serotina* Ehrh. Can. J. Plant Sci., 61: 977-992.

Pardee, G. K. 1847. Case of poisoning by the wild cherry. West. Lancet, 6: 289-291.

Scimeca, J. M., Oehme, F. W. 1985. Postmortem guide to common poisonous plants of livestock. Vet. Hum. Toxicol., 27: 189-199.

Nomenclature:

Scientific Name: *Prunus virginiana* L.

Vernacular name(s): red chokecherry

Scientific family name: *Rosaceae*

Vernacular family name: rose

Go to ITIS*^{ca} for more taxonomic information on: [Prunus virginiana](#)

References:

Agriculture Quebec. 1975. Noms des maladies des plantes du Canada/ Names of plant diseases in Canada. , Quebec City, Que., Canada. 288 pp.

Alex, J. F., Cayouette, R., Mulligan, G. A. 1980. Common and botanical names of weeds in Canada/Noms populaire et scientifiques des plantes nuisibles du Canada. Revised. Agric. Can. Publ., Ottawa, Ont., Canada. 132 pp.

Bailey, L. H., Bailey, E. Z. 1976. Hortus third. Revised. MacMillan, New York, N.Y., USA. 1290 pp.

Scoggan, H. J. 1978, 1979. The flora of Canada. Nat. Mus. Nat. Sci. (Ottawa) Publ. Bot. 7(1)-7(4). 1711 pp.

Van Wijk, H. L. 1911. A dictionary of plant names. Martinus Nijhoff, The Hague, The Netherlands. 1444 pp.

Victorin, M. 1964. Flore Laurentienne. 2nd ed. Univ. Montreal, Montreal, Que., Canada. 952 pp.

Geographic Information

Alberta
British Columbia
Labrador
Manitoba
New Brunswick
Newfoundland
Nova Scotia
Ontario
Prince Edward Island
Quebec
Saskatchewan

References:

Bailey, L. H., Bailey, E. Z. 1976. Hortus third. Revised. MacMillan, New York, N.Y., USA. 1290 pp.

Boivin, B. 1966, 1967. Énumération des plantes du Canada. Provencheria 6. Nat. Can. (Que.) 93: 253-274; 371-437; 583-646; 989-1063. 94: 131-157; 471-528; 625-655.

Image or illustration

Prunus virginiana:

Images: images.google.com

Notes on Poisonous plant parts:

At all stages of growth, leaves of red chokecherry contained quantities of prunasin that were well above the minimum 1.4% level required for acute poisoning. Twigs also contained levels of prunasin at or above the level required to cause acute poisoning. Twigs developed more toxin during dry years. The prunasin level of buds and flowers was above the minimum level as well (Majak et al. 1981).

Toxic parts:

leaves
seeds
twigs

References:

Majak, W., McDiarmid, R. E., Hall, J. W. 1981. The cyanide potential of Saskatoon serviceberry (*Amelanchier alnifolia*) and chokecherry (*Prunus virginiana*). *Can. J. Anim. Sci.*, 61: 681-686.

Notes on Toxic plant chemicals:

Two cyanogenetic glycosides, amygdalin and prunasin, are found in red chokecherry plant material. Levels of HCN at 143-243 mg have been found in 100 g of leaves. The higher amounts apply to wilted leaves. A lethal dose in cattle occurs after ingesting fresh leaves equivalent to about 0.25% of body weight (Kingsbury 1964, Cheek and Schull 1985).

Toxic plant chemicals:

amygdalin

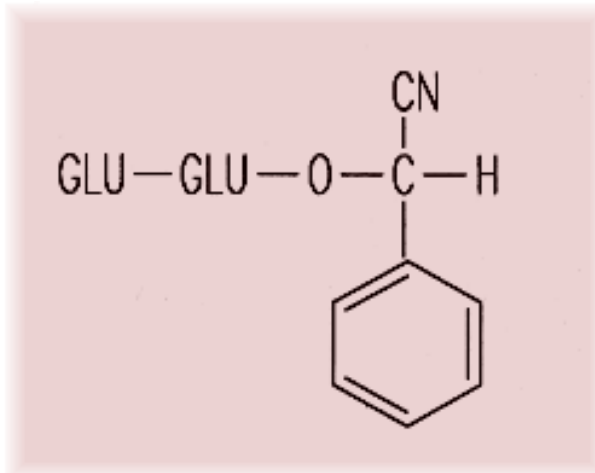

prunasin

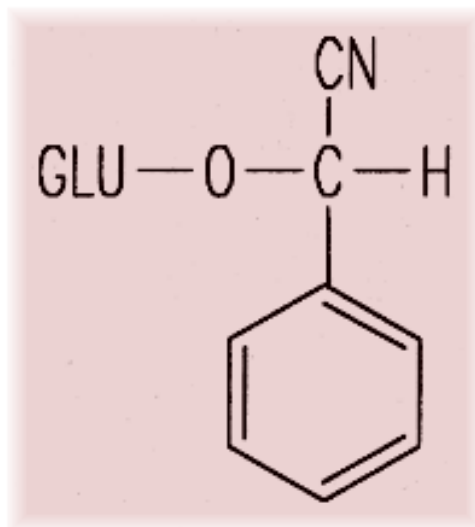

Chemical diagram(s) are courtesy of [Ruth McDiarmid](#), Biochemistry Technician, Kamloops Range Station, Agriculture and Agri-Food Canada, Kamloops, British Columbia, Canada.

References:

Cheeke, P. R., Shull, L. R. 1985. Natural toxicants in feeds and poisonous plants. AVI Publishing Company, Inc., Westport, Conn., USA. 492 pp.

Kingsbury, J. M. 1964. Poisonous plants of the United States and Canada. Prentice-Hall Inc., Englewood Cliffs, N.J., USA. 626 pp.

Animals/Human Poisoning:

Note: When an animal is listed without additional information, the literature (as of 1993) contained no detailed explanation.

Cattle

General symptoms of poisoning:

[agitation](#)

[coma](#)

[convulsions](#)

[death by asphyxiation](#)

[dyspnea](#)

[gait, staggering](#)

Notes on poisoning:

Experimental work on cattle showed that fresh leaves consumed at a rate equivalent to 0.25% of an animal's body weight constitute a lethal dose. Symptoms listed above are applicable to all types of animals. Postmortem findings usually show bright red blood and congested internal organs (Kingsbury 1964, Scimeca and Oehme

1985).

References:

Kingsbury, J. M. 1964. Poisonous plants of the United States and Canada. Prentice-Hall Inc., Englewood Cliffs, N.J., USA. 626 pp.

Scimeca, J. M., Oehme, F. W. 1985. Postmortem guide to common poisonous plants of livestock. *Vet. Hum. Toxicol.*, 27: 189-199.

Humans

General symptoms of poisoning:

[abdominal pains](#)

[babinski reflex](#)

[coma](#)

[convulsions](#)

[cyanosis](#)

[death by asphyxiation](#)

[vomiting](#)

Notes on poisoning:

Ingesting large quantities of red chokecherry fruits, without removing the seeds, has caused illness and death in children. The onset of symptoms is usually sudden and includes abdominal pain, vomiting, convulsions, inability to speak, labored breathing, coma, and death from asphyxiation. The blood is initially bright red because cell respiration is interrupted (Pardee 1847, Kingsbury 1964).

References:

Kingsbury, J. M. 1964. Poisonous plants of the United States and Canada. Prentice-Hall Inc., Englewood Cliffs, N.J., USA. 626 pp.

Pardee, G. K. 1847. Case of poisoning by the wild cherry. *West. Lancet*, 6: 289-291.

Sheep

General symptoms of poisoning:

[coma](#)

[convulsions](#)

[death by asphyxiation](#)

[dyspnea](#)

[paralysis](#)

Notes on poisoning:

See additional information under cattle.

References:

Kingsbury, J. M. 1964. Poisonous plants of the United States and Canada. Prentice-Hall Inc., Englewood Cliffs, N.J., USA. 626 pp.

[Another search?](#)

[Français](#) | [Contact Us](#) | [Help](#) | [Search](#) | [Canada site](#)

[Coming Events](#) | [About CBIF](#) | [Links](#) | [Reports and Publications](#) |

[Home](#)

Date modified: 2003-02-06

[Important Notices](#)



Français	Contact us	Help	Search	Canada site
Coming events	About CBIF	Links	Reports and publications	Home

Canadian Biodiversity Information Facility



Notes on poisoning: *Pteridium aquilinum*

[Introduction](#)[Interactive](#)[All poisonous plants by Botanical name](#)[All poisonous plants by Common name](#)[Important WWW Poisonous Plants sites](#)

General poisoning notes:

Bracken (*Pteridium aquilinum*) is a native fern that grows across most of Canada. This fern has caused sickness and loss of cattle in Canada and in other countries. Cattle, sheep, and wild animals have also been poisoned after ingesting bracken. Bracken contains several chemicals that cause problems. Thiaminase results in vitamin B1 deficiency in nonruminants such as horses and swine. Ptaquiloside, a carcinogen-mutagen, causes acute and chronic symptoms of illness in ruminants. The spores may contain carcinogens that can cause problems to animals and humans. The young fronds of bracken are ingested as human food, especially in Japan. They contain significant quantities of the carcinogen (Cheeke and Schull 1985, Fenwick 1988, Hirono 1989).

References:

[Cody, W. J., Crompton, C. W.](#) 1975. The biology of Canadian weeds. 15. *Pteridium aquilinum* (L.) Kuhn. Can. J. Plant Sci., 55: 1059-1072.

Cheeke, P. R., Shull, L. R. 1985. Natural toxicants in feeds and poisonous plants. AVI Publishing Company, Inc., Westport, Conn., USA. 492 pp.

Evans, I. A. 1976. Relationship between bracken and cancer. Bot. Linn. Soc., 73: 105-112.

Fenwick, G. R. 1988. Bracken (*Pteridium aquilinum*) - toxic effects and toxic constituents. J. Sci. Food Agric., 46: 147-173.

Hirono, I. 1989. Carcinogenic bracken glycosides. Pages 239-251 in Cheeke, P. R., ed. Toxicants of plant origin. Vol. II. Glycosides. CRC Press, Inc., Boca Raton, Fla., USA. 277 pp.

Hopkins, A. 1990. Bracken (*Pteridium aquilinum*): its distribution and animal health implications. Agric. Can. Res.

Branch Contrib., 146: 316-326.

Kelleway, R. A., Geovjian, L. 1978. Acute bracken fern poisoning in a 14-month-old horse. *Vet. Med. Small Anim. Clin.*, 73: 295-296.

Milne, R. 1988. Heathlands of England harbour cancer spores. *New Sci.*, 118: 23.

Nomenclature:

Scientific Name: *Pteridium aquilinum* (L.) Kuhn

Vernacular name(s): bracken

Scientific family name: *Polypodiaceae*

Vernacular family name: fern

Go to ITIS^{*ca} for more taxonomic information on: [Pteridium aquilinum](#)

References:

Agriculture Quebec. 1975. Noms des maladies des plantes du Canada/ Names of plant diseases in Canada. , Quebec City, Que., Canada. 288 pp.

Alex, J. F., Cayouette, R., Mulligan, G. A. 1980. Common and botanical names of weeds in Canada/Noms populaire et scientifiques des plantes nuisibles du Canada. Revised. Agric. Can. Publ., Ottawa, Ont., Canada. 132 pp.

Bailey, L. H., Bailey, E. Z. 1976. Hortus third. Revised. MacMillan, New York, N.Y., USA. 1290 pp.

Scoggan, H. J. 1978, 1979. The flora of Canada. Nat. Mus. Nat. Sci. (Ottawa) Publ. Bot. 7(1)-7(4). 1711 pp.

Van Wijk, H. L. 1911. A dictionary of plant names. Martinus Nijhoff, The Hague, The Netherlands. 1444 pp.

Victorin, M. 1964. Flore Laurentienne. 2nd ed. Univ. Montreal, Montreal, Que., Canada. 952 pp.

Geographic Information

Alberta
British Columbia
Labrador
Manitoba
New Brunswick
Newfoundland

Nova Scotia
Ontario
Prince Edward Island
Quebec

References:

Bailey, L. H., Bailey, E. Z. 1976. Hortus third. Revised. MacMillan, New York, N.Y., USA. 1290 pp.

Boivin, B. 1966, 1967. Énumération des plantes du Canada. Provencheria 6. Nat. Can. (Que.) 93: 253-274; 371-437; 583-646; 989-1063. 94: 131-157; 471-528; 625-655.

Image or illustration

Pteridium aquilinum:

Images: images.google.com

Notes on Poisonous plant parts:

All parts of bracken contain toxic chemicals. Ingesting fresh or dry fronds (leaves) or underground rhizomes has caused toxic signs and death in ruminants and nonruminants. After ingesting the young fronds, animals were found to be affected by carcinogenic compounds that the young fronds contain; these compounds may also cause problems in humans. The spores appear to be the most carcinogenic part of bracken and may cause problems in livestock. Humans who work outdoors in areas where bracken grows abundantly could also be at risk from the spores (Milne and Fenwick 1988, Milne 1988, Hirono 1989).

Toxic parts:

all parts
leaves
rhizome
spores
young shoots

References:

Fenwick, G. R. 1988. Bracken (*Pteridium aquilinum*) - toxic effects and toxic constituents. J. Sci. Food Agric., 46: 147-173.

Hirono, I. 1989. Carcinogenic bracken glycosides. Pages 239-251 in Cheeke, P. R., ed. Toxicants of plant origin. Vol. II. Glycosides. CRC Press, Inc., Boca Raton, Fla., USA. 277 pp.

Notes on Toxic plant chemicals:

A group of chemical compounds have been implicated in the various toxic properties of bracken. Thiaminase, an enzyme that decomposes vitamin B1, has caused toxic problems, particularly in nonruminants, which cannot synthesize their own vitamin B1. Ptaquiloside and aquilide A possess an unusual, planar, illudane norsesquiterpene skeleton. Under alkaline conditions these chemicals yield pterosin B, a proximate carcinogen-mutagen. Pterosin B has been implicated as a cause of the cancers noted after bracken ingestion, and ptaquiloside has been implicated as a contributor to the toxic signs in ruminant animals (Cheeke and Schull 1988, Fenwick 1988). Bracken also contains prunasin, a cyanogenic glycoside, which appears to be a deterrent to herbivory (Tewe and Iyayi 1989).

Toxic plant chemicals:

aquilide A
prunasin

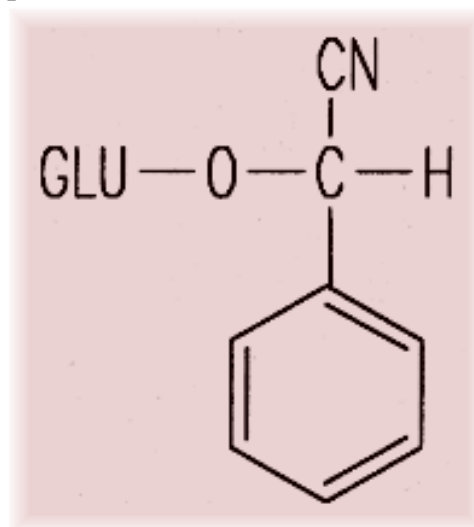

ptaquiloside

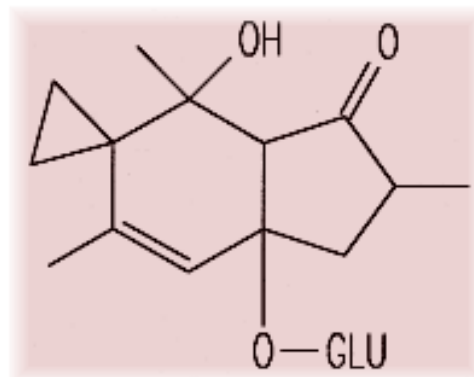

thiaminase

Chemical diagram(s) are courtesy of [Ruth McDiarmid](#),

Biochemistry Technician, Kamloops Range Station, Agriculture and Agri-Food Canada, Kamloops, British Columbia, Canada.

References:

Cheeke, P. R., Shull, L. R. 1985. Natural toxicants in feeds and poisonous plants. AVI Publishing Company, Inc., Westport, Conn., USA. 492 pp.

Fenwick, G. R. 1988. Bracken (*Pteridium aquilinum*) - toxic effects and toxic constituents. J. Sci. Food Agric., 46: 147-173.

Hirono, I. 1989. Carcinogenic bracken glycosides. Pages 239-251 in Cheeke, P. R., ed. Toxicants of plant origin. Vol. II. Glycosides. CRC Press, Inc., Boca Raton, Fla., USA. 277 pp.

Tewe, O. O., Iyayi, E. A. 1989. Cyanogenic glycosides. Pages 43-60 in Cheeke, P. R., ed. Toxicants of plant origin. Vol. II. Glycosides. CRC Press, Inc., Boca Raton, Fla., USA. 277 pp.

Animals/Human Poisoning:

Note: When an animal is listed without additional information, the literature (as of 1993) contained no detailed explanation.

Cattle

General symptoms of poisoning:

[anemia](#)

[bone marrow damage](#)

[cancer and tumors](#)

[death](#)

[hemorrhage](#)

Notes on poisoning:

Consuming significant quantities of bracken fronds can cause bracken poisoning, which results in bone marrow damage. Only small foci of erythropoietic cells and some megakaryocytes remain. Hemorrhaging occurs, with blood in the feces and bleeding from the nose, vagina, and membranes around the mouth and eyes. Postmortem examination shows hemorrhaging in the stomach, intestines, lungs, and heart (Cheeke and Schull 1985, Fenwick 1988, Hirono 1989).

References:

Cheeke, P. R., Shull, L. R. 1985. Natural toxicants in feeds and poisonous plants. AVI Publishing Company, Inc., Westport, Conn., USA. 492 pp.

Fenwick, G. R. 1988. Bracken (*Pteridium aquilinum*) - toxic effects and toxic constituents. J. Sci. Food Agric., 46: 147-173.

Hirono, I. 1989. Carcinogenic bracken glycosides. Pages 239-251 in Cheeke, P. R., ed. Toxicants of plant origin. Vol. II. Glycosides. CRC Press, Inc., Boca Raton, Fla., USA. 277 pp.

Horses

General symptoms of poisoning:

[anemia](#)

[anorexia](#)

[ataxia](#)

[colic](#)

[convulsions](#)

[death](#)

[gait, staggering](#)

[incoordination](#)

[opisthotonos](#)

[recumbency](#)

[weight loss](#)

References:

Cheeke, P. R., Shull, L. R. 1985. Natural toxicants in feeds and poisonous plants. AVI Publishing Company, Inc., Westport, Conn., USA. 492 pp.

Fenwick, G. R. 1988. Bracken (*Pteridium aquilinum*) - toxic effects and toxic constituents. J. Sci. Food Agric., 46: 147-173.

Kelleway, R. A., Geovjian, L. 1978. Acute bracken fern poisoning in a 14-month-old horse. Vet. Med. Small Anim. Clin., 73: 295-296.

Humans

General symptoms of poisoning:

[cancer and tumors](#)

Notes on poisoning:

The young fronds of bracken have been used as a food source, particularly in Japan. Ptaquiloside, a carcinogenic compound, has been found in bracken. The toxin is especially abundant in the young fronds. If the fronds are not processed in any way, tumor incidence in rats is 78%. After the fronds are processed with boiling water or are boiled with wood ash, sodium bicarbonate, or

salt, the incidence of cancer is reduced to 4-25%. Mammary cancer and ileal and urinary bladder tumors were observed. Cattle develop urinary papilloma. The carcinogen can be transferred by milk. The high incidence of stomach cancer in Japan may be partly due to the consumption of bracken (Cheeke and Schull 1985, Hirono 1989).

References:

Cheeke, P. R., Shull, L. R. 1985. Natural toxicants in feeds and poisonous plants. AVI Publishing Company, Inc., Westport, Conn., USA. 492 pp.

Hirono, I. 1989. Carcinogenic bracken glycosides. Pages 239-251 in Cheeke, P. R., ed. Toxicants of plant origin. Vol. II. Glycosides. CRC Press, Inc., Boca Raton, Fla., USA. 277 pp.

Milne, R. 1988. Heathlands of England harbour cancer spores. New Sci., 118: 23.

Sheep

General symptoms of poisoning:

[blindness](#)

Notes on poisoning:

Sheep in the British Isles have developed a condition called bright blindness. The sheep develop degeneration of the neuroepithelium of the retina, with low counts of blood platelets and white blood cells. This problem has been linked to the consumption of bracken. Cattle with similar symptoms have been reported (Fenwick 1989).

References:

Cheeke, P. R., Shull, L. R. 1985. Natural toxicants in feeds and poisonous plants. AVI Publishing Company, Inc., Westport, Conn., USA. 492 pp.

Swine

General symptoms of poisoning:

[appetite, loss of](#)
[death](#)

Notes on poisoning:

Reports of acute bracken poisoning in swine are infrequent, perhaps because of few symptoms. The symptoms are similar to

heart failure. Experimental feeding of dry, powdered rhizomes produced loss of appetite after 8 weeks, followed by rapid deterioration and death 2 weeks later. Postmortem findings revealed damage to the heart. Ingestion by pregnant sows resulted in some death of the piglets after birth (Fenwick 1988).

References:

Fenwick, G. R. 1988. Bracken (*Pteridium aquilinum*) - toxic effects and toxic constituents. J. Sci. Food Agric., 46: 147-173.

[Another search?](#)

[Français](#) | [Contact Us](#) | [Help](#) | [Search](#) | [Canada site](#)

[Coming Events](#) | [About CBIF](#) | [Links](#) | [Reports and Publications](#) |

[Home](#)

Date modified: 2003-02-06

[Important Notices](#)



Français	Contact us	Help	Search	Canada site
Coming events	About CBIF	Links	Reports and publications	Home

Canadian Biodiversity Information Facility



Notes on poisoning: Quercus alba

[Introduction](#)

[Interactive](#)

[All poisonous plants by Botanical name](#)

[All poisonous plants by Common name](#)

[Important WWW Poisonous Plants sites](#)



General poisoning notes:

White oak (*Quercus alba*) is a native tree found in southern Quebec and Ontario. Ingesting the leaves and acorns has caused some toxic problems in cattle. The concentration of toxic phenolics is less than in red or black oak (*Q. rubra* or *Q. velutina*). Symptoms are similar for all three species of oak. In severe cases, renal failure usually results in death (Sandusky et al. 1977, Cockrill and Beasley 1979).

References:

Cockrill, J. M., Beasley, J. N. 1979. Renal damage to cattle during acorn poisoning. *Vet. Med. Small Anim. Clin.*, 74: 82, 84-85.

Sandusky, G. E., Fosnaugh, C. J., Smith, J. B., Mohan, R. 1977. Oak poisoning of cattle in Ohio. *J. Am. Vet. Med. Assoc.*, 171: 627-629.

Nomenclature:

Scientific Name: *Quercus alba* L.

Vernacular name(s): white oak

Scientific family name: *Fagaceae*

Vernacular family name: beech

Go to ITIS*^{ca} for more taxonomic information on: [Quercus alba](#)

References:

Agriculture Quebec. 1975. Noms des maladies des plantes du Canada/ Names of plant diseases in Canada. , Quebec City, Que., Canada. 288 pp.

Alex, J. F., Cayouette, R., Mulligan, G. A. 1980. Common and botanical names of weeds in Canada/Noms populaire et scientifiques des plantes nuisibles du Canada. Revised. Agric. Can. Publ., Ottawa, Ont., Canada. 132 pp.

Bailey, L. H., Bailey, E. Z. 1976. Hortus third. Revised. MacMillan, New York, N.Y., USA. 1290 pp.

Scoggan, H. J. 1978, 1979. The flora of Canada. Nat. Mus. Nat. Sci. (Ottawa) Publ. Bot. 7(1)-7(4). 1711 pp.

Van Wijk, H. L. 1911. A dictionary of plant names. Martinus Nijhoff, The Hague, The Netherlands. 1444 pp.

Victorin, M. 1964. Flore Laurentienne. 2nd ed. Univ. Montreal, Montreal, Que., Canada. 952 pp.

Geographic Information

Ontario

Quebec

References:

Bailey, L. H., Bailey, E. Z. 1976. Hortus third. Revised. MacMillan, New York, N.Y., USA. 1290 pp.

Boivin, B. 1966, 1967. Énumération des plantes du Canada. Provencheria 6. Nat. Can. (Que.) 93: 253-274; 371-437; 583-646; 989-1063. 94: 131-157; 471-528; 625-655.

Image or illustration

Quercus alba:

Images: images.google.com

Toxic parts:

acorns

leaves

References:

Sandusky, G. E., Fosnaugh, C. J., Smith, J. B., Mohan, R. 1977. Oak poisoning of cattle in Ohio. J. Am. Vet. Med. Assoc., 171: 627-629.

Notes on Toxic plant chemicals:

See notes under chemicals in red oak ([Quercus rubra](#)).

Toxic plant chemicals:

gallic acid
pyrogallol
tannic acid

References:

Basden, K. W., Dalvi, R. R. 1987. Determination of total phenolics in acorns from different species of oak trees in conjunction with acorn poisoning in cattle. *Vet. Hum. Toxicol.*, 29: 305-306.

Animals/Human Poisoning:

Note: When an animal is listed without additional information, the literature (as of 1993) contained no detailed explanation.

Cattle

General symptoms of poisoning:

[anorexia](#)
[ascites](#)
[death](#)
[dehydration](#)
[depression](#)
[diarrhea](#)
[kidney failure](#)

Notes on poisoning:

Toxic symptoms include anorexia, rumen atony, hemorrhagic diarrhea, subcutaneous edema, ascites, and dehydration. Renal failure usually results in death. Postmortem examination revealed perirenal edema and hemorrhage. The kidneys had a characteristic nephrosis in a multifocal pattern, of the proximal convoluted tubules (Sandusky et al. 1977, Cockrill and Beasley 1979).

References:

Cockrill, J. M., Beasley, J. N. 1979. Renal damage to cattle during acorn poisoning. *Vet. Med. Small Anim. Clin.*, 74: 82, 84-85.

Sandusky, G. E., Fosnaugh, C. J., Smith, J. B., Mohan, R. 1977.

Oak poisoning of cattle in Ohio. J. Am. Vet. Med. Assoc., 171:
627-629.

[Another search?](#)

[Français](#) | [Contact Us](#) | [Help](#) | [Search](#) | [Canada site](#)

[Coming Events](#) | [About CBIF](#) | [Links](#) | [Reports and Publications](#) |

[Home](#)

Date modified: 2003-02-06

[Important Notices](#)



Français	Contact us	Help	Search	Canada site
Coming events	About CBIF	Links	Reports and publications	Home

Canadian Biodiversity Information Facility



Notes on poisoning: *Quercus rubra*

[Introduction](#)

[Interactive](#)

[All poisonous plants by Botanical name](#)

[All poisonous plants by Common name](#)

[Important WWW Poisonous Plants sites](#)

General poisoning notes:

Red oak (*Quercus rubra*) is a native tree found in eastern Canada. This plant contains toxic tannins that have caused poisoning and death in cattle and horses. Sheep may have also been poisoned by this oak. Poisoning can lead to depression, anorexia, loss of condition, and kidney damage. Kidney failure usually results in death (Duncan 1961, Cockerill and Beasley 1979).



References:

Cockrill, J. M., Beasley, J. N. 1979. Renal damage to cattle during acorn poisoning. *Vet. Med. Small Anim. Clin.*, 74: 82, 84-85.

Duncan, C. S. 1961. Oak leaf poisoning in two horses. *Cornell Vet.*, 51: 159-162.

Nomenclature:

Scientific Name: *Quercus rubra* L.

Vernacular name(s): red oak

Scientific family name: *Fagaceae*

Vernacular family name: beech

Go to ITIS^{*ca} for more taxonomic information on: [Quercus rubra](#)

References:

Agriculture Quebec. 1975. Noms des maladies des plantes du Canada/ Names of plant diseases in Canada. , Quebec City, Que., Canada. 288 pp.

Alex, J. F., Cayouette, R., Mulligan, G. A. 1980. Common and

botanical names of weeds in Canada/Noms populaire et scientifiques des plantes nuisibles du Canada. Revised. Agric. Can. Publ., Ottawa, Ont., Canada. 132 pp.

Bailey, L. H., Bailey, E. Z. 1976. Hortus third. Revised. MacMillan, New York, N.Y., USA. 1290 pp.

Scoggan, H. J. 1978, 1979. The flora of Canada. Nat. Mus. Nat. Sci. (Ottawa) Publ. Bot. 7(1)-7(4). 1711 pp.

Van Wijk, H. L. 1911. A dictionary of plant names. Martinus Nijhoff, The Hague, The Netherlands. 1444 pp.

Victorin, M. 1964. Flore Laurentienne. 2nd ed. Univ. Montreal, Montreal, Que., Canada. 952 pp.

Geographic Information

New Brunswick
Nova Scotia
Ontario
Prince Edward Island
Quebec

References:

Bailey, L. H., Bailey, E. Z. 1976. Hortus third. Revised. MacMillan, New York, N.Y., USA. 1290 pp.

Boivin, B. 1966, 1967. Énumération des plantes du Canada. Provencheria 6. Nat. Can. (Que.) 93: 253-274; 371-437; 583-646; 989-1063. 94: 131-157; 471-528; 625-655.

Image or illustration

Quercus rubra:

Images: images.google.com

Notes on Poisonous plant parts:

The leaves and acorns are toxic. The immature acorns contain more toxin than the mature acorns (Cockrill and Beasley 1979).

Toxic parts:

acorns
immature fruit
leaves

References:

Cockrill, J. M., Beasley, J. N. 1979. Renal damage to cattle during acorn poisoning. *Vet. Med. Small Anim. Clin.*, 74: 82, 84-85.

Notes on Toxic plant chemicals:

The toxic agents are polyhydroxyphenolic compounds (tannins) including gallic acid, pyrogallol, and tannic acid. The concentration of these compounds is higher in immature, green acorns than in mature ones. The following quantities of phenolics were found in acorns (Basden and Dalvi 1987):

Oak species	Total phenolics (% of total weight)
Quercus alba (white oak)	1.09 (0.41-2.54)
Quercus rubra (red oak)	3.72
Quercus velutina (black oak)	4.51 (3.29-6.13)

Black oak and red oak contain a greater total average of phenolics in the acorns does than white oak.

Toxic plant chemicals:

gallic acid
pyrogallol
tannic acid

References:

Basden, K. W., Dalvi, R. R. 1987. Determination of total phenolics in acorns from different species of oak trees in conjunction with acorn poisoning in cattle. *Vet. Hum. Toxicol.*, 29: 305-306.

Animals/Human Poisoning:

Note: When an animal is listed without additional information, the literature (as of 1993) contained no detailed explanation.

Cattle

General symptoms of poisoning:

[anorexia](#)

[constipation](#)

[depression](#)

[kidney failure](#)

[teeth grinding](#)

Notes on poisoning:

Cattle that ingest a small number of acorns may show some loss of condition. However, they often develop a preference for eating the acorns. Toxic amounts cause depression, anorexia, constipation, the passing of small fecal balls covered in mucous and blood, teeth grinding, and submandibular edema. Death is usually caused by kidney failure. Postmortem findings reveal a large number of acorns in the rumen, gastroenteritis in the caudal portion of the digestive tract, and small, shrunken kidneys with diminished reserve capacity. If renal stress occurs, the reserve function of the kidney may be exceeded. Perirenal edema and hemorrhagic enteritis were the prominent lesions. Multifocal necrosis of the proximal convoluted tubules of the kidney is characteristic (Sandusky et al. 1977, Cockrill and Beasley 1979).

References:

Cockrill, J. M., Beasley, J. N. 1979. Renal damage to cattle during acorn poisoning. *Vet. Med. Small Anim. Clin.*, 74: 82, 84-85.

Horses

General symptoms of poisoning:

[abdominal pains](#)

[anorexia](#)

[colic](#)

[constipation](#)

[depression](#)

[diarrhea](#)

[hematuria](#)

[icterus](#)

Notes on poisoning:

Horses that ingested leaves of red oak developed symptoms of depression, anorexia, abdominal pain, constipation, slight icterus, hematuria, edema, and weakness. The symptoms occurred 6-9 days after ingestion. Blood transfusions were thought to speed recovery (Duncan 1961).

References:

Duncan, C. S. 1961. Oak leaf poisoning in two horses. Cornell Vet., 51: 159-162.

Sheep

[Another search?](#)

[Français](#) | [Contact Us](#) | [Help](#) | [Search](#) | [Canada site](#)

[Coming Events](#) | [About CBIF](#) | [Links](#) | [Reports and Publications](#) |

[Home](#)

Date modified: 2003-02-06

[Important Notices](#)



Français	Contact us	Help	Search	Canada site
Coming events	About CBIF	Links	Reports and publications	Home

Canadian Biodiversity Information Facility



Notes on poisoning: *Quercus velutina*

[Introduction](#)

[Interactive](#)

[All poisonous plants by Botanical name](#)

[All poisonous plants by Common name](#)

[Important WWW Poisonous Plants sites](#)



General poisoning notes:

Black oak (*Quercus velutina*) is a native tree found only in southern Ontario. The acorns contain significant quantities of toxic phenolics. This plant caused sickness and death in cattle after they ingested acorns on autumn pastures. The occurrence of poisoning from black oak in southern Ontario is minimal because of its restricted distribution (Sandusky et al. 1977, Basden and Dalvi 1987).

References:

Basden, K. W., Dalvi, R. R. 1987. Determination of total phenolics in acorns from different species of oak trees in conjunction with acorn poisoning in cattle. *Vet. Hum. Toxicol.*, 29: 305-306.

Cockrill, J. M., Beasley, J. N. 1979. Renal damage to cattle during acorn poisoning. *Vet. Med. Small Anim. Clin.*, 74: 82, 84-85.

Sandusky, G. E., Fosnaugh, C. J., Smith, J. B., Mohan, R. 1977. Oak poisoning of cattle in Ohio. *J. Am. Vet. Med. Assoc.*, 171: 627-629.

Nomenclature:

Scientific Name: *Quercus velutina* Lam.

Vernacular name(s): black oak

Scientific family name: *Fagaceae*

Vernacular family name: beech

Go to ITIS*^{ca} for more taxonomic information on: [Quercus velutina](#)

References:

Agriculture Quebec. 1975. Noms des maladies des plantes du Canada/ Names of plant diseases in Canada. , Quebec City, Que., Canada. 288 pp.

Alex, J. F., Cayouette, R., Mulligan, G. A. 1980. Common and botanical names of weeds in Canada/Noms populaire et scientifiques des plantes nuisibles du Canada. Revised. Agric. Can. Publ., Ottawa, Ont., Canada. 132 pp.

Bailey, L. H., Bailey, E. Z. 1976. Hortus third. Revised. MacMillan, New York, N.Y., USA. 1290 pp.

Scoggan, H. J. 1978, 1979. The flora of Canada. Nat. Mus. Nat. Sci. (Ottawa) Publ. Bot. 7(1)-7(4). 1711 pp.

Van Wijk, H. L. 1911. A dictionary of plant names. Martinus Nijhoff, The Hague, The Netherlands. 1444 pp.

Victorin, M. 1964. Flore Laurentienne. 2nd ed. Univ. Montreal, Montreal, Que., Canada. 952 pp.

Geographic Information

Ontario

References:

Bailey, L. H., Bailey, E. Z. 1976. Hortus third. Revised. MacMillan, New York, N.Y., USA. 1290 pp.

Boivin, B. 1966, 1967. Énumération des plantes du Canada. Provencheria 6. Nat. Can. (Que.) 93: 253-274; 371-437; 583-646; 989-1063. 94: 131-157; 471-528; 625-655.

Image or illustration

Quercus velutina:

Images: images.google.com

Notes on Poisonous plant parts:

Ingesting oak leaves and acorns has caused poisoning. Immature acorns contain more toxin than mature acorns (Sandusky et al. 1977).

Toxic parts:

acorns

leaves

References:

Sandusky, G. E., Fosnaugh, C. J., Smith, J. B., Mohan, R. 1977. Oak poisoning of cattle in Ohio. J. Am. Vet. Med. Assoc., 171: 627-629.

Notes on Toxic plant chemicals:

See notes under chemical section of red oak ([Quercus rubra](#)).

Toxic plant chemicals:

gallic acid
pyrogallol
tannic acid

References:

Basden, K. W., Dalvi, R. R. 1987. Determination of total phenolics in acorns from different species of oak trees in conjunction with acorn poisoning in cattle. Vet. Hum. Toxicol., 29: 305-306.

Animals/Human Poisoning:

Note: When an animal is listed without additional information, the literature (as of 1993) contained no detailed explanation.

Cattle

General symptoms of poisoning:

[anorexia](#)

[ascites](#)

[constipation](#)

[diarrhea](#)

[hematuria](#)

[kidney failure](#)

References:

Cockrill, J. M., Beasley, J. N. 1979. Renal damage to cattle during acorn poisoning. Vet. Med. Small Anim. Clin., 74: 82, 84-85.

Sandusky, G. E., Fosnaugh, C. J., Smith, J. B., Mohan, R. 1977.

Oak poisoning of cattle in Ohio. J. Am. Vet. Med. Assoc., 171:
627-629.

Horses

Sheep

[Another search?](#)

[Français](#) | [Contact Us](#) | [Help](#) | [Search](#) | [Canada site](#)

[Coming Events](#) | [About CBIF](#) | [Links](#) | [Reports and Publications](#) |

[Home](#)

Date modified: 2003-02-06

[Important Notices](#)



Français	Contact us	Help	Search	Canada site
Coming events	About CBIF	Links	Reports and publications	Home

Canadian Biodiversity Information Facility



Notes on poisoning: *Ranunculus bulbosus*

[Introduction](#)

[Interactive](#)

[All poisonous plants by Botanical name](#)

[All poisonous plants by Common name](#)

[Important WWW Poisonous Plants sites](#)



General poisoning notes:

Bulbous buttercup (*Ranunculus bulbosus*) is a naturalized herb found in a few Canadian provinces. In the past, the juice of this plant was used by beggars in Europe to cause skin lesions, thus eliciting compassion. The volatile chemical protoanemonin is an irritant. Ingesting this plant has poisoned cattle, swine, and humans. The recent literature includes few cases of poisoning (Kingsbury 1964, Cooper and Johnson 1984).

References:

Cooper, M. R., Johnson, A. W. 1984. Poisonous plants in Britain and their effects on animals and man. Her Majesty's Stationery Office, London, England. 305 pp.

Kingsbury, J. M. 1964. Poisonous plants of the United States and Canada. Prentice-Hall Inc., Englewood Cliffs, N.J., USA. 626 pp.

Nomenclature:

Scientific Name: *Ranunculus bulbosus* L.

Vernacular name(s): bulbous buttercup

Scientific family name: *Ranunculaceae*

Vernacular family name: crowfoot

Go to ITIS*^{ca} for more taxonomic information on: [Ranunculus bulbosus](#)

References:

Agriculture Quebec. 1975. Noms des maladies des plantes du Canada/ Names of plant diseases in Canada. , Quebec City, Que., Canada. 288 pp.

Alex, J. F., Cayouette, R., Mulligan, G. A. 1980. Common and botanical names of weeds in Canada/Noms populaire et scientifiques des plantes nuisibles du Canada. Revised. Agric. Can. Publ., Ottawa, Ont., Canada. 132 pp.

Bailey, L. H., Bailey, E. Z. 1976. Hortus third. Revised. MacMillan, New York, N.Y., USA. 1290 pp.

Scoggan, H. J. 1978, 1979. The flora of Canada. Nat. Mus. Nat. Sci. (Ottawa) Publ. Bot. 7(1)-7(4). 1711 pp.

Van Wijk, H. L. 1911. A dictionary of plant names. Martinus Nijhoff, The Hague, The Netherlands. 1444 pp.

Victorin, M. 1964. Flore Laurentienne. 2nd ed. Univ. Montreal, Montreal, Que., Canada. 952 pp.

Geographic Information

Newfoundland

Nova Scotia

Ontario

References:

Bailey, L. H., Bailey, E. Z. 1976. Hortus third. Revised. MacMillan, New York, N.Y., USA. 1290 pp.

Boivin, B. 1966, 1967. Énumération des plantes du Canada. Provencheria 6. Nat. Can. (Que.) 93: 253-274; 371-437; 583-646; 989-1063. 94: 131-157; 471-528; 625-655.

Image or illustration

Ranunculus bulbosus:

Images: images.google.com

Toxic parts:

plant juices

References:

Cooper, M. R., Johnson, A. W. 1984. Poisonous plants in Britain and their effects on animals and man. Her Majesty's Stationery Office, London, England. 305 pp.

Notes on Toxic plant chemicals:

Ranunculin, a glycoside, occurs in the juice of the buttercups. Upon maceration, a plant enzyme is released that converts ranunculin to protoanemonin. This chemical, a yellow volatile oil, is unstable and either polymerizes to nontoxic anemonin or is volatilized. Air-dried plants, as those found in hay, are nontoxic. Protoanemonin is an irritant that can cause blisters and other problems when ingested (Cooper and Johnson 1984).

Toxic plant chemicals:

ranunculin

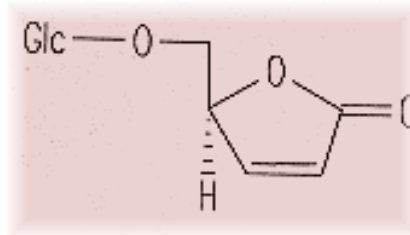

Chemical diagram(s) are courtesy of [Ruth McDiarmid](#), Biochemistry Technician, Kamloops Range Station, Agriculture and Agri-Food Canada, Kamloops, British Columbia, Canada.

References:

Cooper, M. R., Johnson, A. W. 1984. Poisonous plants in Britain and their effects on animals and man. Her Majesty's Stationery Office, London, England. 305 pp.

Animals/Human Poisoning:

Note: When an animal is listed without additional information, the literature (as of 1993) contained no detailed explanation.

Cattle

General symptoms of poisoning:

[breathing, labored](#)

[gait, unsteady](#)

[nasal discharge](#)

[salivation](#)

Notes on poisoning:

In one case in Britain, a cow salivated, coughed, and discharged mucous from the nostrils after ingesting buttercup plants. The animal swayed in the hindquarters with an uneasy movement of

the legs. A period of noisy breathing preceded recovery (Cooper and Johnson 1984).

References:

Cooper, M. R., Johnson, A. W. 1984. Poisonous plants in Britain and their effects on animals and man. Her Majesty's Stationery Office, London, England. 305 pp.

Humans

General symptoms of poisoning:

[abdominal pains](#)

[diarrhea](#)

[mouth, irritation of](#)

Notes on poisoning:

Ingesting the bulbous bases of this buttercup has caused a few cases of illness. An acrid taste and burning of the mouth and throat precludes ingesting large quantities. Other symptoms may include diarrhea and abdominal pain (Cooper and Johnson 1984).

References:

Cooper, M. R., Johnson, A. W. 1984. Poisonous plants in Britain and their effects on animals and man. Her Majesty's Stationery Office, London, England. 305 pp.

Swine

General symptoms of poisoning:

[blindness](#)

References:

Kingsbury, J. M. 1964. Poisonous plants of the United States and Canada. Prentice-Hall Inc., Englewood Cliffs, N.J., USA. 626 pp.

[Another search?](#)

[Français](#) | [Contact Us](#) | [Help](#) | [Search](#) | [Canada site](#)

[Coming Events](#) | [About CBIF](#) | [Links](#) | [Reports and Publications](#) | [Home](#)

Date modified: 2003-02-06

[Important Notices](#)



Français	Contact us	Help	Search	Canada site
Coming events	About CBIF	Links	Reports and publications	Home

Canadian Biodiversity Information Facility



Notes on poisoning: *Ranunculus sceleratus*

[Introduction](#)[Interactive](#)[All poisonous plants by Botanical name](#)[All poisonous plants by Common name](#)[Important WWW Poisonous Plants sites](#)

General poisoning notes:

Celery-leaved buttercup (*Ranunculus sceleratus*) is a native herb found across most of Canada. This plant contains a toxic irritant that produces protoanemonin upon mastication. All types of livestock can become ill upon ingestion, but cattle are most commonly affected. Horses and goats have also been poisoned (Cooper and Johnson 1984, Fuller and McClintock 1986).

References:

Cooper, M. R., Johnson, A. W. 1984. Poisonous plants in Britain and their effects on animals and man. Her Majesty's Stationery Office, London, England. 305 pp.

Fuller, T. C., McClintock, E. 1986. Poisonous plants of California. Univ. California Press, Berkeley, Calif., USA. 432 pp.

Nomenclature:

Scientific Name: *Ranunculus sceleratus* L.

Vernacular name(s): celery-leaved buttercup

Scientific family name: *Ranunculaceae*

Vernacular family name: crowfoot

Go to ITIS^{*ca} for more taxonomic information on: [Ranunculus sceleratus](#)

References:

Agriculture Quebec. 1975. Noms des maladies des plantes du Canada/ Names of plant diseases in Canada. , Quebec City, Que., Canada. 288 pp.

Alex, J. F., Cayouette, R., Mulligan, G. A. 1980. Common and botanical names of weeds in Canada/Noms populaire et scientifiques des plantes nuisibles du Canada. Revised. Agric. Can. Publ., Ottawa, Ont., Canada. 132 pp.

Bailey, L. H., Bailey, E. Z. 1976. Hortus third. Revised. MacMillan, New York, N.Y., USA. 1290 pp.

Scoggan, H. J. 1978, 1979. The flora of Canada. Nat. Mus. Nat. Sci. (Ottawa) Publ. Bot. 7(1)-7(4). 1711 pp.

Van Wijk, H. L. 1911. A dictionary of plant names. Martinus Nijhoff, The Hague, The Netherlands. 1444 pp.

Victorin, M. 1964. Flore Laurentienne. 2nd ed. Univ. Montreal, Montreal, Que., Canada. 952 pp.

Geographic Information

Alberta
British Columbia
Labrador
Manitoba
Newfoundland
Northwest Territories
Ontario
Quebec
Saskatchewan
Yukon Territory

References:

Bailey, L. H., Bailey, E. Z. 1976. Hortus third. Revised. MacMillan, New York, N.Y., USA. 1290 pp.

Boivin, B. 1966, 1967. Énumération des plantes du Canada. Provencheria 6. Nat. Can. (Que.) 93: 253-274; 371-437; 583-646; 989-1063. 94: 131-157; 471-528; 625-655.

Image or illustration

Ranunculus sceleratus:

Images: images.google.com

Notes on Poisonous plant parts:

The plant juices contain the glycoside, which is converted to the irritant protoanemonin. The concentration is highest during flowering (Cooper and Johnson 1984).

Toxic parts:

plant juices

References:

Cooper, M. R., Johnson, A. W. 1984. Poisonous plants in Britain and their effects on animals and man. Her Majesty's Stationery Office, London, England. 305 pp.

Notes on Toxic plant chemicals:

Ranunculin, a glycoside, becomes a volatile irritant, protoanemonin, after enzyme-mediated conversion through mastication (Cooper and Johnson 1984).

Toxic plant chemicals:

ranunculin

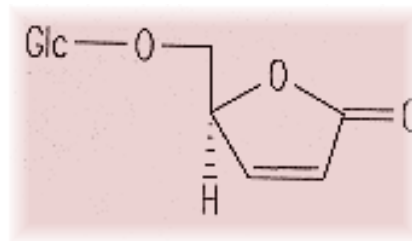

Chemical diagram(s) are courtesy of [Ruth McDiarmid](#), Biochemistry Technician, Kamloops Range Station, Agriculture and Agri-Food Canada, Kamloops, British Columbia, Canada.

References:

Cooper, M. R., Johnson, A. W. 1984. Poisonous plants in Britain and their effects on animals and man. Her Majesty's Stationery Office, London, England. 305 pp.

Animals/Human Poisoning:

Note: When an animal is listed without additional information, the literature (as of 1993) contained no detailed explanation.

Cattle

General symptoms of poisoning:

[abdominal pains](#)

[blindness](#)

[constipation](#)

[diarrhea](#)
[gait, unsteady](#)
[mouth, irritation of](#)
[salivation](#)

Notes on poisoning:

Ingesting the celery-leaved buttercup causes salivation, abdominal pain, and inflammation of the mouth. In more serious cases, severe ulceration of the mouth and of the digestive and urinary systems occurs. The animal excretes dark-colored diarrhea and urine. Unsteady gait occurs in the hind legs, and vision can be impaired or lost. Convulsion precedes death, although fatalities are rare. Animals should not be allowed to graze pastures for at least 2 weeks after spraying with 2,4-D because the plants may be grazed selectively by animals (Cooper and Johnson 1984).

References:

Cooper, M. R., Johnson, A. W. 1984. Poisonous plants in Britain and their effects on animals and man. Her Majesty's Stationery Office, London, England. 305 pp.

Fuller, T. C., McClintock, E. 1986. Poisonous plants of California. Univ. California Press, Berkeley, Calif., USA. 432 pp.

Goats

General symptoms of poisoning:

[abdominal pains](#)
[death](#)
[mouth, irritation of](#)

References:

Cooper, M. R., Johnson, A. W. 1984. Poisonous plants in Britain and their effects on animals and man. Her Majesty's Stationery Office, London, England. 305 pp.

Horses

General symptoms of poisoning:

[blindness, temporary](#)
[colic](#)
[convulsions](#)
[muscle spasms](#)
[paralysis](#)

Notes on poisoning:

A horse was poisoned after ingesting celery-leaved buttercup. Symptoms included paralysis, muscle tremors, colic, convulsions, and loss of hearing and sight. Recovery occurred over a few days but weakness persisted (Cooper and Johnson 1984).

References:

Cooper, M. R., Johnson, A. W. 1984. Poisonous plants in Britain and their effects on animals and man. Her Majesty's Stationery Office, London, England. 305 pp.

[Another search?](#)

[Français](#) | [Contact Us](#) | [Help](#) | [Search](#) | [Canada site](#)

[Coming Events](#) | [About CBIF](#) | [Links](#) | [Reports and Publications](#) | [Home](#)

Date modified: 2003-02-06

[Important Notices](#)



Français	Contact us	Help	Search	Canada site
Coming events	About CBIF	Links	Reports and publications	Home

Canadian Biodiversity Information Facility



Notes on poisoning: *Raphanus raphanistrum*

[Introduction](#)[Interactive](#)[All poisonous plants by Botanical name](#)[All poisonous plants by Common name](#)[Important WWW Poisonous Plants sites](#)

General poisoning notes:

Wild radish (*Raphanus raphanistrum*) is a naturalized herb found across most of Canada. This plant, like the cultivated radish (*Raphanus sativus*) contains glucosinolates in the seeds, which can cause poisoning if eaten in sufficient quantities by livestock. Symptoms are similar to those discussed in the general notes under [Brassica oleracea](#).

References:



Kingsbury, J. M. 1964. Poisonous plants of the United States and Canada. Prentice-Hall Inc., Englewood Cliffs, N.J., USA. 626 pp.

Nomenclature:

Scientific Name: *Raphanus raphanistrum* L.

Vernacular name(s): wild radish

Scientific family name: *Cruciferae*

Vernacular family name: mustard

Go to ITIS*^{ca} for more taxonomic information on: [Raphanus raphanistrum](#)

References:

Agriculture Quebec. 1975. Noms des maladies des plantes du Canada/ Names of plant diseases in Canada. , Quebec City, Que., Canada. 288 pp.

Alex, J. F., Cayouette, R., Mulligan, G. A. 1980. Common and botanical names of weeds in Canada/Noms populaire et scientifiques des plantes nuisibles du Canada. Revised. Agric. Can. Publ., Ottawa, Ont., Canada. 132 pp.

Bailey, L. H., Bailey, E. Z. 1976. Hortus third. Revised. MacMillan, New York, N.Y., USA. 1290 pp.

Scoggan, H. J. 1978, 1979. The flora of Canada. Nat. Mus. Nat. Sci. (Ottawa) Publ. Bot. 7(1)-7(4). 1711 pp.

Van Wijk, H. L. 1911. A dictionary of plant names. Martinus Nijhoff, The Hague, The Netherlands. 1444 pp.

Victorin, M. 1964. Flore Laurentienne. 2nd ed. Univ. Montreal, Montreal, Que., Canada. 952 pp.

Geographic Information

British Columbia
Labrador
New Brunswick
Nova Scotia
Ontario
Prince Edward Island
Quebec
Saskatchewan

References:

Bailey, L. H., Bailey, E. Z. 1976. Hortus third. Revised. MacMillan, New York, N.Y., USA. 1290 pp.

Boivin, B. 1966, 1967. Énumération des plantes du Canada. Provencheria 6. Nat. Can. (Que.) 93: 253-274; 371-437; 583-646; 989-1063. 94: 131-157; 471-528; 625-655.

Image or illustration

Raphanus raphanistrum:

Images: images.google.com

Toxic parts:

seeds

References:

Kingsbury, J. M. 1964. Poisonous plants of the United States and Canada. Prentice-Hall Inc., Englewood Cliffs, N.J., USA. 626 pp.

Palechek, N. 1986. Toxic weed seeds in cattle feed. Can. Vet. J., 26: A10.

Notes on Toxic plant chemicals:

Glucosinolates are contained in the seeds of this plant. See the discussions on these toxins in general notes under [Brassica oleracea](#).

Toxic plant chemicals:

glucosinolates

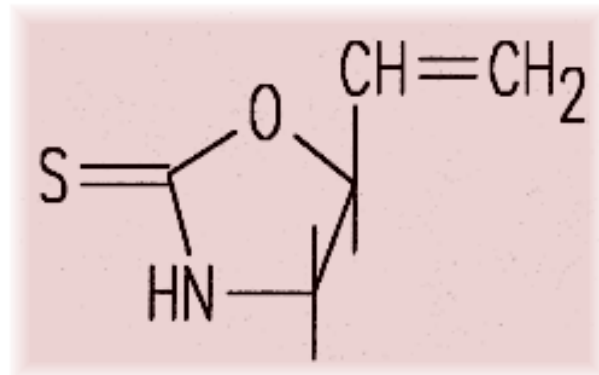

glucosinolates

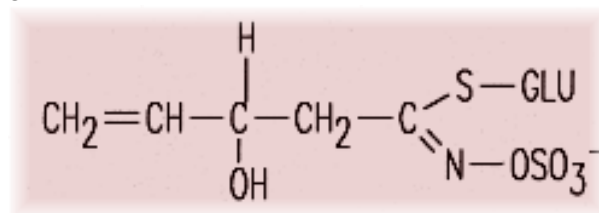

glucosinolates

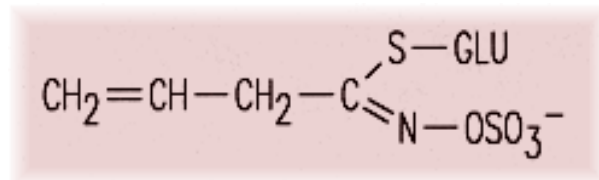

Chemical diagram(s) are courtesy of [Ruth McDiarmid](#), Biochemistry Technician, Kamloops Range Station, Agriculture and Agri-Food Canada, Kamloops, British Columbia, Canada.

References:

Kingsbury, J. M. 1964. Poisonous plants of the United States and Canada. Prentice-Hall Inc., Englewood Cliffs, N.J., USA. 626 pp.

Animals/Human Poisoning:

Note: When an animal is listed without additional information, the literature (as of 1993) contained no detailed explanation.

Cattle

General symptoms of poisoning:

[hemoglobinuria](#)

References:

Kingsbury, J. M. 1964. Poisonous plants of the United States and Canada. Prentice-Hall Inc., Englewood Cliffs, N.J., USA. 626 pp.

Sheep

[Another search?](#)

[Français](#) | [Contact Us](#) | [Help](#) | [Search](#) | [Canada site](#)

[Coming Events](#) | [About CBIF](#) | [Links](#) | [Reports and Publications](#) |

[Home](#)

Date modified: 2003-02-06

[Important Notices](#)



Français	Contact us	Help	Search	Canada site
Coming events	About CBIF	Links	Reports and publications	Home

Canadian Biodiversity Information Facility



Notes on poisoning: *Raphanus sativus*

[Introduction](#)[Interactive](#)[All poisonous plants by Botanical name](#)[All poisonous plants by Common name](#)[Important WWW Poisonous Plants sites](#)

General poisoning notes:

Radish (*Raphanus sativus*) is a cultivated plant with the potential for livestock poisoning from SMCO or glucosinolate toxins contained in the leaves and seeds. However, no occurrence was reported in the literature. See general notes under [Brassica oleracea](#) on the effects of these chemicals.

References:

Cheeke, P. R., Shull, L. R. 1985. Natural toxicants in feeds and poisonous plants. AVI Publishing Company, Inc., Westport, Conn., USA. 492 pp.



Nomenclature:

Scientific Name: *Raphanus sativus* L.

Vernacular name(s): radish

Scientific family name: *Cruciferae*

Vernacular family name: mustard

Go to ITIS*^{ca} for more taxonomic information on: [Raphanus sativus](#)

References:

Agriculture Quebec. 1975. Noms des maladies des plantes du Canada/ Names of plant diseases in Canada. , Quebec City, Que., Canada. 288 pp.

Alex, J. F., Cayouette, R., Mulligan, G. A. 1980. Common and botanical names of weeds in Canada/Noms populaire et scientifiques des plantes nuisibles du Canada. Revised. Agric. Can. Publ., Ottawa, Ont., Canada. 132 pp.

Bailey, L. H., Bailey, E. Z. 1976. Hortus third. Revised. MacMillan, New York, N.Y., USA. 1290 pp.

Scoggan, H. J. 1978, 1979. The flora of Canada. Nat. Mus. Nat. Sci. (Ottawa) Publ. Bot. 7(1)-7(4). 1711 pp.

Van Wijk, H. L. 1911. A dictionary of plant names. Martinus Nijhoff, The Hague, The Netherlands. 1444 pp.

Victorin, M. 1964. Flore Laurentienne. 2nd ed. Univ. Montreal, Montreal, Que., Canada. 952 pp.

Geographic Information

References:

Bailey, L. H., Bailey, E. Z. 1976. Hortus third. Revised. MacMillan, New York, N.Y., USA. 1290 pp.

Boivin, B. 1966, 1967. Énumération des plantes du Canada. Provencheria 6. Nat. Can. (Que.) 93: 253-274; 371-437; 583-646; 989-1063. 94: 131-157; 471-528; 625-655.

Image or illustration

Raphanus sativus:

Images: images.google.com

Toxic parts:

leaves
seeds

References:

Cheeke, P. R., Shull, L. R. 1985. Natural toxicants in feeds and poisonous plants. AVI Publishing Company, Inc., Westport, Conn., USA. 492 pp.

Notes on Toxic plant chemicals:

See the general notes under [Brassica oleracea](#) for further discussion of these chemicals.

Toxic plant chemicals:

glucosinolates

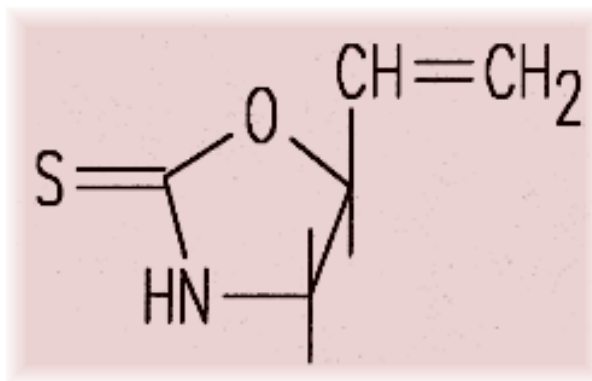

glucosinolates

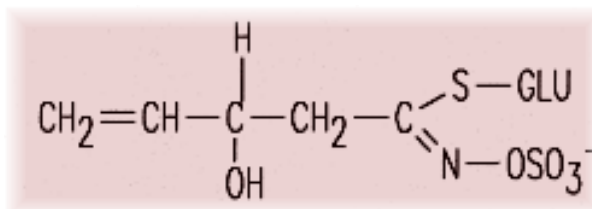

glucosinolates

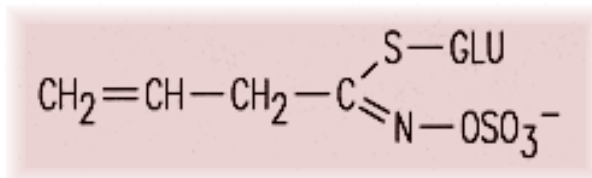

S-methyl-L-cysteine sulfoxide (SMCO)

Chemical diagram(s) are courtesy of [Ruth McDiarmid](#), Biochemistry Technician, Kamloops Range Station, Agriculture and Agri-Food Canada, Kamloops, British Columbia, Canada.

References:

Benevenga, N. J., Case, G. L., Steele, R. D. 1989. Occurrence and metabolism of s-methyl-l-cysteine and s-methyl-l-cysteine sulfoxide in plants and their toxicity and metabolism in animals. Pages 203-228 in Cheeke, P. R., ed. Toxicants of plant origin. Vol. III. Proteins and amino acids. CRC Press, Inc., Boca Raton, Fla., USA. 271 pp.

Cheeke, P. R., Shull, L. R. 1985. Natural toxicants in feeds and poisonous plants. AVI Publishing Company, Inc., Westport, Conn., USA. 492 pp.

Fenwick, G. R., Heaney, R. K., Mawson, R. 1989. Glucosinolates. Pages 1-41 in Cheeke, P. R., ed. Toxicants of plant origin. Vol. II. Glycosides. CRC Press, Inc., Boca Raton, Fla., USA. 277 pp.

Animals/Human Poisoning:

Note: When an animal is listed without additional information, the

literature (as of 1993) contained no detailed explanation.

Cattle

[Another search?](#)

[Français](#) | [Contact Us](#) | [Help](#) | [Search](#) | [Canada site](#)

[Coming Events](#) | [About CBIF](#) | [Links](#) | [Reports and Publications](#) |

[Home](#)

Date modified: 2003-02-06

[Important Notices](#)



Français	Contact us	Help	Search	Canada site
Coming events	About CBIF	Links	Reports and publications	Home

Canadian Biodiversity Information Facility



Notes on poisoning: *Rhamnus cathartica*

[Introduction](#)[Interactive](#)[All poisonous plants by Botanical name](#)[All poisonous plants by Common name](#)[Important WWW Poisonous Plants sites](#)

General poisoning notes:

European buckthorn (*Rhamnus cathartica*) is a small naturalized shrub that is found throughout much of eastern Canada and in the Prairie Provinces. The shrub has spines on the branches and trunks. These shrubs commonly grow along fence rows and roadsides and in old fields. In some areas, they are a common undergrowth shrub in woodlands. The bark and fruits contain chemicals that have a strong purgative action that can affect humans. Severe poisoning is rare (Cooper and Johnson 1984, Lampe and McCann 1986).



References:

Cooper, M. R., Johnson, A. W. 1984. Poisonous plants in Britain and their effects on animals and man. Her Majesty's Stationery Office, London, England. 305 pp.

Fuller, T. C., McClintock, E. 1986. Poisonous plants of California. Univ. California Press, Berkeley, Calif., USA. 432 pp.

Lampe, K. F., McCann, M. A. 1985. AMA Handbook of poisonous and injurious plants. American Medical Assoc. Chicago, Ill., USA. 432 pp.

Nomenclature:

Scientific Name: *Rhamnus cathartica* L.

Vernacular name(s): European buckthorn

Scientific family name: *Rhamnaceae*

Vernacular family name: buckthorn

Go to ITIS*^{ca} for more taxonomic information on: [Rhamnus cathartica](#)

References:

Agriculture Quebec. 1975. Noms des maladies des plantes du Canada/ Names of plant diseases in Canada. , Quebec City, Que., Canada. 288 pp.

Alex, J. F., Cayouette, R., Mulligan, G. A. 1980. Common and botanical names of weeds in Canada/Noms populaire et scientifiques des plantes nuisibles du Canada. Revised. Agric. Can. Publ., Ottawa, Ont., Canada. 132 pp.

Bailey, L. H., Bailey, E. Z. 1976. Hortus third. Revised. MacMillan, New York, N.Y., USA. 1290 pp.

Scoggan, H. J. 1978, 1979. The flora of Canada. Nat. Mus. Nat. Sci. (Ottawa) Publ. Bot. 7(1)-7(4). 1711 pp.

Van Wijk, H. L. 1911. A dictionary of plant names. Martinus Nijhoff, The Hague, The Netherlands. 1444 pp.

Victorin, M. 1964. Flore Laurentienne. 2nd ed. Univ. Montreal, Montreal, Que., Canada. 952 pp.

Geographic Information

Manitoba
Nova Scotia
Ontario
Prince Edward Island
Quebec
Saskatchewan

References:

Bailey, L. H., Bailey, E. Z. 1976. Hortus third. Revised. MacMillan, New York, N.Y., USA. 1290 pp.

Boivin, B. 1966, 1967. Énumération des plantes du Canada. Provencheria 6. Nat. Can. (Que.) 93: 253-274; 371-437; 583-646; 989-1063. 94: 131-157; 471-528; 625-655.

Image or illustration

Rhamnus cathartica:

Images: images.google.com

Toxic parts:

bark
mature fruit

References:

Cooper, M. R., Johnson, A. W. 1984. Poisonous plants in Britain and their effects on animals and man. Her Majesty's Stationery Office, London, England. 305 pp.

Notes on Toxic plant chemicals:

This plant contains glycosides, which upon hydrolysis yield anthraquinones such as emodin (a trihydroxymethylanthraquinone). These chemicals have a purgative action; emodin has been used in laxative preparations (Cooper and Johnson 1984).

Toxic plant chemicals:

anthraquinones

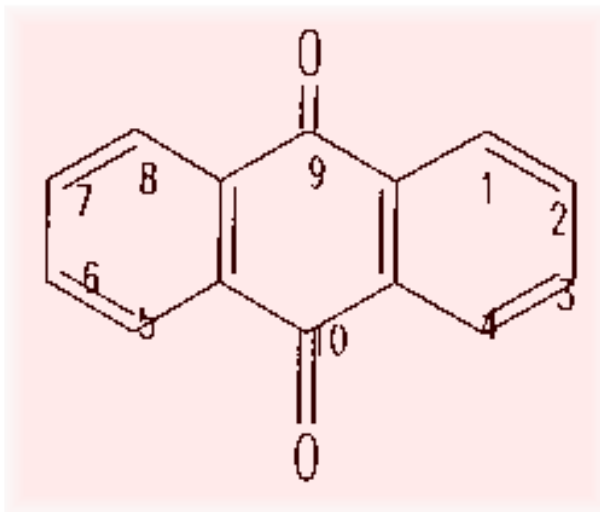

emodine

Chemical diagram(s) are courtesy of [Ruth McDiarmid](#), Biochemistry Technician, Kamloops Range Station, Agriculture and Agri-Food Canada, Kamloops, British Columbia, Canada.

References:

Cooper, M. R., Johnson, A. W. 1984. Poisonous plants in Britain and their effects on animals and man. Her Majesty's Stationery Office, London, England. 305 pp.

Animals/Human Poisoning:

Note: When an animal is listed without additional information, the literature (as of 1993) contained no detailed explanation.

Humans

General symptoms of poisoning:

[abdominal pains](#)

[diarrhea](#)

[gastroenteritis](#)

[hemorrhage](#)

[muscle spasms](#)

[vomiting](#)

Notes on poisoning:

European buckthorn is usually ingested by children, who eat the black berries or chew the twigs. Under normal circumstances, the symptoms are usually mild and are limited to transient abdominal pain, vomiting, and diarrhea. Ingesting 20 berries or more can have more serious consequences such as gastrointestinal symptoms, fluid depletion, kidney damage, muscular convulsions, and hemorrhage. Serious cases may result in difficult breathing and collapse. Treatment includes inducing vomiting, if it has not already occurred, and fluid replacement (Cooper and Johnson 1984, Fuller and McClintock 1985).

References:

Cooper, M. R., Johnson, A. W. 1984. Poisonous plants in Britain and their effects on animals and man. Her Majesty's Stationery Office, London, England. 305 pp.

Fuller, T. C., McClintock, E. 1986. Poisonous plants of California. Univ. California Press, Berkeley, Calif., USA. 432 pp.

Lampe, K. F., McCann, M. A. 1985. AMA Handbook of poisonous and injurious plants. American Medical Assoc. Chicago, Ill., USA. 432 pp.

[Another search?](#)

[Français](#) | [Contact Us](#) | [Help](#) | [Search](#) | [Canada site](#)

[Coming Events](#) | [About CBIF](#) | [Links](#) | [Reports and Publications](#) |

[Home](#)

Date modified: 2003-02-06

[Important Notices](#)



Français	Contact us	Help	Search	Canada site
Coming events	About CBIF	Links	Reports and publications	Home

Canadian Biodiversity Information Facility



Notes on poisoning: *Rhamnus frangula*

[Introduction](#)[Interactive](#)[All poisonous plants by Botanical name](#)[All poisonous plants by Common name](#)[Important WWW Poisonous Plants sites](#)

General poisoning notes:

Alder buckthorn (*Rhamnus frangula*) is a naturalized shrub or small tree that is found in parts of eastern Canada and the Prairie Provinces. This plant is found along fencerows and roadsides and in lightly shaded woodlands. Several purgative chemicals, including emodin, occur in the bark and in the purple-black fruits. This plant causes usually mild symptoms if ingested by children. There is one record of fatal poisoning of a cow (Cooper and Johnson 1984, Fuller and McClintock 1985).



References:

Cooper, M. R., Johnson, A. W. 1984. Poisonous plants in Britain and their effects on animals and man. Her Majesty's Stationery Office, London, England. 305 pp.

Nomenclature:

Scientific Name: *Rhamnus frangula* L.

Vernacular name(s): alder buckthorn

Scientific family name: *Rhamnaceae*

Vernacular family name: buckthorn

Go to ITIS*^{ca} for more taxonomic information on: [Rhamnus frangula](#)

References:

Agriculture Quebec. 1975. Noms des maladies des plantes du Canada/ Names of plant diseases in Canada. , Quebec City, Que., Canada. 288 pp.

Alex, J. F., Cayouette, R., Mulligan, G. A. 1980. Common and botanical names of weeds in Canada/Noms populaire et scientifiques

des plantes nuisibles du Canada. Revised. Agric. Can. Publ., Ottawa, Ont., Canada. 132 pp.

Bailey, L. H., Bailey, E. Z. 1976. Hortus third. Revised. MacMillan, New York, N.Y., USA. 1290 pp.

Scoggan, H. J. 1978, 1979. The flora of Canada. Nat. Mus. Nat. Sci. (Ottawa) Publ. Bot. 7(1)-7(4). 1711 pp.

Van Wijk, H. L. 1911. A dictionary of plant names. Martinus Nijhoff, The Hague, The Netherlands. 1444 pp.

Victorin, M. 1964. Flore Laurentienne. 2nd ed. Univ. Montreal, Montreal, Que., Canada. 952 pp.

Geographic Information

Manitoba
New Brunswick
Nova Scotia
Ontario
Prince Edward Island
Quebec

References:

Bailey, L. H., Bailey, E. Z. 1976. Hortus third. Revised. MacMillan, New York, N.Y., USA. 1290 pp.

Boivin, B. 1966, 1967. Énumération des plantes du Canada. Provencheria 6. Nat. Can. (Que.) 93: 253-274; 371-437; 583-646; 989-1063. 94: 131-157; 471-528; 625-655.

Image or illustration

Rhamnus frangula:

Images: images.google.com

Toxic parts:

bark
mature fruit

References:

Cooper, M. R., Johnson, A. W. 1984. Poisonous plants in Britain and their effects on animals and man. Her Majesty's Stationery Office, London, England. 305 pp.

Notes on Toxic plant chemicals:

Alder buckthorn contains glycosides, which upon hydrolysis yield anthraquinones such as emodin (a trihydroxymethylanthraquinone). These chemicals are purgative; emodin has been used in laxatives (Cooper and Johnson 1984).

Toxic plant chemicals:

anthraquinones

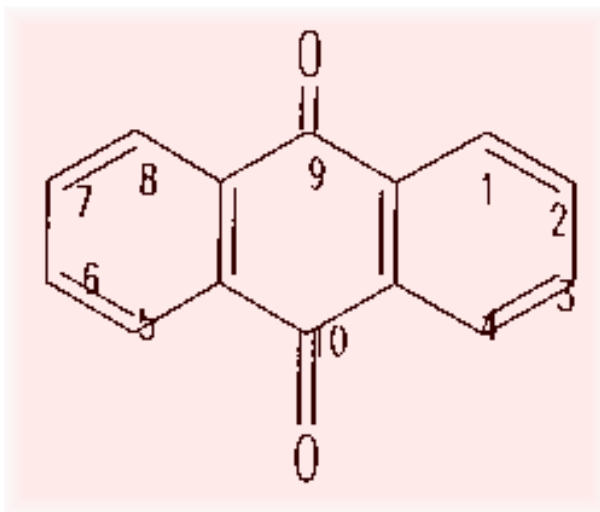

emodine

Chemical diagram(s) are courtesy of [Ruth McDiarmid](#), Biochemistry Technician, Kamloops Range Station, Agriculture and Agri-Food Canada, Kamloops, British Columbia, Canada.

References:

Cooper, M. R., Johnson, A. W. 1984. Poisonous plants in Britain and their effects on animals and man. Her Majesty's Stationery Office, London, England. 305 pp.

Animals/Human Poisoning:

Note: When an animal is listed without additional information, the literature (as of 1993) contained no detailed explanation.

Cattle

General symptoms of poisoning:

[death](#)

[diarrhea](#)

[fever](#)

[vomiting](#)

Notes on poisoning:

In one case of fatal poisoning, a cow ate large quantities of leaves, twigs, and berries of alder buckthorn. The animal quickly became ill and developed symptoms of diarrhea, vomiting, slow pulse, cramps, and slight fever before death. Postmortem examination showed leaves of the plant in the stomach, with gastrointestinal inflammation (Cooper and Johnson 1984).

References:

Cooper, M. R., Johnson, A. W. 1984. Poisonous plants in Britain and their effects on animals and man. Her Majesty's Stationery Office, London, England. 305 pp.

Humans

General symptoms of poisoning:

[abdominal pains](#)

[collapse](#)

[convulsions](#)

[diarrhea](#)

[gastroenteritis](#)

[hemorrhage](#)

[vomiting](#)

Notes on poisoning:

Children who ingest the plant material usually experience mild symptoms of poisoning such as transient abdominal pains, vomiting, and diarrhea. If 20 or more berries are ingested, symptoms may include gastrointestinal symptoms, fluid depletion, kidney damage, muscular convulsions, and hemorrhage. In severe cases, difficult breathing and collapse may occur. Severe poisoning is rare because of induced vomiting. Treatment should replace lost fluids and induce vomiting if it has not occurred (Cooper and Johnson 1984, Fuller and McClintock 1985).

References:

Cooper, M. R., Johnson, A. W. 1984. Poisonous plants in Britain and their effects on animals and man. Her Majesty's Stationery Office, London, England. 305 pp.

[Another search?](#)

[Français](#) | [Contact Us](#) | [Help](#) | [Search](#) | [Canada site](#)

[Coming Events](#) | [About CBIF](#) | [Links](#) | [Reports and Publications](#) |

[Home](#)

Date modified: 2003-02-06

[Important Notices](#)



Français	Contact us	Help	Search	Canada site
Coming events	About CBIF	Links	Reports and publications	Home

Canadian Biodiversity Information Facility



Notes on poisoning: *Rheum rhaponticum*

[Introduction](#)[Interactive](#)[All poisonous plants by Botanical name](#)[All poisonous plants by Common name](#)[Important WWW Poisonous Plants sites](#)

General poisoning notes:

Rhubarb (*Rheum rhaponticum*) is a perennial cultivated plant that persists around old farm sites. The plant contains oxalate crystals, which have been reported to cause poisoning when large quantities of raw or cooked leaves are ingested. Anthraquinones (glycosides) have been implicated more recently in the poisoning. The stalks are widely used as preserves and are also eaten raw, without problems. The toxic content is much lower in the stalks. Humans have been poisoned after ingesting the leaves. Human poisoning was a particular problem in World War I, when the leaves were recommended as a food source in Britain. Some animals, including goats and swine, have also been poisoned by ingesting the leaves. Children should be taught to eat only the rhubarb stalks, preferably under supervision (Robb 1919; Cooper and Johnson 1984).

References:

Cooper, M. R., Johnson, A. W. 1984. Poisonous plants in Britain and their effects on animals and man. Her Majesty's Stationery Office, London, England. 305 pp.

Robb, H. F. 1919. Death from rhubarb leaves due to oxalic acid poisoning. J. Am. Med. Assoc., 73: 627-628.

Spoerke, D. G., Smolinske, S. C. 1990. Toxicity of houseplants. CRC Press, Inc., Boca Raton, Fla., USA. 335 pp.

Nomenclature:

Scientific Name: *Rheum rhaponticum* L.

Vernacular name(s): rhubarb

Scientific family name: *Polygonaceae*

Vernacular family name: buckwheat

Go to ITIS*^{ca} for more taxonomic information on: [Rheum rhaponticum](#)

References:

Agriculture Quebec. 1975. Noms des maladies des plantes du Canada/ Names of plant diseases in Canada. , Quebec City, Que., Canada. 288 pp.

Alex, J. F., Cayouette, R., Mulligan, G. A. 1980. Common and botanical names of weeds in Canada/Noms populaire et scientifiques des plantes nuisibles du Canada. Revised. Agric. Can. Publ., Ottawa, Ont., Canada. 132 pp.

Bailey, L. H., Bailey, E. Z. 1976. Hortus third. Revised. MacMillan, New York, N.Y., USA. 1290 pp.

Scoggan, H. J. 1978, 1979. The flora of Canada. Nat. Mus. Nat. Sci. (Ottawa) Publ. Bot. 7(1)-7(4). 1711 pp.

Van Wijk, H. L. 1911. A dictionary of plant names. Martinus Nijhoff, The Hague, The Netherlands. 1444 pp.

Victorin, M. 1964. Flore Laurentienne. 2nd ed. Univ. Montreal, Montreal, Que., Canada. 952 pp.

Geographic Information

Plant or plant parts used in or around the home.

References:

Bailey, L. H., Bailey, E. Z. 1976. Hortus third. Revised. MacMillan, New York, N.Y., USA. 1290 pp.

Boivin, B. 1966, 1967. Énumération des plantes du Canada. Provencheria 6. Nat. Can. (Que.) 93: 253-274; 371-437; 583-646; 989-1063. 94: 131-157; 471-528; 625-655.

Image or illustration

Rheum rhaponticum:

Images: images.google.com

Notes on Poisonous plant parts:

Rhubarb leaves contain the highest amounts of oxalates and perhaps anthraquinones, which may be partly responsible for toxicity. The stalks also contain some low levels of oxalates, but this is not a problem (Cooper and Johnson 1984).

Toxic parts:

leaves

References:

Cooper, M. R., Johnson, A. W. 1984. Poisonous plants in Britain and their effects on animals and man. Her Majesty's Stationery Office, London, England. 305 pp.

Notes on Toxic plant chemicals:

Oxalates are contained in all parts of rhubarb plants, especially in the green leaves. There is some evidence that anthraquinone glycosides are also present and may be partly responsible (Cooper and Johnson 1984).

Toxic plant chemicals:

anthraquinones

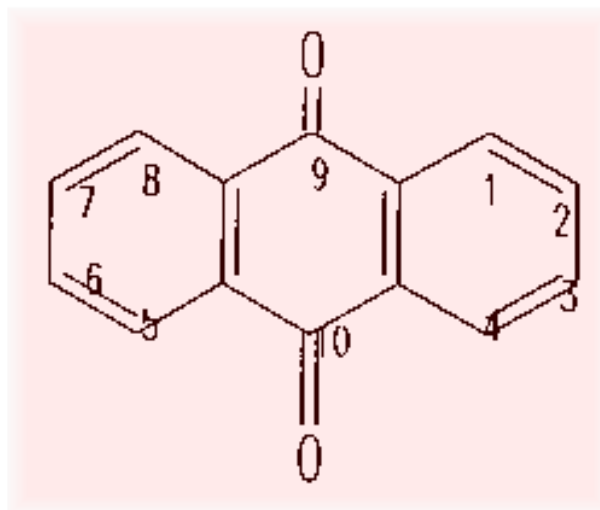

oxalate

Chemical diagram(s) are courtesy of [Ruth McDiarmid](#), Biochemistry Technician, Kamloops Range Station, Agriculture and Agri-Food Canada, Kamloops, British Columbia, Canada.

References:

Cooper, M. R., Johnson, A. W. 1984. Poisonous plants in Britain and their effects on animals and man. Her Majesty's Stationery Office, London, England. 305 pp.

Animals/Human Poisoning:

Note: When an animal is listed without additional information, the literature (as of 1993) contained no detailed explanation.

Goats

General symptoms of poisoning:

[diarrhea](#)
[mouth, frothing of](#)
[vomiting](#)

Notes on poisoning:

A goat that ate rhubarb leaves stood with outspread legs, an open mouth, and protruding eyes. The animal was crying and produced sour green vomit and profuse diarrhea (Cooper and Johnson 1984).

References:

Cooper, M. R., Johnson, A. W. 1984. Poisonous plants in Britain and their effects on animals and man. Her Majesty's Stationery Office, London, England. 305 pp.

Humans

General symptoms of poisoning:

[abdominal pains](#)
[abortion](#)
[convulsions](#)
[death](#)
[drowsiness](#)
[muscle twitching](#)
[nausea](#)
[vomiting](#)

Notes on poisoning:

Ingesting rhubarb leaves has caused many fatalities, especially during World War II, when the leaves were recommended as food for a short time. In one fatal case, oxalic acid was ingested at a rate of only 1.3 g/kg, whereas five or six times this amount normally constitutes a fatal dose. More recent evidence indicates that anthraquinone glycosides may be involved. Symptoms include abdominal pain, nausea, vomiting, weakness, and drowsiness. Blood clotting is reduced. A woman in early pregnancy aborted before she died. Two children ingested 20-100 g of leaves and stalks. They vomited and developed jaundice, with some kidney and liver damage. Analysis for

oxalate crystals in the urine may help diagnosis (Robb 1919, Cooper and Johnson 1984).

References:

Cooper, M. R., Johnson, A. W. 1984. Poisonous plants in Britain and their effects on animals and man. Her Majesty's Stationery Office, London, England. 305 pp.

Robb, H. F. 1919. Death from rhubarb leaves due to oxalic acid poisoning. J. Am. Med. Assoc., 73: 627-628.

Spoerke, D. G., Smolinske, S. C. 1990. Toxicity of houseplants. CRC Press, Inc., Boca Raton, Fla., USA. 335 pp.

Swine

General symptoms of poisoning:

[convulsions](#)

[death](#)

[gait, staggering](#)

[mouth, frothing of](#)

Notes on poisoning:

Swine that ingested rhubarb plants exhibited the following symptoms: foaming at the mouth, staggering, and convulsions, followed by death. Postmortem examination revealed severe inflammation of the stomach and intestines (Cooper and Johnson 1984).

References:

Cooper, M. R., Johnson, A. W. 1984. Poisonous plants in Britain and their effects on animals and man. Her Majesty's Stationery Office, London, England. 305 pp.

[Another search?](#)

[Français](#) | [Contact Us](#) | [Help](#) | [Search](#) | [Canada site](#)

[Coming Events](#) | [About CBIF](#) | [Links](#) | [Reports and Publications](#) |

[Home](#)

Date modified: 2003-02-06

[Important Notices](#)



Français	Contact us	Help	Search	Canada site
Coming events	About CBIF	Links	Reports and publications	Home

Canadian Biodiversity Information Facility



Notes on poisoning: *Rhododendron albiflorum*

[Introduction](#)[Interactive](#)[All poisonous plants by
Botanical name](#)[All poisonous plants by
Common name](#)[Important WWW Poisonous
Plants sites](#)

General poisoning notes:

White rose-bay (*Rhododendron albiflorum*) is a native shrub found in southwestern British Columbia. This plant is toxic to sheep, although rare cases of cattle poisoning may occur. The plant contains andromedotoxins (grayanotoxins) that can cause sickness and death after they are ingested by animals (Kingsbury 1964, Looman et al. 1983).

References:

Kingsbury, J. M. 1964. Poisonous plants of the United States and Canada. Prentice-Hall Inc., Englewood Cliffs, N.J., USA. 626 pp.

Looman, J., Majak, W., Smoliak, S. 1983. Stock-poisoning plants of western Canada. Agric. Can. Res. Branch Contrib. 1982-7E. 35 pp.

Nomenclature:

Scientific Name: *Rhododendron albiflorum* Lam.

Vernacular name(s): white rose-bay

Scientific family name: *Ericaceae*

Vernacular family name: heath

Go to ITIS^{*ca} for more taxonomic information on: [Rhododendron albiflorum](#)

References:

Agriculture Quebec. 1975. Noms des maladies des plantes du Canada/ Names of plant diseases in Canada. , Quebec City, Que., Canada. 288 pp.

Alex, J. F., Cayouette, R., Mulligan, G. A. 1980. Common and botanical names of weeds in Canada/Noms populaire et scientifiques des plantes nuisibles du Canada. Revised. Agric. Can. Publ., Ottawa, Ont., Canada.



132 pp.

Bailey, L. H., Bailey, E. Z. 1976. Hortus third. Revised. MacMillan, New York, N.Y., USA. 1290 pp.

Scoggan, H. J. 1978, 1979. The flora of Canada. Nat. Mus. Nat. Sci. (Ottawa) Publ. Bot. 7(1)-7(4). 1711 pp.

Van Wijk, H. L. 1911. A dictionary of plant names. Martinus Nijhoff, The Hague, The Netherlands. 1444 pp.

Victorin, M. 1964. Flore Laurentienne. 2nd ed. Univ. Montreal, Montreal, Que., Canada. 952 pp.

Geographic Information

Alberta
British Columbia

References:

Bailey, L. H., Bailey, E. Z. 1976. Hortus third. Revised. MacMillan, New York, N.Y., USA. 1290 pp.

Boivin, B. 1966, 1967. Énumération des plantes du Canada. Provencheria 6. Nat. Can. (Que.) 93: 253-274; 371-437; 583-646; 989-1063. 94: 131-157; 471-528; 625-655.

Image or illustration

Rhododendron albiflorum:

Images: images.google.com

Toxic parts:

leaves

References:

Looman, J., Majak, W., Smoliak, S. 1983. Stock-poisoning plants of western Canada. Agric. Can. Res. Branch Contrib. 1982-7E. 35 pp.

Notes on Toxic plant chemicals:

Andromedotoxins (including grayanotoxin I) are toxic diterpenoids that are present in all the poisonous members of the heath family, Ericaceae (Cooper and Johnson 1984).

Toxic plant chemicals:

andromedotoxins

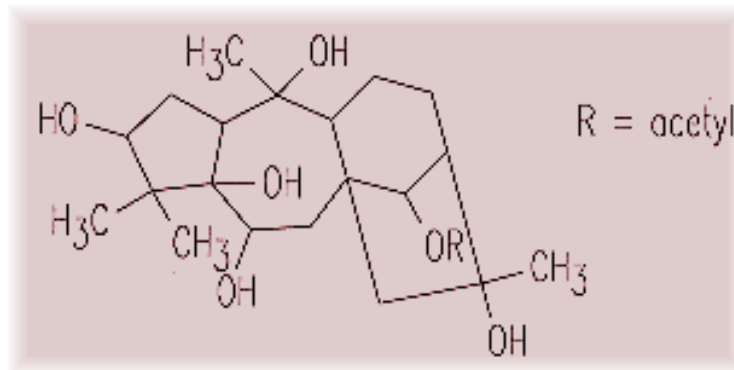

Chemical diagram(s) are courtesy of [Ruth McDiarmid](#), Biochemistry Technician, Kamloops Range Station, Agriculture and Agri-Food Canada, Kamloops, British Columbia, Canada.

References:

Cooper, M. R., Johnson, A. W. 1984. Poisonous plants in Britain and their effects on animals and man. Her Majesty's Stationery Office, London, England. 305 pp.

Animals/Human Poisoning:

Note: When an animal is listed without additional information, the literature (as of 1993) contained no detailed explanation.

Cattle

General symptoms of poisoning:

[anorexia](#)

[death](#)

[nasal discharge](#)

[salivation](#)

[vomiting](#)

[weakness](#)

Notes on poisoning:

Cattle are not poisoned as often as sheep because of the bitter taste of the leaves. Symptoms of ingestion may include initial anorexia, salivation, and dullness. Vomiting may be accompanied by bloat. Abdominal pain and nasal discharge occur. In severe cases, death may result (Kingsbury 1964).

References:

Kingsbury, J. M. 1964. Poisonous plants of the United States and Canada. Prentice-Hall Inc., Englewood Cliffs, N.J., USA. 626 pp.

Sheep

General symptoms of poisoning:

[convulsions](#)

[death](#)

[nasal discharge](#)

[paralysis](#)

[salivation](#)

Notes on poisoning:

The palatability of the leaves is low. However, ingesting the leaves causes symptoms, including salivation, nasal discharge, convulsions, paralysis of the limbs, and weakness. In severe cases, death can occur after a period of coma (Looman et al. 1983).

References:

Kingsbury, J. M. 1964. Poisonous plants of the United States and Canada. Prentice-Hall Inc., Englewood Cliffs, N.J., USA. 626 pp.

Looman, J., Majak, W., Smoliak, S. 1983. Stock-poisoning plants of western Canada. Agric. Can. Res. Branch Contrib. 1982-7E. 35 pp.

[Another search?](#)

[Français](#) | [Contact Us](#) | [Help](#) | [Search](#) | [Canada site](#)

[Coming Events](#) | [About CBIF](#) | [Links](#) | [Reports and Publications](#) | [Home](#)

Date modified: 2003-02-06

[Important Notices](#)



Français	Contact us	Help	Search	Canada site
Coming events	About CBIF	Links	Reports and publications	Home

Canadian Biodiversity Information Facility



Notes on poisoning:

Rhododendron

macrophyllum

[Introduction](#)[Interactive](#)[All poisonous plants by](#)[Botanical name](#)[All poisonous plants by](#)[Common name](#)[Important WWW Poisonous](#)[Plants sites](#)

General poisoning notes:

California rose-bay (*Rhododendron macrophyllum*) is a native shrub found in southwestern British Columbia. This plant has poisoned goats and sheep. Azaleas are now considered part of the genus *Rhododendron*. Animals and humans have been poisoned after ingesting the foliage, nectar, or honey made from these plants. Klein-Schwartz and Litovitz (1985) found that humans who ingested plant parts of *Rhododendron* plants exhibited few symptoms of poisoning. Of 152 cases, only nine developed any symptoms and only one resulted in vomiting and transient hypertension. The authors concluded that ingesting moderate amounts of azalea material posed little danger to humans. Azaleas are often used as houseplants. Children and family pets should be prevented from ingesting these plants. Livestock have been poisoned by ingesting foliage of azaleas and rhododendrons. Sheep are most commonly affected in North America. Death has occurred in some cases (Casteel and Wagstaff 1989). Poisoning usually occurs when animals gain access to clippings or when little other forage is available, as in the winter. Rhododendrons retain their leaves over the winter. Goats and cattle have been poisoned as well. Andromedotoxins (grayanotoxins) are the toxins involved.

References:

Casteel, S., Wagstaff, J. 1989. *Rhododendron macrophyllum* poisoning in a group of goats and sheep. *Vet. Hum. Toxicol.*, 31: 176-177.

Klein-Schwartz, W., Litovitz, T. 1985. Azalea toxicity: an overrated problem?. *Clin. Toxicol.*, 23: 91-101.

Nomenclature:

Scientific Name: *Rhododendron macrophyllum* D. Don ex G. Don

Vernacular name(s): California rose-bay

Scientific family name: *Ericaceae*

Vernacular family name: heath

Go to ITIS*^{ca} for more taxonomic information on: [Rhododendron macrophyllum](#)

References:

- Agriculture Quebec. 1975. Noms des maladies des plantes du Canada/ Names of plant diseases in Canada. , Quebec City, Que., Canada. 288 pp.
- Alex, J. F., Cayouette, R., Mulligan, G. A. 1980. Common and botanical names of weeds in Canada/Noms populaire et scientifiques des plantes nuisibles du Canada. Revised. Agric. Can. Publ., Ottawa, Ont., Canada. 132 pp.
- Bailey, L. H., Bailey, E. Z. 1976. Hortus third. Revised. MacMillan, New York, N.Y., USA. 1290 pp.
- Scoggan, H. J. 1978, 1979. The flora of Canada. Nat. Mus. Nat. Sci. (Ottawa) Publ. Bot. 7(1)-7(4). 1711 pp.
- Van Wijk, H. L. 1911. A dictionary of plant names. Martinus Nijhoff, The Hague, The Netherlands. 1444 pp.
- Victorin, M. 1964. Flore Laurentienne. 2nd ed. Univ. Montreal, Montreal, Que., Canada. 952 pp.

Geographic Information

British Columbia

References:

- Bailey, L. H., Bailey, E. Z. 1976. Hortus third. Revised. MacMillan, New York, N.Y., USA. 1290 pp.
- Boivin, B. 1966, 1967. Énumération des plantes du Canada. Provencheria 6. Nat. Can. (Que.) 93: 253-274; 371-437; 583-646; 989-1063. 94: 131-157; 471-528; 625-655.

Image or illustration

Rhododendron macrophyllum:

Images: images.google.com

Notes on Poisonous plant parts:

The leaves and stems of this plant have caused poisoning (Casteel and

Wagstaff 1989).

Toxic parts:

leaves
stems

References:

Casteel, S., Wagstaff, J. 1989. *Rhododendron macrophyllum* poisoning in a group of goats and sheep. *Vet. Hum. Toxicol.*, 31: 176-177.

Notes on Toxic plant chemicals:

Andromedotoxins (including grayanotoxin I) are toxic diterpenoids that are present in all the poisonous members of Ericaceae, the heath family (Cooper and Johnson 1984).

Toxic plant chemicals:

andromedotoxins

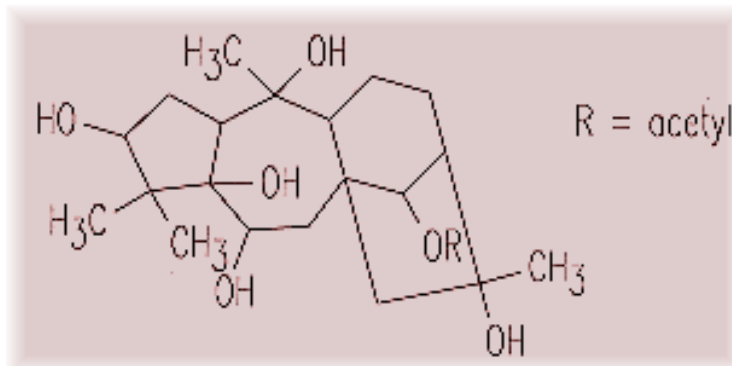

Chemical diagram(s) are courtesy of [Ruth McDiarmid](#), Biochemistry Technician, Kamloops Range Station, Agriculture and Agri-Food Canada, Kamloops, British Columbia, Canada.

References:

Cooper, M. R., Johnson, A. W. 1984. *Poisonous plants in Britain and their effects on animals and man*. Her Majesty's Stationery Office, London, England. 305 pp.

Animals/Human Poisoning:

Note: When an animal is listed without additional information, the literature (as of 1993) contained no detailed explanation.

Goats

General symptoms of poisoning:

[ataxia](#)

[colic](#)

[convulsions](#)

[death](#)

[opisthotonos](#)

[recumbency, lateral](#)

[vomiting](#)

[weakness](#)

Notes on poisoning:

In one case, several young and adult goats gained access to clippings of California rose-bay; most were poisoned, and some young goats died. Symptoms included initial lateral recumbency and a tonic-clonic convulsive episode starting 6 h after ingestion. Vomiting, ataxia, and weakness occurred. Vomiting continued over 2 days. Intense colic was observed. Lactating goats dried up. Some animals remained recumbent for a couple of days (Casteel and Wagstaff 1989).

References:

Casteel, S., Wagstaff, J. 1989. *Rhododendron macrophyllum* poisoning in a group of goats and sheep. *Vet. Hum. Toxicol.*, 31: 176-177.

Humans

General symptoms of poisoning:

[mouth, irritation of](#)

[vomiting](#)

Notes on poisoning:

Klein-Schwartz and Litovitz (1985) found that only minimal symptoms were exhibited, such as vomiting, after ingesting species of the genus *Rhododendron*. Lampe and McCann (1985) note that ingesting significant quantities of leaves can cause more severe symptoms such as burning of the mouth, salivation, vomiting, diarrhea, headache, and dimness of vision. Such occurrences are unlikely because of the bitterness of the leaves. Reports occur regarding the toxicity of honey made from azaleas and rhododendrons. This honey is bitter and is unlikely to be ingested in large quantities.

References:

Klein-Schwartz, W., Litovitz, T. 1985. Azalea toxicity: an overrated

problem?.Clin. Toxicol., 23: 91-101.

Sheep

General symptoms of poisoning:

[ataxia](#)

[colic](#)

[depression](#)

[recumbency](#)

[vomiting](#)

[weakness](#)

Notes on poisoning:

Ingesting clippings of California rose-bay caused illness in sheep. Symptoms included severe vomiting, ataxia, and weakness. Vomiting continued over a few days. The animals walked a short distance and then fell down. Some animals remained recumbent for many hours. Colic was observed (Casteel and Wagstaff 1989).

References:

Casteel, S., Wagstaff, J. 1989. *Rhododendron macrophyllum* poisoning in a group of goats and sheep. Vet. Hum. Toxicol., 31: 176-177.

[Another search?](#)

[Français](#) | [Contact Us](#) | [Help](#) | [Search](#) | [Canada site](#)

[Coming Events](#) | [About CBIF](#) | [Links](#) | [Reports and Publications](#) | [Home](#)

Date modified: 2003-02-06

[Important Notices](#)



Français	Contact us	Help	Search	Canada site
Coming events	About CBIF	Links	Reports and publications	Home

Canadian Biodiversity Information Facility



Notes on poisoning: *Rhus diversiloba*

[Introduction](#)[Interactive](#)[All poisonous plants by Botanical name](#)[All poisonous plants by Common name](#)[Important WWW Poisonous Plants sites](#)

General poisoning notes:

Western poison-oak (*Rhus diversiloba*; synonym *Toxicodendron diversiloba*) is a native shrub found in southwestern British Columbia. This plant contains urushiol, which is highly sensitizing in humans. Reactions can range from mild redness to large areas of oozing lesions and fever (Mulligan 1990, Gayer and Burnett 1988). For more information please see the bulletin "[Poison Ivy, Western Poison Oak, Poison Sumac](#)"

References:

Epstein, W. L., Byers, V. S. 1981. Poison oak and poison ivy dermatitis. Prevention and treatment in forest service work. U.S. Dep. Agric. For. Serv. Rep., 14 pp.

Gayer, K. D., Burnett, J. W. 1988. *Toxicodendron* dermatitis. *Cutis*, 42: 99-100.

Mulligan, G. A. 1990. [Poison ivy. Western poison oak. Poison sumac](#). Agric. Can. Publ., 1699. 13 pp.

Nomenclature:

Scientific Name: *Rhus diversiloba* T. & G.

Vernacular name(s): western poison-oak

Scientific family name: *Anacardiaceae*

Vernacular family name: cashew

Go to ITIS^{*ca} for more taxonomic information on: [Rhus diversiloba](#)

References:

Agriculture Quebec. 1975. Noms des maladies des plantes du Canada/ Names of plant diseases in Canada. , Quebec City, Que., Canada. 288 pp.

Alex, J. F., Cayouette, R., Mulligan, G. A. 1980. Common and botanical names of weeds in Canada/Noms populaire et scientifiques des plantes nuisibles du Canada. Revised. Agric. Can. Publ., Ottawa, Ont., Canada. 132 pp.

Bailey, L. H., Bailey, E. Z. 1976. Hortus third. Revised. MacMillan, New York, N.Y., USA. 1290 pp.

Scoggan, H. J. 1978, 1979. The flora of Canada. Nat. Mus. Nat. Sci. (Ottawa) Publ. Bot. 7(1)-7(4). 1711 pp.

Van Wijk, H. L. 1911. A dictionary of plant names. Martinus Nijhoff, The Hague, The Netherlands. 1444 pp.

Victorin, M. 1964. Flore Laurentienne. 2nd ed. Univ. Montreal, Montreal, Que., Canada. 952 pp.

Geographic Information

British Columbia

References:

Bailey, L. H., Bailey, E. Z. 1976. Hortus third. Revised. MacMillan, New York, N.Y., USA. 1290 pp.

Boivin, B. 1966, 1967. Énumération des plantes du Canada. Provencheria 6. Nat. Can. (Que.) 93: 253-274; 371-437; 583-646; 989-1063. 94: 131-157; 471-528; 625-655.

Image or illustration

Rhus diversiloba:

Images: images.google.com

Notes on Poisonous plant parts:

All parts of the plant, with the exception of the pollen, anthers, xylem, and epidermis, contain the allergen urushiol. Even in winter, sap from damaged stems causes allergic reactions. Similarly, damage to the root results in dermatitis (Mulligan 1990, Gayer and Burnett 1988).

Toxic parts:

all parts
flowers
immature fruit
leaves
mature fruit
plant juices
stems

References:

Epstein, W. L., Byers, V. S. 1981. Poison oak and poison ivy dermatitis. Prevention and treatment in forest service work. U.S. Dep. Agric. For. Serv. Rep., 14 pp.

Gayer, K. D., Burnett, J. W. 1988. *Toxicodendron* dermatitis. *Cutis*, 42: 99-100.

Mulligan, G. A. 1990. [Poison ivy. Western poison oak. Poison sumac](#). Agric. Can. Publ., 1699. 13 pp.

Notes on Toxic plant chemicals:

Urushiol, a nonvolatile phenolic allergen, includes alkylcatechols, found in all toxic *Rhus* species. Urushiol is found in the resin canals that occur throughout the plants. The toxin is exposed after damage to the plant (Gayer and Burnett 1988).

Toxic plant chemicals:

urushiol oil

References:

Epstein, W. L., Byers, V. S. 1981. Poison oak and poison ivy dermatitis. Prevention and treatment in forest service work. U.S. Dep. Agric. For. Serv. Rep., 14 pp.

Gayer, K. D., Burnett, J. W. 1988. *Toxicodendron* dermatitis. *Cutis*, 42: 99-100.

Schmidt, R. J., Khan, L., Chung, L. Y. 1990. Are free radicals and not quinones the haptenic species derived from urushiols and other contact allergenic mono- and dihydride alkylbenzenes? *Dermatol. Res.*, 282: 56-64.

Animals/Human Poisoning:

Note: When an animal is listed without additional information,

the literature (as of 1993) contained no detailed explanation.

Humans

General symptoms of poisoning:

[blistering](#)

[blisters, weeping](#)

[itchiness](#)

[temperature, elevated](#)

References:

Epstein, W. L., Byers, V. S. 1981. Poison oak and poison ivy dermatitis. Prevention and treatment in forest service work. U.S. Dep. Agric. For. Serv. Rep., 14 pp.

Mulligan, G. A. 1990. [Poison ivy. Western poison oak. Poison sumac](#). Agric. Can. Publ., 1699. 13 pp.

[Another search?](#)

[Français](#) | [Contact Us](#) | [Help](#) | [Search](#) | [Canada site](#)

[Coming Events](#) | [About CBIF](#) | [Links](#) | [Reports and Publications](#) |

[Home](#)

Date modified: 2003-02-06

[Important Notices](#)



Français	Contact us	Help	Search	Canada site
Coming events	About CBIF	Links	Reports and publications	Home

Canadian Biodiversity Information Facility



Notes on poisoning: *Rhus radicans*

[Introduction](#)[Interactive](#)[All poisonous plants by Botanical name](#)[All poisonous plants by Common name](#)[Important WWW Poisonous Plants sites](#)

General poisoning notes:

Poison ivy (*Rhus radicans*; synonym *Toxicodendron radicans*) is a native shrub or vine found throughout southern Canada. Three recognized varieties are found in various parts of the country (Mulligan and Junkins 1977). Urushiol is the allergenic agent found in most parts of the plant. Damage to plant tissues causes the nonvolatile chemicals to be exposed. Humans are often sensitized, with symptoms ranging from mild itchiness and redness to severe oozing lesions with fever. Poison ivy is probably responsible for more cases of plant dermatitis in Canada than any other plant. Urushiol can contaminate clothes, tools, and the fur of domestic animals. Humans can subsequently develop dermatitis from contact. Humans do not contract the dermatitis on first contact, but most people are sensitized the first time (Mulligan 1990, Schwartz and Downham 1981, Gayer and Burnett 1988). For more information please see the bulletin "[Poison Ivy, Western Poison Oak, Poison Sumac](#)"

References:

Downham, T. F. 1986. Science has got its hands on poison-ivy, poison-oak, and poison-sumac. U.S. Dep. Agric. For. Serv. Man. N., 47: 23-28.

Epstein, W. L., Byers, V. S. 1981. Poison oak and poison ivy dermatitis. Prevention and treatment in forest service work. U.S. Dep. Agric. For. Serv. Rep., 14 pp.

Gaillard, G. E. 1956. The modern treatment of poison ivy. N. Y. State J. Med., 56:2255-2259.

Gayer, K. D., Burnett, J. W. 1988. *Toxicodendron* dermatitis. Cutis, 42: 99-100.

Goldsmith, M. F. 1984. Sensitivity test may aid in avoiding 'poison' plant-induced dermatitis. J. Am. Med. Assoc., 251:

1389-1390.

Guin, J. D. 1980. Reaction time in experimental poison ivy dermatitis. *Contact Dermatitis*, 6:289-290.

Mulligan, G. A., Junkins, B. E. 1977. The biology of Canadian weeds 23. *Rhus radicans* L. *Can. J. Plant Sci.*, 57: 515-523.

Mulligan, G. A. 1990. [Poison ivy. Western poison oak. Poison sumac](#). *Agric. Can. Publ.*, 1699. 13 pp.

Schwartz, R. S. 1981. Erythema multiforme associated with *Rhus* contact dermatitis. *Cutis*, 27: 85-86.

Nomenclature:

Scientific Name: *Rhus radicans* L.

Vernacular name(s): poison ivy

Scientific family name: *Anacardiaceae*

Vernacular family name: cashew

Go to ITIS^{*ca} for more taxonomic information on: [Rhus radicans](#)

References:

Agriculture Quebec. 1975. Noms des maladies des plantes du Canada/ Names of plant diseases in Canada. , Quebec City, Que., Canada. 288 pp.

Alex, J. F., Cayouette, R., Mulligan, G. A. 1980. Common and botanical names of weeds in Canada/Noms populaire et scientifiques des plantes nuisibles du Canada. Revised. *Agric. Can. Publ.*, Ottawa, Ont., Canada. 132 pp.

Bailey, L. H., Bailey, E. Z. 1976. *Hortus third*. Revised. MacMillan, New York, N.Y., USA. 1290 pp.

Scoggan, H. J. 1978, 1979. The flora of Canada. *Nat. Mus. Nat. Sci. (Ottawa) Publ. Bot.* 7(1)-7(4). 1711 pp.

Van Wijk, H. L. 1911. A dictionary of plant names. Martinus Nijhoff, The Hague, The Netherlands. 1444 pp.

Victorin, M. 1964. *Flore Laurentienne*. 2nd ed. Univ. Montreal, Montreal, Que., Canada. 952 pp.

Geographic Information

Alberta
British Columbia
Manitoba

New Brunswick
Nova Scotia
Ontario
Prince Edward Island
Quebec
Saskatchewan

References:

Bailey, L. H., Bailey, E. Z. 1976. Hortus third. Revised. MacMillan, New York, N.Y., USA. 1290 pp.

Boivin, B. 1966, 1967. Énumération des plantes du Canada. Provencheria 6. Nat. Can. (Que.) 93: 253-274; 371-437; 583-646; 989-1063. 94: 131-157; 471-528; 625-655.

Image or illustration

Rhus radicans:

Images: images.google.com

Toxic parts:

all parts
leaves
plant juices

References:

Gayer, K. D., Burnett, J. W. 1988. *Toxicodendron* dermatitis. Cutis, 42: 99-100.

Goldsmith, M. F. 1984. Sensitivity test may aid in avoiding 'poison' plant-induced dermatitis. J. Am. Med. Assoc., 251: 1389-1390.

Mulligan, G. A., Junkins, B. E. 1977. The biology of Canadian weeds 23. *Rhus radicans* L. Can. J. Plant Sci., 57: 515-523.

Mulligan, G. A. 1990. [Poison ivy. Western poison oak. Poison sumac](#). Agric. Can. Publ., 1699. 13 pp.

Schwartz, R. S. 1981. Erythema multiforme associated with *Rhus* contact dermatitis. Cutis, 27: 85-86.

Notes on Toxic plant chemicals:

Urushiol, a group of alkylcatechols, is found in the sap of poison-ivy plants. The allergic reaction has been traditionally thought to involve initial oxidation by which a protein-reactive

quinone is formed. Recent work indicates that redox cycling in the skin, following penetration of the allergenic alkybenzenes, initially depletes local levels of endogenous-reducing equivalents such as NADH and glutathione. Further cycling results in the uncontrolled generation of radical species that exhibit protein reactivity. The urushiol is not volatile and can contaminate clothing, tools, and domestic animals. Under dry conditions, the chemical can remain harmful for long periods (Mulligan 1990, Schmidt et al. 1990).

Toxic plant chemicals:

urushiol oil
3-pentadecyl catechol

References:

Downham, T. F. 1986. Science has got its hands on poison-ivy, poison-oak, and poison-sumac. U.S. Dep. Agric. For. Serv. Man. N., 47: 23-28.

Gaillard, G. E. 1956. The modern treatment of poison ivy. N. Y. State J. Med., 56:2255-2259.

Gayer, K. D., Burnett, J. W. 1988. *Toxicodendron* dermatitis. Cutis, 42: 99-100.

Goldsmith, M. F. 1984. Sensitivity test may aid in avoiding 'poison' plant-induced dermatitis. J. Am. Med. Assoc., 251: 1389-1390.

Mulligan, G. A., Junkins, B. E. 1977. The biology of Canadian weeds 23. *Rhus radicans* L. Can. J. Plant Sci., 57: 515-523.

Mulligan, G. A. 1990. [Poison ivy. Western poison oak. Poison sumac.](#) Agric. Can. Publ., 1699. 13 pp.

Schmidt, R. J., Khan, L., Chung, L. Y. 1990. Are free radicals and not quinones the haptenic species derived from urushiols and other contact allergenic mono- and dihydride alkybenzenes? Dermatol. Res., 282: 56-64.

Animals/Human Poisoning:

Note: When an animal is listed without additional information, the literature (as of 1993) contained no detailed explanation.

Humans

General symptoms of poisoning:

[blistering](#)

[blisters, weeping](#)

[erythema](#)

[face, edema of](#)

[itchiness](#)

[pneumonitis](#)

[temperature, elevated](#)

[tracheitis](#)

References:

Downham, T. F. 1986. Science has got its hands on poison-ivy, poison-oak, and poison-sumac. U.S. Dep. Agric. For. Serv. Man. N., 47: 23-28.

Epstein, W. L., Byers, V. S. 1981. Poison oak and poison ivy dermatitis. Prevention and treatment in forest service work. U.S. Dep. Agric. For. Serv. Rep., 14 pp.

Gayer, K. D., Burnett, J. W. 1988. *Toxicodendron* dermatitis. *Cutis*, 42: 99-100.

Goldsmith, M. F. 1984. Sensitivity test may aid in avoiding 'poison' plant-induced dermatitis. *J. Am. Med. Assoc.*, 251: 1389-1390.

Guin, J. D. 1980. Reaction time in experimental poison ivy dermatitis. *Contact Dermatitis*, 6:289-290.

Mulligan, G. A., Junkins, B. E. 1977. The biology of Canadian weeds 23. *Rhus radicans* L. *Can. J. Plant Sci.*, 57: 515-523.

Mulligan, G. A. 1990. [Poison ivy. Western poison oak. Poison sumac.](#) Agric. Can. Publ., 1699. 13 pp.

Schwartz, R. S. 1981. Erythema multiforme associated with *Rhus* contact dermatitis. *Cutis*, 27: 85-86.

[Another search?](#)

[Français](#) | [Contact Us](#) | [Help](#) | [Search](#) | [Canada site](#)

[Coming Events](#) | [About CBIF](#) | [Links](#) | [Reports and Publications](#) |

[Home](#)

Date modified: 2003-02-06

[Important Notices](#)



Français	Contact us	Help	Search	Canada site
Coming events	About CBIF	Links	Reports and publications	Home

Canadian Biodiversity Information Facility



Notes on poisoning: *Rhus vernix*

[Introduction](#)[Interactive](#)[All poisonous plants by Botanical name](#)[All poisonous plants by Common name](#)[Important WWW Poisonous Plants sites](#)

General poisoning notes:

Poison sumac (*Rhus vernix*; synonymy *Toxicodendron vernix*) is a native shrub or vine found in southern Quebec and southern Ontario. The sap of this plant contains the allergen urushiol. The chemical is released when plant tissue is damaged. Humans are highly sensitive to allergic reaction, although at least one exposure is needed for sensitization. Mild to severe dermatitis can result from exposure to poison sumac (Mulligan 1990, Gayer and Burnett 1988). For more information please see the bulletin "[Poison Ivy, Western Poison Oak, Poison Sumac](#)"

References:

- Epstein, W. L., Byers, V. S. 1981. Poison oak and poison ivy dermatitis. Prevention and treatment in forest service work. U.S. Dep. Agric. For. Serv. Rep., 14 pp.
- Gayer, K. D., Burnett, J. W. 1988. *Toxicodendron* dermatitis. *Cutis*, 42: 99-100.
- Mulligan, G. A. 1990. [Poison ivy. Western poison oak. Poison sumac](#). Agric. Can. Publ., 1699. 13 pp.

Nomenclature:

Scientific Name: *Rhus vernix* L.

Vernacular name(s): poison sumac

Scientific family name: *Anacardiaceae*

Vernacular family name: cashew

Go to ITIS*^{ca} for more taxonomic information on: [Rhus vernix](#)

References:

Agriculture Quebec. 1975. Noms des maladies des plantes du Canada/ Names of plant diseases in Canada. , Quebec City, Que., Canada. 288 pp.

Alex, J. F., Cayouette, R., Mulligan, G. A. 1980. Common and botanical names of weeds in Canada/Noms populaire et scientifiques des plantes nuisibles du Canada. Revised. Agric. Can. Publ., Ottawa, Ont., Canada. 132 pp.

Bailey, L. H., Bailey, E. Z. 1976. Hortus third. Revised. MacMillan, New York, N.Y., USA. 1290 pp.

Scoggan, H. J. 1978, 1979. The flora of Canada. Nat. Mus. Nat. Sci. (Ottawa) Publ. Bot. 7(1)-7(4). 1711 pp.

Van Wijk, H. L. 1911. A dictionary of plant names. Martinus Nijhoff, The Hague, The Netherlands. 1444 pp.

Victorin, M. 1964. Flore Laurentienne. 2nd ed. Univ. Montreal, Montreal, Que., Canada. 952 pp.

Geographic Information

Ontario

Quebec

References:

Bailey, L. H., Bailey, E. Z. 1976. Hortus third. Revised. MacMillan, New York, N.Y., USA. 1290 pp.

Boivin, B. 1966, 1967. Énumération des plantes du Canada. Provencheria 6. Nat. Can. (Que.) 93: 253-274; 371-437; 583-646; 989-1063. 94: 131-157; 471-528; 625-655.

Image or illustration

Rhus vernix:

Images: images.google.com

Notes on Poisonous plant parts:

Most parts of poison sumac contain the allergen except the pollen, anthers, xylem, and epidermis. Damage to plant parts releases the sap that contains the allergen (Mulligan 1990). The allergen occurs in the plant sap, which is found in all plant parts except the pollen, anthers, xylem, and epidermis. If the stems are damaged they can release the allergen, even in the winter. The

roots are also dangerous (Mulligan 1990).

Toxic parts:

all parts
leaves
mature fruit
plant juices
roots
stems

References:

Epstein, W. L., Byers, V. S. 1981. Poison oak and poison ivy dermatitis. Prevention and treatment in forest service work. U.S. Dep. Agric. For. Serv. Rep., 14 pp.

Mulligan, G. A. 1990. [Poison ivy. Western poison oak. Poison sumac.](#) Agric. Can. Publ., 1699. 13 pp.

Notes on Toxic plant chemicals:

Urushiol, an group of alkylcatechols, is found in the sap of poison sumac. The allergen is nonvolatile and can contaminate clothing, tools, and domestic animals. The allergen can be hazardous for a long time if the contaminated object remains dry (Gayer and Burnett 1988). See poison-ivy ([Rhus radicans](#)) for additional information.

Toxic plant chemicals:

urushiol oil

References:

Epstein, W. L., Byers, V. S. 1981. Poison oak and poison ivy dermatitis. Prevention and treatment in forest service work. U.S. Dep. Agric. For. Serv. Rep., 14 pp.

Gayer, K. D., Burnett, J. W. 1988. *Toxicodendron* dermatitis. *Cutis*, 42: 99-100.

Animals/Human Poisoning:

Note: When an animal is listed without additional information, the literature (as of 1993) contained no detailed explanation.

Humans

General symptoms of poisoning:

[blistering](#)

[blisters, weeping](#)

[itchiness](#)

[temperature, elevated](#)

References:

Epstein, W. L., Byers, V. S. 1981. Poison oak and poison ivy dermatitis. Prevention and treatment in forest service work. U.S. Dep. Agric. For. Serv. Rep., 14 pp.

Mulligan, G. A. 1990. [Poison ivy. Western poison oak. Poison sumac](#). Agric. Can. Publ., 1699. 13 pp.

[Another search?](#)

[Français](#) | [Contact Us](#) | [Help](#) | [Search](#) | [Canada site](#)

[Coming Events](#) | [About CBIF](#) | [Links](#) | [Reports and Publications](#) | [Home](#)

Date modified: 2003-02-06

[Important Notices](#)



Français	Contact us	Help	Search	Canada site
Coming events	About CBIF	Links	Reports and publications	Home

Canadian Biodiversity Information Facility



Notes on poisoning: *Ricinus communis*

[Introduction](#)[Interactive](#)[All poisonous plants by Botanical name](#)[All poisonous plants by Common name](#)[Important WWW Poisonous Plants sites](#)

General poisoning notes:

Castor bean (*Ricinus communis*) is an ornamental herbaceous shrub that is occasionally planted indoors or outdoors as a rapidly growing annual ornamental. The seeds (and to a much lesser extent the leaves) contain ricin, a protein, which is highly toxic in small quantities. Humans as well as cattle, dogs, goats, horses, poultry, rabbits, sheep, and swine have been poisoned after ingesting the seeds. The seed coat must be damaged to allow water to penetrate the seed interior, thus releasing the water-soluble toxin ricin. Most reported cases of animal poisoning have occurred overseas where the seed is used as food and, if improperly treated, has caused illness and death. Humans who ingested the seeds became ill and died. The toxin has been used for of suicide and assassination. Two to four chewed seeds can cause death in children (Cooper and Johnson 1984, Griffiths et al. 1987).

DO NOT ALLOW THESE PLANTS TO SET SEEDS!!

References:

Cooper, M. R., Johnson, A. W. 1984. Poisonous plants in Britain and their effects on animals and man. Her Majesty's Stationery Office, London, England. 305 pp.

Griffiths, G. D., Leek, M. D., Gee, D. J. 1987. The toxic plant proteins ricin and abrin induce apoptotic changes in mammalian lymphoid tissues and intestine. J. Pathol., 151: 221-229.

Griffiths, G., Leith, A., Green, M. 1987. Proteins that play Jekyll and Hyde. New Sci., 115: 59-61.

Hoy, D. L., Catling, P. M. 1981. Necklaces from nature - seed jewelry. Davidsonia, 12: 63-77.

Malizia, E., Sarcinelli, L., Andreucci, G. 1977. Ricinus poisoning: a familiar epidemy. Acta Pharm. Toxicol., 41:

351-361.

Nomenclature:

Scientific Name: *Ricinus communis* L.

Vernacular name(s): castor-bean

Scientific family name: *Euphorbiaceae*

Vernacular family name: spurge

Go to ITIS^{*ca} for more taxonomic information on: [Ricinus communis](#)

References:

Agriculture Quebec. 1975. Noms des maladies des plantes du Canada/ Names of plant diseases in Canada. , Quebec City, Que., Canada. 288 pp.

Alex, J. F., Cayouette, R., Mulligan, G. A. 1980. Common and botanical names of weeds in Canada/Noms populaire et scientifiques des plantes nuisibles du Canada. Revised. Agric. Can. Publ., Ottawa, Ont., Canada. 132 pp.

Bailey, L. H., Bailey, E. Z. 1976. Hortus third. Revised. MacMillan, New York, N.Y., USA. 1290 pp.

Scoggan, H. J. 1978, 1979. The flora of Canada. Nat. Mus. Nat. Sci. (Ottawa) Publ. Bot. 7(1)-7(4). 1711 pp.

Van Wijk, H. L. 1911. A dictionary of plant names. Martinus Nijhoff, The Hague, The Netherlands. 1444 pp.

Victorin, M. 1964. Flore Laurentienne. 2nd ed. Univ. Montreal, Montreal, Que., Canada. 952 pp.

Geographic Information

Plant or plant parts used in or around the home.

References:

Bailey, L. H., Bailey, E. Z. 1976. Hortus third. Revised. MacMillan, New York, N.Y., USA. 1290 pp.

Boivin, B. 1966, 1967. Énumération des plantes du Canada. Provencheria 6. Nat. Can. (Que.) 93: 253-274; 371-437; 583-646; 989-1063. 94: 131-157; 471-528; 625-655.

Image or illustration

Ricinus communis:

Images: images.google.com

Notes on Poisonous plant parts:

The ricin content is highest in the seeds, although a small fraction of the toxin is contained in the leaves. Swallowing a seed without chewing prevents the release of the toxin because of the hard seed coat. However, chewing the seed allows release of the water-soluble chemical, and poisoning can occur (Cooper and Johnson 1984).

Toxic parts:

seeds

References:

Cooper, M. R., Johnson, A. W. 1984. Poisonous plants in Britain and their effects on animals and man. Her Majesty's Stationery Office, London, England. 305 pp.

Hoy, D. L., Catling, P. M. 1981. Necklaces from nature - seed jewelry. *Davidsonia*, 12: 63-77.

Notes on Toxic plant chemicals:

Ricin, a simple protein (a toxalbumin), is one of the most potent naturally occurring substances. Ricin is soluble in water and is therefore not present in extracted oil. Another protein, called ricinus agglutinin (or ricin), causes hemagglutinating activity, coagulation of the red blood cells. Toxicity from this protein disappears after heat treatment, usually as steam. After the oil is extracted, the remaining pomace is used in some countries as animal feed, if properly treated with heat and water. There is wide variation in sensitivity to the toxin in different species. A lethal dose by injection may be as small as two-millionths of body weight.

Experimental oral lethal doses are as follows:

horses	0.1 g/ kg
cattle, foals, rabbits, sheep, swine	1-2 g/kg
goats	5.5 g/kg

Because ricin is a protein, antibodies can be produced by

immunization, which allows animals to withstand up to 800 times a normal lethal dose. Ricin has been used by secret intelligence services as an assassination weapon. In one case, the Bulgarian secret police used a 1.53 mm metal pellet containing a reservoir for a few hundred millionths of a gram of ricin to kill a Bulgarian broadcaster. The pellet was injected by use of an umbrella, and the man died within 4 days (Cooper and Johnson 1984, Griffiths et al. 1987).

Toxic plant chemicals:

ricin

References:

Cooper, M. R., Johnson, A. W. 1984. Poisonous plants in Britain and their effects on animals and man. Her Majesty's Stationery Office, London, England. 305 pp.

Griffiths, G., Leith, A., Green, M. 1987. Proteins that play Jekyll and Hyde. *New Sci.*, 115: 59-61.

Stirpe, F., Barbieri, L. 1986. Ribosome-inactivating proteins up to date. *FEBS (Fed. Eur. Biochem. Soc.) Lett.*, 195: 1-8.

Animals/Human Poisoning:

Note: When an animal is listed without additional information, the literature (as of 1993) contained no detailed explanation.

Cattle

General symptoms of poisoning:

[abortion](#)

[breathing, shallow](#)

[death](#)

[diarrhea](#)

[weakness](#)

Notes on poisoning:

Cattle have been poisoned overseas after ingesting improperly treated castor bean products such as cattle cakes. Symptoms include severe diarrhea with blood and mucous in the feces, abortions, a drastic reduction in milk yield, and death of newborn calves. Weakness, feeble pulse, shortness of breath, and swollen joints have also occurred. Temperature was subnormal, with the pulse fast and weak. The lethal dose was estimated at 250 g of husks. Postmortem findings showed hemorrhaging in the heart,

degeneration of the kidneys and liver, and intense inflammation and erosion of the intestinal membranes. Symptoms are similar for other types of animals (Cooper and Johnson 1984).

References:

Cooper, M. R., Johnson, A. W. 1984. Poisonous plants in Britain and their effects on animals and man. Her Majesty's Stationery Office, London, England. 305 pp.

Chickens

General symptoms of poisoning:

[death](#)

References:

Cooper, M. R., Johnson, A. W. 1984. Poisonous plants in Britain and their effects on animals and man. Her Majesty's Stationery Office, London, England. 305 pp.

Horses

General symptoms of poisoning:

[abdominal pains](#)

[sweating](#)

[temperature, elevated](#)

Notes on poisoning:

The accidental addition of castor beans into grain given to horses caused sweating, a rocking gait, rapid pulse, muscle spasms, elevated temperature, and abdominal pains. The early symptoms may be confused with respiratory infection (Cooper and Johnson 1984).

References:

Cooper, M. R., Johnson, A. W. 1984. Poisonous plants in Britain and their effects on animals and man. Her Majesty's Stationery Office, London, England. 305 pp.

Humans

General symptoms of poisoning:

[abdominal pains](#)

[death](#)

[diarrhea](#)

[fever](#)

[nausea](#)

[vomiting](#)

Notes on poisoning:

Two to four chewed seeds may be enough to cause death in children. Symptoms of poisoning include abdominal pains, diarrhea, vomiting, nausea, drowsiness, dehydration, incoordination, and hematuria. In cases of acute toxicity, symptoms appear after several hours to a few days, although they can occur quickly. Griffiths et al. (1987) found that ricin causes apoptotic changes: cytoplasmic shrinkage, nuclear condensation, and breakdown of cells into membrane-bound fragments. Large-scale disruption in lymphoid tissues occurs. Death has been accidental or purposeful (Malizia et al. 1977, Griffiths et al. 1987). Castor bean contains an unknown potent respiratory allergen. Repeated exposure increases sensitivity (Cooper and Johnson 1984).

References:

Cooper, M. R., Johnson, A. W. 1984. Poisonous plants in Britain and their effects on animals and man. Her Majesty's Stationery Office, London, England. 305 pp.

Griffiths, G. D., Leek, M. D., Gee, D. J. 1987. The toxic plant proteins ricin and abrin induce apoptotic changes in mammalian lymphoid tissues and intestine. *J. Pathol.*, 151: 221-229.

Griffiths, G., Leith, A., Green, M. 1987. Proteins that play Jekyll and Hyde. *New Sci.*, 115: 59-61.

Hoy, D. L., Catling, P. M. 1981. Necklaces from nature - seed jewelry. *Davidsonia*, 12: 63-77.

Malizia, E., Sarcinelli, L., Andreucci, G. 1977. Ricinus poisoning: a familiar epidemy. *Acta Pharm. Toxicol.*, 41: 351-361.

Poultry

General symptoms of poisoning:

[diarrhea](#)

[feathers, ruffled](#)

Notes on poisoning:

In one case of accidental poisoning, poultry deteriorated rapidly, showing ruffled feathers, drooping wings, and grayish combs and wattles. Their crops were impacted for days, egg laying ceased,

and molting started. Several birds died (Cooper and Johnson 1984).

References:

Cooper, M. R., Johnson, A. W. 1984. Poisonous plants in Britain and their effects on animals and man. Her Majesty's Stationery Office, London, England. 305 pp.

Sheep

Swine

General symptoms of poisoning:

[convulsions](#)

[death](#)

[incoordination](#)

[vomiting](#)

[weakness](#)

References:

Cooper, M. R., Johnson, A. W. 1984. Poisonous plants in Britain and their effects on animals and man. Her Majesty's Stationery Office, London, England. 305 pp.

[Another search?](#)

[Français](#) | [Contact Us](#) | [Help](#) | [Search](#) | [Canada site](#)

[Coming Events](#) | [About CBIF](#) | [Links](#) | [Reports and Publications](#) |

[Home](#)

Date modified: 2003-02-06

[Important Notices](#)



Français	Contact us	Help	Search	Canada site
Coming events	About CBIF	Links	Reports and publications	Home

Canadian Biodiversity Information Facility



Notes on poisoning: *Robinia pseudoacacia*

[Introduction](#)[Interactive](#)[All poisonous plants by Botanical name](#)[All poisonous plants by Common name](#)[Important WWW Poisonous Plants sites](#)

General poisoning notes:

Black locust (*Robinia pseudoacacia*) is a naturalized shrub or tree that is planted as an ornamental in warmer parts of Canada. The seeds, bark, and leaves contain toxic proteins that have caused sickness and death in cattle, horses, poultry, sheep, and humans. The plant should be considered toxic to all animals if ingested. Children were poisoned (with rare reports of fatalities) after chewing on plant material, especially the bark. This tree can be found around older farms and houses and is also planted along fencerows. Children should be taught not to ingest any parts of the plant. If older trees are cut down in areas where livestock have access, make sure that the animals do not ingest any sprout (sucker) growth that may emerge from the stump (Hansen 1924, Kingsbury 1964, Cooper and Johnson 1984).

References:

Cooper, M. R., Johnson, A. W. 1984. Poisonous plants in Britain and their effects on animals and man. Her Majesty's Stationery Office, London, England. 305 pp.

Hansen, A. A. 1924. Robinin - a potent plant poison. Better Crops, 22(2): 22-23, 44.

Kingsbury, J. M. 1964. Poisonous plants of the United States and Canada. Prentice-Hall Inc., Englewood Cliffs, N.J., USA. 626 pp.

Nomenclature:

Scientific Name: *Robinia pseudoacacia* L.

Vernacular name(s): black locust

Scientific family name: *Leguminosae*

Vernacular family name: pea

Go to ITIS*^{ca} for more taxonomic information on: [Robinia pseudoacacia](#)

References:

Agriculture Quebec. 1975. Noms des maladies des plantes du Canada/ Names of plant diseases in Canada. , Quebec City, Que., Canada. 288 pp.

Alex, J. F., Cayouette, R., Mulligan, G. A. 1980. Common and botanical names of weeds in Canada/Noms populaire et scientifiques des plantes nuisibles du Canada. Revised. Agric. Can. Publ., Ottawa, Ont., Canada. 132 pp.

Bailey, L. H., Bailey, E. Z. 1976. Hortus third. Revised. MacMillan, New York, N.Y., USA. 1290 pp.

Scoggan, H. J. 1978, 1979. The flora of Canada. Nat. Mus. Nat. Sci. (Ottawa) Publ. Bot. 7(1)-7(4). 1711 pp.

Van Wijk, H. L. 1911. A dictionary of plant names. Martinus Nijhoff, The Hague, The Netherlands. 1444 pp.

Victorin, M. 1964. Flore Laurentienne. 2nd ed. Univ. Montreal, Montreal, Que., Canada. 952 pp.

Geographic Information

British Columbia
Nova Scotia
Ontario
Prince Edward Island
Quebec

References:

Bailey, L. H., Bailey, E. Z. 1976. Hortus third. Revised. MacMillan, New York, N.Y., USA. 1290 pp.

Boivin, B. 1966, 1967. Énumération des plantes du Canada. Provencheria 6. Nat. Can. (Que.) 93: 253-274; 371-437; 583-646; 989-1063. 94: 131-157; 471-528; 625-655.

Image or illustration

Robinia pseudoacacia:

Images: images.google.com

Toxic parts:

bark
leaves
seeds

References:

Cooper, M. R., Johnson, A. W. 1984. Poisonous plants in Britain and their effects on animals and man. Her Majesty's Stationery Office, London, England. 305 pp.

Notes on Toxic plant chemicals:

Robin (or robinin) and phasin, which are toxic proteins called toxalbumins, are present in black locust. A glycoprotein that agglutinates red blood cells has been extracted from the plant. It is not clear if this is robin or another substance. Experimental feeding to horses has shown the following toxicities:

=> aqueous extract of bark about 0.1% of body weight caused symptoms

=> powdered bark about 0.04% of body weight caused symptoms

The poisonous principle appears to be about one-tenth as toxic to cattle (Kingsbury 1964, Cooper and Johnson 1984).

Toxic plant chemicals:

phasin
robin(in)

References:

Cooper, M. R., Johnson, A. W. 1984. Poisonous plants in Britain and their effects on animals and man. Her Majesty's Stationery Office, London, England. 305 pp.

Kingsbury, J. M. 1964. Poisonous plants of the United States and Canada. Prentice-Hall Inc., Englewood Cliffs, N.J., USA. 626 pp.

Animals/Human Poisoning:

Note: When an animal is listed without additional information, the literature (as of 1993) contained no detailed explanation.

Cattle

General symptoms of poisoning:

[anorexia](#)

[death](#)

[dyspnea](#)

[nausea](#)

[paralysis, posterior](#)

[weakness](#)

Notes on poisoning:

Cattle that ingested the sprouts and leaves of black locust were poisoned. Experiments show that cattle are 10 times less sensitive to the toxin than horses. Symptoms include anorexia, weakness, posterior paralysis, nausea, coldness of the extremities, and dilation of the pupils. Death occurs in severe cases (Hansen 1924, Kingsbury 1964).

References:

Kingsbury, J. M. 1964. Poisonous plants of the United States and Canada. Prentice-Hall Inc., Englewood Cliffs, N.J., USA. 626 pp.

Horses

General symptoms of poisoning:

[anorexia](#)

[death](#)

[nausea](#)

[paralysis, posterior](#)

[pupil dilation](#)

[weakness](#)

Notes on poisoning:

Horses that ingested black locust leaves, sprouts, and bark were poisoned and died. Symptoms are similar to those of cattle and include anorexia, weakness, posterior paralysis, nausea, coldness of the extremities, and pupil dilation. Symptoms of colic also occur. In severe cases, death occurs. Postmortem findings showed mucous inflammation of the gastrointestinal tract and occasional severe gastroenteritis. In some cases a yellowish pigmentation of the membranes occurred (Hansen 1924, Kingsbury 1964).

References:

Kingsbury, J. M. 1964. Poisonous plants of the United States and Canada. Prentice-Hall Inc., Englewood Cliffs, N.J., USA. 626 pp.

Humans

General symptoms of poisoning:

[death](#)

[nausea](#)

[pupil dilation](#)

[vomiting](#)

Notes on poisoning:

Humans, usually children, were poisoned after ingesting the bark of black locust. Symptoms include pupil dilation, feeble pulse, severe vomiting, and a death-like palor. The extremities may become cold. Intestinal inflammation, hemorrhaging of the lymphatic tissues, and possible liver damage often occur. Fatalities are rare. The chances of poisoning are rare. Children should not be allowed to ingest plant material from this tree (Hansen 1924, Kingsbury 1964).

References:

Hansen, A. A. 1924. Robitin - a potent plant poison. *Better Crops*, 22(2): 22-23, 44.

Kingsbury, J. M. 1964. *Poisonous plants of the United States and Canada*. Prentice-Hall Inc., Englewood Cliffs, N.J., USA. 626 pp.

Poultry

General symptoms of poisoning:

[liver, congestion of](#)

Notes on poisoning:

Chickens were poisoned after ingesting leaf material. Degenerative changes in the liver and kidney occurred. A toxic phytohemagglutinin extracted from the plant caused fatty degeneration of the liver and death in chick embryos, at doses of 0.25-2.0 mg per egg (Kingsbury 1964, Cooper and Johnson 1984).

References:

Cooper, M. R., Johnson, A. W. 1984. *Poisonous plants in Britain and their effects on animals and man*. Her Majesty's Stationery Office, London, England. 305 pp.

Kingsbury, J. M. 1964. *Poisonous plants of the United States and Canada*. Prentice-Hall Inc., Englewood Cliffs, N.J., USA. 626 pp.

Sheep

General symptoms of poisoning:

[anorexia](#)

Notes on poisoning:

Ingesting the seed pods has caused minor illness in sheep (Kingsbury 1964).

References:

Kingsbury, J. M. 1964. Poisonous plants of the United States and Canada. Prentice-Hall Inc., Englewood Cliffs, N.J., USA. 626 pp.

[Another search?](#)

[Français](#) | [Contact Us](#) | [Help](#) | [Search](#) | [Canada site](#)

[Coming Events](#) | [About CBIF](#) | [Links](#) | [Reports and Publications](#) | [Home](#)

Date modified: 2003-02-06

[Important Notices](#)



Français	Contact us	Help	Search	Canada site
Coming events	About CBIF	Links	Reports and publications	Home

Canadian Biodiversity Information Facility



Notes on poisoning: *Rudbeckia laciniata*

[Introduction](#)[Interactive](#)[All poisonous plants by Botanical name](#)[All poisonous plants by Common name](#)[Important WWW Poisonous Plants sites](#)

General poisoning notes:

Cut-leaved coneflower (*Rudbeckia laciniata*) is native to some parts of Canada and is naturalized in others. A double-flowered form is also used as an ornamental in flower beds and is usually called golden glow. Early circumstantial evidence of poisoning of horses, sheep, and swine can be found. Experiments on sheep and swine have shown that some symptoms of toxicity can occur, although animals generally refuse to eat the unpalatable plants. Animal poisoning by this plant should be considered unlikely (Kingsbury 1964).

References:

Kingsbury, J. M. 1964. Poisonous plants of the United States and Canada. Prentice-Hall Inc., Englewood Cliffs, N.J., USA. 626 pp.

Skidmore, L. V., Peterson, N. F. 1932. Observations on the toxicity of golden glow (*Rudbeckia laciniata*) to swine and other animals. J. Am. Vet. Med. Assoc., 34: 655-662.

Nomenclature:

Scientific Name: *Rudbeckia laciniata* L.

Vernacular name(s): cut-leaved coneflower

Scientific family name: *Compositae*

Vernacular family name: composite

Go to ITIS^{*ca} for more taxonomic information on: [Rudbeckia laciniata](#)

References:

Agriculture Quebec. 1975. Noms des maladies des plantes du

Canada/ Names of plant diseases in Canada. , Quebec City, Que., Canada. 288 pp.

Alex, J. F., Cayouette, R., Mulligan, G. A. 1980. Common and botanical names of weeds in Canada/Noms populaire et scientifiques des plantes nuisibles du Canada. Revised. Agric. Can. Publ., Ottawa, Ont., Canada. 132 pp.

Bailey, L. H., Bailey, E. Z. 1976. Hortus third. Revised. MacMillan, New York, N.Y., USA. 1290 pp.

Scoggan, H. J. 1978, 1979. The flora of Canada. Nat. Mus. Nat. Sci. (Ottawa) Publ. Bot. 7(1)-7(4). 1711 pp.

Van Wijk, H. L. 1911. A dictionary of plant names. Martinus Nijhoff, The Hague, The Netherlands. 1444 pp.

Victorin, M. 1964. Flore Laurentienne. 2nd ed. Univ. Montreal, Montreal, Que., Canada. 952 pp.

Geographic Information

Alberta
British Columbia
Manitoba
New Brunswick
Nova Scotia
Ontario
Prince Edward Island
Quebec
Saskatchewan

References:

Bailey, L. H., Bailey, E. Z. 1976. Hortus third. Revised. MacMillan, New York, N.Y., USA. 1290 pp.

Boivin, B. 1966, 1967. Énumération des plantes du Canada. Provencheria 6. Nat. Can. (Que.) 93: 253-274; 371-437; 583-646; 989-1063. 94: 131-157; 471-528; 625-655.

Image or illustration

Rudbeckia laciniata:

Images: images.google.com

Notes on Poisonous plant parts:

Ingesting the aboveground portion of this plant produced symptoms in some animals (Kingsbury 1964).

Toxic parts:

flowers
leaves
stems

References:

Kingsbury, J. M. 1964. Poisonous plants of the United States and Canada. Prentice-Hall Inc., Englewood Cliffs, N.J., USA. 626 pp.

Toxic plant chemicals:

unknown chemical

References:

Kingsbury, J. M. 1964. Poisonous plants of the United States and Canada. Prentice-Hall Inc., Englewood Cliffs, N.J., USA. 626 pp.

Animals/Human Poisoning:

Note: When an animal is listed without additional information, the literature (as of 1993) contained no detailed explanation.

Horses

Sheep

General symptoms of poisoning:

[anorexia](#)

[depression](#)

[incoordination](#)

Notes on poisoning:

Experiments on sheep showed that animals ate the distasteful plant after a period of starvation. Ingesting plant material equal to 3-4% of body weight produced symptoms after 24 h. The primary symptoms were incoordination and listlessness. Respiratory rates increased. Animals returned to normal within 36 h (Kingsbury 1964).

References:

Kingsbury, J. M. 1964. Poisonous plants of the United States and Canada. Prentice-Hall Inc., Englewood Cliffs, N.J., USA. 626 pp.

Skidmore, L. V., Peterson, N. F. 1932. Observations on the toxicity of golden glow (*Rudbeckia laciniata*) to swine and other animals. J. Am. Vet. Med. Assoc., 34: 655-662.

Swine

General symptoms of poisoning:

[abdominal pains](#)

[anorexia](#)

[depression](#)

[incoordination](#)

Notes on poisoning:

In experiments, swine ate the distaste plant material after a period of starvation. The animals exhibited incoordination, dullness, some signs of abdominal pain, and aimless wandering. The symptoms disappeared within 36 h. Symptoms appeared after ingesting plant material equal to 3-4% of body weight. Symptoms could not be reproduced a second time with further feedings (Kingsbury 1964).

References:

Kingsbury, J. M. 1964. Poisonous plants of the United States and Canada. Prentice-Hall Inc., Englewood Cliffs, N.J., USA. 626 pp.

Skidmore, L. V., Peterson, N. F. 1932. Observations on the toxicity of golden glow (*Rudbeckia laciniata*) to swine and other animals. J. Am. Vet. Med. Assoc., 34: 655-662.

[Another search?](#)

[Français](#) | [Contact Us](#) | [Help](#) | [Search](#) | [Canada site](#)

[Coming Events](#) | [About CBIF](#) | [Links](#) | [Reports and Publications](#) | [Home](#)

Date modified: 2003-02-06

[Important Notices](#)



Français	Contact us	Help	Search	Canada site
Coming events	About CBIF	Links	Reports and publications	Home

Canadian Biodiversity Information Facility



Notes on poisoning: *Rudbeckia serotina*

[Introduction](#)[Interactive](#)[All poisonous plants by Botanical name](#)[All poisonous plants by Common name](#)[Important WWW Poisonous Plants sites](#)

General poisoning notes:

Black-eyed Susan (*Rudbeckia laciniata*) is a native herb that grows across southern Canada. This plant occurs in fields and is sometimes found in disturbed habitats. Ingesting plants caused poisoning in cattle and swine. Symptoms were mild. Poisoning from this plant is unlikely (Kingsbury 1964, Fleurbec 1983).

References:

Kingsbury, J. M. 1964. Poisonous plants of the United States and Canada. Prentice-Hall Inc., Englewood Cliffs, N.J., USA. 626 pp.

Nomenclature:

Scientific Name: *Rudbeckia serotina* Nutt.

Vernacular name(s): black-eyed Susan

Scientific family name: *Compositae*

Vernacular family name: composite

Go to ITIS^{*ca} for more taxonomic information on: [Rudbeckia serotina](#)

References:

Agriculture Quebec. 1975. Noms des maladies des plantes du Canada/ Names of plant diseases in Canada. , Quebec City, Que., Canada. 288 pp.

Alex, J. F., Cayouette, R., Mulligan, G. A. 1980. Common and botanical names of weeds in Canada/Noms populaire et scientifiques des plantes nuisibles du Canada. Revised. Agric. Can. Publ., Ottawa, Ont., Canada. 132 pp.

Bailey, L. H., Bailey, E. Z. 1976. Hortus third. Revised. MacMillan, New York, N.Y., USA. 1290 pp.

Scoggan, H. J. 1978, 1979. The flora of Canada. Nat. Mus. Nat. Sci. (Ottawa) Publ. Bot. 7(1)-7(4). 1711 pp.

Van Wijk, H. L. 1911. A dictionary of plant names. Martinus Nijhoff, The Hague, The Netherlands. 1444 pp.

Victorin, M. 1964. Flore Laurentienne. 2nd ed. Univ. Montreal, Montreal, Que., Canada. 952 pp.

Geographic Information

Alberta
British Columbia
Manitoba
New Brunswick
Newfoundland
Nova Scotia
Ontario
Prince Edward Island
Quebec
Saskatchewan

References:

Bailey, L. H., Bailey, E. Z. 1976. Hortus third. Revised. MacMillan, New York, N.Y., USA. 1290 pp.

Boivin, B. 1966, 1967. Énumération des plantes du Canada. Provencheria 6. Nat. Can. (Que.) 93: 253-274; 371-437; 583-646; 989-1063. 94: 131-157; 471-528; 625-655.

Image or illustration

Rudbeckia serotina:

Images: images.google.com

Notes on Poisonous plant parts:

Ingesting aboveground portions of the plants has caused poisoning in some animals (Kingsbury 1964).

Toxic parts:

flowers
hairs
leaves

stems

References:

Kingsbury, J. M. 1964. Poisonous plants of the United States and Canada. Prentice-Hall Inc., Englewood Cliffs, N.J., USA. 626 pp.

Toxic plant chemicals:

unknown chemical

References:

Kingsbury, J. M. 1964. Poisonous plants of the United States and Canada. Prentice-Hall Inc., Englewood Cliffs, N.J., USA. 626 pp.

Animals/Human Poisoning:

Note: When an animal is listed without additional information, the literature (as of 1993) contained no detailed explanation.

Cattle

General symptoms of poisoning:

[gastroenteritis](#)

References:

Kingsbury, J. M. 1964. Poisonous plants of the United States and Canada. Prentice-Hall Inc., Englewood Cliffs, N.J., USA. 626 pp.

Swine

General symptoms of poisoning:

[coma](#)

Notes on poisoning:

Swine that ingested black-eyed Susan suffered from coma and periods of aimless wandering (Kingsbury 1964).

References:

Kingsbury, J. M. 1964. Poisonous plants of the United States and Canada. Prentice-Hall Inc., Englewood Cliffs, N.J., USA. 626 pp.

[Another search?](#)

[Français](#) | [Contact Us](#) | [Help](#) | [Search](#) | [Canada site](#)
[Coming Events](#) | [About CBIF](#) | [Links](#) | [Reports and Publications](#) |
[Home](#)

Date modified: 2003-02-06

[Important Notices](#)



Français	Contact us	Help	Search	Canada site
Coming events	About CBIF	Links	Reports and publications	Home

Canadian Biodiversity Information Facility



Notes on poisoning: *Rumex acetosa*

[Introduction](#)[Interactive](#)[All poisonous plants by Botanical name](#)[All poisonous plants by Common name](#)[Important WWW Poisonous Plants sites](#)

General poisoning notes:

Garden-sorrel (*Rumex acetosa*) is a naturalized herb found across southern Canada. It is occasionally cultivated as a garden green.

Ingesting large quantities of the plant caused toxicity in sheep and cattle in other countries. Humans should restrict their intake of the leaves of this plant because they contain oxalate crystals (Cooper and Johnson 1984).

References:

Cooper, M. R., Johnson, A. W. 1984. Poisonous plants in Britain and their effects on animals and man. Her Majesty's Stationery Office, London, England. 305 pp.

Kingsbury, J. M. 1964. Poisonous plants of the United States and Canada. Prentice-Hall Inc., Englewood Cliffs, N.J., USA. 626 pp.

Nomenclature:

Scientific Name: *Rumex acetosa* L.

Vernacular name(s): garden-sorrel

Scientific family name: *Polygonaceae*

Vernacular family name: buckwheat

Go to ITIS^{*ca} for more taxonomic information on: [Rumex acetosa](#)

References:

Agriculture Quebec. 1975. Noms des maladies des plantes du Canada/ Names of plant diseases in Canada. , Quebec City, Que., Canada. 288 pp.

Alex, J. F., Cayouette, R., Mulligan, G. A. 1980. Common and botanical names of weeds in Canada/Noms populaire et scientifiques des plantes nuisibles du Canada. Revised. Agric. Can. Publ., Ottawa, Ont., Canada. 132 pp.

Bailey, L. H., Bailey, E. Z. 1976. Hortus third. Revised. MacMillan, New York, N.Y., USA. 1290 pp.

Scoggan, H. J. 1978, 1979. The flora of Canada. Nat. Mus. Nat. Sci. (Ottawa) Publ. Bot. 7(1)-7(4). 1711 pp.

Van Wijk, H. L. 1911. A dictionary of plant names. Martinus Nijhoff, The Hague, The Netherlands. 1444 pp.

Victorin, M. 1964. Flore Laurentienne. 2nd ed. Univ. Montreal, Montreal, Que., Canada. 952 pp.

Geographic Information

Alberta
British Columbia
Labrador
Manitoba
New Brunswick
Newfoundland
Nova Scotia
Ontario
Quebec
Saskatchewan

References:

Bailey, L. H., Bailey, E. Z. 1976. Hortus third. Revised. MacMillan, New York, N.Y., USA. 1290 pp.

Boivin, B. 1966, 1967. Énumération des plantes du Canada. Provencheria 6. Nat. Can. (Que.) 93: 253-274; 371-437; 583-646; 989-1063. 94: 131-157; 471-528; 625-655.

Image or illustration

Rumex acetosa:

Images: images.google.com

Notes on Poisonous plant parts:

Ingesting large amounts of the aboveground portion of garden-sorrel can cause poisoning (Cooper and Johnson 1984).

Toxic parts:

leaves
stems

References:

Cooper, M. R., Johnson, A. W. 1984. Poisonous plants in Britain and their effects on animals and man. Her Majesty's Stationery Office, London, England. 305 pp.

Notes on Toxic plant chemicals:

Oxalates are considered the primary toxin. However, under certain circumstances, nitrates may accumulate to toxic levels. In recorded cases of poisoning, the symptoms were consistent with those of oxalate poisoning (Cooper and Johnson 1984).

Toxic plant chemicals:

oxalate

References:

Cooper, M. R., Johnson, A. W. 1984. Poisonous plants in Britain and their effects on animals and man. Her Majesty's Stationery Office, London, England. 305 pp.

Animals/Human Poisoning:

Note: When an animal is listed without additional information, the literature (as of 1993) contained no detailed explanation.

Cattle

General symptoms of poisoning:

[kidney failure](#)

Notes on poisoning:

Reports of poisoning in cattle are inconsistent. Lactating cows that ingested large quantities of garden-sorrel showed symptoms similar to those of milk fever. Treatment with calcium had transient effects because of subsequent kidney failure (Cooper and Johnson 1984).

References:

Cooper, M. R., Johnson, A. W. 1984. Poisonous plants in Britain and their effects on animals and man. Her Majesty's Stationery Office, London, England. 305 pp.

Sheep

General symptoms of poisoning:

[coma](#)

[death](#)

[incoordination](#)

[mouth, frothing of](#)

[pupil dilation](#)

[recumbency](#)

Notes on poisoning:

Ingesting large amounts of garden-sorrel caused toxicity in sheep in Britain. Symptoms included incoordination, falling, then inability to rise, dilation of the pupils, coma, and death (in five sheep). In lactating ewes, the initial signs resembled milk fever, but favorable response to calcium injection was transient because of kidney failure. No cases of poisoning from this plant have been reported in North America (Kingsbury 1964, Cooper and Johnson 1984).

References:

Cooper, M. R., Johnson, A. W. 1984. Poisonous plants in Britain and their effects on animals and man. Her Majesty's Stationery Office, London, England. 305 pp.

Kingsbury, J. M. 1964. Poisonous plants of the United States and Canada. Prentice-Hall Inc., Englewood Cliffs, N.J., USA. 626 pp.

[Another search?](#)

[Français](#) | [Contact Us](#) | [Help](#) | [Search](#) | [Canada site](#)

[Coming Events](#) | [About CBIF](#) | [Links](#) | [Reports and Publications](#) |

[Home](#)

Date modified: 2003-02-06

[Important Notices](#)



Français	Contact us	Help	Search	Canada site
Coming events	About CBIF	Links	Reports and publications	Home

Canadian Biodiversity Information Facility



Notes on poisoning: *Rumex acetosella*

[Introduction](#)[Interactive](#)[All poisonous plants by Botanical name](#)[All poisonous plants by Common name](#)[Important WWW Poisonous Plants sites](#)

General poisoning notes:

Sheep sorrel (*Rumex acetosella*) is a naturalized herb found across Canada. The plant can become abundant in poor disturbed soils. Ingesting large quantities of the plants caused poisoning and death in sheep in other countries (Cooper and Johnson 1984).



References:

Cooper, M. R., Johnson, A. W. 1984. Poisonous plants in Britain and their effects on animals and man. Her Majesty's Stationery Office, London, England. 305 pp.

Nomenclature:

Scientific Name: *Rumex acetosella* L.

Vernacular name(s): sheep sorrel

Scientific family name: *Polygonaceae*

Vernacular family name: buckwheat

Go to ITIS*^{ca} for more taxonomic information on: [Rumex acetosella](#)

References:

Agriculture Quebec. 1975. Noms des maladies des plantes du Canada/ Names of plant diseases in Canada. , Quebec City, Que., Canada. 288 pp.

Alex, J. F., Cayouette, R., Mulligan, G. A. 1980. Common and botanical names of weeds in Canada/Noms populaire et scientifiques des plantes nuisibles du Canada. Revised. Agric. Can. Publ., Ottawa, Ont., Canada. 132 pp.

Bailey, L. H., Bailey, E. Z. 1976. Hortus third. Revised. MacMillan, New York, N.Y., USA. 1290 pp.

Scoggan, H. J. 1978, 1979. The flora of Canada. Nat. Mus. Nat. Sci. (Ottawa) Publ. Bot. 7(1)-7(4). 1711 pp.

Van Wijk, H. L. 1911. A dictionary of plant names. Martinus Nijhoff, The Hague, The Netherlands. 1444 pp.

Victorin, M. 1964. Flore Laurentienne. 2nd ed. Univ. Montreal, Montreal, Que., Canada. 952 pp.

Geographic Information

Alberta
British Columbia
Labrador
Manitoba
New Brunswick
Nova Scotia
Ontario
Prince Edward Island
Quebec
Saskatchewan
Yukon Territory

References:

Bailey, L. H., Bailey, E. Z. 1976. Hortus third. Revised. MacMillan, New York, N.Y., USA. 1290 pp.

Boivin, B. 1966, 1967. Énumération des plantes du Canada. Provencheria 6. Nat. Can. (Que.) 93: 253-274; 371-437; 583-646; 989-1063. 94: 131-157; 471-528; 625-655.

Image or illustration

Rumex acetosella:

Images: images.google.com

Toxic parts:

leaves
stems

References:

Cooper, M. R., Johnson, A. W. 1984. Poisonous plants in Britain and their effects on animals and man. Her Majesty's Stationery Office, London, England. 305 pp.

Notes on Toxic plant chemicals:

Oxalate crystals are found in sheep sorrel. Under certain circumstances, nitrates can accumulate in sufficient quantity to cause poisoning. If large enough quantities of oxalates are absorbed by ruminants, they combine with blood calcium, forming calcium oxalate and causing calcium deficiency. The crystal can accumulate in the kidneys and brain causing renal failure and nervous disorders (Cooper and Johnson 1984).

Toxic plant chemicals:

oxalate

References:

Cooper, M. R., Johnson, A. W. 1984. Poisonous plants in Britain and their effects on animals and man. Her Majesty's Stationery Office, London, England. 305 pp.

Animals/Human Poisoning:

Note: When an animal is listed without additional information, the literature (as of 1993) contained no detailed explanation.

Sheep

General symptoms of poisoning:

[coma](#)

[death](#)

[falling down](#)

[gait, staggering](#)

[muscle spasms](#)

[nasal discharge](#)

Notes on poisoning:

Several sheep in New Zealand were poisoned and died. Symptoms included staggering, nasal discharge, muscular spasms, abnormal breathing, and falling down. In severe cases, coma preceded death. Postmortem findings revealed oxalate crystals and inflammation of the kidneys. Up to 10% of flocks died (Cooper and Johnson 1984).

References:

Cooper, M. R., Johnson, A. W. 1984. Poisonous plants in Britain

and their effects on animals and man. Her Majesty's Stationery Office, London, England. 305 pp.

[Another search?](#)

[Français](#) | [Contact Us](#) | [Help](#) | [Search](#) | [Canada site](#)

[Coming Events](#) | [About CBIF](#) | [Links](#) | [Reports and Publications](#) |

[Home](#)

Date modified: 2003-02-06

[Important Notices](#)



Français	Contact us	Help	Search	Canada site
Coming events	About CBIF	Links	Reports and publications	Home

Canadian Biodiversity Information Facility



Notes on poisoning: *Rumex venosus*

[Introduction](#)[Interactive](#)[All poisonous plants by Botanical name](#)[All poisonous plants by Common name](#)[Important WWW Poisonous Plants sites](#)

General poisoning notes:

Veined dock (*Rumex venosus*) is a native herb found in the southern part of the Canadian prairies. This plant caused poisoning of cattle in Colorado. Poisoning occurred in early spring when there was little other vegetation. Sickness and death resulted after large amounts of the plants were ingested (Dickie et al. 1978).



References:

Dickie, C. W., Hamann, M. H., Carroll, W. D., Chow, F. 1978. Oxalate (*Rumex venosus*) poisoning in cattle. J. Am. Vet. Med. Assoc., 173: 73-74.

Nomenclature:

Scientific Name: *Rumex venosus* Pursh

Vernacular name(s): veined dock

Scientific family name: *Polygonaceae*

Vernacular family name: buckwheat

Go to ITIS*^{ca} for more taxonomic information on: [Rumex venosus](#)

References:

Agriculture Quebec. 1975. Noms des maladies des plantes du Canada/ Names of plant diseases in Canada. , Quebec City, Que., Canada. 288 pp.

Alex, J. F., Cayouette, R., Mulligan, G. A. 1980. Common and botanical names of weeds in Canada/Noms populaire et scientifiques des plantes nuisibles du Canada. Revised. Agric.

Can. Publ., Ottawa, Ont., Canada. 132 pp.

Bailey, L. H., Bailey, E. Z. 1976. Hortus third. Revised. MacMillan, New York, N.Y., USA. 1290 pp.

Scoggan, H. J. 1978, 1979. The flora of Canada. Nat. Mus. Nat. Sci. (Ottawa) Publ. Bot. 7(1)-7(4). 1711 pp.

Van Wijk, H. L. 1911. A dictionary of plant names. Martinus Nijhoff, The Hague, The Netherlands. 1444 pp.

Victorin, M. 1964. Flore Laurentienne. 2nd ed. Univ. Montreal, Montreal, Que., Canada. 952 pp.

Geographic Information

Alberta

Manitoba

Saskatchewan

References:

Bailey, L. H., Bailey, E. Z. 1976. Hortus third. Revised. MacMillan, New York, N.Y., USA. 1290 pp.

Boivin, B. 1966, 1967. Énumération des plantes du Canada. Provencheria 6. Nat. Can. (Que.) 93: 253-274; 371-437; 583-646; 989-1063. 94: 131-157; 471-528; 625-655.

Image or illustration

Rumex venosus:

Images: images.google.com

Toxic parts:

leaves

stems

References:

Dickie, C. W., Hamann, M. H., Carroll, W. D., Chow, F. 1978. Oxalate (*Rumex venosus*) poisoning in cattle. J. Am. Vet. Med. Assoc., 173: 73-74.

Notes on Toxic plant chemicals:

Oxalate crystals are found in the aboveground parts of the plant. Levels were measured in Colorado, showing oxalates of 9.2% in April and 13.9% in June on a dry-weight basis. If sufficient

quantity of plant material is ingested the oxalates combine with systemic calcium ions to form insoluble calcium oxalate, causing functional hypocalcemia in acute cases (Dickie et al. 1978).

Toxic plant chemicals:

oxalate

References:

Dickie, C. W., Hamann, M. H., Carroll, W. D., Chow, F. 1978. Oxalate (*Rumex venosus*) poisoning in cattle. J. Am. Vet. Med. Assoc., 173: 73-74.

Animals/Human Poisoning:

Note: When an animal is listed without additional information, the literature (as of 1993) contained no detailed explanation.

Cattle

General symptoms of poisoning:

[anorexia](#)

[depression](#)

[kidney, edema of](#)

[lungs, congestion of](#)

Notes on poisoning:

Several cows became ill and died after ingesting veined dock. All the cows were suckling, but none of their calves died. Symptoms included depression and anorexia. Postmortem findings showed ecchymotic and petechial hemorrhaging on the visceral and parietal peritoneum. About 2 L of thin, yellowish fluid was in the abdominal cavity. Mesenteric lymph nodes were enlarged and edematous. Other symptoms included catarrhal abomasitis, enteritis, pale kidneys, and lung congestion (Dickie et al. 1978).

References:

Dickie, C. W., Hamann, M. H., Carroll, W. D., Chow, F. 1978. Oxalate (*Rumex venosus*) poisoning in cattle. J. Am. Vet. Med. Assoc., 173: 73-74.

[Another search?](#)

[Français](#) | [Contact Us](#) | [Help](#) | [Search](#) | [Canada site](#)

[Coming Events](#) | [About CBIF](#) | [Links](#) | [Reports and Publications](#) | [Home](#)

Date modified: 2003-02-06

[Important Notices](#)



Français	Contact us	Help	Search	Canada site
Coming events	About CBIF	Links	Reports and publications	Home

Canadian Biodiversity Information Facility



Notes on poisoning: *Sambucus canadensis*

[Introduction](#)

[Interactive](#)

[All poisonous plants by Botanical name](#)

[All poisonous plants by Common name](#)

[Important WWW Poisonous Plants sites](#)



General poisoning notes:

American elder (*Sambucus canadensis*) is a native shrub found in the moist soils of swamps and along rivers and lakes in eastern Canada. This plant contains cyanogenic glycosides and a cathartic chemical. The plant has poisoned cattle and perhaps sheep. Children were poisoned after using the hollow stems for whistles. Ingesting uncooked berries may cause nausea (Kingsbury 1964, Muenscher 1978). Red-berried elder (*Sambucus pubens*) is a native shrub found from Newfoundland to Manitoba. There are unsubstantiated reports that this species may also have toxic potential. Children should not be allowed to chew the stems or berries.

References:

- Kingsbury, J. M. 1964. Poisonous plants of the United States and Canada. Prentice-Hall Inc., Englewood Cliffs, N.J., USA. 626 pp.
- Muenscher, W. C. 1975. Poisonous plants of the United States. Revised. Collier Books, New York, N.Y., USA. 277 pp.

Nomenclature:

Scientific Name: *Sambucus canadensis* L.

Vernacular name(s): American elder

Scientific family name: *Caprifoliaceae*

Vernacular family name: honeysuckle

Go to ITIS*^{ca} for more taxonomic information on: [Sambucus canadensis](#)

References:

Agriculture Quebec. 1975. Noms des maladies des plantes du Canada/ Names of plant diseases in Canada. , Quebec City, Que., Canada. 288 pp.

Alex, J. F., Cayouette, R., Mulligan, G. A. 1980. Common and botanical names of weeds in Canada/Noms populaire et scientifiques des plantes nuisibles du Canada. Revised. Agric. Can. Publ., Ottawa, Ont., Canada. 132 pp.

Bailey, L. H., Bailey, E. Z. 1976. Hortus third. Revised. MacMillan, New York, N.Y., USA. 1290 pp.

Scoggan, H. J. 1978, 1979. The flora of Canada. Nat. Mus. Nat. Sci. (Ottawa) Publ. Bot. 7(1)-7(4). 1711 pp.

Van Wijk, H. L. 1911. A dictionary of plant names. Martinus Nijhoff, The Hague, The Netherlands. 1444 pp.

Victorin, M. 1964. Flore Laurentienne. 2nd ed. Univ. Montreal, Montreal, Que., Canada. 952 pp.

Geographic Information

New Brunswick
Nova Scotia
Ontario
Prince Edward Island
Quebec

References:

Bailey, L. H., Bailey, E. Z. 1976. Hortus third. Revised. MacMillan, New York, N.Y., USA. 1290 pp.

Boivin, B. 1966, 1967. Énumération des plantes du Canada. Provencheria 6. Nat. Can. (Que.) 93: 253-274; 371-437; 583-646; 989-1063. 94: 131-157; 471-528; 625-655.

Image or illustration

Sambucus canadensis:

Images: images.google.com

Notes on Poisonous plant parts:

Animals were poisoned after ingesting young shoots and leaves. Children were also poisoned when they used the hollow stems as whistles. Uncooked berries may cause nausea (Muenscher 1975).

Toxic parts:

leaves
pollen
young shoots

References:

Muenschler, W. C. 1975. Poisonous plants of the United States. Revised. Collier Books, New York, N.Y., USA. 277 pp.

Notes on Toxic plant chemicals:

Cyanogenic glycosides are found in elders. Sambunigrin and other chemicals may be involved. Cathartics may also be present (Kingsbury 1964, Tewe and Iyayi 1989).

Toxic plant chemicals:

sambunigrin

References:

Kingsbury, J. M. 1964. Poisonous plants of the United States and Canada. Prentice-Hall Inc., Englewood Cliffs, N.J., USA. 626 pp.

Tewe, O. O., Iyayi, E. A. 1989. Cyanogenic glycosides. Pages 43-60 in Cheeke, P. R., ed. Toxicants of plant origin. Vol. II. Glycosides. CRC Press, Inc., Boca Raton, Fla., USA. 277 pp.

Animals/Human Poisoning:

Note: When an animal is listed without additional information, the literature (as of 1993) contained no detailed explanation.

Cattle

General symptoms of poisoning:

[abdominal pains](#)

References:

Muenschler, W. C. 1975. Poisonous plants of the United States. Revised. Collier Books, New York, N.Y., USA. 277 pp.

Humans

General symptoms of poisoning:

[nausea](#)

[vomiting](#)

Notes on poisoning:

Apparently, the use of the hollow stems as whistles or blowpipes has caused poisoning in children. The bark contains a cathartic. Ingesting uncooked berries can cause nausea and vomiting. Cooked are not harmful if eaten in small amounts (Kingsbury 1964).

References:

Kingsbury, J. M. 1964. Poisonous plants of the United States and Canada. Prentice-Hall Inc., Englewood Cliffs, N.J., USA. 626 pp.

Muenschler, W. C. 1975. Poisonous plants of the United States. Revised. Collier Books, New York, N.Y., USA. 277 pp.

[Another search?](#)

[Français](#) | [Contact Us](#) | [Help](#) | [Search](#) | [Canada site](#)

[Coming Events](#) | [About CBIF](#) | [Links](#) | [Reports and Publications](#) | [Home](#)

Date modified: 2003-02-06

[Important Notices](#)



Français	Contact us	Help	Search	Canada site
Coming events	About CBIF	Links	Reports and publications	Home

Canadian Biodiversity Information Facility



Notes on poisoning: *Sambucus nigra*

[Introduction](#)[Interactive](#)[All poisonous plants by Botanical name](#)[All poisonous plants by Common name](#)[Important WWW Poisonous Plants sites](#)

General poisoning notes:

European elder (*Sambucus nigra*) is an outdoor ornamental introduced from Europe. Several cultivars may be available in Canada. This shrub contains cyanogenic glycosides. Swine have been poisoned in Europe, and circumstantial reports of poisoning of cattle and turkeys have been noted. Berries eaten raw can cause nausea and vomiting in humans (Cooper and Johnson 1984). Children should not be allowed to ingest the berries.

References:

Cooper, M. R., Johnson, A. W. 1984. Poisonous plants in Britain and their effects on animals and man. Her Majesty's Stationery Office, London, England. 305 pp.

Nomenclature:

Scientific Name: *Sambucus nigra* L.

Vernacular name(s): European elder

Scientific family name: *Caprifoliaceae*

Vernacular family name: honeysuckle

Go to ITIS^{*ca} for more taxonomic information on: [Sambucus nigra](#)

References:

Agriculture Quebec. 1975. Noms des maladies des plantes du Canada/ Names of plant diseases in Canada. , Quebec City, Que., Canada. 288 pp.

Alex, J. F., Cayouette, R., Mulligan, G. A. 1980. Common and botanical names of weeds in Canada/Noms populaire et

scientifiques des plantes nuisibles du Canada. Revised. Agric. Can. Publ., Ottawa, Ont., Canada. 132 pp.

Bailey, L. H., Bailey, E. Z. 1976. Hortus third. Revised. MacMillan, New York, N.Y., USA. 1290 pp.

Scoggan, H. J. 1978, 1979. The flora of Canada. Nat. Mus. Nat. Sci. (Ottawa) Publ. Bot. 7(1)-7(4). 1711 pp.

Van Wijk, H. L. 1911. A dictionary of plant names. Martinus Nijhoff, The Hague, The Netherlands. 1444 pp.

Victorin, M. 1964. Flore Laurentienne. 2nd ed. Univ. Montreal, Montreal, Que., Canada. 952 pp.

Geographic Information

Plant or plant parts used in or around the home.

References:

Bailey, L. H., Bailey, E. Z. 1976. Hortus third. Revised. MacMillan, New York, N.Y., USA. 1290 pp.

Boivin, B. 1966, 1967. Énumération des plantes du Canada. Provencheria 6. Nat. Can. (Que.) 93: 253-274; 371-437; 583-646; 989-1063. 94: 131-157; 471-528; 625-655.

Image or illustration

Sambucus nigra:

Images: images.google.com

Notes on Poisonous plant parts:

The bark, leaves, and berries can cause poisoning in animals. The roots and stems have caused poisoning in humans. Ingesting quantities of uncooked berries can cause nausea (Cooper and Johnson 1984).

Toxic parts:

bark
leaves
mature fruit
roots
stems

References:

Cooper, M. R., Johnson, A. W. 1984. Poisonous plants in Britain and their effects on animals and man. Her Majesty's Stationery Office, London, England. 305 pp.

Tewe, O. O., Iyayi, E. A. 1989. Cyanogenic glycosides. Pages 43-60 in Cheeke, P. R., ed. Toxicants of plant origin. Vol. II. Glycosides. CRC Press, Inc., Boca Raton, Fla., USA. 277 pp.

Notes on Toxic plant chemicals:

Two cyanogenic glycosides, sambunigrin and vicianin, occur in black elderberry. Hydrocyanic acid can be released in animals by the action of plant enzymes after ingestion (Tewe and Iyayi 1989).

Toxic plant chemicals:

sambunigrin
vicianin

References:

Tewe, O. O., Iyayi, E. A. 1989. Cyanogenic glycosides. Pages 43-60 in Cheeke, P. R., ed. Toxicants of plant origin. Vol. II. Glycosides. CRC Press, Inc., Boca Raton, Fla., USA. 277 pp.

Animals/Human Poisoning:

Note: When an animal is listed without additional information, the literature (as of 1993) contained no detailed explanation.

Humans

General symptoms of poisoning:

[nausea](#)
[vomiting](#)

Notes on poisoning:

Humans have developed nausea and vomiting after ingesting uncooked berries. Cooking destroys the toxin. Children were poisoned when they used the hollow stems of elders as pipes (Cooper and Johnson 1984).

References:

Cooper, M. R., Johnson, A. W. 1984. Poisonous plants in Britain and their effects on animals and man. Her Majesty's Stationery Office, London, England. 305 pp.

Swine

General symptoms of poisoning:

[abdominal pains](#)

[breathing, rapid](#)

[death](#)

[diarrhea](#)

[heart rate, elevated](#)

[paralysis, posterior](#)

[salivation](#)

[trembling](#)

[vomiting](#)

Notes on poisoning:

In one European case, pigs ate young leaves and within a day showed symptoms, including salivation, vomiting, abdominal pain, diarrhea, paralysis, trembling, and unsteadiness. Several pigs died (Cooper and Johnson 1984).

References:

Cooper, M. R., Johnson, A. W. 1984. Poisonous plants in Britain and their effects on animals and man. Her Majesty's Stationery Office, London, England. 305 pp.

[Another search?](#)

[Français](#) | [Contact Us](#) | [Help](#) | [Search](#) | [Canada site](#)

[Coming Events](#) | [About CBIF](#) | [Links](#) | [Reports and Publications](#) |

[Home](#)

Date modified: 2003-02-06

[Important Notices](#)



Français	Contact us	Help	Search	Canada site
Coming events	About CBIF	Links	Reports and publications	Home

Canadian Biodiversity Information Facility



Notes on poisoning: *Sarcobatus vermiculatus*

[Introduction](#)[Interactive](#)[All poisonous plants by Botanical name](#)[All poisonous plants by Common name](#)[Important WWW Poisonous Plants sites](#)

General poisoning notes:

Greasewood (*Sarcobatus vermiculatus*) is a native shrub found in western Canada from southwestern Saskatchewan to southeastern British Columbia. In the western United States, sheep that ingested this plant became ill and died. Oxalates are present in all parts of the plant but are concentrated in the leaves. This plant is regarded as valuable forage. Toxicity can be avoided with good animal management (Kingsbury 1964, Cheeke and Schull 1985).

References:

Cheeke, P. R., Shull, L. R. 1985. Natural toxicants in feeds and poisonous plants. AVI Publishing Company, Inc., Westport, Conn., USA. 492 pp.

Kingsbury, J. M. 1964. Poisonous plants of the United States and Canada. Prentice-Hall Inc., Englewood Cliffs, N.J., USA. 626 pp.

Scimeca, J. M., Oehme, F. W. 1985. Postmortem guide to common poisonous plants of livestock. Vet. Hum. Toxicol., 27: 189-199.

Nomenclature:

Scientific Name: *Sarcobatus vermiculatus* (Hook.) Torr.

Vernacular name(s): greasewood

Scientific family name: *Chenopodiaceae*

Vernacular family name: goosefoot

Go to ITIS*^{ca} for more taxonomic information on: [Sarcobatus vermiculatus](#)

References:

Agriculture Quebec. 1975. Noms des maladies des plantes du Canada/ Names of plant diseases in Canada. , Quebec City, Que., Canada. 288 pp.

Alex, J. F., Cayouette, R., Mulligan, G. A. 1980. Common and botanical names of weeds in Canada/Noms populaire et scientifiques des plantes nuisibles du Canada. Revised. Agric. Can. Publ., Ottawa, Ont., Canada. 132 pp.

Bailey, L. H., Bailey, E. Z. 1976. Hortus third. Revised. MacMillan, New York, N.Y., USA. 1290 pp.

Scoggan, H. J. 1978, 1979. The flora of Canada. Nat. Mus. Nat. Sci. (Ottawa) Publ. Bot. 7(1)-7(4). 1711 pp.

Van Wijk, H. L. 1911. A dictionary of plant names. Martinus Nijhoff, The Hague, The Netherlands. 1444 pp.

Victorin, M. 1964. Flore Laurentienne. 2nd ed. Univ. Montreal, Montreal, Que., Canada. 952 pp.

Geographic Information

Alberta
British Columbia
Saskatchewan

References:

Bailey, L. H., Bailey, E. Z. 1976. Hortus third. Revised. MacMillan, New York, N.Y., USA. 1290 pp.

Boivin, B. 1966, 1967. Énumération des plantes du Canada. Provencheria 6. Nat. Can. (Que.) 93: 253-274; 371-437; 583-646; 989-1063. 94: 131-157; 471-528; 625-655.

Image or illustration

Sarcobatus vermiculatus:

Images: images.google.com

Toxic parts:

leaves

References:

Kingsbury, J. M. 1964. Poisonous plants of the United States and Canada. Prentice-Hall Inc., Englewood Cliffs, N.J., USA. 626 pp.

Notes on Toxic plant chemicals:

Oxalates are found in greasewood. On a dry-weight basis the total content was measured at between 10 and 22%, mostly as soluble salts. The oxalate content is greatest in the leaves, the amount increasing with maturity. Ingesting plant material equal to 1.5-5.0% of an animal's body weight can cause toxicity in sheep (Kingsbury 1964).

Toxic plant chemicals:

oxalate

References:

Kingsbury, J. M. 1964. Poisonous plants of the United States and Canada. Prentice-Hall Inc., Englewood Cliffs, N.J., USA. 626 pp.

Animals/Human Poisoning:

Note: When an animal is listed without additional information, the literature (as of 1993) contained no detailed explanation.

Sheep

General symptoms of poisoning:

[coma](#)

[death](#)

[depression](#)

[prostration](#)

[weakness](#)

Notes on poisoning:

In the western United States, 1000 sheep were lost at a single time. Symptoms occur within 3-5 h of ingesting a toxic quantity of greasewood plant. Symptoms may occur abruptly after animals have been watered. Toxic signs include depression, weakness, prostration, coma, and death. Respiration and heart action grow progressively weaker, and death occurs in 12-20 h. Hypocalcemia is caused by the formation of calcium oxalate in the system. Microscopic lesions occur in the kidney tubules (Kingsbury 1964, Scimeca and Oehme 1985).

References:

Kingsbury, J. M. 1964. Poisonous plants of the United States and

Canada. Prentice-Hall Inc., Englewood Cliffs, N.J., USA. 626 pp.

[Another search?](#)

[Français](#) | [Contact Us](#) | [Help](#) | [Search](#) | [Canada site](#)

[Coming Events](#) | [About CBIF](#) | [Links](#) | [Reports and Publications](#) |

[Home](#)

Date modified: 2003-02-06

[Important Notices](#)



Français	Contact us	Help	Search	Canada site
Coming events	About CBIF	Links	Reports and publications	Home

Canadian Biodiversity Information Facility



Notes on poisoning: *Scilla siberica*

[Introduction](#)[Interactive](#)[All poisonous plants by Botanical name](#)[All poisonous plants by Common name](#)[Important WWW Poisonous Plants sites](#)

General poisoning notes:

Siberian scilla (*Scilla siberica*) is a hardy perennial bulb planted outdoors, and sometimes forced indoors, for its beautiful early spring flowers. The entire plant contains cardiac glycosides, which can potentially cause poisoning if ingested. No cases of poisoning have been documented. This is not a good plant to have around children or pets, which have a habit of chewing leaves. Other *Scilla* species may be available in Canada and may also contain toxins. *Scilla* species may also cause skin irritation in sensitive individuals (Lampe and McCann 1985, Spoerke and Smolinske 1990).



References:

Lampe, K. F., McCann, M. A. 1985. AMA Handbook of poisonous and injurious plants. American Medical Assoc. Chicago, Ill., USA. 432 pp.

Spoerke, D. G., Smolinske, S. C. 1990. Toxicity of houseplants. CRC Press, Inc., Boca Raton, Fla., USA. 335 pp.

Nomenclature:

Scientific Name: *Scilla siberica* Andr.

Vernacular name(s): Siberian scilla

Scientific family name: *Liliaceae*

Vernacular family name: lily

Go to ITIS^{*ca} for more taxonomic information on: [Scilla siberica](#)

References:

Agriculture Quebec. 1975. Noms des maladies des plantes du Canada/ Names of plant diseases in Canada. , Quebec City, Que., Canada. 288 pp.

Alex, J. F., Cayouette, R., Mulligan, G. A. 1980. Common and botanical names

of weeds in Canada/Noms populaire et scientifiques des plantes nuisibles du Canada. Revised. Agric. Can. Publ., Ottawa, Ont., Canada. 132 pp.

Bailey, L. H., Bailey, E. Z. 1976. Hortus third. Revised. MacMillan, New York, N.Y., USA. 1290 pp.

Scoggan, H. J. 1978, 1979. The flora of Canada. Nat. Mus. Nat. Sci. (Ottawa) Publ. Bot. 7(1)-7(4). 1711 pp.

Van Wijk, H. L. 1911. A dictionary of plant names. Martinus Nijhoff, The Hague, The Netherlands. 1444 pp.

Victorin, M. 1964. Flore Laurentienne. 2nd ed. Univ. Montreal, Montreal, Que., Canada. 952 pp.

Geographic Information

Plant or plant parts used in or around the home.

References:

Bailey, L. H., Bailey, E. Z. 1976. Hortus third. Revised. MacMillan, New York, N.Y., USA. 1290 pp.

Boivin, B. 1966, 1967. Énumération des plantes du Canada. Provencheria 6. Nat. Can. (Que.) 93: 253-274; 371-437; 583-646; 989-1063. 94: 131-157; 471-528; 625-655.

Image or illustration

Scilla siberica:

Images: images.google.com

Notes on Poisonous plant parts:

The entire plant contains the toxins, including the bulbs and flowers (Lampe and McCann 1985).

Toxic parts:

all parts
bulbs
flowers
leaves

References:

Lampe, K. F., McCann, M. A. 1985. AMA Handbook of poisonous and injurious plants. American Medical Assoc. Chicago, Ill., USA. 432 pp.

Spoerke, D. G., Smolinske, S. C. 1990. Toxicity of houseplants. CRC Press, Inc., Boca Raton, Fla., USA. 335 pp.

Notes on Toxic plant chemicals:

Many *Scilla* species contain cardiac glycosides, scilla-dienolides, which act like digitalis (Spoerke and Smolinske 1990).

Toxic plant chemicals:

scilla-dienolides

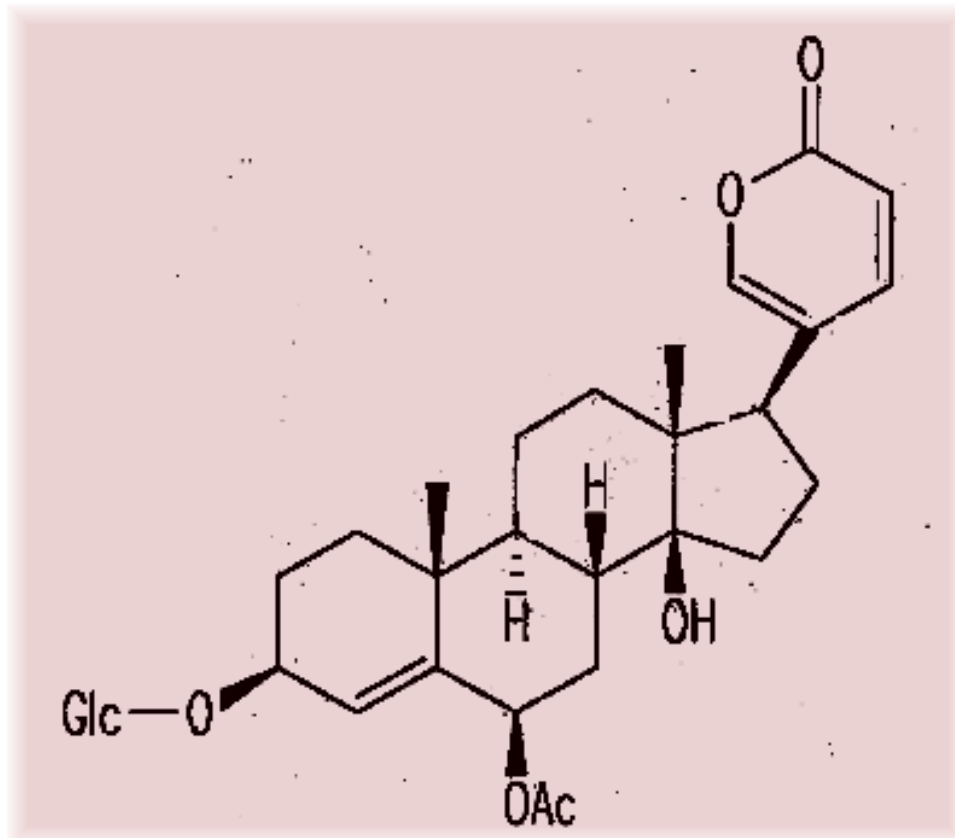

Chemical diagram(s) are courtesy of [Ruth McDiarmid](#), Biochemistry Technician, Kamloops Range Station, Agriculture and Agri-Food Canada, Kamloops, British Columbia, Canada.

References:

Spoerke, D. G., Smolinske, S. C. 1990. Toxicity of houseplants. CRC Press, Inc., Boca Raton, Fla., USA. 335 pp.

Animals/Human Poisoning:

Note: When an animal is listed without additional information, the literature (as of 1993) contained no detailed explanation.

Humans

General symptoms of poisoning:

[abdominal pains](#)

[diarrhea](#)

[vomiting](#)

Notes on poisoning:

Symptoms can include pain in the mouth cavity, abdominal pains, cramps, diarrhea, and an irregular pulse. Several species of *Scilla* are reported to irritate the skin of sensitive individuals (Spoerke and Smolinske 1990).

References:

Lampe, K. F., McCann, M. A. 1985. AMA Handbook of poisonous and injurious plants. American Medical Assoc. Chicago, Ill., USA. 432 pp.

Spoerke, D. G., Smolinske, S. C. 1990. Toxicity of houseplants. CRC Press, Inc., Boca Raton, Fla., USA. 335 pp.

[Another search?](#)

[Français](#) | [Contact Us](#) | [Help](#) | [Search](#) | [Canada site](#)

[Coming Events](#) | [About CBIF](#) | [Links](#) | [Reports and Publications](#) | [Home](#)

Date modified: 2003-02-06

[Important Notices](#)



Français	Contact us	Help	Search	Canada site
Coming events	About CBIF	Links	Reports and publications	Home

Canadian Biodiversity Information Facility



Notes on poisoning: *Senecio integerrimus*

[Introduction](#)[Interactive](#)[All poisonous plants by Botanical name](#)[All poisonous plants by Common name](#)[Important WWW Poisonous Plants sites](#)

General poisoning notes:

Entire-leaved groundsel (*Senecio integerrimus*) is a native herb found through parts of western Canada in the prairies, parklands, and parts of the Rocky Mountains. This plant has caused experimentally chronic poisoning of cattle and horses. Ingesting the plant material over long periods causes irreversible liver damage in animals. This plant grows when other forage is abundant so that it is not a toxic threat unless forage is scarce or the plant is abundant in an area to be cut for hay (Clawson 1933).

References:

Clawson, A. B. 1933. The American groundsels species of *Senecio* as stock poisoning plants. Vet. Med. Small Anim. Clin., 28: 105-110.

Nomenclature:

Scientific Name: *Senecio integerrimus* Nutt.

Vernacular name(s): entire-leaved groundsel

Scientific family name: *Compositae*

Vernacular family name: composite

Go to ITIS^{*ca} for more taxonomic information on: [Senecio integerrimus](#)

References:

Agriculture Quebec. 1975. Noms des maladies des plantes du Canada/ Names of plant diseases in Canada. , Quebec City, Que., Canada. 288 pp.

Alex, J. F., Cayouette, R., Mulligan, G. A. 1980. Common and

botanical names of weeds in Canada/Noms populaire et scientifiques des plantes nuisibles du Canada. Revised. Agric. Can. Publ., Ottawa, Ont., Canada. 132 pp.

Bailey, L. H., Bailey, E. Z. 1976. Hortus third. Revised. MacMillan, New York, N.Y., USA. 1290 pp.

Scoggan, H. J. 1978, 1979. The flora of Canada. Nat. Mus. Nat. Sci. (Ottawa) Publ. Bot. 7(1)-7(4). 1711 pp.

Van Wijk, H. L. 1911. A dictionary of plant names. Martinus Nijhoff, The Hague, The Netherlands. 1444 pp.

Victorin, M. 1964. Flore Laurentienne. 2nd ed. Univ. Montreal, Montreal, Que., Canada. 952 pp.

Geographic Information

Alberta
British Columbia
Manitoba
Northwest Territories
Saskatchewan
Yukon Territory

References:

Bailey, L. H., Bailey, E. Z. 1976. Hortus third. Revised. MacMillan, New York, N.Y., USA. 1290 pp.

Boivin, B. 1966, 1967. Énumération des plantes du Canada. Provencheria 6. Nat. Can. (Que.) 93: 253-274; 371-437; 583-646; 989-1063. 94: 131-157; 471-528; 625-655.

Image or illustration

Senecio integerrimus:

Images: images.google.com

Notes on Poisonous plant parts:

Ingesting the aboveground parts caused poisoning of cattle and horses in experiments. Two cows died after ingesting 92.3 and 135% of their body weight in green plants. A horse fed plants equal to 156% of its body weight (in 81 days) died. A horse fed 76% of its body weight (in 79 days) suffered liver damage. Sheep fed 4.5 kg of green plant material for 28 days showed no symptoms. Liver damage results from ingesting this plant material but takes a long time to develop (Clawson 1933).

Toxic parts:

all parts
flowers
leaves
stems

References:

Clawson, A. B. 1933. The American groundsels species of *Senecio* as stock poisoning plants. *Vet. Med. Small Anim. Clin.*, 28: 105-110.

Kingsbury, J. M. 1964. *Poisonous plants of the United States and Canada*. Prentice-Hall Inc., Englewood Cliffs, N.J., USA. 626 pp.

Notes on Toxic plant chemicals:

Pyrrolizidine alkaloids are found in other toxic members of the genus *Senecio* and are probably the chemicals responsible for cases of poisoning found in experiments.

Toxic plant chemicals:

unknown chemical

References:

Clawson, A. B. 1933. The American groundsels species of *Senecio* as stock poisoning plants. *Vet. Med. Small Anim. Clin.*, 28: 105-110.

Animals/Human Poisoning:

Note: When an animal is listed without additional information, the literature (as of 1993) contained no detailed explanation.

Cattle

General symptoms of poisoning:

[death](#)
[depression](#)
[icterus](#)
[liver, cirrhosis of](#)
[restlessness](#)
[weakness](#)
[weight loss](#)

Notes on poisoning:

Experimental ingestion of plant material caused poisoning and death in cattle. Symptoms are similar to poisoning by other members of the genus *Senecio*, with liver damage causing many of the symptoms. Signs included depression, a peculiar sweet odor from the skin, yellowish discoloration of mucous membranes, itchiness, edema, serum oozing from the skin, and liver damage (Clawson 1933).

References:

Clawson, A. B. 1933. The American groundsels species of *Senecio* as stock poisoning plants. Vet. Med. Small Anim. Clin., 28: 105-110.

Horses

General symptoms of poisoning:

[confusion](#)

[death](#)

[depression](#)

[icterus](#)

[restlessness](#)

[weakness](#)

[weight loss](#)

Notes on poisoning:

Ingesting plant material caused a yellowish discoloration of mucous membranes, a sweet odor from the skin, depression, weakness, restless walking and, after 1 or 2 days, insensibility to objects and pushing against obstacles, urine discoloration, and death. All horses that showed definite symptoms died. Liver damage was apparent upon postmortem examination (Clawson 1933).

References:

Clawson, A. B. 1933. The American groundsels species of *Senecio* as stock poisoning plants. Vet. Med. Small Anim. Clin., 28: 105-110.

Sheep

[Another search?](#)

[Français](#) | [Contact Us](#) | [Help](#) | [Search](#) | [Canada site](#)

[Coming Events](#) | [About CBIF](#) | [Links](#) | [Reports and Publications](#) |

[Home](#)

Date modified: 2003-02-06

[Important Notices](#)



Français	Contact us	Help	Search	Canada site
Coming events	About CBIF	Links	Reports and publications	Home

Canadian Biodiversity Information Facility



Notes on poisoning: *Senecio jacobaea*

[Introduction](#)

[Interactive](#)

[All poisonous plants by Botanical name](#)

[All poisonous plants by Common name](#)

[Important WWW Poisonous Plants sites](#)



General poisoning notes:

Tansy ragwort (*Senecio jacobaea*) is a naturalized herb that is found in fields in eastern Canada and British Columbia. This plant contains pyrrolizidine alkaloids which primarily cause irreversible liver cirrhosis in animals that ingest them. This plant has poisoned cattle and horses, and possibly goats. In the late 19th century and early 20th century, the mysterious Pictou cattle disease in Nova Scotia resulted in heavy losses of cattle. Tansy ragwort ingestion was recognized as causing the problem. In the 1960s cattle losses in Oregon valued at several million dollars were attributed to tansy ragwort ingestion. This plant should be eradicated from forage and crops (Cheeke and Schull 1985, Huxtable 1989). Animals and humans may be poisoned if they drink the milk of animals that have ingested this plant (Molyneux and James 1990, Bain 1990).

References:

- Bain, J. F. 1991. The biology of Canadian weeds. 96. *Senecio jacobaea* L. Can. J. Plant Sci., 71: 127-140.
- Cheeke, P. R., Shull, L. R. 1985. Natural toxicants in feeds and poisonous plants. AVI Publishing Company, Inc., Westport, Conn., USA. 492 pp.
- Fuller, T. C., McClintock, E. 1986. Poisonous plants of California. Univ. California Press, Berkeley, Calif., USA. 432 pp.
- Huxtable, R. J. 1989. Human health implications of pyrrolizidine alkaloids and herbs containing them. Pages 41-86 in Cheeke, P. R., ed. Toxicants of plant origin. Vol. I. Alkaloids. CRC Press, Inc., Boca Raton, Fla., USA. 335 pp.
- Molyneux, R. J., James, L. F. 1990. Pyrrolizidine alkaloids in milk: thresholds of intoxication. Vet. Hum. Toxicol., 32: 94-103.
- Pearson, E. G. 1977. Clinical manifestations of tansy ragwort

poisoning. Mod. Vet. Pract., 57: 421-424.

Pearson, E. G. 1991. Liver failure attributable to pyrrolizidine alkaloid toxicosis and associated with inspiratory dyspnea in ponies: three cases (1982-1988). J. Am. Vet. Med. Assoc., 198: 1651-1654.

Pethick, W. H. 1921. Pictou cattle disease. Can. Vet. Rec., 2: 13-16.

Nomenclature:

Scientific Name: *Senecio jacobaea* L.

Vernacular name(s): tansy ragwort

Scientific family name: *Compositae*

Vernacular family name: composite

Go to ITIS^{*ca} for more taxonomic information on: [Senecio jacobaea](#)

References:

Agriculture Quebec. 1975. Noms des maladies des plantes du Canada/ Names of plant diseases in Canada. , Quebec City, Que., Canada. 288 pp.

Alex, J. F., Cayouette, R., Mulligan, G. A. 1980. Common and botanical names of weeds in Canada/Noms populaire et scientifiques des plantes nuisibles du Canada. Revised. Agric. Can. Publ., Ottawa, Ont., Canada. 132 pp.

Bailey, L. H., Bailey, E. Z. 1976. Hortus third. Revised. MacMillan, New York, N.Y., USA. 1290 pp.

Scoggan, H. J. 1978, 1979. The flora of Canada. Nat. Mus. Nat. Sci. (Ottawa) Publ. Bot. 7(1)-7(4). 1711 pp.

Van Wijk, H. L. 1911. A dictionary of plant names. Martinus Nijhoff, The Hague, The Netherlands. 1444 pp.

Victorin, M. 1964. Flore Laurentienne. 2nd ed. Univ. Montreal, Montreal, Que., Canada. 952 pp.

Geographic Information

British Columbia
New Brunswick
Newfoundland
Nova Scotia
Ontario

Prince Edward Island
Quebec

References:

Bailey, L. H., Bailey, E. Z. 1976. Hortus third. Revised. MacMillan, New York, N.Y., USA. 1290 pp.

Boivin, B. 1966, 1967. Énumération des plantes du Canada. Provencheria 6. Nat. Can. (Que.) 93: 253-274; 371-437; 583-646; 989-1063. 94: 131-157; 471-528; 625-655.

Image or illustration

Senecio jacobaea:

Images: images.google.com

Notes on Poisonous plant parts:

All parts of the plant contain toxic pyrrolizidine alkaloids. The flowers contain the highest concentration of the toxins. The concentration in the leaves increases to a maximum just before flower maturity (Johnson and Molyneux 1986).

Toxic parts:

all parts
flowers
leaves
stems

References:

Johnson, A. E., Molyneux, R. J. 1986. The pyrrolizidine alkaloid free base and N-oxide content of toxic range plants. J. Toxicol. Toxin Rev., 5: 256.

Pethick, W. H. 1921. Pictou cattle disease. Can. Vet. Rec., 2: 13-16.

Notes on Toxic plant chemicals:

Pyrrolizidine alkaloids such as jacobine and seneciphylline are found in tansy ragwort. The content of these alkaloids has been measured at a mean of 0.31% (Cheeke and Schull 1985, Johnson and Molyneux 1986).

Toxic plant chemicals:

jacobine
seneciphylline

References:

Cheeke, P. R., Shull, L. R. 1985. Natural toxicants in feeds and poisonous plants. AVI Publishing Company, Inc., Westport, Conn., USA. 492 pp.

Johnson, A. E., Molyneux, R. J. 1986. The pyrrolizidine alkaloid free base and N-oxide content of toxic range plants. J. Toxicol. Toxin Rev., 5: 256.

Animals/Human Poisoning:

Note: When an animal is listed without additional information, the literature (as of 1993) contained no detailed explanation.

Cattle

General symptoms of poisoning:

[abdominal edema](#)
[agitation](#)
[anorexia](#)
[diarrhea](#)
[jaundice](#)
[liver, cirrhosis of](#)
[nervousness](#)

Notes on poisoning:

So-called Pictou disease was identified in Pictou county, N. S., in cattle and horses; it also occurred in Prince Edward Island. For 20 years, the Canadian government ordered affected herds to be slaughtered before feeding trials confirmed, in 1906, that ingestion of tansy ragwort was responsible. The pyrrolizidine alkaloids cause irreversible liver cirrhosis, with pronounced fibrosis and biliary hyperplasia. Other symptoms include a peculiar bleached color of the hair, nervousness, incoordination, coma, and death. A rapid loss of milk production occurs in lactating cattle, and the milk may taste bitter with an unpleasant odor. Postmortem findings showed liver cirrhosis, often an enlarged gall bladder, abdominal edema, and edema in the mucosa and submucosa of the stomach and intestine (Pethick 1921, Cheeke and Schull 1985, Scimeca and Oehme 1985).

In a case in Oregon, a 3-week-old calf died. Post-mortem findings

showed signs of liver cirrhosis; tansy ragwort poisoning was diagnosed. The dam did not show any signs of tansy ragwort poisoning. Milk from goats was also shown to pass the pyrrolizidine alkaloid (Pearson 1977).

References:

Cheeke, P. R., Shull, L. R. 1985. Natural toxicants in feeds and poisonous plants. AVI Publishing Company, Inc., Westport, Conn., USA. 492 pp.

Pearson, E. G. 1977. Clinical manifestations of tansy ragwort poisoning. *Mod. Vet. Pract.*, 57: 421-424.

Pethick, W. H. 1921. Pictou cattle disease. *Can. Vet. Rec.*, 2: 13-16.

Goats

General symptoms of poisoning:

[abdominal edema](#)

[liver, cirrhosis of](#)

Notes on poisoning:

Goats are not usually poisoned, but if they are fed tansy ragwort they produce mutagenic milk. The pyrrolizidine alkaloids are found in the milk (Huxtable 1989).

References:

Cheeke, P. R., Shull, L. R. 1985. Natural toxicants in feeds and poisonous plants. AVI Publishing Company, Inc., Westport, Conn., USA. 492 pp.

Huxtable, R. J. 1989. Human health implications of pyrrolizidine alkaloids and herbs containing them. Pages 41-86 in Cheeke, P. R., ed. Toxicants of plant origin. Vol. I. Alkaloids. CRC Press, Inc., Boca Raton, Fla., USA. 335 pp.

Horses

General symptoms of poisoning:

[abdominal edema](#)

[coma](#)

[death](#)

[depression](#)

[dyspnea](#)

[gait, staggering](#)

[incoordination](#)
[jaundice](#)
[liver, cirrhosis of](#)
[skin, peeling of](#)
[weight loss](#)

References:

Cheeke, P. R., Shull, L. R. 1985. Natural toxicants in feeds and poisonous plants. AVI Publishing Company, Inc., Westport, Conn., USA. 492 pp.

Pearson, E. G. 1991. Liver failure attributable to pyrrolizidine alkaloid toxicosis and associated with inspiratory dyspnea in ponies: three cases (1982-1988). J. Am. Vet. Med. Assoc., 198: 1651-1654.

Humans

General symptoms of poisoning:

[liver, cirrhosis of](#)

Notes on poisoning:

Pyrrolizidine alkaloids from tansy ragwort were found in honey produced in Oregon and Washington states. The honey is off-color and bitter and is usually not sold. The amount of toxin is so low that acute symptoms of poisoning are unlikely. However, because the effects are cumulative, long term ingestion of this honey cannot be considered safe. There are no records of toxicity from ingesting honey (Fuller and McClintock 1986).

References:

Fuller, T. C., McClintock, E. 1986. Poisonous plants of California. Univ. California Press, Berkeley, Calif., USA. 432 pp.

Sheep

[Another search?](#)

[Français](#) | [Contact Us](#) | [Help](#) | [Search](#) | [Canada site](#)

[Coming Events](#) | [About CBIF](#) | [Links](#) | [Reports and Publications](#) | [Home](#)

Date modified: 2003-02-06

[Important Notices](#)



Français	Contact us	Help	Search	Canada site
Coming events	About CBIF	Links	Reports and publications	Home

Canadian Biodiversity Information Facility



Notes on poisoning: *Senecio vulgaris*

[Introduction](#)[Interactive](#)[All poisonous plants by Botanical name](#)[All poisonous plants by Common name](#)[Important WWW Poisonous Plants sites](#)

General poisoning notes:

Common groundsel (*Senecio vulgaris*) is a naturalized herb found across much of Canada in fields and waste places. This plant contains pyrrolizidine alkaloids, which cause irreversible liver damage after chronic exposure. Cattle and horses have died after ingesting common groundsel. Humans use this plant in teas and herbal remedies in some parts of the world. Death occurred after some species of the genus *Senecio* were ingested. Humans should not ingest foods that contain any plant material from this genus. In a case of prenatal exposure, a mother ingested tea containing an estimated 0.343 mg of senecionine, resulting in fatal veno-occlusive disease in a newborn infant (Huxtable 1989, Spoerke and Smolinske 1990).

References:

Fuller, T. C., McClintock, E. 1986. Poisonous plants of California. Univ. California Press, Berkeley, Calif., USA. 432 pp.

Huxtable, R. J. 1989. Human health implications of pyrrolizidine alkaloids and herbs containing them. Pages 41-86 in Cheeke, P. R., ed. Toxicants of plant origin. Vol. I. Alkaloids. CRC Press, Inc., Boca Raton, Fla., USA. 335 pp.

Lessard, P., Wilson, W. D., Olander, H. J., Rogers, Q. R., Mendel, V. E. 1986. Clinicopathologic study of horses surviving pyrrolizidine alkaloid (*Senecio vulgaris*) toxicosis. Am. J. Vet. Res., 47: 1776-1780.

Mendel, V. E., Witt, M. R., Gitchell, B. S., Gribble, D. N., Rogers, Q. R., Segall, H. J., Knight, H. D. 1988. Pyrrolizidine alkaloid-induced liver disease in horses: an early diagnosis. Am. J. Vet. Res., 49: 572-578.

Spoerke, D. G., Smolinske, S. C. 1990. Toxicity of houseplants. CRC Press, Inc., Boca Raton, Fla., USA. 335 pp.

Nomenclature:

Scientific Name: *Senecio vulgaris* L.

Vernacular name(s): common groundsel

Scientific family name: *Compositae*

Vernacular family name: composite

Go to ITIS*^{ca} for more taxonomic information on: [Senecio vulgaris](#)

References:

Agriculture Quebec. 1975. Noms des maladies des plantes du Canada/ Names of plant diseases in Canada. , Quebec City, Que., Canada. 288 pp.

Alex, J. F., Cayouette, R., Mulligan, G. A. 1980. Common and botanical names of weeds in Canada/Noms populaire et scientifiques des plantes nuisibles du Canada. Revised. Agric. Can. Publ., Ottawa, Ont., Canada. 132 pp.

Bailey, L. H., Bailey, E. Z. 1976. Hortus third. Revised. MacMillan, New York, N.Y., USA. 1290 pp.

Scoggan, H. J. 1978, 1979. The flora of Canada. Nat. Mus. Nat. Sci. (Ottawa) Publ. Bot. 7(1)-7(4). 1711 pp.

Van Wijk, H. L. 1911. A dictionary of plant names. Martinus Nijhoff, The Hague, The Netherlands. 1444 pp.

Victorin, M. 1964. Flore Laurentienne. 2nd ed. Univ. Montreal, Montreal, Que., Canada. 952 pp.

Geographic Information

Alberta
British Columbia
Labrador
Manitoba
New Brunswick
Northwest Territories
Nova Scotia
Ontario
Prince Edward Island
Quebec
Saskatchewan

References:

Bailey, L. H., Bailey, E. Z. 1976. Hortus third. Revised. MacMillan, New York, N.Y., USA. 1290 pp.

Boivin, B. 1966, 1967. Énumération des plantes du Canada. Provencheria 6. Nat. Can. (Que.) 93: 253-274; 371-437; 583-646; 989-1063. 94: 131-157; 471-528; 625-655.

Image or illustration

Senecio vulgaris:

Images: images.google.com

Notes on Poisonous plant parts:

The highest concentration of pyrrolizidine alkaloids is found in the flowers and the lowest in the roots. The amount of toxin increases in the leaves, reaching a maximum just before flower maturity (Johnson and Molyneux 1986).

Toxic parts:

all parts
flowers
leaves

References:

Johnson, A. E., Molyneux, R. J. 1986. The pyrrolizidine alkaloid free base and N-oxide content of toxic range plants. J. Toxicol. Toxin Rev., 5: 256.

Notes on Toxic plant chemicals:

Senecionine, a pyrrolizidine alkaloid, is found in common groundsel. A total of less than 1% alkaloids was measured (Johnson and Molyneux 1986, Huxtable 1989).

Toxic plant chemicals:

senecionine

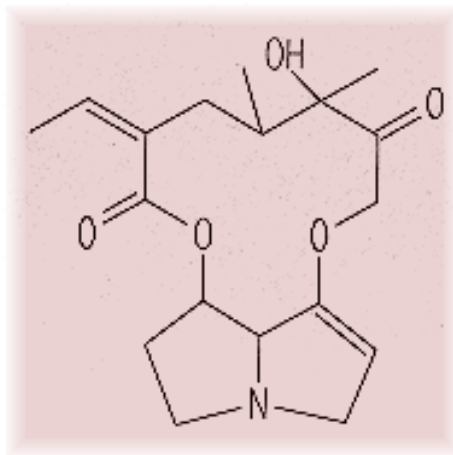

Chemical diagram(s) are courtesy of [Ruth McDiarmid](#), Biochemistry Technician, Kamloops Range Station, Agriculture and Agri-Food Canada, Kamloops, British Columbia, Canada.

References:

Huxtable, R. J. 1989. Human health implications of pyrrolizidine alkaloids and herbs containing them. Pages 41-86 in Cheeke, P. R., ed. Toxicants of plant origin. Vol. I. Alkaloids. CRC Press, Inc., Boca Raton, Fla., USA. 335 pp.

Animals/Human Poisoning:

Note: When an animal is listed without additional information, the literature (as of 1993) contained no detailed explanation.

Cattle

General symptoms of poisoning:

[blindness](#)

[death](#)

[incoordination](#)

[liver, cirrhosis of](#)

[prostration](#)

Notes on poisoning:

Cattle were poisoned after ingesting common groundsel. In some cases, calves 3-8 months old died, whereas older cows showed no clinical signs. Calves from cows eating contaminated hay during pregnancy died the following autumn. The same effects were obtained experimentally from the offspring of rats fed the toxins during pregnancy. Other symptoms include nervousness, incoordination, pushing against objects, walking in circles, and blindness with glazed eyes (Fuller and McClintock 1986).

References:

Fuller, T. C., McClintock, E. 1986. Poisonous plants of California. Univ. California Press, Berkeley, Calif., USA. 432 pp.

Horses

General symptoms of poisoning:

[anorexia](#)

[ataxia](#)

[death](#)

[depression](#)

[diarrhea](#)

[hemoglobinuria](#)

[liver, cirrhosis of](#)

Notes on poisoning:

Ingesting common groundsel leads to sickness and death. Early symptoms include anorexia and listlessness. Animal owners do not usually notice problems until liver damage occurs. Experimental tests show that routine measurement of food intake and weekly body weight can alert owners to pyrrolizidine poisoning early enough so that liver damage can be reduced. Measuring the serum bile acid is the best way to predict animal survival. Liver damage was induced in horses after they ingested an average of 233 +/- 9.2 mg of pyrrolizidine alkaloid per kilogram of body weight. Other symptoms include ataxia, head pressing, and stall walking. Megalocytic hepatopathy develops. Liver damage is often severe before obvious clinical signs develop (Lessard et al. 1986, Mendel et al. 1988).

References:

Lessard, P., Wilson, W. D., Olander, H. J., Rogers, Q. R., Mendel, V. E. 1986. Clinicopathologic study of horses surviving pyrrolizidine alkaloid (*Senecio vulgaris*) toxicosis. Am. J. Vet. Res., 47: 1776-1780.

Mendel, V. E., Witt, M. R., Gitchell, B. S., Gribble, D. N., Rogers, Q. R., Segall, H. J., Knight, H. D. 1988. Pyrrolizidine alkaloid-induced liver disease in horses: an early diagnosis. Am. J. Vet. Res., 49: 572-578.

Humans

General symptoms of poisoning:

[liver, cirrhosis of](#)

Notes on poisoning:

Common groundsel is used in herbal medicine and teas around the world. Humans should not ingest any foods, teas, or remedies that contain any plant material from the genus *Senecio*. Chronic poisoning occurs, resulting in veno-occlusive disease in children and Budd-Chiari syndrome (more commonly) in adults (Huxtable 1989).

References:

Huxtable, R. J. 1989. Human health implications of pyrrolizidine alkaloids and herbs containing them. Pages 41-86 in Cheeke, P. R., ed. Toxicants of plant origin. Vol. I. Alkaloids. CRC Press, Inc., Boca Raton, Fla., USA. 335 pp.

[Another search?](#)

[Français](#) | [Contact Us](#) | [Help](#) | [Search](#) | [Canada site](#)

[Coming Events](#) | [About CBIF](#) | [Links](#) | [Reports and Publications](#) | [Home](#)

Date modified: 2003-02-06

[Important Notices](#)



Français	Contact us	Help	Search	Canada site
Coming events	About CBIF	Links	Reports and publications	Home

Canadian Biodiversity Information Facility



Notes on poisoning: *Sinapis arvensis*

[Introduction](#)[Interactive](#)[All poisonous plants by Botanical name](#)[All poisonous plants by Common name](#)[Important WWW Poisonous Plants sites](#)

General poisoning notes:

Wild mustard (*Sinapis arvensis*) is a naturalized herb found in fields and waste places across Canada. Cattle have been poisoned after ingesting hay containing large quantities of wild mustard seed. This plant contains glucosinolates. See the general notes under [Brassica oleracea](#), which further explain the poisoning potential of plants that contain these chemicals.

References:



Gwatkin, R., Moynihan, I. W. 1943. Wild mustard seed poisoning in cattle. *Can. J. Comp. Med.*, 7: 76-77.

Nomenclature:

Scientific Name: *Sinapis arvensis* L.

Vernacular name(s): wild mustard

Scientific family name: *Cruciferae*

Vernacular family name: mustard

Go to ITIS^{*ca} for more taxonomic information on: [Sinapis arvensis](#)

References:

Agriculture Quebec. 1975. Noms des maladies des plantes du Canada/ Names of plant diseases in Canada. , Quebec City, Que., Canada. 288 pp.

Alex, J. F., Cayouette, R., Mulligan, G. A. 1980. Common and botanical names of weeds in Canada/Noms populaire et scientifiques des plantes nuisibles du Canada. Revised. Agric. Can. Publ., Ottawa, Ont., Canada. 132 pp.

Bailey, L. H., Bailey, E. Z. 1976. Hortus third. Revised. MacMillan, New York, N.Y., USA. 1290 pp.

Scoggan, H. J. 1978, 1979. The flora of Canada. Nat. Mus. Nat. Sci. (Ottawa) Publ. Bot. 7(1)-7(4). 1711 pp.

Van Wijk, H. L. 1911. A dictionary of plant names. Martinus Nijhoff, The Hague, The Netherlands. 1444 pp.

Victorin, M. 1964. Flore Laurentienne. 2nd ed. Univ. Montreal, Montreal, Que., Canada. 952 pp.

Geographic Information

Alberta
British Columbia
Labrador
Manitoba
New Brunswick
Newfoundland
Northwest Territories
Nova Scotia
Ontario
Prince Edward Island
Quebec
Saskatchewan
Yukon Territory

References:

Bailey, L. H., Bailey, E. Z. 1976. Hortus third. Revised. MacMillan, New York, N.Y., USA. 1290 pp.

Boivin, B. 1966, 1967. Énumération des plantes du Canada. Provencheria 6. Nat. Can. (Que.) 93: 253-274; 371-437; 583-646; 989-1063. 94: 131-157; 471-528; 625-655.

Image or illustration

Sinapis arvensis:

Images: images.google.com

Toxic parts:

leaves
seeds

References:

Gwatkin, R., Moynihan, I. W. 1943. Wild mustard seed poisoning in

cattle. Can. J. Comp. Med., 7: 76-77.

Mulligan, G. A., Bailey, L. G. 1975. The biology of Canadian weeds. 8. *Sinapis arvensis* L. Can. J. Plant Sci., 55: 171-183.

Toxic plant chemicals:

glucosinolates

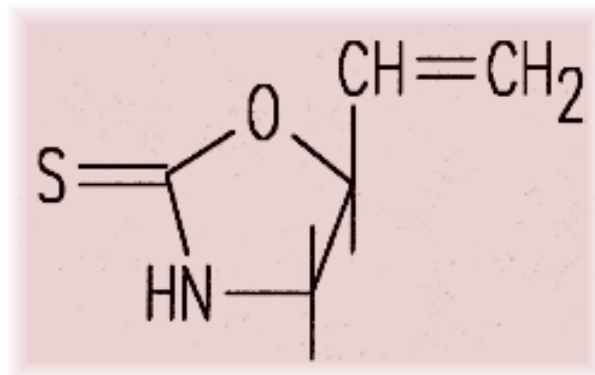

glucosinolates

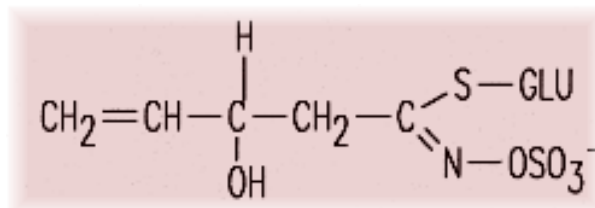

glucosinolates

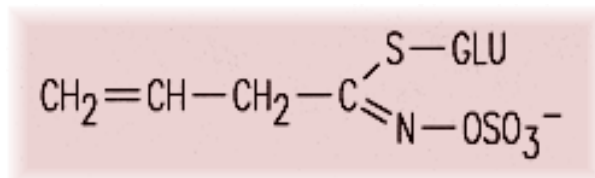

Chemical diagram(s) are courtesy of [Ruth McDiarmid](#), Biochemistry Technician, Kamloops Range Station, Agriculture and Agri-Food Canada, Kamloops, British Columbia, Canada.

References:

Gwatkin, R., Moynihan, I. W. 1943. Wild mustard seed poisoning in cattle. Can. J. Comp. Med., 7: 76-77.

Animals/Human Poisoning:

Note: When an animal is listed without additional information, the literature (as of 1993) contained no detailed explanation.

Cattle

General symptoms of poisoning:

[collapse](#)

[death](#)

[gait, staggering](#)

Notes on poisoning:

Cattle have been poisoned in Canada after ingesting hay containing large quantities of wild mustard seed. The cattle first produced excessive saliva, after which they staggered, collapsed, and died (Gwatkin and Moynihan 1943).

References:

Gwatkin, R., Moynihan, I. W. 1943. Wild mustard seed poisoning in cattle. *Can. J. Comp. Med.*, 7: 76-77.

Swine

[Another search?](#)

[Français](#) | [Contact Us](#) | [Help](#) | [Search](#) | [Canada site](#)

[Coming Events](#) | [About CBIF](#) | [Links](#) | [Reports and Publications](#) |

[Home](#)

Date modified: 2003-02-06

[Important Notices](#)



Français	Contact us	Help	Search	Canada site
Coming events	About CBIF	Links	Reports and publications	Home

Canadian Biodiversity Information Facility



Notes on poisoning: *Solanum dulcamara*

[Introduction](#)

[Interactive](#)

[All poisonous plants by Botanical name](#)

[All poisonous plants by Common name](#)

[Important WWW Poisonous Plants sites](#)

General poisoning notes:

Climbing nightshade (*Solanum dulcamara*) is a naturalized woody vine that is found along fencerows, among shrubbery, and at wood edges across most of southern Canada. The plant, especially in its green immature fruits, contains steroidal alkaloids, which have caused poisoning in cattle and sheep. Humans may have been poisoned after ingesting immature berries. Recent experiments show that the mature red berries contain only a small amount of toxin and have little chance of harming children (Alexander et al. 1948, Cooper and Johnson 1984, Hornfeldt and Collins 1989).



References:

- Alexander, R. F., Forbes, G. B., Hawkins, E. S. 1948. A fatal case of solanine poisoning. *Br. Med. J.*, 2: 518.
- Cooper, M. R., Johnson, A. W. 1984. Poisonous plants in Britain and their effects on animals and man. Her Majesty's Stationery Office, London, England. 305 pp.
- Hornfeldt, C. S., Collins, J. E. 1989. Determination of the toxicity of nightshade berries, *Solanum dulcamara*. *Vet. Hum. Toxicol.*, 31: 363.
- Hornfeldt, C. S., Collins, J. E. 1990. Toxicity of nightshade berries (*Solanum dulcamara*) in mice. *Clin. Toxicol.*, 28: 185-192.
- Keeler, R. F., Baker, D. C., Gaffield, W. 1990. Spirosolane-containing *Solanum* species and induction of congenital craniofacial malformations. *Toxicol.*, 28: 873-884.

Nomenclature:

Scientific Name: *Solanum dulcamara* L.

Vernacular name(s): climbing nightshade

Scientific family name: *Solanaceae*

Vernacular family name: nightshade

Go to ITIS^{*ca} for more taxonomic information on: [Solanum dulcamara](#)

References:

- Agriculture Quebec. 1975. Noms des maladies des plantes du Canada/ Names of plant diseases in Canada. , Quebec City, Que., Canada. 288 pp.
- Alex, J. F., Cayouette, R., Mulligan, G. A. 1980. Common and botanical names of weeds in Canada/Noms populaire et scientifiques des plantes nuisibles du Canada. Revised. Agric. Can. Publ., Ottawa, Ont., Canada. 132 pp.
- Bailey, L. H., Bailey, E. Z. 1976. Hortus third. Revised. MacMillan, New York, N.Y., USA. 1290 pp.
- Scoggan, H. J. 1978, 1979. The flora of Canada. Nat. Mus. Nat. Sci. (Ottawa) Publ. Bot. 7(1)-7(4). 1711 pp.
- Van Wijk, H. L. 1911. A dictionary of plant names. Martinus Nijhoff, The Hague, The Netherlands. 1444 pp.
- Victorin, M. 1964. Flore Laurentienne. 2nd ed. Univ. Montreal, Montreal, Que., Canada. 952 pp.

Geographic Information

Alberta
British Columbia
Manitoba
New Brunswick
Newfoundland
Nova Scotia
Ontario
Prince Edward Island
Quebec
Saskatchewan

References:

- Bailey, L. H., Bailey, E. Z. 1976. Hortus third. Revised. MacMillan, New York, N.Y., USA. 1290 pp.
- Boivin, B. 1966, 1967. Énumération des plantes du Canada. Provencheria 6. Nat. Can. (Que.) 93: 253-274; 371-437; 583-646; 989-1063. 94: 131-157; 471-528; 625-655.

Image or illustration

Solanum dulcamara:

Images: images.google.com

Notes on Poisonous plant parts:

The immature green berries of climbing nightshade have been shown to be toxic to hamsters and mice. Mature red berries did not cause symptoms in mice. Doses were administered (8 mg/kg by orogastric needle) and symptoms occurred within 5-24 h when green berries were given. Ripened berries of climbing nightshade do not appear to present a hazard to children (Baker et al. 1989, Hornfeldt and Collins 1989).

Toxic parts:

immature fruit
leaves

References:

Baker, D. C., Keeler, R. F., Gaffield, W. 1989. Pathology in hamsters administered *Solanum* plant species that contain steroidal alkaloids. *Toxicol.*, 27: 1331-1337.

Cooper, M. R., Johnson, A. W. 1984. Poisonous plants in Britain and their effects on animals and man. Her Majesty's Stationery Office, London, England. 305 pp.

Hornfeldt, C. S., Collins, J. E. 1989. Determination of the toxicity of nightshade berries, *Solanum dulcamara*. *Vet. Hum. Toxicol.*, 31: 363.

Notes on Toxic plant chemicals:

Immature green berries of climbing nightshade contain parent steroidal alkaloid aglycones: 50% solasodine and 50% of another aglycone thought to be soladulcidine. The total alkaloid concentration has been found to be 0.030% of dry matter in the green berries. Water gavage of dry green fruit suspension caused some deaths when given at the rate of 1.4-2.0 g per hamster (avg. wt. 190 g) (Baker et al. 1989).

Toxic plant chemicals:

soladulcidine
solanine

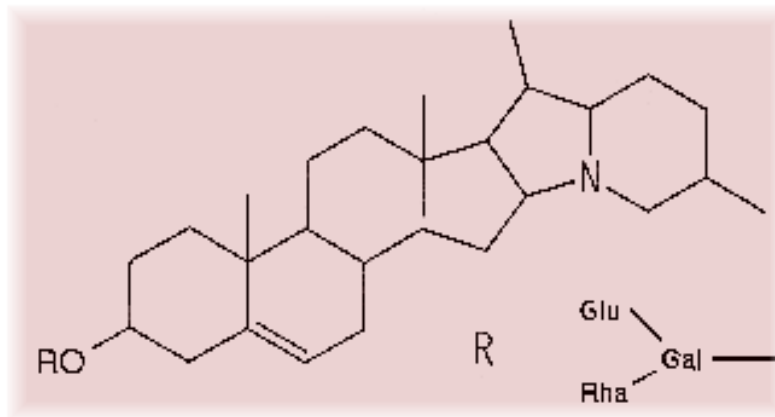

solasodine

Chemical diagram(s) are courtesy of [Ruth McDiarmid](#), Biochemistry Technician, Kamloops Range Station, Agriculture and Agri-Food Canada, Kamloops, British Columbia, Canada.

References:

Baker, D. C., Keeler, R. F., Gaffield, W. 1989. Pathology in hamsters administered *Solanum* plant species that contain steroidal alkaloids. *Toxicon*, 27: 1331-1337.

Animals/Human Poisoning:

Note: When an animal is listed without additional information, the literature (as of 1993) contained no detailed explanation.

Cattle

General symptoms of poisoning:

[incoordination](#)

[muscle spasms](#)

[nervousness](#)

[regurgitation](#)

[salivation](#)

[temperature, depressed](#)

[vomiting](#)

Notes on poisoning:

Cattle that ingested the plant in Britain exhibited symptoms of nervousness, rapid pulse, incoordination, and edema to the front part of the body. The flesh of a slaughtered animal smelled strongly of the plant (Cooper and Johnson 1984).

References:

Cooper, M. R., Johnson, A. W. 1984. Poisonous plants in Britain and their effects on animals and man. Her Majesty's Stationery Office, London, England. 305 pp.

Humans

General symptoms of poisoning:

[abdominal pains](#)

[breathing, labored](#)

[death](#)

[dyspnea](#)

[gastroenteritis](#)

[lethargy](#)

[thirsty](#)

[vomiting](#)

Notes on poisoning:

A child who probably ingested the berries of climbing nightshade died 2 days after exhibiting symptoms of vomiting, weakness, thirst, abdominal pain, dyspnea, and cyanosis. Postmortem examination showed acute inflammation of the mucosa of the stomach and intestines. An alkaloid (7 mg) characteristic of solanine was found in the liver. The evidence is not conclusive, but the child was eating blackberries in an area full of climbing nightshade berries (Alexander et al. 1948).

References:

Alexander, R. F., Forbes, G. B., Hawkins, E. S. 1948. A fatal case of solanine poisoning. Br. Med. J., 2: 518.

Hornfeldt, C. S., Collins, J. E. 1990. Toxicity of nightshade berries (*Solanum dulcamara*) in mice. Clin. Toxicol., 28: 185-192.

Rodents

General symptoms of poisoning:

[breathing, labored](#)

[craniofacial problems](#)

[death](#)

Notes on poisoning:

Tests with mice show that ingesting green (unripe) berries can cause gastroenteritis lesions, labored breathing, and lethargy. Villous atrophy of the small intestine also occurred. The red (ripe) berries did not cause any problems (Hornfeldt and Collins 1990). Tests with unripe berries on

pregnant hamsters induced congenital craniofacial malformations in fetuses in 16% of cases. Dosages administered were high, resulting in the death of some dams. Severe gastrointestinal necrosis caused the deaths. Fetuses showed encephalocele with occasional cleft palate and harelip. Another member of the genus (*Solanum sarrachoides* Sendt.; hairy nightshade) also caused a few problems in fetuses, but the numbers were not statistically significant (Keeler et al. 1990).

References:

Hornfeldt, C. S., Collins, J. E. 1990. Toxicity of nightshade berries (*Solanum dulcamara*) in mice. *Clin. Toxicol.*, 28: 185-192.

Keeler, R. F., Baker, D. C., Gaffield, W. 1990. Spirosolane-containing *Solanum* species and induction of congenital craniofacial malformations. *Toxicon*, 28: 873-884.

Sheep

General symptoms of poisoning:

[death](#)

[diarrhea](#)

[falling down](#)

[gait, staggering](#)

[pupil dilation](#)

[temperature, elevated](#)

Notes on poisoning:

In one case in Britain, sheep ingested climbing nightshade plant material and developed rapid respiration, feeble pulse, elevated temperature, dilated pupils, and green diarrhea, then death. Postmortem findings showed dark, tarry blood, contracted ventricles, and plant material in the stomach (Cooper and Johnson 1984).

References:

Cooper, M. R., Johnson, A. W. 1984. Poisonous plants in Britain and their effects on animals and man. Her Majesty's Stationery Office, London, England. 305 pp.

[Another search?](#)

[Français](#) | [Contact Us](#) | [Help](#) | [Search](#) | [Canada site](#)

[Coming Events](#) | [About CBIF](#) | [Links](#) | [Reports and Publications](#) | [Home](#)

Date modified: 2003-02-06

[Important Notices](#)



Français	Contact us	Help	Search	Canada site
Coming events	About CBIF	Links	Reports and publications	Home

Canadian Biodiversity Information Facility



Notes on poisoning: *Solanum nigrum*

[Introduction](#)[Interactive](#)[All poisonous plants by Botanical name](#)[All poisonous plants by Common name](#)[Important WWW Poisonous Plants sites](#)

General poisoning notes:

Black nightshade (*Solanum nigrum*) is a naturalized herb found scattered across southern Canada in waste places. This plant can be easily confused with eastern black nightshade, a native herb, which is more commonly found in its range in eastern Canada (see taxonomy and distributions in Ogg et al. 1981, Bassett and Munro 1985). Black nightshade contains toxic glycoalkaloids in the plant. The highest concentration is in the green immature berries. All kinds of animals can be poisoned after ingesting nightshade including cattle, sheep, poultry, and swine. Children have been poisoned and have died after ingesting unripe berries. The ripe berries cause reduced symptoms of mild abdominal pains, vomiting, and diarrhea (Cooper and Johnson 1984, Lampe and McCann 1985). Some Canadian garden catalogs sell seed for garden huckleberry (*Solanum melanocerasum* All.; also previously known as *Solanum nigrum* L. var. *guineense* L.). This plant has edible black fruits that can be cooked for use in pies, jams, and preserves. The plant may persist from seed for more than a year in gardens in warmer parts of Canada. There is no evidence that the ripe fruits are toxic. Other species of nightshade occur in Canada, and some may contain small amounts of toxins. Eastern black nightshade (*Solanum ptycanthum* Dun ex DC.) may contain small amounts of toxin in the green berries. Berries of hairy nightshade (*Solanum sarrachoides* Sendt.) have been tested as a teratogen in hamsters but the results were not statistically significant (Keeler et al .1990).

References:

- Bassett, I. J., [Munro, D. B.](#) 1985. The biology of Canadian weeds. 67. *Solanum ptycanthum* Dun., *S. nigrum* L. and *S. sarrachoides* Sendt. Can. J. Plant Sci., 65: 401-414.
- Cooper, M. R., Johnson, A. W. 1984. Poisonous plants in Britain and their effects on animals and man. Her Majesty's Stationery Office, London, England. 305 pp.
- Keeler, R. F., Baker, D. C., Gaffield, W. 1990. Spirosolane-containing

Solanum species and induction of congenital craniofacial malformations. *Toxicon*, 28: 873-884.

Lampe, K. F., McCann, M. A. 1985. *AMA Handbook of poisonous and injurious plants*. American Medical Assoc. Chicago, Ill., USA. 432 pp.

Ogg, A. G., Rogers, B. S., Schilling, E. E. 1981. Characterization of black nightshade (*Solanum nigrum*) and related species in the United States. *Weed Sci.*, 29: 27-32.

Reynard, G. B., Norton, J. B. 1942. Poisonous plants of Maryland in relation to livestock. *Univ. MD. Agric. Exp. Stn. Bull.*, A10. 312 pp.

Nomenclature:

Scientific Name: *Solanum nigrum* L.

Vernacular name(s): black nightshade

Scientific family name: *Solanaceae*

Vernacular family name: nightshade

Go to ITIS*^{ca} for more taxonomic information on: [Solanum nigrum](#)

References:

Agriculture Quebec. 1975. *Noms des maladies des plantes du Canada/ Names of plant diseases in Canada*. , Quebec City, Que., Canada. 288 pp.

Alex, J. F., Cayouette, R., Mulligan, G. A. 1980. *Common and botanical names of weeds in Canada/Noms populaire et scientifiques des plantes nuisibles du Canada*. Revised. *Agric. Can. Publ.*, Ottawa, Ont., Canada. 132 pp.

Bailey, L. H., Bailey, E. Z. 1976. *Hortus third*. Revised. MacMillan, New York, N.Y., USA. 1290 pp.

Scoggan, H. J. 1978, 1979. *The flora of Canada*. *Nat. Mus. Nat. Sci. (Ottawa) Publ. Bot.* 7(1)-7(4). 1711 pp.

Van Wijk, H. L. 1911. *A dictionary of plant names*. Martinus Nijhoff, The Hague, The Netherlands. 1444 pp.

Victorin, M. 1964. *Flore Laurentienne*. 2nd ed. Univ. Montreal, Montreal, Que., Canada. 952 pp.

Geographic Information

Alberta
British Columbia
Manitoba
New Brunswick
Nova Scotia

Ontario
Quebec
Saskatchewan

References:

Bailey, L. H., Bailey, E. Z. 1976. Hortus third. Revised. MacMillan, New York, N.Y., USA. 1290 pp.

Boivin, B. 1966, 1967. Énumération des plantes du Canada. Provencheria 6. Nat. Can. (Que.) 93: 253-274; 371-437; 583-646; 989-1063. 94: 131-157; 471-528; 625-655.

Image or illustration

Solanum nigrum:

Images: images.google.com

Notes on Poisonous plant parts:

All parts of the plant contain alkaloids, especially the green immature berries. The concentration increases in the leaves until plant maturity. The ripe black berries contain little alkaloidal content and can sometimes be eaten with no harmful effects (Cooper and Johnson 1984).

Toxic parts:

all parts
immature fruit
leaves

References:

Cooper, M. R., Johnson, A. W. 1984. Poisonous plants in Britain and their effects on animals and man. Her Majesty's Stationery Office, London, England. 305 pp.

Notes on Toxic plant chemicals:

Toxic glycoalkaloids, including solanine, solasodine, and chaconine are found in black nightshade, especially in the green immature berries. Nitrates can also accumulate in the plant material (Cooper and Johnson 1984).

Toxic plant chemicals:

chaconine

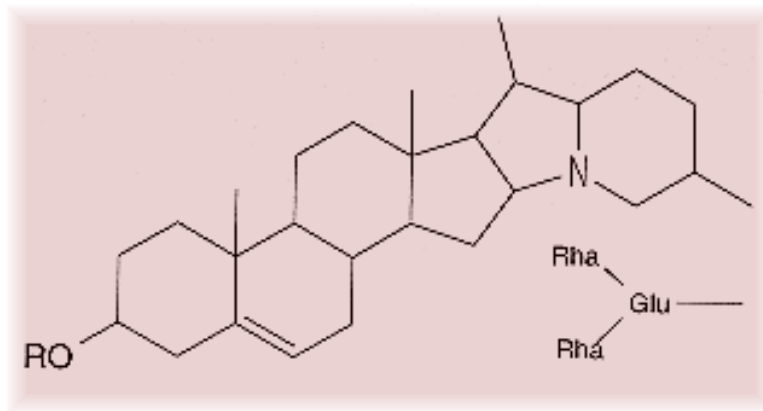

nitrate
solanine

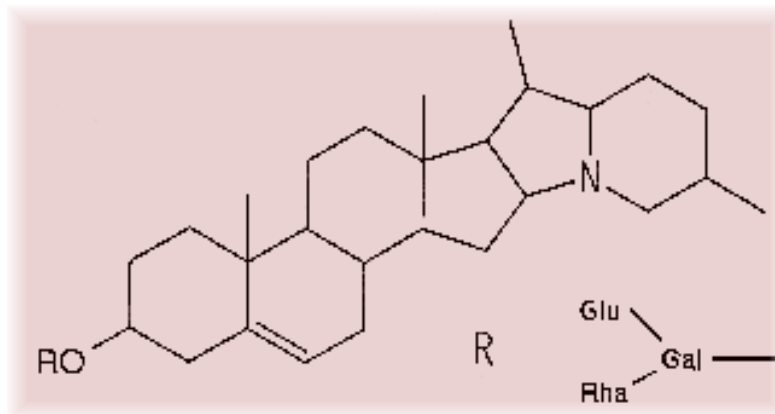

solasodine

Chemical diagram(s) are courtesy of [Ruth McDiarmid](#), Biochemistry Technician, Kamloops Range Station, Agriculture and Agri-Food Canada, Kamloops, British Columbia, Canada.

References:

Cooper, M. R., Johnson, A. W. 1984. Poisonous plants in Britain and their effects on animals and man. Her Majesty's Stationery Office, London, England. 305 pp.

Animals/Human Poisoning:

Note: When an animal is listed without additional information, the literature (as of 1993) contained no detailed explanation.

Cattle

General symptoms of poisoning:

[breathing, labored](#)

[constipation](#)

[death](#)

[diarrhea](#)
[incoordination](#)
[muzzle, dry](#)
[pupil dilation](#)
[temperature, depressed](#)

Notes on poisoning:

Symptoms of poisoning are similar to those for swine. Cattle can also develop edema from the lower jaw to the front of the legs (Cooper and Johnson 1984).

References:

Cooper, M. R., Johnson, A. W. 1984. Poisonous plants in Britain and their effects on animals and man. Her Majesty's Stationery Office, London, England. 305 pp.

Humans

General symptoms of poisoning:

[abdominal pains](#)
[death](#)
[diarrhea](#)
[dizziness](#)
[temperature, elevated](#)
[unconsciousness](#)
[vomiting](#)

Notes on poisoning:

Humans have been poisoned and have died (rarely) after ingesting usually green immature berries. Ripe, black berries have little toxin in them, although abdominal pains and vomiting could occur. Symptoms usually occur only after a latent period of several hours and may persist for several days. Symptoms resemble those of bacterial gastroenteritis and include headache, speech impairment, and unconsciousness (Cooper and Johnson 1984, Lampe and McCann 1985).

References:

Cooper, M. R., Johnson, A. W. 1984. Poisonous plants in Britain and their effects on animals and man. Her Majesty's Stationery Office, London, England. 305 pp.

Poultry

General symptoms of poisoning:

[death](#)

Notes on poisoning:

In one case in Maryland, over 300 pullets died when they were allowed to feed on a field overgrown with black nightshade (Reynard and Norton 1942).

References:

Cooper, M. R., Johnson, A. W. 1984. Poisonous plants in Britain and their effects on animals and man. Her Majesty's Stationery Office, London, England. 305 pp.

Swine

General symptoms of poisoning:

[breathing, rapid](#)

[death](#)

[incoordination](#)

[muscle spasms](#)

[temperature, depressed](#)

Notes on poisoning:

Pigs have been poisoned after ingesting black nightshade. Symptoms included rapid pulse and respiration, pale mucous membranes, dilated pupils, depressed temperature, incoordination, and tremors (Cooper and Johnson 1984).

References:

Cooper, M. R., Johnson, A. W. 1984. Poisonous plants in Britain and their effects on animals and man. Her Majesty's Stationery Office, London, England. 305 pp.

[Another search?](#)

[Français](#) | [Contact Us](#) | [Help](#) | [Search](#) | [Canada site](#)

[Coming Events](#) | [About CBIF](#) | [Links](#) | [Reports and Publications](#) | [Home](#)

Date modified: 2003-02-06

[Important Notices](#)



Français	Contact us	Help	Search	Canada site
Coming events	About CBIF	Links	Reports and publications	Home



Notes on poisoning: *Solanum pseudocapsicum*

[Introduction](#)

[Interactive](#)

[All poisonous plants by Botanical name](#)

[All poisonous plants by Common name](#)

[Important WWW Poisonous Plants sites](#)



General poisoning notes:

Jerusalem-cherry (*Solanum pseudocapsicum*) is an indoor ornamental grown for its colorful berries. This plant contains an alkaloid, solanocapsine, that is related to solanine. Experiments have shown that the chemical can cause death, although it is unlikely because oral absorption of the toxin is minimal. Experiments with cats and rats have shown that oral ingesting leaves and berries has not caused severe symptoms. By extrapolation, children or family pets that ingest moderate amounts of leaf or berry material may experience mild gastroenteritis and vomiting (Der Marderosian et al. 1976, Spoerke and Smolinske 1990).

References:

- Der Marderosian, A. H., Giller, F. B., Roia, F. C. 1976. Phytochemical and toxicological screening of household ornamental plants potentially toxic to humans. 1. J. Toxicol. Environ. Health, 1: 939-953.
- Spoerke, D. G., Smolinske, S. C. 1990. Toxicity of houseplants. CRC Press, Inc., Boca Raton, Fla., USA. 335 pp.

Nomenclature:

Scientific Name: *Solanum pseudocapsicum* L.

Vernacular name(s): Jerusalem-cherry

Scientific family name: *Solanaceae*

Vernacular family name: nightshade

Go to ITIS^{*ca} for more taxonomic information on: [Solanum pseudocapsicum](#)

References:

Agriculture Quebec. 1975. Noms des maladies des plantes du Canada/ Names of plant diseases in Canada. , Quebec City, Que., Canada. 288 pp.

Alex, J. F., Cayouette, R., Mulligan, G. A. 1980. Common and botanical names of weeds in Canada/Noms populaire et scientifiques des plantes nuisibles du Canada. Revised. Agric. Can. Publ., Ottawa, Ont., Canada. 132 pp.

Bailey, L. H., Bailey, E. Z. 1976. Hortus third. Revised. MacMillan, New York, N.Y., USA. 1290 pp.

Scoggan, H. J. 1978, 1979. The flora of Canada. Nat. Mus. Nat. Sci. (Ottawa) Publ. Bot. 7(1)-7(4). 1711 pp.

Van Wijk, H. L. 1911. A dictionary of plant names. Martinus Nijhoff, The Hague, The Netherlands. 1444 pp.

Victorin, M. 1964. Flore Laurentienne. 2nd ed. Univ. Montreal, Montreal, Que., Canada. 952 pp.

Geographic Information

Plant or plant parts used in or around the home.

References:

Bailey, L. H., Bailey, E. Z. 1976. Hortus third. Revised. MacMillan, New York, N.Y., USA. 1290 pp.

Boivin, B. 1966, 1967. Énumération des plantes du Canada. Provencheria 6. Nat. Can. (Que.) 93: 253-274; 371-437; 583-646; 989-1063. 94: 131-157; 471-528; 625-655.

Image or illustration

Solanum pseudocapsicum:

Images: images.google.com

Notes on Poisonous plant parts:

In experiments, extracts of the unripe and ripe berries have caused deaths in rats; the doses were very high and were given intraperitoneally. However, rats that ingested leaves did not die. Humans who ingest berries probably experience only mild gastrointestinal effects (Spoerke and Smolinske 1990).

Toxic parts:

immature fruit
leaves
mature fruit

References:

Der Marderosian, A. H., Giller, F. B., Roia, F. C. 1976. Phytochemical and toxicological screening of household ornamental plants potentially toxic to humans. 1. J. Toxicol. Environ. Health, 1: 939-953.

Spoerke, D. G., Smolinske, S. C. 1990. Toxicity of houseplants. CRC Press, Inc., Boca Raton, Fla., USA. 335 pp.

Notes on Toxic plant chemicals:

Solanocapsine is an alkaloid that is structurally similar to solanine. It has a similar steroidal skeleton with an additional nitrogen group, but it is not a glycoside. Slowing of frog hearts has been shown with concentrations as low as 1:8 million. Oral absorption is minimal in animals. Rats experimentally injected with extracts from berries of Jerusalem-cherry (intraperitoneally, 3 g/100 g of body weight) resulted in the following fatalities:

- ripe fruit => 3 out of 5 rats killed
- unripe fruit => 4 out of 5 rats killed

These results indicate that death is possible, although the dosages given were very high (Der Marderosian et al. 1976, Spoerke and Smolinske 1990).

Toxic plant chemicals:

solanocapsine

References:

Der Marderosian, A. H., Giller, F. B., Roia, F. C. 1976. Phytochemical and toxicological screening of household ornamental plants potentially toxic to humans. 1. J. Toxicol. Environ. Health, 1: 939-953.

Spoerke, D. G., Smolinske, S. C. 1990. Toxicity of houseplants. CRC Press, Inc., Boca Raton, Fla., USA. 335 pp.

Animals/Human Poisoning:

Note: When an animal is listed without additional information, the literature (as of 1993) contained no detailed explanation.

Cats

General symptoms of poisoning:

[heart rate, slow](#)

Notes on poisoning:

Oral administration of pure solanocapsine has produced only slow heart rate and vomiting. Injection resulted in seizures and death. Oral ingestion of berries or leaves would likely produce only mild gastroenteritis and vomiting (Spoerke and Smolinske 1990).

References:

- Der Marderosian, A. H., Giller, F. B., Roia, F. C. 1976. Phytochemical and toxicological screening of household ornamental plants potentially toxic to humans. 1. J. Toxicol. Environ. Health, 1: 939-953.
- Spoerke, D. G., Smolinske, S. C. 1990. Toxicity of houseplants. CRC Press, Inc., Boca Raton, Fla., USA. 335 pp.

Humans

General symptoms of poisoning:

[abdominal pains](#)

[gastroenteritis](#)

[vomiting](#)

Notes on poisoning:

Experiments on animals suggest that children who ingest leaf or berry material might suffer only mild gastroenteritis or vomiting. Nevertheless, children should be taught to avoid eating these plants (Spoerke and Smolinske 1990).

References:

- Spoerke, D. G., Smolinske, S. C. 1990. Toxicity of houseplants. CRC Press, Inc., Boca Raton, Fla., USA. 335 pp.

[Another search?](#)

[Français](#) | [Contact Us](#) | [Help](#) | [Search](#) | [Canada site](#)

[Coming Events](#) | [About CBIF](#) | [Links](#) | [Reports and Publications](#) |

[Home](#)

Date modified: 2003-02-06

[Important Notices](#)



Français	Contact us	Help	Search	Canada site
Coming events	About CBIF	Links	Reports and publications	Home



Notes on poisoning: *Solanum tuberosum*

[Introduction](#)

[Interactive](#)

[All poisonous plants by Botanical name](#)

[All poisonous plants by Common name](#)

[Important WWW Poisonous Plants sites](#)



General poisoning notes:

Potato (*Solanum tuberosum*) is a common introduced garden plant cultivated for its edible tubers. The entire plant contains toxic glycoalkaloids but usually in harmless quantities in the edible tubers. However, in the presence of light, the tubers photosynthesize and coincidentally increase the amount of toxins. The skin, eyes, and sprouts of the tubers can develop toxic amounts. Even the flesh of the tuber can develop toxic quantities of the glycoalkaloids. Cattle, sheep, and swine as well as humans were poisoned and died after ingesting parts of potato plant. Other animals were also been poisoned experimentally. A dog became comatose after ingesting green potato tubers. The aboveground plant portion can also be toxic. The berries produced by the plant can contain 10-20 times more glycoalkaloids than the tubers (Cooper and Johnson 1984). The glycoalkaloids solanine and chaconine are not destroyed by normal cooking. Alkaloidal levels above 20 mg/100 g are considered unsafe for human consumption. Some cultivars have naturally high concentrations of alkaloids and have been rejected for use. Care should be taken to store potatoes in light-proof paper bags. If any green-colored potatoes are found, they should be discarded. Potato peelings and sprouts destined for a compost heap should be buried and kept from dogs or other animals. Sharma and Salunkhe (1989) provide an excellent review of potatoes and toxins and their effects on animals.

References:

Clay, B. R., Edwards, W. C., Peterson, D. R. 1976. Toxic nitrate accumulation in the sorghums. *Bovine Pract.*, 11: 28-32.

Cooper, M. R., Johnson, A. W. 1984. *Poisonous plants in Britain and their effects on animals and man.* Her Majesty's Stationery Office, London, England. 305 pp.

Keeler, R. F., Baker, D. C., Gaffield, W. 1990. Spirosolane-containing *Solanum* species and induction of congenital craniofacial malformations. *Toxicol.*, 28: 873-884.

McMillan, M., Thompson, J. C. 1979. An outbreak of suspected solanine poisoning in schoolboys: examination of criteria of solanine poisoning. *Q. J. Med.*, 48: 227-243.

Sharma, R. P., Salunkhe, D. K. 1989. *Solanum* glycoalkaloids. Pages 179-236 in Cheeke, P. R., ed. Toxicants of plant origin. Vol. I. Alkaloids. CRC Press, Inc., Boca Raton, Fla., USA. 335 pp.

Nomenclature:

Scientific Name: *Solanum tuberosum* L.

Vernacular name(s): potato

Scientific family name: *Solanaceae*

Vernacular family name: nightshade

Go to ITIS*^{ca} for more taxonomic information on: [Solanum tuberosum](#)

References:

Agriculture Quebec. 1975. Noms des maladies des plantes du Canada/ Names of plant diseases in Canada. , Quebec City, Que., Canada. 288 pp.

Alex, J. F., Cayouette, R., Mulligan, G. A. 1980. Common and botanical names of weeds in Canada/Noms populaire et scientifiques des plantes nuisibles du Canada. Revised. Agric. Can. Publ., Ottawa, Ont., Canada. 132 pp.

Bailey, L. H., Bailey, E. Z. 1976. Hortus third. Revised. MacMillan, New York, N.Y., USA. 1290 pp.

Scoggan, H. J. 1978, 1979. The flora of Canada. Nat. Mus. Nat. Sci. (Ottawa) Publ. Bot. 7(1)-7(4). 1711 pp.

Van Wijk, H. L. 1911. A dictionary of plant names. Martinus Nijhoff, The Hague, The Netherlands. 1444 pp.

Victorin, M. 1964. Flore Laurentienne. 2nd ed. Univ. Montreal, Montreal, Que., Canada. 952 pp.

Geographic Information

Plant or plant parts used in or around the home.

References:

Bailey, L. H., Bailey, E. Z. 1976. Hortus third. Revised. MacMillan, New York, N.Y., USA. 1290 pp.

Boivin, B. 1966, 1967. Énumération des plantes du Canada. Provencheria 6. Nat. Can. (Que.) 93: 253-274; 371-437; 583-646; 989-1063. 94:

131-157; 471-528; 625-655.

Image or illustration

Solanum tuberosum:

Images: images.google.com

Notes on Poisonous plant parts:

Potato tubers can develop toxic levels of glycoalkaloids if they are exposed to sunlight. The development of the toxins coincides with the production of chlorophyll in the presence of light. The toxins are highest in the skin, eyes, and sprouts. In a test on rats fed 10% sprouts from early pregnancy, 55% of litters died because of failure to lactate. Potato cultivars, such as "Lenape" have been developed with natural toxic levels of alkaloids in the tubers; these cultivars have not been released for use. The leaves, stems, and berries of potato also contain toxic substances. The concentration of alkaloids in the berries may be 10-20 times that of the tubers (Butterworth and Pelling 1980, Cooper and Johnson 1984, Cheeke and Schull 1985, Salunkhe 1989).

Toxic parts:

immature fruit
leaves
stems
tubers

References:

Butterworth, K. R., Pelling, D. 1980. Are potato 'apples' toxic? J. Pharm. Pharmacol., 32: 79 P.

Cheeke, P. R., Shull, L. R. 1985. Natural toxicants in feeds and poisonous plants. AVI Publishing Company, Inc., Westport, Conn., USA. 492 pp.

Cooper, M. R., Johnson, A. W. 1984. Poisonous plants in Britain and their effects on animals and man. Her Majesty's Stationery Office, London, England. 305 pp.

Notes on Toxic plant chemicals:

Two glycoalkaloids, alpha-solanine and alpha-chaconine, are the major alkaloids in potatoes. The major effects are gastrointestinal tract irritation and nervous system impairment. Exposing the potato tubers to light may increase the concentration of glycoalkaloids to 0.05% in the tuber instead of the usual 0.008%. Potatoes are now screened for toxin levels, which must be below 20 mg/100 g. Levels above 14 mg/100 g are bitter. One variety developed in the 1960s, "Lenape", had levels over 30 mg/100 g and

Animals/Human Poisoning:

Note: When an animal is listed without additional information, the literature (as of 1993) contained no detailed explanation.

Cattle

General symptoms of poisoning:

[anemia](#)

[anorexia](#)

[convulsions](#)

[death](#)

[diarrhea](#)

[restlessness](#)

Notes on poisoning:

Cattle were poisoning after they were given access to green, decayed, or sprouting potatoes. In Europe, feeding large quantities of stored potatoes to young cattle over long periods is recognised as causing severe anemia (Cooper and Johnson 1984).

References:

Cooper, M. R., Johnson, A. W. 1984. Poisonous plants in Britain and their effects on animals and man. Her Majesty's Stationery Office, London, England. 305 pp.

Dogs

General symptoms of poisoning:

[breathing, labored](#)

[coma](#)

[pupil dilation](#)

References:

Cooper, M. R., Johnson, A. W. 1984. Poisonous plants in Britain and their effects on animals and man. Her Majesty's Stationery Office, London, England. 305 pp.

Humans

General symptoms of poisoning:

[abdominal pains](#)

[confusion](#)

[death](#)
[drowsiness](#)
[gastroenteritis](#)
[hallucination](#)
[headache](#)
[trembling](#)
[vomiting](#)

Notes on poisoning:

Ingesting potatoes with green flesh, skin, or tubers causes sickness and, in some cases, human fatalities. Symptoms of ingestion include those common to gastrointestinal problems and nervous disorders. Clinical signs include headache, vomiting, diarrhea and abdominal pain. Neurological symptoms include apathy, restlessness, drowsiness, stupor, confusion, hallucinations, dizziness, trembling, and visual impairment. In severe cases, fatalities occur. Certain birth defects are believed to result from ingesting potatoes infected with potato blight (*Phytophthora infestans*). However, no definitive proof has been found yet (McMillan and Thompson 1979, Sharma and Salunkhe 1989).

References:

McMillan, M., Thompson, J. C. 1979. An outbreak of suspected solanine poisoning in schoolboys: examination of criteria of solanine poisoning. *Q. J. Med.*, 48: 227-243.

Sharma, R. P., Salunkhe, D. K. 1989. *Solanum* glycoalkaloids. Pages 179-236 in Cheeke, P. R., ed. Toxicants of plant origin. Vol. I. Alkaloids. CRC Press, Inc., Boca Raton, Fla., USA. 335 pp.

Rodents

General symptoms of poisoning:

[craniofacial problems](#)
[gastroenteritis](#)

Notes on poisoning:

Pregnant hamsters were gavaged with potato sprout material. Some dams died as a result of experimentally ingesting sprout material. Fetal craniofacial malformations occurred in 24% of cases (Keeler et al. 1990).

References:

Keeler, R. F., Baker, D. C., Gaffield, W. 1990. Spirosolane-containing *Solanum* species and induction of congenital craniofacial malformations. *Toxicol.*, 28: 873-884.

Sheep

General symptoms of poisoning:

[death](#)

[incoordination](#)

[weakness](#)

References:

Cooper, M. R., Johnson, A. W. 1984. Poisonous plants in Britain and their effects on animals and man. Her Majesty's Stationery Office, London, England. 305 pp.

Swine

General symptoms of poisoning:

[anorexia](#)

[coma](#)

[convulsions](#)

[diarrhea](#)

[incoordination](#)

[pupil dilation](#)

[restlessness](#)

[salivation](#)

[vomiting](#)

[weakness](#)

Notes on poisoning:

In Europe, swine that ingested potatoes were poisoned and subsequently died. Some animals died suddenly, whereas others showed signs of incoordination, convulsions, and appeared dazed. Additional symptoms included anorexia, excess salivation, vomiting, diarrhea or constipation, and circulatory failure. Some cases required amputation, resulting from necrosis of the feet (Cooper and Johnson 1984).

References:

Cooper, M. R., Johnson, A. W. 1984. Poisonous plants in Britain and their effects on animals and man. Her Majesty's Stationery Office, London, England. 305 pp.

[Another search?](#)

[Français](#) | [Contact Us](#) | [Help](#) | [Search](#) | [Canada site](#)

[Coming Events](#) | [About CBIF](#) | [Links](#) | [Reports and Publications](#) | [Home](#)

Date modified: 2003-02-06

[Important Notices](#)



Français	Contact us	Help	Search	Canada site
Coming events	About CBIF	Links	Reports and publications	Home

Canadian Biodiversity Information Facility



Notes on poisoning: *Solidago mollis*

[Introduction](#)[Interactive](#)[All poisonous plants by Botanical name](#)[All poisonous plants by Common name](#)[Important WWW Poisonous Plants sites](#)

General poisoning notes:

Velvety goldenrod (*Solidago mollis*) is a native herb found in the southern prairie provinces. This plant was fed experimentally to sheep, killing them. The corrosive resins have caused weight loss in calves, sheep, and small laboratory animals. The toxin has not been determined. In the United States, some other goldenrods (*Solidago* spp.) were shown to be poisonous. The presence of a fungal rust on the plants was implicated in the poisoning (Beath et al. 1953, Kingsbury 1964).

References:

Beath, O. A., Gilbert, C. S., Eppson, H. F., Rosenfeld, I. 1953. Poisonous plants and livestock poisoning. Wyo. Agric. Exp. Stn. Bull., 324. 94 pp.

Kingsbury, J. M. 1964. Poisonous plants of the United States and Canada. Prentice-Hall Inc., Englewood Cliffs, N.J., USA. 626 pp.

Nomenclature:

Scientific Name: *Solidago mollis* Bartl.

Vernacular name(s): velvety goldenrod

Scientific family name: *Compositae*

Vernacular family name: composite

Go to ITIS^{*ca} for more taxonomic information on: [Solidago mollis](#)

References:

Agriculture Quebec. 1975. Noms des maladies des plantes du Canada/ Names of plant diseases in Canada. , Quebec City, Que.,

Canada. 288 pp.

Alex, J. F., Cayouette, R., Mulligan, G. A. 1980. Common and botanical names of weeds in Canada/Noms populaire et scientifiques des plantes nuisibles du Canada. Revised. Agric. Can. Publ., Ottawa, Ont., Canada. 132 pp.

Bailey, L. H., Bailey, E. Z. 1976. Hortus third. Revised. MacMillan, New York, N.Y., USA. 1290 pp.

Scoggan, H. J. 1978, 1979. The flora of Canada. Nat. Mus. Nat. Sci. (Ottawa) Publ. Bot. 7(1)-7(4). 1711 pp.

Van Wijk, H. L. 1911. A dictionary of plant names. Martinus Nijhoff, The Hague, The Netherlands. 1444 pp.

Victorin, M. 1964. Flore Laurentienne. 2nd ed. Univ. Montreal, Montreal, Que., Canada. 952 pp.

Geographic Information

Alberta
Manitoba
Saskatchewan

References:

Bailey, L. H., Bailey, E. Z. 1976. Hortus third. Revised. MacMillan, New York, N.Y., USA. 1290 pp.

Boivin, B. 1966, 1967. Énumération des plantes du Canada. Provencheria 6. Nat. Can. (Que.) 93: 253-274; 371-437; 583-646; 989-1063. 94: 131-157; 471-528; 625-655.

Image or illustration

Solidago mollis:

Images: images.google.com

Toxic parts:

leaves
stems

References:

Beath, O. A., Gilbert, C. S., Eppson, H. F., Rosenfeld, I. 1953. Poisonous plants and livestock poisoning. Wyo. Agric. Exp. Stn. Bull., 324. 94 pp.

Toxic plant chemicals:

unknown chemical

References:

Beath, O. A., Gilbert, C. S., Eppson, H. F., Rosenfeld, I. 1953. Poisonous plants and livestock poisoning. Wyo. Agric. Exp. Stn. Bull., 324. 94 pp.

Animals/Human Poisoning:

Note: When an animal is listed without additional information, the literature (as of 1993) contained no detailed explanation.

Cattle

General symptoms of poisoning:

[weight loss](#)

Notes on poisoning:

Administering small amounts of the resin to calves caused a loss of body weight. The same resin given to small laboratory animals caused severe weight loss (Beath et al. 1953).

References:

Beath, O. A., Gilbert, C. S., Eppson, H. F., Rosenfeld, I. 1953. Poisonous plants and livestock poisoning. Wyo. Agric. Exp. Stn. Bull., 324. 94 pp.

Sheep

General symptoms of poisoning:

[breathing, rapid](#)

[death](#)

[nausea](#)

[vomiting](#)

Notes on poisoning:

Doses of 0.45 kg of partly dried plant material given 4 h apart caused death in 12 h. Symptoms included nausea, vomiting, distress, and accelerated respiration. Small amounts of the corrosive resin caused a loss of body weight (Beath et al. 1953).

References:

Beath, O. A., Gilbert, C. S., Eppson, H. F., Rosenfeld, I. 1953.
Poisonous plants and livestock poisoning. Wyo. Agric. Exp. Stn.
Bull., 324. 94 pp.

[Another search?](#)

[Français](#) | [Contact Us](#) | [Help](#) | [Search](#) | [Canada site](#)

[Coming Events](#) | [About CBIF](#) | [Links](#) | [Reports and Publications](#) |

[Home](#)

Date modified: 2003-02-06

[Important Notices](#)



Français	Contact us	Help	Search	Canada site
Coming events	About CBIF	Links	Reports and publications	Home

Canadian Biodiversity Information Facility



Notes on poisoning: *Sorghum bicolor*

[Introduction](#)[Interactive](#)[All poisonous plants by Botanical name](#)[All poisonous plants by Common name](#)[Important WWW Poisonous Plants sites](#)

General poisoning notes:

Sorghum (*Sorghum bicolor*) is a cultivated plant grown as ensilage, as poultry feed, or sometimes as broomcorn, for its long, flexible, high-quality broom fibers. Sorghum can contain a cyanogenic glycoside that can produce HCN during times of stress or if damaged by frost or mastication. Modern sorghums have been developed for their low HCN potential and are normally safe. Sorghum can also accumulate toxic levels of nitrates. Cattle and rarely horses have been poisoned (Kingsbury 1964, Gray et al. 1968, Clay et al. 1976).

References:

- Cheeke, P. R., Shull, L. R. 1985. Natural toxicants in feeds and poisonous plants. AVI Publishing Company, Inc., Westport, Conn., USA. 492 pp.
- Clay, B. R., Edwards, W. C., Peterson, D. R. 1976. Toxic nitrate accumulation in the sorghums. *Bovine Pract.*, 11: 28-32.
- Fuller, T. C., McClintock, E. 1986. Poisonous plants of California. Univ. California Press, Berkeley, Calif., USA. 432 pp.
- Gray, E., Rice, J. S., Wattenbarger, D., Benson, J. A., Hester, A. J., Loyd, R. C., Greene, B. M. 1968. Hydrocyanic acid potential of *Sorghum* plants grown in Tennessee. *Tenn. Agric. Exp. Stn. Bull.*, 445. 48 pp.
- Kingsbury, J. M. 1964. Poisonous plants of the United States and Canada. Prentice-Hall Inc., Englewood Cliffs, N.J., USA. 626 pp.
- Morgan, S. E., Johnson, B., Brewer, B., Walker, J. 1990. Sorghum cystitis ataxia syndrome in horses. *Vet. Hum. Toxicol.*, 32: 582.

Nomenclature:

Scientific Name: *Sorghum bicolor* (L.) Moench

Vernacular name(s): Sorghum

Scientific family name: *Gramineae*

Vernacular family name: grass

Go to ITIS^{*ca} for more taxonomic information on: [Sorghum bicolor](#)

References:

Agriculture Quebec. 1975. Noms des maladies des plantes du Canada/ Names of plant diseases in Canada. , Quebec City, Que., Canada. 288 pp.

Alex, J. F., Cayouette, R., Mulligan, G. A. 1980. Common and botanical names of weeds in Canada/Noms populaire et scientifiques des plantes nuisibles du Canada. Revised. Agric. Can. Publ., Ottawa, Ont., Canada. 132 pp.

Bailey, L. H., Bailey, E. Z. 1976. Hortus third. Revised. MacMillan, New York, N.Y., USA. 1290 pp.

Scoggan, H. J. 1978, 1979. The flora of Canada. Nat. Mus. Nat. Sci. (Ottawa) Publ. Bot. 7(1)-7(4). 1711 pp.

Van Wijk, H. L. 1911. A dictionary of plant names. Martinus Nijhoff, The Hague, The Netherlands. 1444 pp.

Victorin, M. 1964. Flore Laurentienne. 2nd ed. Univ. Montreal, Montreal, Que., Canada. 952 pp.

Geographic Information

Plant or plant parts used in or around the home.

References:

Bailey, L. H., Bailey, E. Z. 1976. Hortus third. Revised. MacMillan, New York, N.Y., USA. 1290 pp.

Boivin, B. 1966, 1967. Énumération des plantes du Canada. Provencheria 6. Nat. Can. (Que.) 93: 253-274; 371-437; 583-646; 989-1063. 94: 131-157; 471-528; 625-655.

Image or illustration

Sorghum bicolor:

Images: images.google.com

Notes on Poisonous plant parts:

Damaged leaves and stems can release HCN. Since HCN is volatile, silage made from this plant is generally safe (Cheeke and Schull 1985).

Toxic parts:

leaves
stems

References:

Cheeke, P. R., Shull, L. R. 1985. Natural toxicants in feeds and poisonous plants. AVI Publishing Company, Inc., Westport, Conn., USA. 492 pp.

Notes on Toxic plant chemicals:

In the presence of plant enzymes released by damage, a cyanogenic glycoside, dhurrin, produces hydrocyanic acid (HCN) in the animal's system. Levels of cyanide at 250 mg/100 g of plant tissue have been measured after damage. A lethal dose of cyanide is 0.5-3 mg/kg of body weight. Some sorghum plants have been measured with levels 10 times a lethal of HCN (Cheeke and Schull 1985).

Toxic plant chemicals:

dhurrin

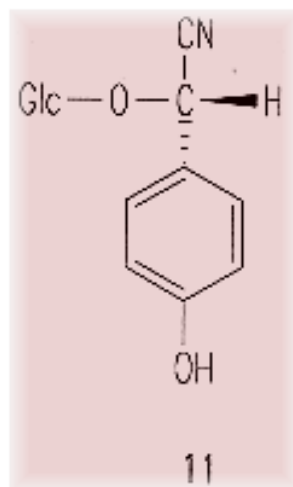

nitrate

Chemical diagram(s) are courtesy of [Ruth McDiarmid](#),

Biochemistry Technician, Kamloops Range Station, Agriculture and Agri-Food Canada, Kamloops, British Columbia, Canada.

References:

Cheeke, P. R., Shull, L. R. 1985. Natural toxicants in feeds and poisonous plants. AVI Publishing Company, Inc., Westport, Conn., USA. 492 pp.

Fuller, T. C., McClintock, E. 1986. Poisonous plants of California. Univ. California Press, Berkeley, Calif., USA. 432 pp.

Animals/Human Poisoning:

Note: When an animal is listed without additional information, the literature (as of 1993) contained no detailed explanation.

Cattle

General symptoms of poisoning:

[abortion](#)

[coma](#)

[convulsions](#)

[cyanosis](#)

[death](#)

[dyspnea](#)

[gait, staggering](#)

[methemoglobinemia](#)

References:

Cheeke, P. R., Shull, L. R. 1985. Natural toxicants in feeds and poisonous plants. AVI Publishing Company, Inc., Westport, Conn., USA. 492 pp.

Clay, B. R., Edwards, W. C., Peterson, D. R. 1976. Toxic nitrate accumulation in the sorghums. *Bovine Pract.*, 11: 28-32.

Gray, E., Rice, J. S., Wattenbarger, D., Benson, J. A., Hester, A. J., Loyd, R. C., Greene, B. M. 1968. Hydrocyanic acid potential of *Sorghum* plants grown in Tennessee. *Tenn. Agric. Exp. Stn. Bull.*, 445. 48 pp.

Kingsbury, J. M. 1964. Poisonous plants of the United States and Canada. Prentice-Hall Inc., Englewood Cliffs, N.J., USA. 626 pp.

Horses

General symptoms of poisoning:

[abortion](#)

[incoordination](#)

[urinary incontinence](#)

Notes on poisoning:

In the United States sublethal doses of HCN caused degeneration of the lumbar and sacral segments of the spinal cord in horses after they ingested sorghum. Large quantities of sediment occur in the urine. If forced to move, affected horses sway from side to side and dribble urine, a condition known as sorghum cystitis ataxia. Other symptoms include an extremely enlarged bladder and patchy encephalomalacia with axonal degeneration. Damage is permanent. When fed sorghums during early pregnancy, mares have aborted. The causal toxin has not been determined yet (Fuller and McClintock 1986, Morgan et al. 1990).

References:

Fuller, T. C., McClintock, E. 1986. Poisonous plants of California. Univ. California Press, Berkeley, Calif., USA. 432 pp.

Morgan, S. E., Johnson, B., Brewer, B., Walker, J. 1990. Sorghum cystitis ataxia syndrome in horses. *Vet. Hum. Toxicol.*, 32: 582.

[Another search?](#)

[Français](#) | [Contact Us](#) | [Help](#) | [Search](#) | [Canada site](#)

[Coming Events](#) | [About CBIF](#) | [Links](#) | [Reports and Publications](#) | [Home](#)

Date modified: 2003-02-06

[Important Notices](#)



Français	Contact us	Help	Search	Canada site
Coming events	About CBIF	Links	Reports and publications	Home

Canadian Biodiversity Information Facility



Notes on poisoning: *Sorghum halepense*

[Introduction](#)[Interactive](#)[All poisonous plants by
Botanical name](#)[All poisonous plants by
Common name](#)[Important WWW Poisonous
Plants sites](#)

General poisoning notes:

Johnson grass (*Sorghum halepense*) is a naturalized herb found as a weed in only a few counties of southwestern Ontario. This plant can produce toxic quantities of HCN if it is damaged through frost, mastication, or water stress. Johnson grass can also accumulate toxic amounts of nitrate under certain circumstances. Cattle and a horse were poisoned after ingesting Johnson grass. Plants are spread from rhizomes but susceptibility to severe frost has limited the plants to a few counties in southwestern Ontario. The grass is found in fields and field edges. Toxicity is not likely, but ingesting large quantities of Johnson grass can cause problems (Gray et al. 1968, Clay et al. 1976, Warwick and Black 1983).

References:

Clay, B. R., Edwards, W. C., Peterson, D. R. 1976. Toxic nitrate accumulation in the sorghums. *Bovine Pract.*, 11: 28-32.

Gray, E., Rice, J. S., Wattenbarger, D., Benson, J. A., Hester, A. J., Loyd, R. C., Greene, B. M. 1968. Hydrocyanic acid potential of *Sorghum* plants grown in Tennessee. *Tenn. Agric. Exp. Stn. Bull.*, 445. 48 pp.

Reynard, G. B., Norton, J. B. 1942. Poisonous plants of Maryland in relation to livestock. *Univ. MD. Agric. Exp. Stn. Bull.*, A10. 312 pp.

Warwick, S. I., Black, L. D. 1983. The biology of Canadian weeds. 61. *Sorghum halepense* (L.) Pers. *Can. J. Plant Sci.*, 63: 997-1014.

Nomenclature:

Scientific Name: *Sorghum halepense* (L.) Pers.

Vernacular name(s): Johnson grass

Scientific family name: *Gramineae*

Vernacular family name: grass

Go to ITIS^{*ca} for more taxonomic information on: [Sorghum halepense](#)

References:

Agriculture Quebec. 1975. Noms des maladies des plantes du Canada/ Names of plant diseases in Canada. , Quebec City, Que., Canada. 288 pp.

Alex, J. F., Cayouette, R., Mulligan, G. A. 1980. Common and botanical names of weeds in Canada/Noms populaire et scientifiques des plantes nuisibles du Canada. Revised. Agric. Can. Publ., Ottawa, Ont., Canada. 132 pp.

Bailey, L. H., Bailey, E. Z. 1976. Hortus third. Revised. MacMillan, New York, N.Y., USA. 1290 pp.

Scoggan, H. J. 1978, 1979. The flora of Canada. Nat. Mus. Nat. Sci. (Ottawa) Publ. Bot. 7(1)-7(4). 1711 pp.

Van Wijk, H. L. 1911. A dictionary of plant names. Martinus Nijhoff, The Hague, The Netherlands. 1444 pp.

Victorin, M. 1964. Flore Laurentienne. 2nd ed. Univ. Montreal, Montreal, Que., Canada. 952 pp.

Geographic Information

Ontario

References:

Bailey, L. H., Bailey, E. Z. 1976. Hortus third. Revised. MacMillan, New York, N.Y., USA. 1290 pp.

Boivin, B. 1966, 1967. Énumération des plantes du Canada. Provencheria 6. Nat. Can. (Que.) 93: 253-274; 371-437; 583-646; 989-1063. 94: 131-157; 471-528; 625-655.

Image or illustration

Sorghum halepense:

Images: images.google.com

Notes on Poisonous plant parts:

The hydrocyanic potential of Johnson grass is largest during early growth of the plant (Gray et al. 1968).

Toxic parts:

leaves

stems

References:

Gray, E., Rice, J. S., Wattenbarger, D., Benson, J. A., Hester, A. J., Loyd, R. C., Greene, B. M. 1968. Hydrocyanic acid potential of *Sorghum* plants grown in Tennessee. *Tenn. Agric. Exp. Stn. Bull.*, 445. 48 pp.

Sharma, R. P., Salunkhe, D. K. 1989. *Solanum* glycoalkaloids. Pages 179-236 in Cheeke, P. R., ed. *Toxicants of plant origin. Vol. I. Alkaloids.* CRC Press, Inc., Boca Raton, Fla., USA. 335 pp.

Notes on Toxic plant chemicals:

A cyanogenic glycoside, dhurrin, is found in Johnson grass. After the plant has been damaged by mastication, plant enzymes convert the glycoside to other chemicals, including HCN. Cyanide, which is lethal, is released into the animal's system. Nitrates can accumulate under some circumstances. Nitrate poisoning has occurred in cattle (Gray et al. 1968, Clay et al. 1976).

Toxic plant chemicals:

chaconine

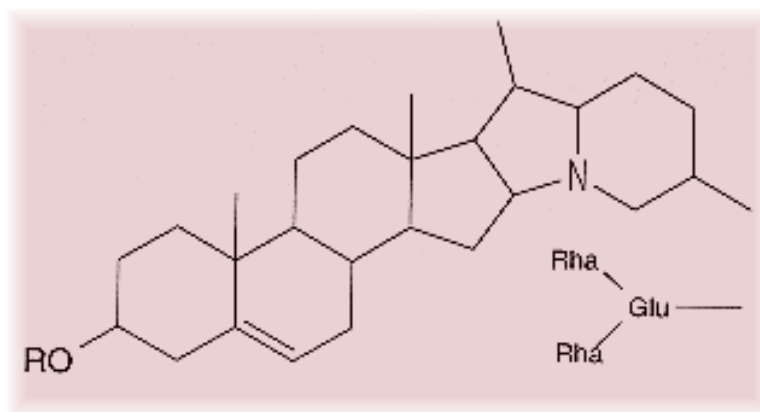

dhurrin

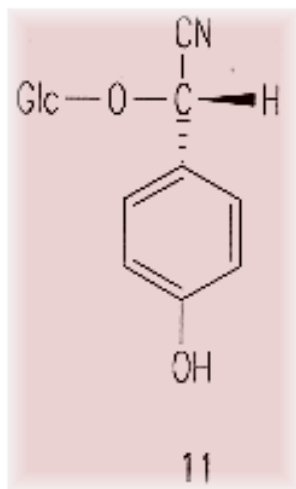

nitrate

Chemical diagram(s) are courtesy of [Ruth McDiarmid](#), Biochemistry Technician, Kamloops Range Station, Agriculture and Agri-Food Canada, Kamloops, British Columbia, Canada.

References:

Clay, B. R., Edwards, W. C., Peterson, D. R. 1976. Toxic nitrate accumulation in the sorghums. *Bovine Pract.*, 11: 28-32.

Gray, E., Rice, J. S., Wattenbarger, D., Benson, J. A., Hester, A. J., Loyd, R. C., Greene, B. M. 1968. Hydrocyanic acid potential of *Sorghum* plants grown in Tennessee. *Tenn. Agric. Exp. Stn. Bull.*, 445. 48 pp.

Sharma, R. P., Salunkhe, D. K. 1989. *Solanum* glycoalkaloids. Pages 179-236 in Cheeke, P. R., ed. *Toxicants of plant origin*. Vol. I. Alkaloids. CRC Press, Inc., Boca Raton, Fla., USA. 335 pp.

Animals/Human Poisoning:

Note: When an animal is listed without additional information, the literature (as of 1993) contained no detailed explanation.

Cattle

General symptoms of poisoning:

[abortion](#)

[breathing, rapid](#)

[death](#)

[death by asphyxiation](#)

[gait, staggering](#)

[methemoglobinemia](#)

[mouth, frothing of](#)

Notes on poisoning:

Johnson grass can accumulate toxic levels of nitrates, which leads to methemoglobinemia. In severe cases, death can occur 4-6 h after ingestion. Three to five days after acute poisoning, surviving pregnant animals may abort (Clay et al. 1976). Dhurrin, a cyanogenic glycoside, is found in plant material. When the plant is damaged by frost, mastication, or water stress, HCN can be released and cyanide can enter the animal's system. Symptoms are the result of cytotoxic hypoxia, leading in severe cases to death from asphyxiation. Other symptoms include increased respiration, irregular pulse, frothing at the mouth, and staggering (Gray et al. 1968, Fuller and McClintock 1986).

References:

Clay, B. R., Edwards, W. C., Peterson, D. R. 1976. Toxic nitrate accumulation in the sorghums. *Bovine Pract.*, 11: 28-32.

Gray, E., Rice, J. S., Wattenbarger, D., Benson, J. A., Hester, A. J., Loyd, R. C., Greene, B. M. 1968. Hydrocyanic acid potential of *Sorghum* plants grown in Tennessee. *Tenn. Agric. Exp. Stn. Bull.*, 445. 48 pp.

Horses

General symptoms of poisoning:

[death by asphyxiation](#)

Notes on poisoning:

In Maryland a horse died from cyanide poisoning after ingesting Johnson grass (Reynard and Norton 1942).

References:

Reynard, G. B., Norton, J. B. 1942. Poisonous plants of Maryland in relation to livestock. *Univ. MD. Agric. Exp. Stn. Bull.*, A10. 312 pp.

[Another search?](#)

[Français](#) | [Contact Us](#) | [Help](#) | [Search](#) | [Canada site](#)

[Coming Events](#) | [About CBIF](#) | [Links](#) | [Reports and Publications](#) | [Home](#)

Date modified: 2003-02-06

[Important Notices](#)



Français	Contact us	Help	Search	Canada site
Coming events	About CBIF	Links	Reports and publications	Home

Canadian Biodiversity Information Facility



Notes on poisoning: *Sorghum sudanense*

[Introduction](#)[Interactive](#)[All poisonous plants by Botanical name](#)[All poisonous plants by Common name](#)[Important WWW Poisonous Plants sites](#)

General poisoning notes:

Sudan grass (*Sorghum sudanense*) is a cultivated forage that is planted as a late-season emergency forage crop and is either pastured or cut for green feed. Some naturalized plants are occasionally found in waste places. Sudan grass can have an HCN potential after damage to the plant. It can also accumulate toxic quantities of nitrates. These problems can be avoided by proper management. Cattle are the main livestock animals that have been poisoned. In one case in California, sheep became photosensitive after ingesting Sudan grass pasture for several days. The photodynamic pigment was not determined (Gray et al. 1968, Clay et al. 1976, Fuller and McClintock 1986).

References:

- Clay, B. R., Edwards, W. C., Peterson, D. R. 1976. Toxic nitrate accumulation in the sorghums. *Bovine Pract.*, 11: 28-32.
- Fuller, T. C., McClintock, E. 1986. *Poisonous plants of California*. Univ. California Press, Berkeley, Calif., USA. 432 pp.
- Gray, E., Rice, J. S., Wattenbarger, D., Benson, J. A., Hester, A. J., Loyd, R. C., Greene, B. M. 1968. Hydrocyanic acid potential of *Sorghum* plants grown in Tennessee. *Tenn. Agric. Exp. Stn. Bull.*, 445. 48 pp.

Nomenclature:

Scientific Name: *Sorghum sudanense* (Piper) Stapf

Vernacular name(s): Sudan grass

Scientific family name: *Gramineae*

Vernacular family name: grass

Go to ITIS^{*ca} for more taxonomic information on: [Sorghum sudanense](#)

References:

Agriculture Quebec. 1975. Noms des maladies des plantes du Canada/ Names of plant diseases in Canada. , Quebec City, Que., Canada. 288 pp.

Alex, J. F., Cayouette, R., Mulligan, G. A. 1980. Common and botanical names of weeds in Canada/Noms populaire et scientifiques des plantes nuisibles du Canada. Revised. Agric. Can. Publ., Ottawa, Ont., Canada. 132 pp.

Bailey, L. H., Bailey, E. Z. 1976. Hortus third. Revised. MacMillan, New York, N.Y., USA. 1290 pp.

Scoggan, H. J. 1978, 1979. The flora of Canada. Nat. Mus. Nat. Sci. (Ottawa) Publ. Bot. 7(1)-7(4). 1711 pp.

Van Wijk, H. L. 1911. A dictionary of plant names. Martinus Nijhoff, The Hague, The Netherlands. 1444 pp.

Victorin, M. 1964. Flore Laurentienne. 2nd ed. Univ. Montreal, Montreal, Que., Canada. 952 pp.

Geographic Information

Ontario

Quebec

References:

Bailey, L. H., Bailey, E. Z. 1976. Hortus third. Revised. MacMillan, New York, N.Y., USA. 1290 pp.

Boivin, B. 1966, 1967. Énumération des plantes du Canada. Provencheria 6. Nat. Can. (Que.) 93: 253-274; 371-437; 583-646; 989-1063. 94: 131-157; 471-528; 625-655.

Image or illustration

Sorghum sudanense:

Images: images.google.com

Notes on Poisonous plant parts:

The HCN potential is greatest in younger plants. Damage to the plant material is required for release of the volatile HCN (Gray et al. 1968).

Toxic parts:

leaves
stems

References:

Clay, B. R., Edwards, W. C., Peterson, D. R. 1976. Toxic nitrate accumulation in the sorghums. *Bovine Pract.*, 11: 28-32.

Gray, E., Rice, J. S., Wattenbarger, D., Benson, J. A., Hester, A. J., Loyd, R. C., Greene, B. M. 1968. Hydrocyanic acid potential of *Sorghum* plants grown in Tennessee. *Tenn. Agric. Exp. Stn. Bull.*, 445. 48 pp.

Notes on Toxic plant chemicals:

Sudan grass contains a cyanogenic glycoside, dhurrin, that can release HCN after plant damage such as frost, mastication, and water stress and allows plant enzymes to alter the glycoside. If enough HCN is released into the animal's system, cyanide leads to cytotoxic hypoxia, which can result in death by asphyxiation. Nitrates can also accumulate to toxic levels in Sudan grass. A case of photosensitization occurred in sheep. A photodynamic pigment may be contained in Sudan grass (Gray et al. 1968, Clay et al. 1976, Fuller and McClintock 1986).

Toxic plant chemicals:

dhurrin

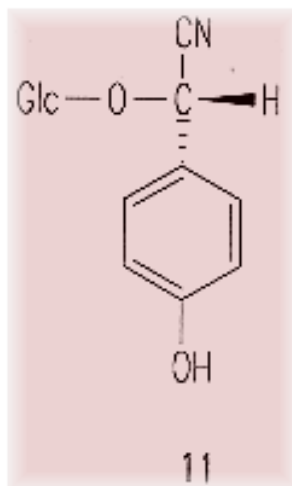

nitrate

Chemical diagram(s) are courtesy of [Ruth McDiarmid](#), Biochemistry Technician, Kamloops Range Station, Agriculture and Agri-Food Canada, Kamloops, British Columbia, Canada.

References:

Clay, B. R., Edwards, W. C., Peterson, D. R. 1976. Toxic nitrate accumulation in the sorghums. *Bovine Pract.*, 11: 28-32.

Fuller, T. C., McClintock, E. 1986. *Poisonous plants of California*. Univ. California Press, Berkeley, Calif., USA. 432 pp.

Gray, E., Rice, J. S., Wattenbarger, D., Benson, J. A., Hester, A. J., Loyd, R. C., Greene, B. M. 1968. Hydrocyanic acid potential of *Sorghum* plants grown in Tennessee. *Tenn. Agric. Exp. Stn. Bull.*, 445. 48 pp.

Animals/Human Poisoning:

Note: When an animal is listed without additional information, the literature (as of 1993) contained no detailed explanation.

Cattle

General symptoms of poisoning:

[abortion](#)

[breathing, rapid](#)

[death](#)

[death by asphyxiation](#)

[gait, staggering](#)

[methemoglobinemia](#)

[mouth, frothing of](#)

Notes on poisoning:

The release of cyanide into the animal's system leads to cytotoxic hypoxia. In severe cases, death has resulted from asphyxiation. Other symptoms include increased breathing rate, irregular pulse, staggering, and frothing at the mouth. Nitrate poisoning causes methemoglobinemia, which can result in death. From 3-5 days after surviving acute poisoning, pregnant cows may abort (Gray et al. 1968, Clay et al. 1976).

References:

Clay, B. R., Edwards, W. C., Peterson, D. R. 1976. Toxic nitrate accumulation in the sorghums. *Bovine Pract.*, 11: 28-32.

Gray, E., Rice, J. S., Wattenbarger, D., Benson, J. A., Hester, A. J., Loyd, R. C., Greene, B. M. 1968. Hydrocyanic acid potential of *Sorghum* plants grown in Tennessee. *Tenn. Agric. Exp. Stn. Bull.*, 445. 48 pp.

Sheep

General symptoms of poisoning:

[breathing, labored](#)

[erythema](#)

[itchiness](#)

[nasal discharge](#)

References:

Fuller, T. C., McClintock, E. 1986. Poisonous plants of California. Univ. California Press, Berkeley, Calif., USA. 432 pp.

[Another search?](#)

[Français](#) | [Contact Us](#) | [Help](#) | [Search](#) | [Canada site](#)

[Coming Events](#) | [About CBIF](#) | [Links](#) | [Reports and Publications](#) |

[Home](#)

Date modified: 2003-02-06

[Important Notices](#)



Français	Contact us	Help	Search	Canada site
Coming events	About CBIF	Links	Reports and publications	Home

Canadian Biodiversity Information Facility



Notes on poisoning: *Suckleya suckleyana*

[Introduction](#)[Interactive](#)[All poisonous plants by Botanical name](#)[All poisonous plants by Common name](#)[Important WWW Poisonous Plants sites](#)

General poisoning notes:

Poison suckleya (*Suckleya suckleyana*) is a native herb found in the southern Saskatchewan and southern Alberta. This plant has caused losses of cattle and possibly sheep in the western United States. The plant is not normally ingested, but in times of scarce forage, it may be eaten in sufficient amounts to cause death. It contains an unknown cyanogenic glycoside that upon ingestion of sufficient quantity can release cyanide in the animal system, resulting in cytotoxic hypoxia. Experiments with cattle, sheep, laboratory rabbits, and guinea pigs have shown the cyanogenic potential of poison suckleya. This plant is not usually ingested by animals and is not common in the southern prairies. However, poisoning can occur (Thorp and Deem 1938, Berry and Gonzales 1986).

References:

Thorp, F., Deem, A. W. 1938. *Suckleya suckleyana*, a poisonous plant. J. Am. Vet. Med. Assoc., 47: 192-197.

Nomenclature:

Scientific Name: *Suckleya suckleyana* (Torr.) Rydb.

Vernacular name(s): poison suckleya

Scientific family name: *Chenopodiaceae*

Vernacular family name: goosefoot

Go to ITIS^{*ca} for more taxonomic information on: [Suckleya suckleyana](#)

References:

Agriculture Quebec. 1975. Noms des maladies des plantes du Canada/ Names of plant diseases in Canada. , Quebec City, Que., Canada. 288 pp.

Alex, J. F., Cayouette, R., Mulligan, G. A. 1980. Common and botanical names of weeds in Canada/Noms populaire et scientifiques des plantes nuisibles du Canada. Revised. Agric. Can. Publ., Ottawa, Ont., Canada. 132 pp.

Bailey, L. H., Bailey, E. Z. 1976. Hortus third. Revised. MacMillan, New York, N.Y., USA. 1290 pp.

Scoggan, H. J. 1978, 1979. The flora of Canada. Nat. Mus. Nat. Sci. (Ottawa) Publ. Bot. 7(1)-7(4). 1711 pp.

Van Wijk, H. L. 1911. A dictionary of plant names. Martinus Nijhoff, The Hague, The Netherlands. 1444 pp.

Victorin, M. 1964. Flore Laurentienne. 2nd ed. Univ. Montreal, Montreal, Que., Canada. 952 pp.

Geographic Information

Alberta

British Columbia

References:

Bailey, L. H., Bailey, E. Z. 1976. Hortus third. Revised. MacMillan, New York, N.Y., USA. 1290 pp.

Boivin, B. 1966, 1967. Énumération des plantes du Canada. Provencheria 6. Nat. Can. (Que.) 93: 253-274; 371-437; 583-646; 989-1063. 94: 131-157; 471-528; 625-655.

Image or illustration

Suckleya suckleyana:

Images: images.google.com

Toxic parts:

leaves

stems

References:

Berry, T. J., Gonzales, P. 1986. Do your cattle-owning clients know about this poisonous range plant? Vet. Med., 81:

1055-1056.

Notes on Toxic plant chemicals:

An unknown cyanogenic glycoside is found in poison suckleya. Upon ingestion, cyanide is released in the animal's system. The cyanide potential of this plant was measured at 0.01-0.24%. After fasting, sheep showed transitory symptoms, with forced feedings of large amounts of the plant containing 0.011% cyanide potential. Plant material measured at 0.0364% cyanide potential is lethal to cattle, guinea pigs, and sheep (Thorp and Deem 1938).

Toxic plant chemicals:

unknown chemical

References:

Berry, T. J., Gonzales, P. 1986. Do your cattle-owning clients know about this poisonous range plant? *Vet. Med.*, 81: 1055-1056.

Thorp, F., Deem, A. W. 1938. *Suckleya suckleyana*, a poisonous plant. *J. Am. Vet. Med. Assoc.*, 47: 192-197.

Animals/Human Poisoning:

Note: When an animal is listed without additional information, the literature (as of 1993) contained no detailed explanation.

Cattle

General symptoms of poisoning:

[breathing, labored](#)

[cyanosis](#)

[death by asphyxiation](#)

[gait, staggering](#)

[muscle twitching](#)

Notes on poisoning:

Ingesting abundant plant material causes cyanide to be released into cattle. Symptoms include glassy eyes, muscular twitching, dribbling urine, staggering, cyanosis, fast and weak heart, labored breathing, spasms, and death by asphyxiation. Postmortem findings showed black-colored blood, congestion of the mucous membrane on the folds of the abomasum and initial part of the duodenum, and a distended bladder. Treatment includes

intravenous sodium nitrate and sodium thiosulfate, with a laxative to remove plant material from the rumen (Thorpe and Deem 1938, Berry and Gonzales 1986).

References:

Thorp, F., Deem, A. W. 1938. *Suckleya suckleyana*, a poisonous plant. J. Am. Vet. Med. Assoc., 47: 192-197.

Sheep

General symptoms of poisoning:

[collapse](#)

[death by asphyxiation](#)

[dyspnea](#)

[heart rate, slow](#)

[salivation](#)

Notes on poisoning:

On the rangelands of the western United States, sheep were believed to have died as a result of ingesting poison suckleya. Sheep were experimentally poisoned after they were force-fed plant material. Sickness and death resulted. Symptoms were similar to those of cattle that died from cytotoxic hypoxia (Thorpe and Deem 1938).

References:

Thorp, F., Deem, A. W. 1938. *Suckleya suckleyana*, a poisonous plant. J. Am. Vet. Med. Assoc., 47: 192-197.

[Another search?](#)

[Français](#) | [Contact Us](#) | [Help](#) | [Search](#) | [Canada site](#)

[Coming Events](#) | [About CBIF](#) | [Links](#) | [Reports and Publications](#) |

[Home](#)

Date modified: 2003-02-06

[Important Notices](#)



Français	Contact us	Help	Search	Canada site
Coming events	About CBIF	Links	Reports and publications	Home



Notes on poisoning: *Symphoricarpos albus*

[Introduction](#)

[Interactive](#)

[All poisonous plants by Botanical name](#)

[All poisonous plants by Common name](#)

[Important WWW Poisonous Plants sites](#)



General poisoning notes:

Thin-leaved snowberry (*Symphoricarpos albus*) is a native shrub found throughout much of Canada in woods and open slopes. The plant is also used as an ornamental shrub in many areas. The white berries contain the isoquinoline alkaloid chelidone, as well as other alkaloids. Ingesting the berries causes mild symptoms of vomiting, dizziness, and slight sedation in children. The risk of severe poisoning does not appear great because of vomiting that occurs after ingestion. Children should be discouraged from eating the attractive white fruit (Lewis 1979, Lampe and McCann 1985).

References:

Lampe, K. F., McCann, M. A. 1985. AMA Handbook of poisonous and injurious plants. American Medical Assoc. Chicago, Ill., USA. 432 pp.

Lewis, W. H. 1979. Snowberry (*Symphoricarpos*) poisoning in children. J. Am. Med. Assoc., 242: 2663.

Turner, N. J., Szczawinski, A. F. 1991. Common poisonous plants and mushrooms of North America. Timber Press, Portland, Oreg., USA. 311 pp.

Nomenclature:

Scientific Name: *Symphoricarpos albus* (L.) Blake

Vernacular name(s): thin-leaved snowberry

Scientific family name: *Caprifoliaceae*

Vernacular family name: honeysuckle

Go to ITIS*^{ca} for more taxonomic information on: [Symphoricarpos albus](#)

References:

Agriculture Quebec. 1975. Noms des maladies des plantes du Canada/ Names of plant diseases in Canada. , Quebec City, Que., Canada. 288 pp.

Alex, J. F., Cayouette, R., Mulligan, G. A. 1980. Common and botanical names of weeds in Canada/Noms populaire et scientifiques des plantes nuisibles du Canada. Revised. Agric. Can. Publ., Ottawa, Ont., Canada. 132 pp.

Bailey, L. H., Bailey, E. Z. 1976. Hortus third. Revised. MacMillan, New York, N.Y., USA. 1290 pp.

Scoggan, H. J. 1978, 1979. The flora of Canada. Nat. Mus. Nat. Sci. (Ottawa) Publ. Bot. 7(1)-7(4). 1711 pp.

Van Wijk, H. L. 1911. A dictionary of plant names. Martinus Nijhoff, The Hague, The Netherlands. 1444 pp.

Victorin, M. 1964. Flore Laurentienne. 2nd ed. Univ. Montreal, Montreal, Que., Canada. 952 pp.

Geographic Information

Alberta
British Columbia
Manitoba
New Brunswick
Northwest Territories
Nova Scotia
Ontario
Quebec
Saskatchewan

References:

Bailey, L. H., Bailey, E. Z. 1976. Hortus third. Revised. MacMillan, New York, N.Y., USA. 1290 pp.

Boivin, B. 1966, 1967. Énumération des plantes du Canada. Provencheria 6. Nat. Can. (Que.) 93: 253-274; 371-437; 583-646; 989-1063. 94: 131-157; 471-528; 625-655.

Image or illustration

Symphoricarpos albus:

Images: images.google.com

Toxic parts:

mature fruit

References:

Lewis, W. H. 1979. Snowberry (*Symphoricarpos*) poisoning in children. J. Am. Med. Assoc., 242: 2663.

Notes on Toxic plant chemicals:

An isoquinoline alkaloid, chelidonine, was found in the fruits of thin-leaved snowberry. This chemical is also found in greater celandine (*Chelidonium majus*), an unrelated plant (Lewis 1979).

Toxic plant chemicals:

chelidonine

References:

Lewis, W. H. 1979. Snowberry (*Symphoricarpos*) poisoning in children. J. Am. Med. Assoc., 242: 2663.

Animals/Human Poisoning:

Note: When an animal is listed without additional information, the literature (as of 1993) contained no detailed explanation.

Humans

General symptoms of poisoning:

[dizziness](#)

[vomiting](#)

Notes on poisoning:

Children who ingested the attractive white fruits experienced vomiting, dizziness, and mild sedation. Blood-stained urine was also reported (Lewis 1979, Cooper and Johnson 1984).

References:

Lewis, W. H. 1979. Snowberry (*Symphoricarpos*) poisoning in children. J. Am. Med. Assoc., 242: 2663.

Turner, N. J., Szczawinski, A. F. 1991. Common poisonous plants and mushrooms of North America. Timber Press, Portland, Oreg.,

USA. 311 pp.

[Another search?](#)

[Français](#) | [Contact Us](#) | [Help](#) | [Search](#) | [Canada site](#)

[Coming Events](#) | [About CBIF](#) | [Links](#) | [Reports and Publications](#) |

[Home](#)

Date modified: 2003-02-06

[Important Notices](#)



Français	Contact us	Help	Search	Canada site
Coming events	About CBIF	Links	Reports and publications	Home

Canadian Biodiversity Information Facility



Notes on poisoning: *Symphytum asperum*

[Introduction](#)

[Interactive](#)

[All poisonous plants by Botanical name](#)

[All poisonous plants by Common name](#)

[Important WWW Poisonous Plants sites](#)



General poisoning notes:

Prickly comfrey (*Symphytum asperum*) is a naturalized herb found in parts of southern Canada. The plant contains pyrrolizidine alkaloids, which can cause veno-occlusive symptoms leading to liver cirrhosis. The plant can also accumulate toxic amounts of nitrates. Animals do not normally eat the plant because of the bristly hairs on the leaves. However, swine given the plant as green fodder showed signs of nitrate poisoning. Long-term use of the plant as food could lead to liver dysfunction (Cooper and Huxtable 1984, Huxtable 1989).

References:

Cooper, M. R., Johnson, A. W. 1984. Poisonous plants in Britain and their effects on animals and man. Her Majesty's Stationery Office, London, England. 305 pp.

Huxtable, R. J. 1989. Human health implications of pyrrolizidine alkaloids and herbs containing them. Pages 41-86 in Cheeke, P. R., ed. Toxicants of plant origin. Vol. I. Alkaloids. CRC Press, Inc., Boca Raton, Fla., USA. 335 pp.

Nomenclature:

Scientific Name: *Symphytum asperum* Lepech.

Vernacular name(s): prickly comfrey

Scientific family name: *Boraginaceae*

Vernacular family name: borage

Go to ITIS^{*ca} for more taxonomic information on: [Symphytum asperum](#)

References:

Agriculture Quebec. 1975. Noms des maladies des plantes du Canada/ Names of plant diseases in Canada. , Quebec City, Que., Canada. 288 pp.

Alex, J. F., Cayouette, R., Mulligan, G. A. 1980. Common and botanical names of weeds in Canada/Noms populaire et scientifiques des plantes nuisibles du Canada. Revised. Agric. Can. Publ., Ottawa, Ont., Canada. 132 pp.

Bailey, L. H., Bailey, E. Z. 1976. Hortus third. Revised. MacMillan, New York, N.Y., USA. 1290 pp.

Scoggan, H. J. 1978, 1979. The flora of Canada. Nat. Mus. Nat. Sci. (Ottawa) Publ. Bot. 7(1)-7(4). 1711 pp.

Van Wijk, H. L. 1911. A dictionary of plant names. Martinus Nijhoff, The Hague, The Netherlands. 1444 pp.

Victorin, M. 1964. Flore Laurentienne. 2nd ed. Univ. Montreal, Montreal, Que., Canada. 952 pp.

Geographic Information

British Columbia

Manitoba

Nova Scotia

Ontario

Prince Edward Island

Quebec

References:

Bailey, L. H., Bailey, E. Z. 1976. Hortus third. Revised. MacMillan, New York, N.Y., USA. 1290 pp.

Boivin, B. 1966, 1967. Énumération des plantes du Canada. Provencheria 6. Nat. Can. (Que.) 93: 253-274; 371-437; 583-646; 989-1063. 94: 131-157; 471-528; 625-655.

Image or illustration

Symphytum asperum:

Images: images.google.com

Toxic parts:

all parts

leaves

roots

stems

References:

Cooper, M. R., Johnson, A. W. 1984. Poisonous plants in Britain and their effects on animals and man. Her Majesty's Stationery Office, London, England. 305 pp.

Huxtable, R. J. 1989. Human health implications of pyrrolizidine alkaloids and herbs containing them. Pages 41-86 in Cheeke, P. R., ed. Toxicants of plant origin. Vol. I. Alkaloids. CRC Press, Inc., Boca Raton, Fla., USA. 335 pp.

Notes on Toxic plant chemicals:

This plant contains pyrrolizidine alkaloids such as echimidine. These alkaloids cause veno-occlusive symptoms in animals. Total alkaloid content (as a percentage of dry weight) for fresh leaves is about 0.01% and for dry leaves, about 0.059%. Many members of the genus contain much higher concentrations of alkaloids in the roots (Huxtable 1989).

Toxic plant chemicals:

echimidine
nitrate

References:

Cooper, M. R., Johnson, A. W. 1984. Poisonous plants in Britain and their effects on animals and man. Her Majesty's Stationery Office, London, England. 305 pp.

Huxtable, R. J. 1989. Human health implications of pyrrolizidine alkaloids and herbs containing them. Pages 41-86 in Cheeke, P. R., ed. Toxicants of plant origin. Vol. I. Alkaloids. CRC Press, Inc., Boca Raton, Fla., USA. 335 pp.

Animals/Human Poisoning:

Note: When an animal is listed without additional information, the literature (as of 1993) contained no detailed explanation.

Swine

General symptoms of poisoning:

[breathing, labored](#)
[cyanosis](#)

[methemoglobinemia](#)

Notes on poisoning:

Prickly comfrey is not normally ingested by animals because of the bristly hairs on the leaves. This plant can accumulate nitrates. In Britain, swine were poisoned when given prickly comfrey as green fodder. Symptoms were typical for nitrate poisoning, including apathy, labored breathing, cyanosis, and methemoglobinemia (Cooper and Johnson 1984).

References:

Cooper, M. R., Johnson, A. W. 1984. Poisonous plants in Britain and their effects on animals and man. Her Majesty's Stationery Office, London, England. 305 pp.

[Another search?](#)

[Français](#) | [Contact Us](#) | [Help](#) | [Search](#) | [Canada site](#)

[Coming Events](#) | [About CBIF](#) | [Links](#) | [Reports and Publications](#) |

[Home](#)

Date modified: 2003-02-06

[Important Notices](#)



Français	Contact us	Help	Search	Canada site
Coming events	About CBIF	Links	Reports and publications	Home

Canadian Biodiversity Information Facility



Notes on poisoning: *Symphytum officinale*

[Introduction](#)[Interactive](#)[All poisonous plants by Botanical name](#)[All poisonous plants by Common name](#)[Important WWW Poisonous Plants sites](#)

General poisoning notes:

Common comfrey (*Symphytum officinale*) is an introduced and naturalized herb found on damp roadsides and waste places in many parts of Canada. This plant contains several pyrrolizidine alkaloids, which cause veno-occlusive symptoms, liver cirrhosis, and death. Humans have been affected after ingesting herbal teas and medicines. Rats have developed hepatocellular tumors after ingesting the alkaloid symphytine, found in common comfrey. Canadian health officials have sought to ban sale of some comfrey products. Animals normally do not ingest the plant because of the bristly hairs. Topical herbal preparations are not considered toxic because the alkaloids do not reach the liver (Steuart 1987, Huxtable 1989, Ridker and McDermott 1989). Russian comfrey (*Symphytum X uplandicum* Nym. [synonymy: *Symphytum peregrinum* Ledeb.]) has been grown in Canada in Lethbridge, Alta., and Vancouver Island, as a trial forage crop for livestock, but it was not found to be suitable. This plant may be available from some nursery seed suppliers. Russian comfrey also contains pyrrolizidine alkaloids and should not be taken internally as a herb remedy.

References:

- Huxtable, R. J. 1989. Human health implications of pyrrolizidine alkaloids and herbs containing them. Pages 41-86 in Cheeke, P. R., ed. Toxicants of plant origin. Vol. I. Alkaloids. CRC Press, Inc., Boca Raton, Fla., USA. 335 pp.
- Ridker, P. M., McDermott, W. V. 1989. Comfrey herb tea and hepatic veno-occlusive disease. *Lancet*, 1989: 657-658.
- Steuart, G. 1987. Growing alkaloid-free comfrey. *Herbs Spices Med. Plants*, 5(4): 9.

Nomenclature:

Scientific Name: *Symphytum officinale* L.

Vernacular name(s): common comfrey

Scientific family name: *Boraginaceae*

Vernacular family name: borage

Go to ITIS^{*ca} for more taxonomic information on: [Symphytum officinale](#)

References:

Agriculture Quebec. 1975. Noms des maladies des plantes du Canada/ Names of plant diseases in Canada. , Quebec City, Que., Canada. 288 pp.

Alex, J. F., Cayouette, R., Mulligan, G. A. 1980. Common and botanical names of weeds in Canada/Noms populaire et scientifiques des plantes nuisibles du Canada. Revised. Agric. Can. Publ., Ottawa, Ont., Canada. 132 pp.

Bailey, L. H., Bailey, E. Z. 1976. Hortus third. Revised. MacMillan, New York, N.Y., USA. 1290 pp.

Scoggan, H. J. 1978, 1979. The flora of Canada. Nat. Mus. Nat. Sci. (Ottawa) Publ. Bot. 7(1)-7(4). 1711 pp.

Van Wijk, H. L. 1911. A dictionary of plant names. Martinus Nijhoff, The Hague, The Netherlands. 1444 pp.

Victorin, M. 1964. Flore Laurentienne. 2nd ed. Univ. Montreal, Montreal, Que., Canada. 952 pp.

Geographic Information

Alberta
British Columbia
New Brunswick
Newfoundland
Ontario
Quebec

References:

Bailey, L. H., Bailey, E. Z. 1976. Hortus third. Revised. MacMillan, New York, N.Y., USA. 1290 pp.

Boivin, B. 1966, 1967. Énumération des plantes du Canada. Provencheria 6. Nat. Can. (Que.) 93: 253-274; 371-437; 583-646; 989-1063. 94: 131-157; 471-528; 625-655.

Image or illustration

Symphytum officinale:

Images: images.google.com

Notes on Poisonous plant parts:

The roots have greater concentrations of pyrrolizidine alkaloids than the leaves. Animals do not commonly ingest the plants because of the bristly leaves (Cooper and Johnson 1984, Huxtable 1989).

Toxic parts:

all parts
leaves
roots

References:

Cooper, M. R., Johnson, A. W. 1984. Poisonous plants in Britain and their effects on animals and man. Her Majesty's Stationery Office, London, England. 305 pp.

Huxtable, R. J. 1989. Human health implications of pyrrolizidine alkaloids and herbs containing them. Pages 41-86 in Cheeke, P. R., ed. Toxicants of plant origin. Vol. I. Alkaloids. CRC Press, Inc., Boca Raton, Fla., USA. 335 pp.

Notes on Toxic plant chemicals:

Common comfrey contains several pyrrolizidine alkaloids, including echimidine, heliosupine, lycopsamine, and symphytine. Alkaloids were found in the plant totalling 0.07% dry weight in roots and 0.062% in dry leaves, and 0.006% in fresh leaves. Two alkaloids found in common comfrey were shown to cause liver and bladder tumors in rats; the roots have more toxins than leaves. Some commercial products of roots and leaves sold as herbal teas and medicinal preparations have a total alkaloidal concentration of 270 mg/kg (leaves) and 2900 mg/kg (roots). Ingesting a cup of tea made from the roots may contain 8.5 mg of alkaloid, which is 26 mg per cup if the gelatinous residue is consumed. [Huxtable 1989].

Toxic plant chemicals:

echimidine

heliosupine
lycopsamine

References:

Huxtable, R. J. 1989. Human health implications of pyrrolizidine alkaloids and herbs containing them. Pages 41-86 in Cheeke, P. R., ed. Toxicants of plant origin. Vol. I. Alkaloids. CRC Press, Inc., Boca Raton, Fla., USA. 335 pp.

Animals/Human Poisoning:

Note: When an animal is listed without additional information, the literature (as of 1993) contained no detailed explanation.

Humans

General symptoms of poisoning:

[ascites](#)
[liver, cirrhosis of](#)

Notes on poisoning:

Ingesting pyrrolizidine alkaloids for several months leads to veno-occlusive problems and severe portal hypertension, which can lead to cirrhosis of the liver and death. Symptoms include ascites, edema, and reduced urinary output. Children are more susceptible than adults. In two cases, one woman was estimated to consume at least 85 mg of pyrrolizidine alkaloids from a herbal leaf preparation over 6 months; another woman consumed 512 mg over 6 months (comfrey-pepsin preparation) (Huxtable 1990). Ridker and McDermott (1989) note that pulmonary endothelial hyperplasia can also occur from direct exposure to these alkaloids. Rats have developed hepatocellular tumors because of the alkaloid symphytine.

References:

Ridker, P. M., McDermott, W. V. 1989. Comfrey herb tea and hepatic veno-occlusive disease. *Lancet*, 1989: 657-658.

[Another search?](#)

[Français](#) | [Contact Us](#) | [Help](#) | [Search](#) | [Canada site](#)

[Coming Events](#) | [About CBIF](#) | [Links](#) | [Reports and Publications](#) | [Home](#)

Date modified: 2003-02-06

[Important Notices](#)



Français	Contact us	Help	Search	Canada site
Coming events	About CBIF	Links	Reports and publications	Home

Canadian Biodiversity Information Facility



Notes on poisoning: *Symplocarpus foetidus*

[Introduction](#)[Interactive](#)[All poisonous plants by Botanical name](#)[All poisonous plants by Common name](#)[Important WWW Poisonous Plants sites](#)

General poisoning notes:

Skunk cabbage (*Symplocarpus foetidus*) is a robust native herb found in wet marshy areas in parts of eastern Canada. Ingesting the plant can cause intense pain and irritation in the mouth area after chewing the roots or leaves (Lampe and McCann 1985). No case reports of such irritation were found in the literature for humans or livestock.



References:

- Kingsbury, J. M. 1964. Poisonous plants of the United States and Canada. Prentice-Hall Inc., Englewood Cliffs, N.J., USA. 626 pp.
- Lampe, K. F., McCann, M. A. 1985. AMA Handbook of poisonous and injurious plants. American Medical Assoc. Chicago, Ill., USA. 432 pp.

Nomenclature:

Scientific Name: *Symplocarpus foetidus* (L.) Nutt.

Vernacular name(s): skunk cabbage

Scientific family name: *Araceae*

Vernacular family name: arum

Go to ITIS^{*ca} for more taxonomic information on: [Symplocarpus foetidus](#)

References:

- Agriculture Quebec. 1975. Noms des maladies des plantes du Canada/ Names of plant diseases in Canada. , Quebec City, Que., Canada. 288 pp.

Alex, J. F., Cayouette, R., Mulligan, G. A. 1980. Common and botanical names of weeds in Canada/Noms populaire et scientifiques des plantes nuisibles du Canada. Revised. Agric. Can. Publ., Ottawa, Ont., Canada. 132 pp.

Bailey, L. H., Bailey, E. Z. 1976. Hortus third. Revised. MacMillan, New York, N.Y., USA. 1290 pp.

Scoggan, H. J. 1978, 1979. The flora of Canada. Nat. Mus. Nat. Sci. (Ottawa) Publ. Bot. 7(1)-7(4). 1711 pp.

Van Wijk, H. L. 1911. A dictionary of plant names. Martinus Nijhoff, The Hague, The Netherlands. 1444 pp.

Victorin, M. 1964. Flore Laurentienne. 2nd ed. Univ. Montreal, Montreal, Que., Canada. 952 pp.

Geographic Information

New Brunswick
Nova Scotia
Ontario
Quebec

References:

Bailey, L. H., Bailey, E. Z. 1976. Hortus third. Revised. MacMillan, New York, N.Y., USA. 1290 pp.

Boivin, B. 1966, 1967. Énumération des plantes du Canada. Provencheria 6. Nat. Can. (Que.) 93: 253-274; 371-437; 583-646; 989-1063. 94: 131-157; 471-528; 625-655.

Image or illustration

Symplocarpus foetidus:

Images: images.google.com

Toxic parts:

leaves
roots

References:

Lampe, K. F., McCann, M. A. 1985. AMA Handbook of poisonous and injurious plants. American Medical Assoc. Chicago, Ill., USA. 432 pp.

Toxic plant chemicals:

oxalate

References:

Kingsbury, J. M. 1964. Poisonous plants of the United States and Canada. Prentice-Hall Inc., Englewood Cliffs, N.J., USA. 626 pp.

Lampe, K. F., McCann, M. A. 1985. AMA Handbook of poisonous and injurious plants. American Medical Assoc. Chicago, Ill., USA. 432 pp.

Animals/Human Poisoning:

Note: When an animal is listed without additional information, the literature (as of 1993) contained no detailed explanation.

Humans

General symptoms of poisoning:

[aphonia](#)

[dysphagia](#)

[hoarseness](#)

[mouth, irritation of](#)

References:

Kingsbury, J. M. 1964. Poisonous plants of the United States and Canada. Prentice-Hall Inc., Englewood Cliffs, N.J., USA. 626 pp.

Lampe, K. F., McCann, M. A. 1985. AMA Handbook of poisonous and injurious plants. American Medical Assoc. Chicago, Ill., USA. 432 pp.

[Another search?](#)

[Français](#) | [Contact Us](#) | [Help](#) | [Search](#) | [Canada site](#)

[Coming Events](#) | [About CBIF](#) | [Links](#) | [Reports and Publications](#) | [Home](#)

Date modified: 2003-02-06

[Important Notices](#)



Français	Contact us	Help	Search	Canada site
Coming events	About CBIF	Links	Reports and publications	Home

Canadian Biodiversity Information Facility



Notes on poisoning: *Tanacetum vulgare*

[Introduction](#)[Interactive](#)[All poisonous plants by Botanical name](#)[All poisonous plants by Common name](#)[Important WWW Poisonous Plants sites](#)

Nomenclature:

Scientific Name: *Tanacetum vulgare* L.

Vernacular name(s): tansy

Scientific family name: *Compositae*

Vernacular family name: composite

Go to ITIS^{*ca} for more taxonomic information on: [Tanacetum vulgare](#)

References:

Agriculture Quebec. 1975. Noms des maladies des plantes du Canada/ Names of plant diseases in Canada. , Quebec City, Que., Canada. 288 pp.

Alex, J. F., Cayouette, R., Mulligan, G. A. 1980. Common and botanical names of weeds in Canada/Noms populaire et scientifiques des plantes nuisibles du Canada. Revised. Agric. Can. Publ., Ottawa, Ont., Canada. 132 pp.

Bailey, L. H., Bailey, E. Z. 1976. Hortus third. Revised. MacMillan, New York, N.Y., USA. 1290 pp.

Scoggan, H. J. 1978, 1979. The flora of Canada. Nat. Mus. Nat. Sci. (Ottawa) Publ. Bot. 7(1)-7(4). 1711 pp.

Van Wijk, H. L. 1911. A dictionary of plant names. Martinus Nijhoff, The Hague, The Netherlands. 1444 pp.

Victorin, M. 1964. Flore Laurentienne. 2nd ed. Univ. Montreal, Montreal, Que., Canada. 952 pp.

Geographic Information

British Columbia
Nova Scotia
Ontario
Quebec
Saskatchewan

References:

Bailey, L. H., Bailey, E. Z. 1976. Hortus third. Revised. MacMillan, New York, N.Y., USA. 1290 pp.

Boivin, B. 1966, 1967. Énumération des plantes du Canada. Provencheria 6. Nat. Can. (Que.) 93: 253-274; 371-437; 583-646; 989-1063. 94: 131-157; 471-528; 625-655.

Image or illustration

Tanacetum vulgare:

Images: images.google.com

Notes on Poisonous plant parts:

All parts of the plant have a strong scent and contain a bitter essential oil that can be toxic (Fuller and McClintock 1986).

Toxic parts:

all parts
flowers
leaves

References:

Fuller, T. C., McClintock, E. 1986. Poisonous plants of California. Univ. California Press, Berkeley, Calif., USA. 432 pp.

Animals/Human Poisoning:

Note: When an animal is listed without additional information, the literature (as of 1993) contained no detailed explanation.

[Another search?](#)

[Français](#) | [Contact Us](#) | [Help](#) | [Search](#) | [Canada site](#)

[Coming Events](#) | [About CBIF](#) | [Links](#) | [Reports and Publications](#) | [Home](#)

Date modified: 2003-02-06

[Important Notices](#)



Français	Contact us	Help	Search	Canada site
Coming events	About CBIF	Links	Reports and publications	Home

Canadian Biodiversity Information Facility



Notes on poisoning: *Taxus baccata*

[Introduction](#)[Interactive](#)[All poisonous plants by Botanical name](#)[All poisonous plants by Common name](#)[Important WWW Poisonous Plants sites](#)

General poisoning notes:

English yew (*Taxus baccata*) is an introduced ornamental shrub that is hardy in the warmest parts of Canada. This shrub has caused poisoning and death in cattle, horses, and humans. Ingesting leaves, bark, or seeds can cause poisoning in all animals. The fleshy fruit pulp is considered to be nontoxic (or low in toxicity). Taxine, a complex of alkaloids, is found in the plant. Children should be taught not to eat the fruit or seeds of this plant. Animals should not have access to the shrub or clippings of the branches (Cooper and Johnson 1984, Feldman et al. 1987).

References:

- Burke, M. J., Siegel, D., Davidow, B. 1979. Anaphylaxis. Consequence of yew (*Taxus*) needle ingestion. N. Y. State J. Med., 79: 1576-1577.
- Cooper, M. R., Johnson, A. W. 1984. Poisonous plants in Britain and their effects on animals and man. Her Majesty's Stationery Office, London, England. 305 pp.
- Feldman, R., Szajewski, J. M., Chrobak, J., Liberek, Z. M. 1987. Four cases of self-poisoning with yew leaves decoction. Vet. Hum. Toxicol., 29: 72.

Nomenclature:

Scientific Name: *Taxus baccata* L.

References:

- Agriculture Quebec. 1975. Noms des maladies des plantes du Canada/ Names of plant diseases in Canada. , Quebec City, Que., Canada. 288 pp.

Alex, J. F., Cayouette, R., Mulligan, G. A. 1980. Common and botanical names of weeds in Canada/Noms populaire et scientifiques des plantes nuisibles du Canada. Revised. Agric. Can. Publ., Ottawa, Ont., Canada. 132 pp.

Bailey, L. H., Bailey, E. Z. 1976. Hortus third. Revised. MacMillan, New York, N.Y., USA. 1290 pp.

Scoggan, H. J. 1978, 1979. The flora of Canada. Nat. Mus. Nat. Sci. (Ottawa) Publ. Bot. 7(1)-7(4). 1711 pp.

Van Wijk, H. L. 1911. A dictionary of plant names. Martinus Nijhoff, The Hague, The Netherlands. 1444 pp.

Victorin, M. 1964. Flore Laurentienne. 2nd ed. Univ. Montreal, Montreal, Que., Canada. 952 pp.

Geographic Information

Plant or plant parts used in or around the home.

References:

Bailey, L. H., Bailey, E. Z. 1976. Hortus third. Revised. MacMillan, New York, N.Y., USA. 1290 pp.

Boivin, B. 1966, 1967. Énumération des plantes du Canada. Provencheria 6. Nat. Can. (Que.) 93: 253-274; 371-437; 583-646; 989-1063. 94: 131-157; 471-528; 625-655.

Image or illustration

Taxus baccata:

Images: images.google.com

Notes on Poisonous plant parts:

All parts of the plant contain significant amounts of the alkaloids, with the exception of the fleshy part of the fruits, which is regarded as nontoxic or low in toxicity. The seeds are toxic. Ingesting the entire fruits without removing the seeds can cause poisoning. Toxicity is not reduced with drying. Hedge clippings from these plants are as toxic as fresh plants (Cooper and Johnson 1984).

Toxic parts:

leaves
pollen

seeds

References:

Cooper, M. R., Johnson, A. W. 1984. Poisonous plants in Britain and their effects on animals and man. Her Majesty's Stationery Office, London, England. 305 pp.

Feldman, R., Szajewski, J. M., Chrobak, J., Liberek, Z. M. 1987. Four cases of self-poisoning with yew leaves decoction. *Vet. Hum. Toxicol.*, 29: 72.

Notes on Toxic plant chemicals:

Taxine (taxin) is a complex mixture of alkaloids that is rapidly absorbed from the digestive tract and interferes with heart action. Case studies on humans have shown that the alkaloids are strongly diuretic and cause severe ventricular rhythms (Feldman et al. 1987). Smith (1989) discusses a technique to diagnose taxine quickly, using direct insertion probe mass spectrometry from the rumen. The lethal dose was estimated at 1-10 g/kg of body weight for ruminants and 0.5-2 g/kg for horses (Cooper and Johnson 1984).

Toxic plant chemicals:

taxine

References:

Cooper, M. R., Johnson, A. W. 1984. Poisonous plants in Britain and their effects on animals and man. Her Majesty's Stationery Office, London, England. 305 pp.

Feldman, R., Szajewski, J. M., Chrobak, J., Liberek, Z. M. 1987. Four cases of self-poisoning with yew leaves decoction. *Vet. Hum. Toxicol.*, 29: 72.

Smith, R. A. 1989. Comments on diagnosis of intoxication due to *Taxus*. *Vet. Hum. Toxicol.*, 31: 177.

Animals/Human Poisoning:

Note: When an animal is listed without additional information, the literature (as of 1993) contained no detailed explanation.

Cattle

General symptoms of poisoning:

[agitation](#)

[collapse](#)

[convulsions](#)

[death](#)

[gait, staggering](#)

[incoordination](#)

[pupil dilation](#)

[trembling](#)

Notes on poisoning:

In Europe, cattle have been poisoned after ingesting English yew. Symptoms include muscular trembling, coldness, a rapid and then weak pulse, and groaning. In some cases, symptoms are not evident until sudden collapse or death. Death does not always occur and spontaneous recovery has been reported. Postmortem findings may only show yew plant material in the stomach. Inflammation of the stomach and intestines may occur (Cooper and Johnson 1984).

References:

Cooper, M. R., Johnson, A. W. 1984. Poisonous plants in Britain and their effects on animals and man. Her Majesty's Stationery Office, London, England. 305 pp.

Horses

General symptoms of poisoning:

[abdominal pains](#)

[collapse](#)

[confusion](#)

[death](#)

[gait, staggering](#)

[incoordination](#)

Notes on poisoning:

Horses have symptoms similar to cattle after ingesting plant material of English yew. In one experiment, a pony given a strained aqueous extract from yew twigs and berries, by stomach tube, developed signs after 1 h and died 15 min later. Ingestion results in the following symptoms: coldness, a rapid and then weak pulse, excitability, and collapse, followed by death (Cooper and Johnson 1984).

References:

Cooper, M. R., Johnson, A. W. 1984. Poisonous plants in Britain and their effects on animals and man. Her Majesty's Stationery Office, London, England. 305 pp.

Humans

General symptoms of poisoning:

[abdominal pains](#)

[coma](#)

[death](#)

[dizziness](#)

[dyspnea](#)

[heart rate, slow](#)

[itchiness](#)

[muscle, weakness of](#)

[sweating](#)

[urination, frequent](#)

[vomiting](#)

References:

Burke, M. J., Siegel, D., Davidow, B. 1979. Anaphylaxis. Consequence of yew (*Taxus*) needle ingestion. N. Y. State J. Med., 79: 1576-1577.

Cooper, M. R., Johnson, A. W. 1984. Poisonous plants in Britain and their effects on animals and man. Her Majesty's Stationery Office, London, England. 305 pp.

Feldman, R., Szajewski, J. M., Chrobak, J., Liberek, Z. M. 1987. Four cases of self-poisoning with yew leaves decoction. Vet. Hum. Toxicol., 29: 72.

[Another search?](#)

[Français](#) | [Contact Us](#) | [Help](#) | [Search](#) | [Canada site](#)

[Coming Events](#) | [About CBIF](#) | [Links](#) | [Reports and Publications](#) |

[Home](#)

Date modified: 2003-02-06

[Important Notices](#)



Français	Contact us	Help	Search	Canada site
Coming events	About CBIF	Links	Reports and publications	Home

Canadian Biodiversity Information Facility



Notes on poisoning: *Taxus canadensis*

[Introduction](#)[Interactive](#)[All poisonous plants by Botanical name](#)[All poisonous plants by Common name](#)[Important WWW Poisonous Plants sites](#)

General poisoning notes:

Canada yew (*Taxus canadensis*) is a native shrub that grows in the moist rich woodlands of eastern Canada. It has also been planted in various parts of the country as an ornamental. In one case in British Columbia, several cattle became ill and some died after ingesting the leaves and twigs of a Canada yew that had been planted for ornamental purposes (Bruce 1927).



References:

Bruce, E. A. 1927. *Astragalus campestris* and other stock poisoning plants of British Columbia. Agric. Can. Publ., 88. 44 pp.

Thomson, G. W., Barker, I. K. 1978. Japanese yew (*Taxus cuspidata*) poisoning in cattle. Can. Vet. J., 19: 320-321.

Nomenclature:

Scientific Name: *Taxus canadensis* Marsh.

References:

Agriculture Quebec. 1975. Noms des maladies des plantes du Canada/ Names of plant diseases in Canada. , Quebec City, Que., Canada. 288 pp.

Alex, J. F., Cayouette, R., Mulligan, G. A. 1980. Common and botanical names of weeds in Canada/Noms populaire et scientifiques des plantes nuisibles du Canada. Revised. Agric. Can. Publ., Ottawa, Ont., Canada. 132 pp.

Bailey, L. H., Bailey, E. Z. 1976. Hortus third. Revised. MacMillan, New York, N.Y., USA. 1290 pp.

Scoggan, H. J. 1978, 1979. The flora of Canada. Nat. Mus. Nat.

Sci. (Ottawa) Publ. Bot. 7(1)-7(4). 1711 pp.

Van Wijk, H. L. 1911. A dictionary of plant names. Martinus Nijhoff, The Hague, The Netherlands. 1444 pp.

Victorin, M. 1964. Flore Laurentienne. 2nd ed. Univ. Montreal, Montreal, Que., Canada. 952 pp.

Geographic Information

British Columbia
Manitoba
New Brunswick
Nova Scotia
Ontario
Prince Edward Island
Quebec

References:

Bailey, L. H., Bailey, E. Z. 1976. Hortus third. Revised. MacMillan, New York, N.Y., USA. 1290 pp.

Boivin, B. 1966, 1967. Énumération des plantes du Canada. Provencheria 6. Nat. Can. (Que.) 93: 253-274; 371-437; 583-646; 989-1063. 94: 131-157; 471-528; 625-655.

Image or illustration

Taxus canadensis:

Images: images.google.com

Notes on Poisonous plant parts:

Leaves, twigs, and seeds are poisonous. Only the red arils, the fleshy outer parts of the fruits, are considered nontoxic (Bruce 1927; Lampe and McCann 1985).

Toxic parts:

leaves
seeds
twigs

References:

Bruce, E. A. 1927. *Astragalus campestris* and other stock poisoning plants of British Columbia. Agric. Can. Publ., 88. 44 pp.

Lampe, K. F., McCann, M. A. 1985. AMA Handbook of poisonous and injurious plants. American Medical Assoc. Chicago, Ill., USA. 432 pp.

Notes on Toxic plant chemicals:

Taxine (taxin), is a complex mixture of alkaloids that is rapidly absorbed from the digestive tract and interferes with heart action (Lampe and McCann 1985, Feldman et al. 1987).

Toxic plant chemicals:

taxine

References:

Feldman, R., Szajewski, J. M., Chrobak, J., Liberek, Z. M. 1987. Four cases of self-poisoning with yew leaves decoction. Vet. Hum. Toxicol., 29: 72.

Lampe, K. F., McCann, M. A. 1985. AMA Handbook of poisonous and injurious plants. American Medical Assoc. Chicago, Ill., USA. 432 pp.

Animals/Human Poisoning:

Note: When an animal is listed without additional information, the literature (as of 1993) contained no detailed explanation.

Cattle

General symptoms of poisoning:

[death](#)

[lungs, congestion of](#)

Notes on poisoning:

Leaves, twigs, and seeds are poisonous. Only the red arils, the fleshy outer parts of the fruits, are considered nontoxic (Bruce 1927; Lampe and McCann 1985).

References:

Bruce, E. A. 1927. *Astragalus campestris* and other stock poisoning plants of British Columbia. Agric. Can. Publ., 88. 44 pp.

[Another search?](#)

[Français](#) | [Contact Us](#) | [Help](#) | [Search](#) | [Canada site](#)
[Coming Events](#) | [About CBIF](#) | [Links](#) | [Reports and Publications](#) |
[Home](#)

Date modified: 2003-02-06

[Important Notices](#)



Français	Contact us	Help	Search	Canada site
Coming events	About CBIF	Links	Reports and publications	Home

Canadian Biodiversity Information Facility



Notes on poisoning: *Taxus cuspidata*

[Introduction](#)

[Interactive](#)

[All poisonous plants by Botanical name](#)

[All poisonous plants by Common name](#)

[Important WWW Poisonous Plants sites](#)



General poisoning notes:

Japanese yew (*Taxus cuspidata*) is an outdoor ornamental that is winter-hardy across southern Canada. This shrub contains toxic quantities of the alkaloid taxine. Cattle and horses became ill and died after ingesting the leaves and twigs of Japanese yew. In two cases in Ontario, several cattle died after gaining access to shrubs around houses or after being given hedge trimmings (Alden et al. 1977, Thomson and Barker 1978).

References:

Alden, C. L., Fosnaugh, C. J., Smith, J. B., Mohan, R. 1977. Japanese yew poisoning of large domestic animals in the midwest. J. Am. Vet. Med. Assoc., 170: 314-316.

Ogden, L. 1988. *Taxus* (yews) - a highly toxic plant. Vet. Hum. Toxicol., 30: 563-564.

Thomson, G. W., Barker, I. K. 1978. Japanese yew (*Taxus cuspidata*) poisoning in cattle. Can. Vet. J., 19: 320-321.

Veatch, J. K., Reid, F. M., Kennedy, G. A. 1988. Differentiating yew poisoning from other toxicoses. Vet. Med., 83: 298-300.

Nomenclature:

Scientific Name: *Taxus cuspidata* Siebold & Zucc.

References:

Agriculture Quebec. 1975. Noms des maladies des plantes du Canada/ Names of plant diseases in Canada. , Quebec City, Que., Canada. 288 pp.

Alex, J. F., Cayouette, R., Mulligan, G. A. 1980. Common and botanical names of weeds in Canada/Noms populaire et

scientifiques des plantes nuisibles du Canada. Revised. Agric. Can. Publ., Ottawa, Ont., Canada. 132 pp.

Bailey, L. H., Bailey, E. Z. 1976. Hortus third. Revised. MacMillan, New York, N.Y., USA. 1290 pp.

Scoggan, H. J. 1978, 1979. The flora of Canada. Nat. Mus. Nat. Sci. (Ottawa) Publ. Bot. 7(1)-7(4). 1711 pp.

Van Wijk, H. L. 1911. A dictionary of plant names. Martinus Nijhoff, The Hague, The Netherlands. 1444 pp.

Victorin, M. 1964. Flore Laurentienne. 2nd ed. Univ. Montreal, Montreal, Que., Canada. 952 pp.

Geographic Information

Plant or plant parts used in or around the home.

References:

Bailey, L. H., Bailey, E. Z. 1976. Hortus third. Revised. MacMillan, New York, N.Y., USA. 1290 pp.

Boivin, B. 1966, 1967. Énumération des plantes du Canada. Provencheria 6. Nat. Can. (Que.) 93: 253-274; 371-437; 583-646; 989-1063. 94: 131-157; 471-528; 625-655.

Image or illustration

Taxus cuspidata:

Images: images.google.com

Notes on Poisonous plant parts:

Leaves, twigs, and seeds are toxic. Only the red arils, the fleshy outer parts of the fruits, are considered nontoxic (Ogden 1988).

Toxic parts:

leaves
seeds
twigs

References:

Ogden, L. 1988. *Taxus* (yews) - a highly toxic plant. Vet. Hum. Toxicol., 30: 563-564.

Notes on Toxic plant chemicals:

Taxine (taxin) is a complex mixture of alkaloids that is rapidly absorbed from the digestive tract and interferes with heart action (Feldman et al. 1987).

Toxic plant chemicals:

taxine

References:

Feldman, R., Szajewski, J. M., Chrobak, J., Liberek, Z. M. 1987. Four cases of self-poisoning with yew leaves decoction. *Vet. Hum. Toxicol.*, 29: 72.

Lampe, K. F., McCann, M. A. 1985. *AMA Handbook of poisonous and injurious plants*. American Medical Assoc. Chicago, Ill., USA. 432 pp.

Animals/Human Poisoning:

Note: When an animal is listed without additional information, the literature (as of 1993) contained no detailed explanation.

Cattle

General symptoms of poisoning:

[death](#)

References:

Ogden, L. 1988. *Taxus* (yews) - a highly toxic plant. *Vet. Hum. Toxicol.*, 30: 563-564.

Veatch, J. K., Reid, F. M., Kennedy, G. A. 1988. Differentiating yew poisoning from other toxicoses. *Vet. Med.*, 83: 298-300.

[Another search?](#)

[Français](#) | [Contact Us](#) | [Help](#) | [Search](#) | [Canada site](#)

[Coming Events](#) | [About CBIF](#) | [Links](#) | [Reports and Publications](#) |

[Home](#)

Date modified: 2003-02-06

[Important Notices](#)



Français	Contact us	Help	Search	Canada site
Coming events	About CBIF	Links	Reports and publications	Home

Canadian Biodiversity Information Facility



Notes on poisoning: *Thermopsis rhombifolia*

[Introduction](#)[Interactive](#)[All poisonous plants by Botanical name](#)[All poisonous plants by Common name](#)[Important WWW Poisonous Plants sites](#)

General poisoning notes:

Golden-bean (*Thermopsis rhombifolia*) is a native plant that is found in the southern part of western Canada. This plant has been suspected since the late 1800s to be poisonous to cattle and horses, but conclusive evidence is lacking in the literature. The related plant, poison-bean (*Thermopsis montana*), causes poisoning in cattle. Poison-bean contains several quinolizidine alkaloids, and similar chemicals may be found in golden-bean. Ingesting seeds of golden-bean was suspected in a case of poisoning of a child in western Canada. Until more definitive studies appear in the literature, the plant is included in this Information System because of its potential for poisoning (Kingsbury 1964, Keeler et al. 1986).

References:

Keeler, R. F., Johnson, A. E., Chase, R. L. 1986. Toxicity of *Thermopsis montana* in cattle. *Cornell Vet.*, 76: 115-127.

Kingsbury, J. M. 1964. *Poisonous plants of the United States and Canada*. Prentice-Hall Inc., Englewood Cliffs, N.J., USA. 626 pp.

Nomenclature:

Scientific Name: *Thermopsis rhombifolia* (Nutt.) Richards.

Vernacular name(s): golden-bean

Scientific family name: *Leguminosae*

Vernacular family name: pea

Go to ITIS^{*ca} for more taxonomic information on: [Thermopsis rhombifolia](#)

References:

Agriculture Quebec. 1975. Noms des maladies des plantes du Canada/ Names of plant diseases in Canada. , Quebec City, Que., Canada. 288 pp.

Alex, J. F., Cayouette, R., Mulligan, G. A. 1980. Common and botanical names of weeds in Canada/Noms populaire et scientifiques des plantes nuisibles du Canada. Revised. Agric. Can. Publ., Ottawa, Ont., Canada. 132 pp.

Bailey, L. H., Bailey, E. Z. 1976. Hortus third. Revised. MacMillan, New York, N.Y., USA. 1290 pp.

Scoggan, H. J. 1978, 1979. The flora of Canada. Nat. Mus. Nat. Sci. (Ottawa) Publ. Bot. 7(1)-7(4). 1711 pp.

Van Wijk, H. L. 1911. A dictionary of plant names. Martinus Nijhoff, The Hague, The Netherlands. 1444 pp.

Victorin, M. 1964. Flore Laurentienne. 2nd ed. Univ. Montreal, Montreal, Que., Canada. 952 pp.

Geographic Information

Alberta
British Columbia
Manitoba
Saskatchewan

References:

Bailey, L. H., Bailey, E. Z. 1976. Hortus third. Revised. MacMillan, New York, N.Y., USA. 1290 pp.

Boivin, B. 1966, 1967. Énumération des plantes du Canada. Provencheria 6. Nat. Can. (Que.) 93: 253-274; 371-437; 583-646; 989-1063. 94: 131-157; 471-528; 625-655.

Image or illustration

Thermopsis rhombifolia:

Images: images.google.com

Toxic parts:

leaves
seeds

References:

Keeler, R. F., Johnson, A. E., Chase, R. L. 1986. Toxicity of *Thermopsis montana* in cattle. Cornell Vet., 76: 115-127.

Notes on Toxic plant chemicals:

The chemicals listed here are found in the closely related poison-bean (*Thermopsis montana*), although similar chemicals are found in golden-bean (Keeler et al. 1986). Some of these chemicals are found in other members of the pea family, including anagyrine, which causes teratogenic effects in cattle that eat lupines containing this chemical.

Toxic plant chemicals:

anagyrine
cytisine
N-methylcytisine
thermopsine

References:

Keeler, R. F., Johnson, A. E., Chase, R. L. 1986. Toxicity of *Thermopsis montana* in cattle. Cornell Vet., 76: 115-127.

Animals/Human Poisoning:

Note: When an animal is listed without additional information, the literature (as of 1993) contained no detailed explanation.

Cattle

General symptoms of poisoning:

[appetite, loss of](#)
[death](#)
[depression](#)

References:

Keeler, R. F., Johnson, A. E., Chase, R. L. 1986. Toxicity of *Thermopsis montana* in cattle. Cornell Vet., 76: 115-127.

Horses

Humans

[Another search?](#)

[Français](#) | [Contact Us](#) | [Help](#) | [Search](#) | [Canada site](#)

[Coming Events](#) | [About CBIF](#) | [Links](#) | [Reports and Publications](#) |

[Home](#)

Date modified: 2003-02-06

[Important Notices](#)



Français	Contact us	Help	Search	Canada site
Coming events	About CBIF	Links	Reports and publications	Home

Canadian Biodiversity Information Facility



Notes on poisoning: *Thlaspi arvense*

[Introduction](#)[Interactive](#)[All poisonous plants by Botanical name](#)[All poisonous plants by Common name](#)[Important WWW Poisonous Plants sites](#)

General poisoning notes:

Stinkweed (*Thlaspi arvense*) is a naturalized herb found in fields and waste places across Canada. The plant contains sufficient quantities of glucosinolates to be toxic. During dry periods, cattle in western Canada have ingested hay containing high quantities of stinkweed. Poisoning, death and abortion occurred (Smith and Crowe 1987). See [Brassica oleracea](#) for additional notes on glucosinolate poisoning.

References:



Cheeke, P. R., Shull, L. R. 1985. Natural toxicants in feeds and poisonous plants. AVI Publishing Company, Inc., Westport, Conn., USA. 492 pp.

Majak, W., McDiarmid, R. E., Benn, M. H., Willms, W. D. 1991. Autolysis of *Thlaspi arvense* in bovine rumen fluid. Phytochemistry (Oxf.), 30: 127-129.

Martin, T., Morgan, S. 1987. What caused the photosensitivity in these dairy heifers. Vet. Med. Small Anim. Clin., 82: 848-851.

Smith, R. A., Crowe, S. P. 1987. Fanweed toxicosis in cattle: case history, analytical method, suggested treatment, and fanweed detoxification. Vet. Hum. Toxicol., 29: 155-159.

Nomenclature:

Scientific Name: *Thlaspi arvense* L.

Vernacular name(s): stinkweed

Scientific family name: *Cruciferae*

Vernacular family name: mustard

Go to ITIS*^{ca} for more taxonomic information on: [Thlaspi arvense](#)

References:

Agriculture Quebec. 1975. Noms des maladies des plantes du Canada/ Names of plant diseases in Canada. , Quebec City, Que., Canada. 288 pp.

Alex, J. F., Cayouette, R., Mulligan, G. A. 1980. Common and botanical names of weeds in Canada/Noms populaire et scientifiques des plantes nuisibles du Canada. Revised. Agric. Can. Publ., Ottawa, Ont., Canada. 132 pp.

Bailey, L. H., Bailey, E. Z. 1976. Hortus third. Revised. MacMillan, New York, N.Y., USA. 1290 pp.

Scoggan, H. J. 1978, 1979. The flora of Canada. Nat. Mus. Nat. Sci. (Ottawa) Publ. Bot. 7(1)-7(4). 1711 pp.

Van Wijk, H. L. 1911. A dictionary of plant names. Martinus Nijhoff, The Hague, The Netherlands. 1444 pp.

Victorin, M. 1964. Flore Laurentienne. 2nd ed. Univ. Montreal, Montreal, Que., Canada. 952 pp.

Geographic Information

Alberta
British Columbia
Labrador
Manitoba
New Brunswick
Northwest Territories
Nova Scotia
Ontario
Prince Edward Island
Quebec
Saskatchewan
Yukon Territory

References:

Bailey, L. H., Bailey, E. Z. 1976. Hortus third. Revised. MacMillan, New York, N.Y., USA. 1290 pp.

Boivin, B. 1966, 1967. Énumération des plantes du Canada. Provencheria 6. Nat. Can. (Que.) 93: 253-274; 371-437; 583-646; 989-1063. 94: 131-157; 471-528; 625-655.

Image or illustration

Thlaspi arvense:

Images: images.google.com

Toxic parts:

leaves
seeds

References:

Best, K. F., McIntyre, G. I. 1975. The biology of Canadian weeds 9. *Thlaspi arvense* L. Can. J. Plant Sci., 55: 279-292.

Cheeke, P. R., Shull, L. R. 1985. Natural toxicants in feeds and poisonous plants. AVI Publishing Company, Inc., Westport, Conn., USA. 492 pp.

Smith, R. A., Crowe, S. P. 1987. Fanweed toxicosis in cattle: case history, analytical method, suggested treatment, and fanweed detoxification. Vet. Hum. Toxicol., 29: 155-159.

Notes on Toxic plant chemicals:

Tests of stinkweed showed that the allylthiocyanate (a glucosinolate) content is sufficient to cause sickness and death in cattle; fatalities occurred at about 65 mg/kg of body weight. The amount of this chemical varies with the stage of maturity of the plant; the highest amount is in the seeds (Smith and Crowe 1987, Majak et al. 1991).

Toxic plant chemicals:

glucosinolates

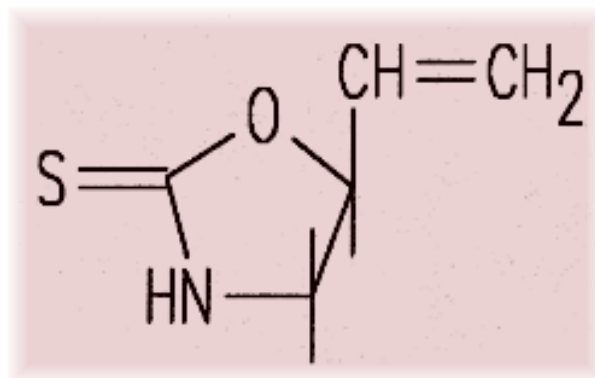

glucosinolates

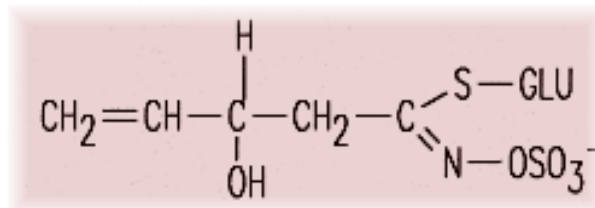

glucosinolates

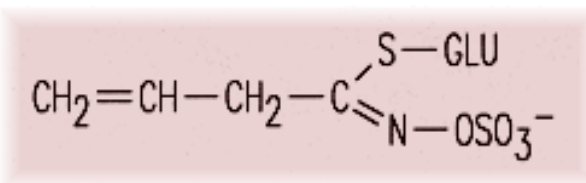

Chemical diagram(s) are courtesy of [Ruth McDiarmid](#), Biochemistry Technician, Kamloops Range Station, Agriculture and Agri-Food Canada, Kamloops, British Columbia, Canada.

References:

Best, K. F., McIntyre, G. I. 1975. The biology of Canadian weeds 9. *Thlaspi arvense* L. Can. J. Plant Sci., 55: 279-292.

Cheeke, P. R., Shull, L. R. 1985. Natural toxicants in feeds and poisonous plants. AVI Publishing Company, Inc., Westport, Conn., USA. 492 pp.

Majak, W., McDiarmid, R. E., Benn, M. H., Willms, W. D. 1991. Autolysis of *Thlaspi arvense* in bovine rumen fluid. Phytochemistry (Oxf.), 30: 127-129.

Smith, R. A., Crowe, S. P. 1987. Fanweed toxicosis in cattle: case history, analytical method, suggested treatment, and fanweed detoxification. Vet. Hum. Toxicol., 29: 155-159.

Animals/Human Poisoning:

Note: When an animal is listed without additional information, the literature (as of 1993) contained no detailed explanation.

Cattle

General symptoms of poisoning:

[abortion](#)

[colic](#)

[death](#)

[skin, peeling of](#)

Notes on poisoning:

Cattle that ingested hay containing between 25-100% stinkweed were colicky and some abortions occurred. Necropsy of cows revealed massive submucosal edema of the wall of forestomachs, particularly in the rumen. Lowering the rumen pH to 5 reportedly stops the allylthiocyanate from forming. However, more recent work found that lower pH did not significantly affect the liberation of allylthiocyanate. Administering large doses of piperazine (110 mg/kg) to rapidly reduce the concentration of toxin has been

suggested. Ensiling hay containing stinkweed apparently prevented liberation of allylthiocyanate (Smith and Crowe 1987). Yield of the chemical is a function of the diet, with alfalfa herbage allowing the lowest release quantity (30%) and alfalfa hay the highest yield (72%) (Majak et al. 1991).

References:

Cheeke, P. R., Shull, L. R. 1985. Natural toxicants in feeds and poisonous plants. AVI Publishing Company, Inc., Westport, Conn., USA. 492 pp.

Majak, W., McDiarmid, R. E., Benn, M. H., Willms, W. D. 1991. Autolysis of *Thlapsi arvense* in bovine rumen fluid. *Phytochemistry* (Oxf.), 30: 127-129.

Martin, T., Morgan, S. 1987. What caused the photosensitivity in these dairy heifers. *Vet. Med. Small Anim. Clin.*, 82: 848-851.

Smith, R. A., Crowe, S. P. 1987. Fanweed toxicosis in cattle: case history, analytical method, suggested treatment, and fanweed detoxification. *Vet. Hum. Toxicol.*, 29: 155-159.

[Another search?](#)

[Français](#) | [Contact Us](#) | [Help](#) | [Search](#) | [Canada site](#)

[Coming Events](#) | [About CBIF](#) | [Links](#) | [Reports and Publications](#) | [Home](#)

Date modified: 2003-02-06

[Important Notices](#)



Français	Contact us	Help	Search	Canada site
Coming events	About CBIF	Links	Reports and publications	Home

Canadian Biodiversity Information Facility



Notes on poisoning: *Trifolium hybridum*

[Introduction](#)

[Interactive](#)

[All poisonous plants by Botanical name](#)

[All poisonous plants by Common name](#)

[Important WWW Poisonous Plants sites](#)



General poisoning notes:

Alsike clover (*Trifolium hybridum*) is found most frequently in the farming areas of northern Canada. This plant is adapted to cool climates and heavy, poorly drained clay soils. Cases of photosensitization have occurred, sometimes accompanied by liver damage and enlargement. This problem has occurred mostly in horses and occasionally in cattle. There is also a potential for nitrate poisoning (Cooper and Johnson 1984, Cheeke and Schull 1985).

References:

Cheeke, P. R., Shull, L. R. 1985. Natural toxicants in feeds and poisonous plants. AVI Publishing Company, Inc., Westport, Conn., USA. 492 pp.

Cooper, M. R., Johnson, A. W. 1984. Poisonous plants in Britain and their effects on animals and man. Her Majesty's Stationery Office, London, England. 305 pp.

Fincher, M. G., Fuller, H. K. 1942. Photosensitization - trifoliosis - light sensitization. Cornell Vet., 32: 95-99.

Nation, P. N. 1989. Alsike clover poisoning: a review. Can. Vet. J., 30: 410-415.

Traub, J. L., Potter, K. A., Bayly, W. M., Reed, S. M. 1982. Alsike clover poisoning. Mod. Vet. Pract., 63: 307-309.

Nomenclature:

Scientific Name: *Trifolium hybridum* L.

Vernacular name(s): alsike clover

Scientific family name: *Leguminosae*

Vernacular family name: pea

Go to ITIS^{*ca} for more taxonomic information on: [Trifolium hybridum](#)

References:

Agriculture Quebec. 1975. Noms des maladies des plantes du Canada/ Names of plant diseases in Canada. , Quebec City, Que., Canada. 288 pp.

Alex, J. F., Cayouette, R., Mulligan, G. A. 1980. Common and botanical names of weeds in Canada/Noms populaire et scientifiques des plantes nuisibles du Canada. Revised. Agric. Can. Publ., Ottawa, Ont., Canada. 132 pp.

Bailey, L. H., Bailey, E. Z. 1976. Hortus third. Revised. MacMillan, New York, N.Y., USA. 1290 pp.

Scoggan, H. J. 1978, 1979. The flora of Canada. Nat. Mus. Nat. Sci. (Ottawa) Publ. Bot. 7(1)-7(4). 1711 pp.

Van Wijk, H. L. 1911. A dictionary of plant names. Martinus Nijhoff, The Hague, The Netherlands. 1444 pp.

Victorin, M. 1964. Flore Laurentienne. 2nd ed. Univ. Montreal, Montreal, Que., Canada. 952 pp.

Geographic Information

Alberta
British Columbia
Labrador
Manitoba
New Brunswick
Nova Scotia
Ontario
Prince Edward Island
Quebec
Saskatchewan
Yukon Territory

References:

Bailey, L. H., Bailey, E. Z. 1976. Hortus third. Revised. MacMillan, New York, N.Y., USA. 1290 pp.

Boivin, B. 1966, 1967. Énumération des plantes du Canada. Provencheria 6. Nat. Can. (Que.) 93: 253-274; 371-437; 583-646; 989-1063. 94: 131-157; 471-528; 625-655.

Image or illustration

Trifolium hybridum:

Images: images.google.com

Notes on Poisonous plant parts:

Ingesting alsike clover causes photosensitization in horses and cattle. The toxic compounds have not been indentified. Nitrates may also accumulate in the plant (Cooper and Johnson 1984).

Toxic parts:

all parts
leaves

References:

Cheeke, P. R., Shull, L. R. 1985. Natural toxicants in feeds and poisonous plants. AVI Publishing Company, Inc., Westport, Conn., USA. 492 pp.

Toxic plant chemicals:

nitrate

References:

Cheeke, P. R., Shull, L. R. 1985. Natural toxicants in feeds and poisonous plants. AVI Publishing Company, Inc., Westport, Conn., USA. 492 pp.

Animals/Human Poisoning:

Note: When an animal is listed without additional information, the literature (as of 1993) contained no detailed explanation.

Cattle

General symptoms of poisoning:

[breathing, labored](#)

[cyanosis](#)

[gait, staggering](#)

References:

Cooper, M. R., Johnson, A. W. 1984. Poisonous plants in Britain and their effects on animals and man. Her Majesty's Stationery Office, London, England. 305 pp.

Horses

General symptoms of poisoning:

[blindness](#)

[depression](#)

[gait, staggering](#)

[liver, cirrhosis of](#)

[nephrosis, severe](#)

References:

Cooper, M. R., Johnson, A. W. 1984. Poisonous plants in Britain and their effects on animals and man. Her Majesty's Stationery Office, London, England. 305 pp.

Traub, J. L., Potter, K. A., Bayly, W. M., Reed, S. M. 1982. Alsike clover poisoning. Mod. Vet. Pract., 63: 307-309.

[Another search?](#)

[Français](#) | [Contact Us](#) | [Help](#) | [Search](#) | [Canada site](#)

[Coming Events](#) | [About CBIF](#) | [Links](#) | [Reports and Publications](#) |

[Home](#)

Date modified: 2003-02-06

[Important Notices](#)



Français	Contact us	Help	Search	Canada site
Coming events	About CBIF	Links	Reports and publications	Home

Canadian Biodiversity Information Facility



Notes on poisoning: *Trifolium pratense*

[Introduction](#)[Interactive](#)[All poisonous plants by Botanical name](#)[All poisonous plants by Common name](#)[Important WWW Poisonous Plants sites](#)

General poisoning notes:

Red clover (*Trifolium pratense*) is a common clover that is used in both cultivation for forage and food for animals. It is also widely naturalized across Canada. Ingesting of this plant can cause bloat in animals. This plant is also involved in a condition called **congenital joint laxity and dwarfism**, which occurs sporadically across the northern part of British Columbia, Alberta, and Ontario. This disorder results in teratogenic problems in beef calves when their dams have overwintered exclusively on clover and grass silage. Red clover can also develop phytoestrogens, which affect fertility in livestock (Cheeke and Schull 1985, Ribble et al. 1989).

References:

Cheeke, P. R., Shull, L. R. 1985. Natural toxicants in feeds and poisonous plants. AVI Publishing Company, Inc., Westport, Conn., USA. 492 pp.

Hall, J. W., Majak, W. 1989. Plant and animal factors in legume bloat. Pages 93-106 in Cheeke, P. R., ed. Toxicants of plant origin. Vol. III. Proteins and amino acids. CRC Press, Inc., Boca Raton, Fla., USA. 271 pp.

Ribble, C. S., Janzen, E. D., Proulx, J. G. 1989. Congenital joint laxity and dwarfism: a feed-associated congenital anomaly of beef calves in Canada. Can. Vet. J., 30: 331-338.

Nomenclature:

Scientific Name: *Trifolium pratense* L.

Vernacular name(s): red clover

Scientific family name: *Leguminosae*

Vernacular family name: pea

Go to ITIS^{*ca} for more taxonomic information on: [Trifolium pratense](#)

References:

Agriculture Quebec. 1975. Noms des maladies des plantes du Canada/ Names of plant diseases in Canada. , Quebec City, Que., Canada. 288 pp.

Alex, J. F., Cayouette, R., Mulligan, G. A. 1980. Common and botanical names of weeds in Canada/Noms populaire et scientifiques des plantes nuisibles du Canada. Revised. Agric. Can. Publ., Ottawa, Ont., Canada. 132 pp.

Bailey, L. H., Bailey, E. Z. 1976. Hortus third. Revised. MacMillan, New York, N.Y., USA. 1290 pp.

Scoggan, H. J. 1978, 1979. The flora of Canada. Nat. Mus. Nat. Sci. (Ottawa) Publ. Bot. 7(1)-7(4). 1711 pp.

Van Wijk, H. L. 1911. A dictionary of plant names. Martinus Nijhoff, The Hague, The Netherlands. 1444 pp.

Victorin, M. 1964. Flore Laurentienne. 2nd ed. Univ. Montreal, Montreal, Que., Canada. 952 pp.

Geographic Information

Alberta
British Columbia
Labrador
Manitoba
New Brunswick
Newfoundland
Nova Scotia
Ontario
Prince Edward Island
Quebec
Saskatchewan
Yukon Territory

References:

Bailey, L. H., Bailey, E. Z. 1976. Hortus third. Revised. MacMillan, New York, N.Y., USA. 1290 pp.

Boivin, B. 1966, 1967. Énumération des plantes du Canada. Provencheria 6. Nat. Can. (Que.) 93: 253-274; 371-437; 583-646; 989-1063. 94: 131-157; 471-528; 625-655.

Image or illustration

Trifolium pratense:

Images: images.google.com

Toxic parts:

all parts

References:

Ribble, C. S., Janzen, E. D., Proulx, J. G. 1989. Congenital joint laxity and dwarfism: a feed-associated congenital anomaly of beef calves in Canada. *Can. Vet. J.*, 30: 331-338.

Notes on Toxic plant chemicals:

Isoflavones, which are glycosides, can occur in red clover. These chemicals are plant estrogens that can cause infertility problems in livestock (Cheeke and Schull 1985).

Toxic plant chemicals:

isoflavones

References:

Cheeke, P. R., Shull, L. R. 1985. Natural toxicants in feeds and poisonous plants. AVI Publishing Company, Inc., Westport, Conn., USA. 492 pp.

Animals/Human Poisoning:

Note: When an animal is listed without additional information, the literature (as of 1993) contained no detailed explanation.

Cattle

General symptoms of poisoning:

[bloat](#)

[brachygnatha, superior](#)

[dwarfism](#)

[joint laxity](#)

References:

Cheeke, P. R., Shull, L. R. 1985. Natural toxicants in feeds and poisonous plants. AVI Publishing Company, Inc., Westport, Conn., USA. 492 pp.

Hall, J. W., Majak, W. 1989. Plant and animal factors in legume bloat. Pages 93-106 in Cheeke, P. R., ed. Toxicants of plant origin. Vol. III. Proteins and amino acids. CRC Press, Inc., Boca Raton, Fla., USA. 271 pp.

Ribble, C. S., Janzen, E. D., Proulx, J. G. 1989. Congenital joint laxity and dwarfism: a feed-associated congenital anomaly of beef calves in Canada. Can. Vet. J., 30: 331-338.

[Another search?](#)

[Français](#) | [Contact Us](#) | [Help](#) | [Search](#) | [Canada site](#)

[Coming Events](#) | [About CBIF](#) | [Links](#) | [Reports and Publications](#) | [Home](#)

Date modified: 2003-02-06

[Important Notices](#)



Français	Contact us	Help	Search	Canada site
Coming events	About CBIF	Links	Reports and publications	Home

Canadian Biodiversity Information Facility



Notes on poisoning: *Trifolium repens*

[Introduction](#)

[Interactive](#)

[All poisonous plants by Botanical name](#)

[All poisonous plants by Common name](#)

[Important WWW Poisonous Plants sites](#)

General poisoning notes:

White clover (*Trifolium repens*) is widely cultivated across Canada and has also become naturalized throughout much of the country. Under certain circumstances this valuable plant can cause problems in animals. White clover can cause bloat in livestock. It has caused laminitis in horses and cattle. After they are ingested, some varieties can liberate HCN, causing cyanogenic poisoning in animals. White clover is also reported to become estrogenic if infected with various fungi (Cooper and Johnson 1984, Cheeke and Schull 1985).



References:

Cooper, M. R., Johnson, A. W. 1984. Poisonous plants in Britain and their effects on animals and man. Her Majesty's Stationery Office, London, England. 305 pp.

Hall, J. W., Majak, W. 1989. Plant and animal factors in legume bloat. Pages 93-106 in Cheeke, P. R., ed. Toxicants of plant origin. Vol. III. Proteins and amino acids. CRC Press, Inc., Boca Raton, Fla., USA. 271 pp.

Nomenclature:

Scientific Name: *Trifolium repens* L.

Vernacular name(s): white clover

Scientific family name: *Leguminosae*

Vernacular family name: pea

Go to ITIS*^{ca} for more taxonomic information on: [Trifolium repens](#)

References:

Agriculture Quebec. 1975. Noms des maladies des plantes du

Canada/ Names of plant diseases in Canada. , Quebec City, Que., Canada. 288 pp.

Alex, J. F., Cayouette, R., Mulligan, G. A. 1980. Common and botanical names of weeds in Canada/Noms populaire et scientifiques des plantes nuisibles du Canada. Revised. Agric. Can. Publ., Ottawa, Ont., Canada. 132 pp.

Bailey, L. H., Bailey, E. Z. 1976. Hortus third. Revised. MacMillan, New York, N.Y., USA. 1290 pp.

Scoggan, H. J. 1978, 1979. The flora of Canada. Nat. Mus. Nat. Sci. (Ottawa) Publ. Bot. 7(1)-7(4). 1711 pp.

Van Wijk, H. L. 1911. A dictionary of plant names. Martinus Nijhoff, The Hague, The Netherlands. 1444 pp.

Victorin, M. 1964. Flore Laurentienne. 2nd ed. Univ. Montreal, Montreal, Que., Canada. 952 pp.

Geographic Information

Alberta
British Columbia
Labrador
Manitoba
New Brunswick
Northwest Territories
Nova Scotia
Ontario
Prince Edward Island
Quebec
Saskatchewan
Yukon Territory

References:

Bailey, L. H., Bailey, E. Z. 1976. Hortus third. Revised. MacMillan, New York, N.Y., USA. 1290 pp.

Boivin, B. 1966, 1967. Énumération des plantes du Canada. Provencheria 6. Nat. Can. (Que.) 93: 253-274; 371-437; 583-646; 989-1063. 94: 131-157; 471-528; 625-655.

Image or illustration

Trifolium repens:

Images: images.google.com

Toxic parts:

all parts

References:

Cooper, M. R., Johnson, A. W. 1984. Poisonous plants in Britain and their effects on animals and man. Her Majesty's Stationery Office, London, England. 305 pp.

Notes on Toxic plant chemicals:

Two cyanogenic glycosides, linamarin and lotaustralin, are found in white clover. In young leaves, the cyanogen levels may reach 350 mg of HCN per 100 g of tissue, with lotaustralin predominating.

Cyanogenesis is controlled by two independently inherited genes in white clover. Only plants possessing at least one dominant functional allele of both genes liberate HCN when damaged. Some cultivars are capable of liberating HCN and others are not (Poultan 1989).

Toxic plant chemicals:

linamarin

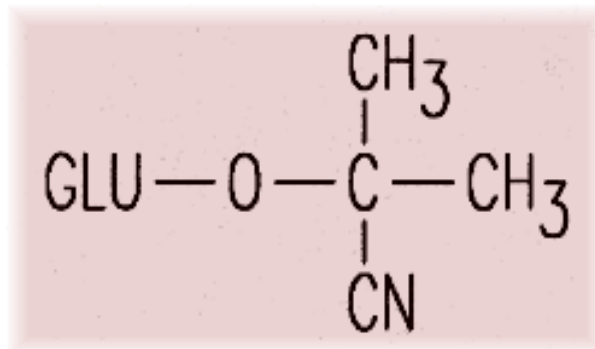

lotaustralin

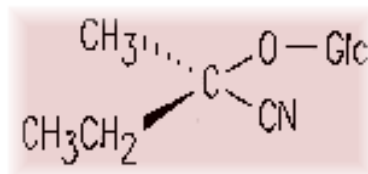

Chemical diagram(s) are courtesy of [Ruth McDiarmid](#), Biochemistry Technician, Kamloops Range Station, Agriculture and Agri-Food Canada, Kamloops, British Columbia, Canada.

References:

Poulton, J. E. 1983. Cyanogenic compounds in plants and their toxic effects. Pages 117-157 in Keeler, R. F., Tu, A. T., eds. Handbook of natural toxins. Vol. 1. Plant and Fungal toxins. Marcel Dekker, Inc., New York, N.Y., USA. 934 pp.

Animals/Human Poisoning:

Note: When an animal is listed without additional information, the literature (as of 1993) contained no detailed explanation.

Cattle

General symptoms of poisoning:

[bloat](#)

References:

Hall, J. W., Majak, W. 1989. Plant and animal factors in legume bloat. Pages 93-106 in Cheeke, P. R., ed. Toxicants of plant origin. Vol. III. Proteins and amino acids. CRC Press, Inc., Boca Raton, Fla., USA. 271 pp.

Horses

General symptoms of poisoning:

[laminitis](#)

Notes on poisoning:

Laminitis is characterized by tenderness, swelling, and inflammation around the hooves. In Britain severe laminitis has been reported in cattle as well (Cooper and Johnson 1984).

References:

Cooper, M. R., Johnson, A. W. 1984. Poisonous plants in Britain and their effects on animals and man. Her Majesty's Stationery Office, London, England. 305 pp.

[Another search?](#)

[Français](#) | [Contact Us](#) | [Help](#) | [Search](#) | [Canada site](#)

[Coming Events](#) | [About CBIF](#) | [Links](#) | [Reports and Publications](#) |

[Home](#)

Date modified: 2003-02-06

[Important Notices](#)



Français	Contact us	Help	Search	Canada site
Coming events	About CBIF	Links	Reports and publications	Home

Canadian Biodiversity Information Facility



Notes on poisoning: *Triglochin maritima*

[Introduction](#)[Interactive](#)[All poisonous plants by Botanical name](#)[All poisonous plants by Common name](#)[Important WWW Poisonous Plants sites](#)

General poisoning notes:

Seaside arrow-grass (*Triglochin maritima*) is a native plant found sporadically across Canada in saline, brackish, or fresh marshes and shores. This plant contains cyanogenic glycosides, which can release HCN during mastication by animals. Poisoning occurs primarily with ruminants, including cattle and sheep. The concentration of toxic chemicals increases during times of moisture depletion (Majak et al. 1980, Cooper and Johnson 1984, Poulton 1989).

References:

Beath, O. A., Draize, J. H., Eppson, H. F. 1933. Arrow grass - chemical and physiological considerations. Univ. Wyo. Agric. Exp. Stn. Bull., 193. 36 pp.

Cooper, M. R., Johnson, A. W. 1984. Poisonous plants in Britain and their effects on animals and man. Her Majesty's Stationery Office, London, England. 305 pp.

Nomenclature:

Scientific Name: *Triglochin maritima* L.

Vernacular name(s): seaside arrow-grass

Scientific family name: *Juncaginaceae*

Vernacular family name: arrow-grass

Go to ITIS^{*ca} for more taxonomic information on: [Triglochin maritima](#)

References:

Agriculture Quebec. 1975. Noms des maladies des plantes du

Canada/ Names of plant diseases in Canada. , Quebec City, Que., Canada. 288 pp.

Alex, J. F., Cayouette, R., Mulligan, G. A. 1980. Common and botanical names of weeds in Canada/Noms populaire et scientifiques des plantes nuisibles du Canada. Revised. Agric. Can. Publ., Ottawa, Ont., Canada. 132 pp.

Bailey, L. H., Bailey, E. Z. 1976. Hortus third. Revised. MacMillan, New York, N.Y., USA. 1290 pp.

Scoggan, H. J. 1978, 1979. The flora of Canada. Nat. Mus. Nat. Sci. (Ottawa) Publ. Bot. 7(1)-7(4). 1711 pp.

Van Wijk, H. L. 1911. A dictionary of plant names. Martinus Nijhoff, The Hague, The Netherlands. 1444 pp.

Victorin, M. 1964. Flore Laurentienne. 2nd ed. Univ. Montreal, Montreal, Que., Canada. 952 pp.

Geographic Information

Alberta
British Columbia
Labrador
Manitoba
New Brunswick
Northwest Territories
Nova Scotia
Ontario
Prince Edward Island
Quebec
Saskatchewan
Yukon Territory

References:

Bailey, L. H., Bailey, E. Z. 1976. Hortus third. Revised. MacMillan, New York, N.Y., USA. 1290 pp.

Boivin, B. 1966, 1967. Énumération des plantes du Canada. Provencheria 6. Nat. Can. (Que.) 93: 253-274; 371-437; 583-646; 989-1063. 94: 131-157; 471-528; 625-655.

Image or illustration

Triglochin maritima:

Images: images.google.com

Toxic parts:

all parts
flowers
leaves

References:

Majak, W., McDiarmid, R. E., Hall, J. W., Van Ryswyk, A. L. 1980. Seasonal variation in the cyanide potential of arrowgrass (*Triglochin maritima*). *Can. J. Plant Sci.*, 60: 1235-1241.

Notes on Toxic plant chemicals:

Two cyanogenic glycosides, triglochinin and taxiphillin, have been found in seaside arrow-grass. The cyanogenic levels in leaves are substantially elevated during periods of severe moisture stress. Newly initiated spikes (flowering stalks) yielded high levels of glycosides. Spikes therefore pose a potential threat if they are selectively grazed. A cyanogenic glycoside content of 50 mg/100 g of green seaside arrow-grass is considered lethal, even if only 0.5% of body weight is ingested (Majak et al. 1980, Cooper and Johnson 1984).

Toxic plant chemicals:

taxiphillin

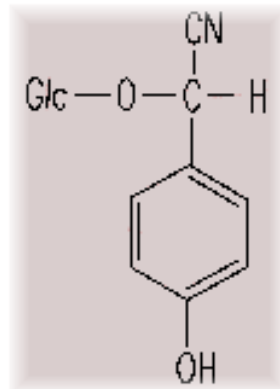

triglochinin

Chemical diagram(s) are courtesy of [Ruth McDiarmid](#), Biochemistry Technician, Kamloops Range Station, Agriculture and Agri-Food Canada, Kamloops, British Columbia, Canada.

References:

Majak, W., McDiarmid, R. E., Hall, J. W., Van Ryswyk, A. L. 1980. Seasonal variation in the cyanide potential of arrowgrass (*Triglochin maritima*). *Can. J. Plant Sci.*, 60: 1235-1241.

Poulton, J. E. 1983. Cyanogenic compounds in plants and their toxic effects. Pages 117-157 in Keeler, R. F., Tu, A. T., eds. Handbook of natural toxins. Vol. 1. Plant and Fungal toxins. Marcel Dekker, Inc., New York, N.Y., USA. 934 pp.

Animals/Human Poisoning:

Note: When an animal is listed without additional information, the literature (as of 1993) contained no detailed explanation.

Cattle

General symptoms of poisoning:

[convulsions](#)

[death by asphyxiation](#)

[nervousness](#)

[recumbency](#)

[trembling](#)

[vomiting](#)

Notes on poisoning:

Cyanide poisoning from seaside arrow-grass is similar to symptoms discussed under sheep.

References:

Cooper, M. R., Johnson, A. W. 1984. Poisonous plants in Britain and their effects on animals and man. Her Majesty's Stationery Office, London, England. 305 pp.

Sheep

General symptoms of poisoning:

[convulsions](#)

[death by asphyxiation](#)

[nervousness](#)

[recumbency](#)

[salivation](#)

[trembling](#)

[vomiting](#)

Notes on poisoning:

Cyanide poisoning of sheep by seaside arrow-grass includes the following symptoms: nervousness, trembling, erratic breathing, convulsions, recumbency, and death. Postmortem findings reveal bright red blood and the smell of bitter almonds in the stomach.

Treatment, if started early enough, can be successful. Intravenous injections of an aqueous solution of sodium thiosulfate have proved to be effective (Cooper and Johnson 1984).

References:

Cooper, M. R., Johnson, A. W. 1984. Poisonous plants in Britain and their effects on animals and man. Her Majesty's Stationery Office, London, England. 305 pp.

[Another search?](#)

[Français](#) | [Contact Us](#) | [Help](#) | [Search](#) | [Canada site](#)

[Coming Events](#) | [About CBIF](#) | [Links](#) | [Reports and Publications](#) | [Home](#)

Date modified: 2003-02-06

[Important Notices](#)



Français	Contact us	Help	Search	Canada site
Coming events	About CBIF	Links	Reports and publications	Home

Canadian Biodiversity Information Facility



Notes on poisoning: *Triglochin palustre*

[Introduction](#)[Interactive](#)[All poisonous plants by Botanical name](#)[All poisonous plants by Common name](#)[Important WWW Poisonous Plants sites](#)

General poisoning notes:

Marsh arrow-grass (*Triglochin palustre*) is a native plant that is found sporadically across Canada in damp brackish or calcareous places. A cyanogenic glycoside, triglochinin, is found in the plant. This chemical becomes more abundant during times of moisture depletion within the plants. Occasional poisoning occurs with cattle and sheep in the lower Cariboo district of British Columbia (Majak et al. 1980, Looman et al. 1983).

References:

Cooper, M. R., Johnson, A. W. 1984. Poisonous plants in Britain and their effects on animals and man. Her Majesty's Stationery Office, London, England. 305 pp.

Looman, J., Majak, W., Smoliak, S. 1983. Stock-poisoning plants of western Canada. Agric. Can. Res. Branch Contrib. 1982-7E. 35 pp.

Nomenclature:

Scientific Name: *Triglochin palustre* L.

Vernacular name(s): marsh arrow-grass

Scientific family name: *Juncaginaceae*

Vernacular family name: arrow-grass

Go to ITIS*^{ca} for more taxonomic information on: [Triglochin palustre](#)

References:

Agriculture Quebec. 1975. Noms des maladies des plantes du Canada/ Names of plant diseases in Canada. , Quebec City, Que.,

Canada. 288 pp.

Alex, J. F., Cayouette, R., Mulligan, G. A. 1980. Common and botanical names of weeds in Canada/Noms populaire et scientifiques des plantes nuisibles du Canada. Revised. Agric. Can. Publ., Ottawa, Ont., Canada. 132 pp.

Bailey, L. H., Bailey, E. Z. 1976. Hortus third. Revised. MacMillan, New York, N.Y., USA. 1290 pp.

Scoggan, H. J. 1978, 1979. The flora of Canada. Nat. Mus. Nat. Sci. (Ottawa) Publ. Bot. 7(1)-7(4). 1711 pp.

Van Wijk, H. L. 1911. A dictionary of plant names. Martinus Nijhoff, The Hague, The Netherlands. 1444 pp.

Victorin, M. 1964. Flore Laurentienne. 2nd ed. Univ. Montreal, Montreal, Que., Canada. 952 pp.

Geographic Information

Alberta
British Columbia
Labrador
Manitoba
New Brunswick
Northwest Territories
Nova Scotia
Ontario
Prince Edward Island
Quebec
Saskatchewan
Yukon Territory

References:

Bailey, L. H., Bailey, E. Z. 1976. Hortus third. Revised. MacMillan, New York, N.Y., USA. 1290 pp.

Boivin, B. 1966, 1967. Énumération des plantes du Canada. Provencheria 6. Nat. Can. (Que.) 93: 253-274; 371-437; 583-646; 989-1063. 94: 131-157; 471-528; 625-655.

Image or illustration

Triglochin palustre:

Images: images.google.com

Toxic parts:

flowers

leaves

References:

Majak, W., McDiarmid, R. E., Hall, J. W., Van Ryswyk, A. L. 1980. Seasonal variation in the cyanide potential of arrowgrass (*Triglochin maritima*). Can. J. Plant Sci., 60: 1235-1241.

Notes on Toxic plant chemicals:

A cyanogenic glycoside, triglochinin, is found in marsh arrow-grass. This chemical is also the main toxic component of seaside arrow-grass (Majak et al. 1980).

Toxic plant chemicals:

triglochinin

References:

Majak, W., McDiarmid, R. E., Hall, J. W., Van Ryswyk, A. L. 1980. Seasonal variation in the cyanide potential of arrowgrass (*Triglochin maritima*). Can. J. Plant Sci., 60: 1235-1241.

Animals/Human Poisoning:

Note: When an animal is listed without additional information, the literature (as of 1993) contained no detailed explanation.

Cattle

General symptoms of poisoning:

[convulsions](#)

[death](#)

[nervousness](#)

[recumbency](#)

[salivation](#)

Notes on poisoning:

In all animals, symptoms of poisoning are similar to those of cyanide poisoning, including convulsions, nervousness, trembling, and recumbency, followed by death. The blood is bright red (Looman et al. 1983).

References:

Looman, J., Majak, W., Smoliak, S. 1983. Stock-poisoning plants

of western Canada. Agric. Can. Res. Branch Contrib. 1982-7E.
35 pp.

Sheep

General symptoms of poisoning:

[convulsions](#)

[nervousness](#)

[recumbency](#)

[salivation](#)

References:

Cooper, M. R., Johnson, A. W. 1984. Poisonous plants in Britain and their effects on animals and man. Her Majesty's Stationery Office, London, England. 305 pp.

[Another search?](#)

[Français](#) | [Contact Us](#) | [Help](#) | [Search](#) | [Canada site](#)

[Coming Events](#) | [About CBIF](#) | [Links](#) | [Reports and Publications](#) | [Home](#)

Date modified: 2003-02-06

[Important Notices](#)



Français	Contact us	Help	Search	Canada site
Coming events	About CBIF	Links	Reports and publications	Home

Canadian Biodiversity Information Facility



Notes on poisoning: *Tulipa gesneriana*

[Introduction](#)[Interactive](#)[All poisonous plants by Botanical name](#)[All poisonous plants by Common name](#)[Important WWW Poisonous Plants sites](#)

General poisoning notes:

Tulip (*Tulipa* spp.), including *Tulipa gesneriana*, is a widely cultivated plant used as a perennial spring flower in Canada. Many species and hybrids as well as numerous cultivars of tulips may be found in Canada. Tulips contain an allergen, tuliposide A, which causes dermatitis in sensitive individuals. Poisoning of humans and dogs has also been reported when tulip bulbs mistaken for onions were ingested. The allergen tuliposide A is also found in the Peruvian lily (*Alstroemeria* spp.), and there is cross-sensitivity to onion and garlic (*Allium* spp). Tulips are not normally a problem to humans, but sensitive individuals should avoid touching the plants (Mitchell and Rook 1979, Cooper and Johnson 1984).

References:

Cooper, M. R., Johnson, A. W. 1984. Poisonous plants in Britain and their effects on animals and man. Her Majesty's Stationery Office, London, England. 305 pp.

Marks, J. G. 1988. Allergic contact dermatitis to *Alstroemeria*. Arch. Dermatol., 124: 914-916.

Mitchell, J. C., Rook, A. 1979. Botanical dermatology. Greenglass Ltd, Vancouver, B.C., Canada. 787 pp.

Nomenclature:

Scientific Name: *Tulipa gesneriana* L.

Vernacular name(s): tulip

Scientific family name: *Liliaceae*

Vernacular family name: lily

Go to ITIS^{*ca} for more taxonomic information on: [Tulipa gesneriana](#)

References:

Agriculture Quebec. 1975. Noms des maladies des plantes du Canada/ Names of plant diseases in Canada. , Quebec City, Que., Canada. 288 pp.

Alex, J. F., Cayouette, R., Mulligan, G. A. 1980. Common and botanical names of weeds in Canada/Noms populaire et scientifiques des plantes nuisibles du Canada. Revised. Agric. Can. Publ., Ottawa, Ont., Canada. 132 pp.

Bailey, L. H., Bailey, E. Z. 1976. Hortus third. Revised. MacMillan, New York, N.Y., USA. 1290 pp.

Scoggan, H. J. 1978, 1979. The flora of Canada. Nat. Mus. Nat. Sci. (Ottawa) Publ. Bot. 7(1)-7(4). 1711 pp.

Van Wijk, H. L. 1911. A dictionary of plant names. Martinus Nijhoff, The Hague, The Netherlands. 1444 pp.

Victorin, M. 1964. Flore Laurentienne. 2nd ed. Univ. Montreal, Montreal, Que., Canada. 952 pp.

Geographic Information

Plant or plant parts used in or around the home.

References:

Bailey, L. H., Bailey, E. Z. 1976. Hortus third. Revised. MacMillan, New York, N.Y., USA. 1290 pp.

Boivin, B. 1966, 1967. Énumération des plantes du Canada. Provencheria 6. Nat. Can. (Que.) 93: 253-274; 371-437; 583-646; 989-1063. 94: 131-157; 471-528; 625-655.

Image or illustration

Tulipa gesneriana:

Images: images.google.com

Notes on Poisonous plant parts:

Tulips contain an allergen that causes dermatitis in sensitive individuals. The allergen concentration is highest in the bulbs, less in the stem and leaves, and least in the flowers. The allergen decreases in the outermost leaves immediately before harvest

time. Some cultivars of tulips cause less severe dermatitis than others (Mitchell and Rook 1979).

Toxic parts:

bulb - dust of
bulbs
leaves
stems

References:

Mitchell, J. C., Rook, A. 1979. Botanical dermatology. Greenglass Ltd, Vancouver, B.C., Canada. 787 pp.

Notes on Toxic plant chemicals:

Tuliposide A is the precursor of the sensitizing agent called alpha-methylene-gamma-butyrolactone (tulipalin A), which results from the hydrolysis of tuliposide A and the lactonization of its aglycone. This chemical causes dermatitis in sensitive individuals (Mitchell and Rook 1979).

Toxic plant chemicals:

tuliposide A

References:

Mitchell, J. C., Rook, A. 1979. Botanical dermatology. Greenglass Ltd, Vancouver, B.C., Canada. 787 pp.

Animals/Human Poisoning:

Note: When an animal is listed without additional information, the literature (as of 1993) contained no detailed explanation.

Dogs

Humans

General symptoms of poisoning:

[breathing, labored](#)

[eczema](#)

[erythema](#)

[nausea](#)

[salivation](#)

[sweating](#)

[vomiting](#)

[weakness](#)

Notes on poisoning:

A few cases of poisoning have occurred after tulip bulbs were ingested either to supplement food or when the bulbs were mistaken for onions. Symptoms included nausea, salivation, sweating, difficult breathing, and palpitations. Weakness persisted for days and vomiting occurred (Cooper and Johnson 1984).

References:

Cooper, M. R., Johnson, A. W. 1984. Poisonous plants in Britain and their effects on animals and man. Her Majesty's Stationery Office, London, England. 305 pp.

Mitchell, J. C., Rook, A. 1979. Botanical dermatology. Greenglass Ltd, Vancouver, B.C., Canada. 787 pp.

[Another search?](#)

[Français](#) | [Contact Us](#) | [Help](#) | [Search](#) | [Canada site](#)

[Coming Events](#) | [About CBIF](#) | [Links](#) | [Reports and Publications](#) |

[Home](#)

Date modified: 2003-02-06

[Important Notices](#)



Français	Contact us	Help	Search	Canada site
Coming events	About CBIF	Links	Reports and publications	Home

Canadian Biodiversity Information Facility



Notes on poisoning: *Urtica dioica*

[Introduction](#)[Interactive](#)[All poisonous plants by Botanical name](#)[All poisonous plants by Common name](#)[Important WWW Poisonous Plants sites](#)

General poisoning notes:

Stinging nettle (*Urtica dioica*) is found across Canada and includes a wide-ranging native subspecies and an introduced subspecies found in the Maritime Provinces. The plant can form large colonies in orchards, farmyards, old pastures, ditches, and waste places. The stinging hairs readily break, allowing the secretions to enter skin. Humans receive a painful sting, followed by a small reddish swelling and prolonged itching and numbness. Initial reactions last only a few minutes but repeated contact can cause the pain to intensify and last for days. Hunting dogs in the United States were poisoned and died after massive exposure to the plants (Bassett et al. 1977, Mitchell and Rook 1979, Anon. 1982).

References:

- Anon. 1982. Stinging nettle (*Urtica* sp.) and dogs. *Vet. Hum. Toxicol.*, 24: 247.
- Bassett, I. J., [Crompton, C. W.](#), Woodland, D. W. 1977. The biology of Canadian weeds. 21. *Urtica dioica* L. *Can. J. Plant Sci.*, 57: 491-498.
- Mitchell, J. C., Rook, A. 1979. *Botanical dermatology*. Greenglass Ltd, Vancouver, B.C., Canada. 787 pp.

Nomenclature:

Scientific Name: *Urtica dioica* L.

Vernacular name(s): stinging nettle

Scientific family name: *Urticaceae*

Vernacular family name: nettle

Go to ITIS^{*ca} for more taxonomic information on: [Urtica dioica](#)

References:

Agriculture Quebec. 1975. Noms des maladies des plantes du Canada/ Names of plant diseases in Canada. , Quebec City, Que., Canada. 288 pp.

Alex, J. F., Cayouette, R., Mulligan, G. A. 1980. Common and botanical names of weeds in Canada/Noms populaire et scientifiques des plantes nuisibles du Canada. Revised. Agric. Can. Publ., Ottawa, Ont., Canada. 132 pp.

Bailey, L. H., Bailey, E. Z. 1976. Hortus third. Revised. MacMillan, New York, N.Y., USA. 1290 pp.

Scoggan, H. J. 1978, 1979. The flora of Canada. Nat. Mus. Nat. Sci. (Ottawa) Publ. Bot. 7(1)-7(4). 1711 pp.

Van Wijk, H. L. 1911. A dictionary of plant names. Martinus Nijhoff, The Hague, The Netherlands. 1444 pp.

Victorin, M. 1964. Flore Laurentienne. 2nd ed. Univ. Montreal, Montreal, Que., Canada. 952 pp.

Geographic Information

Alberta
British Columbia
Manitoba
New Brunswick
Newfoundland
Northwest Territories
Nova Scotia
Ontario
Prince Edward Island
Quebec
Saskatchewan
Yukon Territory

References:

Bailey, L. H., Bailey, E. Z. 1976. Hortus third. Revised. MacMillan, New York, N.Y., USA. 1290 pp.

Boivin, B. 1966, 1967. Énumération des plantes du Canada. Provencheria 6. Nat. Can. (Que.) 93: 253-274; 371-437; 583-646; 989-1063. 94: 131-157; 471-528; 625-655.

Image or illustration

Urtica dioica:

Images: images.google.com

Notes on Poisonous plant parts:

The stinging hairs on the stem, leaves, and flowers produce a painful sting. The hairs consist of a long shaft that narrows towards the point and has a small bulbous tip. The hair just below the tip is not silicified, unlike the rest of the hair, so that the tip is easily broken. A fine hollow shaft remains that can puncture the skin, through which secretions can enter (Mitchell and Rook 1979).

Toxic parts:

hairs

References:

Mitchell, J. C., Rook, A. 1979. Botanical dermatology. Greenglass Ltd, Vancouver, B.C., Canada. 787 pp.

Notes on Toxic plant chemicals:

The stinging hairs of stinging nettle contain the compounds acetylcholine, histamine, and 5-hydroxytryptamine. Acetylcholine is found naturally in mammals and is involved in firing nerves, whereas histamine causes swelling (Mitchell and Rook 1979).

Toxic plant chemicals:

acetylcholine
histamine
5-hydroxytryptamine

References:

Mitchell, J. C., Rook, A. 1979. Botanical dermatology. Greenglass Ltd, Vancouver, B.C., Canada. 787 pp.

Animals/Human Poisoning:

Note: When an animal is listed without additional information, the literature (as of 1993) contained no detailed explanation.

Dogs

General symptoms of poisoning:

[death](#)

[dyspnea](#)

[pain](#)

[trembling](#)

[vomiting](#)

Notes on poisoning:

Hunting dogs in the United States were poisoned after massive exposure to the hairs of stinging nettle. Symptoms included trembling, pain, slobbering, dyspnea, and vomiting. Some dogs died 2-3 days after exposure without treatment (Anon. 1982).

References:

Anon. 1982. Stinging nettle (*Urtica* sp.) and dogs. *Vet. Hum. Toxicol.*, 24: 247.

Humans

General symptoms of poisoning:

[erythema](#)

References:

Mitchell, J. C., Rook, A. 1979. *Botanical dermatology*. Greenglass Ltd, Vancouver, B.C., Canada. 787 pp.

[Another search?](#)

[Français](#) | [Contact Us](#) | [Help](#) | [Search](#) | [Canada site](#)

[Coming Events](#) | [About CBIF](#) | [Links](#) | [Reports and Publications](#) |

[Home](#)

Date modified: 2003-02-06

[Important Notices](#)



Français	Contact us	Help	Search	Canada site
Coming events	About CBIF	Links	Reports and publications	Home



Notes on poisoning: *Veratrum viride*

[Introduction](#)

[Interactive](#)

[All poisonous plants by Botanical name](#)

[All poisonous plants by Common name](#)

[Important WWW Poisonous Plants sites](#)

General poisoning notes:

False hellebore (*Veratrum viride*) is a native perennial plant that is found in parts of eastern and western Canada. The plant contains several steroidal alkaloids. Jervine was shown to be teratogenic in laboratory animals. Livestock do not often ingest the plant, but cattle, poultry, and sheep, have been poisoned. Some deaths may have occurred. The roots, rhizome, and young shoots are most toxic. Humans have been poisoned after ingesting the plant. Extracts from the plant have been used in cases of hypertension and as an insecticide (Fyles 1920, Dayton 1960, Campbell et al. 1985, Mulligan and Munro 1987, Jaffe et al. 1989).



References:

- Campbell, M. A., Brown, K. S., Hassell, J. R., Horigan, E. A., Keeler, R. F. 1985. Inhibition of limb chondrogenesis by a *Veratrum* alkaloid: temporal specificity in vivo and in vitro. Can. Dep. Agric. Exp. Farms Bull., 111: 464-470.
- Dayton, W. A. 1960. Notes on western range forbes. U. S. For. Serv. Wash. Agric. Hand., 161. 254 pp.
- Fyles, F. 1920. Principal poisonous plants of Canada. Can. Dep. Agric. Exp. Farms. Bull. 39. 112 pp.
- Jaffe, A. M., Gephardt, D., Courtemanche, L. 1990. Poisoning due to ingestion of *Veratrum viride* (false hellebore). J. Emerg. Med., 8: 161-167.
- Kingsbury, J. M. 1964. Poisonous plants of the United States and Canada. Prentice-Hall Inc., Englewood Cliffs, N.J., USA. 626 pp.
- Long, R. 1981. Some liliaceae of British Columbia. Davidsonia, 12: 85-88.
- Reynard, G. B., Norton, J. B. 1942. Poisonous plants of Maryland in relation to livestock. Univ. MD. Agric. Exp. Stn. Bull., A10. 312 pp.
- Underhill, J. E. 1959. A case of hellebore poisoning. Can. Field-Nat., 73: 128-129.

Nomenclature:

Scientific Name: *Veratrum viride* Ait.

Vernacular name(s): false hellebore

Scientific family name: *Liliaceae*

Vernacular family name: lily

Go to ITIS*ca for more taxonomic information on: [Veratrum viride](#)

References:

Agriculture Quebec. 1975. Noms des maladies des plantes du Canada/
Names of plant diseases in Canada. , Quebec City, Que., Canada. 288 pp.

Alex, J. F., Cayouette, R., Mulligan, G. A. 1980. Common and botanical names of weeds in Canada/Noms populaire et scientifiques des plantes nuisibles du Canada. Revised. Agric. Can. Publ., Ottawa, Ont., Canada. 132 pp.

Bailey, L. H., Bailey, E. Z. 1976. Hortus third. Revised. MacMillan, New York, N.Y., USA. 1290 pp.

Scoggan, H. J. 1978, 1979. The flora of Canada. Nat. Mus. Nat. Sci. (Ottawa) Publ. Bot. 7(1)-7(4). 1711 pp.

Van Wijk, H. L. 1911. A dictionary of plant names. Martinus Nijhoff, The Hague, The Netherlands. 1444 pp.

Victorin, M. 1964. Flore Laurentienne. 2nd ed. Univ. Montreal, Montreal, Que., Canada. 952 pp.

Geographic Information

Alberta

British Columbia

Labrador

New Brunswick

Northwest Territories

Quebec

Yukon Territory

References:

Bailey, L. H., Bailey, E. Z. 1976. Hortus third. Revised. MacMillan, New York, N.Y., USA. 1290 pp.

Boivin, B. 1966, 1967. Énumération des plantes du Canada. Provencheria 6. Nat. Can. (Que.) 93: 253-274; 371-437; 583-646; 989-1063. 94: 131-157; 471-528; 625-655.

Image or illustration

Veratrum viride:

Images: images.google.com

Notes on Poisonous plant parts:

The steroidal alkaloids are most abundant in roots, rhizomes, and young shoots. Sheep can apparently eat, with impunity, plants that were frosted in the autumn (Dayton 1960).

Toxic parts:

rhizome
roots
young shoots

References:

Campbell, M. A., Brown, K. S., Hassell, J. R., Horigan, E. A., Keeler, R. F. 1985. Inhibition of limb chondrogenesis by a *Veratrum* alkaloid: temporal specificity in vivo and in vitro. Can. Dep. Agric. Exp. Farms Bull., 111: 464-470.

Dayton, W. A. 1960. Notes on western range forbes. U. S. For. Serv. Wash. Agric. Hand., 161. 254 pp.

Notes on Toxic plant chemicals:

The steroidal alkaloid jervine has been isolated from false hellebore. This alkaloid can exert teratogenic effects in several animal species. The LD-50 for jervine in two strains of mice was 220 mg/kg and 260 mg/kg. Some strains of mice were resistant to the teratogenic effects of jervine (Campbell et al. 1985). Several other alkaloids have also been isolated. Germidine is an alkaloid that was studied as a possible drug for hypertension (Claus and Tyler 1965).

Toxic plant chemicals:

germidine
jervine

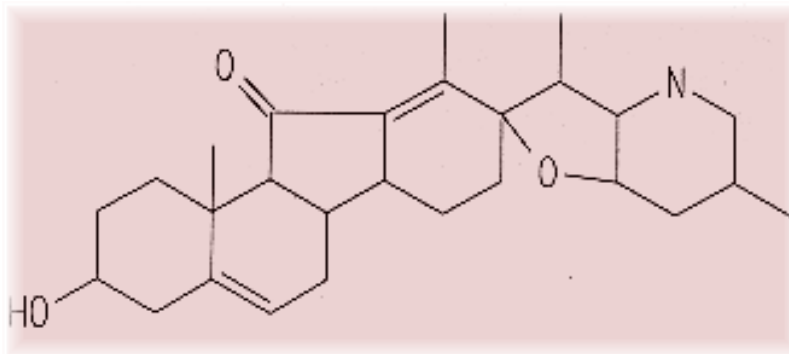

Chemical diagram(s) are courtesy of [Ruth McDiarmid](#), Biochemistry Technician, Kamloops Range Station, Agriculture and Agri-Food Canada, Kamloops, British Columbia, Canada.

References:

Campbell, M. A., Brown, K. S., Hassell, J. R., Horigan, E. A., Keeler, R. F. 1985. Inhibition of limb chondrogenesis by a *Veratrum* alkaloid: temporal specificity in vivo and in vitro. Can. Dep. Agric. Exp. Farms Bull., 111: 464-470.

Claus, E. P., Tyler, V. E. 1965. Pharmacognosy. Lea & Febiger, Philadelphia, Pa., USA. 572 pp.

Animals/Human Poisoning:

Note: When an animal is listed without additional information, the literature (as of 1993) contained no detailed explanation.

Cattle

General symptoms of poisoning:

[abdominal pains](#)

[blindness, temporary](#)

[diarrhea](#)

[heart rate, slow](#)

[vomiting](#)

Notes on poisoning:

Cattle generally avoid ingesting the plant, although young animals may ingest it, sometimes with fatal results. As with humans, the plant causes depression in an animal's heart rate, low blood pressure, and vomiting (Fyles 1920, Reynard and Norton 1942).

References:

Fyles, F. 1920. Principal poisonous plants of Canada. Can. Dep. Agric. Exp. Farms. Bull. 39. 112 pp.

Reynard, G. B., Norton, J. B. 1942. Poisonous plants of Maryland in relation to livestock. Univ. MD. Agric. Exp. Stn. Bull., A10. 312 pp.

Humans

General symptoms of poisoning:

[blood pressure, low](#)

[heart rate, slow](#)

[nausea](#)

[vomiting](#)

Notes on poisoning:

Humans have ingested false hellebore, mistaking it for another plant. The symptoms include reduced heart rate, low blood pressure, and vomiting. Other symptoms include blurred vision, cramps, nausea, dizziness, and chills. Atropine is used in initial treatment (Boivin 1948, Underhill 1959, Jaffe et al. 1989). False hellebore was used by West Coast Indians to commit suicide (Long 1981).

References:

- Jaffe, A. M., Gephardt, D., Courtemanche, L. 1990. Poisoning due to ingestion of *Veratrum viride* (false hellebore). J. Emerg. Med., 8: 161-167.
- Long, R. 1981. Some liliaceae of British Columbia. Davidsonia, 12: 85-88.
- Underhill, J. E. 1959. A case of hellebore poisoning. Can. Field-Nat., 73: 128-129.

Poultry

Rodents

General symptoms of poisoning:

[oligodactylism](#)

References:

- Campbell, M. A., Brown, K. S., Hassell, J. R., Horigan, E. A., Keeler, R. F. 1985. Inhibition of limb chondrogenesis by a *Veratrum* alkaloid: temporal specificity in vivo and in vitro. Can. Dep. Agric. Exp. Farms Bull., 111: 464-470.

Sheep

General symptoms of poisoning:

[nausea](#)

[salivation](#)

Notes on poisoning:

Sheep are apparently less affected by ingesting false hellebore and can eat the leaves with apparent impunity after the leaves have been killed by frost (Reynard and Norton 1942, Dayton 1960).

References:

Dayton, W. A. 1960. Notes on western range forbes. U. S. For. Serv. Wash. Agric. Hand., 161. 254 pp.

Reynard, G. B., Norton, J. B. 1942. Poisonous plants of Maryland in relation to livestock. Univ. MD. Agric. Exp. Stn. Bull., A10. 312 pp.

[Another search?](#)

[Français](#) | [Contact Us](#) | [Help](#) | [Search](#) | [Canada site](#)

[Coming Events](#) | [About CBIF](#) | [Links](#) | [Reports and Publications](#) | [Home](#)

Date modified: 2003-02-06

[Important Notices](#)



Français	Contact us	Help	Search	Canada site
Coming events	About CBIF	Links	Reports and publications	Home

Canadian Biodiversity Information Facility



Notes on poisoning: *Viburnum opulus*

[Introduction](#)[Interactive](#)[All poisonous plants by Botanical name](#)[All poisonous plants by Common name](#)[Important WWW Poisonous Plants sites](#)

General poisoning notes:

Guelder-rose (*Viburnum opulus*) was introduced as a cultivated ornamental and can grow across southern Canada. Occasionally, the shrub may become naturalized. The fears of serious poisoning reported in older literature seem unfounded. Humans who ingest the berries may experience mild symptoms (Frohne and Pfander 1983).



References:

Frohne, D., Pfander, H. J. 1983. A colour atlas of poisonous plants. Wolfe Publishing Ltd., London, England. 291 pp.

Nomenclature:

Scientific Name: *Viburnum opulus* L.

Vernacular name(s): Guelder-rose

Scientific family name: *Caprifoliaceae*

Vernacular family name: honeysuckle

Go to ITIS^{*ca} for more taxonomic information on: [Viburnum opulus](#)

References:

Agriculture Quebec. 1975. Noms des maladies des plantes du Canada/ Names of plant diseases in Canada. , Quebec City, Que., Canada. 288 pp.

Alex, J. F., Cayouette, R., Mulligan, G. A. 1980. Common and botanical names of weeds in Canada/Noms populaire et scientifiques des plantes nuisibles du Canada. Revised. Agric. Can. Publ., Ottawa, Ont., Canada. 132 pp.

Bailey, L. H., Bailey, E. Z. 1976. Hortus third. Revised. MacMillan, New York, N.Y., USA. 1290 pp.

Scoggan, H. J. 1978, 1979. The flora of Canada. Nat. Mus. Nat. Sci. (Ottawa) Publ. Bot. 7(1)-7(4). 1711 pp.

Van Wijk, H. L. 1911. A dictionary of plant names. Martinus Nijhoff, The Hague, The Netherlands. 1444 pp.

Victorin, M. 1964. Flore Laurentienne. 2nd ed. Univ. Montreal, Montreal, Que., Canada. 952 pp.

Geographic Information

Plant or plant parts used in or around the home.

References:

Bailey, L. H., Bailey, E. Z. 1976. Hortus third. Revised. MacMillan, New York, N.Y., USA. 1290 pp.

Boivin, B. 1966, 1967. Énumération des plantes du Canada. Provencheria 6. Nat. Can. (Que.) 93: 253-274; 371-437; 583-646; 989-1063. 94: 131-157; 471-528; 625-655.

Image or illustration

Viburnum opulus:

Images: images.google.com

Toxic parts:

immature fruit

References:

Frohne, D., Pfander, H. J. 1983. A colour atlas of poisonous plants. Wolfe Publishing Ltd., London, England. 291 pp.

Animals/Human Poisoning:

Note: When an animal is listed without additional information, the literature (as of 1993) contained no detailed explanation.

Humans

General symptoms of poisoning:

[diarrhea](#)

[vomiting](#)

Notes on poisoning:

The older European literature suggests that ingesting the berries can cause serious poisoning or even death. However, no recent cases of serious poisoning have been reported. Ingesting the fruits can cause diarrhea or vomiting if unripe berries or large quantities of berries are eaten (Frohne and Pfander 1983).

References:

Frohne, D., Pfander, H. J. 1983. A colour atlas of poisonous plants. Wolfe Publishing Ltd., London, England. 291 pp.

[Another search?](#)

[Français](#) | [Contact Us](#) | [Help](#) | [Search](#) | [Canada site](#)

[Coming Events](#) | [About CBIF](#) | [Links](#) | [Reports and Publications](#) | [Home](#)

Date modified: 2003-02-06

[Important Notices](#)



Français	Contact us	Help	Search	Canada site
Coming events	About CBIF	Links	Reports and publications	Home

Canadian Biodiversity Information Facility



Notes on poisoning: *Vicia faba*

[Introduction](#)[Interactive](#)[All poisonous plants by Botanical name](#)[All poisonous plants by Common name](#)[Important WWW Poisonous Plants sites](#)

General poisoning notes:

Broad bean (*Vicia faba*) is a cultivated plant that is grown occasionally in Canada. The beans are used as human food and are being evaluated as a protein supplement for livestock. Broad beans are not poisonous to humans in the conventional sense, but they cause favism in susceptible individuals. These individuals have a genetically transmitted, male sex-linked deficiency to the enzyme glucose-6-phosphate dehydrogenase. Certain groups such as Oriental Jews, Mediterranean Europeans, Arabs, Asians, and blacks may have the deficiency. The disease can cause death in severe cases. Livestock, including swine, have also been poisoned from ingesting high quantities of beans. Dietary broad beans can also cause metabolic problems in poultry. It is important to note that nonsusceptible persons who eat broad beans are not at risk (Kingsbury 1964, Cooper and Johnson 1984, Cheeke and Schull 1985, Roy and Spencer 1989).

References:

Cheeke, P. R., Shull, L. R. 1985. Natural toxicants in feeds and poisonous plants. AVI Publishing Company, Inc., Westport, Conn., USA. 492 pp.

Cooper, M. R., Johnson, A. W. 1984. Poisonous plants in Britain and their effects on animals and man. Her Majesty's Stationery Office, London, England. 305 pp.

Kingsbury, J. M. 1964. Poisonous plants of the United States and Canada. Prentice-Hall Inc., Englewood Cliffs, N.J., USA. 626 pp.

Liener, I. E. 1989. Antinutritional factors. Pages 339-382 in Matthews, R. H., ed. Legumes: chemistry, technology, and human nutrition. Marcel Dekker, Inc., New York, N.Y., USA. 934 pp.

Nomenclature:

Scientific Name: *Vicia faba* L.

Vernacular name(s): broad bean

Scientific family name: *Leguminosae*

Vernacular family name: pea

Go to ITIS^{*ca} for more taxonomic information on: [Vicia faba](#)

References:

Agriculture Quebec. 1975. Noms des maladies des plantes du Canada/ Names of plant diseases in Canada. , Quebec City, Que., Canada. 288 pp.

Alex, J. F., Cayouette, R., Mulligan, G. A. 1980. Common and botanical names of weeds in Canada/Noms populaire et scientifiques des plantes nuisibles du Canada. Revised. Agric. Can. Publ., Ottawa, Ont., Canada. 132 pp.

Bailey, L. H., Bailey, E. Z. 1976. Hortus third. Revised. MacMillan, New York, N.Y., USA. 1290 pp.

Scoggan, H. J. 1978, 1979. The flora of Canada. Nat. Mus. Nat. Sci. (Ottawa) Publ. Bot. 7(1)-7(4). 1711 pp.

Van Wijk, H. L. 1911. A dictionary of plant names. Martinus Nijhoff, The Hague, The Netherlands. 1444 pp.

Victorin, M. 1964. Flore Laurentienne. 2nd ed. Univ. Montreal, Montreal, Que., Canada. 952 pp.

Geographic Information

Plant or plant parts used in or around the home.

References:

Bailey, L. H., Bailey, E. Z. 1976. Hortus third. Revised. MacMillan, New York, N.Y., USA. 1290 pp.

Boivin, B. 1966, 1967. Énumération des plantes du Canada. Provencheria 6. Nat. Can. (Que.) 93: 253-274; 371-437; 583-646; 989-1063. 94: 131-157; 471-528; 625-655.

Image or illustration

Vicia faba:

Images: images.google.com

Notes on Poisonous plant parts:

Susceptible individuals who ingest raw or partly cooked seeds and inhale pollen can be poisoned (Cooper and Johnson 1984).

Toxic parts:

pollen
seeds

References:

Cooper, M. R., Johnson, A. W. 1984. Poisonous plants in Britain and their effects on animals and man. Her Majesty's Stationery Office, London, England. 305 pp.

Notes on Toxic plant chemicals:

Two glycosides, convicine and vicine, and their respective aglycones, isouramil and divicine, are implicated in favism. In individuals with glucose-6-phosphate dehydrogenase (G6PD) deficiency, a cycle is prevented that would normally reduce the oxidants so that they cannot attack the red cell membrane (Cheeke and Schull 1985).

Toxic plant chemicals:

convicine
vicine

References:

Cheeke, P. R., Shull, L. R. 1985. Natural toxicants in feeds and poisonous plants. AVI Publishing Company, Inc., Westport, Conn., USA. 492 pp.

Liener, I. E. 1989. Antinutritional factors. Pages 339-382 in Matthews, R. H., ed. Legumes: chemistry, technology, and human nutrition. Marcel Dekker, Inc., New York, N.Y., USA. 934 pp.

Animals/Human Poisoning:

Note: When an animal is listed without additional information, the literature (as of 1993) contained no detailed explanation.

Chickens

General symptoms of poisoning:

[egg production, reduced](#)

Notes on poisoning:

Unprocessed broad beans contain factors that lower the rate of chicken growth and alter the size of liver and pancreas. Dietary broad beans have a marked influence on the metabolism of laying hens. Vicine, which is thermostable, causes a reduction in the number of ova, in egg weight, in fertility, and in egg hatchability (Cheeke and Schull 1985).

References:

Cheeke, P. R., Shull, L. R. 1985. Natural toxicants in feeds and poisonous plants. AVI Publishing Company, Inc., Westport, Conn., USA. 492 pp.

Humans

General symptoms of poisoning:

[abdominal pains](#)

[collapse](#)

[death](#)

[dizziness](#)

[Heinz bodies](#)

[hemoglobinuria](#)

[icterus](#)

[jaundice](#)

[methemoglobinemia](#)

[temperature, elevated](#)

[vomiting](#)

References:

Cheeke, P. R., Shull, L. R. 1985. Natural toxicants in feeds and poisonous plants. AVI Publishing Company, Inc., Westport, Conn., USA. 492 pp.

Cooper, M. R., Johnson, A. W. 1984. Poisonous plants in Britain and their effects on animals and man. Her Majesty's Stationery Office, London, England. 305 pp.

Swine

General symptoms of poisoning:

[abdominal pains](#)

[appetite, loss of](#)

[constipation](#)

[depression](#)

Notes on poisoning:

Broad beans are used as animal feed as silage or are added to feed. However, in one case in Poland, pigs were poisoned after eating broad beans as one-third of their diet. Symptoms included depression, reduced activity, flatulence, and constipation. Postmortem examination revealed inflammation of the alimentary tract and pale yellow liver and kidneys (Cooper and Johnson 1984).

References:

Cooper, M. R., Johnson, A. W. 1984. Poisonous plants in Britain and their effects on animals and man. Her Majesty's Stationery Office, London, England. 305 pp.

[Another search?](#)

[Français](#) | [Contact Us](#) | [Help](#) | [Search](#) | [Canada site](#)

[Coming Events](#) | [About CBIF](#) | [Links](#) | [Reports and Publications](#) | [Home](#)

Date modified: 2003-02-06

[Important Notices](#)



Français	Contact us	Help	Search	Canada site
Coming events	About CBIF	Links	Reports and publications	Home

Canadian Biodiversity Information Facility



Notes on poisoning: *Vicia sativa*

[Introduction](#)[Interactive](#)[All poisonous plants by Botanical name](#)[All poisonous plants by Common name](#)[Important WWW Poisonous Plants sites](#)

General poisoning notes:

Common vetch (*Vicia sativa*) was introduced as a forage plant and is naturalized across much of Canada. Some horses and other livestock that ingested the plant were poisoned. However, these reports are in the older European literature. In the western United States, poultry that ingested the seeds of common milk vetch were poisoned and died. Common milk vetch contains a neurolathyrigen that may be partly responsible for neurolathyrism, which usually occurs in humans in India and is associated with species of grass pea (see notes under [Lathyrus sativus](#)) (Cooper and Johnson 1984, Cheeke and Schull 1985).

References:

Cheeke, P. R., Shull, L. R. 1985. Natural toxicants in feeds and poisonous plants. AVI Publishing Company, Inc., Westport, Conn., USA. 492 pp.

Cooper, M. R., Johnson, A. W. 1984. Poisonous plants in Britain and their effects on animals and man. Her Majesty's Stationery Office, London, England. 305 pp.

Nomenclature:

Scientific Name: *Vicia sativa* L.

Vernacular name(s): common vetch

Scientific family name: *Leguminosae*

Vernacular family name: pea

Go to ITIS*^{ca} for more taxonomic information on: [Vicia sativa](#)

References:

Agriculture Quebec. 1975. Noms des maladies des plantes du Canada/ Names of plant diseases in Canada. , Quebec City, Que., Canada. 288 pp.

Alex, J. F., Cayouette, R., Mulligan, G. A. 1980. Common and botanical names of weeds in Canada/Noms populaire et scientifiques des plantes nuisibles du Canada. Revised. Agric. Can. Publ., Ottawa, Ont., Canada. 132 pp.

Bailey, L. H., Bailey, E. Z. 1976. Hortus third. Revised. MacMillan, New York, N.Y., USA. 1290 pp.

Scoggan, H. J. 1978, 1979. The flora of Canada. Nat. Mus. Nat. Sci. (Ottawa) Publ. Bot. 7(1)-7(4). 1711 pp.

Van Wijk, H. L. 1911. A dictionary of plant names. Martinus Nijhoff, The Hague, The Netherlands. 1444 pp.

Victorin, M. 1964. Flore Laurentienne. 2nd ed. Univ. Montreal, Montreal, Que., Canada. 952 pp.

Geographic Information

British Columbia
Labrador
Manitoba
New Brunswick
Newfoundland
Nova Scotia
Ontario
Prince Edward Island
Quebec

References:

Bailey, L. H., Bailey, E. Z. 1976. Hortus third. Revised. MacMillan, New York, N.Y., USA. 1290 pp.

Boivin, B. 1966, 1967. Énumération des plantes du Canada. Provencheria 6. Nat. Can. (Que.) 93: 253-274; 371-437; 583-646; 989-1063. 94: 131-157; 471-528; 625-655.

Image or illustration

Vicia sativa:

Images: images.google.com

Toxic parts:

seeds

References:

Cheeke, P. R., Shull, L. R. 1985. Natural toxicants in feeds and poisonous plants. AVI Publishing Company, Inc., Westport, Conn., USA. 492 pp.

Notes on Toxic plant chemicals:

The toxic amino acid, beta-cyano-L-alanine, is a neurotoxin that affects the nervous system (Cheeke and Schull 1985, Roy and Spencer 1989).

Toxic plant chemicals:

beta-cyano-L-alanine

References:

Cheeke, P. R., Shull, L. R. 1985. Natural toxicants in feeds and poisonous plants. AVI Publishing Company, Inc., Westport, Conn., USA. 492 pp.

Roy, D. N., Spencer, P. S. 1989. Lathrogens. Pages 169-201 in Cheeke, P. R., ed. Toxicants of plant origin. Vol. III. Proteins and amino acids. CRC Press, Inc., Boca Raton, Fla., USA. 271 pp.

Animals/Human Poisoning:

Note: When an animal is listed without additional information, the literature (as of 1993) contained no detailed explanation.

Chickens

General symptoms of poisoning:

[blindness](#)

[convulsions](#)

[death](#)

Notes on poisoning:

In western Oregon, some chicks died after ingesting seeds of common milk vetch. Symptoms included blindness, convulsions, and a pronounced chirping, resembling a pyridoxine deficiency. Experimental feeding of a diet containing 30-80% seeds has

caused these symptoms in poultry (Cooper and Johnson 1984, Cheeke and Schull 1985).

References:

Cheeke, P. R., Shull, L. R. 1985. Natural toxicants in feeds and poisonous plants. AVI Publishing Company, Inc., Westport, Conn., USA. 492 pp.

Horses

General symptoms of poisoning:

[abdominal pains](#)

[weakness](#)

[weakness, posterior](#)

Notes on poisoning:

Older European literature describes poisoning of livestock after the animals ingested common vetch. The symptoms included skin lesions, hair loss, digestive disturbances, and sometimes a loss of use of hindquarters. Postmortem examination revealed enlargement of the liver. These problems have not been reported recently (Cooper and Johnson 1984).

References:

Cooper, M. R., Johnson, A. W. 1984. Poisonous plants in Britain and their effects on animals and man. Her Majesty's Stationery Office, London, England. 305 pp.

[Another search?](#)

[Français](#) | [Contact Us](#) | [Help](#) | [Search](#) | [Canada site](#)

[Coming Events](#) | [About CBIF](#) | [Links](#) | [Reports and Publications](#) | [Home](#)

Date modified: 2003-02-06

[Important Notices](#)



Français	Contact us	Help	Search	Canada site
Coming events	About CBIF	Links	Reports and publications	Home

Canadian Biodiversity Information Facility



Notes on poisoning: *Vicia villosa*

[Introduction](#)

[Interactive](#)

[All poisonous plants by Botanical name](#)

[All poisonous plants by Common name](#)

[Important WWW Poisonous Plants sites](#)



General poisoning notes:

Hairy vetch (*Vicia villosa*) was introduced as a forage in Canada and has become successfully naturalized in parts of southern Canada. This plant causes poisoning in cattle, horses, and poultry. Various syndromes occur in cattle, including a dermatitis that resembles photosensitization in many respects, except that the skin lesions appear on pigmented skin as well. Mortality occurs in cattle and poultry (Panciera 1978, Kerr and Edwards 1982, Cooper and Johnson 1984).

References:

- Anderson, C. A., Divers, T. J. 1983. Systemic granulation inflammation in a horse grazing hairy vetch. *J. Am. Vet. Med. Assoc.*, 183: 569-570.
- Cheeke, P. R., Shull, L. R. 1985. Natural toxicants in feeds and poisonous plants. AVI Publishing Company, Inc., Westport, Conn., USA. 492 pp.
- Cooper, M. R., Johnson, A. W. 1984. Poisonous plants in Britain and their effects on animals and man. Her Majesty's Stationery Office, London, England. 305 pp.
- Kerr, L. A., Edwards, W. C. 1982. Hairy vetch poisoning of cattle. *Vet. Med. Small Anim. Clin.*, 77: 257-258.
- Kingsbury, J. M. 1964. Poisonous plants of the United States and Canada. Prentice-Hall Inc., Englewood Cliffs, N.J., USA. 626 pp.
- Panciera, R. J. 1978. Hairy vetch (*Vicia villosa* Roth) poisoning in cattle. Pages 555-563 in Keeler, R. F., Van Kampen, K. R., James, L. F., eds. *Effects of poisonous plants on livestock*. Academic Press, New York, N.Y., USA. 600 pp.

Nomenclature:

Scientific Name: *Vicia villosa* Roth

Vernacular name(s): hairy vetch

Scientific family name: *Leguminosae*

Vernacular family name: pea

Go to ITIS^{*ca} for more taxonomic information on: [Vicia villosa](#)

References:

Agriculture Quebec. 1975. Noms des maladies des plantes du Canada/ Names of plant diseases in Canada. , Quebec City, Que., Canada. 288 pp.

Alex, J. F., Cayouette, R., Mulligan, G. A. 1980. Common and botanical names of weeds in Canada/Noms populaire et scientifiques des plantes nuisibles du Canada. Revised. Agric. Can. Publ., Ottawa, Ont., Canada. 132 pp.

Bailey, L. H., Bailey, E. Z. 1976. Hortus third. Revised. MacMillan, New York, N.Y., USA. 1290 pp.

Scoggan, H. J. 1978, 1979. The flora of Canada. Nat. Mus. Nat. Sci. (Ottawa) Publ. Bot. 7(1)-7(4). 1711 pp.

Van Wijk, H. L. 1911. A dictionary of plant names. Martinus Nijhoff, The Hague, The Netherlands. 1444 pp.

Victorin, M. 1964. Flore Laurentienne. 2nd ed. Univ. Montreal, Montreal, Que., Canada. 952 pp.

Geographic Information

British Columbia

Manitoba

Nova Scotia

Ontario

Quebec

References:

Bailey, L. H., Bailey, E. Z. 1976. Hortus third. Revised. MacMillan, New York, N.Y., USA. 1290 pp.

Boivin, B. 1966, 1967. Énumération des plantes du Canada. Provencheria 6. Nat. Can. (Que.) 93: 253-274; 371-437; 583-646; 989-1063. 94: 131-157; 471-528; 625-655.

Image or illustration

Vicia villosa:

Images: images.google.com

Notes on Poisonous plant parts:

This plant has occasionally caused poisoning when used as a forage for livestock (Cheeke and Schull 1985).

Toxic parts:

leaves

seeds

References:

Kerr, L. A., Edwards, W. C. 1982. Hairy vetch poisoning of cattle. *Vet. Med. Small Anim. Clin.*, 77: 257-258.

Toxic plant chemicals:

unknown chemical

References:

Kerr, L. A., Edwards, W. C. 1982. Hairy vetch poisoning of cattle. *Vet. Med. Small Anim. Clin.*, 77: 257-258.

Animals/Human Poisoning:

Note: When an animal is listed without additional information, the literature (as of 1993) contained no detailed explanation.

Cattle

General symptoms of poisoning:

[anorexia](#)

[breathing, labored](#)

[coat, rough and dry](#)

[conjunctivitis](#)

[convulsions](#)

[death](#)

[diarrhea](#)

[pain](#)

[pneumonitis](#)
[restlessness](#)
[skin, peeling of](#)
[weakness](#)
[weight loss](#)

Notes on poisoning:

Two types of syndromes are suggested from the symptoms seen in cattle. The first syndrome is acute illness followed by death after ingesting raw seeds of hairy vetch. The animals were very restless, showed pain, experienced convulsions, and died. The second syndrome involves skin lesions, cough, respiration problems, and death after 2 weeks. Postmortem findings showed severe bronchitis with pneumonia, yellow- brown liver, and inflamed forestomachs (Panciera 1978, Cooper and Johnson 1984).

References:

- Cooper, M. R., Johnson, A. W. 1984. Poisonous plants in Britain and their effects on animals and man. Her Majesty's Stationery Office, London, England. 305 pp.
- Kerr, L. A., Edwards, W. C. 1982. Hairy vetch poisoning of cattle. *Vet. Med. Small Anim. Clin.*, 77: 257-258.
- Kingsbury, J. M. 1964. Poisonous plants of the United States and Canada. Prentice-Hall Inc., Englewood Cliffs, N.J., USA. 626 pp.
- Panciera, R. J. 1978. Hairy vetch (*Vicia villosa* Roth) poisoning in cattle. Pages 555-563 in Keeler, R. F., Van Kampen, K. R., James, L. F., eds. Effects of poisonous plants on livestock. Academic Press, New York, N.Y., USA. 600 pp.

Horses

General symptoms of poisoning:

[conjunctivitis](#)
[mouth, edema of](#)

Notes on poisoning:

Hairy vetch causes systemic granulomatous inflammation. Edema occurs especially around the lips and eyes. Conjunctivitis and corneal ulceration develops. The poisoning is most prevalent in mid to late spring as the hairy vetch reaches maturity (Anderson and Divers 1983).

References:

Anderson, C. A., Divers, T. J. 1983. Systemic granulation inflammation in a horse grazing hairy vetch. J. Am. Vet. Med. Assoc., 183: 569-570.

Cheeke, P. R., Shull, L. R. 1985. Natural toxicants in feeds and poisonous plants. AVI Publishing Company, Inc., Westport, Conn., USA. 492 pp.

Poultry

General symptoms of poisoning:

[breathing, labored](#)

[convulsions](#)

[incoordination](#)

[weight loss](#)

Notes on poisoning:

Feeding chicks experimentally on a diet of 30-80% hairy vetch seeds caused 20-40% mortality. Symptoms included weight loss, excitability, and sometimes violent convulsions (Cooper and Johnson 1984).

References:

Cooper, M. R., Johnson, A. W. 1984. Poisonous plants in Britain and their effects on animals and man. Her Majesty's Stationery Office, London, England. 305 pp.

[Another search?](#)

[Français](#) | [Contact Us](#) | [Help](#) | [Search](#) | [Canada site](#)

[Coming Events](#) | [About CBIF](#) | [Links](#) | [Reports and Publications](#) | [Home](#)

Date modified: 2003-02-06

[Important Notices](#)



Français	Contact us	Help	Search	Canada site
Coming events	About CBIF	Links	Reports and publications	Home

Canadian Biodiversity Information Facility



Notes on poisoning: *Wisteria floribunda*

[Introduction](#)[Interactive](#)[All poisonous plants by Botanical name](#)[All poisonous plants by Common name](#)[Important WWW Poisonous Plants sites](#)

General poisoning notes:

Japanese wisteria (*Wisteria floribunda*) is an ornamental vine that is grown for its beautiful flowers. This plant is restricted to the warmer parts of Canada, such as southern Ontario and Vancouver Island. With care, the vine successfully overwinters in Ottawa, Ont. All parts of the plant are toxic, especially the seeds. Ingesting 1-2 seeds can cause serious poisoning in a child. However, no fatalities have been reported in the literature. Another plant in the same genus, Chinese wisteria (*Wisteria sinensis* (Sims) Sweet), may also be capable of surviving in southern Canada (Anon. 1961, Lampe and McCann 1985).

References:

Anon. 1961. *Wisteria*. Natl. Clgh. Poison Control Cent., July-Aug: 1-2.

Lampe, K. F., McCann, M. A. 1985. AMA Handbook of poisonous and injurious plants. American Medical Assoc. Chicago, Ill., USA. 432 pp.

Nomenclature:

Scientific Name: *Wisteria floribunda* (Willd.) DC.

Vernacular name(s): Japanese wisteria

Scientific family name: *Leguminosae*

Vernacular family name: pea

Go to ITIS*^{ca} for more taxonomic information on: [Wisteria floribunda](#)

References:

Agriculture Quebec. 1975. Noms des maladies des plantes du Canada/ Names of plant diseases in Canada. , Quebec City, Que., Canada. 288 pp.

Alex, J. F., Cayouette, R., Mulligan, G. A. 1980. Common and botanical names of weeds in Canada/Noms populaire et scientifiques des plantes nuisibles du Canada. Revised. Agric. Can. Publ., Ottawa, Ont., Canada. 132 pp.

Bailey, L. H., Bailey, E. Z. 1976. Hortus third. Revised. MacMillan, New York, N.Y., USA. 1290 pp.

Scoggan, H. J. 1978, 1979. The flora of Canada. Nat. Mus. Nat. Sci. (Ottawa) Publ. Bot. 7(1)-7(4). 1711 pp.

Van Wijk, H. L. 1911. A dictionary of plant names. Martinus Nijhoff, The Hague, The Netherlands. 1444 pp.

Victorin, M. 1964. Flore Laurentienne. 2nd ed. Univ. Montreal, Montreal, Que., Canada. 952 pp.

Geographic Information

Plant or plant parts used in or around the home.

References:

Bailey, L. H., Bailey, E. Z. 1976. Hortus third. Revised. MacMillan, New York, N.Y., USA. 1290 pp.

Boivin, B. 1966, 1967. Énumération des plantes du Canada. Provencheria 6. Nat. Can. (Que.) 93: 253-274; 371-437; 583-646; 989-1063. 94: 131-157; 471-528; 625-655.

Image or illustration

Wisteria floribunda:

Images: images.google.com

Notes on Poisonous plant parts:

All parts of the plant, including the flowers, are toxic. The seeds are especially toxic (Lampe and McCann 1985).

Toxic parts:

all parts
flowers

leaves

seeds

References:

Lampe, K. F., McCann, M. A. 1985. AMA Handbook of poisonous and injurious plants. American Medical Assoc. Chicago, Ill., USA. 432 pp.

Notes on Toxic plant chemicals:

A glycoside, wistarine, has been found in the plant. It also contains a poisonous lectin (Lampe and McCann 1985).

Toxic plant chemicals:

wistarine

References:

Anon. 1961. *Wisteria*. Natl. Clgh. Poison Control Cent., July-Aug: 1-2.

Lampe, K. F., McCann, M. A. 1985. AMA Handbook of poisonous and injurious plants. American Medical Assoc. Chicago, Ill., USA. 432 pp.

Animals/Human Poisoning:

Note: When an animal is listed without additional information, the literature (as of 1993) contained no detailed explanation.

Humans

General symptoms of poisoning:

[abdominal pains](#)

[collapse](#)

[dehydration](#)

[diarrhea](#)

[nausea](#)

[vomiting](#)

Notes on poisoning:

Humans who ingest wisteria exhibited the following symptoms: nausea, vomiting, diarrhea, abdominal pain, and dehydration. Ingesting 1-2 seeds caused serious poisoning in a young adult. Patients usually recover in 1-2 days. Treatment includes

induction of emesis, followed by supportive treatments with antiemetics and fluid replacement (Anon. 1961, Lampe and McCann 1985).

References:

Anon. 1961. *Wisteria*. Natl. Clgh. Poison Control Cent., July-Aug: 1-2.

Lampe, K. F., McCann, M. A. 1985. AMA Handbook of poisonous and injurious plants. American Medical Assoc. Chicago, Ill., USA. 432 pp.

[Another search?](#)

[Français](#) | [Contact Us](#) | [Help](#) | [Search](#) | [Canada site](#)

[Coming Events](#) | [About CBIF](#) | [Links](#) | [Reports and Publications](#) |

[Home](#)

Date modified: 2003-02-06

[Important Notices](#)



Français	Contact us	Help	Search	Canada site
Coming events	About CBIF	Links	Reports and publications	Home
Canadian Biodiversity Information Facility				



Notes on poisoning: *Xanthium strumarium*

[Introduction](#)

[Interactive](#)

[All poisonous plants
by Botanical name](#)

[All poisonous plants
by Common name](#)

[Important WWW
Poisonous Plants sites](#)

General poisoning notes:

Cocklebur (*Xanthium strumarium*) is a naturalized annual herb found across southern Canada, where it grows in wet soils and agricultural fields. The toxic glycoside carboxyatractyloside is found in the seeds and the cotyledons of seedlings. Livestock are most commonly poisoned after ingesting the cotyledons (seed leaves) of young seedlings. The toxin quickly dissipates as the seedlings grow. Cattle, horses, and swine are often poisoned and die after ingesting this plant. This plant can produce allergic contact dermatitis in susceptible humans (Mitchell and Rook 1979, Weaver and Lechowicz 1983, Burrows and Tyrl 1989).

References:

- Burrows, G. E., Tyrl, R. J. 1989. Plants causing sudden death in livestock. *Clin. Toxicol.*, 5: 263-289.
- Cole, R. J., Cutler, H. G., Stuart, B. P. 1989. Carboxyatractyloside. Pages 253-263 in Cheeke, P. R., ed. *Toxicants of plant origin. Vol. II. Glycosides.* CRC Press, Inc., Boca Raton, Fla., USA. 277 pp.
- Martin, T. M., Stair, E. L., Dawson, L. 1986. Cocklebur poisoning in cattle. *J. Am. Vet. Med. Assoc.*, 189: 562-563.
- Mitchell, J. C., Rook, A. 1979. *Botanical dermatology.* Greenglass Ltd, Vancouver, B.C., Canada. 787 pp.
- Weaver, S. E., Lechowicz, M. J. 1983. The biology of Canadian weeds. 56. *Xanthium strumarium* L. *Can. J. Plant Sci.*, 63: 211-225.

Nomenclature:

Scientific Name: *Xanthium strumarium* L.

Vernacular name(s): cocklebur

Scientific family name: *Compositae*

Vernacular family name: composite

Go to ITIS*^{ca} for more taxonomic information on: [Xanthium strumarium](#)

References:

Agriculture Quebec. 1975. Noms des maladies des plantes du Canada/ Names of plant diseases in

Canada. , Quebec City, Que., Canada. 288 pp.

Alex, J. F., Cayouette, R., Mulligan, G. A. 1980. Common and botanical names of weeds in Canada/Noms populaire et scientifiques des plantes nuisibles du Canada. Revised. Agric. Can. Publ., Ottawa, Ont., Canada. 132 pp.

Bailey, L. H., Bailey, E. Z. 1976. Hortus third. Revised. MacMillan, New York, N.Y., USA. 1290 pp.

Scoggan, H. J. 1978, 1979. The flora of Canada. Nat. Mus. Nat. Sci. (Ottawa) Publ. Bot. 7(1)-7(4). 1711 pp.

Van Wijk, H. L. 1911. A dictionary of plant names. Martinus Nijhoff, The Hague, The Netherlands. 1444 pp.

Victorin, M. 1964. Flore Laurentienne. 2nd ed. Univ. Montreal, Montreal, Que., Canada. 952 pp.

Geographic Information

Alberta
British Columbia
Manitoba
New Brunswick
Nova Scotia
Ontario
Prince Edward Island
Quebec
Saskatchewan

References:

Bailey, L. H., Bailey, E. Z. 1976. Hortus third. Revised. MacMillan, New York, N.Y., USA. 1290 pp.

Boivin, B. 1966, 1967. Énumération des plantes du Canada. Provencheria 6. Nat. Can. (Que.) 93: 253-274; 371-437; 583-646; 989-1063. 94: 131-157; 471-528; 625-655.

Image or illustration

Xanthium strumarium:

Images: images.google.com

Notes on Poisonous plant parts:

The toxin is found in the seeds and in the cotyledons (or seed leaves) of the seedlings (Cole et al. 1980).

Toxic parts:

seedlings
seeds

References:

Cole, R. J., Stuart, B. P., Lansden, J. A., Cox, R. H. 1980. Isolation and redefinition of the toxic agent from cocklebur (*Xanthium strumarium*). J. Agric. Food Chem., 28: 1330-1332.

Notes on Toxic plant chemicals:

A highly toxic glycoside, carboxyatractyloside, is contained in the seeds and seedlings of cocklebur. The amount of the chemical was measured at 0.457% in the seeds and 0.12% in the seedling at the two-leaf stage. The poison occurs only in the cotyledons or seed leaves of the seedlings. The toxin readily disappears after germination (Cole et al. 1980).

Toxic plant chemicals:

carboxyatractyloside

References:

Cole, R. J., Cutler, H. G., Stuart, B. P. 1989. Carboxyatractyloside. Pages 253-263 in Cheeke, P. R., ed. Toxicants of plant origin. Vol. II. Glycosides. CRC Press, Inc., Boca Raton, Fla., USA. 277 pp.

Cole, R. J., Stuart, B. P., Lansden, J. A., Cox, R. H. 1980. Isolation and redefinition of the toxic agent from cocklebur (*Xanthium strumarium*). J. Agric. Food Chem., 28: 1330-1332.

Animals/Human Poisoning:

Note: When an animal is listed without additional information, the literature (as of 1993) contained no detailed explanation.

Cattle

General symptoms of poisoning:

[anorexia](#)

[convulsions](#)

[death](#)

[depression](#)

[dyspnea](#)

[muscle, weakness of](#)

[nausea](#)

[opisthotonos](#)

Notes on poisoning:

Poisoning after ingesting cocklebur cotyledons from seedlings has resulted in symptoms including anorexia, depression, nausea, dyspnea, opisthotonos, and spasmodic running motions. Kidney discoloration and liver discoloration with acute hepatocellular centrilobular necrosis also occurs. Death often occurs, and treatment is symptomatic (Martin et al. 1986).

References:

Martin, T. M., Stair, E. L., Dawson, L. 1986. Cocklebur poisoning in cattle. J. Am. Vet. Med. Assoc., 189: 562-563.

Humans

General symptoms of poisoning:

[erythema](#)

References:

Mitchell, J. C., Rook, A. 1979. Botanical dermatology. Greenglass Ltd, Vancouver, B.C., Canada. 787 pp.

Rodents

General symptoms of poisoning:

[death](#)

Notes on poisoning:

Experimental use of carboxyatractyloside (CAT) in mice and rats, had an LD-50 (i.p. or injections into the peritoneal or abdominal cavity) of:

;

10.6 (7.5-15.1) mg/kg for mice 2.9 (1.5-5.8) mg/kg for rats

; Postmortem examination revealed prominent hepatic lobular accentuation in rats (Cole et al. 1989).

References:

Cole, R. J., Cutler, H. G., Stuart, B. P. 1989. Carboxyatractyloside. Pages 253-263 in Cheeke, P. R., ed. Toxicants of plant origin. Vol. II. Glycosides. CRC Press, Inc., Boca Raton, Fla., USA. 277 pp.

Swine

General symptoms of poisoning:

[anorexia](#)

[death](#)

[depression](#)

[incoordination](#)

[muscle spasms](#)

[vomiting](#)

Notes on poisoning:

Pigs are poisoned after ingesting cotyledons equal to 1-2% of body weight or 20% of macerated burs containing seeds. Intoxication can occur within a few hours and symptoms include anorexia, depression, weakness, a tucked-up appearance, and spasmodic muscular activity. Postmortem findings reveal extensive serofibrinous effusions of protein- rich fluid in the peritoneal cavity. Scattered pericardial and subcutaneous lesions may also occur. Hepatic necrosis can occur (Burrows and Tyrl 1989).

References:

Burrows, G. E., Tyrl, R. J. 1989. Plants causing sudden death in livestock. Clin. Toxicol., 5: 263-289.

[Another search?](#)

[Français](#) | [Contact Us](#) | [Help](#) | [Search](#) | [Canada site](#)

[Coming Events](#) | [About CBIF](#) | [Links](#) | [Reports and Publications](#) | [Home](#)

Date modified: 2003-02-06

[Important Notices](#)



Français	Contact us	Help	Search	Canada site
Coming events	About CBIF	Links	Reports and publications	Home

Canadian Biodiversity Information Facility



Notes on poisoning: *Zigadenus elegans*

[Introduction](#)[Interactive](#)[All poisonous plants by
Botanical name](#)[All poisonous plants by
Common name](#)[Important WWW Poisonous
Plants sites](#)

General poisoning notes:

White camas (*Zigadenus elegans*) is a native perennial herb that grows from a bulb. The plant can be found across most of Canada from British Columbia to New Brunswick and in parts of northwestern Canada. The plant contains several steroidal alkaloids, including zygacine, which can poison livestock and humans. White camas has caused poisoning in sheep and may have been involved in poisoning cattle. Ingesting the bulbs can also cause poisoning. This plant is considered to be about seven times less toxic than death camas (*Zigadenus venenosus*). Poisoning is most common in early spring because this plant often is available before other forage is plentiful (Kingsbury 1964, Panter and James 1989).

References:

- Cheeke, P. R., Shull, L. R. 1985. Natural toxicants in feeds and poisonous plants. AVI Publishing Company, Inc., Westport, Conn., USA. 492 pp.
- Fuller, T. C., McClintock, E. 1986. Poisonous plants of California. Univ. California Press, Berkeley, Calif., USA. 432 pp.
- Kingsbury, J. M. 1964. Poisonous plants of the United States and Canada. Prentice-Hall Inc., Englewood Cliffs, N.J., USA. 626 pp.
- Panter, K. E., James, L. F. 1989. Death camas-early grazing can be hazardous. Rangelands, 11: 147-149.

Nomenclature:

Scientific Name: *Zigadenus elegans* Pursh

Vernacular name(s): white camas

Scientific family name: *Liliaceae*

Vernacular family name: lily

Go to ITIS^{*ca} for more taxonomic information on: [Zigadenus elegans](#)

References:

Agriculture Quebec. 1975. Noms des maladies des plantes du Canada/
Names of plant diseases in Canada. , Quebec City, Que., Canada. 288 pp.

Alex, J. F., Cayouette, R., Mulligan, G. A. 1980. Common and botanical
names of weeds in Canada/Noms populaire et scientifiques des plantes
nuisibles du Canada. Revised. Agric. Can. Publ., Ottawa, Ont., Canada.
132 pp.

Bailey, L. H., Bailey, E. Z. 1976. Hortus third. Revised. MacMillan, New
York, N.Y., USA. 1290 pp.

Scoggan, H. J. 1978, 1979. The flora of Canada. Nat. Mus. Nat. Sci.
(Ottawa) Publ. Bot. 7(1)-7(4). 1711 pp.

Van Wijk, H. L. 1911. A dictionary of plant names. Martinus Nijhoff, The
Hague, The Netherlands. 1444 pp.

Victorin, M. 1964. Flore Laurentienne. 2nd ed. Univ. Montreal, Montreal,
Que., Canada. 952 pp.

Geographic Information

Alberta
British Columbia
Manitoba
New Brunswick
Northwest Territories
Ontario
Quebec
Saskatchewan

References:

Bailey, L. H., Bailey, E. Z. 1976. Hortus third. Revised. MacMillan, New
York, N.Y., USA. 1290 pp.

Boivin, B. 1966, 1967. Énumération des plantes du Canada. Provencheria
6. Nat. Can. (Que.) 93: 253-274; 371-437; 583-646; 989-1063. 94:
131-157; 471-528; 625-655.

Image or illustration

Zigadenus elegans:

Images: images.google.com

Notes on Poisonous plant parts:

All parts of the plant are toxic. The early leaves are the most common cause of poisoning because the plants grow early, before other forage is plentiful. The bulbs may be pulled up and ingested if the ground is wet (Cheeke and Schull 1985, Panter and James 1989).

Toxic parts:

all parts
bulbs
flowers
leaves

References:

Cheeke, P. R., Shull, L. R. 1985. Natural toxicants in feeds and poisonous plants. AVI Publishing Company, Inc., Westport, Conn., USA. 492 pp.

Panter, K. E., James, L. F. 1989. Death camas-early grazing can be hazardous. Rangelands, 11: 147-149.

Notes on Toxic plant chemicals:

A steroidal alkaloid, zygacine, is one of several alkaloids contained in death camas. The lethal dose is estimated at between 2.0-6.0% of animal body weight. This plant is considered to be less toxic than death camas, *Zigadenus venenosus* (Kingsbury 1964).

Toxic plant chemicals:

zygacine

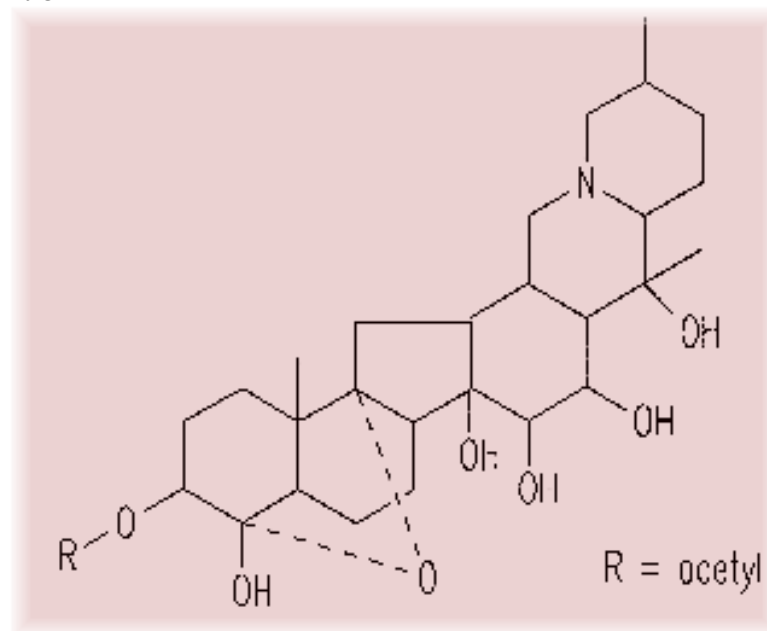

Chemical diagram(s) are courtesy of [Ruth McDiarmid](#), Biochemistry Technician, Kamloops Range Station, Agriculture and Agri-Food Canada, Kamloops, British Columbia, Canada.

References:

Cheeke, P. R., Shull, L. R. 1985. Natural toxicants in feeds and poisonous plants. AVI Publishing Company, Inc., Westport, Conn., USA. 492 pp.

Kingsbury, J. M. 1964. Poisonous plants of the United States and Canada. Prentice-Hall Inc., Englewood Cliffs, N.J., USA. 626 pp.

Animals/Human Poisoning:

Note: When an animal is listed without additional information, the literature (as of 1993) contained no detailed explanation.

Cattle

Horses

Humans

General symptoms of poisoning:

[blood pressure, low](#)

[coma](#)

[dizziness](#)

[heart rate, slow](#)

Notes on poisoning:

Ingesting the bulbs, mistaken for onions, can cause poisoning in humans, even though this species is considered less toxic than death camas (*Zigadenus venenosus*).

References:

Fuller, T. C., McClintock, E. 1986. Poisonous plants of California. Univ. California Press, Berkeley, Calif., USA. 432 pp.

Sheep

General symptoms of poisoning:

[ataxia](#)

[breathing, rapid](#)

[coma](#)

[death](#)

[death](#)
[mouth, frothing of](#)
[nasal discharge](#)
[nausea](#)
[salivation](#)
[urination, frequent](#)
[vomiting](#)

Notes on poisoning:

Symptoms of poisoning are similar for all species of animals. Symptoms in sheep include excessive salivation, froth around the nose and mouth, nausea, vomiting, muscular weakness, ataxia, possible coma, and death. The heart fails before respiration. Postmortem findings reveal the heart in complete diastole. Lesions include severe pulmonary congestion, hemorrhage, and edema. One-time loss of sheep has been reported as 500 head in some species of *Zigadenus* (Cheeke and Schull 1985, Panter and James 1989).

References:

Cheeke, P. R., Shull, L. R. 1985. Natural toxicants in feeds and poisonous plants. AVI Publishing Company, Inc., Westport, Conn., USA. 492 pp.

Panter, K. E., James, L. F. 1989. Death camas-early grazing can be hazardous. Rangelands, 11: 147-149.

[Another search?](#)

[Français](#) | [Contact Us](#) | [Help](#) | [Search](#) | [Canada site](#)

[Coming Events](#) | [About CBIF](#) | [Links](#) | [Reports and Publications](#) | [Home](#)

Date modified: 2003-02-06

[Important Notices](#)



Français	Contact us	Help	Search	Canada site
Coming events	About CBIF	Links	Reports and publications	Home

Canadian Biodiversity Information Facility



Notes on poisoning: *Zigadenus venenosus*

[Introduction](#)[Interactive](#)[All poisonous plants by
Botanical name](#)[All poisonous plants by
Common name](#)[Important WWW Poisonous
Plants sites](#)

General poisoning notes:

Death camas (*Zigadenus venenosus*) is a native perennial herb that is found from British Columbia to southwestern Saskatchewan. The plant is one of the most toxic springtime plants, especially to sheep. Cattle and horses are also occasionally poisoned. Swine vomit the plant so readily that no natural cases of poisoning have been reported. Poultry may also be poisoned, although there are no reported cases. Honey bees are poisoned by the nectar and pollen (Kingsbury 1964, Barker 1978; Panter and James 1989). Humans have also been poisoned after ingesting the bulbs, which were mistaken for other plants such as onions (*Allium* spp.) or camas (*Camassia quamash*). Ingesting the flowers and flower buds has caused poisoning in children (Cameron 1952, Spoerke and Spoerke 1979). These plants should be considered poisonous to all livestock and humans.

References:

Barker, R. J. 1980. Poisoning by plants. Pages 275-296 in Morse, R. A., ed. Honey bee pests, predators, and diseases. Cornell University Press, Ithaca, N.Y., USA. 430 pp.

Cameron, K. 1952. Death camas poisoning. Northwest Med., 1952: 682-683.

Dayton, W. A. 1960. Notes on western range forbes. U. S. For. Serv. Wash. Agric. Hand., 161. 254 pp.

Kingsbury, J. M. 1964. Poisonous plants of the United States and Canada. Prentice-Hall Inc., Englewood Cliffs, N.J., USA. 626 pp.

Long, R. 1981. Some liliaceae of British Columbia. Davidsonia, 12: 85-88.

Panter, K. E., James, L. F. 1989. Death camas-early grazing can be hazardous. Rangelands, 11: 147-149.

Spoerke, D. G., Spoerke, S. E. 1979. Three cases of *Zigadenus* (death camas) poisoning. Vet. Hum. Toxicol., 21: 346-347.

Nomenclature:

Scientific Name: *Zigadenus venenosus* S. Wats.

Vernacular name(s): death camas

Scientific family name: *Liliaceae*

Vernacular family name: lily

Go to ITIS^{*ca} for more taxonomic information on: [Zigadenus venenosus](#)

References:

Agriculture Quebec. 1975. Noms des maladies des plantes du Canada/ Names of plant diseases in Canada. , Quebec City, Que., Canada. 288 pp.

Alex, J. F., Cayouette, R., Mulligan, G. A. 1980. Common and botanical names of weeds in Canada/Noms populaire et scientifiques des plantes nuisibles du Canada. Revised. Agric. Can. Publ., Ottawa, Ont., Canada. 132 pp.

Bailey, L. H., Bailey, E. Z. 1976. Hortus third. Revised. MacMillan, New York, N.Y., USA. 1290 pp.

Scoggan, H. J. 1978, 1979. The flora of Canada. Nat. Mus. Nat. Sci. (Ottawa) Publ. Bot. 7(1)-7(4). 1711 pp.

Van Wijk, H. L. 1911. A dictionary of plant names. Martinus Nijhoff, The Hague, The Netherlands. 1444 pp.

Victorin, M. 1964. Flore Laurentienne. 2nd ed. Univ. Montreal, Montreal, Que., Canada. 952 pp.

Geographic Information

Alberta

British Columbia

Saskatchewan

References:

Bailey, L. H., Bailey, E. Z. 1976. Hortus third. Revised. MacMillan, New York, N.Y., USA. 1290 pp.

Boivin, B. 1966, 1967. Énumération des plantes du Canada. Provencheria 6. Nat. Can. (Que.) 93: 253-274; 371-437; 583-646; 989-1063. 94: 131-157; 471-528; 625-655.

Image or illustration

Zigadenus venenosus:

Images: images.google.com

Notes on Poisonous plant parts:

All parts of death camas contain toxic alkaloids, with the bulbs containing the most. The bulbs may be pulled up by animals when the ground is wet or may be ingested by humans who mistake them for other plants, such as onions. The nectar and pollen are poisonous to bees. Most cases of animal poisoning occur in spring, when other forage is not plentiful (Kingsbury 1964, Barker 1978).

Toxic parts:

all parts
bulbs
flowers
leaves
pollen

References:

Barker, R. J. 1980. Poisoning by plants. Pages 275-296 in Morse, R. A., ed. Honey bee pests, predators, and diseases. Cornell University Press, Ithaca, N.Y., USA. 430 pp.

Kingsbury, J. M. 1964. Poisonous plants of the United States and Canada. Prentice-Hall Inc., Englewood Cliffs, N.J., USA. 626 pp.

Notes on Toxic plant chemicals:

Steroidal alkaloids, including zygacine, have been found in these plants. Death camas is considered to be the most toxic members of the genus *Zigadenus*. The average minimum lethal dose in sheep is estimated to be equal to ingesting 0.6-2.0% of an animal's body weight in plant material (Kingsbury 1964).

Toxic plant chemicals:

zygacine

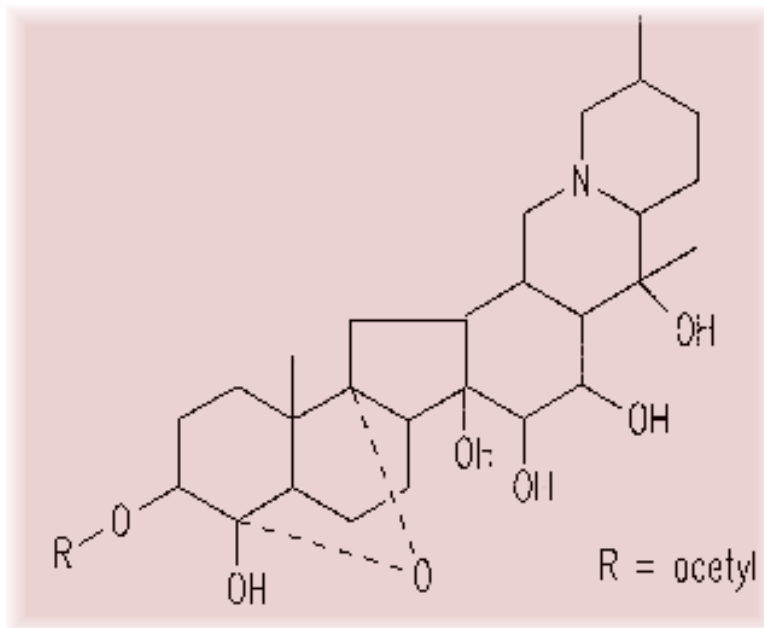

Chemical diagram(s) are courtesy of [Ruth McDiarmid](#), Biochemistry Technician, Kamloops Range Station, Agriculture and Agri-Food Canada, Kamloops, British Columbia, Canada.

References:

Kingsbury, J. M. 1964. Poisonous plants of the United States and Canada. Prentice-Hall Inc., Englewood Cliffs, N.J., USA. 626 pp.

Animals/Human Poisoning:

Note: When an animal is listed without additional information, the literature (as of 1993) contained no detailed explanation.

Cattle

General symptoms of poisoning:

[ataxia](#)
[death](#)
[dyspnea](#)
[nausea](#)
[prostration](#)
[salivation](#)
[trembling](#)

Notes on poisoning:

Cattle are occasionally poisoned by death camas. Symptoms are very similar to those for other livestock. Salivation is sometimes less and nausea greater than in sheep. Other symptoms include muscular weakness, ataxia, trembling, prostration, and death. The heart action becomes weakened

(Kingsbury 1964).

References:

Kingsbury, J. M. 1964. Poisonous plants of the United States and Canada. Prentice-Hall Inc., Englewood Cliffs, N.J., USA. 626 pp.

Honey bees

General symptoms of poisoning:

[death](#)

Notes on poisoning:

In field cases, adult bees died after foraging on this plant. In experiments, both the nectar and pollen, collected by centrifugation, poisoned the bees. The plants bloom for only a couple of weeks and secrete little nectar. Solitary native bees seem less affected by the toxins (Barker 1978).

References:

Barker, R. J. 1980. Poisoning by plants. Pages 275-296 in Morse, R. A., ed. Honey bee pests, predators, and diseases. Cornell University Press, Ithaca, N.Y., USA. 430 pp.

Horses

General symptoms of poisoning:

[colic](#)

[depression](#)

[diarrhea](#)

[salivation](#)

Notes on poisoning:

Horses have been poisoned after ingesting hay containing immature seed pods of death camas. The symptoms of illness included colic, salivation, cramping, depression, and intermittent diarrhea (Fuller and McClintock 1986).

References:

Fuller, T. C., McClintock, E. 1986. Poisonous plants of California. Univ. California Press, Berkeley, Calif., USA. 432 pp.

Humans

General symptoms of poisoning:

[blood pressure, low](#)

[breathing, shallow](#)

[coma](#)

[death](#)

[diarrhea](#)

[drowsiness](#)

[pupil dilation](#)

[vomiting](#)

Notes on poisoning:

Humans have been poisoned after ingesting the bulbs and flowers. In most cases, the bulbs are mistaken for onions. A 2-year-old child became ill after eating the blossoms. Symptoms of poisoning include vomiting, slow breathing, unconsciousness (though responsive to pain or movement), hyperactive tendons and limbs, pupil dilation, and hypotension. The alkaloids cause local irritation when ingested and affect the cardiovascular system by slowing the heart and decreasing blood pressure. Treatment includes emesis, activated charcoal, and saline cathartic. Atropine was also given (Cameron 1952, Spoerke and Spoerke 1979).

References:

Cameron, K. 1952. Death camas poisoning. Northwest Med., 1952: 682-683.

Long, R. 1981. Some liliaceae of British Columbia. Davidsonia, 12: 85-88.

Spoerke, D. G., Spoerke, S. E. 1979. Three cases of *Zigadenus* (death camas) poisoning. Vet. Hum. Toxicol., 21: 346-347.

Poultry

General symptoms of poisoning:

[coma](#)

[death](#)

[diarrhea](#)

[incoordination](#)

[prostration](#)

Notes on poisoning:

In one case (with an related species of *Zigadenus*), poultry were poisoned. Symptoms included diarrhea, staggering gait, incoordination, prostration, and coma. Many birds died (Kingsbury 1964). Death camas can also poison poultry if they ingest the tender shoots.

References:

Kingsbury, J. M. 1964. Poisonous plants of the United States and Canada. Prentice-Hall Inc., Englewood Cliffs, N.J., USA. 626 pp.

Sheep

General symptoms of poisoning:

[breathing, shallow](#)

[cyanosis](#)

[death](#)

[mouth, frothing of](#)

[muscle, weakness of](#)

[nasal discharge](#)

[prostration](#)

[salivation](#)

[urination, frequent](#)

[vomiting](#)

Notes on poisoning:

Death camas is considered to be one of the most toxic plants on the western rangelands, and ingestion causes greater loss of life of sheep than any other plant in springtime. Symptoms include excessive salivation, nausea, frothing at the nose and mouth, vomiting, increased urination and defecation, muscular weakness, ataxia, prostration, and death resulting from heart failure. Postmortem examination shows the heart in complete diastole. Coma may occur for a few hours to several days before death. Lesions include severe pulmonary congestion, edema, and hemorrhage. Losses occur most frequently in the spring, when other forage is not plentiful (Long 1981, Panter and James 1989).

References:

Dayton, W. A. 1960. Notes on western range forbes. U. S. For. Serv. Wash. Agric. Hand., 161. 254 pp.

Long, R. 1981. Some liliaceae of British Columbia. Davidsonia, 12: 85-88.

Panter, K. E., James, L. F. 1989. Death camas-early grazing can be hazardous. Rangelands, 11: 147-149.

Swine

General symptoms of poisoning:

[diarrhea](#)

[vomiting](#)

Notes on poisoning:

Experiments show that swine are susceptible to the poisons, but cases of poisoning are not encountered under natural conditions because swine readily expel the material by vomiting (Kingsbury 1964).

References:

Kingsbury, J. M. 1964. Poisonous plants of the United States and Canada. Prentice-Hall Inc., Englewood Cliffs, N.J., USA. 626 pp.

[Another search?](#)

[Français](#) | [Contact Us](#) | [Help](#) | [Search](#) | [Canada site](#)

[Coming Events](#) | [About CBIF](#) | [Links](#) | [Reports and Publications](#) | [Home](#)

Date modified: 2003-02-06

[Important Notices](#)



English	Contactez-nous	Aide	Recherche	Site du Canada
À venir	À notre sujet	Liens	Rapports et publications	Accueil

Système canadien d'information sur la biodiversité



Toutes les plantes vénéneuses

[Introduction](#)[Recherche interactive](#)[Liste de toutes les plantes toxiques par nom scientifique](#)[Liste de toutes les plantes toxiques par nom commun](#)[Les principaux sites Web sur les plantes toxiques](#)**Nom commun**[abrus à chapelet](#)[aconit Napel](#)[agripaume cardiaque](#)[ail](#)[ail du Canada](#)[alkékenge](#)[aloès](#)[alpiste roseau](#)[amarante à racine rouge](#)[amarante fausse-blite](#)[amarante hybride](#)[amaryllis](#)[amaryllis belladone](#)[amélanchier à feuilles d'aulne](#)[Amsinckia](#)[Anthurium](#)[apocyn à feuilles d'androsème](#)[apocyn chanvrin](#)[arbre ombrelle](#)[arum vénéneux](#)[asaret du Canada](#)[asclépiade de Syrie](#)[asclépiade verticillée](#)[asiminier trilobé](#)[astragale du Canada](#)[astragale fondu](#)[astragale prostré](#)**Nom scientifique***Abrus precatorius**Aconitum napellus**Leonurus cardiaca**Allium sativum**Allium canadense**Physalis alkekengi**Aloe barbadensis**Phalaris arundinacea**Amaranthus retroflexus**Amaranthus blitoides**Amaranthus hybridus**Amaryllis vittata**Amaryllis belladonna**Amelanchier alnifolia**Amsinckia intermedia**Anthurium andraeanum**Apocynum androsaemifolium**Apocynum cannabinum**Brassaia actinophylla**Dieffenbachia amoena**Asarum canadense**Asclepias syriaca**Asclepias verticillata**Asimina triloba**Astragalus canadensis**Astragalus bisulcatus**Astragalus miser*

Astragalus (A. adsurgens)	<i>Astragalus adsurgens</i>
Astragalus (A. lentiginosus)	<i>Astragalus lentiginosus</i>
auriole	<i>Daphne laureola</i>
avocatier	<i>Persea americana</i>
avoine	<i>Avena sativa</i>
azalée blanche	<i>Rhododendron albiflorum</i>
baptisie leucanthe	<i>Baptisia leucantha</i>
barbarée vulgaire	<i>Barbarea vulgaris</i>
bassia à feuilles d'hysope	<i>Bassia hyssopifolia</i>
belle asclépiade	<i>Asclepias speciosa</i>
berce du Caucase	<i>Heracleum mantegazzianum</i>
bigelovie puante	<i>Chrysothamnus nauseosus</i>
bois d'arc	<i>Maclura pomifera</i>
cactus candélabre	<i>Euphorbia lactea</i>
cagarrino	<i>Euphorbia lathyris</i>
caladium	<i>Caladium bicolor</i>
calla des marais	<i>Calla palustris</i>
cardinale bleue	<i>Lobelia siphilitica</i>
carotte à Moreau	<i>Cicuta maculata</i>
centaurée de Russie	<i>Centaurea repens</i>
centaurée du solstice	<i>Centaurea solstitialis</i>
Ceratocephalus	<i>Ceratocephalus testiculatus</i>
cerisier d'amour	<i>Solanum pseudocapsicum</i>
cerisier de Pennsylvanie	<i>Prunus pensylvanica</i>
cerisier de Virginie	<i>Prunus virginiana</i>
cerisier tardif	<i>Prunus serotina</i>
chanvre	<i>Cannabis sativa</i>
chénopode blanc	<i>Chenopodium album</i>
chêne blanc	<i>Quercus alba</i>
chêne noir	<i>Quercus velutina</i>
chêne rouge	<i>Quercus rubra</i>
chèvrefeuille à mouches	<i>Lonicera xylosteum</i>
chèvrefeuille de Tartarie	<i>Lonicera tatarica</i>
chicot du Canada	<i>Gymnocladus dioica</i>
chou puant	<i>Symplocarpus foetidus</i>
chou sauvage	<i>Brassica oleracea</i>
chrysanthème	<i>Chrysanthemum indicum</i>
ciboulette	<i>Allium schoenoprasum</i>

cicutaire du nord	<i>Cicuta virosa</i>
cicutaire pourpre	<i>Cicuta douglasii</i>
cigüe maculée	<i>Conium maculatum</i>
clajeux	<i>Iris versicolor</i>
clivies	<i>Clivia miniata</i>
colchique d'automne	<i>Colchicum autumnale</i>
consoude âpre	<i>Symphytum asperum</i>
consoude officinale	<i>Symphytum officinale</i>
coqueret	<i>Physalis peruviana</i>
corne de cerf	<i>Aloe arborescens</i>
couronne d'épines	<i>Euphorbia milii</i>
croton ou codier	<i>Codiaeum variegatum</i>
cyclamen de Perse	<i>Cyclamen persicum</i>
cynoglosse officinale	<i>Cynoglossum officinale</i>
cypripède acaule	<i>Cypripedium acaule</i>
cypripède royal	<i>Cypripedium reginae</i>
cypripède soulier	<i>Cypripedium calceolus</i>
cytise	<i>Laburnum anagyroides</i>
dame d'onze heures	<i>Ornithogalum umbellatum</i>
daphné camélée	<i>Daphne cneorum</i>
daphné jolibois	<i>Daphne mezereum</i>
Delphinium menziesii	<i>Delphinium menziesii</i>
Delphinium	
dicentre à capuchon	<i>Dicentra cucullaria</i>
dicentre du Canada	<i>Dicentra canadensis</i>
dictame	<i>Dictamnus albus</i>
Dieffenbachia	<i>Dieffenbachia seguine</i>
dieffenbachia	<i>Dieffenbachia bausei</i>
dieffenbachia tachetée	<i>Dieffenbachia maculata</i>
dielytra à belles fleurs	<i>Dicentra formosa</i>
digitale pourpre	<i>Digitalis purpurea</i>
dirca des marais	<i>Dirca palustris</i>
érable rouge	<i>Acer rubrum</i>
eupatoire rugueuse	<i>Eupatorium rugosum</i>
euphorbe cyprès	<i>Euphorbia cyparissias</i>
euphorbe des jardins	<i>Euphorbia peplus</i>
euphorbe ésule	<i>Euphorbia esula</i>
euphorbe effilée	<i>Euphorbia tirucalli</i>
euphorbe réveille-matin	<i>Euphorbia helioscopia</i>

fausse herbe à poux	<i>Iva xanthifolia</i>
fougère d'aigle	<i>Pteridium aquilinum</i>
frêne puant	<i>Ailanthus altissima</i>
fusain	<i>Euonymus atropurpureus</i>
fusain d'Europe	<i>Euonymus europaeus</i>
ginkgo	<i>Ginkgo biloba</i>
glorieuse du Malabar	<i>Gloriosa superba</i>
glycérie géante	<i>Glyceria grandis</i>
glycine du Japon	<i>Wisteria floribunda</i>
graines à chapelet	<i>Caulophyllum thalictroides</i>
grande chélidoine	<i>Chelidonium majus</i>
grande oseille	<i>Rumex acetosa</i>
gui de chêne	<i>Phoradendron flavescens</i>
guttierrezie faux-sarothra	<i>Gutierrezia sarothrae</i>
hélénie automnale	<i>Helenium autumnale</i>
hélénie nudiflore	<i>Helenium flexuosum</i>
hélianthe annuel	<i>Helianthus annuus</i>
héliotrope obové de Curaçao	<i>Heliotropium curassavicum</i>
herbe à la puce	<i>Rhus radicans</i>
hortensia	<i>Hydrangea macrophylla</i>
houblon	<i>Humulus lupulus</i>
houx commun	<i>Ilex aquifolium</i>
houx d'Amérique	<i>Ilex opaca</i>
hyménoxys de Richardson	<i>Hymenoxys richardsonii</i>
if de l'Angleterre	<i>Taxus baccata</i>
if du Canada	<i>Taxus canadensis</i>
if du Japon	<i>Taxus cuspidata</i>
indigo sauvage	<i>Baptisia tinctoria</i>
iris de marais	<i>Iris pseudacorus</i>
jacinthe des bois	<i>Hyacinthoides nonscripta</i>
jonquille	<i>Narcissus pseudonarcissus</i>
jusquiame noire	<i>Hyoscyamus niger</i>
Kalanchoe	<i>Kalanchoe daigremontiana</i>
kalmia à feuilles d'andromède	<i>Kalmia polifolia</i>
kalmia à feuilles étroites	<i>Kalmia angustifolia</i>
kochia à balais	<i>Kochia scoparia</i>
laitue scariole	<i>Lactuca scariola</i>
lampourde glouteron	<i>Xanthium strumarium</i>

Lantana	<i>Lantana camara</i>
laportéa du Canada	<i>Laportea canadensis</i>
laurier rose	<i>Nerium oleander</i>
lentil d'Espagne	<i>Lathyrus sativus</i>
lierre commun	<i>Hedera helix</i>
lierre terrestre	<i>Glechoma hederacea</i>
linaire vulgaire	<i>Linaria vulgaris</i>
lis des Incas	<i>Alstroemeria ligtu</i>
liseron	<i>Ipomoea tricolor</i>
lobélie du cardinal	<i>Lobelia cardinalis</i>
lobélie gonflée	<i>Lobelia inflata</i>
lupin argenté	<i>Lupinus argenteus</i>
lupin de Burke	<i>Lupinus burkei</i>
lupin de polyphylle	<i>Lupinus polyphyllus</i>
lupin soyeux	<i>Lupinus sericeus</i>
Lupinus	<i>Lupinus pusillus</i>
luzerne	<i>Medicago sativa</i>
manguier	<i>Mangifera indica</i>
marronnier	<i>Aesculus hippocastanum</i>
marronnier à fleurs rouges	<i>Aesculus glabra</i>
mélilot blanc	<i>Melilotus alba</i>
mélilot jaune	<i>Melilotus officinalis</i>
ménisperme du Canada	<i>Menispermum canadense</i>
menziézie ferrugineuse	<i>Menziesia ferruginea</i>
millepertuis perforé	<i>Hypericum perforatum</i>
morelle douce-amère	<i>Solanum dulcamara</i>
morelle noire	<i>Solanum nigrum</i>
mouron rouge	<i>Anagallis arvensis</i>
moutarde de l'Inde	<i>Brassica juncea</i>
moutarde des champs	<i>Sinapis arvensis</i>
moutarde des oiseaux	<i>Brassica campestris</i>
moutarde tanaïsie verte	<i>Descurainia pinnata</i>
muguet	<i>Convallaria majalis</i>
narcisse	<i>Narcissus poeticus</i>
navette	<i>Brassica napus</i>
nerprun bourdaine	<i>Rhamnus frangula</i>
nerprun commun	<i>Rhamnus cathartica</i>
nielle	<i>Agrostemma githago</i>

noyer noir	<i>Juglans nigra</i>
obier	<i>Viburnum opulus</i>
oignon	<i>Allium cepa</i>
onoclée sensible	<i>Onoclea sensibilis</i>
ortie dioïque	<i>Urtica dioica</i>
oxytrophe de Lambert	<i>Oxytropis lambertii</i>
Oxytropis	<i>Oxytropis sericea</i>
panais sauvage	<i>Pastinaca sativa</i>
pavot coquelicot	<i>Papaver rhoeas</i>
pavot d'Islande	<i>Papaver nudicaule</i>
pavot d'Orient	<i>Papaver orientale</i>
pavot somnifère	<i>Papaver somniferum</i>
perce-neige	<i>Galanthus nivalis</i>
petite oseille	<i>Rumex acetosella</i>
petit-prêcheur	<i>Arisaema triphyllum</i>
phacélia de Californie	<i>Phacelia campanularia</i>
Philodendron cordatum	<i>Philodendron cordatum</i>
philodendron monstéra	<i>Monstera deliciosa</i>
Philodendron (scandens)	<i>Philodendron scandens</i>
phytolaque d'Amérique	<i>Phytolacca americana</i>
pied d'alouette bicolore	<i>Delphinium bicolor</i>
pied d'alouette glauque	<i>Delphinium glaucum</i>
pin ponderosa	<i>Pinus ponderosa</i>
podophylle pelté	<i>Podophyllum peltatum</i>
poinsettia	<i>Euphorbia pulcherrima</i>
pois de senteur	<i>Lathyrus odoratus</i>
pomme de terre	<i>Solanum tuberosum</i>
prêle des champs	<i>Equisetum arvense</i>
prêle des marais	<i>Equisetum palustre</i>
primula	<i>Primula obconica</i>
radis	<i>Raphanus sativus</i>
radis sauvage	<i>Raphanus raphanistrum</i>
raifort	<i>A Armoracia rusticana</i>
renoncule bulbeuse	<i>Ranunculus bulbosus</i>
renoncule scélérate	<i>Ranunculus sceleratus</i>
rhododendron de Californie	<i>Rhododendron macrophyllum</i>
rhubarbe	<i>Rheum rhaponticum</i>
ricin	<i>Ricinus communis</i>

robinier faux-acacia	<i>Robinia pseudoacacia</i>
rudbeckie hérissée	<i>Rudbeckia serotina</i>
rudbeckie laciniée	<i>Rudbeckia laciniata</i>
rumex veiné	<i>Rumex venosus</i>
sarcobatus vermiculé	<i>Sarcobatus vermiculatus</i>
sarrasin commun	<i>Fagopyrum esculentum</i>
scille de Sibérie	<i>Scilla siberica</i>
séneçon jacobée	<i>Senecio jacobaea</i>
séneçon vulgaire	<i>Senecio vulgaris</i>
Senecio	<i>Senecio integerrimus</i>
sorgho	<i>Sorghum bicolor</i>
sorgho d'Alep	<i>Sorghum halepense</i>
sorgho du Soudan	<i>Sorghum sudanense</i>
stramoine commune	<i>Datura stramonium</i>
stramoine parfumée	<i>Datura innoxia</i>
Suckleya	<i>Suckleya suckleyana</i>
sumac à vernis	<i>Rhus vernix</i>
sumac de l'Ouest	<i>Rhus diversiloba</i>
sureau blanc	<i>Sambucus canadensis</i>
sureau noir	<i>Sambucus nigra</i>
symphorine à grappes	<i>Symphoricarpos albus</i>
tabac	<i>Nicotiana tabacum</i>
tabouret des champs	<i>Thlaspi arvense</i>
tanaïsie vulgaire	<i>Tanacetum vulgare</i>
Thermopsis	<i>Thermopsis rhombifolia</i>
trèfle alsike	<i>Trifolium hybridum</i>
trèfle blanc	<i>Trifolium repens</i>
trèfle rouge	<i>Trifolium pratense</i>
troène commun	<i>Ligustrum vulgare</i>
trompette dorée	<i>Allamanda cathartica</i>
troscart des marais	<i>Triglochin palustre</i>
troscart maritime	<i>Triglochin maritima</i>
tulipe	<i>Tulipa gesneriana</i>
varaire vert	<i>Veratrum viride</i>
vélar fausse giroflée	<i>Erysimum cheiranthoides</i>
verge d'or veloutée	<i>Solidago mollis</i>
vesce cultivée	<i>Vicia sativa</i>
vesce fève	<i>Vicia faba</i>

[vesce velue](#)

Vicia villosa

[vigne vierge](#)

Parthenocissus quinquefolia

[vipérine](#)

Echium vulgare

[zigadène élégant](#)

Zigadenus elegans

[zigadène vénéneux](#)

Zigadenus venenosus

[Une autre recherche?](#)

[English](#) | [Contactez nous](#) | [Aide](#) | [Recherche](#) | [Site du Canada](#)

[À venir](#) | [À notre sujet](#) | [Liens](#) | [Rapports et publications](#) |

[Accueil](#)

Date de modification: 2003-02-06

[Avis important](#)



Français	Contact us	Help	Search	Canada site
Coming events	About CBIF	Links	Reports and publications	Home

Canadian Biodiversity Information Facility



Notes on poisoning: alder buckthorn

[Introduction](#)

[Interactive](#)

[All poisonous plants by Botanical name](#)

[All poisonous plants by Common name](#)

[Important WWW Poisonous Plants sites](#)

General poisoning notes:

Alder buckthorn (*Rhamnus frangula*) is a naturalized shrub or small tree that is found in parts of eastern Canada and the Prairie Provinces. This plant is found along fencerows and roadsides and in lightly shaded woodlands. Several purgative chemicals, including emodin, occur in the bark and in the purple-black fruits. This plant causes usually mild symptoms if ingested by children. There is one record of fatal poisoning of a cow (Cooper and Johnson 1984, Fuller and McClintock 1985).



References:

Cooper, M. R., Johnson, A. W. 1984. Poisonous plants in Britain and their effects on animals and man. Her Majesty's Stationery Office, London, England. 305 pp.

Nomenclature:

Scientific Name: *Rhamnus frangula* L.

Vernacular name(s): alder buckthorn

Scientific family name: *Rhamnaceae*

Vernacular family name: buckthorn

Go to ITIS*^{ca} for more taxonomic information on: [Rhamnus frangula](#)

References:

Agriculture Quebec. 1975. Noms des maladies des plantes du Canada/ Names of plant diseases in Canada. , Quebec City, Que., Canada. 288 pp.

Alex, J. F., Cayouette, R., Mulligan, G. A. 1980. Common and botanical names of weeds in Canada/Noms populaire et scientifiques

des plantes nuisibles du Canada. Revised. Agric. Can. Publ., Ottawa, Ont., Canada. 132 pp.

Bailey, L. H., Bailey, E. Z. 1976. Hortus third. Revised. MacMillan, New York, N.Y., USA. 1290 pp.

Scoggan, H. J. 1978, 1979. The flora of Canada. Nat. Mus. Nat. Sci. (Ottawa) Publ. Bot. 7(1)-7(4). 1711 pp.

Van Wijk, H. L. 1911. A dictionary of plant names. Martinus Nijhoff, The Hague, The Netherlands. 1444 pp.

Victorin, M. 1964. Flore Laurentienne. 2nd ed. Univ. Montreal, Montreal, Que., Canada. 952 pp.

Geographic Information

Manitoba
New Brunswick
Nova Scotia
Ontario
Prince Edward Island
Quebec

References:

Bailey, L. H., Bailey, E. Z. 1976. Hortus third. Revised. MacMillan, New York, N.Y., USA. 1290 pp.

Boivin, B. 1966, 1967. Énumération des plantes du Canada. Provencheria 6. Nat. Can. (Que.) 93: 253-274; 371-437; 583-646; 989-1063. 94: 131-157; 471-528; 625-655.

Image or illustration

alder buckthorn:

Images: images.google.com

Toxic parts:

bark
mature fruit

References:

Cooper, M. R., Johnson, A. W. 1984. Poisonous plants in Britain and their effects on animals and man. Her Majesty's Stationery Office, London, England. 305 pp.

Notes on Toxic plant chemicals:

Alder buckthorn contains glycosides, which upon hydrolysis yield anthraquinones such as emodin (a trihydroxymethylanthraquinone). These chemicals are purgative; emodin has been used in laxatives (Cooper and Johnson 1984).

Toxic plant chemicals:

anthraquinones

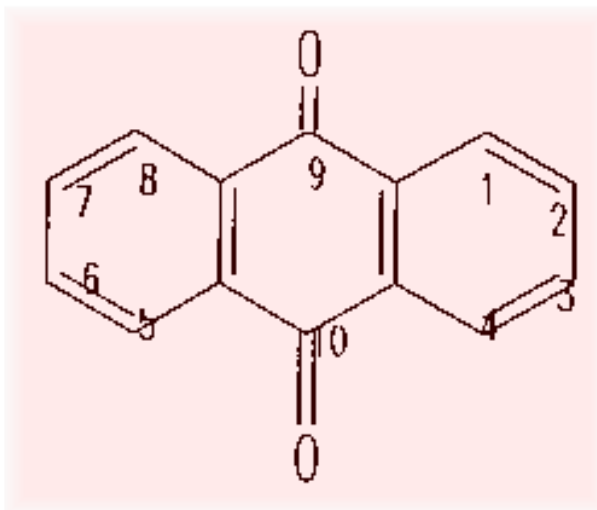

emodine

Chemical diagram(s) are courtesy of [Ruth McDiarmid](#), Biochemistry Technician, Kamloops Range Station, Agriculture and Agri-Food Canada, Kamloops, British Columbia, Canada.

References:

Cooper, M. R., Johnson, A. W. 1984. Poisonous plants in Britain and their effects on animals and man. Her Majesty's Stationery Office, London, England. 305 pp.

Animals/Human Poisoning:

Note: When an animal is listed without additional information, the literature (as of 1993) contained no detailed explanation.

Cattle

General symptoms of poisoning:

[death](#)

[diarrhea](#)

[fever](#)

[vomiting](#)

Notes on poisoning:

In one case of fatal poisoning, a cow ate large quantities of leaves, twigs, and berries of alder buckthorn. The animal quickly became ill and developed symptoms of diarrhea, vomiting, slow pulse, cramps, and slight fever before death. Postmortem examination showed leaves of the plant in the stomach, with gastrointestinal inflammation (Cooper and Johnson 1984).

References:

Cooper, M. R., Johnson, A. W. 1984. Poisonous plants in Britain and their effects on animals and man. Her Majesty's Stationery Office, London, England. 305 pp.

Humans

General symptoms of poisoning:

[abdominal pains](#)

[collapse](#)

[convulsions](#)

[diarrhea](#)

[gastroenteritis](#)

[hemorrhage](#)

[vomiting](#)

Notes on poisoning:

Children who ingest the plant material usually experience mild symptoms of poisoning such as transient abdominal pains, vomiting, and diarrhea. If 20 or more berries are ingested, symptoms may include gastrointestinal symptoms, fluid depletion, kidney damage, muscular convulsions, and hemorrhage. In severe cases, difficult breathing and collapse may occur. Severe poisoning is rare because of induced vomiting. Treatment should replace lost fluids and induce vomiting if it has not occurred (Cooper and Johnson 1984, Fuller and McClintock 1985).

References:

Cooper, M. R., Johnson, A. W. 1984. Poisonous plants in Britain and their effects on animals and man. Her Majesty's Stationery Office, London, England. 305 pp.

[Another search?](#)

[Français](#) | [Contact Us](#) | [Help](#) | [Search](#) | [Canada site](#)

[Coming Events](#) | [About CBIF](#) | [Links](#) | [Reports and Publications](#) |

[Home](#)

Date modified: 2003-02-06

[Important Notices](#)



Français	Contact us	Help	Search	Canada site
Coming events	About CBIF	Links	Reports and publications	Home

Canadian Biodiversity Information Facility



Notes on poisoning: alfalfa

[Introduction](#)[Interactive](#)[All poisonous plants by Botanical name](#)[All poisonous plants by Common name](#)[Important WWW Poisonous Plants sites](#)

General poisoning notes:

Alfalfa (*Medicago sativa*) is an important forage and silage crop in Canada. However, under some circumstances, alfalfa can cause a variety of different toxic problems. Ingesting rapidly growing alfalfa at the vegetative to mid-bud stage can cause bloat in cattle and sheep (Hall and Majak 1989). Alfalfa has also caused photosensitization in cattle with white skin (MacDonald 1954). Alfalfa contains phytoestrogens which cause infertility in animals, including cattle and sheep. These compounds are also contained in some alfalfa pills that are found in health food stores, and these may cause problems in some cases (Cheeke and Schull 1985). Alfalfa also contains saponins that can interfere with the growth of poultry and thus reduce egg-laying (Fuller and McClintock 1986, Oakenfull and Sidhu 1989). Low saponin cultivars have been developed.

References:

- Adams, N. R. 1989. Phytoestrogens. Pages 23-51 in Cheeke, P. R., ed. Toxicants of plant origin. Vol. IV. Phenolics. CRC Press, Inc., Boca Raton, Fla., USA. 232 pp.
- Cheeke, P. R., Shull, L. R. 1985. Natural toxicants in feeds and poisonous plants. AVI Publishing Company, Inc., Westport, Conn., USA. 492 pp.
- Fuller, T. C., McClintock, E. 1986. Poisonous plants of California. Univ. California Press, Berkeley, Calif., USA. 432 pp.
- Hall, J. W., Majak, W. 1989. Plant and animal factors in legume bloat. Pages 93-106 in Cheeke, P. R., ed. Toxicants of plant origin. Vol. III. Proteins and amino acids. CRC Press, Inc., Boca Raton, Fla., USA. 271 pp.
- MacDonald, H. E. 1954. Photosensitization. Can. J. Comp. Med., 18: 228.
- Oakenfull, D., Sidhu, G. S. 1989. Saponins. Pages 97-143 in Cheeke, P. R., ed. Toxicants of plant origin. Vol. II. Glycosides. CRC Press, Inc., Boca Raton, Fla., USA. 277 pp.

Nomenclature:

Scientific Name: *Medicago sativa* L.

Vernacular name(s): alfalfa

Scientific family name: *Leguminosae*

Vernacular family name: pea

Go to ITIS*^{ca} for more taxonomic information on: [Medicago sativa](#)

References:

Agriculture Quebec. 1975. Noms des maladies des plantes du Canada/
Names of plant diseases in Canada. , Quebec City, Que., Canada. 288 pp.

Alex, J. F., Cayouette, R., Mulligan, G. A. 1980. Common and botanical
names of weeds in Canada/Noms populaire et scientifiques des plantes
nuisibles du Canada. Revised. Agric. Can. Publ., Ottawa, Ont., Canada.
132 pp.

Bailey, L. H., Bailey, E. Z. 1976. Hortus third. Revised. MacMillan, New
York, N.Y., USA. 1290 pp.

Scoggan, H. J. 1978, 1979. The flora of Canada. Nat. Mus. Nat. Sci.
(Ottawa) Publ. Bot. 7(1)-7(4). 1711 pp.

Van Wijk, H. L. 1911. A dictionary of plant names. Martinus Nijhoff,
The Hague, The Netherlands. 1444 pp.

Victorin, M. 1964. Flore Laurentienne. 2nd ed. Univ. Montreal,
Montreal, Que., Canada. 952 pp.

Geographic Information

Alberta
British Columbia
Manitoba
New Brunswick
Northwest Territories
Nova Scotia
Ontario
Prince Edward Island
Quebec
Saskatchewan

References:

Bailey, L. H., Bailey, E. Z. 1976. Hortus third. Revised. MacMillan, New
York, N.Y., USA. 1290 pp.

Boivin, B. 1966, 1967. Énumération des plantes du Canada. Provencheria

6. Nat. Can. (Que.) 93: 253-274; 371-437; 583-646; 989-1063. 94: 131-157; 471-528; 625-655.

Image or illustration

alfalfa:

Images: images.google.com

Toxic parts:

leaves

stems

References:

Fuller, T. C., McClintock, E. 1986. Poisonous plants of California. Univ. California Press, Berkeley, Calif., USA. 432 pp.

Notes on Toxic plant chemicals:

Alfalfa contains two phytoestrogenic compounds, coumestrol and coumestan. These compounds can cause fertility problems in sheep and cattle. Alfalfa also contains bloat-causing proteins. Saponins, such as medicagenic acid, can cause growth reduction in poultry (Adams 1989, Hall and Majak 1989, Oakenfull and Sidhu 1989).

Toxic plant chemicals:

coumestan

coumestrol

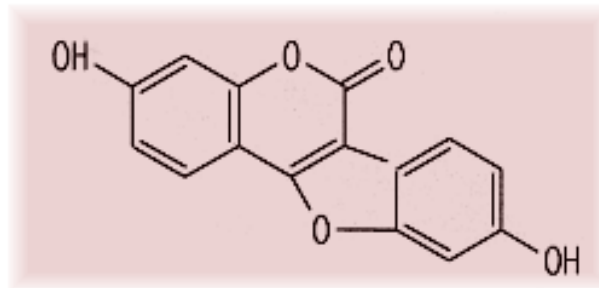

medicagenic acid

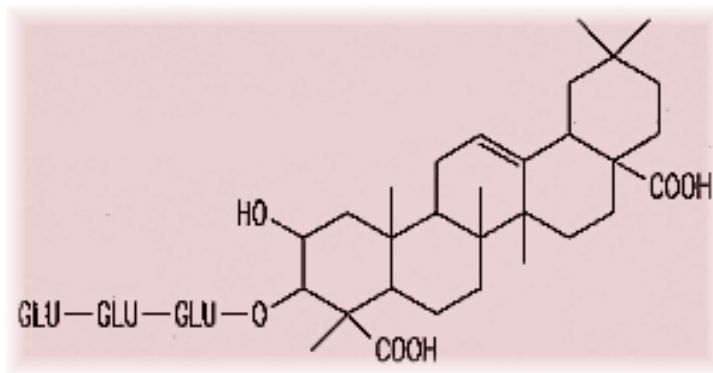

Chemical diagram(s) are courtesy of [Ruth McDiarmid](#), Biochemistry Technician, Kamloops Range Station, Agriculture and Agri-Food Canada, Kamloops, British Columbia, Canada.

References:

Adams, N. R. 1989. Phytoestrogens. Pages 23-51 in Cheeke, P. R., ed. Toxicants of plant origin. Vol. IV. Phenolics. CRC Press, Inc., Boca Raton, Fla., USA. 232 pp.

Fuller, T. C., McClintock, E. 1986. Poisonous plants of California. Univ. California Press, Berkeley, Calif., USA. 432 pp.

Oakenfull, D., Sidhu, G. S. 1989. Saponins. Pages 97-143 in Cheeke, P. R., ed. Toxicants of plant origin. Vol. II. Glycosides. CRC Press, Inc., Boca Raton, Fla., USA. 277 pp.

Animals/Human Poisoning:

Note: When an animal is listed without additional information, the literature (as of 1993) contained no detailed explanation.

Cattle

General symptoms of poisoning:

[bloat](#)

[infertility](#)

Notes on poisoning:

Cattle are especially susceptible to bloat after ingesting rapidly growing alfalfa in the vegetative to mid-bud stage of growth. The formation of stable foam bubbles is recognized as being affected by the concentration of cytoplasmic proteins, which is in turn affected by rumen pH, and the colloidal suspension of chloroplast particles from the plant; the stability is controlled by ion concentration (Hall and Majak 1989). Alfalfa also contains phytoestrogens, which have caused infertility problems in dairy cattle because of cystic ovaries and irregular estrous cycles. Precocious development of mammary glands also occurs, as well as genital

formation in heifers. The coumestan chemicals suppress estrous and inhibit ovulation (Cheeke and Schull 1985, Adams 1989).

References:

Adams, N. R. 1989. Phytoestrogens. Pages 23-51 in Cheeke, P. R., ed. Toxicants of plant origin. Vol. IV. Phenolics. CRC Press, Inc., Boca Raton, Fla., USA. 232 pp.

Cheeke, P. R., Shull, L. R. 1985. Natural toxicants in feeds and poisonous plants. AVI Publishing Company, Inc., Westport, Conn., USA. 492 pp.

Fuller, T. C., McClintock, E. 1986. Poisonous plants of California. Univ. California Press, Berkeley, Calif., USA. 432 pp.

Hall, J. W., Majak, W. 1989. Plant and animal factors in legume bloat. Pages 93-106 in Cheeke, P. R., ed. Toxicants of plant origin. Vol. III. Proteins and amino acids. CRC Press, Inc., Boca Raton, Fla., USA. 271 pp.

Chickens

General symptoms of poisoning:

[weight gain, reduced](#)

References:

Oakenfull, D., Sidhu, G. S. 1989. Saponins. Pages 97-143 in Cheeke, P. R., ed. Toxicants of plant origin. Vol. II. Glycosides. CRC Press, Inc., Boca Raton, Fla., USA. 277 pp.

Humans

General symptoms of poisoning:

[infertility](#)

Notes on poisoning:

Alfalfa tablets are available in health food stores as a dietary supplement for humans. The benefits of the tablets are not clear. Measurements of the phytoestrogen content of some commercial brands have ranged from 20 to 190 ppm. This level of intake, in conjunction with other sources of estrogen (such as birth control pills and estrogen replacement therapy), may be potentially harmful (Cheeke and Schull 1985).

References:

Cheeke, P. R., Shull, L. R. 1985. Natural toxicants in feeds and poisonous plants. AVI Publishing Company, Inc., Westport, Conn., USA.

492 pp.

Sheep

General symptoms of poisoning:

[bloat](#)

[erythema](#)

[infertility](#)

[skin, peeling of](#)

References:

Cheeke, P. R., Shull, L. R. 1985. Natural toxicants in feeds and poisonous plants. AVI Publishing Company, Inc., Westport, Conn., USA. 492 pp.

MacDonald, H. E. 1954. Photosensitization. Can. J. Comp. Med., 18: 228.

[Another search?](#)

[Français](#) | [Contact Us](#) | [Help](#) | [Search](#) | [Canada site](#)

[Coming Events](#) | [About CBIF](#) | [Links](#) | [Reports and Publications](#) | [Home](#)

Date modified: 2003-02-06

[Important Notices](#)



Français	Contact us	Help	Search	Canada site
Coming events	About CBIF	Links	Reports and publications	Home

Canadian Biodiversity Information Facility



Notes on poisoning: aloe - A. barbadensis

[Introduction](#)

[Interactive](#)

[All poisonous plants by Botanical name](#)

[All poisonous plants by Common name](#)

[Important WWW Poisonous Plants sites](#)



General poisoning notes:

Aloe (*Aloe barbadensis*) is the common "Aloe vera" found in extracts that are used in cosmetics and medicinal products. The latex from under the skin can cause a cathartic action because it irritates the large intestine; anthraquinones color alkaline urine red. An excessive dose may cause nephritis (Lampe and McCann 1985). Contact dermatitis can also result from contact with this plant.

References:

Lampe, K. F., McCann, M. A. 1985. AMA Handbook of poisonous and injurious plants. American Medical Assoc. Chicago, Ill., USA. 432 pp.

Schenkel, B., Vorherr, H. 1974. Non-prescription drugs during pregnancy: potential teratogenic and toxic effects upon embryo and fetus. J. Reprod. Med., 12: 33.

Spoerke, D. G., Ekins, B. R. 1980. *Aloe vera* - fact or quackery. Vet. Hum. Toxicol., 22: 418-424.

Nomenclature:

Scientific Name: *Aloe barbadensis* Mill.

Vernacular name(s): aloe - A. barbadensis

Scientific family name: *Liliaceae*

Vernacular family name: lily

Go to ITIS^{*ca} for more taxonomic information on: [Aloe barbadensis](#)

References:

Agriculture Quebec. 1975. Noms des maladies des plantes du Canada/ Names of plant diseases in Canada. , Quebec City, Que., Canada. 288 pp.

Alex, J. F., Cayouette, R., Mulligan, G. A. 1980. Common and botanical names of weeds in Canada/Noms populaire et scientifiques des plantes nuisibles du Canada. Revised. Agric. Can. Publ., Ottawa, Ont., Canada. 132 pp.

Bailey, L. H., Bailey, E. Z. 1976. Hortus third. Revised. MacMillan, New York, N.Y., USA. 1290 pp.

Scoggan, H. J. 1978, 1979. The flora of Canada. Nat. Mus. Nat. Sci. (Ottawa) Publ. Bot. 7(1)-7(4). 1711 pp.

Van Wijk, H. L. 1911. A dictionary of plant names. Martinus Nijhoff, The Hague, The Netherlands. 1444 pp.

Victorin, M. 1964. Flore Laurentienne. 2nd ed. Univ. Montreal, Montreal, Que., Canada. 952 pp.

Geographic Information

Plant or plant parts used in or around the home.

References:

Bailey, L. H., Bailey, E. Z. 1976. Hortus third. Revised. MacMillan, New York, N.Y., USA. 1290 pp.

Boivin, B. 1966, 1967. Énumération des plantes du Canada. Provencheria 6. Nat. Can. (Que.) 93: 253-274; 371-437; 583-646; 989-1063. 94: 131-157; 471-528; 625-655.

Image or illustration

aloe - *A. barbadensis*:

Images: images.google.com

Toxic parts:

latex

References:

Schenkel, B., Vorherr, H. 1974. Non-prescription drugs during pregnancy: potential teratogenic and toxic effects upon embryo and fetus. J. Reprod. Med., 12: 33.

Spoerke, D. G., Ekins, B. R. 1980. *Aloe vera* - fact or quackery. Vet. Hum. Toxicol., 22: 418-424.

Toxic plant chemicals:

aloe-emodin

References:

Spoerke, D. G., Ekins, B. R. 1980. *Aloe vera* - fact or quackery. Vet. Hum. Toxicol., 22: 418-424.

Animals/Human Poisoning:

Note: When an animal is listed without additional information, the literature (as of 1993) contained no detailed explanation.

Humans

General symptoms of poisoning:

[catharsis](#)

[nephritis](#)

References:

Schenkel, B., Vorherr, H. 1974. Non-prescription drugs during pregnancy: potential teratogenic and toxic effects upon embryo and fetus. J. Reprod. Med., 12: 33.

Spoerke, D. G., Ekins, B. R. 1980. *Aloe vera* - fact or quackery. Vet. Hum. Toxicol., 22: 418-424.

[Another search?](#)

[Français](#) | [Contact Us](#) | [Help](#) | [Search](#) | [Canada site](#)

[Coming Events](#) | [About CBIF](#) | [Links](#) | [Reports and Publications](#) |

[Home](#)

Date modified: 2003-02-06

[Important Notices](#)



Français	Contact us	Help	Search	Canada site
Coming events	About CBIF	Links	Reports and publications	Home

Canadian Biodiversity Information Facility



Notes on poisoning: alsike clover

[Introduction](#)

[Interactive](#)

[All poisonous plants by Botanical name](#)

[All poisonous plants by Common name](#)

[Important WWW Poisonous Plants sites](#)



General poisoning notes:

Alsike clover (*Trifolium hybridum*) is found most frequently in the farming areas of northern Canada. This plant is adapted to cool climates and heavy, poorly drained clay soils. Cases of photosensitization have occurred, sometimes accompanied by liver damage and enlargement. This problem has occurred mostly in horses and occasionally in cattle. There is also a potential for nitrate poisoning (Cooper and Johnson 1984, Cheeke and Schull 1985).

References:

Cheeke, P. R., Shull, L. R. 1985. Natural toxicants in feeds and poisonous plants. AVI Publishing Company, Inc., Westport, Conn., USA. 492 pp.

Cooper, M. R., Johnson, A. W. 1984. Poisonous plants in Britain and their effects on animals and man. Her Majesty's Stationery Office, London, England. 305 pp.

Fincher, M. G., Fuller, H. K. 1942. Photosensitization - trifoliosis - light sensitization. Cornell Vet., 32: 95-99.

Nation, P. N. 1989. Alsike clover poisoning: a review. Can. Vet. J., 30: 410-415.

Traub, J. L., Potter, K. A., Bayly, W. M., Reed, S. M. 1982. Alsike clover poisoning. Mod. Vet. Pract., 63: 307-309.

Nomenclature:

Scientific Name: *Trifolium hybridum* L.

Vernacular name(s): alsike clover

Scientific family name: *Leguminosae*

Vernacular family name: pea

Go to ITIS^{*ca} for more taxonomic information on: [Trifolium hybridum](#)

References:

Agriculture Quebec. 1975. Noms des maladies des plantes du Canada/ Names of plant diseases in Canada. , Quebec City, Que., Canada. 288 pp.

Alex, J. F., Cayouette, R., Mulligan, G. A. 1980. Common and botanical names of weeds in Canada/Noms populaire et scientifiques des plantes nuisibles du Canada. Revised. Agric. Can. Publ., Ottawa, Ont., Canada. 132 pp.

Bailey, L. H., Bailey, E. Z. 1976. Hortus third. Revised. MacMillan, New York, N.Y., USA. 1290 pp.

Scoggan, H. J. 1978, 1979. The flora of Canada. Nat. Mus. Nat. Sci. (Ottawa) Publ. Bot. 7(1)-7(4). 1711 pp.

Van Wijk, H. L. 1911. A dictionary of plant names. Martinus Nijhoff, The Hague, The Netherlands. 1444 pp.

Victorin, M. 1964. Flore Laurentienne. 2nd ed. Univ. Montreal, Montreal, Que., Canada. 952 pp.

Geographic Information

Alberta
British Columbia
Labrador
Manitoba
New Brunswick
Nova Scotia
Ontario
Prince Edward Island
Quebec
Saskatchewan
Yukon Territory

References:

Bailey, L. H., Bailey, E. Z. 1976. Hortus third. Revised. MacMillan, New York, N.Y., USA. 1290 pp.

Boivin, B. 1966, 1967. Énumération des plantes du Canada. Provencheria 6. Nat. Can. (Que.) 93: 253-274; 371-437; 583-646; 989-1063. 94: 131-157; 471-528; 625-655.

Image or illustration

alsike clover:

Images: images.google.com

Notes on Poisonous plant parts:

Ingesting alsike clover causes photosensitization in horses and cattle. The toxic compounds have not been indentified. Nitrates may also accumulate in the plant (Cooper and Johnson 1984).

Toxic parts:

all parts
leaves

References:

Cheeke, P. R., Shull, L. R. 1985. Natural toxicants in feeds and poisonous plants. AVI Publishing Company, Inc., Westport, Conn., USA. 492 pp.

Toxic plant chemicals:

nitrate

References:

Cheeke, P. R., Shull, L. R. 1985. Natural toxicants in feeds and poisonous plants. AVI Publishing Company, Inc., Westport, Conn., USA. 492 pp.

Animals/Human Poisoning:

Note: When an animal is listed without additional information, the literature (as of 1993) contained no detailed explanation.

Cattle

General symptoms of poisoning:

[breathing, labored](#)

[cyanosis](#)

[gait, staggering](#)

References:

Cooper, M. R., Johnson, A. W. 1984. Poisonous plants in Britain and their effects on animals and man. Her Majesty's Stationery Office, London, England. 305 pp.

Horses

General symptoms of poisoning:

[blindness](#)

[depression](#)

[gait, staggering](#)

[liver, cirrhosis of](#)

[nephrosis, severe](#)

References:

Cooper, M. R., Johnson, A. W. 1984. Poisonous plants in Britain and their effects on animals and man. Her Majesty's Stationery Office, London, England. 305 pp.

Traub, J. L., Potter, K. A., Bayly, W. M., Reed, S. M. 1982. Alsike clover poisoning. Mod. Vet. Pract., 63: 307-309.

[Another search?](#)

[Français](#) | [Contact Us](#) | [Help](#) | [Search](#) | [Canada site](#)

[Coming Events](#) | [About CBIF](#) | [Links](#) | [Reports and Publications](#) |

[Home](#)

Date modified: 2003-02-06

[Important Notices](#)



Français	Contact us	Help	Search	Canada site
Coming events	About CBIF	Links	Reports and publications	Home

Canadian Biodiversity Information Facility



Notes on poisoning: amaryllis (A. belladonna)

[Introduction](#)

[Interactive](#)

[All poisonous plants by Botanical name](#)

[All poisonous plants by Common name](#)

[Important WWW Poisonous Plants sites](#)

General poisoning notes:

Amaryllis (*Amaryllis belladonna*) is an ornamental plant commonly sold for its winter flowers. Ingesting the bulbs has poisoned humans. The toxic alkaloid, lycorine, is the principal toxin, although small quantities of related alkaloids are also present (Lampe and McCann 1985; Fuller and McClintock 1986).



References:

- Fuller, T. C., McClintock, E. 1986. Poisonous plants of California. Univ. California Press, Berkeley, Calif., USA. 432 pp.
- Lampe, K. F., McCann, M. A. 1985. AMA Handbook of poisonous and injurious plants. American Medical Assoc. Chicago, Ill., USA. 432 pp.

Nomenclature:

Scientific Name: *Amaryllis belladonna* L.

Vernacular name(s): amaryllis (A. belladonna)

Scientific family name: *Amaryllidaceae*

Vernacular family name: amaryllis

Go to ITIS^{*ca} for more taxonomic information on: [Amaryllis belladonna](#)

References:

Agriculture Quebec. 1975. Noms des maladies des plantes du Canada/ Names of plant diseases in Canada. , Quebec City, Que., Canada. 288 pp.

Alex, J. F., Cayouette, R., Mulligan, G. A. 1980. Common and

botanical names of weeds in Canada/Noms populaire et scientifiques des plantes nuisibles du Canada. Revised. Agric. Can. Publ., Ottawa, Ont., Canada. 132 pp.

Bailey, L. H., Bailey, E. Z. 1976. Hortus third. Revised. MacMillan, New York, N.Y., USA. 1290 pp.

Scoggan, H. J. 1978, 1979. The flora of Canada. Nat. Mus. Nat. Sci. (Ottawa) Publ. Bot. 7(1)-7(4). 1711 pp.

Van Wijk, H. L. 1911. A dictionary of plant names. Martinus Nijhoff, The Hague, The Netherlands. 1444 pp.

Victorin, M. 1964. Flore Laurentienne. 2nd ed. Univ. Montreal, Montreal, Que., Canada. 952 pp.

Geographic Information

Plant or plant parts used in or around the home.

References:

Bailey, L. H., Bailey, E. Z. 1976. Hortus third. Revised. MacMillan, New York, N.Y., USA. 1290 pp.

Boivin, B. 1966, 1967. Énumération des plantes du Canada. Provencheria 6. Nat. Can. (Que.) 93: 253-274; 371-437; 583-646; 989-1063. 94: 131-157; 471-528; 625-655.

Image or illustration

amaryllis (A. belledonna):

Images: images.google.com

Toxic parts:

bulbs

References:

Lampe, K. F., McCann, M. A. 1985. AMA Handbook of poisonous and injurious plants. American Medical Assoc. Chicago, Ill., USA. 432 pp.

Notes on Toxic plant chemicals:

Lycorine, a heat-stable alkaloid, is found in *Amaryllis* spp. as well as *Clivia* spp., *Galanthus nivalis*, and *Narcissus* spp. This chemical occurs in small quantities in *Amaryllis* species, so that large quantities of bulb must be eaten to cause symptoms (Lampe

and McCann 1985).

Toxic plant chemicals:

lycorine

References:

Fuller, T. C., McClintock, E. 1986. Poisonous plants of California. Univ. California Press, Berkeley, Calif., USA. 432 pp.

Lampe, K. F., McCann, M. A. 1985. AMA Handbook of poisonous and injurious plants. American Medical Assoc. Chicago, Ill., USA. 432 pp.

Animals/Human Poisoning:

Note: When an animal is listed without additional information, the literature (as of 1993) contained no detailed explanation.

Humans

General symptoms of poisoning:

[diarrhea](#)

[nausea](#)

[vomiting](#)

References:

Fuller, T. C., McClintock, E. 1986. Poisonous plants of California. Univ. California Press, Berkeley, Calif., USA. 432 pp.

Lampe, K. F., McCann, M. A. 1985. AMA Handbook of poisonous and injurious plants. American Medical Assoc. Chicago, Ill., USA. 432 pp.

[Another search?](#)

[Français](#) | [Contact Us](#) | [Help](#) | [Search](#) | [Canada site](#)

[Coming Events](#) | [About CBIF](#) | [Links](#) | [Reports and Publications](#) |

[Home](#)

Date modified: 2003-02-06

[Important Notices](#)



Français	Contact us	Help	Search	Canada site
Coming events	About CBIF	Links	Reports and publications	Home

Canadian Biodiversity Information Facility



Notes on poisoning: amaryllis (*A. vittata*)

[Introduction](#)

[Interactive](#)

[All poisonous plants by Botanical name](#)

[All poisonous plants by Common name](#)

[Important WWW Poisonous Plants sites](#)

General poisoning notes:

The symptoms of poisoning and the chemical involved in amaryllis (*A. vittata*) are the same as those for [A. belladonna](#).

Please see the additional notes listed under that species.

References:



Lampe, K. F., McCann, M. A. 1985. AMA Handbook of poisonous and injurious plants. American Medical Assoc. Chicago, Ill., USA. 432 pp.

Nomenclature:

Scientific Name: *Amaryllis vittata* Ait.

Vernacular name(s): amaryllis (*A. vittata*)

Scientific family name: *Amaryllidaceae*

Vernacular family name: amaryllis

References:

Agriculture Quebec. 1975. Noms des maladies des plantes du Canada/ Names of plant diseases in Canada. , Quebec City, Que., Canada. 288 pp.

Alex, J. F., Cayouette, R., Mulligan, G. A. 1980. Common and botanical names of weeds in Canada/Noms populaire et scientifiques des plantes nuisibles du Canada. Revised. Agric. Can. Publ., Ottawa, Ont., Canada. 132 pp.

Bailey, L. H., Bailey, E. Z. 1976. Hortus third. Revised. MacMillan, New York, N.Y., USA. 1290 pp.

Scoggan, H. J. 1978, 1979. The flora of Canada. Nat. Mus. Nat.

Sci. (Ottawa) Publ. Bot. 7(1)-7(4). 1711 pp.

Van Wijk, H. L. 1911. A dictionary of plant names. Martinus Nijhoff, The Hague, The Netherlands. 1444 pp.

Victorin, M. 1964. Flore Laurentienne. 2nd ed. Univ. Montreal, Montreal, Que., Canada. 952 pp.

Geographic Information

Plant or plant parts used in or around the home.

References:

Bailey, L. H., Bailey, E. Z. 1976. Hortus third. Revised. MacMillan, New York, N.Y., USA. 1290 pp.

Boivin, B. 1966, 1967. Énumération des plantes du Canada. Provencheria 6. Nat. Can. (Que.) 93: 253-274; 371-437; 583-646; 989-1063. 94: 131-157; 471-528; 625-655.

Image or illustration

amaryllis (*A. vittata*):

Images: images.google.com

Toxic parts:

bulbs

References:

Lampe, K. F., McCann, M. A. 1985. AMA Handbook of poisonous and injurious plants. American Medical Assoc. Chicago, Ill., USA. 432 pp.

Toxic plant chemicals:

lycorine

References:

Lampe, K. F., McCann, M. A. 1985. AMA Handbook of poisonous and injurious plants. American Medical Assoc. Chicago, Ill., USA. 432 pp.

Animals/Human Poisoning:

Note: When an animal is listed without additional information, the literature (as of 1993) contained no detailed explanation.

Humans

General symptoms of poisoning:

[nausea](#)

[vomiting](#)

References:

Lampe, K. F., McCann, M. A. 1985. AMA Handbook of poisonous and injurious plants. American Medical Assoc. Chicago, Ill., USA. 432 pp.

[Another search?](#)

[Français](#) | [Contact Us](#) | [Help](#) | [Search](#) | [Canada site](#)

[Coming Events](#) | [About CBIF](#) | [Links](#) | [Reports and Publications](#) |

[Home](#)

Date modified: 2003-02-06

[Important Notices](#)



Français	Contact us	Help	Search	Canada site
Coming events	About CBIF	Links	Reports and publications	Home

Canadian Biodiversity Information Facility



Notes on poisoning: American elder

[Introduction](#)[Interactive](#)[All poisonous plants by Botanical name](#)[All poisonous plants by Common name](#)[Important WWW Poisonous Plants sites](#)

General poisoning notes:

American elder (*Sambucus canadensis*) is a native shrub found in the moist soils of swamps and along rivers and lakes in eastern Canada. This plant contains cyanogenic glycosides and a cathartic chemical. The plant has poisoned cattle and perhaps sheep. Children were poisoned after using the hollow stems for whistles. Ingesting uncooked berries may cause nausea (Kingsbury 1964, Muenscher 1978). Red-berried elder (*Sambucus pubens*) is a native shrub found from Newfoundland to Manitoba. There are unsubstantiated reports that this species may also have toxic potential. Children should not be allowed to chew the stems or berries.

References:

- Kingsbury, J. M. 1964. Poisonous plants of the United States and Canada. Prentice-Hall Inc., Englewood Cliffs, N.J., USA. 626 pp.
- Muenscher, W. C. 1975. Poisonous plants of the United States. Revised. Collier Books, New York, N.Y., USA. 277 pp.

Nomenclature:

Scientific Name: *Sambucus canadensis* L.

Vernacular name(s): American elder

Scientific family name: *Caprifoliaceae*

Vernacular family name: honeysuckle

Go to ITIS^{*ca} for more taxonomic information on: [Sambucus canadensis](#)

References:

Agriculture Quebec. 1975. Noms des maladies des plantes du Canada/ Names of plant diseases in Canada. , Quebec City, Que., Canada. 288 pp.

Alex, J. F., Cayouette, R., Mulligan, G. A. 1980. Common and botanical names of weeds in Canada/Noms populaire et scientifiques des plantes nuisibles du Canada. Revised. Agric. Can. Publ., Ottawa, Ont., Canada. 132 pp.

Bailey, L. H., Bailey, E. Z. 1976. Hortus third. Revised. MacMillan, New York, N.Y., USA. 1290 pp.

Scoggan, H. J. 1978, 1979. The flora of Canada. Nat. Mus. Nat. Sci. (Ottawa) Publ. Bot. 7(1)-7(4). 1711 pp.

Van Wijk, H. L. 1911. A dictionary of plant names. Martinus Nijhoff, The Hague, The Netherlands. 1444 pp.

Victorin, M. 1964. Flore Laurentienne. 2nd ed. Univ. Montreal, Montreal, Que., Canada. 952 pp.

Geographic Information

New Brunswick
Nova Scotia
Ontario
Prince Edward Island
Quebec

References:

Bailey, L. H., Bailey, E. Z. 1976. Hortus third. Revised. MacMillan, New York, N.Y., USA. 1290 pp.

Boivin, B. 1966, 1967. Énumération des plantes du Canada. Provencheria 6. Nat. Can. (Que.) 93: 253-274; 371-437; 583-646; 989-1063. 94: 131-157; 471-528; 625-655.

Image or illustration

American elder:

Images: images.google.com

Notes on Poisonous plant parts:

Animals were poisoned after ingesting young shoots and leaves. Children were also poisoned when they used the hollow stems as whistles. Uncooked berries may cause nausea (Muenscher 1975).

Toxic parts:

leaves
pollen
young shoots

References:

Muenscher, W. C. 1975. Poisonous plants of the United States. Revised. Collier Books, New York, N.Y., USA. 277 pp.

Notes on Toxic plant chemicals:

Cyanogenic glycosides are found in elders. Sambunigrin and other chemicals may be involved. Cathartics may also be present (Kingsbury 1964, Tewe and Iyayi 1989).

Toxic plant chemicals:

sambunigrin

References:

Kingsbury, J. M. 1964. Poisonous plants of the United States and Canada. Prentice-Hall Inc., Englewood Cliffs, N.J., USA. 626 pp.

Tewe, O. O., Iyayi, E. A. 1989. Cyanogenic glycosides. Pages 43-60 in Cheeke, P. R., ed. Toxicants of plant origin. Vol. II. Glycosides. CRC Press, Inc., Boca Raton, Fla., USA. 277 pp.

Animals/Human Poisoning:

Note: When an animal is listed without additional information, the literature (as of 1993) contained no detailed explanation.

Cattle

General symptoms of poisoning:

[abdominal pains](#)

References:

Muenscher, W. C. 1975. Poisonous plants of the United States. Revised. Collier Books, New York, N.Y., USA. 277 pp.

Humans

General symptoms of poisoning:

[nausea](#)

[vomiting](#)

Notes on poisoning:

Apparently, the use of the hollow stems as whistles or blowpipes has caused poisoning in children. The bark contains a cathartic. Ingesting uncooked berries can cause nausea and vomiting. Cooked are not harmful if eaten in small amounts (Kingsbury 1964).

References:

Kingsbury, J. M. 1964. Poisonous plants of the United States and Canada. Prentice-Hall Inc., Englewood Cliffs, N.J., USA. 626 pp.

Muenschler, W. C. 1975. Poisonous plants of the United States. Revised. Collier Books, New York, N.Y., USA. 277 pp.

[Another search?](#)

[Français](#) | [Contact Us](#) | [Help](#) | [Search](#) | [Canada site](#)

[Coming Events](#) | [About CBIF](#) | [Links](#) | [Reports and Publications](#) | [Home](#)

Date modified: 2003-02-06

[Important Notices](#)



Français	Contact us	Help	Search	Canada site
Coming events	About CBIF	Links	Reports and publications	Home

Canadian Biodiversity Information Facility



Notes on poisoning: American holly

[Introduction](#)

[Interactive](#)

[All poisonous plants by Botanical name](#)

[All poisonous plants by Common name](#)

[Important WWW Poisonous Plants sites](#)

General poisoning notes:

American holly (*Ilex opaca*) is an ornamental shrub that provides glossy green leaves and red berries used in Christmas decorations. Ingested berries have been implicated in cases of poisoning of children. The symptoms included vomiting and diarrhea (Rodrigues et al. 1984, Lampe and McCann 1985).



References:

Lampe, K. F., McCann, M. A. 1985. AMA Handbook of poisonous and injurious plants. American Medical Assoc. Chicago, Ill., USA. 432 pp.

Rodrigues, T. D., Johnson, P. N., Jeffrey, L. P. 1984. Hollyberry ingestion. Case report. Vet. Hum. Toxicol., 26: 157-158.

Nomenclature:

Scientific Name: *Ilex opaca* Ait.

Vernacular name(s): American holly

Scientific family name: *Aquifoliaceae*

Vernacular family name: holly

Go to ITIS^{*ca} for more taxonomic information on: [Ilex opaca](#)

References:

Agriculture Quebec. 1975. Noms des maladies des plantes du Canada/ Names of plant diseases in Canada. , Quebec City, Que., Canada. 288 pp.

Alex, J. F., Cayouette, R., Mulligan, G. A. 1980. Common and botanical names of weeds in Canada/Noms populaire et

scientifiques des plantes nuisibles du Canada. Revised. Agric. Can. Publ., Ottawa, Ont., Canada. 132 pp.

Bailey, L. H., Bailey, E. Z. 1976. Hortus third. Revised. MacMillan, New York, N.Y., USA. 1290 pp.

Scoggan, H. J. 1978, 1979. The flora of Canada. Nat. Mus. Nat. Sci. (Ottawa) Publ. Bot. 7(1)-7(4). 1711 pp.

Van Wijk, H. L. 1911. A dictionary of plant names. Martinus Nijhoff, The Hague, The Netherlands. 1444 pp.

Victorin, M. 1964. Flore Laurentienne. 2nd ed. Univ. Montreal, Montreal, Que., Canada. 952 pp.

Geographic Information

Plant or plant parts used in or around the home.

References:

Bailey, L. H., Bailey, E. Z. 1976. Hortus third. Revised. MacMillan, New York, N.Y., USA. 1290 pp.

Boivin, B. 1966, 1967. Énumération des plantes du Canada. Provencheria 6. Nat. Can. (Que.) 93: 253-274; 371-437; 583-646; 989-1063. 94: 131-157; 471-528; 625-655.

Image or illustration

American holly:

Images: images.google.com

Toxic parts:

mature fruit

References:

Rodrigues, T. D., Johnson, P. N., Jeffrey, L. P. 1984. Hollyberry ingestion. Case report. Vet. Hum. Toxicol., 26: 157-158.

Notes on Toxic plant chemicals:

Ilicin is a crude extract that is a bitter glycoside. This extract has been implicated as the poisonous substance (Rodrigues et al. 1984).

Toxic plant chemicals:

ilicin

References:

Rodrigues, T. D., Johnson, P. N., Jeffrey, L. P. 1984. Hollyberry ingestion. Case report. *Vet. Hum. Toxicol.*, 26: 157-158.

Animals/Human Poisoning:

Note: When an animal is listed without additional information, the literature (as of 1993) contained no detailed explanation.

Humans

General symptoms of poisoning:

[diarrhea](#)

[drowsiness](#)

[vomiting](#)

Notes on poisoning:

Ingestion of a "handful" of berries caused repeated vomiting, green, watery diarrhea, and passage of green semisoft stools. The drowsiness might have been associated with the ipecac-induced vomiting. Ingestion of berries usually results in mild symptoms unless a lot of berries are eaten. Children are more likely to eat the berries (Rodrigues et al. 1984).

References:

Rodrigues, T. D., Johnson, P. N., Jeffrey, L. P. 1984. Hollyberry ingestion. Case report. *Vet. Hum. Toxicol.*, 26: 157-158.

[Another search?](#)

[Français](#) | [Contact Us](#) | [Help](#) | [Search](#) | [Canada site](#)

[Coming Events](#) | [About CBIF](#) | [Links](#) | [Reports and Publications](#) |

[Home](#)

Date modified: 2003-02-06

[Important Notices](#)



Français	Contact us	Help	Search	Canada site
Coming events	About CBIF	Links	Reports and publications	Home

Canadian Biodiversity Information Facility



Notes on poisoning: American mistletoe

[Introduction](#)

[Interactive](#)

[All poisonous plants by Botanical name](#)

[All poisonous plants by Common name](#)

[Important WWW Poisonous Plants sites](#)



General poisoning notes:

American mistletoe (*Phoradendron flavescens*) is the familiar mistletoe of Christmas. Ingesting a large number of the berries or tea made from the berries has led to poisoning and death in humans. Mistletoe, used as decorations at Christmas, should be kept out of the reach of children and family pets (Kingsbury 1964, Fuller and McClintock 1986).

References:

- Fuller, T. C., McClintock, E. 1986. Poisonous plants of California. Univ. California Press, Berkeley, Calif., USA. 432 pp.
- Kingsbury, J. M. 1964. Poisonous plants of the United States and Canada. Prentice-Hall Inc., Englewood Cliffs, N.J., USA. 626 pp.

Nomenclature:

Scientific Name: *Phoradendron flavescens* (Pursh) Nutt.

Vernacular name(s): American mistletoe

Scientific family name: *Loranthaceae*

Vernacular family name: mistletoe

Go to ITIS^{*ca} for more taxonomic information on: [Phoradendron flavescens](#)

References:

Agriculture Quebec. 1975. Noms des maladies des plantes du Canada/ Names of plant diseases in Canada. , Quebec City, Que., Canada. 288 pp.

Alex, J. F., Cayouette, R., Mulligan, G. A. 1980. Common and

botanical names of weeds in Canada/Noms populaire et scientifiques des plantes nuisibles du Canada. Revised. Agric. Can. Publ., Ottawa, Ont., Canada. 132 pp.

Bailey, L. H., Bailey, E. Z. 1976. Hortus third. Revised. MacMillan, New York, N.Y., USA. 1290 pp.

Scoggan, H. J. 1978, 1979. The flora of Canada. Nat. Mus. Nat. Sci. (Ottawa) Publ. Bot. 7(1)-7(4). 1711 pp.

Van Wijk, H. L. 1911. A dictionary of plant names. Martinus Nijhoff, The Hague, The Netherlands. 1444 pp.

Victorin, M. 1964. Flore Laurentienne. 2nd ed. Univ. Montreal, Montreal, Que., Canada. 952 pp.

Geographic Information

Plant or plant parts used in or around the home.

References:

Bailey, L. H., Bailey, E. Z. 1976. Hortus third. Revised. MacMillan, New York, N.Y., USA. 1290 pp.

Boivin, B. 1966, 1967. Énumération des plantes du Canada. Provencheria 6. Nat. Can. (Que.) 93: 253-274; 371-437; 583-646; 989-1063. 94: 131-157; 471-528; 625-655.

Image or illustration

American mistletoe:

Images: images.google.com

Toxic parts:

all parts
leaves
mature fruit

References:

Fuller, T. C., McClintock, E. 1986. Poisonous plants of California. Univ. California Press, Berkeley, Calif., USA. 432 pp.

Notes on Toxic plant chemicals:

American mistletoe contains two amines, beta-phenylethylamine and tyramine, as well as a lectin, phoratoxin. These chemicals are probably responsible for toxic reactions after ingestion (Fuller

and McClintock 1986).

Toxic plant chemicals:

beta-phenylethylamine
phoratoxin
tryamine

References:

Fuller, T. C., McClintock, E. 1986. Poisonous plants of California. Univ. California Press, Berkeley, Calif., USA. 432 pp.

Animals/Human Poisoning:

Note: When an animal is listed without additional information, the literature (as of 1993) contained no detailed explanation.

Humans

General symptoms of poisoning:

[cardiac arrest](#)

[death](#)

[gastroenteritis](#)

Notes on poisoning:

Ingesting a few berries causes abdominal pain and diarrhea. Tea made from the berries caused death about 10 h after symptoms of acute gastroenteritis, followed by cardiovascular collapse. Plant material has slowed the heartbeat in a way similar to digitalis (Kingsbury 1964, Fuller and McClintock 1986).

References:

Fuller, T. C., McClintock, E. 1986. Poisonous plants of California. Univ. California Press, Berkeley, Calif., USA. 432 pp.

Kingsbury, J. M. 1964. Poisonous plants of the United States and Canada. Prentice-Hall Inc., Englewood Cliffs, N.J., USA. 626 pp.

[Another search?](#)

[Français](#) | [Contact Us](#) | [Help](#) | [Search](#) | [Canada site](#)

[Coming Events](#) | [About CBIF](#) | [Links](#) | [Reports and Publications](#) |

[Home](#)

Date modified: 2003-02-06

[Important Notices](#)



Français	Contact us	Help	Search	Canada site
Coming events	About CBIF	Links	Reports and publications	Home

Canadian Biodiversity Information Facility



Notes on poisoning: angel's trumpet

[Introduction](#)[Interactive](#)[All poisonous plants by Botanical name](#)[All poisonous plants by Common name](#)[Important WWW Poisonous Plants sites](#)

General poisoning notes:

Angel's trumpet (*Datura innoxia*) contains toxic alkaloids that have caused poisoning and death in humans and other animals. Most of the literature concerns poisoning by jimsonweed (*Datura stramonium*), but angel's trumpet should be considered poisonous as well. This plant is occasionally grown as an outdoor ornamental herb because of its spectacular tubular flowers. See additional information under general notes of [Datura stramonium](#).

References:

Cheeke, P. R., Shull, L. R. 1985. Natural toxicants in feeds and poisonous plants. AVI Publishing Company, Inc., Westport, Conn., USA. 492 pp.

Cooper, M. R., Johnson, A. W. 1984. Poisonous plants in Britain and their effects on animals and man. Her Majesty's Stationery Office, London, England. 305 pp.

Kingsbury, J. M. 1964. Poisonous plants of the United States and Canada. Prentice-Hall Inc., Englewood Cliffs, N.J., USA. 626 pp.

Lampe, K. F., McCann, M. A. 1985. AMA Handbook of poisonous and injurious plants. American Medical Assoc. Chicago, Ill., USA. 432 pp.

Nomenclature:

Scientific Name: *Datura innoxia* Mill.

Vernacular name(s): angel's trumpet

Scientific family name: *Solanaceae*

Vernacular family name: nightshade

Go to ITIS^{*ca} for more taxonomic information on: [Datura innoxia](#)

References:

Agriculture Quebec. 1975. Noms des maladies des plantes du Canada/ Names of plant diseases in Canada. , Quebec City, Que., Canada. 288 pp.

Alex, J. F., Cayouette, R., Mulligan, G. A. 1980. Common and botanical names of weeds in Canada/Noms populaire et scientifiques des plantes nuisibles du Canada. Revised. Agric. Can. Publ., Ottawa, Ont., Canada. 132 pp.

Bailey, L. H., Bailey, E. Z. 1976. Hortus third. Revised. MacMillan, New York, N.Y., USA. 1290 pp.

Scoggan, H. J. 1978, 1979. The flora of Canada. Nat. Mus. Nat. Sci. (Ottawa) Publ. Bot. 7(1)-7(4). 1711 pp.

Van Wijk, H. L. 1911. A dictionary of plant names. Martinus Nijhoff, The Hague, The Netherlands. 1444 pp.

Victorin, M. 1964. Flore Laurentienne. 2nd ed. Univ. Montreal, Montreal, Que., Canada. 952 pp.

Geographic Information

Plant or plant parts used in or around the home.

References:

Bailey, L. H., Bailey, E. Z. 1976. Hortus third. Revised. MacMillan, New York, N.Y., USA. 1290 pp.

Boivin, B. 1966, 1967. Énumération des plantes du Canada. Provencheria 6. Nat. Can. (Que.) 93: 253-274; 371-437; 583-646; 989-1063. 94: 131-157; 471-528; 625-655.

Image or illustration

angel's trumpet:

Images: images.google.com

Toxic parts:

all parts
leaves
seeds

References:

Cheeke, P. R., Shull, L. R. 1985. Natural toxicants in feeds and poisonous plants. AVI Publishing Company, Inc., Westport, Conn., USA. 492 pp.

Notes on Toxic plant chemicals:

This plant contains the tropane alkaloids atropine, hyoscyamine, and hyoscyamine. See additional information under general notes of [Datura stramonium](#).

Toxic plant chemicals:

hyoscyamine

References:

Cheeke, P. R., Shull, L. R. 1985. Natural toxicants in feeds and poisonous plants. AVI Publishing Company, Inc., Westport, Conn., USA. 492 pp.

Animals/Human Poisoning:

Note: When an animal is listed without additional information, the literature (as of 1993) contained no detailed explanation.

Cattle

General symptoms of poisoning:

[death](#)

[muscle twitching](#)

[nervousness](#)

Notes on poisoning:

All types of animals can be poisoned by angel's trumpet because it contains alkaloids. However, no definite cases of poisoning have been reported. The most likely animals to be poisoned are family pets that may have access to plants outside the house.

References:

Kingsbury, J. M. 1964. Poisonous plants of the United States and Canada. Prentice-Hall Inc., Englewood Cliffs, N.J., USA. 626 pp.

Humans

General symptoms of poisoning:

[agitation](#)

[choreiform movement](#)

[coma](#)

[drowsiness](#)

[hallucination](#)

[temperature, elevated](#)

References:

Cooper, M. R., Johnson, A. W. 1984. Poisonous plants in Britain and their effects on animals and man. Her Majesty's Stationery Office, London, England. 305 pp.

Lampe, K. F., McCann, M. A. 1985. AMA Handbook of poisonous and injurious plants. American Medical Assoc. Chicago, Ill., USA. 432 pp.

[Another search?](#)

[Français](#) | [Contact Us](#) | [Help](#) | [Search](#) | [Canada site](#)

[Coming Events](#) | [About CBIF](#) | [Links](#) | [Reports and Publications](#) |

[Home](#)

Date modified: 2003-02-06

[Important Notices](#)



Français	Contact us	Help	Search	Canada site
Coming events	About CBIF	Links	Reports and publications	Home

Canadian Biodiversity Information Facility



Notes on poisoning: Astragalus (A. adsurgens)

[Introduction](#)

[Interactive](#)

[All poisonous plants by Botanical name](#)

[All poisonous plants by Common name](#)

[Important WWW Poisonous Plants sites](#)

General poisoning notes:

Astragalus adsurgens is a native herb found across western Canada. This plant has the potential to accumulate toxic levels of selenium, which would cause symptoms in cattle and probably other livestock. Cases of livestock poisoned by this plant could not be found in the literature.



References:

Davis, A. M. 1986. Selenium uptake in *Astragalus* and *Lupinus* species. *Agron. J.*, 78: 727-729.

Nomenclature:

Scientific Name: *Astragalus adsurgens* Pall.

Vernacular name(s): Astragalus (A. adsurgens)

Scientific family name: *Leguminosae*

Vernacular family name: pea

Go to ITIS*^{ca} for more taxonomic information on: [Astragalus adsurgens](#)

References:

Agriculture Quebec. 1975. Noms des maladies des plantes du Canada/ Names of plant diseases in Canada. , Quebec City, Que., Canada. 288 pp.

Alex, J. F., Cayouette, R., Mulligan, G. A. 1980. Common and botanical names of weeds in Canada/Noms populaire et scientifiques des plantes nuisibles du Canada. Revised. Agric. Can. Publ., Ottawa, Ont., Canada. 132 pp.

Bailey, L. H., Bailey, E. Z. 1976. Hortus third. Revised. MacMillan, New York, N.Y., USA. 1290 pp.

Scoggan, H. J. 1978, 1979. The flora of Canada. Nat. Mus. Nat. Sci. (Ottawa) Publ. Bot. 7(1)-7(4). 1711 pp.

Van Wijk, H. L. 1911. A dictionary of plant names. Martinus Nijhoff, The Hague, The Netherlands. 1444 pp.

Victorin, M. 1964. Flore Laurentienne. 2nd ed. Univ. Montreal, Montreal, Que., Canada. 952 pp.

Geographic Information

Alberta
British Columbia
Manitoba
Northwest Territories
Ontario
Saskatchewan

References:

Bailey, L. H., Bailey, E. Z. 1976. Hortus third. Revised. MacMillan, New York, N.Y., USA. 1290 pp.

Boivin, B. 1966, 1967. Énumération des plantes du Canada. Provencheria 6. Nat. Can. (Que.) 93: 253-274; 371-437; 583-646; 989-1063. 94: 131-157; 471-528; 625-655.

Image or illustration

Astragalus (*A. adsurgens*):

Images: images.google.com

Toxic parts:

leaves
stems

References:

Davis, A. M. 1986. Selenium uptake in *Astragalus* and *Lupinus* species. Agron. J., 78: 727-729.

Notes on Toxic plant chemicals:

Astragalus adsurgens has been found to accumulate selenium well above the minimum amount of 5 mg/kg required for the

existence of selenium poisoning in sheep and cattle. Some plants collected in Canada contained 44 mg/kg of selenium (Davis 1986).

Toxic plant chemicals:

selenium

References:

Davis, A. M. 1986. Selenium uptake in *Astragalus* and *Lupinus* species. *Agron. J.*, 78: 727-729.

Animals/Human Poisoning:

Note: When an animal is listed without additional information, the literature (as of 1993) contained no detailed explanation.

Cattle

[Another search?](#)

[Français](#) | [Contact Us](#) | [Help](#) | [Search](#) | [Canada site](#)

[Coming Events](#) | [About CBIF](#) | [Links](#) | [Reports and Publications](#) |

[Home](#)

Date modified: 2003-02-06

[Important Notices](#)



Français	Contact us	Help	Search	Canada site
Coming events	About CBIF	Links	Reports and publications	Home

Canadian Biodiversity Information Facility



Notes on poisoning:

Astragalus (A. lentiginosus)

[Introduction](#)[Interactive](#)[All poisonous plants by Botanical name](#)[All poisonous plants by Common name](#)[Important WWW Poisonous Plants sites](#)

General poisoning notes:



Astragalus lentiginosus is a native plant found in south-central British Columbia. Ingesting the plant causes a variety of problems. Plants contain the alkaloid swainsonine, which can cause locoism. The common symptoms are impairment of the nervous system, depression, and excitement when disturbed. Teratogenic effects have also been noted in lambs and foals. At high altitudes (above 2120 m), cattle suffer from congestive heart failure (swainsonine influences the vascular system). This plant is a major poisonous range plant in the western United States. It is not abundant anywhere in Canada (Cheeke and Schull 1985, Panter et al. 1988).

References:

Cheeke, P. R., Shull, L. R. 1985. Natural toxicants in feeds and poisonous plants. AVI Publishing Company, Inc., Westport, Conn., USA. 492 pp.

James, L. F., Van Kampen, K. R. 1971. Effects of locoweed intoxication on the genital tract of the ram. *Am. J. Vet. Res.*, 32: 1253-1256.

LeGrande, C. E., James, L. F., McMullen, R. W., Panter, K. E. 1985. Reduced progesterone and altered cotyledonary prostaglandin values induced by locoweed (*Astragalus lentiginosus*) in sheep. *Am. J. Vet. Res.*, 46: 1903-1907.

Panter, K. E., Bunch, T. D., James, L. F., Sisson, D. V. 1987. Ultrasonographic imaging to monitor fetal and placental developments in ewes fed locoweed (*Astragalus lentiginosus*). *Am. J. Vet. Res.*, 48: 686-690.

Panter, K. E., James, L. F., Hartley, W. J. 1989. Transient

testicular degeneration in rams fed locoweed (*Astragalus lentiginosus*). *Vet. Hum. Toxicol.*, 31: 42-46.

Panter, K. E., James, L. F., Nielson, D., Molyneux, R. J., Ralphs, M. H. 1988. The relationship of *Oxytropis sericea* (green and dry) and *Astragalus lentiginosus* with high mountain disease in cattle. *Vet. Hum. Toxicol.*, 30: 318-323.

Ralphs, M. H., Panter, K. E., James, L. F. 1990. Feed preferences and habituation of sheep poisoned by locoweed. *J. Anim. Sci.*, 68: 1354-1362.

Tulsiani, D. R., Broquist, H. P., James, L. F., Touster, O. 1984. The similar effects of swainsonine and locoweed on tissue glycosidases and oligosaccharides of the pig indicate that the alkaloid is the principal toxin for induction of locoism. *Arch. Biochem. Biophys.*, 232: 76-85.

Van Kampen, K. R., James, L. F. 1972. Sequential development of the lesions in locoweed poisoning. *Clin. Toxicol.*, 5: 575-580.

Nomenclature:

Scientific Name: *Astragalus lentiginosus* Dougl.

Vernacular name(s): Astragalus (A. lentiginosus)

Scientific family name: *Leguminosae*

Vernacular family name: pea

Go to ITIS^{*ca} for more taxonomic information on: [Astragalus lentiginosus](#)

References:

Agriculture Quebec. 1975. Noms des maladies des plantes du Canada/ Names of plant diseases in Canada. , Quebec City, Que., Canada. 288 pp.

Alex, J. F., Cayouette, R., Mulligan, G. A. 1980. Common and botanical names of weeds in Canada/Noms populaire et scientifiques des plantes nuisibles du Canada. Revised. Agric. Can. Publ., Ottawa, Ont., Canada. 132 pp.

Bailey, L. H., Bailey, E. Z. 1976. Hortus third. Revised. MacMillan, New York, N.Y., USA. 1290 pp.

Scoggan, H. J. 1978, 1979. The flora of Canada. Nat. Mus. Nat. Sci. (Ottawa) Publ. Bot. 7(1)-7(4). 1711 pp.

Van Wijk, H. L. 1911. A dictionary of plant names. Martinus Nijhoff, The Hague, The Netherlands. 1444 pp.

Victorin, M. 1964. Flore Laurentienne. 2nd ed. Univ. Montreal, Montreal, Que., Canada. 952 pp.

Geographic Information

British Columbia

References:

Bailey, L. H., Bailey, E. Z. 1976. Hortus third. Revised. MacMillan, New York, N.Y., USA. 1290 pp.

Boivin, B. 1966, 1967. Énumération des plantes du Canada. Provencheria 6. Nat. Can. (Que.) 93: 253-274; 371-437; 583-646; 989-1063. 94: 131-157; 471-528; 625-655.

Image or illustration

Astragalus (A. lentiginosus):

Images: images.google.com

Toxic parts:

flowers

leaves

seeds

stems

References:

James, L. F., Van Kampen, K. R. 1971. Effects of locoweed intoxication on the genital tract of the ram. Am. J. Vet. Res., 32: 1253-1256.

LeGrande, C. E., James, L. F., McMullen, R. W., Panter, K. E. 1985. Reduced progesterone and altered cotyledonary prostaglandin values induced by locoweed (*Astragalus lentiginosus*) in sheep. Am. J. Vet. Res., 46: 1903-1907.

Panter, K. E., James, L. F., Hartley, W. J. 1989. Transient testicular degeneration in rams fed locoweed (*Astragalus lentiginosus*). Vet. Hum. Toxicol., 31: 42-46.

Panter, K. E., James, L. F., Nielson, D., Molyneux, R. J., Ralphs, M. H. 1988. The relationship of *Oxytropis sericea* (green and dry) and *Astragalus lentiginosus* with high mountain disease in cattle. Vet. Hum. Toxicol., 30: 318-323.

Tulsiani, D. R., Broquist, H. P., James, L. F., Touster, O. 1984. The similar effects of swainsonine and locoweed on tissue

glycosidases and oligosaccharides of the pig indicate that the alkaloid is the principal toxin for induction of locoism. Arch. Biochem. Biophys., 232: 76-85.

Van Kampen, K. R., James, L. F. 1972. Sequential development of the lesions in locoweed poisoning. Clin. Toxicol., 5: 575-580.

Notes on Toxic plant chemicals:

Swainsonine, the chemical involved in locoism, is found in several plants occurring in Canada, including *Astragalus bisulcatus*, *A. lentiginosus*, *Oxytropis lambertii*, and *O. sericea*. This indolizidine alkaloid causes locoism in cattle, horses, and sheep; it also causes teratogenic deformities in lambs, calves, and foals. In addition, at high altitudes (above 2120 m) it contributes to congenital heart failure in calves and cows (Cheeke and Schull 1985).

Toxic plant chemicals:

slaframine
swainsonine

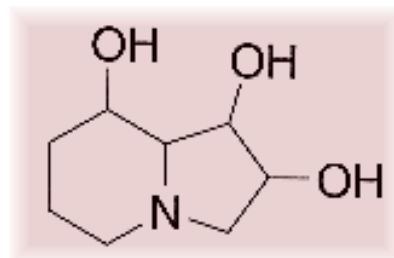

Chemical diagram(s) are courtesy of [Ruth McDiarmid](#), Biochemistry Technician, Kamloops Range Station, Agriculture and Agri-Food Canada, Kamloops, British Columbia, Canada.

References:

Cheeke, P. R., Shull, L. R. 1985. Natural toxicants in feeds and poisonous plants. AVI Publishing Company, Inc., Westport, Conn., USA. 492 pp.

Molyneux, R. J., James, L. F. 1982. Loco intoxication: indolizidine alkaloids of spotted locoweed (*Astragalus lentiginosus*). Science (Wash. D. C.), 216: 190-191.

Tulsiani, D. R., Broquist, H. P., James, L. F., Touster, O. 1984. The similar effects of swainsonine and locoweed on tissue glycosidases and oligosaccharides of the pig indicate that the alkaloid is the principal toxin for induction of locoism. Arch. Biochem. Biophys., 232: 76-85.

Animals/Human Poisoning:

Note: When an animal is listed without additional information, the literature (as of 1993) contained no detailed explanation.

Cattle

General symptoms of poisoning:

[abdominal edema](#)
[appetite, loss of](#)
[duodenum, edema of](#)
[gall bladder, enlarged](#)
[jaw \(lower\), edema of](#)
[thorax \(ventral\), edema](#)
[throat, edema of](#)
[ventricular\(right\), edema](#)

References:

Panter, K. E., James, L. F., Nielson, D., Molyneux, R. J., Ralphs, M. H. 1988. The relationship of *Oxytropis sericea* (green and dry) and *Astragalus lentiginosus* with high mountain disease in cattle. *Vet. Hum. Toxicol.*, 30: 318-323.

Horses

Sheep

General symptoms of poisoning:

[abortion](#)
[blisters, weeping](#)
[brain, vacuolation of](#)
[cytoplasm vacuolation](#)
[death](#)
[depression](#)
[eyes, dull](#)
[fetus, dead](#)
[gait, unsteady](#)
[heart rate, elevated](#)
[incoordination](#)
[kidney, congestion of](#)
[kidney, vacuolation of](#)
[lethargy](#)
[liver, congestion of](#)
[muscle, weakness of](#)

[sperm, detached tails](#)
[sperm mobility, poor](#)
[testicle degeneration](#)
[ventricle\(right\),edema](#)
[ventricle\(right\),round](#)
[weakness](#)

Notes on poisoning:

Astragalus lentiginosus caused fetal abortion in sheep and clinical signs of locoism in pregnant ewes. It also caused fluid accumulation in the placenta, altered cotyledonary development, and decreased fetal heart rates causing cardiac irregularity. At necropsy the fetuses had hypertrophy of the heart, right ventricular dilation, rounded apex of the heart, and generalized edema (Panter et al. 1987).

References:

- James, L. F., Van Kampen, K. R. 1971. Effects of locoweed intoxication on the genital tract of the ram. *Am. J. Vet. Res.*, 32: 1253-1256.
- LeGrande, C. E., James, L. F., McMullen, R. W., Panter, K. E. 1985. Reduced progesterone and altered cotyledonary prostaglandin values induced by locoweed (*Astragalus lentiginosus*) in sheep. *Am. J. Vet. Res.*, 46: 1903-1907.
- Panter, K. E., Bunch, T. D., James, L. F., Sisson, D. V. 1987. Ultrasonographic imaging to monitor fetal and placental developments in ewes fed locoweed (*Astragalus lentiginosus*). *Am. J. Vet. Res.*, 48: 686-690.
- Panter, K. E., James, L. F., Hartley, W. J. 1989. Transient testicular degeneration in rams fed locoweed (*Astragalus lentiginosus*). *Vet. Hum. Toxicol.*, 31: 42-46.
- Ralphs, M. H., Panter, K. E., James, L. F. 1990. Feed preferences and habituation of sheep poisoned by locoweed. *J. Anim. Sci.*, 68: 1354-1362.
- Van Kampen, K. R., James, L. F. 1972. Sequential development of the lesions in locoweed poisoning. *Clin. Toxicol.*, 5: 575-580.

Swine

General symptoms of poisoning:

[brain, vacuolation of](#)
[coat, rough and dry](#)
[cytoplasm vacuolation](#)
[depression](#)

[eyes, dull](#)

[incoordination](#)

[kidney, vacuolation of](#)

References:

Tulsiani, D. R., Broquist, H. P., James, L. F., Touster, O. 1984. The similar effects of swainsonine and locoweed on tissue glycosidases and oligosaccharides of the pig indicate that the alkaloid is the principal toxin for induction of locoism. Arch. Biochem. Biophys., 232: 76-85.

[Another search?](#)

[Français](#) | [Contact Us](#) | [Help](#) | [Search](#) | [Canada site](#)

[Coming Events](#) | [About CBIF](#) | [Links](#) | [Reports and Publications](#) | [Home](#)

Date modified: 2003-02-06

[Important Notices](#)



Français	Contact us	Help	Search	Canada site
Coming events	About CBIF	Links	Reports and publications	Home

Canadian Biodiversity Information Facility



Notes on poisoning: Australian umbrella tree

[Introduction](#)[Interactive](#)[All poisonous plants by Botanical name](#)[All poisonous plants by Common name](#)[Important WWW Poisonous Plants sites](#)

General poisoning notes:

Australian umbrella tree (*Brassaia actinophylla*) is an ornamental shrub grown indoors in Canada. This plant caused toxic symptoms in a dog after it ingested the leaves. Experimental work on rats caused death after they ingested 3.2 g of leaf tissue over 7 days. Symptoms in the rats included extramedullary hematopoiesis in the spleen, with black tarry gastrointestinal content caused by blood (Quam et al. 1985).

References:

Mitchell, J. C. 1981. Allergic contact dermatitis from *Hedera helix* and *Brassaia actinophylla* (Araliaceae). *Contact Dermatitis*, 7: 158-159.

Quam, V. C., Schermeister, L. J., Tanner, N. S. 1985. Investigation for toxicity of a household plant - Australian umbrella tree (*Brassaia actinophylla* Endl.). *N. D. Farm Res.*, 43: 15-17.

Spoerke, D. G., Smolinske, S. C. 1990. *Toxicity of houseplants*. CRC Press, Inc., Boca Raton, Fla., USA. 335 pp.

Nomenclature:

Scientific Name: *Brassaia actinophylla* Endl.

Vernacular name(s): Australian umbrella tree

Scientific family name: *Araliaceae*

Vernacular family name: aralia

Go to ITIS*^{ca} for more taxonomic information on: [Brassaia actinophylla](#)

References:

Agriculture Quebec. 1975. Noms des maladies des plantes du Canada/ Names of plant diseases in Canada. , Quebec City, Que., Canada. 288 pp.

Alex, J. F., Cayouette, R., Mulligan, G. A. 1980. Common and botanical names of weeds in Canada/Noms populaire et scientifiques des plantes nuisibles du Canada. Revised. Agric. Can. Publ., Ottawa, Ont., Canada. 132 pp.

Bailey, L. H., Bailey, E. Z. 1976. Hortus third. Revised. MacMillan, New York, N.Y., USA. 1290 pp.

Scoggan, H. J. 1978, 1979. The flora of Canada. Nat. Mus. Nat. Sci. (Ottawa) Publ. Bot. 7(1)-7(4). 1711 pp.

Van Wijk, H. L. 1911. A dictionary of plant names. Martinus Nijhoff, The Hague, The Netherlands. 1444 pp.

Victorin, M. 1964. Flore Laurentienne. 2nd ed. Univ. Montreal, Montreal, Que., Canada. 952 pp.

Geographic Information

Plant or plant parts used in or around the home.

References:

Bailey, L. H., Bailey, E. Z. 1976. Hortus third. Revised. MacMillan, New York, N.Y., USA. 1290 pp.

Boivin, B. 1966, 1967. Énumération des plantes du Canada. Provencheria 6. Nat. Can. (Que.) 93: 253-274; 371-437; 583-646; 989-1063. 94: 131-157; 471-528; 625-655.

Image or illustration

Australian umbrella tree:

Images: images.google.com

Toxic parts:

leaves

References:

Quam, V. C., Schermeister, L. J., Tanner, N. S. 1985. Investigation for toxicity of a household plant - Australian umbrella tree (*Brassaia actinophylla* Endl.). N. D. Farm Res., 43: 15-17.

Notes on Toxic plant chemicals:

Chemical analysis (Quam et al. 1985) revealed that leaves contain oxalates and saponins as well as some cardiac glycosides and alkaloids.

Toxic plant chemicals:

oxalate

References:

Quam, V. C., Schermeister, L. J., Tanner, N. S. 1985. Investigation for toxicity of a household plant - Australian umbrella tree (*Brassaia actinophylla* Endl.). N. D. Farm Res., 43: 15-17.

Animals/Human Poisoning:

Note: When an animal is listed without additional information, the literature (as of 1993) contained no detailed explanation.

Dogs

General symptoms of poisoning:

[anorexia](#)

[ataxia](#)

[vomiting](#)

Notes on poisoning:

A poodle that ingested Australian umbrella tree leaves suffered from vomiting, leucopenia, anorexia, and ataxia. The leaves were found to contain 0.9%-1.5% oxalate crystals by weight (Spoerke and Smolinske 1990).

References:

Spoerke, D. G., Smolinske, S. C. 1990. Toxicity of houseplants. CRC Press, Inc., Boca Raton, Fla., USA. 335 pp.

Humans

General symptoms of poisoning:

[erythema](#)

References:

Mitchell, J. C. 1981. Allergic contact dermatitis from *Hedera helix* and *Brassaia actinophylla* (Araliaceae). *Contact Dermatitis*, 7: 158-159.

Rodents

General symptoms of poisoning:

[death](#)

[hemorrhage](#)

References:

Quam, V. C., Schermeister, L. J., Tanner, N. S. 1985. Investigation for toxicity of a household plant - Australian umbrella tree (*Brassaia actinophylla* Endl.). *N. D. Farm Res.*, 43: 15-17.

[Another search?](#)

[Français](#) | [Contact Us](#) | [Help](#) | [Search](#) | [Canada site](#)

[Coming Events](#) | [About CBIF](#) | [Links](#) | [Reports and Publications](#) |

[Home](#)

Date modified: 2003-02-06

[Important Notices](#)



Français	Contact us	Help	Search	Canada site
Coming events	About CBIF	Links	Reports and publications	Home

Canadian Biodiversity Information Facility



Notes on poisoning: autumn crocus

[Introduction](#)[Interactive](#)[All poisonous plants by Botanical name](#)[All poisonous plants by Common name](#)[Important WWW Poisonous Plants sites](#)

General poisoning notes:

Autumn crocus (*Colchium autumnale*) is an outdoor ornamental grown for its autumn flowers. The plant is poisonous to all animals and to humans. Livestock have been poisoned in Europe and Asia, where the plants are native. Poisoning has been reported in cattle, goats horses, sheep, and swine, as well as in humans and dogs. The toxic chemical colchicine can be excreted through the milk of lactating animals, thereby poisoning young animals and humans. Cattle and, to a lesser extent, goats and sheep can develop complete resistance to colchicine (Cooper and Johnson 1984). This plant is found only in garden cultivation or maybe as a houseplant in Canada. Children and family pets are therefore most at risk from ingesting autumn crocus.

References:

Cooper, M. R., Johnson, A. W. 1984. Poisonous plants in Britain and their effects on animals and man. Her Majesty's Stationery Office, London, England. 305 pp.

Hill, S. R., Duke, P. K. 1986. 100 poisonous plants of Maryland. Univ. MD. Coop. Ext. Serv. Bull., 314. 55 pp.

Lampe, K. F., McCann, M. A. 1985. AMA Handbook of poisonous and injurious plants. American Medical Assoc. Chicago, Ill., USA. 432 pp.

Spoerke, D. G., Smolinske, S. C. 1990. Toxicity of houseplants. CRC Press, Inc., Boca Raton, Fla., USA. 335 pp.

Nomenclature:

Scientific Name: *Colchicum autumnale* L.

Vernacular name(s): autumn crocus

Scientific family name: *Liliaceae*

Vernacular family name: lily

Go to ITIS^{*ca} for more taxonomic information on: [Colchicum autumnale](#)

References:

Agriculture Quebec. 1975. Noms des maladies des plantes du Canada/ Names of plant diseases in Canada. , Quebec City, Que., Canada. 288 pp.

Alex, J. F., Cayouette, R., Mulligan, G. A. 1980. Common and botanical names of weeds in Canada/Noms populaire et scientifiques des plantes nuisibles du Canada. Revised. Agric. Can. Publ., Ottawa, Ont., Canada. 132 pp.

Bailey, L. H., Bailey, E. Z. 1976. Hortus third. Revised. MacMillan, New York, N.Y., USA. 1290 pp.

Scoggan, H. J. 1978, 1979. The flora of Canada. Nat. Mus. Nat. Sci. (Ottawa) Publ. Bot. 7(1)-7(4). 1711 pp.

Van Wijk, H. L. 1911. A dictionary of plant names. Martinus Nijhoff, The Hague, The Netherlands. 1444 pp.

Victorin, M. 1964. Flore Laurentienne. 2nd ed. Univ. Montreal, Montreal, Que., Canada. 952 pp.

Geographic Information

Plant or plant parts used in or around the home.

References:

Bailey, L. H., Bailey, E. Z. 1976. Hortus third. Revised. MacMillan, New York, N.Y., USA. 1290 pp.

Boivin, B. 1966, 1967. Énumération des plantes du Canada. Provencheria 6. Nat. Can. (Que.) 93: 253-274; 371-437; 583-646; 989-1063. 94: 131-157; 471-528; 625-655.

Image or illustration

autumn crocus:

Images: images.google.com

Toxic parts:

all parts

References:

Lampe, K. F., McCann, M. A. 1985. AMA Handbook of poisonous and injurious plants. American Medical Assoc. Chicago, Ill., USA. 432 pp.

Notes on Toxic plant chemicals:

Colchicine is more toxic than colchiceine. These chemicals withstand drying, storage, and boiling without losing their toxic qualities. Colchicine affects the central nervous system, paralyzing nerve endings and blocking neuromuscular connections.

All parts of the plant are poisonous:

- 0.03-0.06% colchicine in the corm (bulb)
- 0.02-0.04% colchicine in the seeds

Ingesting fresh leaves in the following quantities results in death (Cooper and Johnson 1984):

8-16 g/kg of body weight	cattle
6.4 g/kg body weight	lambs (2-3 months old)
12 g/kg body weight	guinea pigs (adult)

Toxic plant chemicals:

colchiceine
colchicine

References:

Cooper, M. R., Johnson, A. W. 1984. Poisonous plants in Britain and their effects on animals and man. Her Majesty's Stationery Office, London, England. 305 pp.

Animals/Human Poisoning:

Note: When an animal is listed without additional information, the literature (as of 1993) contained no detailed explanation.

Cattle

General symptoms of poisoning:

[abdominal pains](#)

[collapse](#)

[death by asphyxiation](#)

[depression](#)

[diarrhea](#)

[incoordination](#)

[teeth grinding](#)

References:

Cooper, M. R., Johnson, A. W. 1984. Poisonous plants in Britain and their effects on animals and man. Her Majesty's Stationery Office, London, England. 305 pp.

Dogs

Goats

Horses

General symptoms of poisoning:

[collapse](#)

References:

Cooper, M. R., Johnson, A. W. 1984. Poisonous plants in Britain and their effects on animals and man. Her Majesty's Stationery Office, London, England. 305 pp.

Humans

General symptoms of poisoning:

[abdominal pains](#)

[colic](#)

[collapse](#)

[diarrhea](#)

[hemoglobinuria](#)

[mouth, irritation of](#)

[nausea](#)

[thirsty](#)

[vomiting](#)

Notes on poisoning:

Humans and other animals exhibit similar symptoms of colchicine poisoning. Symptoms develop 2-7 h after ingestion. Recovery is slow and relapse may occur, resulting in paralysis, respiratory or heart failure, and death. Temporary hair loss may occur (Cooper and Johnson 1984, Hill and Duke 1986).

References:

Cooper, M. R., Johnson, A. W. 1984. Poisonous plants in Britain and their effects on animals and man. Her Majesty's Stationery Office, London, England. 305 pp.

Hill, S. R., Duke, P. K. 1986. 100 poisonous plants of Maryland. Univ. MD. Coop. Ext. Serv. Bull., 314. 55 pp.

Lampe, K. F., McCann, M. A. 1985. AMA Handbook of poisonous and injurious plants. American Medical Assoc. Chicago, Ill., USA. 432 pp.

Sheep

General symptoms of poisoning:

[collapse](#)

[depression](#)

[diarrhea](#)

[salivation](#)

References:

Cooper, M. R., Johnson, A. W. 1984. Poisonous plants in Britain and their effects on animals and man. Her Majesty's Stationery Office, London, England. 305 pp.

Swine

[Another search?](#)

[Français](#) | [Contact Us](#) | [Help](#) | [Search](#) | [Canada site](#)

[Coming Events](#) | [About CBIF](#) | [Links](#) | [Reports and Publications](#) |

[Home](#)

Date modified: 2003-02-06

[Important Notices](#)



Français	Contact us	Help	Search	Canada site
Coming events	About CBIF	Links	Reports and publications	Home

Canadian Biodiversity Information Facility



Notes on poisoning: avocado

[Introduction](#)

[Interactive](#)

[All poisonous plants by Botanical name](#)

[All poisonous plants by Common name](#)

[Important WWW Poisonous Plants sites](#)



General poisoning notes:

Avocado (*Persea americana*) is a common exotic fruit. The seeds are often planted to produce foliage plants in households. In California, Guatemalan cultivars have caused toxic affects in cattle, goats, rabbits, canaries, and fish. Family pets should be prevented from ingesting the leaves. The seeds have caused toxicity and death in canaries and have experimentally poisoned mice. Leaves should not be allowed to fall accidentally into fish tanks (Hurt 1943, Fuller and McClintock 1986).

References:

Appleman, D. 1944. Preliminary report on toxicity of avocado leaves. Calif. Avocado Soc. Yearbook, 1944: 37.

Fuller, T. C., McClintock, E. 1986. Poisonous plants of California. Univ. California Press, Berkeley, Calif., USA. 432 pp.

Hurt, L. M. 1943. Avocado poisoning. LA. County Livestock Dep. Ann. Rep., 1943: 43-44.

Nomenclature:

Scientific Name: *Persea americana* Mill.

Vernacular name(s): avocado

Scientific family name: *Lauraceae*

Vernacular family name: laurel

Go to ITIS*^{ca} for more taxonomic information on: [Persea americana](#)

References:

Agriculture Quebec. 1975. Noms des maladies des plantes du Canada/ Names of plant diseases in Canada. , Quebec City, Que., Canada. 288 pp.

Alex, J. F., Cayouette, R., Mulligan, G. A. 1980. Common and botanical names of weeds in Canada/Noms populaire et scientifiques des plantes nuisibles du Canada. Revised. Agric. Can. Publ., Ottawa, Ont., Canada. 132 pp.

Bailey, L. H., Bailey, E. Z. 1976. Hortus third. Revised. MacMillan, New York, N.Y., USA. 1290 pp.

Scoggan, H. J. 1978, 1979. The flora of Canada. Nat. Mus. Nat. Sci. (Ottawa) Publ. Bot. 7(1)-7(4). 1711 pp.

Van Wijk, H. L. 1911. A dictionary of plant names. Martinus Nijhoff, The Hague, The Netherlands. 1444 pp.

Victorin, M. 1964. Flore Laurentienne. 2nd ed. Univ. Montreal, Montreal, Que., Canada. 952 pp.

Geographic Information

Plant or plant parts used in or around the home.

References:

Bailey, L. H., Bailey, E. Z. 1976. Hortus third. Revised. MacMillan, New York, N.Y., USA. 1290 pp.

Boivin, B. 1966, 1967. Énumération des plantes du Canada. Provencheria 6. Nat. Can. (Que.) 93: 253-274; 371-437; 583-646; 989-1063. 94: 131-157; 471-528; 625-655.

Image or illustration

avocado:

Images: images.google.com

Notes on Poisonous plant parts:

Ingesting the leaves, branches, or seeds has caused lung congestion and udder inflammation (Fuller and McClintock 1986).

Toxic parts:

leaves

seeds

twigs

References:

Fuller, T. C., McClintock, E. 1986. Poisonous plants of California. Univ. California Press, Berkeley, Calif., USA. 432 pp.

Toxic plant chemicals:

unknown chemical

References:

Fuller, T. C., McClintock, E. 1986. Poisonous plants of California. Univ. California Press, Berkeley, Calif., USA. 432 pp.

Animals/Human Poisoning:

Note: When an animal is listed without additional information, the literature (as of 1993) contained no detailed explanation.

Cattle

General symptoms of poisoning:

[mastitis](#)

Notes on poisoning:

Ingesting avocado leaves and bark has caused lung congestion, mastitis, tissue edema, milk reduction, and death (when large quantities of leaves were consumed). Other mammal species that were poisoned after ingesting avocado showed similar symptoms (Hurt 1943).

References:

Fuller, T. C., McClintock, E. 1986. Poisonous plants of California. Univ. California Press, Berkeley, Calif., USA. 432 pp.

Hurt, L. M. 1943. Avocado poisoning. LA. County Livestock Dep. Ann. Rep., 1943: 43-44.

Goats

General symptoms of poisoning:

[mastitis](#)

References:

Hurt, L. M. 1943. Avocado poisoning. LA. County Livestock Dep. Ann. Rep., 1943: 43-44.

Rabbits

General symptoms of poisoning:

[death](#)

[death by asphyxiation](#)

[mastitis](#)

Notes on poisoning:

Rabbits were poisoned when given access to avocado leaves. The rabbits developed mastitis and dried up. Experimental feeding of "Fuerte," a Guatemalan avocado cultivar, has caused poisoning and death in rabbits. Mexican cultivars have not caused poisoning (Hurt 1943, Appleman 1944).

References:

Appleman, D. 1944. Preliminary report on toxicity of avocado leaves. Calif. Avocado Soc. Yearbook, 1944: 37.

Hurt, L. M. 1943. Avocado poisoning. LA. County Livestock Dep. Ann. Rep., 1943: 43-44.

[Another search?](#)

[Français](#) | [Contact Us](#) | [Help](#) | [Search](#) | [Canada site](#)

[Coming Events](#) | [About CBIF](#) | [Links](#) | [Reports and Publications](#) |

[Home](#)

Date modified: 2003-02-06

[Important Notices](#)



Français	Contact us	Help	Search	Canada site
Coming events	About CBIF	Links	Reports and publications	Home

Canadian Biodiversity Information Facility



Notes on poisoning: bird rape

[Introduction](#)

[Interactive](#)

[All poisonous plants by Botanical name](#)

[All poisonous plants by Common name](#)

[Important WWW Poisonous Plants sites](#)



General poisoning notes:

Bird rape (*Brassica campestris*) includes the vegetables turnip and chinese cabbage. These plants can accumulate toxic quantities of SMC0, which poisoned several types of livestock after they ingested sufficient quantities (Benevenga et al. 1985). Please see the expanded notes on poisoning by this chemical under kale (*Brassica oleracea*) and the effects on various livestock animals.

References:

Benevenga, N. J., Case, G. L., Steele, R. D. 1989. Occurrence and metabolism of s-methyl-l-cysteine and s-methyl-l-cysteine sulfoxide in plants and their toxicity and metabolism in animals. Pages 203-228 in Cheeke, P. R., ed. Toxicants of plant origin. Vol. III. Proteins and amino acids. CRC Press, Inc., Boca Raton, Fla., USA. 271 pp.

Nomenclature:

Scientific Name: *Brassica campestris* L.

Vernacular name(s): bird rape

Scientific family name: *Cruciferae*

Vernacular family name: mustard

Go to ITIS*^{ca} for more taxonomic information on: [Brassica campestris](#)

References:

Agriculture Quebec. 1975. Noms des maladies des plantes du Canada/ Names of plant diseases in Canada. , Quebec City, Que.,

Canada. 288 pp.

Alex, J. F., Cayouette, R., Mulligan, G. A. 1980. Common and botanical names of weeds in Canada/Noms populaire et scientifiques des plantes nuisibles du Canada. Revised. Agric. Can. Publ., Ottawa, Ont., Canada. 132 pp.

Bailey, L. H., Bailey, E. Z. 1976. Hortus third. Revised. MacMillan, New York, N.Y., USA. 1290 pp.

Scoggan, H. J. 1978, 1979. The flora of Canada. Nat. Mus. Nat. Sci. (Ottawa) Publ. Bot. 7(1)-7(4). 1711 pp.

Van Wijk, H. L. 1911. A dictionary of plant names. Martinus Nijhoff, The Hague, The Netherlands. 1444 pp.

Victorin, M. 1964. Flore Laurentienne. 2nd ed. Univ. Montreal, Montreal, Que., Canada. 952 pp.

Geographic Information

Alberta
British Columbia
Labrador
Manitoba
New Brunswick
Newfoundland
Northwest Territories
Nova Scotia
Ontario
Prince Edward Island
Quebec
Saskatchewan
Yukon Territory

References:

Bailey, L. H., Bailey, E. Z. 1976. Hortus third. Revised. MacMillan, New York, N.Y., USA. 1290 pp.

Boivin, B. 1966, 1967. Énumération des plantes du Canada. Provencheria 6. Nat. Can. (Que.) 93: 253-274; 371-437; 583-646; 989-1063. 94: 131-157; 471-528; 625-655.

Image or illustration

bird rape:

Images: images.google.com

Notes on Poisonous plant parts:

The quantities of SMCO vary amongst the plant parts and in relation to the maturity of the plant (Benevenga et al. 1989).

Toxic parts:

flowers
leaves
stems

References:

Benevenga, N. J., Case, G. L., Steele, R. D. 1989. Occurrence and metabolism of s-methyl-l-cysteine and s-methyl-l-cysteine sulfoxide in plants and their toxicity and metabolism in animals. Pages 203-228 in Cheeke, P. R., ed. Toxicants of plant origin. Vol. III. Proteins and amino acids. CRC Press, Inc., Boca Raton, Fla., USA. 271 pp.

Notes on Toxic plant chemicals:

This species can produce toxic quantities of SMCO (S-methyl-L-cysteine sulfoxide) (Benevenga et al. 1989).

Toxic plant chemicals:

S-methyl-L-cysteine sulfoxide (SMCO)

References:

Benevenga, N. J., Case, G. L., Steele, R. D. 1989. Occurrence and metabolism of s-methyl-l-cysteine and s-methyl-l-cysteine sulfoxide in plants and their toxicity and metabolism in animals. Pages 203-228 in Cheeke, P. R., ed. Toxicants of plant origin. Vol. III. Proteins and amino acids. CRC Press, Inc., Boca Raton, Fla., USA. 271 pp.

Animals/Human Poisoning:

Note: When an animal is listed without additional information, the literature (as of 1993) contained no detailed explanation.

Cattle

[Another search?](#)

[Français](#) | [Contact Us](#) | [Help](#) | [Search](#) | [Canada site](#)
[Coming Events](#) | [About CBIF](#) | [Links](#) | [Reports and Publications](#) |
[Home](#)

Date modified: 2003-02-06

[Important Notices](#)



Français	Contact us	Help	Search	Canada site
Coming events	About CBIF	Links	Reports and publications	Home

Canadian Biodiversity Information Facility



Notes on poisoning: black cherry

[Introduction](#)[Interactive](#)[All poisonous plants by Botanical name](#)[All poisonous plants by Common name](#)[Important WWW Poisonous Plants sites](#)

General poisoning notes:

Black cherry (*Prunus serotina*) is a native tree found in eastern Canada. It is occasionally cultivated as an ornamental. The plant contains chemicals that can release hydrogen cyanide in animals. All types of animals can be poisoned by ingesting leaves and twigs. There have been claims of children dying after ingesting an excessive number of seeds, found in the berries. Cyanide poisoning interferes with respiration and blood circulation; death is often swift (Kingsbury 1964, Cheeke 1983, Cheeke and Schull 1985).



References:

- Cheeke, P. R., Shull, L. R. 1985. Natural toxicants in feeds and poisonous plants. AVI Publishing Company, Inc., Westport, Conn., USA. 492 pp.
- Hardin, J. W., Arena, J. M. 1969. Human poisoning from native and cultivated plants. Duke University Press, Durham, N.C., USA. 167 pp.
- Keeler, R. F. 1983. Naturally occurring teratogens from plants. Pages 161-199 in Keeler, R. F., Tu, A. T., eds. Handbook of natural toxins. Vol. 1. Plant and Fungal toxins. Marcel Dekker, Inc., New York, N.Y., USA. 934 pp.
- Kingsbury, J. M. 1964. Poisonous plants of the United States and Canada. Prentice-Hall Inc., Englewood Cliffs, N.J., USA. 626 pp.
- Lampe, K. F., McCann, M. A. 1985. AMA Handbook of poisonous and injurious plants. American Medical Assoc. Chicago, Ill., USA. 432 pp.
- Mulligan, G. A., Munro, D. B. 1981. The biology of Canadian weeds. 51. *Prunus virginiana* L. and *P. serotina* Ehrh. Can. J. Plant Sci., 61: 977-992.

Nomenclature:

Scientific Name: *Prunus serotina* Ehrh.

Vernacular name(s): black cherry

Scientific family name: *Rosaceae*

Vernacular family name: rose

Go to ITIS^{*ca} for more taxonomic information on: [Prunus serotina](#)

References:

Agriculture Quebec. 1975. Noms des maladies des plantes du Canada/ Names of plant diseases in Canada. , Quebec City, Que., Canada. 288 pp.

Alex, J. F., Cayouette, R., Mulligan, G. A. 1980. Common and botanical names of weeds in Canada/Noms populaire et scientifiques des plantes nuisibles du Canada. Revised. Agric. Can. Publ., Ottawa, Ont., Canada. 132 pp.

Bailey, L. H., Bailey, E. Z. 1976. Hortus third. Revised. MacMillan, New York, N.Y., USA. 1290 pp.

Scoggan, H. J. 1978, 1979. The flora of Canada. Nat. Mus. Nat. Sci. (Ottawa) Publ. Bot. 7(1)-7(4). 1711 pp.

Van Wijk, H. L. 1911. A dictionary of plant names. Martinus Nijhoff, The Hague, The Netherlands. 1444 pp.

Victorin, M. 1964. Flore Laurentienne. 2nd ed. Univ. Montreal, Montreal, Que., Canada. 952 pp.

Geographic Information

New Brunswick

Nova Scotia

Ontario

Quebec

References:

Bailey, L. H., Bailey, E. Z. 1976. Hortus third. Revised. MacMillan, New York, N.Y., USA. 1290 pp.

Boivin, B. 1966, 1967. Énumération des plantes du Canada. Provencheria 6. Nat. Can. (Que.) 93: 253-274; 371-437; 583-646; 989-1063. 94: 131-157; 471-528; 625-655.

Image or illustration

black cherry:

Images: images.google.com

Notes on Poisonous plant parts:

The leaves of black cherry contain on average of 212 mg hydrocyanic acid (HCN) per 100 g of fresh leaves. A lethal dose of HCN for humans is between 0.5 and 0.35 mg/kg of body weight. The lethal dose of HCN for cattle and sheep is about 2.0 mg/kg of body weight (Kingsbury 1964).

Toxic parts:

leaves

seeds

twigs

References:

Kingsbury, J. M. 1964. Poisonous plants of the United States and Canada. Prentice-Hall Inc., Englewood Cliffs, N.J., USA. 626 pp.

Notes on Toxic plant chemicals:

Two cyanogenic glycosides are found in black cherry. Amygdalin and prunasin are found in the leaves, twigs, and seeds (Cheeke and Schull 1985). Hydrogen cyanide is formed when the glycosides are hydrolyzed by plant enzymes after damage or by rumen organisms. Majak et al. (1990) found that cyanide production is most rapid in cattle that had been starved for a day. High rates of cyanide production were obtained in the rumen after the animal ingested fresh alfalfa and cubed alfalfa hay.

Toxic plant chemicals:

amygdalin

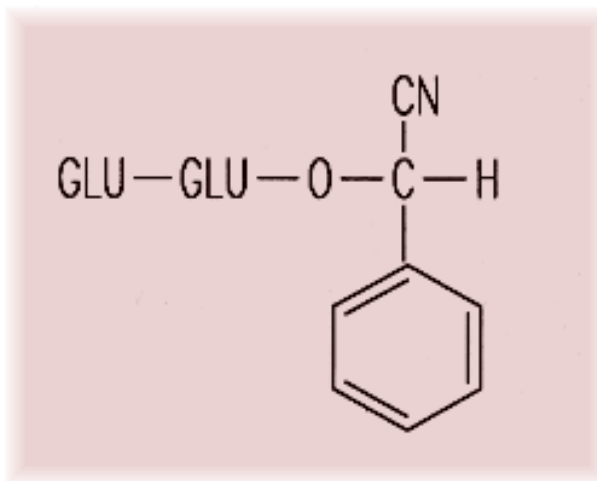

prunasin

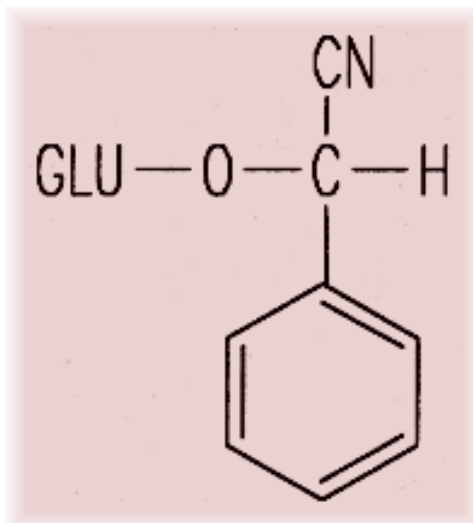

Chemical diagram(s) are courtesy of [Ruth McDiarmid](#), Biochemistry Technician, Kamloops Range Station, Agriculture and Agri-Food Canada, Kamloops, British Columbia, Canada.

References:

Cheeke, P. R., Shull, L. R. 1985. Natural toxicants in feeds and poisonous plants. AVI Publishing Company, Inc., Westport, Conn., USA. 492 pp.

Majak, W., McDiarmid, R. E., Hall, J. W., Cheng, K.-J. 1990. Factors that determine rates of cyanogenesis in bovine ruminal fluid in vitro. J. Anim. Sci., 68: 1648-1655.

Animals/Human Poisoning:

Note: When an animal is listed without additional information, the literature (as of 1993) contained no detailed explanation.

Cattle

General symptoms of poisoning:

[breathing, labored](#)

[death by asphyxiation](#)

[gait, staggering](#)

[muscle spasms](#)

[pupil dilation](#)

Notes on poisoning:

Symptoms of cyanide poisoning are common to all animals. Symptoms may be minimal, with difficult breathing followed by death. Other signs of toxicity may include a short period of stimulation followed by slow pulse, dilated pupils, spasms, staggering, loss of consciousness, and death, which results from asphyxiation. Postmortem findings include bright red blood and congestion of internal organs (Kingsbury 1964, Scimeca and Oehme 1985).

References:

Cheeke, P. R., Shull, L. R. 1985. Natural toxicants in feeds and poisonous plants. AVI Publishing Company, Inc., Westport, Conn., USA. 492 pp.

Kingsbury, J. M. 1964. Poisonous plants of the United States and Canada. Prentice-Hall Inc., Englewood Cliffs, N.J., USA. 626 pp.

Horses

General symptoms of poisoning:

[breathing, labored](#)

[coma](#)

[death by asphyxiation](#)

[dyspnea](#)

[gait, staggering](#)

[muscle spasms](#)

[paralysis](#)

Notes on poisoning:

See notes under cattle for more information.

References:

Kingsbury, J. M. 1964. Poisonous plants of the United States and Canada. Prentice-Hall Inc., Englewood Cliffs, N.J., USA. 626 pp.

Humans

General symptoms of poisoning:

[abdominal pains](#)

[coma](#)

[death](#)

[lethargy](#)

[sweating](#)

[vomiting](#)

Notes on poisoning:

Ingesting large quantities of berries has caused poisoning, because of the toxin in the seeds. Children have been poisoned by chewing twigs or drinking tea made from the leaves. Symptoms include difficult breathing, voice paralysis, twitching, spasms, coma of short duration, and death. Cyanide poisoning can occur quickly, with few symptoms (Hardin and Arena 1969).

References:

Hardin, J. W., Arena, J. M. 1969. Human poisoning from native and cultivated plants. Duke University Press, Durham, N.C., USA. 167 pp.

Lampe, K. F., McCann, M. A. 1985. AMA Handbook of poisonous and injurious plants. American Medical Assoc. Chicago, Ill., USA. 432 pp.

Sheep

General symptoms of poisoning:

[breathing, labored](#)

[coma](#)

[convulsions](#)

[death by asphyxiation](#)

[gait, staggering](#)

[muscle spasms](#)

[paralysis](#)

[unconsciousness](#)

Notes on poisoning:

See notes under cattle for more information.

References:

Kingsbury, J. M. 1964. Poisonous plants of the United States and

Canada. Prentice-Hall Inc., Englewood Cliffs, N.J., USA. 626 pp.

Swine

General symptoms of poisoning:

[limbs,lateral rotation](#)

References:

Keeler, R. F. 1983. Naturally occurring teratogens from plants. Pages 161-199 in Keeler, R. F., Tu, A. T., eds. Handbook of natural toxins. Vol. 1. Plant and Fungal toxins. Marcel Dekker, Inc., New York, N.Y., USA. 934 pp.

[Another search?](#)

[Français](#) | [Contact Us](#) | [Help](#) | [Search](#) | [Canada site](#)

[Coming Events](#) | [About CBIF](#) | [Links](#) | [Reports and Publications](#) |

[Home](#)

Date modified: 2003-02-06

[Important Notices](#)



Français	Contact us	Help	Search	Canada site
Coming events	About CBIF	Links	Reports and publications	Home

Canadian Biodiversity Information Facility



Notes on poisoning: black henbane

[Introduction](#)[Interactive](#)[All poisonous plants by Botanical name](#)[All poisonous plants by Common name](#)[Important WWW Poisonous Plants sites](#)

General poisoning notes:

Black henbane (*Hyoscyamus niger*) is a naturalized herb found across parts of southern Canada. This plant contains several alkaloids, and it has caused rare poisoning in humans, cattle, poultry, and swine. Human poisoning has been accidental or purposeful because of its reported medicinal or hallucinogenic properties. Black henbane has been used medicinally since ancient times to help with a variety of health problems and as a preventative. Its hallucinogenic effects have led people to eat the seed or chew the flowers, often with detrimental results. Ingestion causes anticholinergic syndrome with stimulatory and hallucinatory effects (Hocking 1947, Spoerke et al. 1987). Cattle have been poisoned in Europe after ingesting black henbane that was included in forage. The alkaloid content is retained upon drying, and ingestion is said to taint the milk of cows. Poultry have died after ingesting the seeds, and pigs have died after eating the roots (Cooper and Johnson 1984, Spoerke et al. 1987).

References:

Cooper, M. R., Johnson, A. W. 1984. Poisonous plants in Britain and their effects on animals and man. Her Majesty's Stationery Office, London, England. 305 pp.

Hocking, G. M. 1947. Henbane - healing herb of Hercules and of Apollo. Econ. Bot., 1: 306-316.

Spoerke, D. G., Hall, A. H., Dodson, C. D., Stermitz, F. R., Swanson, C. H., Rumack, B. H. 1987. Mystery root ingestion. J. Emerg. Med., 5: 385-388.

Nomenclature:

Scientific Name: *Hyoscyamus niger* L.

Vernacular name(s): black henbane

Scientific family name: *Solanaceae*

Vernacular family name: nightshade

Go to ITIS^{*ca} for more taxonomic information on: [Hyoscyamus niger](#)

References:

Agriculture Quebec. 1975. Noms des maladies des plantes du Canada/ Names of plant diseases in Canada. , Quebec City, Que., Canada. 288 pp.

Alex, J. F., Cayouette, R., Mulligan, G. A. 1980. Common and botanical names of weeds in Canada/Noms populaire et scientifiques des plantes nuisibles du Canada. Revised. Agric. Can. Publ., Ottawa, Ont., Canada. 132 pp.

Bailey, L. H., Bailey, E. Z. 1976. Hortus third. Revised. MacMillan, New York, N.Y., USA. 1290 pp.

Scoggan, H. J. 1978, 1979. The flora of Canada. Nat. Mus. Nat. Sci. (Ottawa) Publ. Bot. 7(1)-7(4). 1711 pp.

Van Wijk, H. L. 1911. A dictionary of plant names. Martinus Nijhoff, The Hague, The Netherlands. 1444 pp.

Victorin, M. 1964. Flore Laurentienne. 2nd ed. Univ. Montreal, Montreal, Que., Canada. 952 pp.

Geographic Information

Alberta
Manitoba
New Brunswick
Nova Scotia
Ontario
Quebec
Saskatchewan

References:

Bailey, L. H., Bailey, E. Z. 1976. Hortus third. Revised. MacMillan, New York, N.Y., USA. 1290 pp.

Boivin, B. 1966, 1967. Énumération des plantes du Canada. Provencheria 6. Nat. Can. (Que.) 93: 253-274; 371-437; 583-646; 989-1063. 94: 131-157; 471-528; 625-655.

Image or illustration

black henbane:

Images: images.google.com

Notes on Poisonous plant parts:

All parts of the plant contain alkaloids in varying quantities (see the additional notes under chemicals). Ingestion of four flowers has caused some symptoms in humans (Frohne and Pfander 1983, Spoerke et al. 1987).

Toxic parts:

all parts
flowers
leaves
roots
seeds

References:

Frohne, D., Pfander, H. J. 1983. A colour atlas of poisonous plants. Wolfe Publishing Ltd., London, England. 291 pp.

Notes on Toxic plant chemicals:

Hyoscyamine, hyoscyne, and atropine can all be found in black henbane. The alkaloid content has been measured at 0.08% (roots), 0.17% (leaves), and 0.3% (seeds). The major affect of hyoscyamine is depression of the central nervous system (Frohne and Pfander 1983; Cooper and Johnson 1984).

Toxic plant chemicals:

atropine
hyoscyne(scopolamine)
hyoscyamine

References:

Cooper, M. R., Johnson, A. W. 1984. Poisonous plants in Britain and their effects on animals and man. Her Majesty's Stationery Office, London, England. 305 pp.

Frohne, D., Pfander, H. J. 1983. A colour atlas of poisonous plants. Wolfe Publishing Ltd., London, England. 291 pp.

Animals/Human Poisoning:

Note: When an animal is listed without additional information, the literature (as of 1993) contained no detailed explanation.

Cattle

General symptoms of poisoning:

[bloat](#)

[breathing, labored](#)

[convulsions](#)

[cyanosis](#)

[heart rate, elevated](#)

[incoordination](#)

[pupil dilation](#)

[restlessness](#)

Notes on poisoning:

Symptoms of ingestion include restlessness, excitation, convulsions, pupil dilation, difficulty in breathing, increased heart rate, and bloat. Postmortem examination showed degeneration of heart muscle and cyanosis of mucous membranes (Cooper and Johnson 1984).

References:

Cooper, M. R., Johnson, A. W. 1984. Poisonous plants in Britain and their effects on animals and man. Her Majesty's Stationery Office, London, England. 305 pp.

Humans

General symptoms of poisoning:

[coma](#)

[confusion](#)

[death](#)

[hallucination](#)

[mouth dry](#)

[nausea](#)

[pupil dilation](#)

[skin, flushed](#)

[vomiting](#)

Notes on poisoning:

Symptoms of poisoning include thirst, dry mouth, dilated pupils,

warm and flushed skin, and hallucinations. Purposeless movements, such as picking at the air, have been observed. Heart rate is elevated. These are the symptoms that occur after the roots are ingested. Ingesting the flowers has caused agitation, restlessness, dry skin, and pupil dilation (Spoerke et al. 1987).

References:

Hocking, G. M. 1947. Henbane - healing herb of Hercules and of Apollo. *Econ. Bot.*, 1: 306-316.

Spoerke, D. G., Hall, A. H., Dodson, C. D., Stermitz, F. R., Swanson, C. H., Rumack, B. H. 1987. Mystery root ingestion. *J. Emerg. Med.*, 5: 385-388.

Poultry

Swine

[Another search?](#)

[Français](#) | [Contact Us](#) | [Help](#) | [Search](#) | [Canada site](#)

[Coming Events](#) | [About CBIF](#) | [Links](#) | [Reports and Publications](#) |

[Home](#)

Date modified: 2003-02-06

[Important Notices](#)



Français	Contact us	Help	Search	Canada site
Coming events	About CBIF	Links	Reports and publications	Home

Canadian Biodiversity Information Facility



Notes on poisoning: black locust

[Introduction](#)

[Interactive](#)

[All poisonous plants by Botanical name](#)

[All poisonous plants by Common name](#)

[Important WWW Poisonous Plants sites](#)



General poisoning notes:

Black locust (*Robinia pseudoacacia*) is a naturalized shrub or tree that is planted as an ornamental in warmer parts of Canada. The seeds, bark, and leaves contain toxic proteins that have caused sickness and death in cattle, horses, poultry, sheep, and humans. The plant should be considered toxic to all animals if ingested. Children were poisoned (with rare reports of fatalities) after chewing on plant material, especially the bark. This tree can be found around older farms and houses and is also planted along fencerows. Children should be taught not to ingest any parts of the plant. If older trees are cut down in areas where livestock have access, make sure that the animals do not ingest any sprout (sucker) growth that may emerge from the stump (Hansen 1924, Kingsbury 1964, Cooper and Johnson 1984).

References:

Cooper, M. R., Johnson, A. W. 1984. Poisonous plants in Britain and their effects on animals and man. Her Majesty's Stationery Office, London, England. 305 pp.

Hansen, A. A. 1924. Robinin - a potent plant poison. Better Crops, 22(2): 22-23, 44.

Kingsbury, J. M. 1964. Poisonous plants of the United States and Canada. Prentice-Hall Inc., Englewood Cliffs, N.J., USA. 626 pp.

Nomenclature:

Scientific Name: *Robinia pseudoacacia* L.

Vernacular name(s): black locust

Scientific family name: *Leguminosae*

Vernacular family name: pea

Go to ITIS^{*ca} for more taxonomic information on: [Robinia pseudoacacia](#)

References:

Agriculture Quebec. 1975. Noms des maladies des plantes du Canada/ Names of plant diseases in Canada. , Quebec City, Que., Canada. 288 pp.

Alex, J. F., Cayouette, R., Mulligan, G. A. 1980. Common and botanical names of weeds in Canada/Noms populaire et scientifiques des plantes nuisibles du Canada. Revised. Agric. Can. Publ., Ottawa, Ont., Canada. 132 pp.

Bailey, L. H., Bailey, E. Z. 1976. Hortus third. Revised. MacMillan, New York, N.Y., USA. 1290 pp.

Scoggan, H. J. 1978, 1979. The flora of Canada. Nat. Mus. Nat. Sci. (Ottawa) Publ. Bot. 7(1)-7(4). 1711 pp.

Van Wijk, H. L. 1911. A dictionary of plant names. Martinus Nijhoff, The Hague, The Netherlands. 1444 pp.

Victorin, M. 1964. Flore Laurentienne. 2nd ed. Univ. Montreal, Montreal, Que., Canada. 952 pp.

Geographic Information

British Columbia
Nova Scotia
Ontario
Prince Edward Island
Quebec

References:

Bailey, L. H., Bailey, E. Z. 1976. Hortus third. Revised. MacMillan, New York, N.Y., USA. 1290 pp.

Boivin, B. 1966, 1967. Énumération des plantes du Canada. Provencheria 6. Nat. Can. (Que.) 93: 253-274; 371-437; 583-646; 989-1063. 94: 131-157; 471-528; 625-655.

Image or illustration

black locust:

Images: images.google.com

Toxic parts:

bark
leaves
seeds

References:

Cooper, M. R., Johnson, A. W. 1984. Poisonous plants in Britain and their effects on animals and man. Her Majesty's Stationery Office, London, England. 305 pp.

Notes on Toxic plant chemicals:

Robin (or robinin) and phasin, which are toxic proteins called toxalbumins, are present in black locust. A glycoprotein that agglutinates red blood cells has been extracted from the plant. It is not clear if this is robin or another substance. Experimental feeding to horses has shown the following toxicities:

=> aqueous extract of bark about 0.1% of body weight caused symptoms

=> powdered bark about 0.04% of body weight caused symptoms

The poisonous principle appears to be about one-tenth as toxic to cattle (Kingsbury 1964, Cooper and Johnson 1984).

Toxic plant chemicals:

phasin
robin(in)

References:

Cooper, M. R., Johnson, A. W. 1984. Poisonous plants in Britain and their effects on animals and man. Her Majesty's Stationery Office, London, England. 305 pp.

Kingsbury, J. M. 1964. Poisonous plants of the United States and Canada. Prentice-Hall Inc., Englewood Cliffs, N.J., USA. 626 pp.

Animals/Human Poisoning:

Note: When an animal is listed without additional information, the literature (as of 1993) contained no detailed explanation.

Cattle

General symptoms of poisoning:

[anorexia](#)

[death](#)

[dyspnea](#)

[nausea](#)

[paralysis, posterior](#)

[weakness](#)

Notes on poisoning:

Cattle that ingested the sprouts and leaves of black locust were poisoned. Experiments show that cattle are 10 times less sensitive to the toxin than horses. Symptoms include anorexia, weakness, posterior paralysis, nausea, coldness of the extremities, and dilation of the pupils. Death occurs in severe cases (Hansen 1924, Kingsbury 1964).

References:

Kingsbury, J. M. 1964. Poisonous plants of the United States and Canada. Prentice-Hall Inc., Englewood Cliffs, N.J., USA. 626 pp.

Horses

General symptoms of poisoning:

[anorexia](#)

[death](#)

[nausea](#)

[paralysis, posterior](#)

[pupil dilation](#)

[weakness](#)

Notes on poisoning:

Horses that ingested black locust leaves, sprouts, and bark were poisoned and died. Symptoms are similar to those of cattle and include anorexia, weakness, posterior paralysis, nausea, coldness of the extremities, and pupil dilation. Symptoms of colic also occur. In severe cases, death occurs. Postmortem findings showed mucous inflammation of the gastrointestinal tract and occasional severe gastroenteritis. In some cases a yellowish pigmentation of the membranes occurred (Hansen 1924, Kingsbury 1964).

References:

Kingsbury, J. M. 1964. Poisonous plants of the United States and Canada. Prentice-Hall Inc., Englewood Cliffs, N.J., USA. 626 pp.

Humans

General symptoms of poisoning:

[death](#)

[nausea](#)

[pupil dilation](#)

[vomiting](#)

Notes on poisoning:

Humans, usually children, were poisoned after ingesting the bark of black locust. Symptoms include pupil dilation, feeble pulse, severe vomiting, and a death-like palor. The extremities may become cold. Intestinal inflammation, hemorrhaging of the lymphatic tissues, and possible liver damage often occur. Fatalities are rare. The chances of poisoning are rare. Children should not be allowed to ingest plant material from this tree (Hansen 1924, Kingsbury 1964).

References:

Hansen, A. A. 1924. Robitin - a potent plant poison. *Better Crops*, 22(2): 22-23, 44.

Kingsbury, J. M. 1964. *Poisonous plants of the United States and Canada*. Prentice-Hall Inc., Englewood Cliffs, N.J., USA. 626 pp.

Poultry

General symptoms of poisoning:

[liver, congestion of](#)

Notes on poisoning:

Chickens were poisoned after ingesting leaf material. Degenerative changes in the liver and kidney occurred. A toxic phytohemagglutinin extracted from the plant caused fatty degeneration of the liver and death in chick embryos, at doses of 0.25-2.0 mg per egg (Kingsbury 1964, Cooper and Johnson 1984).

References:

Cooper, M. R., Johnson, A. W. 1984. *Poisonous plants in Britain and their effects on animals and man*. Her Majesty's Stationery Office, London, England. 305 pp.

Kingsbury, J. M. 1964. *Poisonous plants of the United States and Canada*. Prentice-Hall Inc., Englewood Cliffs, N.J., USA. 626 pp.

Sheep

General symptoms of poisoning:

[anorexia](#)

Notes on poisoning:

Ingesting the seed pods has caused minor illness in sheep (Kingsbury 1964).

References:

Kingsbury, J. M. 1964. Poisonous plants of the United States and Canada. Prentice-Hall Inc., Englewood Cliffs, N.J., USA. 626 pp.

[Another search?](#)

[Français](#) | [Contact Us](#) | [Help](#) | [Search](#) | [Canada site](#)

[Coming Events](#) | [About CBIF](#) | [Links](#) | [Reports and Publications](#) | [Home](#)

Date modified: 2003-02-06

[Important Notices](#)



Français	Contact us	Help	Search	Canada site
Coming events	About CBIF	Links	Reports and publications	Home

Canadian Biodiversity Information Facility



Notes on poisoning: black nightshade

[Introduction](#)[Interactive](#)[All poisonous plants by Botanical name](#)[All poisonous plants by Common name](#)[Important WWW Poisonous Plants sites](#)

General poisoning notes:

Black nightshade (*Solanum nigrum*) is a naturalized herb found scattered across southern Canada in waste places. This plant can be easily confused with eastern black nightshade, a native herb, which is more commonly found in its range in eastern Canada (see taxonomy and distributions in Ogg et al. 1981, Bassett and Munro 1985). Black nightshade contains toxic glycoalkaloids in the plant. The highest concentration is in the green immature berries. All kinds of animals can be poisoned after ingesting nightshade including cattle, sheep, poultry, and swine. Children have been poisoned and have died after ingesting unripe berries. The ripe berries cause reduced symptoms of mild abdominal pains, vomiting, and diarrhea (Cooper and Johnson 1984, Lampe and McCann 1985). Some Canadian garden catalogs sell seed for garden huckleberry (*Solanum melanocerasum* All.; also previously known as *Solanum nigrum* L. var. *guineense* L.). This plant has edible black fruits that can be cooked for use in pies, jams, and preserves. The plant may persist from seed for more than a year in gardens in warmer parts of Canada. There is no evidence that the ripe fruits are toxic. Other species of nightshade occur in Canada, and some may contain small amounts of toxins. Eastern black nightshade (*Solanum ptycanthum* Dun ex DC.) may contain small amounts of toxin in the green berries. Berries of hairy nightshade (*Solanum sarrachoides* Sendt.) have been tested as a teratogen in hamsters but the results were not statistically significant (Keeler et al. 1990).

References:

- Bassett, I. J., [Munro, D. B.](#) 1985. The biology of Canadian weeds. 67. *Solanum ptycanthum* Dun., *S. nigrum* L. and *S. sarrachoides* Sendt. Can. J. Plant Sci., 65: 401-414.
- Cooper, M. R., Johnson, A. W. 1984. Poisonous plants in Britain and their effects on animals and man. Her Majesty's Stationery Office, London, England. 305 pp.
- Keeler, R. F., Baker, D. C., Gaffield, W. 1990. Spirosolane-containing

Solanum species and induction of congenital craniofacial malformations. *Toxicon*, 28: 873-884.

Lampe, K. F., McCann, M. A. 1985. *AMA Handbook of poisonous and injurious plants*. American Medical Assoc. Chicago, Ill., USA. 432 pp.

Ogg, A. G., Rogers, B. S., Schilling, E. E. 1981. Characterization of black nightshade (*Solanum nigrum*) and related species in the United States. *Weed Sci.*, 29: 27-32.

Reynard, G. B., Norton, J. B. 1942. Poisonous plants of Maryland in relation to livestock. *Univ. MD. Agric. Exp. Stn. Bull.*, A10. 312 pp.

Nomenclature:

Scientific Name: *Solanum nigrum* L.

Vernacular name(s): black nightshade

Scientific family name: *Solanaceae*

Vernacular family name: nightshade

Go to ITIS^{*ca} for more taxonomic information on: [Solanum nigrum](#)

References:

Agriculture Quebec. 1975. *Noms des maladies des plantes du Canada/ Names of plant diseases in Canada*. , Quebec City, Que., Canada. 288 pp.

Alex, J. F., Cayouette, R., Mulligan, G. A. 1980. *Common and botanical names of weeds in Canada/Noms populaire et scientifiques des plantes nuisibles du Canada*. Revised. *Agric. Can. Publ.*, Ottawa, Ont., Canada. 132 pp.

Bailey, L. H., Bailey, E. Z. 1976. *Hortus third*. Revised. MacMillan, New York, N.Y., USA. 1290 pp.

Scoggan, H. J. 1978, 1979. *The flora of Canada*. *Nat. Mus. Nat. Sci. (Ottawa) Publ. Bot.* 7(1)-7(4). 1711 pp.

Van Wijk, H. L. 1911. *A dictionary of plant names*. Martinus Nijhoff, The Hague, The Netherlands. 1444 pp.

Victorin, M. 1964. *Flore Laurentienne*. 2nd ed. Univ. Montreal, Montreal, Que., Canada. 952 pp.

Geographic Information

Alberta
British Columbia
Manitoba
New Brunswick
Nova Scotia

Ontario
Quebec
Saskatchewan

References:

Bailey, L. H., Bailey, E. Z. 1976. Hortus third. Revised. MacMillan, New York, N.Y., USA. 1290 pp.

Boivin, B. 1966, 1967. Énumération des plantes du Canada. Provencheria 6. Nat. Can. (Que.) 93: 253-274; 371-437; 583-646; 989-1063. 94: 131-157; 471-528; 625-655.

Image or illustration

black nightshade:

Images: images.google.com

Notes on Poisonous plant parts:

All parts of the plant contain alkaloids, especially the green immature berries. The concentration increases in the leaves until plant maturity. The ripe black berries contain little alkaloidal content and can sometimes be eaten with no harmful effects (Cooper and Johnson 1984).

Toxic parts:

all parts
immature fruit
leaves

References:

Cooper, M. R., Johnson, A. W. 1984. Poisonous plants in Britain and their effects on animals and man. Her Majesty's Stationery Office, London, England. 305 pp.

Notes on Toxic plant chemicals:

Toxic glycoalkaloids, including solanine, solasodine, and chaconine are found in black nightshade, especially in the green immature berries. Nitrates can also accumulate in the plant material (Cooper and Johnson 1984).

Toxic plant chemicals:

chaconine

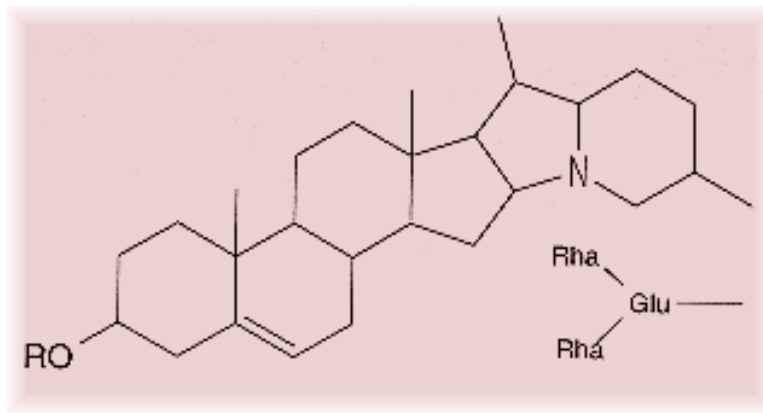

nitrate
solanine

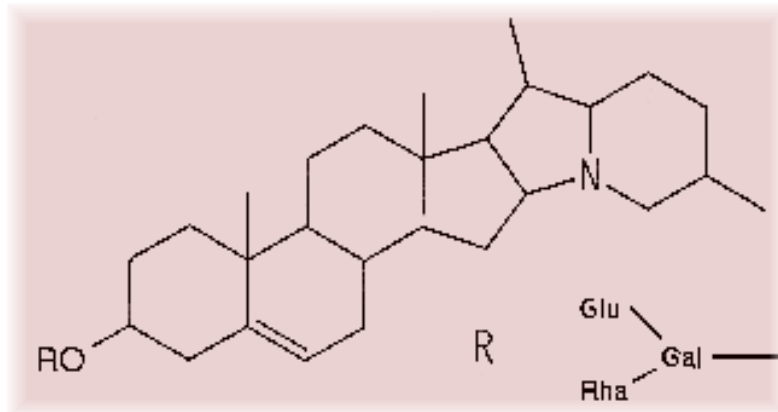

solasodine

Chemical diagram(s) are courtesy of [Ruth McDiarmid](#), Biochemistry Technician, Kamloops Range Station, Agriculture and Agri-Food Canada, Kamloops, British Columbia, Canada.

References:

Cooper, M. R., Johnson, A. W. 1984. Poisonous plants in Britain and their effects on animals and man. Her Majesty's Stationery Office, London, England. 305 pp.

Animals/Human Poisoning:

Note: When an animal is listed without additional information, the literature (as of 1993) contained no detailed explanation.

Cattle

General symptoms of poisoning:

[breathing, labored](#)
[constipation](#)
[death](#)

[diarrhea](#)
[incoordination](#)
[muzzle, dry](#)
[pupil dilation](#)
[temperature, depressed](#)

Notes on poisoning:

Symptoms of poisoning are similar to those for swine. Cattle can also develop edema from the lower jaw to the front of the legs (Cooper and Johnson 1984).

References:

Cooper, M. R., Johnson, A. W. 1984. Poisonous plants in Britain and their effects on animals and man. Her Majesty's Stationery Office, London, England. 305 pp.

Humans

General symptoms of poisoning:

[abdominal pains](#)
[death](#)
[diarrhea](#)
[dizziness](#)
[temperature, elevated](#)
[unconsciousness](#)
[vomiting](#)

Notes on poisoning:

Humans have been poisoned and have died (rarely) after ingesting usually green immature berries. Ripe, black berries have little toxin in them, although abdominal pains and vomiting could occur. Symptoms usually occur only after a latent period of several hours and may persist for several days. Symptoms resemble those of bacterial gastroenteritis and include headache, speech impairment, and unconsciousness (Cooper and Johnson 1984, Lampe and McCann 1985).

References:

Cooper, M. R., Johnson, A. W. 1984. Poisonous plants in Britain and their effects on animals and man. Her Majesty's Stationery Office, London, England. 305 pp.

Poultry

General symptoms of poisoning:

[death](#)

Notes on poisoning:

In one case in Maryland, over 300 pullets died when they were allowed to feed on a field overgrown with black nightshade (Reynard and Norton 1942).

References:

Cooper, M. R., Johnson, A. W. 1984. Poisonous plants in Britain and their effects on animals and man. Her Majesty's Stationery Office, London, England. 305 pp.

Swine

General symptoms of poisoning:

[breathing, rapid](#)

[death](#)

[incoordination](#)

[muscle spasms](#)

[temperature, depressed](#)

Notes on poisoning:

Pigs have been poisoned after ingesting black nightshade. Symptoms included rapid pulse and respiration, pale mucous membranes, dilated pupils, depressed temperature, incoordination, and tremors (Cooper and Johnson 1984).

References:

Cooper, M. R., Johnson, A. W. 1984. Poisonous plants in Britain and their effects on animals and man. Her Majesty's Stationery Office, London, England. 305 pp.

[Another search?](#)

[Français](#) | [Contact Us](#) | [Help](#) | [Search](#) | [Canada site](#)

[Coming Events](#) | [About CBIF](#) | [Links](#) | [Reports and Publications](#) | [Home](#)

Date modified: 2003-02-06

[Important Notices](#)



Français	Contact us	Help	Search	Canada site
Coming events	About CBIF	Links	Reports and publications	Home

Canadian Biodiversity Information Facility



Notes on poisoning: black oak

[Introduction](#)[Interactive](#)[All poisonous plants by Botanical name](#)[All poisonous plants by Common name](#)[Important WWW Poisonous Plants sites](#)

General poisoning notes:

Black oak (*Quercus velutina*) is a native tree found only in southern Ontario. The acorns contain significant quantities of toxic phenolics. This plant caused sickness and death in cattle after they ingested acorns on autumn pastures. The occurrence of poisoning from black oak in southern Ontario is minimal because of its restricted distribution (Sandusky et al. 1977, Basden and Dalvi 1987).

References:

- Basden, K. W., Dalvi, R. R. 1987. Determination of total phenolics in acorns from different species of oak trees in conjunction with acorn poisoning in cattle. *Vet. Hum. Toxicol.*, 29: 305-306.
- Cockrill, J. M., Beasley, J. N. 1979. Renal damage to cattle during acorn poisoning. *Vet. Med. Small Anim. Clin.*, 74: 82, 84-85.
- Sandusky, G. E., Fosnaugh, C. J., Smith, J. B., Mohan, R. 1977. Oak poisoning of cattle in Ohio. *J. Am. Vet. Med. Assoc.*, 171: 627-629.

Nomenclature:

Scientific Name: *Quercus velutina* Lam.

Vernacular name(s): black oak

Scientific family name: *Fagaceae*

Vernacular family name: beech

Go to ITIS*^{ca} for more taxonomic information on: [Quercus velutina](#)

References:

Agriculture Quebec. 1975. Noms des maladies des plantes du Canada/ Names of plant diseases in Canada. , Quebec City, Que., Canada. 288 pp.

Alex, J. F., Cayouette, R., Mulligan, G. A. 1980. Common and botanical names of weeds in Canada/Noms populaire et scientifiques des plantes nuisibles du Canada. Revised. Agric. Can. Publ., Ottawa, Ont., Canada. 132 pp.

Bailey, L. H., Bailey, E. Z. 1976. Hortus third. Revised. MacMillan, New York, N.Y., USA. 1290 pp.

Scoggan, H. J. 1978, 1979. The flora of Canada. Nat. Mus. Nat. Sci. (Ottawa) Publ. Bot. 7(1)-7(4). 1711 pp.

Van Wijk, H. L. 1911. A dictionary of plant names. Martinus Nijhoff, The Hague, The Netherlands. 1444 pp.

Victorin, M. 1964. Flore Laurentienne. 2nd ed. Univ. Montreal, Montreal, Que., Canada. 952 pp.

Geographic Information

Ontario

References:

Bailey, L. H., Bailey, E. Z. 1976. Hortus third. Revised. MacMillan, New York, N.Y., USA. 1290 pp.

Boivin, B. 1966, 1967. Énumération des plantes du Canada. Provencheria 6. Nat. Can. (Que.) 93: 253-274; 371-437; 583-646; 989-1063. 94: 131-157; 471-528; 625-655.

Image or illustration

black oak:

Images: images.google.com

Notes on Poisonous plant parts:

Ingesting oak leaves and acorns has caused poisoning. Immature acorns contain more toxin than mature acorns (Sandusky et al. 1977).

Toxic parts:

acorns

leaves

References:

Sandusky, G. E., Fosnaugh, C. J., Smith, J. B., Mohan, R. 1977. Oak poisoning of cattle in Ohio. J. Am. Vet. Med. Assoc., 171: 627-629.

Notes on Toxic plant chemicals:

See notes under chemical section of red oak ([Quercus rubra](#)).

Toxic plant chemicals:

gallic acid
pyrogallol
tannic acid

References:

Basden, K. W., Dalvi, R. R. 1987. Determination of total phenolics in acorns from different species of oak trees in conjunction with acorn poisoning in cattle. Vet. Hum. Toxicol., 29: 305-306.

Animals/Human Poisoning:

Note: When an animal is listed without additional information, the literature (as of 1993) contained no detailed explanation.

Cattle

General symptoms of poisoning:

[anorexia](#)
[ascites](#)
[constipation](#)
[diarrhea](#)
[hematuria](#)
[kidney failure](#)

References:

Cockrill, J. M., Beasley, J. N. 1979. Renal damage to cattle during acorn poisoning. Vet. Med. Small Anim. Clin., 74: 82, 84-85.

Sandusky, G. E., Fosnaugh, C. J., Smith, J. B., Mohan, R. 1977.

Oak poisoning of cattle in Ohio. J. Am. Vet. Med. Assoc., 171:
627-629.

Horses

Sheep

[Another search?](#)

[Français](#) | [Contact Us](#) | [Help](#) | [Search](#) | [Canada site](#)

[Coming Events](#) | [About CBIF](#) | [Links](#) | [Reports and Publications](#) |

[Home](#)

Date modified: 2003-02-06

[Important Notices](#)



Français	Contact us	Help	Search	Canada site
Coming events	About CBIF	Links	Reports and publications	Home

Canadian Biodiversity Information Facility



Notes on poisoning: black walnut

[Introduction](#)

[Interactive](#)

[All poisonous plants by Botanical name](#)

[All poisonous plants by Common name](#)

[Important WWW Poisonous Plants sites](#)



General poisoning notes:

Black walnut (*Juglans nigra*) is native to southwestern Ontario and has been planted as a cultivated tree. The shavings of wood from this tree have caused laminitis in horses in the United States. Black walnut shavings are less likely to be used as bedding in Canada because the tree is not common here. However, if bedding is obtained from a hardwood mill or furniture manufacturing plant, sufficient black black walnut shavings may be present to cause problems. Reforestation of black walnut has been attempted in southern Ontario by leaving nuts for squirrels to gather in the autumn. The squirrel bury them for the winter, allowing many black walnut trees to germinate by this method. Pollen of black walnut has been implicated in causing laminitis in horses (MacDaniels 1983, Minnick et al. 1987).

References:

Galey, F. D., Whiteley, H. E., Goetz, T. E., Kuenstler, A. R., Davis, C. A., Beasley, V. R. 1991. Black walnut (*Juglans nigra*) Toxicosis: a model for equine laminitis. *J. Comp. Pathol.*, 104: 313-326.

MacDaniels, L. H. 1983. Perspective on the black walnut toxicity problem - apparent allergies to man and horse. *Cornell Vet.*, 73: 204-207.

Minnick, P. D., Brown, C. M., Braselton, W. E., Meerdink, G. L., Slanker, M. R. 1987. The induction of equine laminitis with an aqueous extract of the heartwood of black walnut (*Juglans nigra*). *Vet. Hum. Toxicol.*, 29: 230-233.

True, R. G., Lowe, J. E. 1980. Induced juglone toxicosis in ponies and horses. *Am. J. Vet. Res.*, 41: 944-945.

Nomenclature:

Scientific Name: *Juglans nigra* L.

Vernacular name(s): black walnut

Scientific family name: *Juglandaceae*

Vernacular family name: walnut

Go to ITIS^{*ca} for more taxonomic information on: [Juglans nigra](#)

References:

Agriculture Quebec. 1975. Noms des maladies des plantes du Canada/ Names of plant diseases in Canada. , Quebec City, Que., Canada. 288 pp.

Alex, J. F., Cayouette, R., Mulligan, G. A. 1980. Common and botanical names of weeds in Canada/Noms populaire et scientifiques des plantes nuisibles du Canada. Revised. Agric. Can. Publ., Ottawa, Ont., Canada. 132 pp.

Bailey, L. H., Bailey, E. Z. 1976. Hortus third. Revised. MacMillan, New York, N.Y., USA. 1290 pp.

Scoggan, H. J. 1978, 1979. The flora of Canada. Nat. Mus. Nat. Sci. (Ottawa) Publ. Bot. 7(1)-7(4). 1711 pp.

Van Wijk, H. L. 1911. A dictionary of plant names. Martinus Nijhoff, The Hague, The Netherlands. 1444 pp.

Victorin, M. 1964. Flore Laurentienne. 2nd ed. Univ. Montreal, Montreal, Que., Canada. 952 pp.

Geographic Information

Ontario

References:

Bailey, L. H., Bailey, E. Z. 1976. Hortus third. Revised. MacMillan, New York, N.Y., USA. 1290 pp.

Boivin, B. 1966, 1967. Énumération des plantes du Canada. Provencheria 6. Nat. Can. (Que.) 93: 253-274; 371-437; 583-646; 989-1063. 94: 131-157; 471-528; 625-655.

Image or illustration

black walnut:

Images: images.google.com

Notes on Poisonous plant parts:

Wood shavings of black walnut have caused symptoms in horses. The chemical juglone has not been found in appreciable amounts in the wood. Other chemicals are probably involved in causing symptoms in horses from wood shavings (Minnick et al. 1987).

Toxic parts:

bark
mature fruit
wood

References:

Minnick, P. D., Brown, C. M., Braselton, W. E., Meerdink, G. L., Slanker, M. R. 1987. The induction of equine laminitis with an aqueous extract of the heartwood of black walnut (*Juglans nigra*). Vet. Hum. Toxicol., 29: 230-233.

Notes on Toxic plant chemicals:

Juglone, a naphthoquinone, has been found in the bark, nuts, and roots of black walnut. Pure juglone is less potent than a crude extract of the plant in inducing toxic effects. Additional compounds seem to be involved in causing more severe cases. Two ponies given 1 g of pure juglone orally developed mild laminitis that disappeared within 24 h (Minnick et al. 1987).

Toxic plant chemicals:

juglone

References:

Minnick, P. D., Brown, C. M., Braselton, W. E., Meerdink, G. L., Slanker, M. R. 1987. The induction of equine laminitis with an aqueous extract of the heartwood of black walnut (*Juglans nigra*). Vet. Hum. Toxicol., 29: 230-233.

True, R. G., Lowe, J. E. 1980. Induced juglone toxicosis in ponies and horses. Am. J. Vet. Res., 41: 944-945.

Animals/Human Poisoning:

Note: When an animal is listed without additional information,

the literature (as of 1993) contained no detailed explanation.

Horses

General symptoms of poisoning:

[ataxia](#)

[breathing, rapid](#)

[depression](#)

[laminitis](#)

[lethargy](#)

[recumbency](#)

References:

Galey, F. D., Whiteley, H. E., Goetz, T. E., Kuenstler, A. R., Davis, C. A., Beasley, V. R. 1991. Black walnut (*Juglans nigra*) Toxicosis: a model for equine laminitis. J. Comp. Pathol., 104: 313-326.

MacDaniels, L. H. 1983. Perspective on the black walnut toxicity problem - apparent allergies to man and horse. Cornell Vet., 73: 204-207.

Minnick, P. D., Brown, C. M., Braselton, W. E., Meerdink, G. L., Slanker, M. R. 1987. The induction of equine laminitis with an aqueous extract of the heartwood of black walnut (*Juglans nigra*). Vet. Hum. Toxicol., 29: 230-233.

True, R. G., Lowe, J. E. 1980. Induced juglone toxicosis in ponies and horses. Am. J. Vet. Res., 41: 944-945.

[Another search?](#)

[Français](#) | [Contact Us](#) | [Help](#) | [Search](#) | [Canada site](#)

[Coming Events](#) | [About CBIF](#) | [Links](#) | [Reports and Publications](#) | [Home](#)

Date modified: 2003-02-06

[Important Notices](#)



Français	Contact us	Help	Search	Canada site
Coming events	About CBIF	Links	Reports and publications	Home

Canadian Biodiversity Information Facility



Notes on poisoning: black-eyed Susan

[Introduction](#)

[Interactive](#)

[All poisonous plants by Botanical name](#)

[All poisonous plants by Common name](#)

[Important WWW Poisonous Plants sites](#)



General poisoning notes:

Black-eyed Susan (*Rudbeckia laciniata*) is a native herb that grows across southern Canada. This plant occurs in fields and is sometimes found in disturbed habitats. Ingesting plants caused poisoning in cattle and swine. Symptoms were mild. Poisoning from this plant is unlikely (Kingsbury 1964, Fleurbec 1983).

References:

Kingsbury, J. M. 1964. Poisonous plants of the United States and Canada. Prentice-Hall Inc., Englewood Cliffs, N.J., USA. 626 pp.

Nomenclature:

Scientific Name: *Rudbeckia serotina* Nutt.

Vernacular name(s): black-eyed Susan

Scientific family name: *Compositae*

Vernacular family name: composite

Go to ITIS^{*ca} for more taxonomic information on: [Rudbeckia serotina](#)

References:

Agriculture Quebec. 1975. Noms des maladies des plantes du Canada/ Names of plant diseases in Canada. , Quebec City, Que., Canada. 288 pp.

Alex, J. F., Cayouette, R., Mulligan, G. A. 1980. Common and botanical names of weeds in Canada/Noms populaire et scientifiques des plantes nuisibles du Canada. Revised. Agric. Can. Publ., Ottawa, Ont., Canada. 132 pp.

Bailey, L. H., Bailey, E. Z. 1976. Hortus third. Revised. MacMillan, New York, N.Y., USA. 1290 pp.

Scoggan, H. J. 1978, 1979. The flora of Canada. Nat. Mus. Nat. Sci. (Ottawa) Publ. Bot. 7(1)-7(4). 1711 pp.

Van Wijk, H. L. 1911. A dictionary of plant names. Martinus Nijhoff, The Hague, The Netherlands. 1444 pp.

Victorin, M. 1964. Flore Laurentienne. 2nd ed. Univ. Montreal, Montreal, Que., Canada. 952 pp.

Geographic Information

Alberta
British Columbia
Manitoba
New Brunswick
Newfoundland
Nova Scotia
Ontario
Prince Edward Island
Quebec
Saskatchewan

References:

Bailey, L. H., Bailey, E. Z. 1976. Hortus third. Revised. MacMillan, New York, N.Y., USA. 1290 pp.

Boivin, B. 1966, 1967. Énumération des plantes du Canada. Provencheria 6. Nat. Can. (Que.) 93: 253-274; 371-437; 583-646; 989-1063. 94: 131-157; 471-528; 625-655.

Image or illustration

black-eyed Susan:

Images: images.google.com

Notes on Poisonous plant parts:

Ingesting aboveground portions of the plants has caused poisoning in some animals (Kingsbury 1964).

Toxic parts:

flowers
hairs
leaves

stems

References:

Kingsbury, J. M. 1964. Poisonous plants of the United States and Canada. Prentice-Hall Inc., Englewood Cliffs, N.J., USA. 626 pp.

Toxic plant chemicals:

unknown chemical

References:

Kingsbury, J. M. 1964. Poisonous plants of the United States and Canada. Prentice-Hall Inc., Englewood Cliffs, N.J., USA. 626 pp.

Animals/Human Poisoning:

Note: When an animal is listed without additional information, the literature (as of 1993) contained no detailed explanation.

Cattle

General symptoms of poisoning:

[gastroenteritis](#)

References:

Kingsbury, J. M. 1964. Poisonous plants of the United States and Canada. Prentice-Hall Inc., Englewood Cliffs, N.J., USA. 626 pp.

Swine

General symptoms of poisoning:

[coma](#)

Notes on poisoning:

Swine that ingested black-eyed Susan suffered from coma and periods of aimless wandering (Kingsbury 1964).

References:

Kingsbury, J. M. 1964. Poisonous plants of the United States and Canada. Prentice-Hall Inc., Englewood Cliffs, N.J., USA. 626 pp.

[Another search?](#)

[Français](#) | [Contact Us](#) | [Help](#) | [Search](#) | [Canada site](#)
[Coming Events](#) | [About CBIF](#) | [Links](#) | [Reports and Publications](#) |
[Home](#)

Date modified: 2003-02-06

[Important Notices](#)



Français	Contact us	Help	Search	Canada site
Coming events	About CBIF	Links	Reports and publications	Home

Canadian Biodiversity Information Facility



Notes on poisoning: blue cardinalflower

[Introduction](#)[Interactive](#)[All poisonous plants by Botanical name](#)[All poisonous plants by Common name](#)[Important WWW Poisonous Plants sites](#)

General poisoning notes:

Blue cardinalflower (*Lobelia siphilitica*) is a native herb found along wet river banks in southern Ontario. This plant contains an alkaloid, lobeline, that caused poisoning when the extract was used as a home remedy. For more information, see the notes under Indian- tobacco ([Lobelia inflata](#)).



References:

Lampe, K. F., McCann, M. A. 1985. AMA Handbook of poisonous and injurious plants. American Medical Assoc. Chicago, Ill., USA. 432 pp.

Nomenclature:

Scientific Name: *Lobelia siphilitica* L.

Vernacular name(s): blue cardinalflower

Scientific family name: *Campanulaceae*

Vernacular family name: bellflower

Go to ITIS*^{ca} for more taxonomic information on: [Lobelia siphilitica](#)

References:

Agriculture Quebec. 1975. Noms des maladies des plantes du Canada/ Names of plant diseases in Canada. , Quebec City, Que., Canada. 288 pp.

Alex, J. F., Cayouette, R., Mulligan, G. A. 1980. Common and botanical names of weeds in Canada/Noms populaire et scientifiques des plantes nuisibles du Canada. Revised. Agric. Can. Publ., Ottawa, Ont., Canada. 132 pp.

Bailey, L. H., Bailey, E. Z. 1976. Hortus third. Revised. MacMillan, New York, N.Y., USA. 1290 pp.

Scoggan, H. J. 1978, 1979. The flora of Canada. Nat. Mus. Nat. Sci. (Ottawa) Publ. Bot. 7(1)-7(4). 1711 pp.

Van Wijk, H. L. 1911. A dictionary of plant names. Martinus Nijhoff, The Hague, The Netherlands. 1444 pp.

Victorin, M. 1964. Flore Laurentienne. 2nd ed. Univ. Montreal, Montreal, Que., Canada. 952 pp.

Geographic Information

Ontario

References:

Bailey, L. H., Bailey, E. Z. 1976. Hortus third. Revised. MacMillan, New York, N.Y., USA. 1290 pp.

Boivin, B. 1966, 1967. Énumération des plantes du Canada. Provencheria 6. Nat. Can. (Que.) 93: 253-274; 371-437; 583-646; 989-1063. 94: 131-157; 471-528; 625-655.

Image or illustration

blue cardinalflower:

Images: images.google.com

Toxic parts:

leaves

stems

References:

Lampe, K. F., McCann, M. A. 1985. AMA Handbook of poisonous and injurious plants. American Medical Assoc. Chicago, Ill., USA. 432 pp.

Toxic plant chemicals:

lobeline

References:

Lampe, K. F., McCann, M. A. 1985. AMA Handbook of poisonous and injurious plants. American Medical Assoc.

Chicago, Ill., USA. 432 pp.

Animals/Human Poisoning:

Note: When an animal is listed without additional information, the literature (as of 1993) contained no detailed explanation.

Humans

[Another search?](#)

[Français](#) | [Contact Us](#) | [Help](#) | [Search](#) | [Canada site](#)

[Coming Events](#) | [About CBIF](#) | [Links](#) | [Reports and Publications](#) |

[Home](#)

Date modified: 2003-02-06

[Important Notices](#)



Français	Contact us	Help	Search	Canada site
Coming events	About CBIF	Links	Reports and publications	Home

Canadian Biodiversity Information Facility



Notes on poisoning: blue cohosh

[Introduction](#)[Interactive](#)[All poisonous plants by Botanical name](#)[All poisonous plants by Common name](#)[Important WWW Poisonous Plants sites](#)

General poisoning notes:

Blue cohosh (*Caulophyllum thalictroides*) is a native plant found in rich woods in eastern Canada. The plant contains chemicals that can cause cell damage. Experiments show that handling powdered root can cause irritation of mucous membranes, with possible dermatitis. No case histories of poisoning were found in the literature, but the plant has poisoning potential. Children should not be allowed to eat the attractive blue fruits of this plant (Muenscher 1975, Lampe and McCann 1985). No references were found of poisoning of livestock.

References:

Lampe, K. F., McCann, M. A. 1985. AMA Handbook of poisonous and injurious plants. American Medical Assoc. Chicago, Ill., USA. 432 pp.

Nomenclature:

Scientific Name: *Caulophyllum thalictroides* (L.) Michaux

Vernacular name(s): blue cohosh

Scientific family name: *Berberidaceae*

Vernacular family name: barberry

Go to ITIS*^{ca} for more taxonomic information on: [Caulophyllum thalictroides](#)

References:

Agriculture Quebec. 1975. Noms des maladies des plantes du Canada/ Names of plant diseases in Canada. , Quebec City, Que., Canada. 288 pp.

Alex, J. F., Cayouette, R., Mulligan, G. A. 1980. Common and botanical names of weeds in Canada/Noms populaire et scientifiques des plantes nuisibles du Canada. Revised. Agric. Can. Publ., Ottawa, Ont., Canada. 132 pp.

Bailey, L. H., Bailey, E. Z. 1976. Hortus third. Revised. MacMillan, New York, N.Y., USA. 1290 pp.

Scoggan, H. J. 1978, 1979. The flora of Canada. Nat. Mus. Nat. Sci. (Ottawa) Publ. Bot. 7(1)-7(4). 1711 pp.

Van Wijk, H. L. 1911. A dictionary of plant names. Martinus Nijhoff, The Hague, The Netherlands. 1444 pp.

Victorin, M. 1964. Flore Laurentienne. 2nd ed. Univ. Montreal, Montreal, Que., Canada. 952 pp.

Geographic Information

Manitoba
New Brunswick
Nova Scotia
Ontario
Quebec

References:

Bailey, L. H., Bailey, E. Z. 1976. Hortus third. Revised. MacMillan, New York, N.Y., USA. 1290 pp.

Boivin, B. 1966, 1967. Énumération des plantes du Canada. Provencheria 6. Nat. Can. (Que.) 93: 253-274; 371-437; 583-646; 989-1063. 94: 131-157; 471-528; 625-655.

Image or illustration

blue cohosh:

Images: images.google.com

Notes on Poisonous plant parts:

The berries and roots contain chemicals that are cytotoxic, causing cell damage. The plant is extremely bitter and is not usually ingested by livestock. (Muenscher 1975, Lampe and McCann 1985).

Toxic parts:

mature fruit
roots

References:

Lampe, K. F., McCann, M. A. 1985. AMA Handbook of poisonous and injurious plants. American Medical Assoc. Chicago, Ill., USA. 432 pp.

Muenschler, W. C. 1975. Poisonous plants of the United States. Revised. Collier Books, New York, N.Y., USA. 277 pp.

Notes on Toxic plant chemicals:

An alkaloid and saponins occur in this plant. The chemicals are cytotoxic, damaging animal cells. The plant is reported to have orally active oxytocic substances, which cause uterine contractions (Ferguson and Edwards 1954, Lampe and McCann 1985).

Toxic plant chemicals:

N-methylcytisine

References:

Lampe, K. F., McCann, M. A. 1985. AMA Handbook of poisonous and injurious plants. American Medical Assoc. Chicago, Ill., USA. 432 pp.

Animals/Human Poisoning:

Note: When an animal is listed without additional information, the literature (as of 1993) contained no detailed explanation.

Humans

General symptoms of poisoning:

[mouth, irritation of](#)

References:

Lampe, K. F., McCann, M. A. 1985. AMA Handbook of poisonous and injurious plants. American Medical Assoc. Chicago, Ill., USA. 432 pp.

[Another search?](#)

[Français](#) | [Contact Us](#) | [Help](#) | [Search](#) | [Canada site](#)

[Coming Events](#) | [About CBIF](#) | [Links](#) | [Reports and Publications](#) | [Home](#)

Date modified: 2003-02-06

[Important Notices](#)



Français	Contact us	Help	Search	Canada site
Coming events	About CBIF	Links	Reports and publications	Home

Canadian Biodiversity Information Facility



Notes on poisoning: blue flag iris

[Introduction](#)[Interactive](#)[All poisonous plants by Botanical name](#)[All poisonous plants by Common name](#)[Important WWW Poisonous Plants sites](#)

General poisoning notes:

Blue flag (*Iris versicolor*) is a native herb found in eastern and central Canada. This plant has been mentioned as causing poisoning in humans and animals, but case reports have not been found. The plant juice can cause dermatitis in sensitive individuals. Other iris species have also been implicated in poisoning of animals and in causing dermatitis in humans (see additional information under [Iris pseudacorus](#)). Because of the potential for poisoning, care should be taken to prevent access by livestock to blue flag, which grows in moist soils near rivers, lakes, and marshes (Fyles 1920, Cooper and Johnson 1984).

References:

Cooper, M. R., Johnson, A. W. 1984. Poisonous plants in Britain and their effects on animals and man. Her Majesty's Stationery Office, London, England. 305 pp.

Fyles, F. 1920. Principal poisonous plants of Canada. Can. Dep. Agric. Exp. Farms. Bull. 39. 112 pp.

Nomenclature:

Scientific Name: *Iris versicolor* L.

Vernacular name(s): blue flag iris

Scientific family name: *Iridaceae*

Vernacular family name: iris

Go to ITIS*^{ca} for more taxonomic information on: [Iris versicolor](#)

References:

Agriculture Quebec. 1975. Noms des maladies des plantes du

Canada/ Names of plant diseases in Canada. , Quebec City, Que., Canada. 288 pp.

Alex, J. F., Cayouette, R., Mulligan, G. A. 1980. Common and botanical names of weeds in Canada/Noms populaire et scientifiques des plantes nuisibles du Canada. Revised. Agric. Can. Publ., Ottawa, Ont., Canada. 132 pp.

Bailey, L. H., Bailey, E. Z. 1976. Hortus third. Revised. MacMillan, New York, N.Y., USA. 1290 pp.

Scoggan, H. J. 1978, 1979. The flora of Canada. Nat. Mus. Nat. Sci. (Ottawa) Publ. Bot. 7(1)-7(4). 1711 pp.

Van Wijk, H. L. 1911. A dictionary of plant names. Martinus Nijhoff, The Hague, The Netherlands. 1444 pp.

Victorin, M. 1964. Flore Laurentienne. 2nd ed. Univ. Montreal, Montreal, Que., Canada. 952 pp.

Geographic Information

British Columbia
Labrador
Manitoba
New Brunswick
Newfoundland
Northwest Territories
Nova Scotia
Ontario
Prince Edward Island
Quebec
Saskatchewan

References:

Bailey, L. H., Bailey, E. Z. 1976. Hortus third. Revised. MacMillan, New York, N.Y., USA. 1290 pp.

Boivin, B. 1966, 1967. Énumération des plantes du Canada. Provencheria 6. Nat. Can. (Que.) 93: 253-274; 371-437; 583-646; 989-1063. 94: 131-157; 471-528; 625-655.

Image or illustration

blue flag iris:

Images: images.google.com

Toxic parts:

rhizome

References:

Cooper, M. R., Johnson, A. W. 1984. Poisonous plants in Britain and their effects on animals and man. Her Majesty's Stationery Office, London, England. 305 pp.

Fyles, F. 1920. Principal poisonous plants of Canada. Can. Dep. Agric. Exp. Farms. Bull. 39. 112 pp.

Notes on Toxic plant chemicals:

A glycoside, iridin (or irisin), has been implicated as the toxic compound in iris species, although this has not been confirmed (Fyles 1920, Cooper and Johnson 1984).

Toxic plant chemicals:

iridin

References:

Cooper, M. R., Johnson, A. W. 1984. Poisonous plants in Britain and their effects on animals and man. Her Majesty's Stationery Office, London, England. 305 pp.

Fyles, F. 1920. Principal poisonous plants of Canada. Can. Dep. Agric. Exp. Farms. Bull. 39. 112 pp.

Animals/Human Poisoning:

Note: When an animal is listed without additional information, the literature (as of 1993) contained no detailed explanation.

Cattle

Humans

General symptoms of poisoning:

[abdominal pains](#)

[nausea](#)

[vomiting](#)

References:

Cooper, M. R., Johnson, A. W. 1984. Poisonous plants in Britain and their effects on animals and man. Her Majesty's Stationery Office, London, England. 305 pp.

Fyles, F. 1920. Principal poisonous plants of Canada. Can. Dep. Agric. Exp. Farms. Bull. 39. 112 pp.

[Another search?](#)

[Français](#) | [Contact Us](#) | [Help](#) | [Search](#) | [Canada site](#)

[Coming Events](#) | [About CBIF](#) | [Links](#) | [Reports and Publications](#) |

[Home](#)

Date modified: 2003-02-06

[Important Notices](#)



Français	Contact us	Help	Search	Canada site
Coming events	About CBIF	Links	Reports and publications	Home

Canadian Biodiversity Information Facility



Notes on poisoning: blueweed

[Introduction](#)

[Interactive](#)

[All poisonous plants by Botanical name](#)

[All poisonous plants by Common name](#)

[Important WWW Poisonous Plants sites](#)



General poisoning notes:

Blueweed (*Echium vulgare*) is a naturalized biennial herb found in fields and waste places across Canada. The bristly hairs on this plant cause skin irritation. There is no mention of whether the irritation is purely mechanical or whether it is caused by chemicals in the hairs on the leaves and stems. This plant may also contain pyrrolizidine alkaloids including heliosupine (Cheeke 1989, Cooper and Johnson 1984). Poisoning by this plant has not been reported. Purple bugloss (*Echium lycopsis* L. = *Echium plantagineum* L.) has been collected in Canada on a couple of occasions, but it does not persist. This species does contain several pyrrolizidine alkaloids, including echimidine, echiumine, and heliotrine. The plant has caused death of horses and liver damage of sheep in Australia (Cooper and Johnson 1984, Cheeke 1989). Lampe and McCann (1985) discuss toxicity of both species to humans after ingestion of herbal teas containing *Echium* spp. Chronic consumption can cause veno-occlusive disease of the liver (Budd-Chiari syndrome), with hepatic vein thrombosis leading to cirrhosis. Purple bugloss (*Echium lycopsis*), which is discussed above, contains chemicals that can cause this type of problem. However, it does not appear to persist in Canada. There is no information in the literature on blueweed causing such poisoning, but it may contain pyrrolizidine alkaloids (Cheeke 1989). Caution is obviously warranted. Teas containing either of these plants should not be used by humans.

References:

Cheeke, P. R. 1989. Pyrrolizidine alkaloid toxicity and metabolism in laboratory animals and livestock. Pages 1-22 in Cheeke, P. R., ed. Toxicants of plant origin. Vol. I. Alkaloids. CRC Press, Inc., Boca Raton, Fla., USA. 335 pp.

Cooper, M. R., Johnson, A. W. 1984. Poisonous plants in Britain

and their effects on animals and man. Her Majesty's Stationery Office, London, England. 305 pp.

Lampe, K. F., McCann, M. A. 1985. AMA Handbook of poisonous and injurious plants. American Medical Assoc. Chicago, Ill., USA. 432 pp.

Nomenclature:

Scientific Name: *Echium vulgare* L.

Vernacular name(s): blueweed

Scientific family name: *Boraginaceae*

Vernacular family name: borage

Go to ITIS^{*ca} for more taxonomic information on: [Echium vulgare](#)

References:

Agriculture Quebec. 1975. Noms des maladies des plantes du Canada/ Names of plant diseases in Canada. , Quebec City, Que., Canada. 288 pp.

Alex, J. F., Cayouette, R., Mulligan, G. A. 1980. Common and botanical names of weeds in Canada/Noms populaire et scientifiques des plantes nuisibles du Canada. Revised. Agric. Can. Publ., Ottawa, Ont., Canada. 132 pp.

Bailey, L. H., Bailey, E. Z. 1976. Hortus third. Revised. MacMillan, New York, N.Y., USA. 1290 pp.

Scoggan, H. J. 1978, 1979. The flora of Canada. Nat. Mus. Nat. Sci. (Ottawa) Publ. Bot. 7(1)-7(4). 1711 pp.

Van Wijk, H. L. 1911. A dictionary of plant names. Martinus Nijhoff, The Hague, The Netherlands. 1444 pp.

Victorin, M. 1964. Flore Laurentienne. 2nd ed. Univ. Montreal, Montreal, Que., Canada. 952 pp.

Geographic Information

Alberta
British Columbia
Manitoba
New Brunswick
Newfoundland
Nova Scotia
Ontario
Quebec

Saskatchewan

References:

Bailey, L. H., Bailey, E. Z. 1976. Hortus third. Revised. MacMillan, New York, N.Y., USA. 1290 pp.

Boivin, B. 1966, 1967. Énumération des plantes du Canada. Provencheria 6. Nat. Can. (Que.) 93: 253-274; 371-437; 583-646; 989-1063. 94: 131-157; 471-528; 625-655.

Image or illustration

blueweed:

Images: images.google.com

Notes on Poisonous plant parts:

The bristly hairs covering the stem and leaves produce severe inflammation when they break off and become imbedded in the skin (Muenscher 1975).

Toxic parts:

hairs

References:

Lampe, K. F., McCann, M. A. 1985. AMA Handbook of poisonous and injurious plants. American Medical Assoc. Chicago, Ill., USA. 432 pp.

Notes on Toxic plant chemicals:

Cheeke (1989) mentions that blueweed contains pyrrolizidine alkaloids, but no further information is given. Another member of the genus (*Echium lycopsis*) contains several alkaloids that have caused poisoning of animals in Australia.

Toxic plant chemicals:

unknown chemical

References:

Lampe, K. F., McCann, M. A. 1985. AMA Handbook of poisonous and injurious plants. American Medical Assoc. Chicago, Ill., USA. 432 pp.

Animals/Human Poisoning:

Note: When an animal is listed without additional information, the literature (as of 1993) contained no detailed explanation.

Humans

General symptoms of poisoning:

[itchiness](#)

Notes on poisoning:

The hairs on blueweed cause intense itchiness and skin irritation (Muenscher 1975).

References:

Lampe, K. F., McCann, M. A. 1985. AMA Handbook of poisonous and injurious plants. American Medical Assoc. Chicago, Ill., USA. 432 pp.

[Another search?](#)

[Français](#) | [Contact Us](#) | [Help](#) | [Search](#) | [Canada site](#)

[Coming Events](#) | [About CBIF](#) | [Links](#) | [Reports and Publications](#) |

[Home](#)

Date modified: 2003-02-06

[Important Notices](#)



Français	Contact us	Help	Search	Canada site
Coming events	About CBIF	Links	Reports and publications	Home

Canadian Biodiversity Information Facility



Notes on poisoning: bog-laurel

[Introduction](#)[Interactive](#)[All poisonous plants by
Botanical name](#)[All poisonous plants by
Common name](#)[Important WWW Poisonous
Plants sites](#)

General poisoning notes:

Bog-laurel (*Kalmia polifolia*) is a native shrub found across Canada in boggy areas. The plant has caused experimental poisoning in cattle, goats, and sheep, with sheep being most susceptible. Suspected poisoning of cattle and sheep in the west have been reported. Bog-laurel is less toxic than sheep-laurel (*Kalmia angustifolia*). Only the western variety of bog-laurel (*Kalmia polifolia* var. *microphylla*) has been tested for toxicity. However, the plant should be considered potentially toxic through its entire range in Canada (Clawson 1933, Kingsbury 1964, Lampe and McCann 1985).



References:

Clawson, A. B. 1933. Alpine kalmia (*Kalmia microphylla*) as a stock-poisoning plant. U. S. Dep. Agric. Tech. Bull., 391. 10 pp.

Kingsbury, J. M. 1964. Poisonous plants of the United States and Canada. Prentice-Hall Inc., Englewood Cliffs, N.J., USA. 626 pp.

Lampe, K. F., McCann, M. A. 1985. AMA Handbook of poisonous and injurious plants. American Medical Assoc. Chicago, Ill., USA. 432 pp.

Nomenclature:

Scientific Name: *Kalmia polifolia* Wang

Vernacular name(s): bog-laurel

Scientific family name: *Ericaceae*

Vernacular family name: heath

Go to ITIS^{*ca} for more taxonomic information on: [Kalmia polifolia](#)

References:

Agriculture Quebec. 1975. Noms des maladies des plantes du Canada/
Names of plant diseases in Canada. , Quebec City, Que., Canada. 288 pp.

Alex, J. F., Cayouette, R., Mulligan, G. A. 1980. Common and botanical
names of weeds in Canada/Noms populaire et scientifiques des plantes
nuisibles du Canada. Revised. Agric. Can. Publ., Ottawa, Ont., Canada.
132 pp.

Bailey, L. H., Bailey, E. Z. 1976. Hortus third. Revised. MacMillan, New
York, N.Y., USA. 1290 pp.

Scoggan, H. J. 1978, 1979. The flora of Canada. Nat. Mus. Nat. Sci.
(Ottawa) Publ. Bot. 7(1)-7(4). 1711 pp.

Van Wijk, H. L. 1911. A dictionary of plant names. Martinus Nijhoff, The
Hague, The Netherlands. 1444 pp.

Victorin, M. 1964. Flore Laurentienne. 2nd ed. Univ. Montreal, Montreal,
Que., Canada. 952 pp.

Geographic Information

Alberta
British Columbia
Labrador
Manitoba
New Brunswick
Newfoundland
Northwest Territories
Nova Scotia
Ontario
Prince Edward Island
Quebec
Saskatchewan
Yukon Territory

References:

Bailey, L. H., Bailey, E. Z. 1976. Hortus third. Revised. MacMillan, New
York, N.Y., USA. 1290 pp.

Boivin, B. 1966, 1967. Énumération des plantes du Canada. Provencheria
6. Nat. Can. (Que.) 93: 253-274; 371-437; 583-646; 989-1063. 94:
131-157; 471-528; 625-655.

Image or illustration

bog-laurel:

Images: images.google.com

Notes on Poisonous plant parts:

All parts of the plant are poisonous including the nectar, which can result in poisonous honey. The leaves have been used in experiments to poison livestock (Clawson 1933, Fuller and McClintock 1986).

Toxic parts:

all parts
leaves
stems

References:

Clawson, A. B. 1933. Alpine kalmia (*Kalmia microphylla*) as a stock-poisoning plant. U. S. Dep. Agric. Tech. Bull., 391. 10 pp.

Fuller, T. C., McClintock, E. 1986. Poisonous plants of California. Univ. California Press, Berkeley, Calif., USA. 432 pp.

Notes on Toxic plant chemicals:

Andromedotoxins (grayanotoxins) are resins derived from diterpenes. Several have been found in many members of the heath family and are toxic if sufficient vegetation is eaten (Kakisawa et al. 1965, Fuller and McClintock 1986).

Toxic plant chemicals:

andromedotoxins

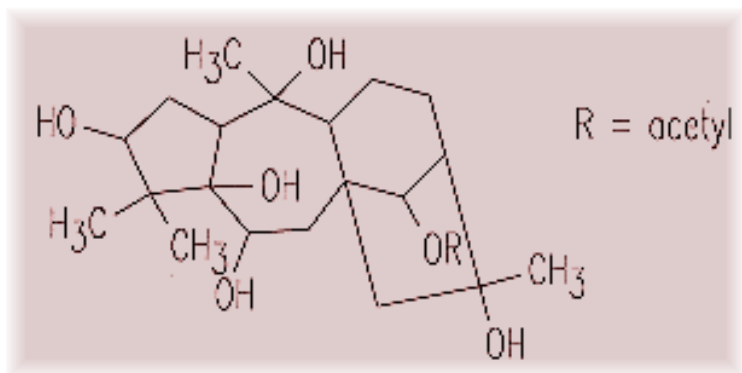

Chemical diagram(s) are courtesy of [Ruth McDiarmid](#), Biochemistry Technician, Kamloops Range Station, Agriculture and Agri-Food Canada, Kamloops, British Columbia, Canada.

References:

Clawson, A. B. 1933. Alpine kalmia (*Kalmia microphylla*) as a

stock-poisoning plant. U. S. Dep. Agric. Tech. Bull., 391. 10 pp.

Fuller, T. C., McClintock, E. 1986. Poisonous plants of California. Univ. California Press, Berkeley, Calif., USA. 432 pp.

Kakisawa, H., Kozima, T., Yanai, M., Nakanishi, K. 1965. Stereochemistry of grayanotoxins. Tetrahedron, 21: 3091-3104.

Animals/Human Poisoning:

Note: When an animal is listed without additional information, the literature (as of 1993) contained no detailed explanation.

Cattle

Goats

General symptoms of poisoning:

[depression](#)

[nausea](#)

[salivation](#)

[vomiting](#)

Notes on poisoning:

Experimental poisoning of sheep caused such symptoms as depression, salivation, loss of appetite, and vomiting. Grating of teeth and frequent vomiting was noticed in more severe cases. Pulse and body temperature was affected very little. A dosage of green leaves equal to 0.3% of an animal's body weight can cause a toxic response. A dosage of 2% of an animal's body weight caused severe sickness in sheep (Clawson 1933).

References:

Clawson, A. B. 1933. Alpine kalmia (*Kalmia microphylla*) as a stock-poisoning plant. U. S. Dep. Agric. Tech. Bull., 391. 10 pp.

Kingsbury, J. M. 1964. Poisonous plants of the United States and Canada. Prentice-Hall Inc., Englewood Cliffs, N.J., USA. 626 pp.

Sheep

General symptoms of poisoning:

[depression](#)

[gait, staggering](#)

[nausea](#)

[recumbency](#)

[salivation](#)

[vomiting](#)

Notes on poisoning:

Experimental poisoning of sheep caused such symptoms as depression, salivation, loss of appetite, and vomiting. Grating of teeth and frequent vomiting was noticed in more severe cases. Pulse and body temperature was affected very little. A dosage of green leaves equal to 0.3% of an animal's body weight can cause a toxic response. A dosage of 2% of an animal's body weight caused severe sickness in sheep (Clawson 1933).

References:

Clawson, A. B. 1933. Alpine kalmia (*Kalmia microphylla*) as a stock-poisoning plant. U. S. Dep. Agric. Tech. Bull., 391. 10 pp.

Kingsbury, J. M. 1964. Poisonous plants of the United States and Canada. Prentice-Hall Inc., Englewood Cliffs, N.J., USA. 626 pp.

[Another search?](#)

[Français](#) | [Contact Us](#) | [Help](#) | [Search](#) | [Canada site](#)

[Coming Events](#) | [About CBIF](#) | [Links](#) | [Reports and Publications](#) | [Home](#)

Date modified: 2003-02-06

[Important Notices](#)



Français	Contact us	Help	Search	Canada site
Coming events	About CBIF	Links	Reports and publications	Home

Canadian Biodiversity Information Facility



Notes on poisoning: bracken

[Introduction](#)

[Interactive](#)

[All poisonous plants by Botanical name](#)

[All poisonous plants by Common name](#)

[Important WWW Poisonous Plants sites](#)



General poisoning notes:

Bracken (*Pteridium aquilinum*) is a native fern that grows across most of Canada. This fern has caused sickness and loss of cattle in Canada and in other countries. Cattle, sheep, and wild animals have also been poisoned after ingesting bracken. Bracken contains several chemicals that cause problems. Thiaminase results in vitamin B1 deficiency in nonruminants such as horses and swine. Ptaquiloside, a carcinogen-mutagen, causes acute and chronic symptoms of illness in ruminants. The spores may contain carcinogens that can cause problems to animals and humans. The young fronds of bracken are ingested as human food, especially in Japan. They contain significant quantities of the carcinogen (Cheeke and Schull 1985, Fenwick 1988, Hirono 1989).

References:

[Cody, W. J., Crompton, C. W.](#) 1975. The biology of Canadian weeds. 15. *Pteridium aquilinum* (L.) Kuhn. Can. J. Plant Sci., 55: 1059-1072.

Cheeke, P. R., Shull, L. R. 1985. Natural toxicants in feeds and poisonous plants. AVI Publishing Company, Inc., Westport, Conn., USA. 492 pp.

Evans, I. A. 1976. Relationship between bracken and cancer. Bot. Linn. Soc., 73: 105-112.

Fenwick, G. R. 1988. Bracken (*Pteridium aquilinum*) - toxic effects and toxic constituents. J. Sci. Food Agric., 46: 147-173.

Hirono, I. 1989. Carcinogenic bracken glycosides. Pages 239-251 in Cheeke, P. R., ed. Toxicants of plant origin. Vol. II. Glycosides. CRC Press, Inc., Boca Raton, Fla., USA. 277 pp.

Hopkins, A. 1990. Bracken (*Pteridium aquilinum*): its distribution and animal health implications. Agric. Can. Res.

Branch Contrib., 146: 316-326.

Kelleway, R. A., Geovjian, L. 1978. Acute bracken fern poisoning in a 14-month-old horse. *Vet. Med. Small Anim. Clin.*, 73: 295-296.

Milne, R. 1988. Heathlands of England harbour cancer spores. *New Sci.*, 118: 23.

Nomenclature:

Scientific Name: *Pteridium aquilinum* (L.) Kuhn

Vernacular name(s): bracken

Scientific family name: *Polypodiaceae*

Vernacular family name: fern

Go to ITIS^{*ca} for more taxonomic information on: [Pteridium aquilinum](#)

References:

Agriculture Quebec. 1975. Noms des maladies des plantes du Canada/ Names of plant diseases in Canada. , Quebec City, Que., Canada. 288 pp.

Alex, J. F., Cayouette, R., Mulligan, G. A. 1980. Common and botanical names of weeds in Canada/Noms populaire et scientifiques des plantes nuisibles du Canada. Revised. Agric. Can. Publ., Ottawa, Ont., Canada. 132 pp.

Bailey, L. H., Bailey, E. Z. 1976. Hortus third. Revised. MacMillan, New York, N.Y., USA. 1290 pp.

Scoggan, H. J. 1978, 1979. The flora of Canada. Nat. Mus. Nat. Sci. (Ottawa) Publ. Bot. 7(1)-7(4). 1711 pp.

Van Wijk, H. L. 1911. A dictionary of plant names. Martinus Nijhoff, The Hague, The Netherlands. 1444 pp.

Victorin, M. 1964. Flore Laurentienne. 2nd ed. Univ. Montreal, Montreal, Que., Canada. 952 pp.

Geographic Information

Alberta
British Columbia
Labrador
Manitoba
New Brunswick
Newfoundland

Nova Scotia
Ontario
Prince Edward Island
Quebec

References:

Bailey, L. H., Bailey, E. Z. 1976. Hortus third. Revised. MacMillan, New York, N.Y., USA. 1290 pp.

Boivin, B. 1966, 1967. Énumération des plantes du Canada. Provencheria 6. Nat. Can. (Que.) 93: 253-274; 371-437; 583-646; 989-1063. 94: 131-157; 471-528; 625-655.

Image or illustration

bracken:

Images: images.google.com

Notes on Poisonous plant parts:

All parts of bracken contain toxic chemicals. Ingesting fresh or dry fronds (leaves) or underground rhizomes has caused toxic signs and death in ruminants and nonruminants. After ingesting the young fronds, animals were found to be affected by carcinogenic compounds that the young fronds contain; these compounds may also cause problems in humans. The spores appear to be the most carcinogenic part of bracken and may cause problems in livestock. Humans who work outdoors in areas where bracken grows abundantly could also be at risk from the spores (Milne and Fenwick 1988, Milne 1988, Hirono 1989).

Toxic parts:

all parts
leaves
rhizome
spores
young shoots

References:

Fenwick, G. R. 1988. Bracken (*Pteridium aquilinum*) - toxic effects and toxic constituents. J. Sci. Food Agric., 46: 147-173.

Hirono, I. 1989. Carcinogenic bracken glycosides. Pages 239-251 in Cheeke, P. R., ed. Toxicants of plant origin. Vol. II. Glycosides. CRC Press, Inc., Boca Raton, Fla., USA. 277 pp.

Notes on Toxic plant chemicals:

A group of chemical compounds have been implicated in the various toxic properties of bracken. Thiaminase, an enzyme that decomposes vitamin B1, has caused toxic problems, particularly in nonruminants, which cannot synthesize their own vitamin B1. Ptaquiloside and aquilide A possess an unusual, planar, illudane norsesquiterpene skeleton. Under alkaline conditions these chemicals yield pterodin B, a proximate carcinogen-mutagen. Pterodin B has been implicated as a cause of the cancers noted after bracken ingestion, and ptaquiloside has been implicated as a contributor to the toxic signs in ruminant animals (Cheeke and Schull 1988, Fenwick 1988). Bracken also contains prunasin, a cyanogenic glycoside, which appears to be a deterrent to herbivory (Tewe and Iyayi 1989).

Toxic plant chemicals:

aquilide A
prunasin

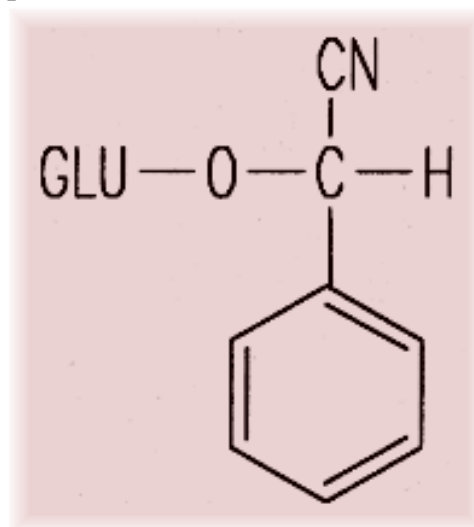

ptaquiloside

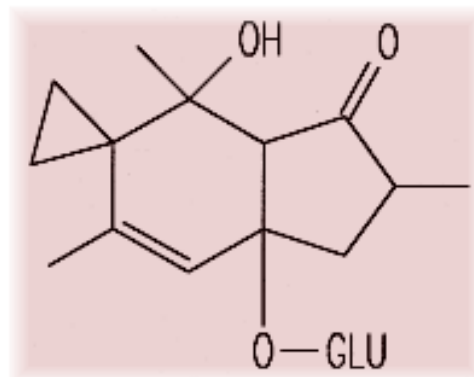

thiaminase

Chemical diagram(s) are courtesy of [Ruth McDiarmid](#),

Biochemistry Technician, Kamloops Range Station, Agriculture and Agri-Food Canada, Kamloops, British Columbia, Canada.

References:

Cheeke, P. R., Shull, L. R. 1985. Natural toxicants in feeds and poisonous plants. AVI Publishing Company, Inc., Westport, Conn., USA. 492 pp.

Fenwick, G. R. 1988. Bracken (*Pteridium aquilinum*) - toxic effects and toxic constituents. J. Sci. Food Agric., 46: 147-173.

Hirono, I. 1989. Carcinogenic bracken glycosides. Pages 239-251 in Cheeke, P. R., ed. Toxicants of plant origin. Vol. II. Glycosides. CRC Press, Inc., Boca Raton, Fla., USA. 277 pp.

Tewe, O. O., Iyayi, E. A. 1989. Cyanogenic glycosides. Pages 43-60 in Cheeke, P. R., ed. Toxicants of plant origin. Vol. II. Glycosides. CRC Press, Inc., Boca Raton, Fla., USA. 277 pp.

Animals/Human Poisoning:

Note: When an animal is listed without additional information, the literature (as of 1993) contained no detailed explanation.

Cattle

General symptoms of poisoning:

[anemia](#)

[bone marrow damage](#)

[cancer and tumors](#)

[death](#)

[hemorrhage](#)

Notes on poisoning:

Consuming significant quantities of bracken fronds can cause bracken poisoning, which results in bone marrow damage. Only small foci of erythropoietic cells and some megakaryocytes remain. Hemorrhaging occurs, with blood in the feces and bleeding from the nose, vagina, and membranes around the mouth and eyes. Postmortem examination shows hemorrhaging in the stomach, intestines, lungs, and heart (Cheeke and Schull 1985, Fenwick 1988, Hirono 1989).

References:

Cheeke, P. R., Shull, L. R. 1985. Natural toxicants in feeds and poisonous plants. AVI Publishing Company, Inc., Westport, Conn., USA. 492 pp.

Fenwick, G. R. 1988. Bracken (*Pteridium aquilinum*) - toxic effects and toxic constituents. J. Sci. Food Agric., 46: 147-173.

Hirono, I. 1989. Carcinogenic bracken glycosides. Pages 239-251 in Cheeke, P. R., ed. Toxicants of plant origin. Vol. II. Glycosides. CRC Press, Inc., Boca Raton, Fla., USA. 277 pp.

Horses

General symptoms of poisoning:

[anemia](#)

[anorexia](#)

[ataxia](#)

[colic](#)

[convulsions](#)

[death](#)

[gait, staggering](#)

[incoordination](#)

[opisthotonos](#)

[recumbency](#)

[weight loss](#)

References:

Cheeke, P. R., Shull, L. R. 1985. Natural toxicants in feeds and poisonous plants. AVI Publishing Company, Inc., Westport, Conn., USA. 492 pp.

Fenwick, G. R. 1988. Bracken (*Pteridium aquilinum*) - toxic effects and toxic constituents. J. Sci. Food Agric., 46: 147-173.

Kelleway, R. A., Geovjian, L. 1978. Acute bracken fern poisoning in a 14-month-old horse. Vet. Med. Small Anim. Clin., 73: 295-296.

Humans

General symptoms of poisoning:

[cancer and tumors](#)

Notes on poisoning:

The young fronds of bracken have been used as a food source, particularly in Japan. Ptaquiloside, a carcinogenic compound, has been found in bracken. The toxin is especially abundant in the young fronds. If the fronds are not processed in any way, tumor incidence in rats is 78%. After the fronds are processed with boiling water or are boiled with wood ash, sodium bicarbonate, or

salt, the incidence of cancer is reduced to 4-25%. Mammary cancer and ileal and urinary bladder tumors were observed. Cattle develop urinary papilloma. The carcinogen can be transferred by milk. The high incidence of stomach cancer in Japan may be partly due to the consumption of bracken (Cheeke and Schull 1985, Hirono 1989).

References:

Cheeke, P. R., Shull, L. R. 1985. Natural toxicants in feeds and poisonous plants. AVI Publishing Company, Inc., Westport, Conn., USA. 492 pp.

Hirono, I. 1989. Carcinogenic bracken glycosides. Pages 239-251 in Cheeke, P. R., ed. Toxicants of plant origin. Vol. II. Glycosides. CRC Press, Inc., Boca Raton, Fla., USA. 277 pp.

Milne, R. 1988. Heathlands of England harbour cancer spores. New Sci., 118: 23.

Sheep

General symptoms of poisoning:

[blindness](#)

Notes on poisoning:

Sheep in the British Isles have developed a condition called bright blindness. The sheep develop degeneration of the neuroepithelium of the retina, with low counts of blood platelets and white blood cells. This problem has been linked to the consumption of bracken. Cattle with similar symptoms have been reported (Fenwick 1989).

References:

Cheeke, P. R., Shull, L. R. 1985. Natural toxicants in feeds and poisonous plants. AVI Publishing Company, Inc., Westport, Conn., USA. 492 pp.

Swine

General symptoms of poisoning:

[appetite, loss of](#)
[death](#)

Notes on poisoning:

Reports of acute bracken poisoning in swine are infrequent, perhaps because of few symptoms. The symptoms are similar to

heart failure. Experimental feeding of dry, powdered rhizomes produced loss of appetite after 8 weeks, followed by rapid deterioration and death 2 weeks later. Postmortem findings revealed damage to the heart. Ingestion by pregnant sows resulted in some death of the piglets after birth (Fenwick 1988).

References:

Fenwick, G. R. 1988. Bracken (*Pteridium aquilinum*) - toxic effects and toxic constituents. J. Sci. Food Agric., 46: 147-173.

[Another search?](#)

[Français](#) | [Contact Us](#) | [Help](#) | [Search](#) | [Canada site](#)

[Coming Events](#) | [About CBIF](#) | [Links](#) | [Reports and Publications](#) |

[Home](#)

Date modified: 2003-02-06

[Important Notices](#)



Français	Contact us	Help	Search	Canada site
Coming events	About CBIF	Links	Reports and publications	Home

Canadian Biodiversity Information Facility



Notes on poisoning: broad bean

[Introduction](#)

[Interactive](#)

[All poisonous plants by Botanical name](#)

[All poisonous plants by Common name](#)

[Important WWW Poisonous Plants sites](#)



General poisoning notes:

Broad bean (*Vicia faba*) is a cultivated plant that is grown occasionally in Canada. The beans are used as human food and are being evaluated as a protein supplement for livestock. Broad beans are not poisonous to humans in the conventional sense, but they cause favism in susceptible individuals. These individuals have a genetically transmitted, male sex-linked deficiency to the enzyme glucose-6-phosphate dehydrogenase. Certain groups such as Oriental Jews, Mediterranean Europeans, Arabs, Asians, and blacks may have the deficiency. The disease can cause death in severe cases. Livestock, including swine, have also been poisoned from ingesting high quantities of beans. Dietary broad beans can also cause metabolic problems in poultry. It is important to note that nonsusceptible persons who eat broad beans are not at risk (Kingsbury 1964, Cooper and Johnson 1984, Cheeke and Schull 1985, Roy and Spencer 1989).

References:

Cheeke, P. R., Shull, L. R. 1985. Natural toxicants in feeds and poisonous plants. AVI Publishing Company, Inc., Westport, Conn., USA. 492 pp.

Cooper, M. R., Johnson, A. W. 1984. Poisonous plants in Britain and their effects on animals and man. Her Majesty's Stationery Office, London, England. 305 pp.

Kingsbury, J. M. 1964. Poisonous plants of the United States and Canada. Prentice-Hall Inc., Englewood Cliffs, N.J., USA. 626 pp.

Liener, I. E. 1989. Antinutritional factors. Pages 339-382 in Matthews, R. H., ed. Legumes: chemistry, technology, and human nutrition. Marcel Dekker, Inc., New York, N.Y., USA. 934 pp.

Nomenclature:

Scientific Name: *Vicia faba* L.

Vernacular name(s): broad bean

Scientific family name: *Leguminosae*

Vernacular family name: pea

Go to ITIS^{*ca} for more taxonomic information on: [Vicia faba](#)

References:

Agriculture Quebec. 1975. Noms des maladies des plantes du Canada/ Names of plant diseases in Canada. , Quebec City, Que., Canada. 288 pp.

Alex, J. F., Cayouette, R., Mulligan, G. A. 1980. Common and botanical names of weeds in Canada/Noms populaire et scientifiques des plantes nuisibles du Canada. Revised. Agric. Can. Publ., Ottawa, Ont., Canada. 132 pp.

Bailey, L. H., Bailey, E. Z. 1976. Hortus third. Revised. MacMillan, New York, N.Y., USA. 1290 pp.

Scoggan, H. J. 1978, 1979. The flora of Canada. Nat. Mus. Nat. Sci. (Ottawa) Publ. Bot. 7(1)-7(4). 1711 pp.

Van Wijk, H. L. 1911. A dictionary of plant names. Martinus Nijhoff, The Hague, The Netherlands. 1444 pp.

Victorin, M. 1964. Flore Laurentienne. 2nd ed. Univ. Montreal, Montreal, Que., Canada. 952 pp.

Geographic Information

Plant or plant parts used in or around the home.

References:

Bailey, L. H., Bailey, E. Z. 1976. Hortus third. Revised. MacMillan, New York, N.Y., USA. 1290 pp.

Boivin, B. 1966, 1967. Énumération des plantes du Canada. Provencheria 6. Nat. Can. (Que.) 93: 253-274; 371-437; 583-646; 989-1063. 94: 131-157; 471-528; 625-655.

Image or illustration

broad bean:

Images: images.google.com

Notes on Poisonous plant parts:

Susceptible individuals who ingest raw or partly cooked seeds and inhale pollen can be poisoned (Cooper and Johnson 1984).

Toxic parts:

pollen
seeds

References:

Cooper, M. R., Johnson, A. W. 1984. Poisonous plants in Britain and their effects on animals and man. Her Majesty's Stationery Office, London, England. 305 pp.

Notes on Toxic plant chemicals:

Two glycosides, convicine and vicine, and their respective aglycones, isouramil and divicine, are implicated in favism. In individuals with glucose-6-phosphate dehydrogenase (G6PD) deficiency, a cycle is prevented that would normally reduce the oxidants so that they cannot attack the red cell membrane (Cheeke and Schull 1985).

Toxic plant chemicals:

convicine
vicine

References:

Cheeke, P. R., Shull, L. R. 1985. Natural toxicants in feeds and poisonous plants. AVI Publishing Company, Inc., Westport, Conn., USA. 492 pp.

Liener, I. E. 1989. Antinutritional factors. Pages 339-382 in Matthews, R. H., ed. Legumes: chemistry, technology, and human nutrition. Marcel Dekker, Inc., New York, N.Y., USA. 934 pp.

Animals/Human Poisoning:

Note: When an animal is listed without additional information, the literature (as of 1993) contained no detailed explanation.

Chickens

General symptoms of poisoning:

[egg production, reduced](#)

Notes on poisoning:

Unprocessed broad beans contain factors that lower the rate of chicken growth and alter the size of liver and pancreas. Dietary broad beans have a marked influence on the metabolism of laying hens. Vicine, which is thermostable, causes a reduction in the number of ova, in egg weight, in fertility, and in egg hatchability (Cheeke and Schull 1985).

References:

Cheeke, P. R., Shull, L. R. 1985. Natural toxicants in feeds and poisonous plants. AVI Publishing Company, Inc., Westport, Conn., USA. 492 pp.

Humans

General symptoms of poisoning:

[abdominal pains](#)

[collapse](#)

[death](#)

[dizziness](#)

[Heinz bodies](#)

[hemoglobinuria](#)

[icterus](#)

[jaundice](#)

[methemoglobinemia](#)

[temperature, elevated](#)

[vomiting](#)

References:

Cheeke, P. R., Shull, L. R. 1985. Natural toxicants in feeds and poisonous plants. AVI Publishing Company, Inc., Westport, Conn., USA. 492 pp.

Cooper, M. R., Johnson, A. W. 1984. Poisonous plants in Britain and their effects on animals and man. Her Majesty's Stationery Office, London, England. 305 pp.

Swine

General symptoms of poisoning:

[abdominal pains](#)

[appetite, loss of](#)

[constipation](#)

[depression](#)

Notes on poisoning:

Broad beans are used as animal feed as silage or are added to feed. However, in one case in Poland, pigs were poisoned after eating broad beans as one-third of their diet. Symptoms included depression, reduced activity, flatulence, and constipation. Postmortem examination revealed inflammation of the alimentary tract and pale yellow liver and kidneys (Cooper and Johnson 1984).

References:

Cooper, M. R., Johnson, A. W. 1984. Poisonous plants in Britain and their effects on animals and man. Her Majesty's Stationery Office, London, England. 305 pp.

[Another search?](#)

[Français](#) | [Contact Us](#) | [Help](#) | [Search](#) | [Canada site](#)

[Coming Events](#) | [About CBIF](#) | [Links](#) | [Reports and Publications](#) | [Home](#)

Date modified: 2003-02-06

[Important Notices](#)



Français	Contact us	Help	Search	Canada site
Coming events	About CBIF	Links	Reports and publications	Home

Canadian Biodiversity Information Facility



Notes on poisoning: broom snakeweed

[Introduction](#)

[Interactive](#)

[All poisonous plants by Botanical name](#)

[All poisonous plants by Common name](#)

[Important WWW Poisonous Plants sites](#)



General poisoning notes:

Broom snakeweed (*Gutierrezia sarothrae*) is a native perennial found in western rangelands. This plant has caused acute toxicity and abortion in cattle, which has also been experimentally induced in goats and sheep. The plant is more toxic during the early stages of growth and if it grows on poor, sandy soils. Major losses of cattle through acute toxicity and abortion have occurred in the southern United States, in Texas, and in New Mexico (Kingsbury 1964, Molyneux et al. 1980).

References:

Kingsbury, J. M. 1964. Poisonous plants of the United States and Canada. Prentice-Hall Inc., Englewood Cliffs, N.J., USA. 626 pp.

Molyneux, R. J., Stevens, K. L., James, L. F. 1980. Chemistry of toxic range plants. Volatile constituents of broomweed (*Gutierrezia sarothrae*). J. Agric. Food Chem., 28: 1332-1333.

Ralphs, M. H. 1985. Poisonous plants: the snakeweeds. Rangelands, 7(2): 63-65.

Nomenclature:

Scientific Name: *Gutierrezia sarothrae* (Pursh) Britton & Rusby

Vernacular name(s): broom snakeweed

Scientific family name: *Compositae*

Vernacular family name: composite

Go to ITIS^{*ca} for more taxonomic information on: [Gutierrezia sarothrae](#)

References:

Agriculture Quebec. 1975. Noms des maladies des plantes du Canada/ Names of plant diseases in Canada. , Quebec City, Que., Canada. 288 pp.

Alex, J. F., Cayouette, R., Mulligan, G. A. 1980. Common and botanical names of weeds in Canada/Noms populaire et scientifiques des plantes nuisibles du Canada. Revised. Agric. Can. Publ., Ottawa, Ont., Canada. 132 pp.

Bailey, L. H., Bailey, E. Z. 1976. Hortus third. Revised. MacMillan, New York, N.Y., USA. 1290 pp.

Scoggan, H. J. 1978, 1979. The flora of Canada. Nat. Mus. Nat. Sci. (Ottawa) Publ. Bot. 7(1)-7(4). 1711 pp.

Van Wijk, H. L. 1911. A dictionary of plant names. Martinus Nijhoff, The Hague, The Netherlands. 1444 pp.

Victorin, M. 1964. Flore Laurentienne. 2nd ed. Univ. Montreal, Montreal, Que., Canada. 952 pp.

Geographic Information

Alberta
Manitoba
Saskatchewan

References:

Bailey, L. H., Bailey, E. Z. 1976. Hortus third. Revised. MacMillan, New York, N.Y., USA. 1290 pp.

Boivin, B. 1966, 1967. Énumération des plantes du Canada. Provencheria 6. Nat. Can. (Que.) 93: 253-274; 371-437; 583-646; 989-1063. 94: 131-157; 471-528; 625-655.

Image or illustration

broom snakeweed:

Images: images.google.com

Notes on Poisonous plant parts:

As little as 9 kg of fresh broom snakeweed has produced abortion in cattle within 7 days. Death has been experimentally produced in cattle, sheep, and goats by feeding fresh plants equivalent to 10-20% of body weight for 3 days to 2 weeks (Kingsbury 1964).

Toxic parts:

leaves
stems

References:

Kingsbury, J. M. 1964. Poisonous plants of the United States and Canada. Prentice-Hall Inc., Englewood Cliffs, N.J., USA. 626 pp.

Molyneux, R. J., Stevens, K. L., James, L. F. 1980. Chemistry of toxic range plants. Volatile constituents of broomweed (*Gutierrezia sarothrae*). J. Agric. Food Chem., 28: 1332-1333.

Notes on Toxic plant chemicals:

The essential oil contains monoterpenes, such as alpha-pinene and geraniol, and sesquiterpenes, such as gamma-humulene. However, Molyneux et al. (1980) do not believe that these chemicals contribute to the abortifacient nature of broom snakeweed. Saponins are believed to be the cause of the toxicity to animals and may also be implicated in the abortifacient fraction (Cheeke and Schull 1985).

Toxic plant chemicals:

alpha-pinene
gamma-humulene

References:

Molyneux, R. J., Stevens, K. L., James, L. F. 1980. Chemistry of toxic range plants. Volatile constituents of broomweed (*Gutierrezia sarothrae*). J. Agric. Food Chem., 28: 1332-1333.

Animals/Human Poisoning:

Note: When an animal is listed without additional information, the literature (as of 1993) contained no detailed explanation.

Cattle

General symptoms of poisoning:

[abortion](#)

[anorexia](#)

[appetite, loss of](#)

[constipation](#)

[death](#)

[diarrhea](#)

[muzzle, crusty](#)

[urination, frequent](#)

Notes on poisoning:

Acute toxicity includes symptoms of listlessness, anorexia, rough coat, diarrhea or constipation, vaginal discharge, and hematuria. Cattle produce a nasal discharge, and the muzzle becomes crusty. Lesions include those of gastroenteritis and degeneration of the kidneys and liver. Severe toxic nephritis with necrosis occurs in serious cases. The spleen may be congested and the uterus, edematous. Abortion is a major result of poisoning. Premature calves are weak or are dead at birth with retained placenta. The pregnant cow may experience swelling of the vulva and early udder development (Kingsbury 1964, Molyneux et al. 1980, Ralphs 1985).

References:

Kingsbury, J. M. 1964. Poisonous plants of the United States and Canada. Prentice-Hall Inc., Englewood Cliffs, N.J., USA. 626 pp.

Ralphs, M. H. 1985. Poisonous plants: the snakeweeds. Rangelands, 7(2): 63-65.

Goats

General symptoms of poisoning:

[abortion](#)

[death](#)

References:

Kingsbury, J. M. 1964. Poisonous plants of the United States and Canada. Prentice-Hall Inc., Englewood Cliffs, N.J., USA. 626 pp.

Sheep

General symptoms of poisoning:

[abortion](#)

[anorexia](#)

[constipation](#)

[death](#)

[diarrhea](#)

[icterus](#)

[weakness](#)

Notes on poisoning:

Symptoms of broom snakeweed poisoning in sheep are similar to those in cattle and include anorexia, rough coat, diarrhea or constipation, vaginal discharge, and hematuria. Sheep display minor icterus. Lesions include those of gastroenteritis and degeneration of the liver and kidneys. Toxic nephritis is found in severe cases. Abortion also occurs, but less frequently than in cattle (Kingsbury 1964).

References:

Kingsbury, J. M. 1964. Poisonous plants of the United States and Canada. Prentice-Hall Inc., Englewood Cliffs, N.J., USA. 626 pp.

[Another search?](#)

[Français](#) | [Contact Us](#) | [Help](#) | [Search](#) | [Canada site](#)

[Coming Events](#) | [About CBIF](#) | [Links](#) | [Reports and Publications](#) | [Home](#)

Date modified: 2003-02-06

[Important Notices](#)



Français	Contact us	Help	Search	Canada site
Coming events	About CBIF	Links	Reports and publications	Home

Canadian Biodiversity Information Facility



Notes on poisoning: buckwheat

[Introduction](#)

[Interactive](#)

[All poisonous plants by Botanical name](#)

[All poisonous plants by Common name](#)

[Important WWW Poisonous Plants sites](#)



General poisoning notes:

Buckwheat (*Fagopyrum esculentum*) is cultivated in Canada as a crop for fodder and for the production of buckwheat honey.

Ingesting entire plants, dried or fresh, has caused photosensitization in animals with exposed or light-colored skin including cattle, goats, sheep, swine, and turkeys. Exposure to the sun is necessary. This plant is considered to be a primary photosensitizer, although jaundice has occurred concurrently, which indicates secondary involvement of the liver (Cooper and Johnson 1984, Cheeke and Schull 1985). Buckwheat has been found to be an effective replacement for wheat or barley in rations for swine (Anderson and Bowland 1981). Closely related tartary buckwheat (*Fagopyrum tataricum* L.) is also a satisfactory grain replacement in ruminant animals (Nicholson et al. 1976).

Humans can be sensitized to dust from buckwheat flour after long exposure. Asthma is the usual response, although rare individuals may manifest food allergy reactions after ingesting food products containing buckwheat flour. Photosensitization has not occurred in humans (Blumstein 1936).

References:

Anderson, D. M., Bowland, J. P. 1981. Evaluation of buckwheat (*Fagopyrum esculentum*) in diets of growing pigs. Proc. Am. Soc. Anim. Sci. West. Br., 32: 422-425.

Blumstein, G. I. 1936. Buckwheat sensitivity. J. Allergy, 7: 74-79.

Cheeke, P. R., Shull, L. R. 1985. Natural toxicants in feeds and poisonous plants. AVI Publishing Company, Inc., Westport, Conn., USA. 492 pp.

Cooper, M. R., Johnson, A. W. 1984. Poisonous plants in Britain and their effects on animals and man. Her Majesty's Stationery Office, London, England. 305 pp.

Nicholson, J. W., McQueen, R., Grant, E. A., Burgess, P. L. 1976. The feeding value of tartary buckwheat for ruminants. *Can. J. Anim. Sci.*, 56: 803-808.

Nomenclature:

Scientific Name: *Fagopyrum esculentum* Moench

Vernacular name(s): buckwheat

Scientific family name: *Polygonaceae*

Vernacular family name: buckwheat

Go to ITIS^{*ca} for more taxonomic information on: [Fagopyrum esculentum](#)

References:

Agriculture Quebec. 1975. Noms des maladies des plantes du Canada/ Names of plant diseases in Canada. , Quebec City, Que., Canada. 288 pp.

Alex, J. F., Cayouette, R., Mulligan, G. A. 1980. Common and botanical names of weeds in Canada/Noms populaire et scientifiques des plantes nuisibles du Canada. Revised. Agric. Can. Publ., Ottawa, Ont., Canada. 132 pp.

Bailey, L. H., Bailey, E. Z. 1976. Hortus third. Revised. MacMillan, New York, N.Y., USA. 1290 pp.

Scoggan, H. J. 1978, 1979. The flora of Canada. Nat. Mus. Nat. Sci. (Ottawa) Publ. Bot. 7(1)-7(4). 1711 pp.

Van Wijk, H. L. 1911. A dictionary of plant names. Martinus Nijhoff, The Hague, The Netherlands. 1444 pp.

Victorin, M. 1964. Flore Laurentienne. 2nd ed. Univ. Montreal, Montreal, Que., Canada. 952 pp.

Geographic Information

Plant or plant parts used in or around the home.

References:

Bailey, L. H., Bailey, E. Z. 1976. Hortus third. Revised. MacMillan, New York, N.Y., USA. 1290 pp.

Boivin, B. 1966, 1967. Énumération des plantes du Canada. Provencheria 6. Nat. Can. (Que.) 93: 253-274; 371-437; 583-646; 989-1063. 94: 131-157; 471-528; 625-655.

Image or illustration

buckwheat:

Images: images.google.com

Notes on Poisonous plant parts:

Little fagopyrin occurs in the seeds, but ingesting the entire plant, either green or dried, can cause serious photosensitization in livestock (Johnson 1989).

Toxic parts:

all parts
leaves
seeds
stems

References:

Johnson, A. E. 1983. Photosensitizing toxins from plants and their biologic effects. Pages 345-359 in Keeler, R. F., Tu, A. T., eds. Handbook of natural toxins. Vol. 1. Plant and Fungal toxins. Marcel Dekker, Inc., New York, N.Y., USA. 934 pp.

Notes on Toxic plant chemicals:

Fagopyrin, probably a derivative of naphthodianthrone, is closely related to hypericin, which is found in St. John's-wort (*[Hypericum perforatum](#)*). The absorption spectra of these chemicals is in the range of 540-610 nm (Johnson 1983).

Toxic plant chemicals:

fagopyrin

References:

Johnson, A. E. 1983. Photosensitizing toxins from plants and their biologic effects. Pages 345-359 in Keeler, R. F., Tu, A. T., eds. Handbook of natural toxins. Vol. 1. Plant and Fungal toxins. Marcel Dekker, Inc., New York, N.Y., USA. 934 pp.

Animals/Human Poisoning:

Note: When an animal is listed without additional information,

the literature (as of 1993) contained no detailed explanation.

Cattle

General symptoms of poisoning:

[recumbency](#)

[skin, peeling of](#)

[thirsty](#)

[weakness](#)

References:

Cooper, M. R., Johnson, A. W. 1984. Poisonous plants in Britain and their effects on animals and man. Her Majesty's Stationery Office, London, England. 305 pp.

Goats

General symptoms of poisoning:

[blistering](#)

[skin, peeling of](#)

References:

Cooper, M. R., Johnson, A. W. 1984. Poisonous plants in Britain and their effects on animals and man. Her Majesty's Stationery Office, London, England. 305 pp.

Humans

Sheep

General symptoms of poisoning:

[blistering](#)

[paralysis](#)

[recumbency](#)

[skin, peeling of](#)

References:

Cooper, M. R., Johnson, A. W. 1984. Poisonous plants in Britain and their effects on animals and man. Her Majesty's Stationery Office, London, England. 305 pp.

Swine

General symptoms of poisoning:

[blistering](#)
[skin, peeling of](#)

References:

Cooper, M. R., Johnson, A. W. 1984. Poisonous plants in Britain and their effects on animals and man. Her Majesty's Stationery Office, London, England. 305 pp.

Turkeys

General symptoms of poisoning:

[incoordination](#)
[skin, peeling of](#)

References:

Cooper, M. R., Johnson, A. W. 1984. Poisonous plants in Britain and their effects on animals and man. Her Majesty's Stationery Office, London, England. 305 pp.

[Another search?](#)

[Français](#) | [Contact Us](#) | [Help](#) | [Search](#) | [Canada site](#)

[Coming Events](#) | [About CBIF](#) | [Links](#) | [Reports and Publications](#) | [Home](#)

Date modified: 2003-02-06

[Important Notices](#)



Français	Contact us	Help	Search	Canada site
Coming events	About CBIF	Links	Reports and publications	Home

Canadian Biodiversity Information Facility



Notes on poisoning: bulbous buttercup

[Introduction](#)

[Interactive](#)

[All poisonous plants by Botanical name](#)

[All poisonous plants by Common name](#)

[Important WWW Poisonous Plants sites](#)



General poisoning notes:

Bulbous buttercup (*Ranunculus bulbosus*) is a naturalized herb found in a few Canadian provinces. In the past, the juice of this plant was used by beggars in Europe to cause skin lesions, thus eliciting compassion. The volatile chemical protoanemonin is an irritant. Ingesting this plant has poisoned cattle, swine, and humans. The recent literature includes few cases of poisoning (Kingsbury 1964, Cooper and Johnson 1984).

References:

Cooper, M. R., Johnson, A. W. 1984. Poisonous plants in Britain and their effects on animals and man. Her Majesty's Stationery Office, London, England. 305 pp.

Kingsbury, J. M. 1964. Poisonous plants of the United States and Canada. Prentice-Hall Inc., Englewood Cliffs, N.J., USA. 626 pp.

Nomenclature:

Scientific Name: *Ranunculus bulbosus* L.

Vernacular name(s): bulbous buttercup

Scientific family name: *Ranunculaceae*

Vernacular family name: crowfoot

Go to ITIS*^{ca} for more taxonomic information on: [Ranunculus bulbosus](#)

References:

Agriculture Quebec. 1975. Noms des maladies des plantes du Canada/ Names of plant diseases in Canada. , Quebec City, Que., Canada. 288 pp.

Alex, J. F., Cayouette, R., Mulligan, G. A. 1980. Common and botanical names of weeds in Canada/Noms populaire et scientifiques des plantes nuisibles du Canada. Revised. Agric. Can. Publ., Ottawa, Ont., Canada. 132 pp.

Bailey, L. H., Bailey, E. Z. 1976. Hortus third. Revised. MacMillan, New York, N.Y., USA. 1290 pp.

Scoggan, H. J. 1978, 1979. The flora of Canada. Nat. Mus. Nat. Sci. (Ottawa) Publ. Bot. 7(1)-7(4). 1711 pp.

Van Wijk, H. L. 1911. A dictionary of plant names. Martinus Nijhoff, The Hague, The Netherlands. 1444 pp.

Victorin, M. 1964. Flore Laurentienne. 2nd ed. Univ. Montreal, Montreal, Que., Canada. 952 pp.

Geographic Information

Newfoundland

Nova Scotia

Ontario

References:

Bailey, L. H., Bailey, E. Z. 1976. Hortus third. Revised. MacMillan, New York, N.Y., USA. 1290 pp.

Boivin, B. 1966, 1967. Énumération des plantes du Canada. Provencheria 6. Nat. Can. (Que.) 93: 253-274; 371-437; 583-646; 989-1063. 94: 131-157; 471-528; 625-655.

Image or illustration

bulbous buttercup:

Images: images.google.com

Toxic parts:

plant juices

References:

Cooper, M. R., Johnson, A. W. 1984. Poisonous plants in Britain and their effects on animals and man. Her Majesty's Stationery Office, London, England. 305 pp.

Notes on Toxic plant chemicals:

Ranunculin, a glycoside, occurs in the juice of the buttercups. Upon maceration, a plant enzyme is released that converts ranunculin to protoanemonin. This chemical, a yellow volatile oil, is unstable and either polymerizes to nontoxic anemonin or is volatilized. Air-dried plants, as those found in hay, are nontoxic. Protoanemonin is an irritant that can cause blisters and other problems when ingested (Cooper and Johnson 1984).

Toxic plant chemicals:

ranunculin

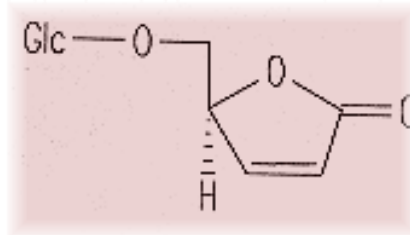

Chemical diagram(s) are courtesy of [Ruth McDiarmid](#), Biochemistry Technician, Kamloops Range Station, Agriculture and Agri-Food Canada, Kamloops, British Columbia, Canada.

References:

Cooper, M. R., Johnson, A. W. 1984. Poisonous plants in Britain and their effects on animals and man. Her Majesty's Stationery Office, London, England. 305 pp.

Animals/Human Poisoning:

Note: When an animal is listed without additional information, the literature (as of 1993) contained no detailed explanation.

Cattle

General symptoms of poisoning:

[breathing, labored](#)

[gait, unsteady](#)

[nasal discharge](#)

[salivation](#)

Notes on poisoning:

In one case in Britain, a cow salivated, coughed, and discharged mucous from the nostrils after ingesting buttercup plants. The animal swayed in the hindquarters with an uneasy movement of

the legs. A period of noisy breathing preceded recovery (Cooper and Johnson 1984).

References:

Cooper, M. R., Johnson, A. W. 1984. Poisonous plants in Britain and their effects on animals and man. Her Majesty's Stationery Office, London, England. 305 pp.

Humans

General symptoms of poisoning:

[abdominal pains](#)

[diarrhea](#)

[mouth, irritation of](#)

Notes on poisoning:

Ingesting the bulbous bases of this buttercup has caused a few cases of illness. An acrid taste and burning of the mouth and throat precludes ingesting large quantities. Other symptoms may include diarrhea and abdominal pain (Cooper and Johnson 1984).

References:

Cooper, M. R., Johnson, A. W. 1984. Poisonous plants in Britain and their effects on animals and man. Her Majesty's Stationery Office, London, England. 305 pp.

Swine

General symptoms of poisoning:

[blindness](#)

References:

Kingsbury, J. M. 1964. Poisonous plants of the United States and Canada. Prentice-Hall Inc., Englewood Cliffs, N.J., USA. 626 pp.

[Another search?](#)

[Français](#) | [Contact Us](#) | [Help](#) | [Search](#) | [Canada site](#)

[Coming Events](#) | [About CBIF](#) | [Links](#) | [Reports and Publications](#) |

[Home](#)

Date modified: 2003-02-06

[Important Notices](#)



Français	Contact us	Help	Search	Canada site
Coming events	About CBIF	Links	Reports and publications	Home

Canadian Biodiversity Information Facility



Notes on poisoning: bur buttercup

[Introduction](#)

[Interactive](#)

[All poisonous plants by Botanical name](#)

[All poisonous plants by Common name](#)

[Important WWW Poisonous Plants sites](#)



General poisoning notes:

Bur buttercup (*Ceratocephalus testiculatus*) is an introduced herb that so far is known only from around Kamloops, British Columbia. This plant is found in several western states bordering Canada, where it is rapidly spreading. The plant has also been found on South Bass Island in Ohio on Lake Erie. This plant contains ranunculin, as do some species of the genus *Ranunculus* (buttercup). This chemical changes into a toxic chemical when the plant is crushed. Sheep have been poisoned and have died in the western United States after ingesting aboveground plant material; this plant is considered highly toxic. About 500 g of green plant can kill a 45-kg sheep. This plant grows in dry sandy areas, such as sage slopes and in livestock pens, and has recently been found as a weed in grain and alfalfa fields (Olsen et al. 1983, Cusick 1989).

References:

- Cusick, A. W. 1989. Bur buttercup (*Ceratocephalus testiculatus*: Ranunculaceae): a poisonous plant newly established in Ohio. *Mich. Bot.*, 28: 33-35.
- Olsen, J. D., Anderson, T. E., Murphy, J. C., Madsen, G. 1983. Bur buttercup poisoning of sheep. *J. Am. Vet. Med. Assoc.*, 183: 538-543.

Nomenclature:

Scientific Name: *Ceratocephalus testiculatus* (Crantz) Roth

Vernacular name(s): bur buttercup

Scientific family name: *Ranunculaceae*

Vernacular family name: crowfoot

References:

Agriculture Quebec. 1975. Noms des maladies des plantes du Canada/ Names of plant diseases in Canada. , Quebec City, Que., Canada. 288 pp.

Alex, J. F., Cayouette, R., Mulligan, G. A. 1980. Common and botanical names of weeds in Canada/Noms populaire et scientifiques des plantes nuisibles du Canada. Revised. Agric. Can. Publ., Ottawa, Ont., Canada. 132 pp.

Bailey, L. H., Bailey, E. Z. 1976. Hortus third. Revised. MacMillan, New York, N.Y., USA. 1290 pp.

Scoggan, H. J. 1978, 1979. The flora of Canada. Nat. Mus. Nat. Sci. (Ottawa) Publ. Bot. 7(1)-7(4). 1711 pp.

Van Wijk, H. L. 1911. A dictionary of plant names. Martinus Nijhoff, The Hague, The Netherlands. 1444 pp.

Victorin, M. 1964. Flore Laurentienne. 2nd ed. Univ. Montreal, Montreal, Que., Canada. 952 pp.

Geographic Information

British Columbia

References:

Bailey, L. H., Bailey, E. Z. 1976. Hortus third. Revised. MacMillan, New York, N.Y., USA. 1290 pp.

Boivin, B. 1966, 1967. Énumération des plantes du Canada. Provencheria 6. Nat. Can. (Que.) 93: 253-274; 371-437; 583-646; 989-1063. 94: 131-157; 471-528; 625-655.

Image or illustration

bur buttercup:

Images: images.google.com

Toxic parts:

plant juices

References:

Cusick, A. W. 1989. Bur buttercup (*Ceratocephalus testiculatus*: Ranunculaceae): a poisonous plant newly established in Ohio. Mich. Bot., 28: 33-35.

Notes on Toxic plant chemicals:

Crushing the plant releases an enzyme that changes ranunculin, a glycoside, to protoanemonin, a highly irritant, yellow, volatile oil. This chemical is unstable and changes to nontoxic anemonin or volatilizes upon drying, leaving nontoxic plant material. The median LD-50 was 10.9 g/kg for sheep fed aboveground plant parts in the flower to early-seed stage. A sheep fed 7 g/kg of body weight might develop transient anorectic effects. Intake of 13.9 g/kg or greater would usually be lethal (Olsen et al. 1983).

Toxic plant chemicals:

ranunculin

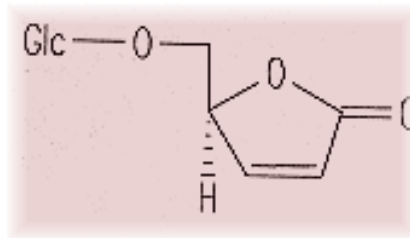

Chemical diagram(s) are courtesy of [Ruth McDiarmid](#), Biochemistry Technician, Kamloops Range Station, Agriculture and Agri-Food Canada, Kamloops, British Columbia, Canada.

References:

Olsen, J. D., Anderson, T. E., Murphy, J. C., Madsen, G. 1983. Bur buttercup poisoning of sheep. J. Am. Vet. Med. Assoc., 183: 538-543.

Animals/Human Poisoning:

Note: When an animal is listed without additional information, the literature (as of 1993) contained no detailed explanation.

Sheep

General symptoms of poisoning:

[anorexia](#)
[breathing, labored](#)
[death](#)
[diarrhea](#)
[dyspnea](#)
[recumbency](#)
[weakness](#)

Notes on poisoning:

In Utah 150 of 800 sheep that ingested bur buttercup died. Symptoms took less than 24 h and included watery diarrhea, recumbency, weakness, and death. Experimental feeding showed more complete signs, such as tachycardia, dyspnea, anorexia, and occasional fever. Post-mortem findings revealed edema of the peritoneal surface to the ruminoreticulum, subendocardial hemorrhages in the left ventricle, and congestion of the heart, kidneys, liver and lungs. Severity was directly related to the dosage. Death results apparently as a failure of the cardiovascular system, with massive fluid shifts (Olsen et al. 1983).

References:

Olsen, J. D., Anderson, T. E., Murphy, J. C., Madsen, G. 1983. Bur buttercup poisoning of sheep. J. Am. Vet. Med. Assoc., 183: 538-543.

[Another search?](#)

[Français](#) | [Contact Us](#) | [Help](#) | [Search](#) | [Canada site](#)

[Coming Events](#) | [About CBIF](#) | [Links](#) | [Reports and Publications](#) | [Home](#)

Date modified: 2003-02-06

[Important Notices](#)



Français	Contact us	Help	Search	Canada site
Coming events	About CBIF	Links	Reports and publications	Home

Canadian Biodiversity Information Facility



Notes on poisoning: Burke's lupine

[Introduction](#)[Interactive](#)[All poisonous plants by Botanical name](#)[All poisonous plants by Common name](#)[Important WWW Poisonous Plants sites](#)

General poisoning notes:

Burkes''s lupine (*Lupinus burkei*) is a native herb found in southern British Columbia. Chemical analysis of aboveground plant material has shown that this species can occasionally contain enough of the chemical anagyrene to cause teratogenic effects in calves if the plant is ingested maternally between day 40 and day 70 of gestation. The literature does not include cases of poisoning or teratogenic problems caused by this plant. See additional notes under silky lupine ([Lupinus sericeus](#)).

References:

Davis, A. M., Stout, D. M. 1986. Anagyrene in western American lupines. J. Range Manage., 39: 29-30.

Nomenclature:

Scientific Name: *Lupinus burkei* S. Wats.

Vernacular name(s): Burke's lupine

Scientific family name: *Leguminosae*

Vernacular family name: pea

Go to ITIS*^{ca} for more taxonomic information on: [Lupinus burkei](#)

References:

Agriculture Quebec. 1975. Noms des maladies des plantes du Canada/ Names of plant diseases in Canada. , Quebec City, Que., Canada. 288 pp.

Alex, J. F., Cayouette, R., Mulligan, G. A. 1980. Common and botanical names of weeds in Canada/Noms populaire et

scientifiques des plantes nuisibles du Canada. Revised. Agric. Can. Publ., Ottawa, Ont., Canada. 132 pp.

Bailey, L. H., Bailey, E. Z. 1976. Hortus third. Revised. MacMillan, New York, N.Y., USA. 1290 pp.

Scoggan, H. J. 1978, 1979. The flora of Canada. Nat. Mus. Nat. Sci. (Ottawa) Publ. Bot. 7(1)-7(4). 1711 pp.

Van Wijk, H. L. 1911. A dictionary of plant names. Martinus Nijhoff, The Hague, The Netherlands. 1444 pp.

Victorin, M. 1964. Flore Laurentienne. 2nd ed. Univ. Montreal, Montreal, Que., Canada. 952 pp.

Geographic Information

Alberta

British Columbia

References:

Bailey, L. H., Bailey, E. Z. 1976. Hortus third. Revised. MacMillan, New York, N.Y., USA. 1290 pp.

Boivin, B. 1966, 1967. Énumération des plantes du Canada. Provencheria 6. Nat. Can. (Que.) 93: 253-274; 371-437; 583-646; 989-1063. 94: 131-157; 471-528; 625-655.

Image or illustration

Burke's lupine:

Images: images.google.com

Toxic parts:

leaves

stems

References:

Davis, A. M., Stout, D. M. 1986. Anagryne in western American lupines. J. Range Manage., 39: 29-30.

Notes on Toxic plant chemicals:

Burke's lupine contains anagryne, which has been measured in amounts exceeding the minimum (1.44 g/kg) required to cause teratogenic effects in calves (Davis and Stout 1986). See additional notes under silky lupine [Lupinus sericeus](#)).

Toxic plant chemicals:

anagyrine

References:

Davis, A. M., Stout, D. M. 1986. Anagyrine in western American lupines. *J. Range Manage.*, 39: 29-30.

Animals/Human Poisoning:

Note: When an animal is listed without additional information, the literature (as of 1993) contained no detailed explanation.

Cattle

[Another search?](#)

[Français](#) | [Contact Us](#) | [Help](#) | [Search](#) | [Canada site](#)

[Coming Events](#) | [About CBIF](#) | [Links](#) | [Reports and Publications](#) | [Home](#)

Date modified: 2003-02-06

[Important Notices](#)



Français	Contact us	Help	Search	Canada site
Coming events	About CBIF	Links	Reports and publications	Home

Canadian Biodiversity Information Facility



Notes on poisoning: burningbush

[Introduction](#)

[Interactive](#)

[All poisonous plants by Botanical name](#)

[All poisonous plants by Common name](#)

[Important WWW Poisonous Plants sites](#)



General poisoning notes:

Burningbush (*Euonymus atropurpureus*) is an ornamental shrub that grows across southern Canada. Several reviews have noted that this plant is poisonous, but documented cases appear to refer to the closely related European spindletree (*Euonymus europaeus*). See additional information under general notes on the European spindletree. Children who ingest the seeds should be attended to. Children and horses have been poisoned by ingesting the European spindletree. Symptoms of poisoning of children and horses are discussed under that plant as well.

References:

Kingsbury, J. M. 1964. Poisonous plants of the United States and Canada. Prentice-Hall Inc., Englewood Cliffs, N.J., USA. 626 pp.

Nomenclature:

Scientific Name: *Euonymus atropurpureus* Jacq.

Vernacular name(s): burningbush

Scientific family name: *Celastraceae*

Vernacular family name: stafftree

Go to ITIS^{*ca} for more taxonomic information on: [Euonymus atropurpureus](#)

References:

Agriculture Quebec. 1975. Noms des maladies des plantes du Canada/ Names of plant diseases in Canada. , Quebec City, Que., Canada. 288 pp.

Alex, J. F., Cayouette, R., Mulligan, G. A. 1980. Common and

botanical names of weeds in Canada/Noms populaire et scientifiques des plantes nuisibles du Canada. Revised. Agric. Can. Publ., Ottawa, Ont., Canada. 132 pp.

Bailey, L. H., Bailey, E. Z. 1976. Hortus third. Revised. MacMillan, New York, N.Y., USA. 1290 pp.

Scoggan, H. J. 1978, 1979. The flora of Canada. Nat. Mus. Nat. Sci. (Ottawa) Publ. Bot. 7(1)-7(4). 1711 pp.

Van Wijk, H. L. 1911. A dictionary of plant names. Martinus Nijhoff, The Hague, The Netherlands. 1444 pp.

Victorin, M. 1964. Flore Laurentienne. 2nd ed. Univ. Montreal, Montreal, Que., Canada. 952 pp.

Geographic Information

Plant or plant parts used in or around the home.

References:

Bailey, L. H., Bailey, E. Z. 1976. Hortus third. Revised. MacMillan, New York, N.Y., USA. 1290 pp.

Boivin, B. 1966, 1967. Énumération des plantes du Canada. Provencheria 6. Nat. Can. (Que.) 93: 253-274; 371-437; 583-646; 989-1063. 94: 131-157; 471-528; 625-655.

Image or illustration

burningbush:

Images: images.google.com

Toxic parts:

bark
leaves
seeds

References:

Kingsbury, J. M. 1964. Poisonous plants of the United States and Canada. Prentice-Hall Inc., Englewood Cliffs, N.J., USA. 626 pp.

Toxic plant chemicals:

evomonoside

References:

Kingsbury, J. M. 1964. Poisonous plants of the United States and Canada. Prentice-Hall Inc., Englewood Cliffs, N.J., USA. 626 pp.

Animals/Human Poisoning:

Note: When an animal is listed without additional information, the literature (as of 1993) contained no detailed explanation.

Horses

Humans

[Another search?](#)

[Français](#) | [Contact Us](#) | [Help](#) | [Search](#) | [Canada site](#)

[Coming Events](#) | [About CBIF](#) | [Links](#) | [Reports and Publications](#) | [Home](#)

Date modified: 2003-02-06

[Important Notices](#)



Français	Contact us	Help	Search	Canada site
Coming events	About CBIF	Links	Reports and publications	Home

Canadian Biodiversity Information Facility



Notes on poisoning: caladium

[Introduction](#)[Interactive](#)[All poisonous plants by Botanical name](#)[All poisonous plants by Common name](#)[Important WWW Poisonous Plants sites](#)

General poisoning notes:

Caladium (*Caladium bicolor*) is a houseplant that can cause burning and irritation of the lips. The plant can be a problem to children who ingest the leaves as well as to family pets that might nibble on the foliage.



References:

Lampe, K. F., McCann, M. A. 1985. AMA Handbook of poisonous and injurious plants. American Medical Assoc. Chicago, Ill., USA. 432 pp.

Spoerke, D. G., Smolinske, S. C. 1990. Toxicity of houseplants. CRC Press, Inc., Boca Raton, Fla., USA. 335 pp.

Nomenclature:

Scientific Name: *Caladium bicolor* (Ait.) Vent.

Vernacular name(s): caladium

Scientific family name: *Araceae*

Vernacular family name: arum

Go to ITIS^{*ca} for more taxonomic information on: [Caladium bicolor](#)

References:

Agriculture Quebec. 1975. Noms des maladies des plantes du Canada/ Names of plant diseases in Canada. , Quebec City, Que., Canada. 288 pp.

Alex, J. F., Cayouette, R., Mulligan, G. A. 1980. Common and botanical names of weeds in Canada/Noms populaire et

scientifiques des plantes nuisibles du Canada. Revised. Agric. Can. Publ., Ottawa, Ont., Canada. 132 pp.

Bailey, L. H., Bailey, E. Z. 1976. Hortus third. Revised. MacMillan, New York, N.Y., USA. 1290 pp.

Scoggan, H. J. 1978, 1979. The flora of Canada. Nat. Mus. Nat. Sci. (Ottawa) Publ. Bot. 7(1)-7(4). 1711 pp.

Van Wijk, H. L. 1911. A dictionary of plant names. Martinus Nijhoff, The Hague, The Netherlands. 1444 pp.

Victorin, M. 1964. Flore Laurentienne. 2nd ed. Univ. Montreal, Montreal, Que., Canada. 952 pp.

Geographic Information

Plant or plant parts used in or around the home.

References:

Bailey, L. H., Bailey, E. Z. 1976. Hortus third. Revised. MacMillan, New York, N.Y., USA. 1290 pp.

Boivin, B. 1966, 1967. Énumération des plantes du Canada. Provencheria 6. Nat. Can. (Que.) 93: 253-274; 371-437; 583-646; 989-1063. 94: 131-157; 471-528; 625-655.

Image or illustration

caladium:

Images: images.google.com

Notes on Poisonous plant parts:

All parts of this plant contain oxalate crystals, which can cause intense irritation if ingested (Lampe and McCann 1985).

Toxic parts:

leaves
roots
stems

References:

Lampe, K. F., McCann, M. A. 1985. AMA Handbook of poisonous and injurious plants. American Medical Assoc. Chicago, Ill., USA. 432 pp.

Notes on Toxic plant chemicals:

Oxalate crystals are common to many members of the family Araceae and are capable of causing intense irritation.

Toxic plant chemicals:

oxalate

References:

Lampe, K. F., McCann, M. A. 1985. AMA Handbook of poisonous and injurious plants. American Medical Assoc. Chicago, Ill., USA. 432 pp.

Animals/Human Poisoning:

Note: When an animal is listed without additional information, the literature (as of 1993) contained no detailed explanation.

Cats

Dogs

Humans

General symptoms of poisoning:

[mouth, irritation of](#)

Notes on poisoning:

Ingesting material containing calcium oxalate raphide crystals causes irritation of the soft mouth parts and perhaps the throat of humans and animals. Swelling of tissues causes pain and a burning sensation that slowly subsides. Cool liquids or analgesics may be indicated. The insoluble oxalates do not cause systemic poisoning (Lampe and McCann 1985).

References:

Lampe, K. F., McCann, M. A. 1985. AMA Handbook of poisonous and injurious plants. American Medical Assoc. Chicago, Ill., USA. 432 pp.

[Another search?](#)

[Français](#) | [Contact Us](#) | [Help](#) | [Search](#) | [Canada site](#)

[Coming Events](#) | [About CBIF](#) | [Links](#) | [Reports and Publications](#) | [Home](#)

Date modified: 2003-02-06

[Important Notices](#)



Français	Contact us	Help	Search	Canada site
Coming events	About CBIF	Links	Reports and publications	Home

Canadian Biodiversity Information Facility



Notes on poisoning: California bluebell

[Introduction](#)[Interactive](#)[All poisonous plants by Botanical name](#)[All poisonous plants by Common name](#)[Important WWW Poisonous Plants sites](#)

General poisoning notes:

California bluebell (*Phacelia campanularia*) has been found near Fort Saskatchewan, Alta., where it was probably introduced. This plant causes dermatitis that is similar to poison-ivy dermatitis. The plants in Alberta have caused at least one case of dermatitis (Hardwick, personal communication). If these plants expand their range, more people may develop dermatitis (Munz 1965, Mitchell and Rook 1979).

References:

Mitchell, J. C., Rook, A. 1979. Botanical dermatology. Greenglass Ltd, Vancouver, B.C., Canada. 787 pp.

Munz, P. A. 1965. Dermatitis produced by phacelia (Hydrophyllaceae). Science (Wash. D. C.), 76: 194.

Nomenclature:

Scientific Name: *Phacelia campanularia* A. Gray

Vernacular name(s): California bluebell

Scientific family name: *Hydrophyllaceae*

Vernacular family name: waterleaf

Go to ITIS^{*ca} for more taxonomic information on: [Phacelia campanularia](#)

References:

Agriculture Quebec. 1975. Noms des maladies des plantes du Canada/ Names of plant diseases in Canada. , Quebec City, Que., Canada. 288 pp.

Alex, J. F., Cayouette, R., Mulligan, G. A. 1980. Common and botanical names of weeds in Canada/Noms populaire et scientifiques des plantes nuisibles du Canada. Revised. Agric. Can. Publ., Ottawa, Ont., Canada. 132 pp.

Bailey, L. H., Bailey, E. Z. 1976. Hortus third. Revised. MacMillan, New York, N.Y., USA. 1290 pp.

Scoggan, H. J. 1978, 1979. The flora of Canada. Nat. Mus. Nat. Sci. (Ottawa) Publ. Bot. 7(1)-7(4). 1711 pp.

Van Wijk, H. L. 1911. A dictionary of plant names. Martinus Nijhoff, The Hague, The Netherlands. 1444 pp.

Victorin, M. 1964. Flore Laurentienne. 2nd ed. Univ. Montreal, Montreal, Que., Canada. 952 pp.

Geographic Information

Alberta

References:

Bailey, L. H., Bailey, E. Z. 1976. Hortus third. Revised. MacMillan, New York, N.Y., USA. 1290 pp.

Boivin, B. 1966, 1967. Énumération des plantes du Canada. Provencheria 6. Nat. Can. (Que.) 93: 253-274; 371-437; 583-646; 989-1063. 94: 131-157; 471-528; 625-655.

Image or illustration

California bluebell:

Images: images.google.com

Notes on Poisonous plant parts:

The viscid glandular hairs on the plants stain the skin brown, and the sap causes dermatitis (Munz 1965).

Toxic parts:

hairs

References:

Munz, P. A. 1965. Dermatitis produced by phacelia (Hydrophyllaceae). Science (Wash. D. C.), 76: 194.

Toxic plant chemicals:

unknown chemical

References:

Munz, P. A. 1965. Dermatitis produced by phacelia (Hydrophyllaceae). Science (Wash. D. C.), 76: 194.

Animals/Human Poisoning:

Note: When an animal is listed without additional information, the literature (as of 1993) contained no detailed explanation.

Humans

General symptoms of poisoning:

[blistering](#)

[erythema](#)

[itchiness](#)

References:

Munz, P. A. 1965. Dermatitis produced by phacelia (Hydrophyllaceae). Science (Wash. D. C.), 76: 194.

[Another search?](#)

[Français](#) | [Contact Us](#) | [Help](#) | [Search](#) | [Canada site](#)

[Coming Events](#) | [About CBIF](#) | [Links](#) | [Reports and Publications](#) |

[Home](#)

Date modified: 2003-02-06

[Important Notices](#)



Français	Contact us	Help	Search	Canada site
Coming events	About CBIF	Links	Reports and publications	Home

Canadian Biodiversity Information Facility



Notes on poisoning: California rose-bay

[Introduction](#)[Interactive](#)[All poisonous plants by
Botanical name](#)[All poisonous plants by
Common name](#)[Important WWW Poisonous
Plants sites](#)

General poisoning notes:

California rose-bay (*Rhododendron macrophyllum*) is a native shrub found in southwestern British Columbia. This plant has poisoned goats and sheep. Azaleas are now considered part of the genus *Rhododendron*. Animals and humans have been poisoned after ingesting the foliage, nectar, or honey made from these plants. Klein-Schwartz and Litovitz (1985) found that humans who ingested plant parts of *Rhododendron* plants exhibited few symptoms of poisoning. Of 152 cases, only nine developed any symptoms and only one resulted in vomiting and transient hypertension. The authors concluded that ingesting moderate amounts of azalea material posed little danger to humans. Azaleas are often used as houseplants. Children and family pets should be prevented from ingesting these plants. Livestock have been poisoned by ingesting foliage of azaleas and rhododendrons. Sheep are most commonly affected in North America. Death has occurred in some cases (Casteel and Wagstaff 1989). Poisoning usually occurs when animals gain access to clippings or when little other forage is available, as in the winter. Rhododendrons retain their leaves over the winter. Goats and cattle have been poisoned as well. Andromedotoxins (grayanotoxins) are the toxins involved.

References:

Casteel, S., Wagstaff, J. 1989. *Rhododendron macrophyllum* poisoning in a group of goats and sheep. *Vet. Hum. Toxicol.*, 31: 176-177.

Klein-Schwartz, W., Litovitz, T. 1985. Azalea toxicity: an overrated problem?. *Clin. Toxicol.*, 23: 91-101.

Nomenclature:

Scientific Name: *Rhododendron macrophyllum* D. Don ex G. Don

Vernacular name(s): California rose-bay

Scientific family name: *Ericaceae*

Vernacular family name: heath

Go to ITIS^{*ca} for more taxonomic information on: [Rhododendron macrophyllum](#)

References:

Agriculture Quebec. 1975. Noms des maladies des plantes du Canada/ Names of plant diseases in Canada. , Quebec City, Que., Canada. 288 pp.

Alex, J. F., Cayouette, R., Mulligan, G. A. 1980. Common and botanical names of weeds in Canada/Noms populaire et scientifiques des plantes nuisibles du Canada. Revised. Agric. Can. Publ., Ottawa, Ont., Canada. 132 pp.

Bailey, L. H., Bailey, E. Z. 1976. Hortus third. Revised. MacMillan, New York, N.Y., USA. 1290 pp.

Scoggan, H. J. 1978, 1979. The flora of Canada. Nat. Mus. Nat. Sci. (Ottawa) Publ. Bot. 7(1)-7(4). 1711 pp.

Van Wijk, H. L. 1911. A dictionary of plant names. Martinus Nijhoff, The Hague, The Netherlands. 1444 pp.

Victorin, M. 1964. Flore Laurentienne. 2nd ed. Univ. Montreal, Montreal, Que., Canada. 952 pp.

Geographic Information

British Columbia

References:

Bailey, L. H., Bailey, E. Z. 1976. Hortus third. Revised. MacMillan, New York, N.Y., USA. 1290 pp.

Boivin, B. 1966, 1967. Énumération des plantes du Canada. Provencheria 6. Nat. Can. (Que.) 93: 253-274; 371-437; 583-646; 989-1063. 94: 131-157; 471-528; 625-655.

Image or illustration

California rose-bay:

Images: images.google.com

Notes on Poisonous plant parts:

The leaves and stems of this plant have caused poisoning (Casteel and Wagstaff 1989).

Toxic parts:

leaves
stems

References:

Casteel, S., Wagstaff, J. 1989. *Rhododendron macrophyllum* poisoning in a group of goats and sheep. *Vet. Hum. Toxicol.*, 31: 176-177.

Notes on Toxic plant chemicals:

Andromedotoxins (including grayanotoxin I) are toxic diterpenoids that are present in all the poisonous members of Ericaceae, the heath family (Cooper and Johnson 1984).

Toxic plant chemicals:

andromedotoxins

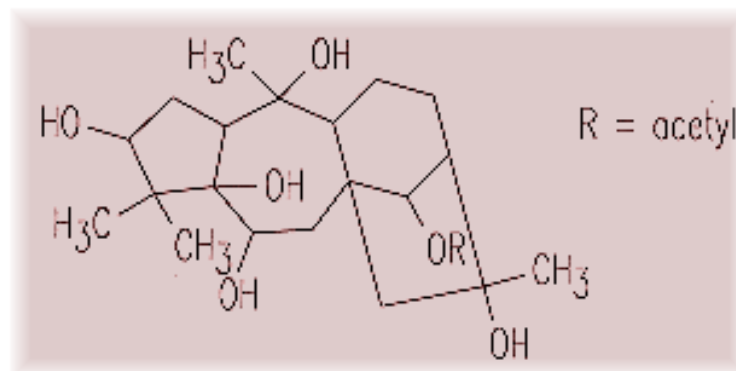

Chemical diagram(s) are courtesy of [Ruth McDiarmid](#), Biochemistry Technician, Kamloops Range Station, Agriculture and Agri-Food Canada, Kamloops, British Columbia, Canada.

References:

Cooper, M. R., Johnson, A. W. 1984. *Poisonous plants in Britain and their effects on animals and man*. Her Majesty's Stationery Office, London, England. 305 pp.

Animals/Human Poisoning:

Note: When an animal is listed without additional information, the literature (as of 1993) contained no detailed explanation.

Goats

General symptoms of poisoning:

[ataxia](#)

[colic](#)

[convulsions](#)

[death](#)

[opisthotonos](#)

[recumbency, lateral](#)

[vomiting](#)

[weakness](#)

Notes on poisoning:

In one case, several young and adult goats gained access to clippings of California rose-bay; most were poisoned, and some young goats died. Symptoms included initial lateral recumbency and a tonic-clonic convulsive episode starting 6 h after ingestion. Vomiting, ataxia, and weakness occurred. Vomiting continued over 2 days. Intense colic was observed. Lactating goats dried up. Some animals remained recumbent for a couple of days (Casteel and Wagstaff 1989).

References:

Casteel, S., Wagstaff, J. 1989. *Rhododendron macrophyllum* poisoning in a group of goats and sheep. *Vet. Hum. Toxicol.*, 31: 176-177.

Humans

General symptoms of poisoning:

[mouth, irritation of](#)

[vomiting](#)

Notes on poisoning:

Klein-Schwartz and Litovitz (1985) found that only minimal symptoms were exhibited, such as vomiting, after ingesting species of the genus *Rhododendron*. Lampe and McCann (1985) note that ingesting significant quantities of leaves can cause more severe symptoms such as burning of the mouth, salivation, vomiting, diarrhea, headache, and dimness of vision. Such occurrences are unlikely because of the bitterness of the leaves. Reports occur regarding the toxicity of honey made from azaleas and rhododendrons. This honey is bitter and is unlikely to be ingested in large quantities.

References:

Klein-Schwartz, W., Litovitz, T. 1985. Azalea toxicity: an overrated problem?. *Clin. Toxicol.*, 23: 91-101.

Sheep

General symptoms of poisoning:

[ataxia](#)

[colic](#)

[depression](#)

[recumbency](#)

[vomiting](#)

[weakness](#)

Notes on poisoning:

Ingesting clippings of California rose-bay caused illness in sheep. Symptoms included severe vomiting, ataxia, and weakness. Vomiting continued over a few days. The animals walked a short distance and then fell down. Some animals remained recumbent for many hours. Colic was observed (Casteel and Wagstaff 1989).

References:

Casteel, S., Wagstaff, J. 1989. *Rhododendron macrophyllum* poisoning in a group of goats and sheep. *Vet. Hum. Toxicol.*, 31: 176-177.

[Another search?](#)

[Français](#) | [Contact Us](#) | [Help](#) | [Search](#) | [Canada site](#)

[Coming Events](#) | [About CBIF](#) | [Links](#) | [Reports and Publications](#) | [Home](#)

Date modified: 2003-02-06

[Important Notices](#)



Français	Contact us	Help	Search	Canada site
Coming events	About CBIF	Links	Reports and publications	Home

Canadian Biodiversity Information Facility



Notes on poisoning: Canada nettle

[Introduction](#)[Interactive](#)[All poisonous plants by Botanical name](#)[All poisonous plants by Common name](#)[Important WWW Poisonous Plants sites](#)

General poisoning notes:

Canada nettle (*Laportea canadensis*) is found in moist woods and along streams. This plant has stinging hairs on the leaves and stem that readily penetrate thin-skinned areas on humans. The tips of the hairs break off, allowing the contained liquid to penetrate the body. Intense localized itching results. Applying water to the surface of the affected area can increase the sensation; this problem may persist for several weeks. In Australia, other members of the genus *Laportea* have caused severe reactions in humans, and a death was reported in New Guinea after severe exposure. Livestock have responded frantically to contact with these plants in Australia. Canada nettle can cause reactions in animals upon exposure in Canada. Avoid this plant if possible (MacFarlane 1963, Mitchell and Rook 1979).

References:

MacFarlane, W. V. 1963. The stinging properties of *Laportea*. *Econ. Bot.*, 17: 303-311.

Nomenclature:

Scientific Name: *Laportea canadensis* (L.) Gaud.

Vernacular name(s): Canada nettle

Scientific family name: *Urticaceae*

Vernacular family name: nettle

Go to ITIS*^{ca} for more taxonomic information on: [Laportea canadensis](#)

References:

Agriculture Quebec. 1975. Noms des maladies des plantes du Canada/ Names of plant diseases in Canada. , Quebec City, Que., Canada. 288 pp.

Alex, J. F., Cayouette, R., Mulligan, G. A. 1980. Common and botanical names of weeds in Canada/Noms populaire et scientifiques des plantes nuisibles du Canada. Revised. Agric. Can. Publ., Ottawa, Ont., Canada. 132 pp.

Bailey, L. H., Bailey, E. Z. 1976. Hortus third. Revised. MacMillan, New York, N.Y., USA. 1290 pp.

Scoggan, H. J. 1978, 1979. The flora of Canada. Nat. Mus. Nat. Sci. (Ottawa) Publ. Bot. 7(1)-7(4). 1711 pp.

Van Wijk, H. L. 1911. A dictionary of plant names. Martinus Nijhoff, The Hague, The Netherlands. 1444 pp.

Victorin, M. 1964. Flore Laurentienne. 2nd ed. Univ. Montreal, Montreal, Que., Canada. 952 pp.

Geographic Information

Manitoba
New Brunswick
Nova Scotia
Ontario
Quebec
Saskatchewan

References:

Bailey, L. H., Bailey, E. Z. 1976. Hortus third. Revised. MacMillan, New York, N.Y., USA. 1290 pp.

Boivin, B. 1966, 1967. Énumération des plantes du Canada. Provencheria 6. Nat. Can. (Que.) 93: 253-274; 371-437; 583-646; 989-1063. 94: 131-157; 471-528; 625-655.

Image or illustration

Canada nettle:

Images: images.google.com

Notes on Poisonous plant parts:

Canada nettle is covered with stinging hairs on the leaves and stem. The tips of the hairs are readily fractured on contact with

skin, allowing the internal liquid to be injected into the local body area. The hairs are sharply pointed, allowing ready penetration of thinner skinned portions of the body (MacFarlane 1963).

Toxic parts:

hairs

References:

MacFarlane, W. V. 1963. The stinging properties of *Laportea*. Econ. Bot., 17: 303-311.

Notes on Toxic plant chemicals:

The active ingredient in the stinging hairs is not known. The chemicals acetylcholine, histamine, and 5-hydroxytryptamine, which cause the stinging of hairs from the closely related American stinging nettle (*Urtica dioica*), are not the primary toxic chemicals in Canada nettle. Some studies on native Australian *Laportea* species have shown that no detectable loss of activity occurs after 46 years in a dry state. Immersion in boiling water for 10 min does not deactivate the chemical. In fact, the pain is intensified in humans if the affected area is exposed to water, a reaction that may last for many weeks (MacFarlane 1963).

Toxic plant chemicals:

unknown chemical

References:

MacFarlane, W. V. 1963. The stinging properties of *Laportea*. Econ. Bot., 17: 303-311.

Animals/Human Poisoning:

Note: When an animal is listed without additional information, the literature (as of 1993) contained no detailed explanation.

Humans

General symptoms of poisoning:

[erythema](#)

[itchiness](#)

[pain](#)

[skin, flushed](#)

Notes on poisoning:

Canada nettle hairs induce localized pain and discomfort as well as erythema, reddening, and localized sweating. The pain may persist for weeks. Canada nettle differs from American stinging nettle (*Urtica dioica*) in that the intense pain can persist for weeks or months (MacFarlane 1963, Mitchell and Rook 1979).

References:

MacFarlane, W. V. 1963. The stinging properties of *Laportea*. Econ. Bot., 17: 303-311.

[Another search?](#)

[Français](#) | [Contact Us](#) | [Help](#) | [Search](#) | [Canada site](#)

[Coming Events](#) | [About CBIF](#) | [Links](#) | [Reports and Publications](#) | [Home](#)

Date modified: 2003-02-06

[Important Notices](#)



Français	Contact us	Help	Search	Canada site
Coming events	About CBIF	Links	Reports and publications	Home

Canadian Biodiversity Information Facility



Notes on poisoning: Canada yew

[Introduction](#)

[Interactive](#)

[All poisonous plants by Botanical name](#)

[All poisonous plants by Common name](#)

[Important WWW Poisonous Plants sites](#)



General poisoning notes:

Canada yew (*Taxus canadensis*) is a native shrub that grows in the moist rich woodlands of eastern Canada. It has also been planted in various parts of the country as an ornamental. In one case in British Columbia, several cattle became ill and some died after ingesting the leaves and twigs of a Canada yew that had been planted for ornamental purposes (Bruce 1927).

References:

Bruce, E. A. 1927. *Astragalus campestris* and other stock poisoning plants of British Columbia. Agric. Can. Publ., 88. 44 pp.

Thomson, G. W., Barker, I. K. 1978. Japanese yew (*Taxus cuspidata*) poisoning in cattle. Can. Vet. J., 19: 320-321.

Nomenclature:

Scientific Name: *Taxus canadensis* Marsh.

References:

Agriculture Quebec. 1975. Noms des maladies des plantes du Canada/ Names of plant diseases in Canada. , Quebec City, Que., Canada. 288 pp.

Alex, J. F., Cayouette, R., Mulligan, G. A. 1980. Common and botanical names of weeds in Canada/Noms populaire et scientifiques des plantes nuisibles du Canada. Revised. Agric. Can. Publ., Ottawa, Ont., Canada. 132 pp.

Bailey, L. H., Bailey, E. Z. 1976. Hortus third. Revised. MacMillan, New York, N.Y., USA. 1290 pp.

Scoggan, H. J. 1978, 1979. The flora of Canada. Nat. Mus. Nat.

Sci. (Ottawa) Publ. Bot. 7(1)-7(4). 1711 pp.

Van Wijk, H. L. 1911. A dictionary of plant names. Martinus Nijhoff, The Hague, The Netherlands. 1444 pp.

Victorin, M. 1964. Flore Laurentienne. 2nd ed. Univ. Montreal, Montreal, Que., Canada. 952 pp.

Geographic Information

British Columbia
Manitoba
New Brunswick
Nova Scotia
Ontario
Prince Edward Island
Quebec

References:

Bailey, L. H., Bailey, E. Z. 1976. Hortus third. Revised. MacMillan, New York, N.Y., USA. 1290 pp.

Boivin, B. 1966, 1967. Énumération des plantes du Canada. Provencheria 6. Nat. Can. (Que.) 93: 253-274; 371-437; 583-646; 989-1063. 94: 131-157; 471-528; 625-655.

Image or illustration

Canada yew:

Images: images.google.com

Notes on Poisonous plant parts:

Leaves, twigs, and seeds are poisonous. Only the red arils, the fleshy outer parts of the fruits, are considered nontoxic (Bruce 1927; Lampe and McCann 1985).

Toxic parts:

leaves
seeds
twigs

References:

Bruce, E. A. 1927. *Astragalus campestris* and other stock poisoning plants of British Columbia. Agric. Can. Publ., 88. 44 pp.

Lampe, K. F., McCann, M. A. 1985. AMA Handbook of poisonous and injurious plants. American Medical Assoc. Chicago, Ill., USA. 432 pp.

Notes on Toxic plant chemicals:

Taxine (taxin), is a complex mixture of alkaloids that is rapidly absorbed from the digestive tract and interferes with heart action (Lampe and McCann 1985, Feldman et al. 1987).

Toxic plant chemicals:

taxine

References:

Feldman, R., Szajewski, J. M., Chrobak, J., Liberek, Z. M. 1987. Four cases of self-poisoning with yew leaves decoction. Vet. Hum. Toxicol., 29: 72.

Lampe, K. F., McCann, M. A. 1985. AMA Handbook of poisonous and injurious plants. American Medical Assoc. Chicago, Ill., USA. 432 pp.

Animals/Human Poisoning:

Note: When an animal is listed without additional information, the literature (as of 1993) contained no detailed explanation.

Cattle

General symptoms of poisoning:

[death](#)

[lungs, congestion of](#)

Notes on poisoning:

Leaves, twigs, and seeds are poisonous. Only the red arils, the fleshy outer parts of the fruits, are considered nontoxic (Bruce 1927; Lampe and McCann 1985).

References:

Bruce, E. A. 1927. *Astragalus campestris* and other stock poisoning plants of British Columbia. Agric. Can. Publ., 88. 44 pp.

[Another search?](#)

[Français](#) | [Contact Us](#) | [Help](#) | [Search](#) | [Canada site](#)
[Coming Events](#) | [About CBIF](#) | [Links](#) | [Reports and Publications](#) |
[Home](#)

Date modified: 2003-02-06

[Important Notices](#)



Français	Contact us	Help	Search	Canada site
Coming events	About CBIF	Links	Reports and publications	Home

Canadian Biodiversity Information Facility



Notes on poisoning: Canadian milk-vetch

[Introduction](#)[Interactive](#)[All poisonous plants by Botanical name](#)[All poisonous plants by Common name](#)[Important WWW Poisonous Plants sites](#)

General poisoning notes:

Cattle have been fatally poisoned when fed on rangeland containing Canadian milk-vetch (*Astragalus canadensis*).

Experiments with sheep indicated that plant material must contain NO₂ at 250 mg/kg of body weight to produce toxic responses and 275 mg/kg body weight for a lethal dose. In week-old chicks, the LD-50 = 2 g of plant ingested (Williams and James 1975).

References:

Williams, C., James, L. F. 1975. Toxicity of nitro-containing *Astragalus* to sheep and chicks. *J. Range Manage.*, 28: 260-263.

Nomenclature:

Scientific Name: *Astragalus canadensis* L.

Vernacular name(s): Canadian milk-vetch

Scientific family name: *Leguminosae*

Vernacular family name: pea

Go to ITIS^{*ca} for more taxonomic information on: [Astragalus canadensis](#)

References:

Agriculture Quebec. 1975. Noms des maladies des plantes du Canada/ Names of plant diseases in Canada. , Quebec City, Que., Canada. 288 pp.

Alex, J. F., Cayouette, R., Mulligan, G. A. 1980. Common and botanical names of weeds in Canada/Noms populaire et scientifiques des plantes nuisibles du Canada. Revised. Agric. Can. Publ., Ottawa, Ont., Canada. 132 pp.

Bailey, L. H., Bailey, E. Z. 1976. Hortus third. Revised. MacMillan, New York, N.Y., USA. 1290 pp.

Scoggan, H. J. 1978, 1979. The flora of Canada. Nat. Mus. Nat. Sci. (Ottawa) Publ. Bot. 7(1)-7(4). 1711 pp.

Van Wijk, H. L. 1911. A dictionary of plant names. Martinus Nijhoff, The Hague, The Netherlands. 1444 pp.

Victorin, M. 1964. Flore Laurentienne. 2nd ed. Univ. Montreal, Montreal, Que., Canada. 952 pp.

Geographic Information

Alberta
British Columbia
Manitoba
Northwest Territories
Ontario
Quebec
Saskatchewan

References:

Bailey, L. H., Bailey, E. Z. 1976. Hortus third. Revised. MacMillan, New York, N.Y., USA. 1290 pp.

Boivin, B. 1966, 1967. Énumération des plantes du Canada. Provencheria 6. Nat. Can. (Que.) 93: 253-274; 371-437; 583-646; 989-1063. 94: 131-157; 471-528; 625-655.

Image or illustration

Canadian milk-vetch:

Images: images.google.com

Toxic parts:

flowers
leaves

References:

Williams, C., James, L. F. 1975. Toxicity of nitro-containing *Astragalus* to sheep and chicks. J. Range Manage., 28: 260-263.

Toxic plant chemicals:

3-nitropropionic acid

References:

Williams, C., James, L. F. 1975. Toxicity of nitro-containing *Astragalus* to sheep and chicks. *J. Range Manage.*, 28: 260-263.

Animals/Human Poisoning:

Note: When an animal is listed without additional information, the literature (as of 1993) contained no detailed explanation.

Cattle

General symptoms of poisoning:

[death](#)

References:

Williams, C., James, L. F. 1975. Toxicity of nitro-containing *Astragalus* to sheep and chicks. *J. Range Manage.*, 28: 260-263.

Sheep

[Another search?](#)

[Français](#) | [Contact Us](#) | [Help](#) | [Search](#) | [Canada site](#)

[Coming Events](#) | [About CBIF](#) | [Links](#) | [Reports and Publications](#) |

[Home](#)

Date modified: 2003-02-06

[Important Notices](#)



Français	Contact us	Help	Search	Canada site
Coming events	About CBIF	Links	Reports and publications	Home

Canadian Biodiversity Information Facility



Notes on poisoning: candalabra aloe

[Introduction](#)

[Interactive](#)

[All poisonous plants by Botanical name](#)

[All poisonous plants by Common name](#)

[Important WWW Poisonous Plants sites](#)

General poisoning notes:

Aloe (*Aloe* spp.) extracts are used in many cosmetic and medicinal compounds. Unfortunately, some humans develop allergic contact dermatitis from this plant. Ingesting the plant latex can cause a cathartic action. Excessive doses may cause nephritis (Shoji 1982 Lampe and McCann 1985).



References:

Shoji, A. 1982. Contact dermatitis to *Aloe arborescens*. Contact Dermatitis, 8: 164-167.

Nomenclature:

Scientific Name: *Aloe arborescens* Mill.

Vernacular name(s): candalabra aloe

Scientific family name: *Liliaceae*

Vernacular family name: lily

Go to ITIS*^{ca} for more taxonomic information on: [Aloe arborescens](#)

References:

Agriculture Quebec. 1975. Noms des maladies des plantes du Canada/ Names of plant diseases in Canada. , Quebec City, Que., Canada. 288 pp.

Alex, J. F., Cayouette, R., Mulligan, G. A. 1980. Common and botanical names of weeds in Canada/Noms populaire et scientifiques des plantes nuisibles du Canada. Revised. Agric. Can. Publ., Ottawa, Ont., Canada. 132 pp.

Bailey, L. H., Bailey, E. Z. 1976. Hortus third. Revised. MacMillan, New York, N.Y., USA. 1290 pp.

Scoggan, H. J. 1978, 1979. The flora of Canada. Nat. Mus. Nat. Sci. (Ottawa) Publ. Bot. 7(1)-7(4). 1711 pp.

Van Wijk, H. L. 1911. A dictionary of plant names. Martinus Nijhoff, The Hague, The Netherlands. 1444 pp.

Victorin, M. 1964. Flore Laurentienne. 2nd ed. Univ. Montreal, Montreal, Que., Canada. 952 pp.

Geographic Information

Plant or plant parts used in or around the home.

References:

Bailey, L. H., Bailey, E. Z. 1976. Hortus third. Revised. MacMillan, New York, N.Y., USA. 1290 pp.

Boivin, B. 1966, 1967. Énumération des plantes du Canada. Provencheria 6. Nat. Can. (Que.) 93: 253-274; 371-437; 583-646; 989-1063. 94: 131-157; 471-528; 625-655.

Image or illustration

candalabra aloe:

Images: images.google.com

Toxic parts:

plant juices

References:

Nakamura, T., Kotajima, S. 1984. Contact dermatitis from *Aloe arborescens*. Contact Dermatitis, 11: 51.

Shoji, A. 1982. Contact dermatitis to *Aloe arborescens*. Contact Dermatitis, 8: 164-167.

Animals/Human Poisoning:

Note: When an animal is listed without additional information, the literature (as of 1993) contained no detailed explanation.

Humans

General symptoms of poisoning:

[eczema](#)

[erythema](#)

References:

Shoji, A. 1982. Contact dermatitis to *Aloe arborescens*. Contact Dermatitis, 8: 164-167.

[Another search?](#)

[Français](#) | [Contact Us](#) | [Help](#) | [Search](#) | [Canada site](#)

[Coming Events](#) | [About CBIF](#) | [Links](#) | [Reports and Publications](#) |

[Home](#)

Date modified: 2003-02-06

[Important Notices](#)



Français	Contact us	Help	Search	Canada site
Coming events	About CBIF	Links	Reports and publications	Home

Canadian Biodiversity Information Facility



Notes on poisoning: candelabra-cactus

[Introduction](#)[Interactive](#)[All poisonous plants by Botanical name](#)[All poisonous plants by Common name](#)[Important WWW Poisonous Plants sites](#)

General poisoning notes:

Candelabra-cactus (*Euphorbia lactea*) is an indoor ornamental plant. The latex (juice) of the plant contains an intense irritant that causes problems when the latex comes in contact with mucous membranes and eyes. Severe eye problems have also been experimentally produced in dogs. Ingestion should be avoided by children and family pets.

References:



Crowder, J. I., Sexton, R. R. 1964. Keratoconjunctivitis resulting from the sap of candelabra cactus and the pencil tree. Arch. Ophthalmol., 72: 476-484.

Nomenclature:

Scientific Name: *Euphorbia lactea* Haw.

Vernacular name(s): candelabra-cactus

Scientific family name: *Euphorbiaceae*

Vernacular family name: spurge

Go to ITIS*^{ca} for more taxonomic information on: [Euphorbia lactea](#)

References:

Agriculture Quebec. 1975. Noms des maladies des plantes du Canada/ Names of plant diseases in Canada. , Quebec City, Que., Canada. 288 pp.

Alex, J. F., Cayouette, R., Mulligan, G. A. 1980. Common and botanical names of weeds in Canada/Noms populaire et scientifiques des plantes nuisibles du Canada. Revised. Agric. Can. Publ., Ottawa, Ont., Canada. 132 pp.

Bailey, L. H., Bailey, E. Z. 1976. Hortus third. Revised. MacMillan, New York, N.Y., USA. 1290 pp.

Scoggan, H. J. 1978, 1979. The flora of Canada. Nat. Mus. Nat. Sci. (Ottawa) Publ. Bot. 7(1)-7(4). 1711 pp.

Van Wijk, H. L. 1911. A dictionary of plant names. Martinus Nijhoff, The Hague, The Netherlands. 1444 pp.

Victorin, M. 1964. Flore Laurentienne. 2nd ed. Univ. Montreal, Montreal, Que., Canada. 952 pp.

Geographic Information

Plant or plant parts used in or around the home.

References:

Bailey, L. H., Bailey, E. Z. 1976. Hortus third. Revised. MacMillan, New York, N.Y., USA. 1290 pp.

Boivin, B. 1966, 1967. Énumération des plantes du Canada. Provencheria 6. Nat. Can. (Que.) 93: 253-274; 371-437; 583-646; 989-1063. 94: 131-157; 471-528; 625-655.

Image or illustration

candelabra-cactus:

Images: images.google.com

Toxic parts:

latex

References:

Crowder, J. I., Sexton, R. R. 1964. Keratoconjunctivitis resulting from the sap of candelabra cactus and the pencil tree. Arch. Ophthalmol., 72: 476-484.

Animals/Human Poisoning:

Note: When an animal is listed without additional information, the literature (as of 1993) contained no detailed explanation.

Humans

General symptoms of poisoning:

[keratoconjunctivitis](#)

Notes on poisoning:

The milky sap of candelabra-cactus contains an irritant that can cause intense burning and keratoconjunctivitis if a drop gets into the eyes. In one case, a man felt intense pain in his eye followed by mild conjunctival hyperemia and punctate staining of the cornea. Within 24 h the patient had copious mucous discharge, marked conjunctival edema, swollen lids, and severe pain in the eye. A few days later the eye began to heal, with complete recovery after a couple of weeks. Experiments on dogs resulted in similar symptoms, with eventual clearing of the eyes (Crowder and Sexton 1964).

References:

Crowder, J. I., Sexton, R. R. 1964. Keratoconjunctivitis resulting from the sap of candelabra cactus and the pencil tree. Arch. Ophthalmol., 72: 476-484.

[Another search?](#)

[Français](#) | [Contact Us](#) | [Help](#) | [Search](#) | [Canada site](#)

[Coming Events](#) | [About CBIF](#) | [Links](#) | [Reports and Publications](#) |

[Home](#)

Date modified: 2003-02-06

[Important Notices](#)



Français	Contact us	Help	Search	Canada site
Coming events	About CBIF	Links	Reports and publications	Home

Canadian Biodiversity Information Facility



Notes on poisoning: caper spurge

[Introduction](#)

[Interactive](#)

[All poisonous plants by Botanical name](#)

[All poisonous plants by Common name](#)

[Important WWW Poisonous Plants sites](#)



General poisoning notes:

Caper spurge (*Euphorbia lathyris*) is an outdoor ornamental that has become naturalized in British Columbia. This plant contains an irritant toxin in the latex. Humans have been poisoned after ingesting the seed capsules, which resemble capers, a different plant. Goats apparently eat this plant without experiencing great problems, but the toxin can accumulate and can be passed through the milk (Fuller and McClintock 1986).

References:

Cooper, M. R., Johnson, A. W. 1984. Poisonous plants in Britain and their effects on animals and man. Her Majesty's Stationery Office, London, England. 305 pp.

Fuller, T. C., McClintock, E. 1986. Poisonous plants of California. Univ. California Press, Berkeley, Calif., USA. 432 pp.

Nomenclature:

Scientific Name: *Euphorbia lathyris* L.

Vernacular name(s): caper spurge

Scientific family name: *Euphorbiaceae*

Vernacular family name: spurge

Go to ITIS*^{ca} for more taxonomic information on: [Euphorbia lathyris](#)

References:

Agriculture Quebec. 1975. Noms des maladies des plantes du Canada/ Names of plant diseases in Canada. , Quebec City, Que., Canada. 288 pp.

Alex, J. F., Cayouette, R., Mulligan, G. A. 1980. Common and botanical names of weeds in Canada/Noms populaire et scientifiques des plantes nuisibles du Canada. Revised. Agric. Can. Publ., Ottawa, Ont., Canada. 132 pp.

Bailey, L. H., Bailey, E. Z. 1976. Hortus third. Revised. MacMillan, New York, N.Y., USA. 1290 pp.

Scoggan, H. J. 1978, 1979. The flora of Canada. Nat. Mus. Nat. Sci. (Ottawa) Publ. Bot. 7(1)-7(4). 1711 pp.

Van Wijk, H. L. 1911. A dictionary of plant names. Martinus Nijhoff, The Hague, The Netherlands. 1444 pp.

Victorin, M. 1964. Flore Laurentienne. 2nd ed. Univ. Montreal, Montreal, Que., Canada. 952 pp.

Geographic Information

British Columbia

References:

Bailey, L. H., Bailey, E. Z. 1976. Hortus third. Revised. MacMillan, New York, N.Y., USA. 1290 pp.

Boivin, B. 1966, 1967. Énumération des plantes du Canada. Provencheria 6. Nat. Can. (Que.) 93: 253-274; 371-437; 583-646; 989-1063. 94: 131-157; 471-528; 625-655.

Image or illustration

caper spurge:

Images: images.google.com

Toxic parts:

latex

References:

Cooper, M. R., Johnson, A. W. 1984. Poisonous plants in Britain and their effects on animals and man. Her Majesty's Stationery Office, London, England. 305 pp.

Notes on Toxic plant chemicals:

Caper spurge contains unidentified ingenol derivatives that are toxic diterpenes. The activity of the toxins are not affected by

drying or storage (Frohne and Pfander 1983, Cooper and Johnson 1984).

Toxic plant chemicals:

5-deoxyingenol

References:

Cooper, M. R., Johnson, A. W. 1984. Poisonous plants in Britain and their effects on animals and man. Her Majesty's Stationery Office, London, England. 305 pp.

Frohne, D., Pfander, H. J. 1983. A colour atlas of poisonous plants. Wolfe Publishing Ltd., London, England. 291 pp.

Animals/Human Poisoning:

Note: When an animal is listed without additional information, the literature (as of 1993) contained no detailed explanation.

Goats

Humans

General symptoms of poisoning:

[abdominal pains](#)

[diarrhea](#)

[vomiting](#)

Notes on poisoning:

Caper spurge has seed capsules that resemble true capers. In Europe, adults were poisoned when they mistakenly ingested caper spurge. They experienced intense burning of the mouth and stomach, abdominal pains, diarrhea, and eventual recovery. The latex is corrosive and causes skin irritation (Cooper and Johnson 1984, Fuller and McClintock 1986).

References:

Cooper, M. R., Johnson, A. W. 1984. Poisonous plants in Britain and their effects on animals and man. Her Majesty's Stationery Office, London, England. 305 pp.

Fuller, T. C., McClintock, E. 1986. Poisonous plants of California. Univ. California Press, Berkeley, Calif., USA. 432 pp.

[Another search?](#)

[Français](#) | [Contact Us](#) | [Help](#) | [Search](#) | [Canada site](#)
[Coming Events](#) | [About CBIF](#) | [Links](#) | [Reports and Publications](#) |
[Home](#)

Date modified: 2003-02-06

[Important Notices](#)



Français	Contact us	Help	Search	Canada site
Coming events	About CBIF	Links	Reports and publications	Home

Canadian Biodiversity Information Facility



Notes on poisoning: cardinalflower

[Introduction](#)

[Interactive](#)

[All poisonous plants by Botanical name](#)

[All poisonous plants by Common name](#)

[Important WWW Poisonous Plants sites](#)

General poisoning notes:

Cardinalflower (*Lobelia cardinalis*) is a native herb that grows along riverbanks and is occasionally found in garden flower beds as a perennial. This plant contains lobeline, which caused poisoning when misused as a home medicine. See the notes under Indian-tobacco ([Lobelia inflata](#)) for more information.



References:

Lampe, K. F., McCann, M. A. 1985. AMA Handbook of poisonous and injurious plants. American Medical Assoc. Chicago, Ill., USA. 432 pp.

Nomenclature:

Scientific Name: *Lobelia cardinalis* L.

Vernacular name(s): cardinalflower

Scientific family name: *Campanulaceae*

Vernacular family name: bellflower

Go to ITIS^{*ca} for more taxonomic information on: [Lobelia cardinalis](#)

References:

Agriculture Quebec. 1975. Noms des maladies des plantes du Canada/ Names of plant diseases in Canada. , Quebec City, Que., Canada. 288 pp.

Alex, J. F., Cayouette, R., Mulligan, G. A. 1980. Common and botanical names of weeds in Canada/Noms populaire et scientifiques des plantes nuisibles du Canada. Revised. Agric. Can. Publ., Ottawa, Ont., Canada. 132 pp.

Bailey, L. H., Bailey, E. Z. 1976. Hortus third. Revised. MacMillan, New York, N.Y., USA. 1290 pp.

Scoggan, H. J. 1978, 1979. The flora of Canada. Nat. Mus. Nat. Sci. (Ottawa) Publ. Bot. 7(1)-7(4). 1711 pp.

Van Wijk, H. L. 1911. A dictionary of plant names. Martinus Nijhoff, The Hague, The Netherlands. 1444 pp.

Victorin, M. 1964. Flore Laurentienne. 2nd ed. Univ. Montreal, Montreal, Que., Canada. 952 pp.

Geographic Information

New Brunswick
Ontario
Quebec

References:

Bailey, L. H., Bailey, E. Z. 1976. Hortus third. Revised. MacMillan, New York, N.Y., USA. 1290 pp.

Boivin, B. 1966, 1967. Énumération des plantes du Canada. Provencheria 6. Nat. Can. (Que.) 93: 253-274; 371-437; 583-646; 989-1063. 94: 131-157; 471-528; 625-655.

Image or illustration

cardinalflower:

Images: images.google.com

Toxic parts:

leaves
stems

References:

Lampe, K. F., McCann, M. A. 1985. AMA Handbook of poisonous and injurious plants. American Medical Assoc. Chicago, Ill., USA. 432 pp.

Toxic plant chemicals:

lobeline

References:

Lampe, K. F., McCann, M. A. 1985. AMA Handbook of poisonous and injurious plants. American Medical Assoc. Chicago, Ill., USA. 432 pp.

Animals/Human Poisoning:

Note: When an animal is listed without additional information, the literature (as of 1993) contained no detailed explanation.

Humans

[Another search?](#)

[Français](#) | [Contact Us](#) | [Help](#) | [Search](#) | [Canada site](#)

[Coming Events](#) | [About CBIF](#) | [Links](#) | [Reports and Publications](#) |

[Home](#)

Date modified: 2003-02-06

[Important Notices](#)



Français	Contact us	Help	Search	Canada site
Coming events	About CBIF	Links	Reports and publications	Home

Canadian Biodiversity Information Facility



Notes on poisoning: castor-bean

[Introduction](#)

[Interactive](#)

[All poisonous plants by Botanical name](#)

[All poisonous plants by Common name](#)

[Important WWW Poisonous Plants sites](#)



General poisoning notes:

Castor bean (*Ricinus communis*) is an ornamental herbaceous shrub that is occasionally planted indoors or outdoors as a rapidly growing annual ornamental. The seeds (and to a much lesser extent the leaves) contain ricin, a protein, which is highly toxic in small quantities. Humans as well as cattle, dogs, goats, horses, poultry, rabbits, sheep, and swine have been poisoned after ingesting the seeds. The seed coat must be damaged to allow water to penetrate the seed interior, thus releasing the water-soluble toxin ricin. Most reported cases of animal poisoning have occurred overseas where the seed is used as food and, if improperly treated, has caused illness and death. Humans who ingested the seeds became ill and died. The toxin has been used for of suicide and assassination. Two to four chewed seeds can cause death in children (Cooper and Johnson 1984, Griffiths et al. 1987).

DO NOT ALLOW THESE PLANTS TO SET SEEDS!!

References:

Cooper, M. R., Johnson, A. W. 1984. Poisonous plants in Britain and their effects on animals and man. Her Majesty's Stationery Office, London, England. 305 pp.

Griffiths, G. D., Leek, M. D., Gee, D. J. 1987. The toxic plant proteins ricin and abrin induce apoptotic changes in mammalian lymphoid tissues and intestine. *J. Pathol.*, 151: 221-229.

Griffiths, G., Leith, A., Green, M. 1987. Proteins that play Jekyll and Hyde. *New Sci.*, 115: 59-61.

Hoy, D. L., Catling, P. M. 1981. Necklaces from nature - seed jewelry. *Davidsonia*, 12: 63-77.

Malizia, E., Sarcinelli, L., Andreucci, G. 1977. Ricinus poisoning: a familiar epidemy. *Acta Pharm. Toxicol.*, 41:

351-361.

Nomenclature:

Scientific Name: *Ricinus communis* L.

Vernacular name(s): castor-bean

Scientific family name: *Euphorbiaceae*

Vernacular family name: spurge

Go to ITIS^{*ca} for more taxonomic information on: [Ricinus communis](#)

References:

Agriculture Quebec. 1975. Noms des maladies des plantes du Canada/ Names of plant diseases in Canada. , Quebec City, Que., Canada. 288 pp.

Alex, J. F., Cayouette, R., Mulligan, G. A. 1980. Common and botanical names of weeds in Canada/Noms populaire et scientifiques des plantes nuisibles du Canada. Revised. Agric. Can. Publ., Ottawa, Ont., Canada. 132 pp.

Bailey, L. H., Bailey, E. Z. 1976. Hortus third. Revised. MacMillan, New York, N.Y., USA. 1290 pp.

Scoggan, H. J. 1978, 1979. The flora of Canada. Nat. Mus. Nat. Sci. (Ottawa) Publ. Bot. 7(1)-7(4). 1711 pp.

Van Wijk, H. L. 1911. A dictionary of plant names. Martinus Nijhoff, The Hague, The Netherlands. 1444 pp.

Victorin, M. 1964. Flore Laurentienne. 2nd ed. Univ. Montreal, Montreal, Que., Canada. 952 pp.

Geographic Information

Plant or plant parts used in or around the home.

References:

Bailey, L. H., Bailey, E. Z. 1976. Hortus third. Revised. MacMillan, New York, N.Y., USA. 1290 pp.

Boivin, B. 1966, 1967. Énumération des plantes du Canada. Provencheria 6. Nat. Can. (Que.) 93: 253-274; 371-437; 583-646; 989-1063. 94: 131-157; 471-528; 625-655.

Image or illustration

castor-bean:

Images: images.google.com

Notes on Poisonous plant parts:

The ricin content is highest in the seeds, although a small fraction of the toxin is contained in the leaves. Swallowing a seed without chewing prevents the release of the toxin because of the hard seed coat. However, chewing the seed allows release of the water-soluble chemical, and poisoning can occur (Cooper and Johnson 1984).

Toxic parts:

seeds

References:

Cooper, M. R., Johnson, A. W. 1984. Poisonous plants in Britain and their effects on animals and man. Her Majesty's Stationery Office, London, England. 305 pp.

Hoy, D. L., Catling, P. M. 1981. Necklaces from nature - seed jewelry. *Davidsonia*, 12: 63-77.

Notes on Toxic plant chemicals:

Ricin, a simple protein (a toxalbumin), is one of the most potent naturally occurring substances. Ricin is soluble in water and is therefore not present in extracted oil. Another protein, called ricinus agglutinin (or ricin), causes hemagglutinating activity, coagulation of the red blood cells. Toxicity from this protein disappears after heat treatment, usually as steam. After the oil is extracted, the remaining pomace is used in some countries as animal feed, if properly treated with heat and water. There is wide variation in sensitivity to the toxin in different species. A lethal dose by injection may be as small as two-millionths of body weight.

Experimental oral lethal doses are as follows:

horses	0.1 g/ kg
cattle, foals, rabbits, sheep, swine	1-2 g/kg
goats	5.5 g/kg

Because ricin is a protein, antibodies can be produced by

immunization, which allows animals to withstand up to 800 times a normal lethal dose. Ricin has been used by secret intelligence services as an assassination weapon. In one case, the Bulgarian secret police used a 1.53 mm metal pellet containing a reservoir for a few hundred millionths of a gram of ricin to kill a Bulgarian broadcaster. The pellet was injected by use of an umbrella, and the man died within 4 days (Cooper and Johnson 1984, Griffiths et al. 1987).

Toxic plant chemicals:

ricin

References:

Cooper, M. R., Johnson, A. W. 1984. Poisonous plants in Britain and their effects on animals and man. Her Majesty's Stationery Office, London, England. 305 pp.

Griffiths, G., Leith, A., Green, M. 1987. Proteins that play Jekyll and Hyde. *New Sci.*, 115: 59-61.

Stirpe, F., Barbieri, L. 1986. Ribosome-inactivating proteins up to date. *FEBS (Fed. Eur. Biochem. Soc.) Lett.*, 195: 1-8.

Animals/Human Poisoning:

Note: When an animal is listed without additional information, the literature (as of 1993) contained no detailed explanation.

Cattle

General symptoms of poisoning:

[abortion](#)

[breathing, shallow](#)

[death](#)

[diarrhea](#)

[weakness](#)

Notes on poisoning:

Cattle have been poisoned overseas after ingesting improperly treated castor bean products such as cattle cakes. Symptoms include severe diarrhea with blood and mucous in the feces, abortions, a drastic reduction in milk yield, and death of newborn calves. Weakness, feeble pulse, shortness of breath, and swollen joints have also occurred. Temperature was subnormal, with the pulse fast and weak. The lethal dose was estimated at 250 g of husks. Postmortem findings showed hemorrhaging in the heart,

degeneration of the kidneys and liver, and intense inflammation and erosion of the intestinal membranes. Symptoms are similar for other types of animals (Cooper and Johnson 1984).

References:

Cooper, M. R., Johnson, A. W. 1984. Poisonous plants in Britain and their effects on animals and man. Her Majesty's Stationery Office, London, England. 305 pp.

Chickens

General symptoms of poisoning:

[death](#)

References:

Cooper, M. R., Johnson, A. W. 1984. Poisonous plants in Britain and their effects on animals and man. Her Majesty's Stationery Office, London, England. 305 pp.

Horses

General symptoms of poisoning:

[abdominal pains](#)

[sweating](#)

[temperature, elevated](#)

Notes on poisoning:

The accidental addition of castor beans into grain given to horses caused sweating, a rocking gait, rapid pulse, muscle spasms, elevated temperature, and abdominal pains. The early symptoms may be confused with respiratory infection (Cooper and Johnson 1984).

References:

Cooper, M. R., Johnson, A. W. 1984. Poisonous plants in Britain and their effects on animals and man. Her Majesty's Stationery Office, London, England. 305 pp.

Humans

General symptoms of poisoning:

[abdominal pains](#)

[death](#)

[diarrhea](#)

[fever](#)

[nausea](#)

[vomiting](#)

Notes on poisoning:

Two to four chewed seeds may be enough to cause death in children. Symptoms of poisoning include abdominal pains, diarrhea, vomiting, nausea, drowsiness, dehydration, incoordination, and hematuria. In cases of acute toxicity, symptoms appear after several hours to a few days, although they can occur quickly. Griffiths et al. (1987) found that ricin causes apoptotic changes: cytoplasmic shrinkage, nuclear condensation, and breakdown of cells into membrane-bound fragments. Large-scale disruption in lymphoid tissues occurs. Death has been accidental or purposeful (Malizia et al. 1977, Griffiths et al. 1987). Castor bean contains an unknown potent respiratory allergen. Repeated exposure increases sensitivity (Cooper and Johnson 1984).

References:

Cooper, M. R., Johnson, A. W. 1984. Poisonous plants in Britain and their effects on animals and man. Her Majesty's Stationery Office, London, England. 305 pp.

Griffiths, G. D., Leek, M. D., Gee, D. J. 1987. The toxic plant proteins ricin and abrin induce apoptotic changes in mammalian lymphoid tissues and intestine. *J. Pathol.*, 151: 221-229.

Griffiths, G., Leith, A., Green, M. 1987. Proteins that play Jekyll and Hyde. *New Sci.*, 115: 59-61.

Hoy, D. L., Catling, P. M. 1981. Necklaces from nature - seed jewelry. *Davidsonia*, 12: 63-77.

Malizia, E., Sarcinelli, L., Andreucci, G. 1977. Ricinus poisoning: a familiar epidemy. *Acta Pharm. Toxicol.*, 41: 351-361.

Poultry

General symptoms of poisoning:

[diarrhea](#)

[feathers, ruffled](#)

Notes on poisoning:

In one case of accidental poisoning, poultry deteriorated rapidly, showing ruffled feathers, drooping wings, and grayish combs and wattles. Their crops were impacted for days, egg laying ceased,

and molting started. Several birds died (Cooper and Johnson 1984).

References:

Cooper, M. R., Johnson, A. W. 1984. Poisonous plants in Britain and their effects on animals and man. Her Majesty's Stationery Office, London, England. 305 pp.

Sheep

Swine

General symptoms of poisoning:

[convulsions](#)

[death](#)

[incoordination](#)

[vomiting](#)

[weakness](#)

References:

Cooper, M. R., Johnson, A. W. 1984. Poisonous plants in Britain and their effects on animals and man. Her Majesty's Stationery Office, London, England. 305 pp.

[Another search?](#)

[Français](#) | [Contact Us](#) | [Help](#) | [Search](#) | [Canada site](#)

[Coming Events](#) | [About CBIF](#) | [Links](#) | [Reports and Publications](#) |

[Home](#)

Date modified: 2003-02-06

[Important Notices](#)



Français	Contact us	Help	Search	Canada site
Coming events	About CBIF	Links	Reports and publications	Home

Canadian Biodiversity Information Facility



Notes on poisoning: celery-leaved buttercup

[Introduction](#)[Interactive](#)[All poisonous plants by Botanical name](#)[All poisonous plants by Common name](#)[Important WWW Poisonous Plants sites](#)

General poisoning notes:

Celery-leaved buttercup (*Ranunculus sceleratus*) is a native herb found across most of Canada. This plant contains a toxic irritant that produces protoanemonin upon mastication. All types of livestock can become ill upon ingestion, but cattle are most commonly affected. Horses and goats have also been poisoned (Cooper and Johnson 1984, Fuller and McClintock 1986).

References:

Cooper, M. R., Johnson, A. W. 1984. Poisonous plants in Britain and their effects on animals and man. Her Majesty's Stationery Office, London, England. 305 pp.

Fuller, T. C., McClintock, E. 1986. Poisonous plants of California. Univ. California Press, Berkeley, Calif., USA. 432 pp.

Nomenclature:

Scientific Name: *Ranunculus sceleratus* L.

Vernacular name(s): celery-leaved buttercup

Scientific family name: *Ranunculaceae*

Vernacular family name: crowfoot

Go to ITIS^{*ca} for more taxonomic information on: [Ranunculus sceleratus](#)

References:

Agriculture Quebec. 1975. Noms des maladies des plantes du Canada/ Names of plant diseases in Canada. , Quebec City, Que., Canada. 288 pp.

Alex, J. F., Cayouette, R., Mulligan, G. A. 1980. Common and botanical names of weeds in Canada/Noms populaire et scientifiques des plantes nuisibles du Canada. Revised. Agric. Can. Publ., Ottawa, Ont., Canada. 132 pp.

Bailey, L. H., Bailey, E. Z. 1976. Hortus third. Revised. MacMillan, New York, N.Y., USA. 1290 pp.

Scoggan, H. J. 1978, 1979. The flora of Canada. Nat. Mus. Nat. Sci. (Ottawa) Publ. Bot. 7(1)-7(4). 1711 pp.

Van Wijk, H. L. 1911. A dictionary of plant names. Martinus Nijhoff, The Hague, The Netherlands. 1444 pp.

Victorin, M. 1964. Flore Laurentienne. 2nd ed. Univ. Montreal, Montreal, Que., Canada. 952 pp.

Geographic Information

Alberta
British Columbia
Labrador
Manitoba
Newfoundland
Northwest Territories
Ontario
Quebec
Saskatchewan
Yukon Territory

References:

Bailey, L. H., Bailey, E. Z. 1976. Hortus third. Revised. MacMillan, New York, N.Y., USA. 1290 pp.

Boivin, B. 1966, 1967. Énumération des plantes du Canada. Provencheria 6. Nat. Can. (Que.) 93: 253-274; 371-437; 583-646; 989-1063. 94: 131-157; 471-528; 625-655.

Image or illustration

celery-leaved buttercup:

Images: images.google.com

Notes on Poisonous plant parts:

The plant juices contain the glycoside, which is converted to the irritant protoanemonin. The concentration is highest during flowering (Cooper and Johnson 1984).

Toxic parts:

plant juices

References:

Cooper, M. R., Johnson, A. W. 1984. Poisonous plants in Britain and their effects on animals and man. Her Majesty's Stationery Office, London, England. 305 pp.

Notes on Toxic plant chemicals:

Ranunculin, a glycoside, becomes a volatile irritant, protoanemonin, after enzyme-mediated conversion through mastication (Cooper and Johnson 1984).

Toxic plant chemicals:

ranunculin

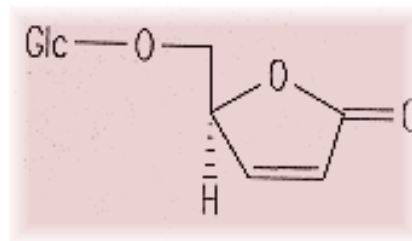

Chemical diagram(s) are courtesy of [Ruth McDiarmid](#), Biochemistry Technician, Kamloops Range Station, Agriculture and Agri-Food Canada, Kamloops, British Columbia, Canada.

References:

Cooper, M. R., Johnson, A. W. 1984. Poisonous plants in Britain and their effects on animals and man. Her Majesty's Stationery Office, London, England. 305 pp.

Animals/Human Poisoning:

Note: When an animal is listed without additional information, the literature (as of 1993) contained no detailed explanation.

Cattle

General symptoms of poisoning:

[abdominal pains](#)

[blindness](#)

[constipation](#)

[diarrhea](#)
[gait, unsteady](#)
[mouth, irritation of](#)
[salivation](#)

Notes on poisoning:

Ingesting the celery-leaved buttercup causes salivation, abdominal pain, and inflammation of the mouth. In more serious cases, severe ulceration of the mouth and of the digestive and urinary systems occurs. The animal excretes dark-colored diarrhea and urine. Unsteady gait occurs in the hind legs, and vision can be impaired or lost. Convulsion precedes death, although fatalities are rare. Animals should not be allowed to graze pastures for at least 2 weeks after spraying with 2,4-D because the plants may be grazed selectively by animals (Cooper and Johnson 1984).

References:

Cooper, M. R., Johnson, A. W. 1984. Poisonous plants in Britain and their effects on animals and man. Her Majesty's Stationery Office, London, England. 305 pp.

Fuller, T. C., McClintock, E. 1986. Poisonous plants of California. Univ. California Press, Berkeley, Calif., USA. 432 pp.

Goats

General symptoms of poisoning:

[abdominal pains](#)
[death](#)
[mouth, irritation of](#)

References:

Cooper, M. R., Johnson, A. W. 1984. Poisonous plants in Britain and their effects on animals and man. Her Majesty's Stationery Office, London, England. 305 pp.

Horses

General symptoms of poisoning:

[blindness, temporary](#)
[colic](#)
[convulsions](#)
[muscle spasms](#)
[paralysis](#)

Notes on poisoning:

A horse was poisoned after ingesting celery-leaved buttercup. Symptoms included paralysis, muscle tremors, colic, convulsions, and loss of hearing and sight. Recovery occurred over a few days but weakness persisted (Cooper and Johnson 1984).

References:

Cooper, M. R., Johnson, A. W. 1984. Poisonous plants in Britain and their effects on animals and man. Her Majesty's Stationery Office, London, England. 305 pp.

[Another search?](#)

[Français](#) | [Contact Us](#) | [Help](#) | [Search](#) | [Canada site](#)

[Coming Events](#) | [About CBIF](#) | [Links](#) | [Reports and Publications](#) | [Home](#)

Date modified: 2003-02-06

[Important Notices](#)



Français	Contact us	Help	Search	Canada site
Coming events	About CBIF	Links	Reports and publications	Home

Canadian Biodiversity Information Facility



Notes on poisoning: Chinese-lantern

[Introduction](#)[Interactive](#)[All poisonous plants by
Botanical name](#)[All poisonous plants by
Common name](#)[Important WWW Poisonous
Plants sites](#)

General poisoning notes:

Chinese-lantern (*Physalis alkekengi*) is an outdoor ornamental grown for its lantern-shaped fruit cover (pericarp). The enclosed immature fruits contain sufficient quantities of solanine to cause gastroenteritis and diarrhea in children. The mature fruits are apparently edible (Lampe and McCann 1985).

References:

Lampe, K. F., McCann, M. A. 1985. AMA Handbook of poisonous and injurious plants. American Medical Assoc. Chicago, Ill., USA. 432 pp.

Nomenclature:

Scientific Name: *Physalis alkekengi* L.

Vernacular name(s): Chinese-lantern

Scientific family name: *Solanaceae*

Vernacular family name: nightshade

Go to ITIS^{*ca} for more taxonomic information on: [Physalis alkekengi](#)

References:

Agriculture Quebec. 1975. Noms des maladies des plantes du Canada/ Names of plant diseases in Canada. , Quebec City, Que., Canada. 288 pp.

Alex, J. F., Cayouette, R., Mulligan, G. A. 1980. Common and botanical names of weeds in Canada/Noms populaire et scientifiques des plantes nuisibles du Canada. Revised. Agric. Can. Publ., Ottawa, Ont., Canada. 132 pp.

Bailey, L. H., Bailey, E. Z. 1976. Hortus third. Revised. MacMillan, New York, N.Y., USA. 1290 pp.

Scoggan, H. J. 1978, 1979. The flora of Canada. Nat. Mus. Nat. Sci. (Ottawa) Publ. Bot. 7(1)-7(4). 1711 pp.

Van Wijk, H. L. 1911. A dictionary of plant names. Martinus Nijhoff, The Hague, The Netherlands. 1444 pp.

Victorin, M. 1964. Flore Laurentienne. 2nd ed. Univ. Montreal, Montreal, Que., Canada. 952 pp.

Geographic Information

Plant or plant parts used in or around the home.

References:

Bailey, L. H., Bailey, E. Z. 1976. Hortus third. Revised. MacMillan, New York, N.Y., USA. 1290 pp.

Boivin, B. 1966, 1967. Énumération des plantes du Canada. Provencheria 6. Nat. Can. (Que.) 93: 253-274; 371-437; 583-646; 989-1063. 94: 131-157; 471-528; 625-655.

Image or illustration

Chinese-lantern:

Images: images.google.com

Toxic parts:

immature fruit

References:

Lampe, K. F., McCann, M. A. 1985. AMA Handbook of poisonous and injurious plants. American Medical Assoc. Chicago, Ill., USA. 432 pp.

Notes on Toxic plant chemicals:

Solanine, a bitter glycoalkaloid, is found in the immature berries. Ripe fruit is apparently edible (Lampe and McCann 1985, Fuller and McClintock 1986).

Toxic plant chemicals:

solanine

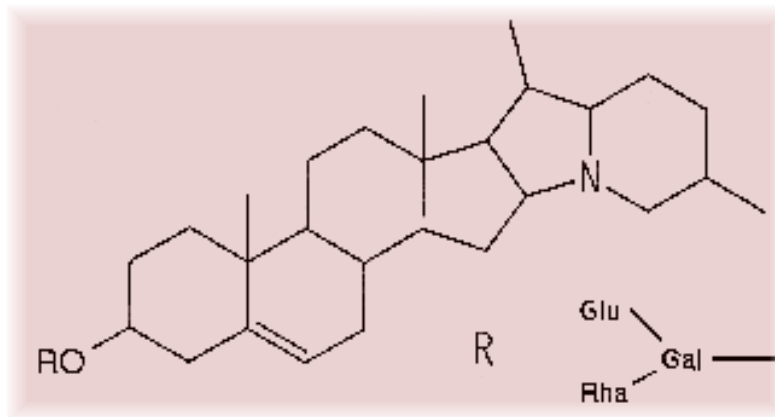

Chemical diagram(s) are courtesy of [Ruth McDiarmid](#), Biochemistry Technician, Kamloops Range Station, Agriculture and Agri-Food Canada, Kamloops, British Columbia, Canada.

References:

Fuller, T. C., McClintock, E. 1986. Poisonous plants of California. Univ. California Press, Berkeley, Calif., USA. 432 pp.

Lampe, K. F., McCann, M. A. 1985. AMA Handbook of poisonous and injurious plants. American Medical Assoc. Chicago, Ill., USA. 432 pp.

Animals/Human Poisoning:

Note: When an animal is listed without additional information, the literature (as of 1993) contained no detailed explanation.

Humans

General symptoms of poisoning:

[diarrhea](#)

[fever](#)

[gastroenteritis](#)

Notes on poisoning:

Symptoms include diarrhea, gastroenteritis, fever, and a scratchy feeling at the back of the throat a few hours after ingestion (Lampe and McCann 1985).

References:

Lampe, K. F., McCann, M. A. 1985. AMA Handbook of poisonous and injurious plants. American Medical Assoc. Chicago, Ill., USA. 432 pp.

[Another search?](#)

[Français](#) | [Contact Us](#) | [Help](#) | [Search](#) | [Canada site](#)

[Coming Events](#) | [About CBIF](#) | [Links](#) | [Reports and Publications](#) | [Home](#)

Date modified: 2003-02-06

[Important Notices](#)



Français	Contact us	Help	Search	Canada site
Coming events	About CBIF	Links	Reports and publications	Home

Canadian Biodiversity Information Facility



Notes on poisoning: chives

[Introduction](#)

[Interactive](#)

[All poisonous plants by Botanical name](#)

[All poisonous plants by Common name](#)

[Important WWW Poisonous Plants sites](#)

General poisoning notes:

Horses have been poisoned in Japan by ingesting the leaves of chive (*Allium schoenoprasum*) in early spring. Chives have escaped cultivation and have been naturalized in various parts of Canada, but the plants are not abundant.



References:

Kobayashi, T. 1950. Studies on the histo-pathologic changes of experimental cases of the "Ezonegi-poisoning" in horses. Jpn. J. Vet. Sci., 12: 209.

Nomenclature:

Scientific Name: *Allium schoenoprasum* L.

Vernacular name(s): chives

Scientific family name: *Liliaceae*

Vernacular family name: lily

Go to ITIS*^{ca} for more taxonomic information on: [Allium schoenoprasum](#)

References:

Agriculture Quebec. 1975. Noms des maladies des plantes du Canada/ Names of plant diseases in Canada. , Quebec City, Que., Canada. 288 pp.

Alex, J. F., Cayouette, R., Mulligan, G. A. 1980. Common and botanical names of weeds in Canada/Noms populaire et scientifiques des plantes nuisibles du Canada. Revised. Agric. Can. Publ., Ottawa, Ont., Canada. 132 pp.

Bailey, L. H., Bailey, E. Z. 1976. Hortus third. Revised. MacMillan, New York, N.Y., USA. 1290 pp.

Scoggan, H. J. 1978, 1979. The flora of Canada. Nat. Mus. Nat. Sci. (Ottawa) Publ. Bot. 7(1)-7(4). 1711 pp.

Van Wijk, H. L. 1911. A dictionary of plant names. Martinus Nijhoff, The Hague, The Netherlands. 1444 pp.

Victorin, M. 1964. Flore Laurentienne. 2nd ed. Univ. Montreal, Montreal, Que., Canada. 952 pp.

Geographic Information

Alberta
British Columbia
Labrador
New Brunswick
Newfoundland
Northwest Territories
Nova Scotia
Ontario
Quebec
Saskatchewan
Yukon Territory

References:

Bailey, L. H., Bailey, E. Z. 1976. Hortus third. Revised. MacMillan, New York, N.Y., USA. 1290 pp.

Boivin, B. 1966, 1967. Énumération des plantes du Canada. Provencheria 6. Nat. Can. (Que.) 93: 253-274; 371-437; 583-646; 989-1063. 94: 131-157; 471-528; 625-655.

Image or illustration

chives:

Images: images.google.com

Toxic parts:

leaves

References:

Kobayashi, T. 1950. Studies on the histo-pathologic changes of experimental cases of the "Ezonegi-poisoning" in horses. Jpn. J. Vet. Sci., 12: 209.

Animals/Human Poisoning:

Note: When an animal is listed without additional information, the literature (as of 1993) contained no detailed explanation.

Horses

General symptoms of poisoning:

[hemoglobinuria](#)

[icterus](#)

References:

Kobayashi, T. 1950. Studies on the histo-pathologic changes of experimental cases of the "Ezonegi-poisoning" in horses. Jpn. J. Vet. Sci., 12: 209.

[Another search?](#)

[Français](#) | [Contact Us](#) | [Help](#) | [Search](#) | [Canada site](#)

[Coming Events](#) | [About CBIF](#) | [Links](#) | [Reports and Publications](#) |

[Home](#)

Date modified: 2003-02-06

[Important Notices](#)



Français	Contact us	Help	Search	Canada site
Coming events	About CBIF	Links	Reports and publications	Home



Notes on poisoning: chrysanthemum

[Introduction](#)

[Interactive](#)

[All poisonous plants by Botanical name](#)

[All poisonous plants by Common name](#)

[Important WWW Poisonous Plants sites](#)

General poisoning notes:

Chrysanthemum (*Chrysanthemum indicum*) and cultivated hybrids (*C. X morifolium* Ramat.) are perennial ornamentals grown indoors and outdoors. Some humans develop contact dermatitis after extended exposure to garden chrysanthemums. This is an occupational hazard of florists, nursery workers, and gardeners. (Rook and Mitchell 1979, Frohne and Pfander 1983).

References:



Mitchell, J. C., Rook, A. 1979. Botanical dermatology. Greenglass Ltd, Vancouver, B.C., Canada. 787 pp.

Nomenclature:

Scientific Name: *Chrysanthemum indicum* L.

Vernacular name(s): chrysanthemum

Scientific family name: *Compositae*

Vernacular family name: composite

Go to ITIS^{*ca} for more taxonomic information on:

[Chrysanthemum indicum](#)

References:

Agriculture Quebec. 1975. Noms des maladies des plantes du Canada/ Names of plant diseases in Canada. , Quebec City, Que., Canada. 288 pp.

Alex, J. F., Cayouette, R., Mulligan, G. A. 1980. Common and botanical names of weeds in Canada/Noms populaire et scientifiques des plantes nuisibles du Canada. Revised. Agric. Can. Publ., Ottawa, Ont., Canada. 132 pp.

Bailey, L. H., Bailey, E. Z. 1976. Hortus third. Revised. MacMillan, New York, N.Y., USA. 1290 pp.

Scoggan, H. J. 1978, 1979. The flora of Canada. Nat. Mus. Nat. Sci. (Ottawa) Publ. Bot. 7(1)-7(4). 1711 pp.

Van Wijk, H. L. 1911. A dictionary of plant names. Martinus Nijhoff, The Hague, The Netherlands. 1444 pp.

Victorin, M. 1964. Flore Laurentienne. 2nd ed. Univ. Montreal, Montreal, Que., Canada. 952 pp.

Geographic Information

Plant or plant parts used in or around the home.

References:

Bailey, L. H., Bailey, E. Z. 1976. Hortus third. Revised. MacMillan, New York, N.Y., USA. 1290 pp.

Boivin, B. 1966, 1967. Énumération des plantes du Canada. Provencheria 6. Nat. Can. (Que.) 93: 253-274; 371-437; 583-646; 989-1063. 94: 131-157; 471-528; 625-655.

Image or illustration

chrysanthemum:

Images: images.google.com

Toxic parts:

leaves

References:

Frohne, D., Pfander, H. J. 1983. A colour atlas of poisonous plants. Wolfe Publishing Ltd., London, England. 291 pp.

Notes on Toxic plant chemicals:

Arteglasin A is a sesquiterpene lactone of the quaianolide type and is one of the active allergens of garden chrysanthemums. A cross-link can form between this chemical and sulfhydryl groups of body proteins so that complete antigens are produced. Repeated exposure can cause the allergic reaction. Humans who are sensitive to one member of the Compositae family can become sensitive to other members of the plant family, such as yarrow (*Achillea millefolium*) or wild chamomile (*Matricaria chamomilla*) (Mitchell

and Rook 1979; Frohne and Pfander 1983).

Toxic plant chemicals:

arteglasin A

References:

Frohne, D., Pfander, H. J. 1983. A colour atlas of poisonous plants. Wolfe Publishing Ltd., London, England. 291 pp.

Mitchell, J. C., Rook, A. 1979. Botanical dermatology. Greenglass Ltd, Vancouver, B.C., Canada. 787 pp.

Animals/Human Poisoning:

Note: When an animal is listed without additional information, the literature (as of 1993) contained no detailed explanation.

Humans

[Another search?](#)

[Français](#) | [Contact Us](#) | [Help](#) | [Search](#) | [Canada site](#)

[Coming Events](#) | [About CBIF](#) | [Links](#) | [Reports and Publications](#) |

[Home](#)

Date modified: 2003-02-06

[Important Notices](#)



Français	Contact us	Help	Search	Canada site
Coming events	About CBIF	Links	Reports and publications	Home

Canadian Biodiversity Information Facility



Notes on poisoning: climbing nightshade

[Introduction](#)[Interactive](#)[All poisonous plants by Botanical name](#)[All poisonous plants by Common name](#)[Important WWW Poisonous Plants sites](#)

General poisoning notes:

Climbing nightshade (*Solanum dulcamara*) is a naturalized woody vine that is found along fencerows, among shrubbery, and at wood edges across most of southern Canada. The plant, especially in its green immature fruits, contains steroidal alkaloids, which have caused poisoning in cattle and sheep. Humans may have been poisoned after ingesting immature berries. Recent experiments show that the mature red berries contain only a small amount of toxin and have little chance of harming children (Alexander et al. 1948, Cooper and Johnson 1984, Hornfeldt and Collins 1989).



References:

- Alexander, R. F., Forbes, G. B., Hawkins, E. S. 1948. A fatal case of solanine poisoning. *Br. Med. J.*, 2: 518.
- Cooper, M. R., Johnson, A. W. 1984. Poisonous plants in Britain and their effects on animals and man. Her Majesty's Stationery Office, London, England. 305 pp.
- Hornfeldt, C. S., Collins, J. E. 1989. Determination of the toxicity of nightshade berries, *Solanum dulcamara*. *Vet. Hum. Toxicol.*, 31: 363.
- Hornfeldt, C. S., Collins, J. E. 1990. Toxicity of nightshade berries (*Solanum dulcamara*) in mice. *Clin. Toxicol.*, 28: 185-192.
- Keeler, R. F., Baker, D. C., Gaffield, W. 1990. Spirosolane-containing *Solanum* species and induction of congenital craniofacial malformations. *Toxicol.*, 28: 873-884.

Nomenclature:

Scientific Name: *Solanum dulcamara* L.

Vernacular name(s): climbing nightshade

Scientific family name: *Solanaceae*

Vernacular family name: nightshade

Go to ITIS*^{ca} for more taxonomic information on: [Solanum dulcamara](#)

References:

- Agriculture Quebec. 1975. Noms des maladies des plantes du Canada/ Names of plant diseases in Canada. , Quebec City, Que., Canada. 288 pp.
- Alex, J. F., Cayouette, R., Mulligan, G. A. 1980. Common and botanical names of weeds in Canada/Noms populaire et scientifiques des plantes nuisibles du Canada. Revised. Agric. Can. Publ., Ottawa, Ont., Canada. 132 pp.
- Bailey, L. H., Bailey, E. Z. 1976. Hortus third. Revised. MacMillan, New York, N.Y., USA. 1290 pp.
- Scoggan, H. J. 1978, 1979. The flora of Canada. Nat. Mus. Nat. Sci. (Ottawa) Publ. Bot. 7(1)-7(4). 1711 pp.
- Van Wijk, H. L. 1911. A dictionary of plant names. Martinus Nijhoff, The Hague, The Netherlands. 1444 pp.
- Victorin, M. 1964. Flore Laurentienne. 2nd ed. Univ. Montreal, Montreal, Que., Canada. 952 pp.

Geographic Information

Alberta
British Columbia
Manitoba
New Brunswick
Newfoundland
Nova Scotia
Ontario
Prince Edward Island
Quebec
Saskatchewan

References:

- Bailey, L. H., Bailey, E. Z. 1976. Hortus third. Revised. MacMillan, New York, N.Y., USA. 1290 pp.
- Boivin, B. 1966, 1967. Énumération des plantes du Canada. Provencheria 6. Nat. Can. (Que.) 93: 253-274; 371-437; 583-646; 989-1063. 94: 131-157; 471-528; 625-655.

Image or illustration

climbing nightshade:

Images: images.google.com

Notes on Poisonous plant parts:

The immature green berries of climbing nightshade have been shown to be toxic to hamsters and mice. Mature red berries did not cause symptoms in mice. Doses were administered (8 mg/kg by orogastric needle) and symptoms occurred within 5-24 h when green berries were given. Ripened berries of climbing nightshade do not appear to present a hazard to children (Baker et al. 1989, Hornfeldt and Collins 1989).

Toxic parts:

immature fruit
leaves

References:

Baker, D. C., Keeler, R. F., Gaffield, W. 1989. Pathology in hamsters administered *Solanum* plant species that contain steroidal alkaloids. *Toxicon*, 27: 1331-1337.

Cooper, M. R., Johnson, A. W. 1984. Poisonous plants in Britain and their effects on animals and man. Her Majesty's Stationery Office, London, England. 305 pp.

Hornfeldt, C. S., Collins, J. E. 1989. Determination of the toxicity of nightshade berries, *Solanum dulcamara*. *Vet. Hum. Toxicol.*, 31: 363.

Notes on Toxic plant chemicals:

Immature green berries of climbing nightshade contain parent steroidal alkaloid aglycones: 50% solasodine and 50% of another aglycone thought to be soladulcidine. The total alkaloid concentration has been found to be 0.030% of dry matter in the green berries. Water gavage of dry green fruit suspension caused some deaths when given at the rate of 1.4-2.0 g per hamster (avg. wt. 190 g) (Baker et al. 1989).

Toxic plant chemicals:

soladulcidine
solanine

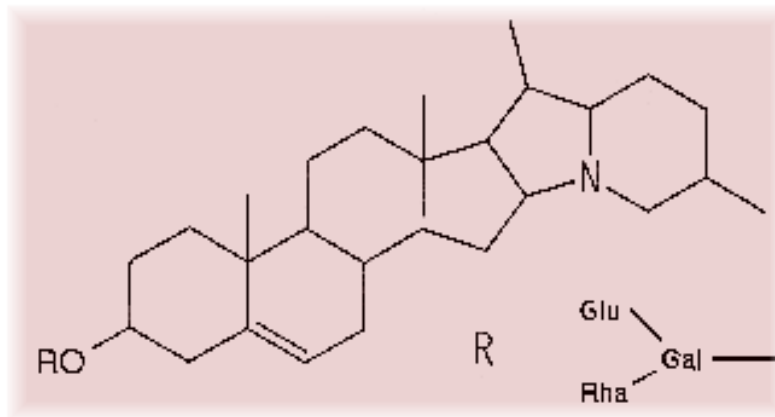

solasodine

Chemical diagram(s) are courtesy of [Ruth McDiarmid](#), Biochemistry Technician, Kamloops Range Station, Agriculture and Agri-Food Canada, Kamloops, British Columbia, Canada.

References:

Baker, D. C., Keeler, R. F., Gaffield, W. 1989. Pathology in hamsters administered *Solanum* plant species that contain steroidal alkaloids. *Toxicon*, 27: 1331-1337.

Animals/Human Poisoning:

Note: When an animal is listed without additional information, the literature (as of 1993) contained no detailed explanation.

Cattle

General symptoms of poisoning:

[incoordination](#)

[muscle spasms](#)

[nervousness](#)

[regurgitation](#)

[salivation](#)

[temperature, depressed](#)

[vomiting](#)

Notes on poisoning:

Cattle that ingested the plant in Britain exhibited symptoms of nervousness, rapid pulse, incoordination, and edema to the front part of the body. The flesh of a slaughtered animal smelled strongly of the plant (Cooper and Johnson 1984).

References:

Cooper, M. R., Johnson, A. W. 1984. Poisonous plants in Britain and their effects on animals and man. Her Majesty's Stationery Office, London, England. 305 pp.

Humans

General symptoms of poisoning:

[abdominal pains](#)

[breathing, labored](#)

[death](#)

[dyspnea](#)

[gastroenteritis](#)

[lethargy](#)

[thirsty](#)

[vomiting](#)

Notes on poisoning:

A child who probably ingested the berries of climbing nightshade died 2 days after exhibiting symptoms of vomiting, weakness, thirst, abdominal pain, dyspnea, and cyanosis. Postmortem examination showed acute inflammation of the mucosa of the stomach and intestines. An alkaloid (7 mg) characteristic of solanine was found in the liver. The evidence is not conclusive, but the child was eating blackberries in an area full of climbing nightshade berries (Alexander et al. 1948).

References:

Alexander, R. F., Forbes, G. B., Hawkins, E. S. 1948. A fatal case of solanine poisoning. Br. Med. J., 2: 518.

Hornfeldt, C. S., Collins, J. E. 1990. Toxicity of nightshade berries (*Solanum dulcamara*) in mice. Clin. Toxicol., 28: 185-192.

Rodents

General symptoms of poisoning:

[breathing, labored](#)

[craniofacial problems](#)

[death](#)

Notes on poisoning:

Tests with mice show that ingesting green (unripe) berries can cause gastroenteritis lesions, labored breathing, and lethargy. Villous atrophy of the small intestine also occurred. The red (ripe) berries did not cause any problems (Hornfeldt and Collins 1990). Tests with unripe berries on

pregnant hamsters induced congenital craniofacial malformations in fetuses in 16% of cases. Dosages administered were high, resulting in the death of some dams. Severe gastrointestinal necrosis caused the deaths. Fetuses showed encephalocele with occasional cleft palate and harelip. Another member of the genus (*Solanum sarrachoides* Sendt.; hairy nightshade) also caused a few problems in fetuses, but the numbers were not statistically significant (Keeler et al. 1990).

References:

Hornfeldt, C. S., Collins, J. E. 1990. Toxicity of nightshade berries (*Solanum dulcamara*) in mice. Clin. Toxicol., 28: 185-192.

Keeler, R. F., Baker, D. C., Gaffield, W. 1990. Spirosolane-containing *Solanum* species and induction of congenital craniofacial malformations. Toxicol., 28: 873-884.

Sheep

General symptoms of poisoning:

[death](#)

[diarrhea](#)

[falling down](#)

[gait, staggering](#)

[pupil dilation](#)

[temperature, elevated](#)

Notes on poisoning:

In one case in Britain, sheep ingested climbing nightshade plant material and developed rapid respiration, feeble pulse, elevated temperature, dilated pupils, and green diarrhea, then death. Postmortem findings showed dark, tarry blood, contracted ventricles, and plant material in the stomach (Cooper and Johnson 1984).

References:

Cooper, M. R., Johnson, A. W. 1984. Poisonous plants in Britain and their effects on animals and man. Her Majesty's Stationery Office, London, England. 305 pp.

[Another search?](#)

[Français](#) | [Contact Us](#) | [Help](#) | [Search](#) | [Canada site](#)

[Coming Events](#) | [About CBIF](#) | [Links](#) | [Reports and Publications](#) | [Home](#)

Date modified: 2003-02-06

[Important Notices](#)



Français	Contact us	Help	Search	Canada site
Coming events	About CBIF	Links	Reports and publications	Home
Canadian Biodiversity Information Facility				



Notes on poisoning: cocklebur

[Introduction](#)

[Interactive](#)

[All poisonous plants
by Botanical name](#)

[All poisonous plants
by Common name](#)

[Important WWW
Poisonous Plants sites](#)

General poisoning notes:

Cocklebur (*Xanthium strumarium*) is a naturalized annual herb found across southern Canada, where it grows in wet soils and agricultural fields. The toxic glycoside carboxyatractyloside is found in the seeds and the cotyledons of seedlings. Livestock are most commonly poisoned after ingesting the cotyledons (seed leaves) of young seedlings. The toxin quickly dissipates as the seedlings grow. Cattle, horses, and swine are often poisoned and die after ingesting this plant. This plant can produce allergic contact dermatitis in susceptible humans (Mitchell and Rook 1979, Weaver and Lechowicz 1983, Burrows and Tyrl 1989).

References:

Burrows, G. E., Tyrl, R. J. 1989. Plants causing sudden death in livestock. Clin. Toxicol., 5: 263-289.

Cole, R. J., Cutler, H. G., Stuart, B. P. 1989. Carboxyatractyloside. Pages 253-263 in Cheeke, P. R., ed. Toxicants of plant origin. Vol. II. Glycosides. CRC Press, Inc., Boca Raton, Fla., USA. 277 pp.

Martin, T. M., Stair, E. L., Dawson, L. 1986. Cocklebur poisoning in cattle. J. Am. Vet. Med. Assoc., 189: 562-563.

Mitchell, J. C., Rook, A. 1979. Botanical dermatology. Greenglass Ltd, Vancouver, B.C., Canada. 787 pp.

Weaver, S. E., Lechowicz, M. J. 1983. The biology of Canadian weeds. 56. *Xanthium strumarium* L. Can. J. Plant Sci., 63: 211-225.

Nomenclature:

Scientific Name: *Xanthium strumarium* L.

Vernacular name(s): cocklebur

Scientific family name: *Compositae*

Vernacular family name: composite

Go to ITIS*ca for more taxonomic information on: [Xanthium strumarium](#)

References:

Agriculture Quebec. 1975. Noms des maladies des plantes du Canada/ Names of plant diseases in Canada. , Quebec City, Que., Canada. 288 pp.

Alex, J. F., Cayouette, R., Mulligan, G. A. 1980. Common and botanical names of weeds in

Canada/Noms populaire et scientifiques des plantes nuisibles du Canada. Revised. Agric. Can. Publ., Ottawa, Ont., Canada. 132 pp.

Bailey, L. H., Bailey, E. Z. 1976. Hortus third. Revised. MacMillan, New York, N.Y., USA. 1290 pp.

Scoggan, H. J. 1978, 1979. The flora of Canada. Nat. Mus. Nat. Sci. (Ottawa) Publ. Bot. 7(1)-7(4). 1711 pp.

Van Wijk, H. L. 1911. A dictionary of plant names. Martinus Nijhoff, The Hague, The Netherlands. 1444 pp.

Victorin, M. 1964. Flore Laurentienne. 2nd ed. Univ. Montreal, Montreal, Que., Canada. 952 pp.

Geographic Information

Alberta
British Columbia
Manitoba
New Brunswick
Nova Scotia
Ontario
Prince Edward Island
Quebec
Saskatchewan

References:

Bailey, L. H., Bailey, E. Z. 1976. Hortus third. Revised. MacMillan, New York, N.Y., USA. 1290 pp.

Boivin, B. 1966, 1967. Énumération des plantes du Canada. Provencheria 6. Nat. Can. (Que.) 93: 253-274; 371-437; 583-646; 989-1063. 94: 131-157; 471-528; 625-655.

Image or illustration

cocklebur:

Images: images.google.com

Notes on Poisonous plant parts:

The toxin is found in the seeds and in the cotyledons (or seed leaves) of the seedlings (Cole et al. 1980).

Toxic parts:

seedlings
seeds

References:

Cole, R. J., Stuart, B. P., Lansden, J. A., Cox, R. H. 1980. Isolation and redefinition of the toxic agent from cocklebur (*Xanthium strumarium*). J. Agric. Food Chem., 28: 1330-1332.

Notes on Toxic plant chemicals:

A highly toxic glycoside, carboxyatractyloside, is contained in the seeds and seedlings of cocklebur. The amount of the chemical was measured at 0.457% in the seeds and 0.12% in the seedling at the two-leaf stage. The poison occurs only in the cotyledons or seed leaves of the seedlings. The toxin readily disappears after germination (Cole et al. 1980).

Toxic plant chemicals:

carboxyatractyloside

References:

Cole, R. J., Cutler, H. G., Stuart, B. P. 1989. Carboxyatractyloside. Pages 253-263 in Cheeke, P. R., ed. Toxicants of plant origin. Vol. II. Glycosides. CRC Press, Inc., Boca Raton, Fla., USA. 277 pp.

Cole, R. J., Stuart, B. P., Lansden, J. A., Cox, R. H. 1980. Isolation and redefinition of the toxic agent from cocklebur (*Xanthium strumarium*). J. Agric. Food Chem., 28: 1330-1332.

Animals/Human Poisoning:

Note: When an animal is listed without additional information, the literature (as of 1993) contained no detailed explanation.

Cattle

General symptoms of poisoning:

[anorexia](#)

[convulsions](#)

[death](#)

[depression](#)

[dyspnea](#)

[muscle, weakness of](#)

[nausea](#)

[opisthotonos](#)

Notes on poisoning:

Poisoning after ingesting cocklebur cotyledons from seedlings has resulted in symptoms including anorexia, depression, nausea, dyspnea, opisthotonos, and spasmodic running motions. Kidney discoloration and liver discoloration with acute hepatocellular centrilobular necrosis also occurs. Death often occurs, and treatment is symptomatic (Martin et al. 1986).

References:

Martin, T. M., Stair, E. L., Dawson, L. 1986. Cocklebur poisoning in cattle. J. Am. Vet. Med. Assoc., 189: 562-563.

Humans

General symptoms of poisoning:

[erythema](#)

References:

Mitchell, J. C., Rook, A. 1979. Botanical dermatology. Greenglass Ltd, Vancouver, B.C., Canada. 787 pp.

Rodents

General symptoms of poisoning:

[death](#)

Notes on poisoning:

Experimental use of carboxyatractyloside (CAT) in mice and rats, had an LD-50 (i.p. or injections into the peritoneal or abdominal cavity) of:

;

10.6 (7.5-15.1) mg/kg for mice 2.9 (1.5-5.8) mg/kg for rats

; Postmortem examination revealed prominent hepatic lobular accentuation in rats (Cole et al. 1989).

References:

Cole, R. J., Cutler, H. G., Stuart, B. P. 1989. Carboxyatractyloside. Pages 253-263 in Cheeke, P. R., ed. Toxicants of plant origin. Vol. II. Glycosides. CRC Press, Inc., Boca Raton, Fla., USA. 277 pp.

Swine

General symptoms of poisoning:

[anorexia](#)

[death](#)

[depression](#)

[incoordination](#)

[muscle spasms](#)

[vomiting](#)

Notes on poisoning:

Pigs are poisoned after ingesting cotyledons equal to 1-2% of body weight or 20% of macerated burs containing seeds. Intoxication can occur within a few hours and symptoms include anorexia, depression, weakness, a tucked-up appearance, and spasmodic muscular activity. Postmortem findings reveal extensive serofibrinous effusions of protein- rich fluid in the peritoneal cavity. Scattered pericardial and subcutaneous lesions may also occur. Hepatic necrosis can occur (Burrows and Tyrl 1989).

References:

Burrows, G. E., Tyrl, R. J. 1989. Plants causing sudden death in livestock. Clin. Toxicol., 5: 263-289.

[Another search?](#)

[Français](#) | [Contact Us](#) | [Help](#) | [Search](#) | [Canada site](#)

[Coming Events](#) | [About CBIF](#) | [Links](#) | [Reports and Publications](#) | [Home](#)

Date modified: 2003-02-06

[Important Notices](#)



Français	Contact us	Help	Search	Canada site
Coming events	About CBIF	Links	Reports and publications	Home

Canadian Biodiversity Information Facility



Notes on poisoning: Colorado rubberweed

[Introduction](#)[Interactive](#)[All poisonous plants by Botanical name](#)[All poisonous plants by Common name](#)[Important WWW Poisonous Plants sites](#)

General poisoning notes:

Colorado rubberweed (*Hymenoxys richardsonii*) is a native herb found in the southern prairies. This plant has caused poisoning and death in sheep, goats, and occasionally cattle. Sheep and goats consume this plant when there is little else to eat. Poisoning is therefore most frequent in spring and late autumn, when other forage is reduced. Cattle are poisoned less frequently because they find the plant unpalatable (Cheeke and Schull 1985).

References:

Cheeke, P. R., Shull, L. R. 1985. Natural toxicants in feeds and poisonous plants. AVI Publishing Company, Inc., Westport, Conn., USA. 492 pp.

Parker, K. W. 1936. Prevention of death losses in sheep on areas infested with pingue (*Actinea richardsoni*). N. M. Agric. Exp. Stn. Bull., 241. 53 pp.

Nomenclature:

Scientific Name: *Hymenoxys richardsonii* (Hook.) Cockerell

Vernacular name(s): Colorado rubberweed

Scientific family name: *Compositae*

Vernacular family name: composite

Go to ITIS*^{ca} for more taxonomic information on: [Hymenoxys richardsonii](#)

References:

Agriculture Quebec. 1975. Noms des maladies des plantes du Canada/ Names of plant diseases in Canada. , Quebec City, Que.,

Canada. 288 pp.

Alex, J. F., Cayouette, R., Mulligan, G. A. 1980. Common and botanical names of weeds in Canada/Noms populaire et scientifiques des plantes nuisibles du Canada. Revised. Agric. Can. Publ., Ottawa, Ont., Canada. 132 pp.

Bailey, L. H., Bailey, E. Z. 1976. Hortus third. Revised. MacMillan, New York, N.Y., USA. 1290 pp.

Scoggan, H. J. 1978, 1979. The flora of Canada. Nat. Mus. Nat. Sci. (Ottawa) Publ. Bot. 7(1)-7(4). 1711 pp.

Van Wijk, H. L. 1911. A dictionary of plant names. Martinus Nijhoff, The Hague, The Netherlands. 1444 pp.

Victorin, M. 1964. Flore Laurentienne. 2nd ed. Univ. Montreal, Montreal, Que., Canada. 952 pp.

Geographic Information

Alberta
Saskatchewan

References:

Bailey, L. H., Bailey, E. Z. 1976. Hortus third. Revised. MacMillan, New York, N.Y., USA. 1290 pp.

Boivin, B. 1966, 1967. Énumération des plantes du Canada. Provencheria 6. Nat. Can. (Que.) 93: 253-274; 371-437; 583-646; 989-1063. 94: 131-157; 471-528; 625-655.

Image or illustration

Colorado rubberweed:

Images: images.google.com

Toxic parts:

all parts
leaves
stems

References:

Cheeke, P. R., Shull, L. R. 1985. Natural toxicants in feeds and poisonous plants. AVI Publishing Company, Inc., Westport, Conn., USA. 492 pp.

Notes on Toxic plant chemicals:

Hymenovin (hymenoxon) is a sesquiterpene lactone that contains an alpha-methylene-gamma-lactone moiety. This moiety inhibits the enzymatic capability of adenylate cyclase by alkylation of its thiol group. The inhibition can disrupt the cellular transmission of external signals to the internal regulatory proteins. Mercaptans, such as cysteine, may be used in treatment by partly detoxifying the moiety before it can damage cellular enzymes (Elissalde and Ivie 1987). The oral LD-50 of hymenovin (hymenoxon) is 2.9-8.5 g/kg in sheep (Cheeke and Schull 1985).

Toxic plant chemicals:

hymenovin

References:

Cheeke, P. R., Shull, L. R. 1985. Natural toxicants in feeds and poisonous plants. AVI Publishing Company, Inc., Westport, Conn., USA. 492 pp.

Elissalde, M. H., Ivie, G. W. 1987. Inhibition of macrophage adenylate cyclase by the alpha-methylene-gamma-lactone moiety of sesquiterpene lactones from forage plants. *Am. J. Vet. Res.*, 48: 148-152.

Animals/Human Poisoning:

Note: When an animal is listed without additional information, the literature (as of 1993) contained no detailed explanation.

Cattle

Goats

Sheep

General symptoms of poisoning:

[death](#)

[kidney, congestion of](#)

[liver, congestion of](#)

[lungs, congestion of](#)

[vomiting](#)

Notes on poisoning:

Symptoms of ingestion include violent vomiting, hence the name

spewing sickness. Sheep may have a green stain around the mouth. Vomited material can be inhaled, which can lead to inhalation pneumonia, permanent lung damage, or death. Lesions in the gastrointestinal tract, liver and kidney congestion, and lung damage occur. Frequent coughing and sneezing occur (Parker, Cheeke and Schull 1985).

References:

Cheeke, P. R., Shull, L. R. 1985. Natural toxicants in feeds and poisonous plants. AVI Publishing Company, Inc., Westport, Conn., USA. 492 pp.

Parker, K. W. 1936. Prevention of death losses in sheep on areas infested with pingue (*Actinea richardsoni*). N. M. Agric. Exp. Stn. Bull., 241. 53 pp.

[Another search?](#)

[Français](#) | [Contact Us](#) | [Help](#) | [Search](#) | [Canada site](#)

[Coming Events](#) | [About CBIF](#) | [Links](#) | [Reports and Publications](#) | [Home](#)

Date modified: 2003-02-06

[Important Notices](#)



Français	Contact us	Help	Search	Canada site
Coming events	About CBIF	Links	Reports and publications	Home

Canadian Biodiversity Information Facility



Notes on poisoning: common comfrey

[Introduction](#)

[Interactive](#)

[All poisonous plants by Botanical name](#)

[All poisonous plants by Common name](#)

[Important WWW Poisonous Plants sites](#)



General poisoning notes:

Common comfrey (*Symphytum officinale*) is an introduced and naturalized herb found on damp roadsides and waste places in many parts of Canada. This plant contains several pyrrolizidine alkaloids, which cause veno-occlusive symptoms, liver cirrhosis, and death. Humans have been affected after ingesting herbal teas and medicines. Rats have developed hepatocellular tumors after ingesting the alkaloid symphytine, found in common comfrey. Canadian health officials have sought to ban sale of some comfrey products. Animals normally do not ingest the plant because of the bristly hairs. Topical herbal preparations are not considered toxic because the alkaloids do not reach the liver (Steuart 1987, Huxtable 1989, Ridker and McDermott 1989). Russian comfrey (*Symphytum X uplandicum* Nym. [synonymy: *Symphytum peregrinum* Ledeb.]) has been grown in Canada in Lethbridge, Alta., and Vancouver Island, as a trial forage crop for livestock, but it was not found to be suitable. This plant may be available from some nursery seed suppliers. Russian comfrey also contains pyrrolizidine alkaloids and should not be taken internally as a herb remedy.

References:

Huxtable, R. J. 1989. Human health implications of pyrrolizidine alkaloids and herbs containing them. Pages 41-86 in Cheeke, P. R., ed. Toxicants of plant origin. Vol. I. Alkaloids. CRC Press, Inc., Boca Raton, Fla., USA. 335 pp.

Ridker, P. M., McDermott, W. V. 1989. Comfrey herb tea and hepatic veno-occlusive disease. *Lancet*, 1989: 657-658.

Steuart, G. 1987. Growing alkaloid-free comfrey. *Herbs Spices Med. Plants*, 5(4): 9.

Nomenclature:

Scientific Name: *Symphytum officinale* L.

Vernacular name(s): common comfrey

Scientific family name: *Boraginaceae*

Vernacular family name: borage

Go to ITIS^{*ca} for more taxonomic information on: [Symphytum officinale](#)

References:

Agriculture Quebec. 1975. Noms des maladies des plantes du Canada/ Names of plant diseases in Canada. , Quebec City, Que., Canada. 288 pp.

Alex, J. F., Cayouette, R., Mulligan, G. A. 1980. Common and botanical names of weeds in Canada/Noms populaire et scientifiques des plantes nuisibles du Canada. Revised. Agric. Can. Publ., Ottawa, Ont., Canada. 132 pp.

Bailey, L. H., Bailey, E. Z. 1976. Hortus third. Revised. MacMillan, New York, N.Y., USA. 1290 pp.

Scoggan, H. J. 1978, 1979. The flora of Canada. Nat. Mus. Nat. Sci. (Ottawa) Publ. Bot. 7(1)-7(4). 1711 pp.

Van Wijk, H. L. 1911. A dictionary of plant names. Martinus Nijhoff, The Hague, The Netherlands. 1444 pp.

Victorin, M. 1964. Flore Laurentienne. 2nd ed. Univ. Montreal, Montreal, Que., Canada. 952 pp.

Geographic Information

Alberta
British Columbia
New Brunswick
Newfoundland
Ontario
Quebec

References:

Bailey, L. H., Bailey, E. Z. 1976. Hortus third. Revised. MacMillan, New York, N.Y., USA. 1290 pp.

Boivin, B. 1966, 1967. Énumération des plantes du Canada. Provencheria 6. Nat. Can. (Que.) 93: 253-274; 371-437; 583-646; 989-1063. 94: 131-157; 471-528; 625-655.

Image or illustration

common comfrey:

Images: images.google.com

Notes on Poisonous plant parts:

The roots have greater concentrations of pyrrolizidine alkaloids than the leaves. Animals do not commonly ingest the plants because of the bristly leaves (Cooper and Johnson 1984, Huxtable 1989).

Toxic parts:

all parts
leaves
roots

References:

Cooper, M. R., Johnson, A. W. 1984. Poisonous plants in Britain and their effects on animals and man. Her Majesty's Stationery Office, London, England. 305 pp.

Huxtable, R. J. 1989. Human health implications of pyrrolizidine alkaloids and herbs containing them. Pages 41-86 in Cheeke, P. R., ed. Toxicants of plant origin. Vol. I. Alkaloids. CRC Press, Inc., Boca Raton, Fla., USA. 335 pp.

Notes on Toxic plant chemicals:

Common comfrey contains several pyrrolizidine alkaloids, including echimidine, heliosupine, lycopsamine, and symphytine. Alkaloids were found in the plant totalling 0.07% dry weight in roots and 0.062% in dry leaves, and 0.006% in fresh leaves. Two alkaloids found in common comfrey were shown to cause liver and bladder tumors in rats; the roots have more toxins than leaves. Some commercial products of roots and leaves sold as herbal teas and medicinal preparations have a total alkaloidal concentration of 270 mg/kg (leaves) and 2900 mg/kg (roots). Ingesting a cup of tea made from the roots may contain 8.5 mg of alkaloid, which is 26 mg per cup if the gelatinous residue is consumed. [Huxtable 1989].

Toxic plant chemicals:

echimidine

heliosupine
lycopsamine

References:

Huxtable, R. J. 1989. Human health implications of pyrrolizidine alkaloids and herbs containing them. Pages 41-86 in Cheeke, P. R., ed. Toxicants of plant origin. Vol. I. Alkaloids. CRC Press, Inc., Boca Raton, Fla., USA. 335 pp.

Animals/Human Poisoning:

Note: When an animal is listed without additional information, the literature (as of 1993) contained no detailed explanation.

Humans

General symptoms of poisoning:

[ascites](#)
[liver, cirrhosis of](#)

Notes on poisoning:

Ingesting pyrrolizidine alkaloids for several months leads to veno-occlusive problems and severe portal hypertension, which can lead to cirrhosis of the liver and death. Symptoms include ascites, edema, and reduced urinary output. Children are more susceptible than adults. In two cases, one woman was estimated to consume at least 85 mg of pyrrolizidine alkaloids from a herbal leaf preparation over 6 months; another woman consumed 512 mg over 6 months (comfrey-pepsin preparation) (Huxtable 1990). Ridker and McDermott (1989) note that pulmonary endothelial hyperplasia can also occur from direct exposure to these alkaloids. Rats have developed hepatocellular tumors because of the alkaloid symphytine.

References:

Ridker, P. M., McDermott, W. V. 1989. Comfrey herb tea and hepatic veno-occlusive disease. *Lancet*, 1989: 657-658.

[Another search?](#)

[Français](#) | [Contact Us](#) | [Help](#) | [Search](#) | [Canada site](#)

[Coming Events](#) | [About CBIF](#) | [Links](#) | [Reports and Publications](#) | [Home](#)

Date modified: 2003-02-06

[Important Notices](#)



Français	Contact us	Help	Search	Canada site
Coming events	About CBIF	Links	Reports and publications	Home

Canadian Biodiversity Information Facility



Notes on poisoning: common groundsel

[Introduction](#)

[Interactive](#)

[All poisonous plants by Botanical name](#)

[All poisonous plants by Common name](#)

[Important WWW Poisonous Plants sites](#)



General poisoning notes:

Common groundsel (*Senecio vulgaris*) is a naturalized herb found across much of Canada in fields and waste places. This plant contains pyrrolizidine alkaloids, which cause irreversible liver damage after chronic exposure. Cattle and horses have died after ingesting common groundsel. Humans use this plant in teas and herbal remedies in some parts of the world. Death occurred after some species of the genus *Senecio* were ingested. Humans should not ingest foods that contain any plant material from this genus. In a case of prenatal exposure, a mother ingested tea containing an estimated 0.343 mg of senecionine, resulting in fatal veno-occlusive disease in a newborn infant (Huxtable 1989, Spoerke and Smolinske 1990).

References:

Fuller, T. C., McClintock, E. 1986. Poisonous plants of California. Univ. California Press, Berkeley, Calif., USA. 432 pp.

Huxtable, R. J. 1989. Human health implications of pyrrolizidine alkaloids and herbs containing them. Pages 41-86 in Cheeke, P. R., ed. Toxicants of plant origin. Vol. I. Alkaloids. CRC Press, Inc., Boca Raton, Fla., USA. 335 pp.

Lessard, P., Wilson, W. D., Olander, H. J., Rogers, Q. R., Mendel, V. E. 1986. Clinicopathologic study of horses surviving pyrrolizidine alkaloid (*Senecio vulgaris*) toxicosis. Am. J. Vet. Res., 47: 1776-1780.

Mendel, V. E., Witt, M. R., Gitchell, B. S., Gribble, D. N., Rogers, Q. R., Segall, H. J., Knight, H. D. 1988. Pyrrolizidine alkaloid-induced liver disease in horses: an early diagnosis. Am. J. Vet. Res., 49: 572-578.

Spoerke, D. G., Smolinske, S. C. 1990. Toxicity of houseplants. CRC Press, Inc., Boca Raton, Fla., USA. 335 pp.

Nomenclature:

Scientific Name: *Senecio vulgaris* L.

Vernacular name(s): common groundsel

Scientific family name: *Compositae*

Vernacular family name: composite

Go to ITIS*^{ca} for more taxonomic information on: [Senecio vulgaris](#)

References:

Agriculture Quebec. 1975. Noms des maladies des plantes du Canada/ Names of plant diseases in Canada. , Quebec City, Que., Canada. 288 pp.

Alex, J. F., Cayouette, R., Mulligan, G. A. 1980. Common and botanical names of weeds in Canada/Noms populaire et scientifiques des plantes nuisibles du Canada. Revised. Agric. Can. Publ., Ottawa, Ont., Canada. 132 pp.

Bailey, L. H., Bailey, E. Z. 1976. Hortus third. Revised. MacMillan, New York, N.Y., USA. 1290 pp.

Scoggan, H. J. 1978, 1979. The flora of Canada. Nat. Mus. Nat. Sci. (Ottawa) Publ. Bot. 7(1)-7(4). 1711 pp.

Van Wijk, H. L. 1911. A dictionary of plant names. Martinus Nijhoff, The Hague, The Netherlands. 1444 pp.

Victorin, M. 1964. Flore Laurentienne. 2nd ed. Univ. Montreal, Montreal, Que., Canada. 952 pp.

Geographic Information

Alberta
British Columbia
Labrador
Manitoba
New Brunswick
Northwest Territories
Nova Scotia
Ontario
Prince Edward Island
Quebec
Saskatchewan

References:

Bailey, L. H., Bailey, E. Z. 1976. Hortus third. Revised. MacMillan, New York, N.Y., USA. 1290 pp.

Boivin, B. 1966, 1967. Énumération des plantes du Canada. Provencheria 6. Nat. Can. (Que.) 93: 253-274; 371-437; 583-646; 989-1063. 94: 131-157; 471-528; 625-655.

Image or illustration

common groundsel:

Images: images.google.com

Notes on Poisonous plant parts:

The highest concentration of pyrrolizidine alkaloids is found in the flowers and the lowest in the roots. The amount of toxin increases in the leaves, reaching a maximum just before flower maturity (Johnson and Molyneux 1986).

Toxic parts:

all parts
flowers
leaves

References:

Johnson, A. E., Molyneux, R. J. 1986. The pyrrolizidine alkaloid free base and N-oxide content of toxic range plants. J. Toxicol. Toxin Rev., 5: 256.

Notes on Toxic plant chemicals:

Senecionine, a pyrrolizidine alkaloid, is found in common groundsel. A total of less than 1% alkaloids was measured (Johnson and Molyneux 1986, Huxtable 1989).

Toxic plant chemicals:

senecionine

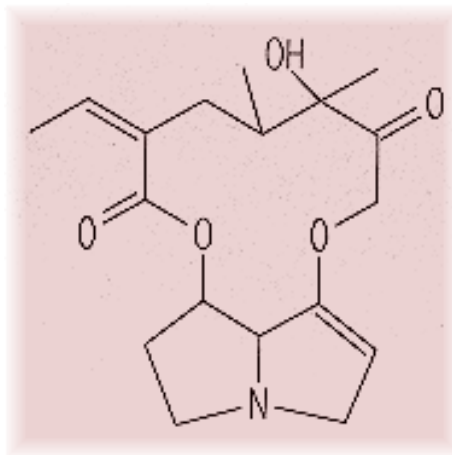

Chemical diagram(s) are courtesy of [Ruth McDiarmid](#), Biochemistry Technician, Kamloops Range Station, Agriculture and Agri-Food Canada, Kamloops, British Columbia, Canada.

References:

Huxtable, R. J. 1989. Human health implications of pyrrolizidine alkaloids and herbs containing them. Pages 41-86 in Cheeke, P. R., ed. Toxicants of plant origin. Vol. I. Alkaloids. CRC Press, Inc., Boca Raton, Fla., USA. 335 pp.

Animals/Human Poisoning:

Note: When an animal is listed without additional information, the literature (as of 1993) contained no detailed explanation.

Cattle

General symptoms of poisoning:

[blindness](#)

[death](#)

[incoordination](#)

[liver, cirrhosis of](#)

[prostration](#)

Notes on poisoning:

Cattle were poisoned after ingesting common groundsel. In some cases, calves 3-8 months old died, whereas older cows showed no clinical signs. Calves from cows eating contaminated hay during pregnancy died the following autumn. The same effects were obtained experimentally from the offspring of rats fed the toxins during pregnancy. Other symptoms include nervousness, incoordination, pushing against objects, walking in circles, and blindness with glazed eyes (Fuller and McClintock 1986).

References:

Fuller, T. C., McClintock, E. 1986. Poisonous plants of California. Univ. California Press, Berkeley, Calif., USA. 432 pp.

Horses

General symptoms of poisoning:

[anorexia](#)

[ataxia](#)

[death](#)

[depression](#)

[diarrhea](#)

[hemoglobinuria](#)

[liver, cirrhosis of](#)

Notes on poisoning:

Ingesting common groundsel leads to sickness and death. Early symptoms include anorexia and listlessness. Animal owners do not usually notice problems until liver damage occurs. Experimental tests show that routine measurement of food intake and weekly body weight can alert owners to pyrrolizidine poisoning early enough so that liver damage can be reduced. Measuring the serum bile acid is the best way to predict animal survival. Liver damage was induced in horses after they ingested an average of 233 +/- 9.2 mg of pyrrolizidine alkaloid per kilogram of body weight. Other symptoms include ataxia, head pressing, and stall walking. Megalocytic hepatopathy develops. Liver damage is often severe before obvious clinical signs develop (Lessard et al. 1986, Mendel et al. 1988).

References:

Lessard, P., Wilson, W. D., Olander, H. J., Rogers, Q. R., Mendel, V. E. 1986. Clinicopathologic study of horses surviving pyrrolizidine alkaloid (*Senecio vulgaris*) toxicosis. Am. J. Vet. Res., 47: 1776-1780.

Mendel, V. E., Witt, M. R., Gitchell, B. S., Gribble, D. N., Rogers, Q. R., Segall, H. J., Knight, H. D. 1988. Pyrrolizidine alkaloid-induced liver disease in horses: an early diagnosis. Am. J. Vet. Res., 49: 572-578.

Humans

General symptoms of poisoning:

[liver, cirrhosis of](#)

Notes on poisoning:

Common groundsel is used in herbal medicine and teas around the world. Humans should not ingest any foods, teas, or remedies that contain any plant material from the genus *Senecio*. Chronic poisoning occurs, resulting in veno-occlusive disease in children and Budd-Chiari syndrome (more commonly) in adults (Huxtable 1989).

References:

Huxtable, R. J. 1989. Human health implications of pyrrolizidine alkaloids and herbs containing them. Pages 41-86 in Cheeke, P. R., ed. Toxicants of plant origin. Vol. I. Alkaloids. CRC Press, Inc., Boca Raton, Fla., USA. 335 pp.

[Another search?](#)

[Français](#) | [Contact Us](#) | [Help](#) | [Search](#) | [Canada site](#)

[Coming Events](#) | [About CBIF](#) | [Links](#) | [Reports and Publications](#) | [Home](#)

Date modified: 2003-02-06

[Important Notices](#)



Français	Contact us	Help	Search	Canada site
Coming events	About CBIF	Links	Reports and publications	Home

Canadian Biodiversity Information Facility



Notes on poisoning: common hop

[Introduction](#)

[Interactive](#)

[All poisonous plants by Botanical name](#)

[All poisonous plants by Common name](#)

[Important WWW Poisonous Plants sites](#)

General poisoning notes:

Hop (*Humulus lupulus*) is cultivated for its use in beer-making. It is also used as an ornamental vine in many areas. Hop pickers can develop dermatitis from working with common hop plants (Raith and Jager 1984, Fuller and McClintock 1986).



References:

Fuller, T. C., McClintock, E. 1986. Poisonous plants of California. Univ. California Press, Berkeley, Calif., USA. 432 pp.

Raith, L., Jager, K. 1984. Hop allergy. Contact Dermatitis, 11: 53.

Nomenclature:

Scientific Name: *Humulus lupulus* L.

Vernacular name(s): common hop

Scientific family name: *Cannabaceae*

Vernacular family name: hemp

Go to ITIS*^{ca} for more taxonomic information on: [Humulus lupulus](#)

References:

Agriculture Quebec. 1975. Noms des maladies des plantes du Canada/ Names of plant diseases in Canada. , Quebec City, Que., Canada. 288 pp.

Alex, J. F., Cayouette, R., Mulligan, G. A. 1980. Common and botanical names of weeds in Canada/Noms populaire et scientifiques des plantes nuisibles du Canada. Revised. Agric.

Can. Publ., Ottawa, Ont., Canada. 132 pp.

Bailey, L. H., Bailey, E. Z. 1976. Hortus third. Revised. MacMillan, New York, N.Y., USA. 1290 pp.

Scoggan, H. J. 1978, 1979. The flora of Canada. Nat. Mus. Nat. Sci. (Ottawa) Publ. Bot. 7(1)-7(4). 1711 pp.

Van Wijk, H. L. 1911. A dictionary of plant names. Martinus Nijhoff, The Hague, The Netherlands. 1444 pp.

Victorin, M. 1964. Flore Laurentienne. 2nd ed. Univ. Montreal, Montreal, Que., Canada. 952 pp.

Geographic Information

British Columbia

Manitoba

New Brunswick

Nova Scotia

Ontario

Prince Edward Island

Quebec

Saskatchewan

References:

Bailey, L. H., Bailey, E. Z. 1976. Hortus third. Revised. MacMillan, New York, N.Y., USA. 1290 pp.

Boivin, B. 1966, 1967. Énumération des plantes du Canada. Provencheria 6. Nat. Can. (Que.) 93: 253-274; 371-437; 583-646; 989-1063. 94: 131-157; 471-528; 625-655.

Image or illustration

common hop:

Images: images.google.com

Notes on Poisonous plant parts:

In addition to allergic responses, the hairs on the leaves may cause mechanical abrasion of the skin (Fuller and McClintock 1986).

Toxic parts:

leaves

mature fruit

References:

Fuller, T. C., McClintock, E. 1986. Poisonous plants of California. Univ. California Press, Berkeley, Calif., USA. 432 pp.

Toxic plant chemicals:

unknown chemical

References:

Fuller, T. C., McClintock, E. 1986. Poisonous plants of California. Univ. California Press, Berkeley, Calif., USA. 432 pp.

Animals/Human Poisoning:

Note: When an animal is listed without additional information, the literature (as of 1993) contained no detailed explanation.

Humans

General symptoms of poisoning:

[blistering](#)

[conjunctivitis](#)

[erythema](#)

References:

Fuller, T. C., McClintock, E. 1986. Poisonous plants of California. Univ. California Press, Berkeley, Calif., USA. 432 pp.

Raith, L., Jager, K. 1984. Hop allergy. Contact Dermatitis, 11: 53.

[Another search?](#)

[Français](#) | [Contact Us](#) | [Help](#) | [Search](#) | [Canada site](#)

[Coming Events](#) | [About CBIF](#) | [Links](#) | [Reports and Publications](#) | [Home](#)

Date modified: 2003-02-06

[Important Notices](#)



Français	Contact us	Help	Search	Canada site
Coming events	About CBIF	Links	Reports and publications	Home

Canadian Biodiversity Information Facility



Notes on poisoning: common milkweed

[Introduction](#)

[Interactive](#)

[All poisonous plants by Botanical name](#)

[All poisonous plants by Common name](#)

[Important WWW Poisonous Plants sites](#)

General poisoning notes:

Common milkweed (*Asclepias syriaca*) is a native perennial herb found in eastern Canada in fields, ditches, and waste places. This plant has poisoned sheep in the eastern United States. The plant contains cardiac glycosides, which are toxic to animals (Reynard and Norton, Joubert 1989).



References:

Joubert, J. P. 1989. Cardiac glycosides. Pages 61-97 in Cheeke, P. R., ed. Toxicants of plant origin. Vol. II. Glycosides. CRC Press, Inc., Boca Raton, Fla., USA. 277 pp.

Reynard, G. B., Norton, J. B. 1942. Poisonous plants of Maryland in relation to livestock. Univ. MD. Agric. Exp. Stn. Bull., A10. 312 pp.

Nomenclature:

Scientific Name: *Asclepias syriaca* L.

Vernacular name(s): common milkweed

Scientific family name: *Asclepiadaceae*

Vernacular family name: milkweed

Go to ITIS^{*ca} for more taxonomic information on: [Asclepias syriaca](#)

References:

Agriculture Quebec. 1975. Noms des maladies des plantes du Canada/ Names of plant diseases in Canada. , Quebec City, Que., Canada. 288 pp.

Alex, J. F., Cayouette, R., Mulligan, G. A. 1980. Common and botanical names of weeds in Canada/Noms populaire et scientifiques des plantes nuisibles du Canada. Revised. Agric. Can. Publ., Ottawa, Ont., Canada. 132 pp.

Bailey, L. H., Bailey, E. Z. 1976. Hortus third. Revised. MacMillan, New York, N.Y., USA. 1290 pp.

Scoggan, H. J. 1978, 1979. The flora of Canada. Nat. Mus. Nat. Sci. (Ottawa) Publ. Bot. 7(1)-7(4). 1711 pp.

Van Wijk, H. L. 1911. A dictionary of plant names. Martinus Nijhoff, The Hague, The Netherlands. 1444 pp.

Victorin, M. 1964. Flore Laurentienne. 2nd ed. Univ. Montreal, Montreal, Que., Canada. 952 pp.

Geographic Information

Manitoba
New Brunswick
Nova Scotia
Ontario
Prince Edward Island
Quebec

References:

Bailey, L. H., Bailey, E. Z. 1976. Hortus third. Revised. MacMillan, New York, N.Y., USA. 1290 pp.

Boivin, B. 1966, 1967. Énumération des plantes du Canada. Provencheria 6. Nat. Can. (Que.) 93: 253-274; 371-437; 583-646; 989-1063. 94: 131-157; 471-528; 625-655.

Image or illustration

common milkweed:

Images: images.google.com

Toxic parts:

latex
leaves
stems

References:

Joubert, J. P. 1989. Cardiac glycosides. Pages 61-97 in Cheeke, P. R., ed. Toxicants of plant origin. Vol. II. Glycosides. CRC

Press, Inc., Boca Raton, Fla., USA. 277 pp.

Toxic plant chemicals:

desglucosyrioside
syrioboside
syrioside

References:

Joubert, J. P. 1989. Cardiac glycosides. Pages 61-97 in Cheeke, P. R., ed. Toxicants of plant origin. Vol. II. Glycosides. CRC Press, Inc., Boca Raton, Fla., USA. 277 pp.

Animals/Human Poisoning:

Note: When an animal is listed without additional information, the literature (as of 1993) contained no detailed explanation.

Sheep

General symptoms of poisoning:

[death](#)

Notes on poisoning:

A dozen sheep died after ingesting large amounts of common milkweed in Maryland. The plants, which were almost the only vegetation available during a drought, are normally distasteful to livestock (Reynard and Norton 1942).

References:

Reynard, G. B., Norton, J. B. 1942. Poisonous plants of Maryland in relation to livestock. Univ. MD. Agric. Exp. Stn. Bull., A10. 312 pp.

[Another search?](#)

[Français](#) | [Contact Us](#) | [Help](#) | [Search](#) | [Canada site](#)

[Coming Events](#) | [About CBIF](#) | [Links](#) | [Reports and Publications](#) |

[Home](#)

Date modified: 2003-02-06

[Important Notices](#)



Français	Contact us	Help	Search	Canada site
Coming events	About CBIF	Links	Reports and publications	Home

Canadian Biodiversity Information Facility



Notes on poisoning: common privet

[Introduction](#)[Interactive](#)[All poisonous plants by Botanical name](#)[All poisonous plants by Common name](#)[Important WWW Poisonous Plants sites](#)

General poisoning notes:

Common privet (*Ligustrum vulgare*) is an ornamental shrub that is often planted as a hedge, and therefore the flowers and berries are trimmed. In older European literature, ingesting the berries has been noted to cause sickness in children. In more recent cases of ingestion by children, symptoms included only vomiting and diarrhea, after up to 12 berries were eaten (Frohne and Pfander 1983). Reynard and Norton (1942) cite the case of sheep that died after ingesting the trimmings from a hedge of a related privet (*Ligustrum ovalifolium*).

References:

Frohne, D., Pfander, H. J. 1983. A colour atlas of poisonous plants. Wolfe Publishing Ltd., London, England. 291 pp.

Nomenclature:

Scientific Name: *Ligustrum vulgare* L.

Vernacular name(s): common privet

Scientific family name: *Oleaceae*

Vernacular family name: olive

Go to ITIS*^{ca} for more taxonomic information on: [Ligustrum vulgare](#)

References:

Agriculture Quebec. 1975. Noms des maladies des plantes du Canada/ Names of plant diseases in Canada. , Quebec City, Que., Canada. 288 pp.

Alex, J. F., Cayouette, R., Mulligan, G. A. 1980. Common and

botanical names of weeds in Canada/Noms populaire et scientifiques des plantes nuisibles du Canada. Revised. Agric. Can. Publ., Ottawa, Ont., Canada. 132 pp.

Bailey, L. H., Bailey, E. Z. 1976. Hortus third. Revised. MacMillan, New York, N.Y., USA. 1290 pp.

Scoggan, H. J. 1978, 1979. The flora of Canada. Nat. Mus. Nat. Sci. (Ottawa) Publ. Bot. 7(1)-7(4). 1711 pp.

Van Wijk, H. L. 1911. A dictionary of plant names. Martinus Nijhoff, The Hague, The Netherlands. 1444 pp.

Victorin, M. 1964. Flore Laurentienne. 2nd ed. Univ. Montreal, Montreal, Que., Canada. 952 pp.

Geographic Information

Plant or plant parts used in or around the home.

References:

Bailey, L. H., Bailey, E. Z. 1976. Hortus third. Revised. MacMillan, New York, N.Y., USA. 1290 pp.

Boivin, B. 1966, 1967. Énumération des plantes du Canada. Provencheria 6. Nat. Can. (Que.) 93: 253-274; 371-437; 583-646; 989-1063. 94: 131-157; 471-528; 625-655.

Image or illustration

common privet:

Images: images.google.com

Toxic parts:

mature fruit

References:

Frohne, D., Pfander, H. J. 1983. A colour atlas of poisonous plants. Wolfe Publishing Ltd., London, England. 291 pp.

Notes on Toxic plant chemicals:

Unknown chemicals are involved in common privet poisoning. Frohne and Pfander (1983) note that lignan glycosides, saponins, and seco- iridoid bitter substances are likely involved.

Toxic plant chemicals:

unknown chemical

References:

Frohne, D., Pfander, H. J. 1983. A colour atlas of poisonous plants. Wolfe Publishing Ltd., London, England. 291 pp.

Animals/Human Poisoning:

Note: When an animal is listed without additional information, the literature (as of 1993) contained no detailed explanation.

Humans

General symptoms of poisoning:

[diarrhea](#)

[vomiting](#)

Notes on poisoning:

In recent reports the berries of common privet produced symptoms of diarrhea and vomiting only. In older literature, death was reported. Gastroenteritis may persist for 48-72 h. (Frohne and Pfander 1983, Lampe and McCann 1985).

References:

Frohne, D., Pfander, H. J. 1983. A colour atlas of poisonous plants. Wolfe Publishing Ltd., London, England. 291 pp.

[Another search?](#)

[Français](#) | [Contact Us](#) | [Help](#) | [Search](#) | [Canada site](#)

[Coming Events](#) | [About CBIF](#) | [Links](#) | [Reports and Publications](#) | [Home](#)

Date modified: 2003-02-06

[Important Notices](#)



Français	Contact us	Help	Search	Canada site
Coming events	About CBIF	Links	Reports and publications	Home

Canadian Biodiversity Information Facility



Notes on poisoning: common vetch

[Introduction](#)

[Interactive](#)

[All poisonous plants by Botanical name](#)

[All poisonous plants by Common name](#)

[Important WWW Poisonous Plants sites](#)



General poisoning notes:

Common vetch (*Vicia sativa*) was introduced as a forage plant and is naturalized across much of Canada. Some horses and other livestock that ingested the plant were poisoned. However, these reports are in the older European literature. In the western United States, poultry that ingested the seeds of common milk vetch were poisoned and died. Common milk vetch contains a neurolathyrigen that may be partly responsible for neurolathyrism, which usually occurs in humans in India and is associated with species of grass pea (see notes under [Lathyrus sativus](#)) (Cooper and Johnson 1984, Cheeke and Schull 1985).

References:

Cheeke, P. R., Shull, L. R. 1985. Natural toxicants in feeds and poisonous plants. AVI Publishing Company, Inc., Westport, Conn., USA. 492 pp.

Cooper, M. R., Johnson, A. W. 1984. Poisonous plants in Britain and their effects on animals and man. Her Majesty's Stationery Office, London, England. 305 pp.

Nomenclature:

Scientific Name: *Vicia sativa* L.

Vernacular name(s): common vetch

Scientific family name: *Leguminosae*

Vernacular family name: pea

Go to ITIS*^{ca} for more taxonomic information on: [Vicia sativa](#)

References:

Agriculture Quebec. 1975. Noms des maladies des plantes du Canada/ Names of plant diseases in Canada. , Quebec City, Que., Canada. 288 pp.

Alex, J. F., Cayouette, R., Mulligan, G. A. 1980. Common and botanical names of weeds in Canada/Noms populaire et scientifiques des plantes nuisibles du Canada. Revised. Agric. Can. Publ., Ottawa, Ont., Canada. 132 pp.

Bailey, L. H., Bailey, E. Z. 1976. Hortus third. Revised. MacMillan, New York, N.Y., USA. 1290 pp.

Scoggan, H. J. 1978, 1979. The flora of Canada. Nat. Mus. Nat. Sci. (Ottawa) Publ. Bot. 7(1)-7(4). 1711 pp.

Van Wijk, H. L. 1911. A dictionary of plant names. Martinus Nijhoff, The Hague, The Netherlands. 1444 pp.

Victorin, M. 1964. Flore Laurentienne. 2nd ed. Univ. Montreal, Montreal, Que., Canada. 952 pp.

Geographic Information

British Columbia
Labrador
Manitoba
New Brunswick
Newfoundland
Nova Scotia
Ontario
Prince Edward Island
Quebec

References:

Bailey, L. H., Bailey, E. Z. 1976. Hortus third. Revised. MacMillan, New York, N.Y., USA. 1290 pp.

Boivin, B. 1966, 1967. Énumération des plantes du Canada. Provencheria 6. Nat. Can. (Que.) 93: 253-274; 371-437; 583-646; 989-1063. 94: 131-157; 471-528; 625-655.

Image or illustration

common vetch:

Images: images.google.com

Toxic parts:

seeds

References:

Cheeke, P. R., Shull, L. R. 1985. Natural toxicants in feeds and poisonous plants. AVI Publishing Company, Inc., Westport, Conn., USA. 492 pp.

Notes on Toxic plant chemicals:

The toxic amino acid, beta-cyano-L-alanine, is a neurotoxin that affects the nervous system (Cheeke and Schull 1985, Roy and Spencer 1989).

Toxic plant chemicals:

beta-cyano-L-alanine

References:

Cheeke, P. R., Shull, L. R. 1985. Natural toxicants in feeds and poisonous plants. AVI Publishing Company, Inc., Westport, Conn., USA. 492 pp.

Roy, D. N., Spencer, P. S. 1989. Lathrogens. Pages 169-201 in Cheeke, P. R., ed. Toxicants of plant origin. Vol. III. Proteins and amino acids. CRC Press, Inc., Boca Raton, Fla., USA. 271 pp.

Animals/Human Poisoning:

Note: When an animal is listed without additional information, the literature (as of 1993) contained no detailed explanation.

Chickens

General symptoms of poisoning:

[blindness](#)

[convulsions](#)

[death](#)

Notes on poisoning:

In western Oregon, some chicks died after ingesting seeds of common milk vetch. Symptoms included blindness, convulsions, and a pronounced chirping, resembling a pyridoxine deficiency. Experimental feeding of a diet containing 30-80% seeds has

caused these symptoms in poultry (Cooper and Johnson 1984, Cheeke and Schull 1985).

References:

Cheeke, P. R., Shull, L. R. 1985. Natural toxicants in feeds and poisonous plants. AVI Publishing Company, Inc., Westport, Conn., USA. 492 pp.

Horses

General symptoms of poisoning:

[abdominal pains](#)

[weakness](#)

[weakness, posterior](#)

Notes on poisoning:

Older European literature describes poisoning of livestock after the animals ingested common vetch. The symptoms included skin lesions, hair loss, digestive disturbances, and sometimes a loss of use of hindquarters. Postmortem examination revealed enlargement of the liver. These problems have not been reported recently (Cooper and Johnson 1984).

References:

Cooper, M. R., Johnson, A. W. 1984. Poisonous plants in Britain and their effects on animals and man. Her Majesty's Stationery Office, London, England. 305 pp.

[Another search?](#)

[Français](#) | [Contact Us](#) | [Help](#) | [Search](#) | [Canada site](#)

[Coming Events](#) | [About CBIF](#) | [Links](#) | [Reports and Publications](#) | [Home](#)

Date modified: 2003-02-06

[Important Notices](#)



Français	Contact us	Help	Search	Canada site
Coming events	About CBIF	Links	Reports and publications	Home

Canadian Biodiversity Information Facility



Notes on poisoning: corn poppy

[Introduction](#)

[Interactive](#)

[All poisonous plants by Botanical name](#)

[All poisonous plants by Common name](#)

[Important WWW Poisonous Plants sites](#)

General poisoning notes:

Corn poppy (*Papaver rhoeas*) is an ornamental herb that has become naturalized in some provinces. This plant has poisoned cattle according to early European literature. No recent cases have been described, but the plant may be potentially poisonous if animals ingest it (Cooper and Johnson 1984).



References:

Cooper, M. R., Johnson, A. W. 1984. Poisonous plants in Britain and their effects on animals and man. Her Majesty's Stationery Office, London, England. 305 pp.

Nomenclature:

Scientific Name: *Papaver rhoeas* L.

Vernacular name(s): corn poppy

Scientific family name: *Papaveraceae*

Vernacular family name: poppy

Go to ITIS^{*ca} for more taxonomic information on: [Papaver rhoeas](#)

References:

Agriculture Quebec. 1975. Noms des maladies des plantes du Canada/ Names of plant diseases in Canada. , Quebec City, Que., Canada. 288 pp.

Alex, J. F., Cayouette, R., Mulligan, G. A. 1980. Common and botanical names of weeds in Canada/Noms populaire et scientifiques des plantes nuisibles du Canada. Revised. Agric. Can. Publ., Ottawa, Ont., Canada. 132 pp.

Bailey, L. H., Bailey, E. Z. 1976. Hortus third. Revised. MacMillan, New York, N.Y., USA. 1290 pp.

Scoggan, H. J. 1978, 1979. The flora of Canada. Nat. Mus. Nat. Sci. (Ottawa) Publ. Bot. 7(1)-7(4). 1711 pp.

Van Wijk, H. L. 1911. A dictionary of plant names. Martinus Nijhoff, The Hague, The Netherlands. 1444 pp.

Victorin, M. 1964. Flore Laurentienne. 2nd ed. Univ. Montreal, Montreal, Que., Canada. 952 pp.

Geographic Information

Plant or plant parts used in or around the home.

References:

Bailey, L. H., Bailey, E. Z. 1976. Hortus third. Revised. MacMillan, New York, N.Y., USA. 1290 pp.

Boivin, B. 1966, 1967. Énumération des plantes du Canada. Provencheria 6. Nat. Can. (Que.) 93: 253-274; 371-437; 583-646; 989-1063. 94: 131-157; 471-528; 625-655.

Image or illustration

corn poppy:

Images: images.google.com

Toxic parts:

all parts
plant juices

References:

Cooper, M. R., Johnson, A. W. 1984. Poisonous plants in Britain and their effects on animals and man. Her Majesty's Stationery Office, London, England. 305 pp.

Notes on Toxic plant chemicals:

Rhoadine, an alkaloid, and other alkaloids are found in corn poppy (Cooper and Johnson 1984).

Toxic plant chemicals:

rhoadine

References:

Cooper, M. R., Johnson, A. W. 1984. Poisonous plants in Britain and their effects on animals and man. Her Majesty's Stationery Office, London, England. 305 pp.

Animals/Human Poisoning:

Note: When an animal is listed without additional information, the literature (as of 1993) contained no detailed explanation.

Cattle

General symptoms of poisoning:

[incoordination](#)

[recumbency](#)

[restlessness](#)

Notes on poisoning:

Symptoms of poisoning are similar to those caused by other poppy species, including restlessness, incoordination, muscle spasms, and falling down (Cooper and Johnson 1984).

References:

Cooper, M. R., Johnson, A. W. 1984. Poisonous plants in Britain and their effects on animals and man. Her Majesty's Stationery Office, London, England. 305 pp.

[Another search?](#)

[Français](#) | [Contact Us](#) | [Help](#) | [Search](#) | [Canada site](#)

[Coming Events](#) | [About CBIF](#) | [Links](#) | [Reports and Publications](#) |

[Home](#)

Date modified: 2003-02-06

[Important Notices](#)



Français	Contact us	Help	Search	Canada site
Coming events	About CBIF	Links	Reports and publications	Home

Canadian Biodiversity Information Facility



Notes on poisoning: croton

[Introduction](#)

[Interactive](#)

[All poisonous plants by Botanical name](#)

[All poisonous plants by Common name](#)

[Important WWW Poisonous Plants sites](#)



General poisoning notes:

Croton (*Codiaeum variegatum*) is a common houseplant. Chewing the bark and roots is said to cause burning of the mouth. Some young leaves are used in the East Indies as a vegetable, but cases of irritation have been reported. The latex has caused eczema in some gardeners (Morton 1962, Frohne and Pfander 1983).

References:

- Morton, J. F. 1962. Ornamental plants with toxic and or irritant properties. II. Proc. Fla. State Hort. Soc., 75: 484-491.
- Perkins, K. D., Payne, W. W. 1978. Guide to the poisonous and irritant plants of Florida. Univ. Fla. Agric. Ext. Serv. Circ., 441. 84 pp.

Nomenclature:

Scientific Name: *Codiaeum variegatum* (L.) Blume

Vernacular name(s): croton

Scientific family name: *Euphorbiaceae*

Vernacular family name: spurge

Go to ITIS*^{ca} for more taxonomic information on: [Codiaeum variegatum](#)

References:

- Agriculture Quebec. 1975. Noms des maladies des plantes du Canada/ Names of plant diseases in Canada. , Quebec City, Que., Canada. 288 pp.

Alex, J. F., Cayouette, R., Mulligan, G. A. 1980. Common and botanical names of weeds in Canada/Noms populaire et scientifiques des plantes nuisibles du Canada. Revised. Agric. Can. Publ., Ottawa, Ont., Canada. 132 pp.

Bailey, L. H., Bailey, E. Z. 1976. Hortus third. Revised. MacMillan, New York, N.Y., USA. 1290 pp.

Scoggan, H. J. 1978, 1979. The flora of Canada. Nat. Mus. Nat. Sci. (Ottawa) Publ. Bot. 7(1)-7(4). 1711 pp.

Van Wijk, H. L. 1911. A dictionary of plant names. Martinus Nijhoff, The Hague, The Netherlands. 1444 pp.

Victorin, M. 1964. Flore Laurentienne. 2nd ed. Univ. Montreal, Montreal, Que., Canada. 952 pp.

Geographic Information

Plant or plant parts used in or around the home.

References:

Bailey, L. H., Bailey, E. Z. 1976. Hortus third. Revised. MacMillan, New York, N.Y., USA. 1290 pp.

Boivin, B. 1966, 1967. Énumération des plantes du Canada. Provencheria 6. Nat. Can. (Que.) 93: 253-274; 371-437; 583-646; 989-1063. 94: 131-157; 471-528; 625-655.

Image or illustration

croton:

Images: images.google.com

Toxic parts:

bark
latex
leaves
roots

References:

Perkins, K. D., Payne, W. W. 1978. Guide to the poisonous and irritant plants of Florida. Univ. Fla. Agric. Ext. Serv. Circ., 441. 84 pp.

Toxic plant chemicals:

5-deoxyingenol

References:

Perkins, K. D., Payne, W. W. 1978. Guide to the poisonous and irritant plants of Florida. Univ. Fla. Agric. Ext. Serv. Circ., 441. 84 pp.

Animals/Human Poisoning:

Note: When an animal is listed without additional information, the literature (as of 1993) contained no detailed explanation.

Humans

General symptoms of poisoning:

[eczema](#)
[mouth, irritation of](#)

Notes on poisoning:

Ingesting the bark or roots has caused burning and irritation of the mouth parts. Occasional eczema has been reported after repeated exposure to the latex (Morton 1962, Frohne and Pfander 1983).

References:

Morton, J. F. 1962. Ornamental plants with toxic and or irritant properties. II. Proc. Fla. State Hortic. Soc., 75: 484-491.

Perkins, K. D., Payne, W. W. 1978. Guide to the poisonous and irritant plants of Florida. Univ. Fla. Agric. Ext. Serv. Circ., 441. 84 pp.

[Another search?](#)

[Français](#) | [Contact Us](#) | [Help](#) | [Search](#) | [Canada site](#)
[Coming Events](#) | [About CBIF](#) | [Links](#) | [Reports and Publications](#) | [Home](#)

Date modified: 2003-02-06

[Important Notices](#)



Français	Contact us	Help	Search	Canada site
Coming events	About CBIF	Links	Reports and publications	Home

Canadian Biodiversity Information Facility



Notes on poisoning: crown-of-thorns

[Introduction](#)

[Interactive](#)

[All poisonous plants by Botanical name](#)

[All poisonous plants by Common name](#)

[Important WWW Poisonous Plants sites](#)



General poisoning notes:

Crown-of-thorns (*Euphorbia milii*) is an indoor ornamental plant. The plant contains caustic and irritant chemicals in the latex. This plant should not be ingested nor should the juice be rubbed on the skin or in the eyes. Family pets should not be allowed to ingest this plant.

References:

Fuller, T. C., McClintock, E. 1986. Poisonous plants of California. Univ. California Press, Berkeley, Calif., USA. 432 pp.

Kingsbury, J. M. 1964. Poisonous plants of the United States and Canada. Prentice-Hall Inc., Englewood Cliffs, N.J., USA. 626 pp.

Nomenclature:

Scientific Name: *Euphorbia milii* Ch. des Moulins

Vernacular name(s): crown-of-thorns

Scientific family name: *Euphorbiaceae*

Vernacular family name: spurge

Go to ITIS^{*ca} for more taxonomic information on: [Euphorbia milii](#)

References:

Agriculture Quebec. 1975. Noms des maladies des plantes du Canada/ Names of plant diseases in Canada. , Quebec City, Que., Canada. 288 pp.

Alex, J. F., Cayouette, R., Mulligan, G. A. 1980. Common and botanical names of weeds in Canada/Noms populaire et scientifiques des plantes nuisibles du Canada. Revised. Agric. Can.

Publ., Ottawa, Ont., Canada. 132 pp.

Bailey, L. H., Bailey, E. Z. 1976. Hortus third. Revised. MacMillan, New York, N.Y., USA. 1290 pp.

Scoggan, H. J. 1978, 1979. The flora of Canada. Nat. Mus. Nat. Sci. (Ottawa) Publ. Bot. 7(1)-7(4). 1711 pp.

Van Wijk, H. L. 1911. A dictionary of plant names. Martinus Nijhoff, The Hague, The Netherlands. 1444 pp.

Victorin, M. 1964. Flore Laurentienne. 2nd ed. Univ. Montreal, Montreal, Que., Canada. 952 pp.

Geographic Information

Plant or plant parts used in or around the home.

References:

Bailey, L. H., Bailey, E. Z. 1976. Hortus third. Revised. MacMillan, New York, N.Y., USA. 1290 pp.

Boivin, B. 1966, 1967. Énumération des plantes du Canada. Provencheria 6. Nat. Can. (Que.) 93: 253-274; 371-437; 583-646; 989-1063. 94: 131-157; 471-528; 625-655.

Image or illustration

crown-of-thorns:

Images: images.google.com

Toxic parts:

latex

References:

Frohne, D., Pfander, H. J. 1983. A colour atlas of poisonous plants. Wolfe Publishing Ltd., London, England. 291 pp.

Notes on Toxic plant chemicals:

Unknown ingenol derivatives of toxic diterpenes are found in the latex of crown-of-thorns and have irritant properties (Frohne and Pfander 1983).

Toxic plant chemicals:

5-deoxyingenol

References:

Frohne, D., Pfander, H. J. 1983. A colour atlas of poisonous plants. Wolfe Publishing Ltd., London, England. 291 pp.

Animals/Human Poisoning:

Note: When an animal is listed without additional information, the literature (as of 1993) contained no detailed explanation.

Humans

General symptoms of poisoning:

[abdominal pains](#)

[blistering](#)

[mouth, irritation of](#)

Notes on poisoning:

Crown-of-thorns contains an irritant in the latex that causes skin irritation and problems on mucous membranes and eye tissue. Ingestion can cause irritation of the mouth and stomach, and abdominal pains (Fuller and McClintock 1986).

References:

Fuller, T. C., McClintock, E. 1986. Poisonous plants of California. Univ. California Press, Berkeley, Calif., USA. 432 pp.

Kingsbury, J. M. 1964. Poisonous plants of the United States and Canada. Prentice-Hall Inc., Englewood Cliffs, N.J., USA. 626 pp.

[Another search?](#)

[Français](#) | [Contact Us](#) | [Help](#) | [Search](#) | [Canada site](#)

[Coming Events](#) | [About CBIF](#) | [Links](#) | [Reports and Publications](#) |

[Home](#)

Date modified: 2003-02-06

[Important Notices](#)



Français	Contact us	Help	Search	Canada site
Coming events	About CBIF	Links	Reports and publications	Home

Canadian Biodiversity Information Facility



Notes on poisoning: cut-leaved coneflower

[Introduction](#)[Interactive](#)[All poisonous plants by Botanical name](#)[All poisonous plants by Common name](#)[Important WWW Poisonous Plants sites](#)

General poisoning notes:

Cut-leaved coneflower (*Rudbeckia laciniata*) is native to some parts of Canada and is naturalized in others. A double-flowered form is also used as an ornamental in flower beds and is usually called golden glow. Early circumstantial evidence of poisoning of horses, sheep, and swine can be found. Experiments on sheep and swine have shown that some symptoms of toxicity can occur, although animals generally refuse to eat the unpalatable plants. Animal poisoning by this plant should be considered unlikely (Kingsbury 1964).

References:

Kingsbury, J. M. 1964. Poisonous plants of the United States and Canada. Prentice-Hall Inc., Englewood Cliffs, N.J., USA. 626 pp.

Skidmore, L. V., Peterson, N. F. 1932. Observations on the toxicity of golden glow (*Rudbeckia laciniata*) to swine and other animals. J. Am. Vet. Med. Assoc., 34: 655-662.

Nomenclature:

Scientific Name: *Rudbeckia laciniata* L.

Vernacular name(s): cut-leaved coneflower

Scientific family name: *Compositae*

Vernacular family name: composite

Go to ITIS^{*ca} for more taxonomic information on: [Rudbeckia laciniata](#)

References:

Agriculture Quebec. 1975. Noms des maladies des plantes du

Canada/ Names of plant diseases in Canada. , Quebec City, Que., Canada. 288 pp.

Alex, J. F., Cayouette, R., Mulligan, G. A. 1980. Common and botanical names of weeds in Canada/Noms populaire et scientifiques des plantes nuisibles du Canada. Revised. Agric. Can. Publ., Ottawa, Ont., Canada. 132 pp.

Bailey, L. H., Bailey, E. Z. 1976. Hortus third. Revised. MacMillan, New York, N.Y., USA. 1290 pp.

Scoggan, H. J. 1978, 1979. The flora of Canada. Nat. Mus. Nat. Sci. (Ottawa) Publ. Bot. 7(1)-7(4). 1711 pp.

Van Wijk, H. L. 1911. A dictionary of plant names. Martinus Nijhoff, The Hague, The Netherlands. 1444 pp.

Victorin, M. 1964. Flore Laurentienne. 2nd ed. Univ. Montreal, Montreal, Que., Canada. 952 pp.

Geographic Information

Alberta
British Columbia
Manitoba
New Brunswick
Nova Scotia
Ontario
Prince Edward Island
Quebec
Saskatchewan

References:

Bailey, L. H., Bailey, E. Z. 1976. Hortus third. Revised. MacMillan, New York, N.Y., USA. 1290 pp.

Boivin, B. 1966, 1967. Énumération des plantes du Canada. Provencheria 6. Nat. Can. (Que.) 93: 253-274; 371-437; 583-646; 989-1063. 94: 131-157; 471-528; 625-655.

Image or illustration

cut-leaved coneflower:

Images: images.google.com

Notes on Poisonous plant parts:

Ingesting the aboveground portion of this plant produced symptoms in some animals (Kingsbury 1964).

Toxic parts:

flowers
leaves
stems

References:

Kingsbury, J. M. 1964. Poisonous plants of the United States and Canada. Prentice-Hall Inc., Englewood Cliffs, N.J., USA. 626 pp.

Toxic plant chemicals:

unknown chemical

References:

Kingsbury, J. M. 1964. Poisonous plants of the United States and Canada. Prentice-Hall Inc., Englewood Cliffs, N.J., USA. 626 pp.

Animals/Human Poisoning:

Note: When an animal is listed without additional information, the literature (as of 1993) contained no detailed explanation.

Horses

Sheep

General symptoms of poisoning:

[anorexia](#)

[depression](#)

[incoordination](#)

Notes on poisoning:

Experiments on sheep showed that animals ate the distasteful plant after a period of starvation. Ingesting plant material equal to 3-4% of body weight produced symptoms after 24 h. The primary symptoms were incoordination and listlessness. Respiratory rates increased. Animals returned to normal within 36 h (Kingsbury 1964).

References:

Kingsbury, J. M. 1964. Poisonous plants of the United States and Canada. Prentice-Hall Inc., Englewood Cliffs, N.J., USA. 626 pp.

Skidmore, L. V., Peterson, N. F. 1932. Observations on the toxicity of golden glow (*Rudbeckia laciniata*) to swine and other animals. J. Am. Vet. Med. Assoc., 34: 655-662.

Swine

General symptoms of poisoning:

[abdominal pains](#)

[anorexia](#)

[depression](#)

[incoordination](#)

Notes on poisoning:

In experiments, swine ate the distaste plant material after a period of starvation. The animals exhibited incoordination, dullness, some signs of abdominal pain, and aimless wandering. The symptoms disappeared within 36 h. Symptoms appeared after ingesting plant material equal to 3-4% of body weight. Symptoms could not be reproduced a second time with further feedings (Kingsbury 1964).

References:

Kingsbury, J. M. 1964. Poisonous plants of the United States and Canada. Prentice-Hall Inc., Englewood Cliffs, N.J., USA. 626 pp.

Skidmore, L. V., Peterson, N. F. 1932. Observations on the toxicity of golden glow (*Rudbeckia laciniata*) to swine and other animals. J. Am. Vet. Med. Assoc., 34: 655-662.

[Another search?](#)

[Français](#) | [Contact Us](#) | [Help](#) | [Search](#) | [Canada site](#)

[Coming Events](#) | [About CBIF](#) | [Links](#) | [Reports and Publications](#) | [Home](#)

Date modified: 2003-02-06

[Important Notices](#)



Français	Contact us	Help	Search	Canada site
Coming events	About CBIF	Links	Reports and publications	Home

Canadian Biodiversity Information Facility



Notes on poisoning: cyclamen

[Introduction](#)[Interactive](#)[All poisonous plants by Botanical name](#)[All poisonous plants by Common name](#)[Important WWW Poisonous Plants sites](#)

General poisoning notes:

Cyclamen (*Cyclamen persicum*) is a houseplant that has a toxic saponin, cyclamin, in the tuberous rhizomes. The rhizome is bitter and found underground, so that children or family pets are unlikely to be exposed to the toxins. There is no information on the amounts of saponins, if any, in cyclamen foliage (Spoerke et al. 1987).

References:

Spoerke, D. G., Spoerke, S. E., Hall, A., Rumack, B. H. 1987. Toxicity of *Cyclamen persium* (Mill). *Vet. Hum. Toxicol.*, 29: 250-251.

Nomenclature:

Scientific Name: *Cyclamen persicum* Mill.

Vernacular name(s): cyclamen

Scientific family name: *Primulaceae*

Vernacular family name: primrose

Go to ITIS*^{ca} for more taxonomic information on: [Cyclamen persicum](#)

References:

Agriculture Quebec. 1975. Noms des maladies des plantes du Canada/ Names of plant diseases in Canada. , Quebec City, Que., Canada. 288 pp.

Alex, J. F., Cayouette, R., Mulligan, G. A. 1980. Common and botanical names of weeds in Canada/Noms populaire et scientifiques des plantes nuisibles du Canada. Revised. Agric.

Can. Publ., Ottawa, Ont., Canada. 132 pp.

Bailey, L. H., Bailey, E. Z. 1976. Hortus third. Revised. MacMillan, New York, N.Y., USA. 1290 pp.

Scoggan, H. J. 1978, 1979. The flora of Canada. Nat. Mus. Nat. Sci. (Ottawa) Publ. Bot. 7(1)-7(4). 1711 pp.

Van Wijk, H. L. 1911. A dictionary of plant names. Martinus Nijhoff, The Hague, The Netherlands. 1444 pp.

Victorin, M. 1964. Flore Laurentienne. 2nd ed. Univ. Montreal, Montreal, Que., Canada. 952 pp.

Geographic Information

Plant or plant parts used in or around the home.

References:

Bailey, L. H., Bailey, E. Z. 1976. Hortus third. Revised. MacMillan, New York, N.Y., USA. 1290 pp.

Boivin, B. 1966, 1967. Énumération des plantes du Canada. Provencheria 6. Nat. Can. (Que.) 93: 253-274; 371-437; 583-646; 989-1063. 94: 131-157; 471-528; 625-655.

Image or illustration

cyclamen:

Images: images.google.com

Notes on Poisonous plant parts:

The tuberous rhizomes contain the chemical cyclamin. However, these rhizomes are in the soil and have an acrid taste, so that ingestion by children is not likely (Spoerke et al. 1987). Cyclamin is a triterpenoid saponin, which is an irritant that can cause nausea and even paralysis upon absorption. The chemical is not volatile, but it is water soluble and can occur as small white crystals or an amorphous, lusterless mass (Spoerke et al. 1987).

Toxic parts:

rhizome

tubers

References:

Frohne, D., Pfander, H. J. 1983. A colour atlas of poisonous

plants. Wolfe Publishing Ltd., London, England. 291 pp.

Notes on Toxic plant chemicals:

The tuberous rhizomes contain the chemical cyclamin. However, these rhizomes are in the soil and have an acrid taste, so that ingestion by children is not likely (Spoerke et al. 1987). Cyclamin is a triterpenoid saponin, which is an irritant that can cause nausea and even paralysis upon absorption. The chemical is not volatile, but it is water soluble and can occur as small white crystals or an amorphous, lusterless mass (Spoerke et al. 1987).

Toxic plant chemicals:

cyclamin
unknown chemical

References:

Frohne, D., Pfander, H. J. 1983. A colour atlas of poisonous plants. Wolfe Publishing Ltd., London, England. 291 pp.

Santucci, B., Picardo, M., Cristaudo, A. 1985. Contact dermatitis from *Euphorbia pulcherrima*. Contact Dermatitis, 12: 285-286.

Spoerke, D. G., Spoerke, S. E., Hall, A., Rumack, B. H. 1987. Toxicity of *Cyclamen persium* (Mill). Vet. Hum. Toxicol., 29: 250-251.

Animals/Human Poisoning:

Note: When an animal is listed without additional information, the literature (as of 1993) contained no detailed explanation.

Humans

[Another search?](#)

[Français](#) | [Contact Us](#) | [Help](#) | [Search](#) | [Canada site](#)

[Coming Events](#) | [About CBIF](#) | [Links](#) | [Reports and Publications](#) | [Home](#)

Date modified: 2003-02-06

[Important Notices](#)



Français	Contact us	Help	Search	Canada site
Coming events	About CBIF	Links	Reports and publications	Home

Canadian Biodiversity Information Facility



Notes on poisoning: cypress spurge

[Introduction](#)

[Interactive](#)

[All poisonous plants by Botanical name](#)

[All poisonous plants by Common name](#)

[Important WWW Poisonous Plants sites](#)



General poisoning notes:

Cypress spurge (*Euphorbia cyparissias*) is a naturalized herb found across southern Canada. Ingesting the plant has caused loss of cattle in New York State. This plant is usually avoided by livestock but is ingested if incorporated with hay. The plant is abundant in some locations in southern Ontario. Some humans are sensitive to the irritant latex and may develop inflammation.

References:

- Frohne, D., Pfander, H. J. 1983. A colour atlas of poisonous plants. Wolfe Publishing Ltd., London, England. 291 pp.
- Kingsbury, J. M. 1964. Poisonous plants of the United States and Canada. Prentice-Hall Inc., Englewood Cliffs, N.J., USA. 626 pp.
- Stahevitch, A. E., Crompton, C. W., Wojtas, W. A. 1988. The biology of Canadian weeds. 85. *Euphorbia cyparissias* L. Can. J. Plant Sci., 68: 175-191.

Nomenclature:

Scientific Name: *Euphorbia cyparissias* L.

Vernacular name(s): cypress spurge

Scientific family name: *Euphorbiaceae*

Vernacular family name: spurge

Go to ITIS^{*ca} for more taxonomic information on: [Euphorbia cyparissias](#)

References:

Agriculture Quebec. 1975. Noms des maladies des plantes du

Canada/ Names of plant diseases in Canada. , Quebec City, Que., Canada. 288 pp.

Alex, J. F., Cayouette, R., Mulligan, G. A. 1980. Common and botanical names of weeds in Canada/Noms populaire et scientifiques des plantes nuisibles du Canada. Revised. Agric. Can. Publ., Ottawa, Ont., Canada. 132 pp.

Bailey, L. H., Bailey, E. Z. 1976. Hortus third. Revised. MacMillan, New York, N.Y., USA. 1290 pp.

Scoggan, H. J. 1978, 1979. The flora of Canada. Nat. Mus. Nat. Sci. (Ottawa) Publ. Bot. 7(1)-7(4). 1711 pp.

Van Wijk, H. L. 1911. A dictionary of plant names. Martinus Nijhoff, The Hague, The Netherlands. 1444 pp.

Victorin, M. 1964. Flore Laurentienne. 2nd ed. Univ. Montreal, Montreal, Que., Canada. 952 pp.

Geographic Information

British Columbia
Manitoba
New Brunswick
Newfoundland
Nova Scotia
Ontario
Prince Edward Island
Quebec

References:

Bailey, L. H., Bailey, E. Z. 1976. Hortus third. Revised. MacMillan, New York, N.Y., USA. 1290 pp.

Boivin, B. 1966, 1967. Énumération des plantes du Canada. Provencheria 6. Nat. Can. (Que.) 93: 253-274; 371-437; 583-646; 989-1063. 94: 131-157; 471-528; 625-655.

Image or illustration

cypress spurge:

Images: images.google.com

Notes on Poisonous plant parts:

The toxic compounds are found in the latex and seeds (Frohne and Pfander 1983).

Toxic parts:

latex
seeds

References:

Frohne, D., Pfander, H. J. 1983. A colour atlas of poisonous plants. Wolfe Publishing Ltd., London, England. 291 pp.

Notes on Toxic plant chemicals:

Unknown ingenanes, toxic diterpenes, are found in this plant (Frohne and Pfander 1983).

Toxic plant chemicals:

5-deoxyingenol

References:

Frohne, D., Pfander, H. J. 1983. A colour atlas of poisonous plants. Wolfe Publishing Ltd., London, England. 291 pp.

Animals/Human Poisoning:

Note: When an animal is listed without additional information, the literature (as of 1993) contained no detailed explanation.

Cattle

General symptoms of poisoning:

[collapse](#)
[death](#)
[diarrhea](#)
[weakness](#)

Notes on poisoning:

Cattle that have ingested hay containing large amounts of cypress spurge have had diarrhea followed by weakness, collapse, and death (Kingsbury 1964).

References:

Kingsbury, J. M. 1964. Poisonous plants of the United States and Canada. Prentice-Hall Inc., Englewood Cliffs, N.J., USA. 626 pp.

Horses

Humans

General symptoms of poisoning:

[blistering](#)

References:

Frohne, D., Pfander, H. J. 1983. A colour atlas of poisonous plants. Wolfe Publishing Ltd., London, England. 291 pp.

Sheep

[Another search?](#)

[Français](#) | [Contact Us](#) | [Help](#) | [Search](#) | [Canada site](#)

[Coming Events](#) | [About CBIF](#) | [Links](#) | [Reports and Publications](#) |

[Home](#)

Date modified: 2003-02-06

[Important Notices](#)



Français	Contact us	Help	Search	Canada site
Coming events	About CBIF	Links	Reports and publications	Home

Canadian Biodiversity Information Facility



Notes on poisoning: daffodil

[Introduction](#)[Interactive](#)[All poisonous plants by Botanical name](#)[All poisonous plants by Common name](#)[Important WWW Poisonous Plants sites](#)

General poisoning notes:

Daffodil (*Narcissus pseudonarcissus*) is an ornamental that is planted outdoors as a spring-flowering perennial. It may be used indoors as a forced flower during the winter. The aboveground parts cause dermatitis in sensitive individuals. The bulbs can also cause dermatitis. Humans have been poisoned after ingesting bulbs thought to be onions, as have cattle when they were fed bulbs instead of feed in times of scarcity. Family pets may be at risk if they ingest daffodils (Mitchell and Rook 1979, Litovitz and Fahey 1982, Cooper and Johnson 1984).

References:

Cooper, M. R., Johnson, A. W. 1984. Poisonous plants in Britain and their effects on animals and man. Her Majesty's Stationery Office, London, England. 305 pp.

Gonçalo, S., Freitas, J. D., Sousa, I. 1987. Contact dermatitis and respiratory symptoms and *Narcissus pseudonarcissus*. Contact Dermatitis, 16: 115-116.

Litovitz, T. L., Fahey, B. A. 1982. Please don't eat the daffodils. N. Eng. J. Med., 306: 547.

Mitchell, J. C., Rook, A. 1979. Botanical dermatology. Greenglass Ltd, Vancouver, B.C., Canada. 787 pp.

Nomenclature:

Scientific Name: *Narcissus pseudonarcissus* L.

Vernacular name(s): daffodil

Scientific family name: *Amaryllidaceae*

Vernacular family name: amaryllis

Go to ITIS^{*ca} for more taxonomic information on: [Narcissus pseudonarcissus](#)

References:

Agriculture Quebec. 1975. Noms des maladies des plantes du Canada/ Names of plant diseases in Canada. , Quebec City, Que., Canada. 288 pp.

Alex, J. F., Cayouette, R., Mulligan, G. A. 1980. Common and botanical names of weeds in Canada/Noms populaire et scientifiques des plantes nuisibles du Canada. Revised. Agric. Can. Publ., Ottawa, Ont., Canada. 132 pp.

Bailey, L. H., Bailey, E. Z. 1976. Hortus third. Revised. MacMillan, New York, N.Y., USA. 1290 pp.

Scoggan, H. J. 1978, 1979. The flora of Canada. Nat. Mus. Nat. Sci. (Ottawa) Publ. Bot. 7(1)-7(4). 1711 pp.

Van Wijk, H. L. 1911. A dictionary of plant names. Martinus Nijhoff, The Hague, The Netherlands. 1444 pp.

Victorin, M. 1964. Flore Laurentienne. 2nd ed. Univ. Montreal, Montreal, Que., Canada. 952 pp.

Geographic Information

Plant or plant parts used in or around the home.

References:

Bailey, L. H., Bailey, E. Z. 1976. Hortus third. Revised. MacMillan, New York, N.Y., USA. 1290 pp.

Boivin, B. 1966, 1967. Énumération des plantes du Canada. Provencheria 6. Nat. Can. (Que.) 93: 253-274; 371-437; 583-646; 989-1063. 94: 131-157; 471-528; 625-655.

Image or illustration

daffodil:

Images: images.google.com

Notes on Poisonous plant parts:

The bulbs of narcissus are toxic if ingested. All parts of the plant can cause allergic dermatitis in sensitive humans (Mitchell and Rook 1979).

Toxic parts:

bulbs
flowers
leaves
stems

References:

Gonçalo, S., Freitas, J. D., Sousa, I. 1987. Contact dermatitis and respiratory symptoms and *Narcissus pseudonarcissus*. Contact Dermatitis, 16: 115-116.

Lampe, K. F., McCann, M. A. 1985. AMA Handbook of poisonous and injurious plants. American Medical Assoc. Chicago, Ill., USA. 432 pp.

Mitchell, J. C., Rook, A. 1979. Botanical dermatology. Greenglass Ltd, Vancouver, B.C., Canada. 787 pp.

Toxic plant chemicals:

lycorine

References:

Lampe, K. F., McCann, M. A. 1985. AMA Handbook of poisonous and injurious plants. American Medical Assoc. Chicago, Ill., USA. 432 pp.

Animals/Human Poisoning:

Note: When an animal is listed without additional information, the literature (as of 1993) contained no detailed explanation.

Cattle

General symptoms of poisoning:

[convulsions](#)

[drowsiness](#)

[gastroenteritis](#)

Notes on poisoning:

During World War II, cattle were fed daffodil bulbs because of scarce feed. They developed seizures, sedation, hypotension, and gastrointestinal and hepatic degeneration. Animal poisoning is more severe than human poisoning because humans develop rapid emesis (Litovitz and Fahey 1982, Cooper and Johnson

1984).

References:

Cooper, M. R., Johnson, A. W. 1984. Poisonous plants in Britain and their effects on animals and man. Her Majesty's Stationery Office, London, England. 305 pp.

Litovitz, T. L., Fahey, B. A. 1982. Please don't eat the daffodils. N. Eng. J. Med., 306: 547.

Humans

General symptoms of poisoning:

[abdominal pains](#)

[conjunctivitis](#)

[diarrhea](#)

[dizziness](#)

[dyspnea](#)

[eczema](#)

[erythema](#)

[hoarseness](#)

[itchiness](#)

[nausea](#)

[vomiting](#)

Notes on poisoning:

Ingesting daffodil bulbs produces the following symptoms: abdominal pains, vomiting, nausea, lightheadedness, shivering, and sometimes diarrhea. Because emesis is rapid, more severe symptoms do not usually occur. Ingesting bulbs is rare (Litovitz and Fahey 1982, Lampe and McCann 1985).

References:

Gonçalo, S., Freitas, J. D., Sousa, I. 1987. Contact dermatitis and respiratory symptoms and *Narcissus pseudonarcissus*. Contact Dermatitis, 16: 115-116.

Litovitz, T. L., Fahey, B. A. 1982. Please don't eat the daffodils. N. Eng. J. Med., 306: 547.

Mitchell, J. C., Rook, A. 1979. Botanical dermatology. Greenglass Ltd, Vancouver, B.C., Canada. 787 pp.

[Another search?](#)

[Français](#) | [Contact Us](#) | [Help](#) | [Search](#) | [Canada site](#)

[Coming Events](#) | [About CBIF](#) | [Links](#) | [Reports and Publications](#) | [Home](#)

Date modified: 2003-02-06

[Important Notices](#)



Français	Contact us	Help	Search	Canada site
Coming events	About CBIF	Links	Reports and publications	Home

Canadian Biodiversity Information Facility



Notes on poisoning: death camas

[Introduction](#)

[Interactive](#)

[All poisonous plants by Botanical name](#)

[All poisonous plants by Common name](#)

[Important WWW Poisonous Plants sites](#)



General poisoning notes:

Death camas (*Zigadenus venenosus*) is a native perennial herb that is found from British Columbia to southwestern Saskatchewan. The plant is one of the most toxic springtime plants, especially to sheep. Cattle and horses are also occasionally poisoned. Swine vomit the plant so readily that no natural cases of poisoning have been reported. Poultry may also be poisoned, although there are no reported cases. Honey bees are poisoned by the nectar and pollen (Kingsbury 1964, Barker 1978; Panter and James 1989). Humans have also been poisoned after ingesting the bulbs, which were mistaken for other plants such as onions (*Allium* spp.) or camas (*Camassia quamash*). Ingesting the flowers and flower buds has caused poisoning in children (Cameron 1952, Spoerke and Spoerke 1979). These plants should be considered poisonous to all livestock and humans.

References:

- Barker, R. J. 1980. Poisoning by plants. Pages 275-296 in Morse, R. A., ed. Honey bee pests, predators, and diseases. Cornell University Press, Ithaca, N.Y., USA. 430 pp.
- Cameron, K. 1952. Death camas poisoning. Northwest Med., 1952: 682-683.
- Dayton, W. A. 1960. Notes on western range forbes. U. S. For. Serv. Wash. Agric. Hand., 161. 254 pp.
- Kingsbury, J. M. 1964. Poisonous plants of the United States and Canada. Prentice-Hall Inc., Englewood Cliffs, N.J., USA. 626 pp.
- Long, R. 1981. Some liliaceae of British Columbia. Davidsonia, 12: 85-88.
- Panter, K. E., James, L. F. 1989. Death camas-early grazing can be hazardous. Rangelands, 11: 147-149.
- Spoerke, D. G., Spoerke, S. E. 1979. Three cases of *Zigadenus* (death camas) poisoning. Vet. Hum. Toxicol., 21: 346-347.

Nomenclature:

Scientific Name: *Zigadenus venenosus* S. Wats.

Vernacular name(s): death camas

Scientific family name: *Liliaceae*

Vernacular family name: lily

Go to ITIS^{*ca} for more taxonomic information on: [Zigadenus venenosus](#)

References:

Agriculture Quebec. 1975. Noms des maladies des plantes du Canada/ Names of plant diseases in Canada. , Quebec City, Que., Canada. 288 pp.

Alex, J. F., Cayouette, R., Mulligan, G. A. 1980. Common and botanical names of weeds in Canada/Noms populaire et scientifiques des plantes nuisibles du Canada. Revised. Agric. Can. Publ., Ottawa, Ont., Canada. 132 pp.

Bailey, L. H., Bailey, E. Z. 1976. Hortus third. Revised. MacMillan, New York, N.Y., USA. 1290 pp.

Scoggan, H. J. 1978, 1979. The flora of Canada. Nat. Mus. Nat. Sci. (Ottawa) Publ. Bot. 7(1)-7(4). 1711 pp.

Van Wijk, H. L. 1911. A dictionary of plant names. Martinus Nijhoff, The Hague, The Netherlands. 1444 pp.

Victorin, M. 1964. Flore Laurentienne. 2nd ed. Univ. Montreal, Montreal, Que., Canada. 952 pp.

Geographic Information

Alberta

British Columbia

Saskatchewan

References:

Bailey, L. H., Bailey, E. Z. 1976. Hortus third. Revised. MacMillan, New York, N.Y., USA. 1290 pp.

Boivin, B. 1966, 1967. Énumération des plantes du Canada. Provencheria 6. Nat. Can. (Que.) 93: 253-274; 371-437; 583-646; 989-1063. 94: 131-157; 471-528; 625-655.

Image or illustration

death camas:

Images: images.google.com

Notes on Poisonous plant parts:

All parts of death camas contain toxic alkaloids, with the bulbs containing the most. The bulbs may be pulled up by animals when the ground is wet or may be ingested by humans who mistake them for other plants, such as onions. The nectar and pollen are poisonous to bees. Most cases of animal poisoning occur in spring, when other forage is not plentiful (Kingsbury 1964, Barker 1978).

Toxic parts:

all parts
bulbs
flowers
leaves
pollen

References:

Barker, R. J. 1980. Poisoning by plants. Pages 275-296 in Morse, R. A., ed. Honey bee pests, predators, and diseases. Cornell University Press, Ithaca, N.Y., USA. 430 pp.

Kingsbury, J. M. 1964. Poisonous plants of the United States and Canada. Prentice-Hall Inc., Englewood Cliffs, N.J., USA. 626 pp.

Notes on Toxic plant chemicals:

Steroidal alkaloids, including zygacine, have been found in these plants. Death camas is considered to be the most toxic members of the genus *Zigadenus*. The average minimum lethal dose in sheep is estimated to be equal to ingesting 0.6-2.0% of an animal's body weight in plant material (Kingsbury 1964).

Toxic plant chemicals:

zygacine

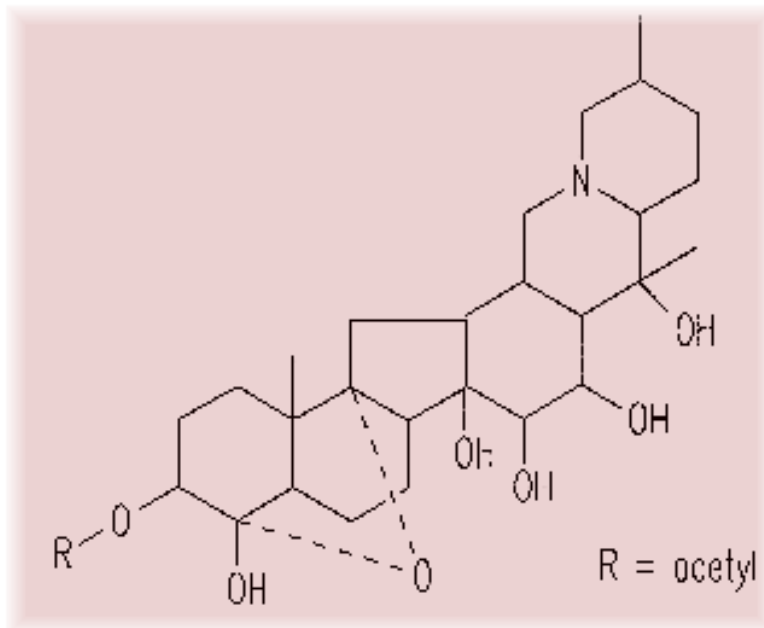

Chemical diagram(s) are courtesy of [Ruth McDiarmid](#), Biochemistry Technician, Kamloops Range Station, Agriculture and Agri-Food Canada, Kamloops, British Columbia, Canada.

References:

Kingsbury, J. M. 1964. Poisonous plants of the United States and Canada. Prentice-Hall Inc., Englewood Cliffs, N.J., USA. 626 pp.

Animals/Human Poisoning:

Note: When an animal is listed without additional information, the literature (as of 1993) contained no detailed explanation.

Cattle

General symptoms of poisoning:

[ataxia](#)

[death](#)

[dyspnea](#)

[nausea](#)

[prostration](#)

[salivation](#)

[trembling](#)

Notes on poisoning:

Cattle are occasionally poisoned by death camas. Symptoms are very similar to those for other livestock. Salivation is sometimes less and nausea greater than in sheep. Other symptoms include muscular weakness, ataxia, trembling, prostration, and death. The heart action becomes weakened

(Kingsbury 1964).

References:

Kingsbury, J. M. 1964. Poisonous plants of the United States and Canada. Prentice-Hall Inc., Englewood Cliffs, N.J., USA. 626 pp.

Honey bees

General symptoms of poisoning:

[death](#)

Notes on poisoning:

In field cases, adult bees died after foraging on this plant. In experiments, both the nectar and pollen, collected by centrifugation, poisoned the bees. The plants bloom for only a couple of weeks and secrete little nectar. Solitary native bees seem less affected by the toxins (Barker 1978).

References:

Barker, R. J. 1980. Poisoning by plants. Pages 275-296 in Morse, R. A., ed. Honey bee pests, predators, and diseases. Cornell University Press, Ithaca, N.Y., USA. 430 pp.

Horses

General symptoms of poisoning:

[colic](#)

[depression](#)

[diarrhea](#)

[salivation](#)

Notes on poisoning:

Horses have been poisoned after ingesting hay containing immature seed pods of death camas. The symptoms of illness included colic, salivation, cramping, depression, and intermittent diarrhea (Fuller and McClintock 1986).

References:

Fuller, T. C., McClintock, E. 1986. Poisonous plants of California. Univ. California Press, Berkeley, Calif., USA. 432 pp.

Humans

General symptoms of poisoning:

[blood pressure, low](#)

[breathing, shallow](#)

[coma](#)

[death](#)

[diarrhea](#)

[drowsiness](#)

[pupil dilation](#)

[vomiting](#)

Notes on poisoning:

Humans have been poisoned after ingesting the bulbs and flowers. In most cases, the bulbs are mistaken for onions. A 2-year-old child became ill after eating the blossoms. Symptoms of poisoning include vomiting, slow breathing, unconsciousness (though responsive to pain or movement), hyperactive tendons and limbs, pupil dilation, and hypotension. The alkaloids cause local irritation when ingested and affect the cardiovascular system by slowing the heart and decreasing blood pressure. Treatment includes emesis, activated charcoal, and saline cathartic. Atropine was also given (Cameron 1952, Spoerke and Spoerke 1979).

References:

Cameron, K. 1952. Death camas poisoning. Northwest Med., 1952: 682-683.

Long, R. 1981. Some liliaceae of British Columbia. Davidsonia, 12: 85-88.

Spoerke, D. G., Spoerke, S. E. 1979. Three cases of *Zigadenus* (death camas) poisoning. Vet. Hum. Toxicol., 21: 346-347.

Poultry

General symptoms of poisoning:

[coma](#)

[death](#)

[diarrhea](#)

[incoordination](#)

[prostration](#)

Notes on poisoning:

In one case (with an related species of *Zigadenus*), poultry were poisoned. Symptoms included diarrhea, staggering gait, incoordination, prostration, and coma. Many birds died (Kingsbury 1964). Death camas can also poison poultry if they ingest the tender shoots.

References:

Kingsbury, J. M. 1964. Poisonous plants of the United States and Canada. Prentice-Hall Inc., Englewood Cliffs, N.J., USA. 626 pp.

Sheep

General symptoms of poisoning:

[breathing, shallow](#)

[cyanosis](#)

[death](#)

[mouth, frothing of](#)

[muscle, weakness of](#)

[nasal discharge](#)

[prostration](#)

[salivation](#)

[urination, frequent](#)

[vomiting](#)

Notes on poisoning:

Death camas is considered to be one of the most toxic plants on the western rangelands, and ingestion causes greater loss of life of sheep than any other plant in springtime. Symptoms include excessive salivation, nausea, frothing at the nose and mouth, vomiting, increased urination and defecation, muscular weakness, ataxia, prostration, and death resulting from heart failure. Postmortem examination shows the heart in complete diastole. Coma may occur for a few hours to several days before death. Lesions include severe pulmonary congestion, edema, and hemorrhage. Losses occur most frequently in the spring, when other forage is not plentiful (Long 1981, Panter and James 1989).

References:

Dayton, W. A. 1960. Notes on western range forbes. U. S. For. Serv. Wash. Agric. Hand., 161. 254 pp.

Long, R. 1981. Some liliaceae of British Columbia. Davidsonia, 12: 85-88.

Panter, K. E., James, L. F. 1989. Death camas-early grazing can be hazardous. Rangelands, 11: 147-149.

Swine

General symptoms of poisoning:

[diarrhea](#)

[vomiting](#)

Notes on poisoning:

Experiments show that swine are susceptible to the poisons, but cases of poisoning are not encountered under natural conditions because swine readily expel the material by vomiting (Kingsbury 1964).

References:

Kingsbury, J. M. 1964. Poisonous plants of the United States and Canada. Prentice-Hall Inc., Englewood Cliffs, N.J., USA. 626 pp.

[Another search?](#)

[Français](#) | [Contact Us](#) | [Help](#) | [Search](#) | [Canada site](#)

[Coming Events](#) | [About CBIF](#) | [Links](#) | [Reports and Publications](#) | [Home](#)

Date modified: 2003-02-06

[Important Notices](#)



Français	Contact us	Help	Search	Canada site
Coming events	About CBIF	Links	Reports and publications	Home

Canadian Biodiversity Information Facility



Notes on poisoning: Devil's-backbone

[Introduction](#)[Interactive](#)[All poisonous plants by Botanical name](#)[All poisonous plants by Common name](#)[Important WWW Poisonous Plants sites](#)

General poisoning notes:

Devil's-backbone (*Kalanchoe daigremontiana*) is an indoor ornamental plant. This plant contains a cardiac glycoside that has caused experimental toxicity and death in chicks and mice. It has caused illness in pets, such as rabbits and mice. Dogs and cats are also at risk from ingesting plant material. The plants should be kept away from children, as well. Devil's-backbone produces plantlets along the leaf margins, which fall off and become new plants. These plantlets can be found in profusion around the pot in which an adult devil's-backbone is growing. Children and family pets have easy access to these plantlets. Several other species of *Kalanchoe* may be found growing as houseplants in Canada. Tests have shown that some of them may also contain toxic bufadienolide compounds. These compounds were only recently discovered (Williams and Smith 1985, Joubert 1989), and so caution should be exercised with all species. Some members of the genus *Kalanchoe* have caused poisoning of sheep and cattle in South Africa and Australia, where they are native or naturalized (Cheeke and Schull 1985, Williams and Smith 1985).

References:

Cheeke, P. R., Shull, L. R. 1985. Natural toxicants in feeds and poisonous plants. AVI Publishing Company, Inc., Westport, Conn., USA. 492 pp.

Fuller, T. C., McClintock, E. 1986. Poisonous plants of California. Univ. California Press, Berkeley, Calif., USA. 432 pp.

Joubert, J. P. 1989. Cardiac glycosides. Pages 61-97 in Cheeke, P. R., ed. Toxicants of plant origin. Vol. II. Glycosides. CRC Press, Inc., Boca Raton, Fla., USA. 277 pp.

Wagner, H., Fischer, M., Lotter, H. 1985. Isolation and structure determination of daigremontianin, a novel bufadienolide from *Kalanchoe daigremontiana*. *Planta Med.*, 33: 169-171.

Williams, M. C., Smith, M. C. 1984. Toxicity of *Kalanchoe* spp. to chicks. *Am. J. Vet. Res.*, 45: 543-546.

Nomenclature:

Scientific Name: *Kalanchoe daigremontiana* Hamet & Perr.

Vernacular name(s): Devil's-backbone

Scientific family name: *Crassulaceae*

Vernacular family name: orpine

Go to ITIS^{*ca} for more taxonomic information on: [Kalanchoe daigremontiana](#)

References:

Agriculture Quebec. 1975. Noms des maladies des plantes du Canada/ Names of plant diseases in Canada. , Quebec City, Que., Canada. 288 pp.

Alex, J. F., Cayouette, R., Mulligan, G. A. 1980. Common and botanical names of weeds in Canada/Noms populaire et scientifiques des plantes nuisibles du Canada. Revised. Agric. Can. Publ., Ottawa, Ont., Canada. 132 pp.

Bailey, L. H., Bailey, E. Z. 1976. Hortus third. Revised. MacMillan, New York, N.Y., USA. 1290 pp.

Scoggan, H. J. 1978, 1979. The flora of Canada. Nat. Mus. Nat. Sci. (Ottawa) Publ. Bot. 7(1)-7(4). 1711 pp.

Van Wijk, H. L. 1911. A dictionary of plant names. Martinus Nijhoff, The Hague, The Netherlands. 1444 pp.

Victorin, M. 1964. Flore Laurentienne. 2nd ed. Univ. Montreal, Montreal, Que., Canada. 952 pp.

Geographic Information

Plant or plant parts used in or around the home.

References:

Bailey, L. H., Bailey, E. Z. 1976. Hortus third. Revised. MacMillan, New York, N.Y., USA. 1290 pp.

Boivin, B. 1966, 1967. Énumération des plantes du Canada. Provencheria 6. *Nat. Can. (Que.)* 93: 253-274; 371-437; 583-646; 989-1063. 94: 131-157; 471-528; 625-655.

Image or illustration

Devil's-backbone:

Images: images.google.com

Notes on Poisonous plant parts:

Williams and Smith (1984) found that the leaves contained more toxin than the stems.

Toxic parts:

leaves

stems

References:

Joubert, J. P. 1989. Cardiac glycosides. Pages 61-97 in Cheeke, P. R., ed. Toxicants of plant origin. Vol. II. Glycosides. CRC Press, Inc., Boca Raton, Fla., USA. 277 pp.

Wagner, H., Fischer, M., Lotter, H. 1985. Isolation and structure determination of daigremontianin, a novel bufadienolide from *Kalanchoe daigremontiana*. *Planta Med.*, 33: 169-171.

Williams, M. C., Smith, M. C. 1984. Toxicity of *Kalanchoe* spp. to chicks. *Am. J. Vet. Res.*, 45: 543-546.

Notes on Toxic plant chemicals:

Daigremontianin is a bufadienolide. Bufadienolides are cardiac glycosides that are similar to cardenolides, differing only in the structure of the C-17 substituent on the D ring. This chemical has been found to be toxic in experiments on mice (Wagner et al. 1985).

Toxic plant chemicals:

daigremontianin

References:

Wagner, H., Fischer, M., Lotter, H. 1985. Isolation and structure determination of daigremontianin, a novel bufadienolide from *Kalanchoe daigremontiana*. *Planta Med.*, 33: 169-171.

Animals/Human Poisoning:

Note: When an animal is listed without additional information, the literature (as of 1993) contained no detailed explanation.

Cats

General symptoms of poisoning:

[breathing, labored](#)

[convulsions](#)

[paralysis](#)

References:

Fuller, T. C., McClintock, E. 1986. Poisonous plants of California. Univ. California Press, Berkeley, Calif., USA. 432 pp.

Chickens

General symptoms of poisoning:

[breathing, labored](#)

[convulsions](#)

[death](#)

[depression](#)

[incoordination](#)

[muscle twitching](#)

[paralysis](#)

[trembling](#)

Notes on poisoning:

Experimental feeding of leaf extracts to chicks caused depression, closed eyes, ruffled and drooping feathers, twitching of the neck and head, and often spiralling of the head over the back. In severe cases, convulsions, paralysis, neck and limb tremors, and death occurred. A dosage of 8 mg/g of body weight caused mild symptoms; dosages between 12-20 mg/g of body weight caused some deaths. Stem extracts produced less severe symptoms and no deaths, even when fed at the equivalent of 20 mg/g of body weight (Williams and Smith 1984).

References:

Fuller, T. C., McClintock, E. 1986. Poisonous plants of California. Univ. California Press, Berkeley, Calif., USA. 432 pp.

Williams, M. C., Smith, M. C. 1984. Toxicity of *Kalanchoe* spp. to chicks. Am. J. Vet. Res., 45: 543-546.

Rabbits

General symptoms of poisoning:

[breathing, rapid](#)

[opisthotonos](#)

[paralysis](#)

Notes on poisoning:

A pet rabbit ate three-quarters of a leaf and became depressed and torpid; it subsequently experienced rapid breathing and teeth grinding. It fell down when attempting to walk. Paralysis followed. An injection of atropine was administered, and the rabbit recovered fully within 9 h (Williams and Smith 1984).

References:

Williams, M. C., Smith, M. C. 1984. Toxicity of *Kalanchoe* spp. to chicks. *Am. J. Vet. Res.*, 45: 543-546.

Rodents

General symptoms of poisoning:

[muscle spasms](#)

[paralysis](#)

Notes on poisoning:

In motility tests, mice experimentally fed the chemical daigremontianin at dosages of 0.1-0.5 mg/kg experienced a strong sedative effect. Higher concentrations resulted in paralysis and spasmodic muscular contractions (Wagner et al. 1985).

References:

Wagner, H., Fischer, M., Lotter, H. 1985. Isolation and structure determination of daigremontianin, a novel bufadienolide from *Kalanchoe daigremontiana*. *Planta Med.*, 33: 169-171.

[Another search?](#)

[Français](#) | [Contact Us](#) | [Help](#) | [Search](#) | [Canada site](#)

[Coming Events](#) | [About CBIF](#) | [Links](#) | [Reports and Publications](#) |

[Home](#)

Date modified: 2003-02-06

[Important Notices](#)



Français	Contact us	Help	Search	Canada site
Coming events	About CBIF	Links	Reports and publications	Home

Canadian Biodiversity Information Facility



Notes on poisoning: dumbcane

[Introduction](#)

[Interactive](#)

[All poisonous plants by Botanical name](#)

[All poisonous plants by Common name](#)

[Important WWW Poisonous Plants sites](#)

General poisoning notes:

Dumbcane (*Dieffenbachia bausei*) is an ornamental houseplant. Experimental work caused death in mice when leaf tissue extract was fed orally at the rate of 100 mg of lyophilized plant material (in distilled water) per 35 g of body weight (Der Marderosian et al. 1976).



References:

Der Marderosian, A. H., Giller, F. B., Roia, F. C. 1976. Phytochemical and toxicological screening of household ornamental plants potentially toxic to humans. 1. J. Toxicol. Environ. Health, 1: 939-953.

Nomenclature:

Scientific Name: *Dieffenbachia bausei* Regel

Vernacular name(s): dumbcane

Scientific family name: *Araceae*

Vernacular family name: arum

References:

Agriculture Quebec. 1975. Noms des maladies des plantes du Canada/ Names of plant diseases in Canada. , Quebec City, Que., Canada. 288 pp.

Alex, J. F., Cayouette, R., Mulligan, G. A. 1980. Common and botanical names of weeds in Canada/Noms populaire et scientifiques des plantes nuisibles du Canada. Revised. Agric. Can. Publ., Ottawa, Ont., Canada. 132 pp.

Bailey, L. H., Bailey, E. Z. 1976. Hortus third. Revised.

MacMillan, New York, N.Y., USA. 1290 pp.

Scoggan, H. J. 1978, 1979. The flora of Canada. Nat. Mus. Nat. Sci. (Ottawa) Publ. Bot. 7(1)-7(4). 1711 pp.

Van Wijk, H. L. 1911. A dictionary of plant names. Martinus Nijhoff, The Hague, The Netherlands. 1444 pp.

Victorin, M. 1964. Flore Laurentienne. 2nd ed. Univ. Montreal, Montreal, Que., Canada. 952 pp.

Geographic Information

Plant or plant parts used in or around the home.

References:

Bailey, L. H., Bailey, E. Z. 1976. Hortus third. Revised. MacMillan, New York, N.Y., USA. 1290 pp.

Boivin, B. 1966, 1967. Énumération des plantes du Canada. Provencheria 6. Nat. Can. (Que.) 93: 253-274; 371-437; 583-646; 989-1063. 94: 131-157; 471-528; 625-655.

Image or illustration

dumbcane:

Images: images.google.com

Toxic parts:

leaves

References:

Der Marderosian, A. H., Giller, F. B., Roia, F. C. 1976. Phytochemical and toxicological screening of household ornamental plants potentially toxic to humans. 1. J. Toxicol. Environ. Health, 1: 939-953.

Notes on Toxic plant chemicals:

See notes under [Dieffenbachia seguine](#) for additional information on toxic chemicals in *Dieffenbachia* spp.

Toxic plant chemicals:

oxalate

References:

Der Marderosian, A. H., Giller, F. B., Roia, F. C. 1976. Phytochemical and toxicological screening of household ornamental plants potentially toxic to humans. 1. J. Toxicol. Environ. Health, 1: 939-953.

Animals/Human Poisoning:

Note: When an animal is listed without additional information, the literature (as of 1993) contained no detailed explanation.

Rodents

[Another search?](#)

[Français](#) | [Contact Us](#) | [Help](#) | [Search](#) | [Canada site](#)

[Coming Events](#) | [About CBIF](#) | [Links](#) | [Reports and Publications](#) | [Home](#)

Date modified: 2003-02-06

[Important Notices](#)



Français	Contact us	Help	Search	Canada site
Coming events	About CBIF	Links	Reports and publications	Home

Canadian Biodiversity Information Facility



Notes on poisoning: Dutchman's-breeches

[Introduction](#)[Interactive](#)[All poisonous plants by
Botanical name](#)[All poisonous plants by
Common name](#)[Important WWW Poisonous
Plants sites](#)

General poisoning notes:

Dutchman's-breeches (*Dicentra cucullaria*) is a native herb found in the rich woodlands of eastern Canada. The plant has been shown to cause poisoning when fed to cattle under experimental conditions. The underground tubers caused more severe symptoms. When plant tubers were fed at 2 kg/100 kg of animal weight, various symptoms occurred, including trembling and convulsions (Black et al. 1923). Poisoning may occur during the spring, when the ground is soft and the tubers might be dug up.



References:

Black, O. F., Eggleston, W. W., Kelly, J. W., Turner, H. C. 1923. Poisonous properties of *Bikukulla cucullaria* (Dutchman's-breeches) and *B. canadensis* (squirrel-corn). J. Agric. Res., 23: 69-78.

Nomenclature:

Scientific Name: *Dicentra cucullaria* (L.) Bernh.

Vernacular name(s): Dutchman's-breeches

Scientific family name: *Fumariaceae*

Vernacular family name: frumitory

Go to ITIS^{*ca} for more taxonomic information on: [Dicentra cucullaria](#)

References:

Agriculture Quebec. 1975. Noms des maladies des plantes du Canada/ Names of plant diseases in Canada. , Quebec City, Que., Canada. 288 pp.

Alex, J. F., Cayouette, R., Mulligan, G. A. 1980. Common and botanical names of weeds in Canada/Noms populaire et scientifiques des plantes nuisibles du Canada. Revised. Agric. Can. Publ., Ottawa, Ont., Canada.

132 pp.

Bailey, L. H., Bailey, E. Z. 1976. Hortus third. Revised. MacMillan, New York, N.Y., USA. 1290 pp.

Scoggan, H. J. 1978, 1979. The flora of Canada. Nat. Mus. Nat. Sci. (Ottawa) Publ. Bot. 7(1)-7(4). 1711 pp.

Van Wijk, H. L. 1911. A dictionary of plant names. Martinus Nijhoff, The Hague, The Netherlands. 1444 pp.

Victorin, M. 1964. Flore Laurentienne. 2nd ed. Univ. Montreal, Montreal, Que., Canada. 952 pp.

Geographic Information

New Brunswick

Nova Scotia

Ontario

Prince Edward Island

Quebec

References:

Bailey, L. H., Bailey, E. Z. 1976. Hortus third. Revised. MacMillan, New York, N.Y., USA. 1290 pp.

Boivin, B. 1966, 1967. Énumération des plantes du Canada. Provencheria 6. Nat. Can. (Que.) 93: 253-274; 371-437; 583-646; 989-1063. 94: 131-157; 471-528; 625-655.

Image or illustration

Dutchman's-breeches:

Images: images.google.com

Notes on Poisonous plant parts:

When the plant was fed to cattle during experiments the underground tubers caused more symptoms than the aboveground portion of the plant (Black et al. 1923).

Toxic parts:

leaves

tubers

References:

Black, O. F., Eggleston, W. W., Kelly, J. W., Turner, H. C. 1923.

Poisonous properties of *Bikukulla cucullaria* (Dutchman's-breeches) and *B. canadensis* (squirrel-corn). J. Agric. Res., 23: 69-78.

Notes on Toxic plant chemicals:

Several isoquinoline alkaloids have been found in *Dicentra* species, including aporphine and protopine. The degree of toxicity of the various alkaloids is not known (Black et al. 1923). Protopine is also found in the opium poppy (*Papaver somniferum*).

Toxic plant chemicals:

aporphine

protopine

References:

Black, O. F., Eggleston, W. W., Kelly, J. W., Turner, H. C. 1923. Poisonous properties of *Bikukulla cucullaria* (Dutchman's-breeches) and *B. canadensis* (squirrel-corn). J. Agric. Res., 23: 69-78.

Animals/Human Poisoning:

Note: When an animal is listed without additional information, the literature (as of 1993) contained no detailed explanation.

Cattle

General symptoms of poisoning:

[breathing, labored](#)

[convulsions](#)

[mouth, frothing of](#)

[nervousness](#)

[opisthotonos](#)

[trembling](#)

Notes on poisoning:

Experimental feeding of cattle caused the animals to become nervous, run back and forth, violently eject stomach contents, tremble, convulse, and fall down with the legs extended and rigid. The cattle were able to rise again and recover after a while (Black et al. 1923).

References:

Black, O. F., Eggleston, W. W., Kelly, J. W., Turner, H. C. 1923. Poisonous properties of *Bikukulla cucullaria* (Dutchman's-breeches) and *B. canadensis* (squirrel-corn). J. Agric. Res., 23: 69-78.

[Another search?](#)

[Français](#) | [Contact Us](#) | [Help](#) | [Search](#) | [Canada site](#)

[Coming Events](#) | [About CBIF](#) | [Links](#) | [Reports and Publications](#) | [Home](#)

Date modified: 2003-02-06

[Important Notices](#)



Français	Contact us	Help	Search	Canada site
Coming events	About CBIF	Links	Reports and publications	Home

Canadian Biodiversity Information Facility



Notes on poisoning: eastern whorled milkweed

[Introduction](#)[Interactive](#)[All poisonous plants by Botanical name](#)[All poisonous plants by Common name](#)[Important WWW Poisonous Plants sites](#)

General poisoning notes:

Eastern whorled milkweed (*Asclepias verticillata*) is a native plant found in fields in parts of southern Canada. It has caused poisoning in experimental feeding tests in sheep. Large quantities of fresh plant were administered with a balling gun at about 2.2% of body weight, causing symptoms of poisoning (Marsh and Clawson 1921). The early literature is rife with contradictions in determining the scientific names of various milkweeds. *Asclepias verticillata* was termed *Asclepias verticillata* var. *geyeri* in Marsh and Clawson (1921). For more information on *Asclepias* taxonomy see Woodson (1954).

References:

Clark, J. G. 1979. Whorled milkweed poisoning. *Vet. Hum. Toxicol.*, 21: 431.

Marsh, C. D., Clawson, A. B. 1921. Poisonous properties of the whorled milkweeds *Asclepias pumila* and *A. verticillata* var. *geyeri*. U. S. Dept. Agric. Bull., 942. 14 pp.

Woodson, R. E. 1954. The North American species of *Asclepias* L. *Ann. Mo. Bot. Gard.*, 41: 1-211.

Nomenclature:

Scientific Name: *Asclepias verticillata* L.

Vernacular name(s): eastern whorled milkweed

Scientific family name: *Asclepiadaceae*

Vernacular family name: milkweed

Go to ITIS*^{ca} for more taxonomic information on: [Asclepias verticillata](#)

References:

Agriculture Quebec. 1975. Noms des maladies des plantes du Canada/ Names of plant diseases in Canada. , Quebec City, Que., Canada. 288 pp.

Alex, J. F., Cayouette, R., Mulligan, G. A. 1980. Common and botanical names of weeds in Canada/Noms populaire et scientifiques des plantes nuisibles du Canada. Revised. Agric. Can. Publ., Ottawa, Ont., Canada. 132 pp.

Bailey, L. H., Bailey, E. Z. 1976. Hortus third. Revised. MacMillan, New York, N.Y., USA. 1290 pp.

Scoggan, H. J. 1978, 1979. The flora of Canada. Nat. Mus. Nat. Sci. (Ottawa) Publ. Bot. 7(1)-7(4). 1711 pp.

Van Wijk, H. L. 1911. A dictionary of plant names. Martinus Nijhoff, The Hague, The Netherlands. 1444 pp.

Victorin, M. 1964. Flore Laurentienne. 2nd ed. Univ. Montreal, Montreal, Que., Canada. 952 pp.

Geographic Information

Manitoba
Ontario
Saskatchewan

References:

Bailey, L. H., Bailey, E. Z. 1976. Hortus third. Revised. MacMillan, New York, N.Y., USA. 1290 pp.

Boivin, B. 1966, 1967. Énumération des plantes du Canada. Provencheria 6. Nat. Can. (Que.) 93: 253-274; 371-437; 583-646; 989-1063. 94: 131-157; 471-528; 625-655.

Image or illustration

eastern whorled milkweed:

Images: images.google.com

Toxic parts:

flower buds
leaves

References:

Clark, J. G. 1979. Whorled milkweed poisoning. *Vet. Hum. Toxicol.*, 21: 431.

Toxic plant chemicals:

galitoxin

References:

Clark, J. G. 1979. Whorled milkweed poisoning. *Vet. Hum. Toxicol.*, 21: 431.

Animals/Human Poisoning:

Note: When an animal is listed without additional information, the literature (as of 1993) contained no detailed explanation.

Sheep

General symptoms of poisoning:

[agitation](#)

[bloat](#)

[breathing, labored](#)

[convulsions](#)

[death](#)

[depression](#)

[opisthotonos](#)

[pupil dilation](#)

[temperature, elevated](#)

[trembling](#)

[weakness, posterior](#)

Notes on poisoning:

Experimental feeding of fresh eastern whorled milkweed caused poisoning in sheep. The animals fell down and went through characteristic running movements. The head and jaws occasionally moved compulsively. The pulse was often weak. Ingesting 2.2% of body weight was necessary to produce serious poisoning in sheep. Animals do not normally eat these distasteful plants or other milkweeds (Marsh and Clawson 1921).

References:

Clark, J. G. 1979. Whorled milkweed poisoning. *Vet. Hum.*

Toxicol., 21: 431.

Marsh, C. D., Clawson, A. B. 1921. Poisonous properties of the whorled milkweeds *Asclepias pumila* and *A. verticillata* var. *geyeri*. U. S. Dept. Agric. Bull., 942. 14 pp.

[Another search?](#)

[Français](#) | [Contact Us](#) | [Help](#) | [Search](#) | [Canada site](#)

[Coming Events](#) | [About CBIF](#) | [Links](#) | [Reports and Publications](#) |

[Home](#)

Date modified: 2003-02-06

[Important Notices](#)



Français	Contact us	Help	Search	Canada site
Coming events	About CBIF	Links	Reports and publications	Home

Canadian Biodiversity Information Facility



Notes on poisoning: English bluebell

[Introduction](#)[Interactive](#)[All poisonous plants by Botanical name](#)[All poisonous plants by Common name](#)[Important WWW Poisonous Plants sites](#)

General poisoning notes:

English bluebell (*Endymion non-scriptus*) is an ornamental bulb plant that is grown outdoors and forced indoors for its early spring flowers. This species was formerly included under the genus *Scilla*. The plant contains glycosides, which are chemically similar to the cardiac glycoside digitalis. Cattle, a horse, and humans were poisoned after ingesting this plant. Children or family pets should be prevented from chewing the plants (Cooper and Johnson 1984).

References:

Cooper, M. R., Johnson, A. W. 1984. Poisonous plants in Britain and their effects on animals and man. Her Majesty's Stationery Office, London, England. 305 pp.

Nomenclature:

Scientific Name: *Hyacinthoides nonscripta* (L.) Garcke

Vernacular name(s): English bluebell

Scientific family name: *Liliaceae*

Vernacular family name: lily

Go to ITIS^{*ca} for more taxonomic information on: [Hyacinthoides nonscripta](#)

References:

Agriculture Quebec. 1975. Noms des maladies des plantes du Canada/ Names of plant diseases in Canada. , Quebec City, Que., Canada. 288 pp.

Alex, J. F., Cayouette, R., Mulligan, G. A. 1980. Common and

botanical names of weeds in Canada/Noms populaire et scientifiques des plantes nuisibles du Canada. Revised. Agric. Can. Publ., Ottawa, Ont., Canada. 132 pp.

Bailey, L. H., Bailey, E. Z. 1976. Hortus third. Revised. MacMillan, New York, N.Y., USA. 1290 pp.

Scoggan, H. J. 1978, 1979. The flora of Canada. Nat. Mus. Nat. Sci. (Ottawa) Publ. Bot. 7(1)-7(4). 1711 pp.

Van Wijk, H. L. 1911. A dictionary of plant names. Martinus Nijhoff, The Hague, The Netherlands. 1444 pp.

Victorin, M. 1964. Flore Laurentienne. 2nd ed. Univ. Montreal, Montreal, Que., Canada. 952 pp.

Geographic Information

Plant or plant parts used in or around the home.

References:

Bailey, L. H., Bailey, E. Z. 1976. Hortus third. Revised. MacMillan, New York, N.Y., USA. 1290 pp.

Boivin, B. 1966, 1967. Énumération des plantes du Canada. Provencheria 6. Nat. Can. (Que.) 93: 253-274; 371-437; 583-646; 989-1063. 94: 131-157; 471-528; 625-655.

Image or illustration

English bluebell:

Images: images.google.com

Toxic parts:

all parts
bulbs
flowers
leaves

References:

Cooper, M. R., Johnson, A. W. 1984. Poisonous plants in Britain and their effects on animals and man. Her Majesty's Stationery Office, London, England. 305 pp.

Notes on Toxic plant chemicals:

The plant contains glycosides, generally termed scillarens, which

are similar to the cardiac glycoside digitalis (Cooper and Johnson 1984).

Toxic plant chemicals:

unknown chemical

References:

Cooper, M. R., Johnson, A. W. 1984. Poisonous plants in Britain and their effects on animals and man. Her Majesty's Stationery Office, London, England. 305 pp.

Animals/Human Poisoning:

Note: When an animal is listed without additional information, the literature (as of 1993) contained no detailed explanation.

Cattle

General symptoms of poisoning:

[breathing, shallow](#)

[heart rate, slow](#)

[lethargy](#)

[temperature, depressed](#)

Notes on poisoning:

A group of cows and calves in Britain grazed on English bluebells and a few days later became dull and lethargic, chewed intermittently, and produced hard, dry feces. Temperature and respiration were decreased and heart beat became erratic. Lactating cows became dry. Recovery was slow when the cows were removed from the plants and given extra feed (Cooper and Johnson 1984).

References:

Cooper, M. R., Johnson, A. W. 1984. Poisonous plants in Britain and their effects on animals and man. Her Majesty's Stationery Office, London, England. 305 pp.

Horses

General symptoms of poisoning:

[abdominal pains](#)

[diarrhea](#)

[skin, cold and moist
temperature, depressed
urination, absent
vomiting](#)

Notes on poisoning:

A horse that ate several bulbs of English bluebell became ill within 6 h. Symptoms included initial choking, abdominal pain, slow pulse, low temperature, and cold, clammy skin. Within 10 h the animal produced dark-colored diarrhea with blood and ceased urinating. The horse recovered slowly, passing blood-stained urine for several days (Cooper and Johnson 1984).

References:

Cooper, M. R., Johnson, A. W. 1984. Poisonous plants in Britain and their effects on animals and man. Her Majesty's Stationery Office, London, England. 305 pp.

Humans

General symptoms of poisoning:

[abdominal pains](#)
[diarrhea](#)
[heart rate, slow](#)
[skin, flushed](#)

References:

Cooper, M. R., Johnson, A. W. 1984. Poisonous plants in Britain and their effects on animals and man. Her Majesty's Stationery Office, London, England. 305 pp.

[Another search?](#)

[Français](#) | [Contact Us](#) | [Help](#) | [Search](#) | [Canada site](#)
[Coming Events](#) | [About CBIF](#) | [Links](#) | [Reports and Publications](#) | [Home](#)

Date modified: 2003-02-06

[Important Notices](#)



Français	Contact us	Help	Search	Canada site
Coming events	About CBIF	Links	Reports and publications	Home

Canadian Biodiversity Information Facility



Notes on poisoning: English holly

[Introduction](#)

[Interactive](#)

[All poisonous plants by Botanical name](#)

[All poisonous plants by Common name](#)

[Important WWW Poisonous Plants sites](#)

General poisoning notes:

English holly (*Ilex aquifolium*) has been implicated in cases where children have eaten the berries. Kingsbury (1969) noted that the often-quoted fatal dosage of 20-30 berries comes from European literature before 1889 and that this quantity has not been confirmed. Modern references show that symptoms are usually confined to vomiting and diarrhea (Cooper and Johnson 1984, Lampe and McCann 1985). This holly is used as an outdoor ornamental, and the glossy green leaves and red berries may be sold as Christmas decorations.

References:



Cooper, M. R., Johnson, A. W. 1984. Poisonous plants in Britain and their effects on animals and man. Her Majesty's Stationery Office, London, England. 305 pp.

Kingsbury, J. M. 1969. Phytotoxicity 1. Major problems associated with poisonous plants. Clin. Pharmacol. Ther., 10: 163-169.

Lampe, K. F., McCann, M. A. 1985. AMA Handbook of poisonous and injurious plants. American Medical Assoc. Chicago, Ill., USA. 432 pp.

Nomenclature:

Scientific Name: *Ilex aquifolium* L.

Vernacular name(s): English holly

Scientific family name: *Aquifoliaceae*

Vernacular family name: holly

Go to ITIS*^{ca} for more taxonomic information on: [Ilex aquifolium](#)

References:

Agriculture Quebec. 1975. Noms des maladies des plantes du Canada/ Names

of plant diseases in Canada. , Quebec City, Que., Canada. 288 pp.

Alex, J. F., Cayouette, R., Mulligan, G. A. 1980. Common and botanical names of weeds in Canada/Noms populaire et scientifiques des plantes nuisibles du Canada. Revised. Agric. Can. Publ., Ottawa, Ont., Canada. 132 pp.

Bailey, L. H., Bailey, E. Z. 1976. Hortus third. Revised. MacMillan, New York, N.Y., USA. 1290 pp.

Scoggan, H. J. 1978, 1979. The flora of Canada. Nat. Mus. Nat. Sci. (Ottawa) Publ. Bot. 7(1)-7(4). 1711 pp.

Van Wijk, H. L. 1911. A dictionary of plant names. Martinus Nijhoff, The Hague, The Netherlands. 1444 pp.

Victorin, M. 1964. Flore Laurentienne. 2nd ed. Univ. Montreal, Montreal, Que., Canada. 952 pp.

Geographic Information

British Columbia

References:

Bailey, L. H., Bailey, E. Z. 1976. Hortus third. Revised. MacMillan, New York, N.Y., USA. 1290 pp.

Boivin, B. 1966, 1967. Énumération des plantes du Canada. Provencheria 6. Nat. Can. (Que.) 93: 253-274; 371-437; 583-646; 989-1063. 94: 131-157; 471-528; 625-655.

Image or illustration

English holly:

Images: images.google.com

Toxic parts:

mature fruit

References:

Willems, M. 1988. A cyanogenic glucoside from *Ilex aquifolium*. Phytochemistry (Oxf.), 27: 1852-1853.

Notes on Toxic plant chemicals:

Ilicin, a glycoside, has been implicated as the toxic substance in in holly berries (Rodrigues et al. 1984). A cyanogenic glycoside,

(2-beta-D-glucopyranosyloxy-p-hydroxy-6,7-dihydromandelonitrile) has also been isolated from the berries of English holly. The chemical also occurs in lower concentrations in the leaves and stems. A common name for this chemical has not been established yet (Willems 1988).

Toxic plant chemicals:

-dihydromandelonitrile
ilicin

References:

Willems, M. 1988. A cyanogenic glucoside from *Ilex aquifolium*. *Phytochemistry* (Oxf.), 27: 1852-1853.

Animals/Human Poisoning:

Note: When an animal is listed without additional information, the literature (as of 1993) contained no detailed explanation.

Humans

General symptoms of poisoning:

[diarrhea](#)

[nausea](#)

[vomiting](#)

Notes on poisoning:

Symptoms include multiple episodes of vomiting, nausea, and diarrhea. If a large number of berries are ingested, vomiting should be induced with an emetic. Conservative management is generally adequate (Cooper and Johnson 1984, Lampe and McCann 1985).

References:

Cooper, M. R., Johnson, A. W. 1984. Poisonous plants in Britain and their effects on animals and man. Her Majesty's Stationery Office, London, England. 305 pp.

Lampe, K. F., McCann, M. A. 1985. AMA Handbook of poisonous and injurious plants. American Medical Assoc. Chicago, Ill., USA. 432 pp.

[Another search?](#)

[Français](#) | [Contact Us](#) | [Help](#) | [Search](#) | [Canada site](#)

[Coming Events](#) | [About CBIF](#) | [Links](#) | [Reports and Publications](#) | [Home](#)

Date modified: 2003-02-06

[Important Notices](#)



Français	Contact us	Help	Search	Canada site
Coming events	About CBIF	Links	Reports and publications	Home

Canadian Biodiversity Information Facility



Notes on poisoning: English ivy

[Introduction](#)[Interactive](#)[All poisonous plants by Botanical name](#)[All poisonous plants by Common name](#)[Important WWW Poisonous Plants sites](#)

General poisoning notes:

English ivy (*Hedera helix*) is an indoor and outdoor ornamental vine. This plant contains saponins, which have caused poisoning in cattle, dogs, sheep, and humans. Two chemicals in the sap can also cause severe contact dermatitis in sensitive humans. Cases of poisoning are found in older European literature; the plant grows naturally in Europe. Cattle that ingested large quantities of the vines were ill for a few days. Humans who ingested the berries have shown symptoms, including coma. Dermatitis is rare but can be severe. Weeping lesions and blisters respond slowly to treatment (Cooper and Johnson 1984, Massmanian et al. 1980). Family pets should not be allowed to eat English ivy leaves.

References:

- Boyle, J., Harman, R. M. 1985. Contact dermatitis to *Hedera helix* (common ivy). *Contact Dermatitis*, 12: 111-112.
- Cooper, M. R., Johnson, A. W. 1984. Poisonous plants in Britain and their effects on animals and man. Her Majesty's Stationery Office, London, England. 305 pp.
- Frohne, D., Pfander, H. J. 1983. A colour atlas of poisonous plants. Wolfe Publishing Ltd., London, England. 291 pp.
- Massmanian, A., Valcuende Cavero, F., Ramirez Bosca, A., Castells Rodellas, A. 1988. Contact dermatitis from variegated ivy (*Hedera helix* subsp. *canariensis* Willd.). *Contact Dermatitis*, 18: 247-248.
- Mitchell, J. C. 1981. Allergic contact dermatitis from *Hedera helix* and *Brassaia actinophylla* (Araliaceae). *Contact Dermatitis*, 7: 158-159.
- Spoerke, D. G., Smolinske, S. C. 1990. Toxicity of houseplants. CRC Press, Inc., Boca Raton, Fla., USA. 335 pp.

Nomenclature:

Scientific Name: *Hedera helix* L.

Vernacular name(s): English ivy

Scientific family name: *Araliaceae*

Vernacular family name: aralia

Go to ITIS^{*ca} for more taxonomic information on: [Hedera helix](#)

References:

Agriculture Quebec. 1975. Noms des maladies des plantes du Canada/ Names of plant diseases in Canada. , Quebec City, Que., Canada. 288 pp.

Alex, J. F., Cayouette, R., Mulligan, G. A. 1980. Common and botanical names of weeds in Canada/Noms populaire et scientifiques des plantes nuisibles du Canada. Revised. Agric. Can. Publ., Ottawa, Ont., Canada. 132 pp.

Bailey, L. H., Bailey, E. Z. 1976. Hortus third. Revised. MacMillan, New York, N.Y., USA. 1290 pp.

Scoggan, H. J. 1978, 1979. The flora of Canada. Nat. Mus. Nat. Sci. (Ottawa) Publ. Bot. 7(1)-7(4). 1711 pp.

Van Wijk, H. L. 1911. A dictionary of plant names. Martinus Nijhoff, The Hague, The Netherlands. 1444 pp.

Victorin, M. 1964. Flore Laurentienne. 2nd ed. Univ. Montreal, Montreal, Que., Canada. 952 pp.

Geographic Information

Plant or plant parts used in or around the home.

References:

Bailey, L. H., Bailey, E. Z. 1976. Hortus third. Revised. MacMillan, New York, N.Y., USA. 1290 pp.

Boivin, B. 1966, 1967. Énumération des plantes du Canada. Provencheria 6. Nat. Can. (Que.) 93: 253-274; 371-437; 583-646; 989-1063. 94: 131-157; 471-528; 625-655.

Image or illustration

English ivy:

Images: images.google.com

Notes on Poisonous plant parts:

The sap contained in the leaves and stems of English ivy can cause dermatitis and irritation in sensitive humans. The dermatitis usually occurs after pruning the plant (Massmanian et al. 1988). The leaves and fruit contain saponins that hydrolyze into toxic hederin compounds. These toxins have caused poisoning in animals and humans (Cooper and Johnson 1984).

Toxic parts:

leaves
mature fruit
plant juices

References:

Boyle, J., Harman, R. M. 1985. Contact dermatitis to *Hedera helix* (common ivy). *Contact Dermatitis*, 12: 111-112.

Cooper, M. R., Johnson, A. W. 1984. Poisonous plants in Britain and their effects on animals and man. Her Majesty's Stationery Office, London, England. 305 pp.

Massmanian, A., Valcuende Caverro, F., Ramirez Bosca, A., Castells Rodellas, A. 1988. Contact dermatitis from variegated ivy (*Hedera helix* subsp. *canariensis* Willd.). *Contact Dermatitis*, 18: 247-248.

Notes on Toxic plant chemicals:

English ivy contains hederasaponins, which undergo partial hydrolysis to form toxic substances (micro-hederin and beta-hederin). These toxins can cause poisoning in humans and other animals if ingested in sufficient quantities. English ivy also contains allergenic and irritant chemicals, falcarinol and didehydrofalcarinol, which cause intense burning and dermatitis in sensitive humans (Cooper and Johnson 1984; Massmanian et al. 1988).

Toxic plant chemicals:

didehydrofalcarinol
falcarinol
hederasaponins

References:

Cooper, M. R., Johnson, A. W. 1984. Poisonous plants in Britain and their effects on animals and man. Her Majesty's Stationery Office, London, England. 305 pp.

Massmanian, A., Valcuende Cavero, F., Ramirez Bosca, A., Castells Rodellas, A. 1988. Contact dermatitis from variegated ivy (*Hedera helix* subsp. *canariensis* Willd.). Contact Dermatitis, 18: 247-248.

Animals/Human Poisoning:

Note: When an animal is listed without additional information, the literature (as of 1993) contained no detailed explanation.

Cattle

Dogs

General symptoms of poisoning:

[agitation](#)

[diarrhea](#)

[muscle spasms](#)

[paralysis](#)

[vomiting](#)

References:

Cooper, M. R., Johnson, A. W. 1984. Poisonous plants in Britain and their effects on animals and man. Her Majesty's Stationery Office, London, England. 305 pp.

Humans

General symptoms of poisoning:

[blisters, weeping](#)

[breathing, labored](#)

[coma](#)

[convulsions](#)

[diarrhea](#)

[erythema](#)

[muscle spasms](#)

[paralysis](#)

[vomiting](#)

Notes on poisoning:

Cattle that ingested large quantities of English ivy vine became ill and excitable, started staggering, and bellowed loudly. The odor of crushed ivy leaves was on the breath and in the milk. Recovery was quick and complete in three days (Cooper and Johnson 1984). English ivy berries are often listed as being poisonous to children, and cases of English ivy poisoning are listed in older European literature. Symptoms of ingestion included laboured breathing, coma, convulsions, and excitation (Cooper and Johnson 1984). Frohne and Pfander (1983) state that the ripe berries are dry and taste bitter. Large quantities are unlikely to be consumed by children.

References:

Boyle, J., Harman, R. M. 1985. Contact dermatitis to *Hedera helix* (common ivy). *Contact Dermatitis*, 12: 111-112.

Cooper, M. R., Johnson, A. W. 1984. Poisonous plants in Britain and their effects on animals and man. Her Majesty's Stationery Office, London, England. 305 pp.

Massmanian, A., Valcuende Cavero, F., Ramirez Bosca, A., Castells Rodellas, A. 1988. Contact dermatitis from variegated ivy (*Hedera helix* subsp. *canariensis* Willd.). *Contact Dermatitis*, 18: 247-248.

Sheep

[Another search?](#)

[Français](#) | [Contact Us](#) | [Help](#) | [Search](#) | [Canada site](#)

[Coming Events](#) | [About CBIF](#) | [Links](#) | [Reports and Publications](#) | [Home](#)

Date modified: 2003-02-06

[Important Notices](#)



Français	Contact us	Help	Search	Canada site
Coming events	About CBIF	Links	Reports and publications	Home

Canadian Biodiversity Information Facility



Notes on poisoning: English yew

[Introduction](#)[Interactive](#)[All poisonous plants by Botanical name](#)[All poisonous plants by Common name](#)[Important WWW Poisonous Plants sites](#)

General poisoning notes:

English yew (*Taxus baccata*) is an introduced ornamental shrub that is hardy in the warmest parts of Canada. This shrub has caused poisoning and death in cattle, horses, and humans. Ingesting leaves, bark, or seeds can cause poisoning in all animals. The fleshy fruit pulp is considered to be nontoxic (or low in toxicity). Taxine, a complex of alkaloids, is found in the plant. Children should be taught not to eat the fruit or seeds of this plant. Animals should not have access to the shrub or clippings of the branches (Cooper and Johnson 1984, Feldman et al. 1987).

References:

- Burke, M. J., Siegel, D., Davidow, B. 1979. Anaphylaxis. Consequence of yew (*Taxus*) needle ingestion. N. Y. State J. Med., 79: 1576-1577.
- Cooper, M. R., Johnson, A. W. 1984. Poisonous plants in Britain and their effects on animals and man. Her Majesty's Stationery Office, London, England. 305 pp.
- Feldman, R., Szajewski, J. M., Chrobak, J., Liberek, Z. M. 1987. Four cases of self-poisoning with yew leaves decoction. Vet. Hum. Toxicol., 29: 72.

Nomenclature:

Scientific Name: *Taxus baccata* L.

References:

- Agriculture Quebec. 1975. Noms des maladies des plantes du Canada/ Names of plant diseases in Canada. , Quebec City, Que., Canada. 288 pp.

Alex, J. F., Cayouette, R., Mulligan, G. A. 1980. Common and botanical names of weeds in Canada/Noms populaire et scientifiques des plantes nuisibles du Canada. Revised. Agric. Can. Publ., Ottawa, Ont., Canada. 132 pp.

Bailey, L. H., Bailey, E. Z. 1976. Hortus third. Revised. MacMillan, New York, N.Y., USA. 1290 pp.

Scoggan, H. J. 1978, 1979. The flora of Canada. Nat. Mus. Nat. Sci. (Ottawa) Publ. Bot. 7(1)-7(4). 1711 pp.

Van Wijk, H. L. 1911. A dictionary of plant names. Martinus Nijhoff, The Hague, The Netherlands. 1444 pp.

Victorin, M. 1964. Flore Laurentienne. 2nd ed. Univ. Montreal, Montreal, Que., Canada. 952 pp.

Geographic Information

Plant or plant parts used in or around the home.

References:

Bailey, L. H., Bailey, E. Z. 1976. Hortus third. Revised. MacMillan, New York, N.Y., USA. 1290 pp.

Boivin, B. 1966, 1967. Énumération des plantes du Canada. Provencheria 6. Nat. Can. (Que.) 93: 253-274; 371-437; 583-646; 989-1063. 94: 131-157; 471-528; 625-655.

Image or illustration

English yew:

Images: images.google.com

Notes on Poisonous plant parts:

All parts of the plant contain significant amounts of the alkaloids, with the exception of the fleshy part of the fruits, which is regarded as nontoxic or low in toxicity. The seeds are toxic. Ingesting the entire fruits without removing the seeds can cause poisoning. Toxicity is not reduced with drying. Hedge clippings from these plants are as toxic as fresh plants (Cooper and Johnson 1984).

Toxic parts:

leaves
pollen

seeds

References:

Cooper, M. R., Johnson, A. W. 1984. Poisonous plants in Britain and their effects on animals and man. Her Majesty's Stationery Office, London, England. 305 pp.

Feldman, R., Szajewski, J. M., Chrobak, J., Liberek, Z. M. 1987. Four cases of self-poisoning with yew leaves decoction. *Vet. Hum. Toxicol.*, 29: 72.

Notes on Toxic plant chemicals:

Taxine (taxin) is a complex mixture of alkaloids that is rapidly absorbed from the digestive tract and interferes with heart action. Case studies on humans have shown that the alkaloids are strongly diuretic and cause severe ventricular rhythms (Feldman et al. 1987). Smith (1989) discusses a technique to diagnose taxine quickly, using direct insertion probe mass spectrometry from the rumen. The lethal dose was estimated at 1-10 g/kg of body weight for ruminants and 0.5-2 g/kg for horses (Cooper and Johnson 1984).

Toxic plant chemicals:

taxine

References:

Cooper, M. R., Johnson, A. W. 1984. Poisonous plants in Britain and their effects on animals and man. Her Majesty's Stationery Office, London, England. 305 pp.

Feldman, R., Szajewski, J. M., Chrobak, J., Liberek, Z. M. 1987. Four cases of self-poisoning with yew leaves decoction. *Vet. Hum. Toxicol.*, 29: 72.

Smith, R. A. 1989. Comments on diagnosis of intoxication due to *Taxus*. *Vet. Hum. Toxicol.*, 31: 177.

Animals/Human Poisoning:

Note: When an animal is listed without additional information, the literature (as of 1993) contained no detailed explanation.

Cattle

General symptoms of poisoning:

[agitation](#)

[collapse](#)

[convulsions](#)

[death](#)

[gait, staggering](#)

[incoordination](#)

[pupil dilation](#)

[trembling](#)

Notes on poisoning:

In Europe, cattle have been poisoned after ingesting English yew. Symptoms include muscular trembling, coldness, a rapid and then weak pulse, and groaning. In some cases, symptoms are not evident until sudden collapse or death. Death does not always occur and spontaneous recovery has been reported. Postmortem findings may only show yew plant material in the stomach. Inflammation of the stomach and intestines may occur (Cooper and Johnson 1984).

References:

Cooper, M. R., Johnson, A. W. 1984. Poisonous plants in Britain and their effects on animals and man. Her Majesty's Stationery Office, London, England. 305 pp.

Horses

General symptoms of poisoning:

[abdominal pains](#)

[collapse](#)

[confusion](#)

[death](#)

[gait, staggering](#)

[incoordination](#)

Notes on poisoning:

Horses have symptoms similar to cattle after ingesting plant material of English yew. In one experiment, a pony given a strained aqueous extract from yew twigs and berries, by stomach tube, developed signs after 1 h and died 15 min later. Ingestion results in the following symptoms: coldness, a rapid and then weak pulse, excitability, and collapse, followed by death (Cooper and Johnson 1984).

References:

Cooper, M. R., Johnson, A. W. 1984. Poisonous plants in Britain and their effects on animals and man. Her Majesty's Stationery Office, London, England. 305 pp.

Humans

General symptoms of poisoning:

[abdominal pains](#)

[coma](#)

[death](#)

[dizziness](#)

[dyspnea](#)

[heart rate, slow](#)

[itchiness](#)

[muscle, weakness of](#)

[sweating](#)

[urination, frequent](#)

[vomiting](#)

References:

Burke, M. J., Siegel, D., Davidow, B. 1979. Anaphylaxis. Consequence of yew (*Taxus*) needle ingestion. N. Y. State J. Med., 79: 1576-1577.

Cooper, M. R., Johnson, A. W. 1984. Poisonous plants in Britain and their effects on animals and man. Her Majesty's Stationery Office, London, England. 305 pp.

Feldman, R., Szajewski, J. M., Chrobak, J., Liberek, Z. M. 1987. Four cases of self-poisoning with yew leaves decoction. Vet. Hum. Toxicol., 29: 72.

[Another search?](#)

[Français](#) | [Contact Us](#) | [Help](#) | [Search](#) | [Canada site](#)

[Coming Events](#) | [About CBIF](#) | [Links](#) | [Reports and Publications](#) |

[Home](#)

Date modified: 2003-02-06

[Important Notices](#)



Français	Contact us	Help	Search	Canada site
Coming events	About CBIF	Links	Reports and publications	Home

Canadian Biodiversity Information Facility



Notes on poisoning: entire-leaved groundsel

[Introduction](#)

[Interactive](#)

[All poisonous plants by Botanical name](#)

[All poisonous plants by Common name](#)

[Important WWW Poisonous Plants sites](#)



General poisoning notes:

Entire-leaved groundsel (*Senecio integerrimus*) is a native herb found through parts of western Canada in the prairies, parklands, and parts of the Rocky Mountains. This plant has caused experimentally chronic poisoning of cattle and horses. Ingesting the plant material over long periods causes irreversible liver damage in animals. This plant grows when other forage is abundant so that it is not a toxic threat unless forage is scarce or the plant is abundant in an area to be cut for hay (Clawson 1933).

References:

Clawson, A. B. 1933. The American groundsels species of *Senecio* as stock poisoning plants. *Vet. Med. Small Anim. Clin.*, 28: 105-110.

Nomenclature:

Scientific Name: *Senecio integerrimus* Nutt.

Vernacular name(s): entire-leaved groundsel

Scientific family name: *Compositae*

Vernacular family name: composite

Go to ITIS^{*ca} for more taxonomic information on: [Senecio integerrimus](#)

References:

Agriculture Quebec. 1975. Noms des maladies des plantes du Canada/ Names of plant diseases in Canada. , Quebec City, Que., Canada. 288 pp.

Alex, J. F., Cayouette, R., Mulligan, G. A. 1980. Common and

botanical names of weeds in Canada/Noms populaire et scientifiques des plantes nuisibles du Canada. Revised. Agric. Can. Publ., Ottawa, Ont., Canada. 132 pp.

Bailey, L. H., Bailey, E. Z. 1976. Hortus third. Revised. MacMillan, New York, N.Y., USA. 1290 pp.

Scoggan, H. J. 1978, 1979. The flora of Canada. Nat. Mus. Nat. Sci. (Ottawa) Publ. Bot. 7(1)-7(4). 1711 pp.

Van Wijk, H. L. 1911. A dictionary of plant names. Martinus Nijhoff, The Hague, The Netherlands. 1444 pp.

Victorin, M. 1964. Flore Laurentienne. 2nd ed. Univ. Montreal, Montreal, Que., Canada. 952 pp.

Geographic Information

Alberta
British Columbia
Manitoba
Northwest Territories
Saskatchewan
Yukon Territory

References:

Bailey, L. H., Bailey, E. Z. 1976. Hortus third. Revised. MacMillan, New York, N.Y., USA. 1290 pp.

Boivin, B. 1966, 1967. Énumération des plantes du Canada. Provencheria 6. Nat. Can. (Que.) 93: 253-274; 371-437; 583-646; 989-1063. 94: 131-157; 471-528; 625-655.

Image or illustration

entire-leaved groundsel:

Images: images.google.com

Notes on Poisonous plant parts:

Ingesting the aboveground parts caused poisoning of cattle and horses in experiments. Two cows died after ingesting 92.3 and 135% of their body weight in green plants. A horse fed plants equal to 156% of its body weight (in 81 days) died. A horse fed 76% of its body weight (in 79 days) suffered liver damage. Sheep fed 4.5 kg of green plant material for 28 days showed no symptoms. Liver damage results from ingesting this plant material but takes a long time to develop (Clawson 1933).

Toxic parts:

all parts
flowers
leaves
stems

References:

Clawson, A. B. 1933. The American groundsels species of *Senecio* as stock poisoning plants. *Vet. Med. Small Anim. Clin.*, 28: 105-110.

Kingsbury, J. M. 1964. *Poisonous plants of the United States and Canada*. Prentice-Hall Inc., Englewood Cliffs, N.J., USA. 626 pp.

Notes on Toxic plant chemicals:

Pyrrolizidine alkaloids are found in other toxic members of the genus *Senecio* and are probably the chemicals responsible for cases of poisoning found in experiments.

Toxic plant chemicals:

unknown chemical

References:

Clawson, A. B. 1933. The American groundsels species of *Senecio* as stock poisoning plants. *Vet. Med. Small Anim. Clin.*, 28: 105-110.

Animals/Human Poisoning:

Note: When an animal is listed without additional information, the literature (as of 1993) contained no detailed explanation.

Cattle

General symptoms of poisoning:

[death](#)
[depression](#)
[icterus](#)
[liver, cirrhosis of](#)
[restlessness](#)
[weakness](#)
[weight loss](#)

Notes on poisoning:

Experimental ingestion of plant material caused poisoning and death in cattle. Symptoms are similar to poisoning by other members of the genus *Senecio*, with liver damage causing many of the symptoms. Signs included depression, a peculiar sweet odor from the skin, yellowish discoloration of mucous membranes, itchiness, edema, serum oozing from the skin, and liver damage (Clawson 1933).

References:

Clawson, A. B. 1933. The American groundsels species of *Senecio* as stock poisoning plants. Vet. Med. Small Anim. Clin., 28: 105-110.

Horses

General symptoms of poisoning:

[confusion](#)

[death](#)

[depression](#)

[icterus](#)

[restlessness](#)

[weakness](#)

[weight loss](#)

Notes on poisoning:

Ingesting plant material caused a yellowish discoloration of mucous membranes, a sweet odor from the skin, depression, weakness, restless walking and, after 1 or 2 days, insensibility to objects and pushing against obstacles, urine discoloration, and death. All horses that showed definite symptoms died. Liver damage was apparent upon postmortem examination (Clawson 1933).

References:

Clawson, A. B. 1933. The American groundsels species of *Senecio* as stock poisoning plants. Vet. Med. Small Anim. Clin., 28: 105-110.

Sheep

[Another search?](#)

[Français](#) | [Contact Us](#) | [Help](#) | [Search](#) | [Canada site](#)

[Coming Events](#) | [About CBIF](#) | [Links](#) | [Reports and Publications](#) |

[Home](#)

Date modified: 2003-02-06

[Important Notices](#)



Français	Contact us	Help	Search	Canada site
Coming events	About CBIF	Links	Reports and publications	Home

Canadian Biodiversity Information Facility



Notes on poisoning: European buckthorn

[Introduction](#)[Interactive](#)[All poisonous plants by Botanical name](#)[All poisonous plants by Common name](#)[Important WWW Poisonous Plants sites](#)

General poisoning notes:

European buckthorn (*Rhamnus cathartica*) is a small naturalized shrub that is found throughout much of eastern Canada and in the Prairie Provinces. The shrub has spines on the branches and trunks. These shrubs commonly grow along fence rows and roadsides and in old fields. In some areas, they are a common undergrowth shrub in woodlands. The bark and fruits contain chemicals that have a strong purgative action that can affect humans. Severe poisoning is rare (Cooper and Johnson 1984, Lampe and McCann 1986).



References:

Cooper, M. R., Johnson, A. W. 1984. Poisonous plants in Britain and their effects on animals and man. Her Majesty's Stationery Office, London, England. 305 pp.

Fuller, T. C., McClintock, E. 1986. Poisonous plants of California. Univ. California Press, Berkeley, Calif., USA. 432 pp.

Lampe, K. F., McCann, M. A. 1985. AMA Handbook of poisonous and injurious plants. American Medical Assoc. Chicago, Ill., USA. 432 pp.

Nomenclature:

Scientific Name: *Rhamnus cathartica* L.

Vernacular name(s): European buckthorn

Scientific family name: *Rhamnaceae*

Vernacular family name: buckthorn

Go to ITIS*^{ca} for more taxonomic information on: [Rhamnus cathartica](#)

References:

Agriculture Quebec. 1975. Noms des maladies des plantes du Canada/ Names of plant diseases in Canada. , Quebec City, Que., Canada. 288 pp.

Alex, J. F., Cayouette, R., Mulligan, G. A. 1980. Common and botanical names of weeds in Canada/Noms populaire et scientifiques des plantes nuisibles du Canada. Revised. Agric. Can. Publ., Ottawa, Ont., Canada. 132 pp.

Bailey, L. H., Bailey, E. Z. 1976. Hortus third. Revised. MacMillan, New York, N.Y., USA. 1290 pp.

Scoggan, H. J. 1978, 1979. The flora of Canada. Nat. Mus. Nat. Sci. (Ottawa) Publ. Bot. 7(1)-7(4). 1711 pp.

Van Wijk, H. L. 1911. A dictionary of plant names. Martinus Nijhoff, The Hague, The Netherlands. 1444 pp.

Victorin, M. 1964. Flore Laurentienne. 2nd ed. Univ. Montreal, Montreal, Que., Canada. 952 pp.

Geographic Information

Manitoba
Nova Scotia
Ontario
Prince Edward Island
Quebec
Saskatchewan

References:

Bailey, L. H., Bailey, E. Z. 1976. Hortus third. Revised. MacMillan, New York, N.Y., USA. 1290 pp.

Boivin, B. 1966, 1967. Énumération des plantes du Canada. Provencheria 6. Nat. Can. (Que.) 93: 253-274; 371-437; 583-646; 989-1063. 94: 131-157; 471-528; 625-655.

Image or illustration

European buckthorn:

Images: images.google.com

Toxic parts:

bark
mature fruit

References:

Cooper, M. R., Johnson, A. W. 1984. Poisonous plants in Britain and their effects on animals and man. Her Majesty's Stationery Office, London, England. 305 pp.

Notes on Toxic plant chemicals:

This plant contains glycosides, which upon hydrolysis yield anthraquinones such as emodin (a trihydroxymethylanthraquinone). These chemicals have a purgative action; emodin has been used in laxative preparations (Cooper and Johnson 1984).

Toxic plant chemicals:

anthraquinones

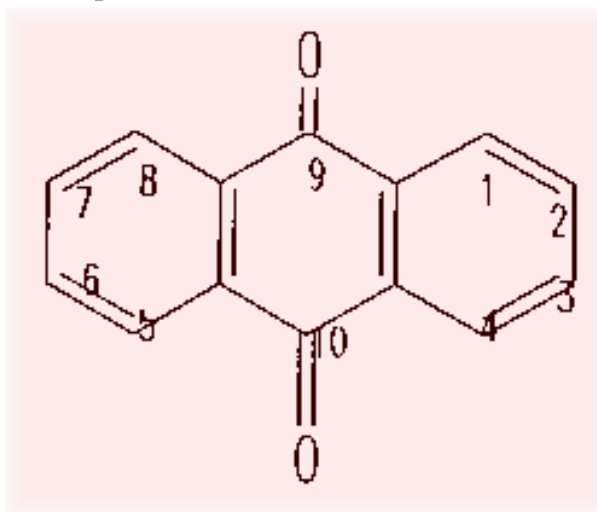

emodine

Chemical diagram(s) are courtesy of [Ruth McDiarmid](#), Biochemistry Technician, Kamloops Range Station, Agriculture and Agri-Food Canada, Kamloops, British Columbia, Canada.

References:

Cooper, M. R., Johnson, A. W. 1984. Poisonous plants in Britain and their effects on animals and man. Her Majesty's Stationery Office, London, England. 305 pp.

Animals/Human Poisoning:

Note: When an animal is listed without additional information, the literature (as of 1993) contained no detailed explanation.

Humans

General symptoms of poisoning:

[abdominal pains](#)

[diarrhea](#)

[gastroenteritis](#)

[hemorrhage](#)

[muscle spasms](#)

[vomiting](#)

Notes on poisoning:

European buckthorn is usually ingested by children, who eat the black berries or chew the twigs. Under normal circumstances, the symptoms are usually mild and are limited to transient abdominal pain, vomiting, and diarrhea. Ingesting 20 berries or more can have more serious consequences such as gastrointestinal symptoms, fluid depletion, kidney damage, muscular convulsions, and hemorrhage. Serious cases may result in difficult breathing and collapse. Treatment includes inducing vomiting, if it has not already occurred, and fluid replacement (Cooper and Johnson 1984, Fuller and McClintock 1985).

References:

Cooper, M. R., Johnson, A. W. 1984. Poisonous plants in Britain and their effects on animals and man. Her Majesty's Stationery Office, London, England. 305 pp.

Fuller, T. C., McClintock, E. 1986. Poisonous plants of California. Univ. California Press, Berkeley, Calif., USA. 432 pp.

Lampe, K. F., McCann, M. A. 1985. AMA Handbook of poisonous and injurious plants. American Medical Assoc. Chicago, Ill., USA. 432 pp.

[Another search?](#)

[Français](#) | [Contact Us](#) | [Help](#) | [Search](#) | [Canada site](#)

[Coming Events](#) | [About CBIF](#) | [Links](#) | [Reports and Publications](#) |

[Home](#)

Date modified: 2003-02-06

[Important Notices](#)



Français	Contact us	Help	Search	Canada site
Coming events	About CBIF	Links	Reports and publications	Home

Canadian Biodiversity Information Facility



Notes on poisoning: European elder

[Introduction](#)[Interactive](#)[All poisonous plants by Botanical name](#)[All poisonous plants by Common name](#)[Important WWW Poisonous Plants sites](#)

General poisoning notes:

European elder (*Sambucus nigra*) is an outdoor ornamental introduced from Europe. Several cultivars may be available in Canada. This shrub contains cyanogenic glycosides. Swine have been poisoned in Europe, and circumstantial reports of poisoning of cattle and turkeys have been noted. Berries eaten raw can cause nausea and vomiting in humans (Cooper and Johnson 1984). Children should not be allowed to ingest the berries.

References:

Cooper, M. R., Johnson, A. W. 1984. Poisonous plants in Britain and their effects on animals and man. Her Majesty's Stationery Office, London, England. 305 pp.

Nomenclature:

Scientific Name: *Sambucus nigra* L.

Vernacular name(s): European elder

Scientific family name: *Caprifoliaceae*

Vernacular family name: honeysuckle

Go to ITIS^{*ca} for more taxonomic information on: [Sambucus nigra](#)

References:

Agriculture Quebec. 1975. Noms des maladies des plantes du Canada/ Names of plant diseases in Canada. , Quebec City, Que., Canada. 288 pp.

Alex, J. F., Cayouette, R., Mulligan, G. A. 1980. Common and botanical names of weeds in Canada/Noms populaire et

scientifiques des plantes nuisibles du Canada. Revised. Agric. Can. Publ., Ottawa, Ont., Canada. 132 pp.

Bailey, L. H., Bailey, E. Z. 1976. Hortus third. Revised. MacMillan, New York, N.Y., USA. 1290 pp.

Scoggan, H. J. 1978, 1979. The flora of Canada. Nat. Mus. Nat. Sci. (Ottawa) Publ. Bot. 7(1)-7(4). 1711 pp.

Van Wijk, H. L. 1911. A dictionary of plant names. Martinus Nijhoff, The Hague, The Netherlands. 1444 pp.

Victorin, M. 1964. Flore Laurentienne. 2nd ed. Univ. Montreal, Montreal, Que., Canada. 952 pp.

Geographic Information

Plant or plant parts used in or around the home.

References:

Bailey, L. H., Bailey, E. Z. 1976. Hortus third. Revised. MacMillan, New York, N.Y., USA. 1290 pp.

Boivin, B. 1966, 1967. Énumération des plantes du Canada. Provencheria 6. Nat. Can. (Que.) 93: 253-274; 371-437; 583-646; 989-1063. 94: 131-157; 471-528; 625-655.

Image or illustration

European elder:

Images: images.google.com

Notes on Poisonous plant parts:

The bark, leaves, and berries can cause poisoning in animals. The roots and stems have caused poisoning in humans. Ingesting quantities of uncooked berries can cause nausea (Cooper and Johnson 1984).

Toxic parts:

bark
leaves
mature fruit
roots
stems

References:

Cooper, M. R., Johnson, A. W. 1984. Poisonous plants in Britain and their effects on animals and man. Her Majesty's Stationery Office, London, England. 305 pp.

Tewe, O. O., Iyayi, E. A. 1989. Cyanogenic glycosides. Pages 43-60 in Cheeke, P. R., ed. Toxicants of plant origin. Vol. II. Glycosides. CRC Press, Inc., Boca Raton, Fla., USA. 277 pp.

Notes on Toxic plant chemicals:

Two cyanogenic glycosides, sambunigrin and vicianin, occur in black elderberry. Hydrocyanic acid can be released in animals by the action of plant enzymes after ingestion (Tewe and Iyayi 1989).

Toxic plant chemicals:

sambunigrin
vicianin

References:

Tewe, O. O., Iyayi, E. A. 1989. Cyanogenic glycosides. Pages 43-60 in Cheeke, P. R., ed. Toxicants of plant origin. Vol. II. Glycosides. CRC Press, Inc., Boca Raton, Fla., USA. 277 pp.

Animals/Human Poisoning:

Note: When an animal is listed without additional information, the literature (as of 1993) contained no detailed explanation.

Humans

General symptoms of poisoning:

[nausea](#)
[vomiting](#)

Notes on poisoning:

Humans have developed nausea and vomiting after ingesting uncooked berries. Cooking destroys the toxin. Children were poisoned when they used the hollow stems of elders as pipes (Cooper and Johnson 1984).

References:

Cooper, M. R., Johnson, A. W. 1984. Poisonous plants in Britain and their effects on animals and man. Her Majesty's Stationery Office, London, England. 305 pp.

Swine

General symptoms of poisoning:

[abdominal pains](#)

[breathing, rapid](#)

[death](#)

[diarrhea](#)

[heart rate, elevated](#)

[paralysis, posterior](#)

[salivation](#)

[trembling](#)

[vomiting](#)

Notes on poisoning:

In one European case, pigs ate young leaves and within a day showed symptoms, including salivation, vomiting, abdominal pain, diarrhea, paralysis, trembling, and unsteadiness. Several pigs died (Cooper and Johnson 1984).

References:

Cooper, M. R., Johnson, A. W. 1984. Poisonous plants in Britain and their effects on animals and man. Her Majesty's Stationery Office, London, England. 305 pp.

[Another search?](#)

[Français](#) | [Contact Us](#) | [Help](#) | [Search](#) | [Canada site](#)

[Coming Events](#) | [About CBIF](#) | [Links](#) | [Reports and Publications](#) |

[Home](#)

Date modified: 2003-02-06

[Important Notices](#)



Français	Contact us	Help	Search	Canada site
Coming events	About CBIF	Links	Reports and publications	Home

Canadian Biodiversity Information Facility



Notes on poisoning: European spindletree

[Introduction](#)[Interactive](#)[All poisonous plants by Botanical name](#)[All poisonous plants by Common name](#)[Important WWW Poisonous Plants sites](#)

General poisoning notes:

European spindletree (*Euonymus europaeus*) is an ornamental shrub that can grow in the warmer parts of Canada. The shrub has poisoned children as well as goats, horses, and sheep. Children are attracted to the mature fleshy orange fruits, which contain seeds with cardiac glycosides and alkaloids. Children have become quite ill. Fatal poisoning has occurred in two horses after they ingested shoots of this plant (Frohne and Pfander 1983, Cooper and Johnson 1984, Lampe and McCann 1985).

References:

Cooper, M. R., Johnson, A. W. 1984. Poisonous plants in Britain and their effects on animals and man. Her Majesty's Stationery Office, London, England. 305 pp.

Frohne, D., Pfander, H. J. 1983. A colour atlas of poisonous plants. Wolfe Publishing Ltd., London, England. 291 pp.

Lampe, K. F., McCann, M. A. 1985. AMA Handbook of poisonous and injurious plants. American Medical Assoc. Chicago, Ill., USA. 432 pp.

Nomenclature:

Scientific Name: *Euonymus europaeus* L.

Vernacular name(s): European spindletree

Scientific family name: *Celastraceae*

Vernacular family name: stafftree

Go to ITIS^{*ca} for more taxonomic information on: [Euonymus europaeus](#)

References:

Agriculture Quebec. 1975. Noms des maladies des plantes du Canada/ Names of plant diseases in Canada. , Quebec City, Que., Canada. 288 pp.

Alex, J. F., Cayouette, R., Mulligan, G. A. 1980. Common and botanical names of weeds in Canada/Noms populaire et scientifiques des plantes nuisibles du Canada. Revised. Agric. Can. Publ., Ottawa, Ont., Canada. 132 pp.

Bailey, L. H., Bailey, E. Z. 1976. Hortus third. Revised. MacMillan, New York, N.Y., USA. 1290 pp.

Scoggan, H. J. 1978, 1979. The flora of Canada. Nat. Mus. Nat. Sci. (Ottawa) Publ. Bot. 7(1)-7(4). 1711 pp.

Van Wijk, H. L. 1911. A dictionary of plant names. Martinus Nijhoff, The Hague, The Netherlands. 1444 pp.

Victorin, M. 1964. Flore Laurentienne. 2nd ed. Univ. Montreal, Montreal, Que., Canada. 952 pp.

Geographic Information

Plant or plant parts used in or around the home.

References:

Bailey, L. H., Bailey, E. Z. 1976. Hortus third. Revised. MacMillan, New York, N.Y., USA. 1290 pp.

Boivin, B. 1966, 1967. Énumération des plantes du Canada. Provencheria 6. Nat. Can. (Que.) 93: 253-274; 371-437; 583-646; 989-1063. 94: 131-157; 471-528; 625-655.

Image or illustration

European spindletree:

Images: images.google.com

Notes on Poisonous plant parts:

The conspicuous fruiting structures of the European spindletree entice children to eat them. The seeds contain toxins that have caused poisoning of children (Frohne and Pfander 1983).

Toxic parts:

bark

leaves

seeds

References:

Frohne, D., Pfander, H. J. 1983. A colour atlas of poisonous plants. Wolfe Publishing Ltd., London, England. 291 pp.

Notes on Toxic plant chemicals:

Several cardiac glycosides have been found in the seeds, including evomonoside, whose aglycone is digitoxigenin. Alkaloids also make up about 0.1% of the seeds, including evonine. The toxicity of the alkaloidal fraction has not been studied. Cardiac glycosides are also found in the leaves and bark (the alkaloid content is too low to be of any consequence) (Frohne and Pfander 1983, Lampe and McCann 1985).

Toxic plant chemicals:

evomonoside

evonine

References:

Frohne, D., Pfander, H. J. 1983. A colour atlas of poisonous plants. Wolfe Publishing Ltd., London, England. 291 pp.

Lampe, K. F., McCann, M. A. 1985. AMA Handbook of poisonous and injurious plants. American Medical Assoc. Chicago, Ill., USA. 432 pp.

Animals/Human Poisoning:

Note: When an animal is listed without additional information, the literature (as of 1993) contained no detailed explanation.

Goats

Horses

General symptoms of poisoning:

[constipation](#)

[death](#)

[heart rate, elevated](#)

Notes on poisoning:

In one case in Europe, two horses had access to the shoots of European spindletree and they ingested large quantities of them. The animals suffered paralysis of the digestive tract. The pulse was rapid and the horses died within 4 days. Postmortem examination showed inflammation of the intestines (Cooper and Johnson 1984).

References:

Cooper, M. R., Johnson, A. W. 1984. Poisonous plants in Britain and their effects on animals and man. Her Majesty's Stationery Office, London, England. 305 pp.

Humans

General symptoms of poisoning:

[convulsions](#)

[death](#)

[diarrhea](#)

[hallucination](#)

[vomiting](#)

Notes on poisoning:

Children are attracted to the bright orange fruits, which contain toxic seeds. Symptoms occur 10-12 h after ingestion and include diarrhea, vomiting, stimulation of the heart and, in more severe cases, hallucination and loss of consciousness. In one fatal case, the child had blood-stained diarrhea and convulsions before death (Cooper and Johnson 1984).

References:

Cooper, M. R., Johnson, A. W. 1984. Poisonous plants in Britain and their effects on animals and man. Her Majesty's Stationery Office, London, England. 305 pp.

Sheep

[Another search?](#)

[Français](#) | [Contact Us](#) | [Help](#) | [Search](#) | [Canada site](#)

[Coming Events](#) | [About CBIF](#) | [Links](#) | [Reports and Publications](#) | [Home](#)

Date modified: 2003-02-06

[Important Notices](#)



Français	Contact us	Help	Search	Canada site
Coming events	About CBIF	Links	Reports and publications	Home

Canadian Biodiversity Information Facility



Notes on poisoning: false hellebore

[Introduction](#)

[Interactive](#)

[All poisonous plants by Botanical name](#)

[All poisonous plants by Common name](#)

[Important WWW Poisonous Plants sites](#)



General poisoning notes:

False hellebore (*Veratrum viride*) is a native perennial plant that is found in parts of eastern and western Canada. The plant contains several steroidal alkaloids. Jervine was shown to be teratogenic in laboratory animals. Livestock do not often ingest the plant, but cattle, poultry, and sheep, have been poisoned. Some deaths may have occurred. The roots, rhizome, and young shoots are most toxic. Humans have been poisoned after ingesting the plant. Extracts from the plant have been used in cases of hypertension and as an insecticide (Fyles 1920, Dayton 1960, Campbell et al. 1985, Mulligan and Munro 1987, Jaffe et al. 1989).

References:

- Campbell, M. A., Brown, K. S., Hassell, J. R., Horigan, E. A., Keeler, R. F. 1985. Inhibition of limb chondrogenesis by a *Veratrum* alkaloid: temporal specificity in vivo and in vitro. Can. Dep. Agric. Exp. Farms Bull., 111: 464-470.
- Dayton, W. A. 1960. Notes on western range forbes. U. S. For. Serv. Wash. Agric. Hand., 161. 254 pp.
- Fyles, F. 1920. Principal poisonous plants of Canada. Can. Dep. Agric. Exp. Farms. Bull. 39. 112 pp.
- Jaffe, A. M., Gephardt, D., Courtemanche, L. 1990. Poisoning due to ingestion of *Veratrum viride* (false hellebore). J. Emerg. Med., 8: 161-167.
- Kingsbury, J. M. 1964. Poisonous plants of the United States and Canada. Prentice-Hall Inc., Englewood Cliffs, N.J., USA. 626 pp.
- Long, R. 1981. Some liliaceae of British Columbia. Davidsonia, 12: 85-88.
- Reynard, G. B., Norton, J. B. 1942. Poisonous plants of Maryland in relation to livestock. Univ. MD. Agric. Exp. Stn. Bull., A10. 312 pp.
- Underhill, J. E. 1959. A case of hellebore poisoning. Can. Field-Nat., 73: 128-129.

Nomenclature:

Scientific Name: *Veratrum viride* Ait.

Vernacular name(s): false hellebore

Scientific family name: *Liliaceae*

Vernacular family name: lily

Go to ITIS*ca for more taxonomic information on: [Veratrum viride](#)

References:

Agriculture Quebec. 1975. Noms des maladies des plantes du Canada/
Names of plant diseases in Canada. , Quebec City, Que., Canada. 288 pp.

Alex, J. F., Cayouette, R., Mulligan, G. A. 1980. Common and botanical names of weeds in Canada/Noms populaire et scientifiques des plantes nuisibles du Canada. Revised. Agric. Can. Publ., Ottawa, Ont., Canada. 132 pp.

Bailey, L. H., Bailey, E. Z. 1976. Hortus third. Revised. MacMillan, New York, N.Y., USA. 1290 pp.

Scoggan, H. J. 1978, 1979. The flora of Canada. Nat. Mus. Nat. Sci. (Ottawa) Publ. Bot. 7(1)-7(4). 1711 pp.

Van Wijk, H. L. 1911. A dictionary of plant names. Martinus Nijhoff, The Hague, The Netherlands. 1444 pp.

Victorin, M. 1964. Flore Laurentienne. 2nd ed. Univ. Montreal, Montreal, Que., Canada. 952 pp.

Geographic Information

Alberta

British Columbia

Labrador

New Brunswick

Northwest Territories

Quebec

Yukon Territory

References:

Bailey, L. H., Bailey, E. Z. 1976. Hortus third. Revised. MacMillan, New York, N.Y., USA. 1290 pp.

Boivin, B. 1966, 1967. Énumération des plantes du Canada. Provencheria 6. Nat. Can. (Que.) 93: 253-274; 371-437; 583-646; 989-1063. 94: 131-157; 471-528; 625-655.

Image or illustration

false hellebore:

Images: images.google.com

Notes on Poisonous plant parts:

The steroidal alkaloids are most abundant in roots, rhizomes, and young shoots. Sheep can apparently eat, with impunity, plants that were frosted in the autumn (Dayton 1960).

Toxic parts:

rhizome
roots
young shoots

References:

Campbell, M. A., Brown, K. S., Hassell, J. R., Horigan, E. A., Keeler, R. F. 1985. Inhibition of limb chondrogenesis by a *Veratrum* alkaloid: temporal specificity in vivo and in vitro. Can. Dep. Agric. Exp. Farms Bull., 111: 464-470.

Dayton, W. A. 1960. Notes on western range forbes. U. S. For. Serv. Wash. Agric. Hand., 161. 254 pp.

Notes on Toxic plant chemicals:

The steroidal alkaloid jervine has been isolated from false hellebore. This alkaloid can exert teratogenic effects in several animal species. The LD-50 for jervine in two strains of mice was 220 mg/kg and 260 mg/kg. Some strains of mice were resistant to the teratogenic effects of jervine (Campbell et al. 1985). Several other alkaloids have also been isolated. Germidine is an alkaloid that was studied as a possible drug for hypertension (Claus and Tyler 1965).

Toxic plant chemicals:

germidine
jervine

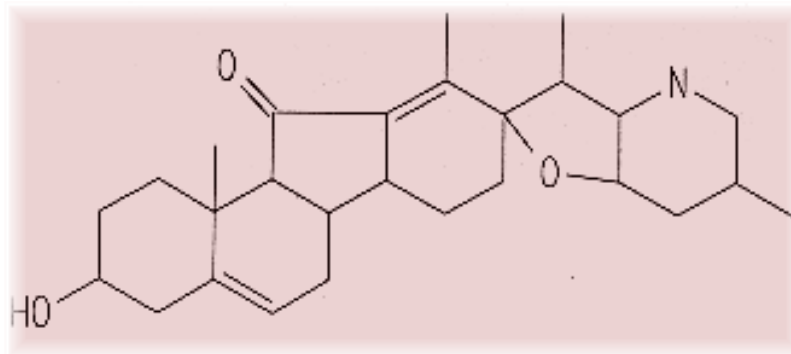

Chemical diagram(s) are courtesy of [Ruth McDiarmid](#), Biochemistry Technician, Kamloops Range Station, Agriculture and Agri-Food Canada, Kamloops, British Columbia, Canada.

References:

Campbell, M. A., Brown, K. S., Hassell, J. R., Horigan, E. A., Keeler, R. F. 1985. Inhibition of limb chondrogenesis by a *Veratrum* alkaloid: temporal specificity in vivo and in vitro. Can. Dep. Agric. Exp. Farms Bull., 111: 464-470.

Claus, E. P., Tyler, V. E. 1965. Pharmacognosy. Lea & Febiger, Philadelphia, Pa., USA. 572 pp.

Animals/Human Poisoning:

Note: When an animal is listed without additional information, the literature (as of 1993) contained no detailed explanation.

Cattle

General symptoms of poisoning:

[abdominal pains](#)
[blindness, temporary](#)
[diarrhea](#)
[heart rate, slow](#)
[vomiting](#)

Notes on poisoning:

Cattle generally avoid ingesting the plant, although young animals may ingest it, sometimes with fatal results. As with humans, the plant causes depression in an animal's heart rate, low blood pressure, and vomiting (Fyles 1920, Reynard and Norton 1942).

References:

Fyles, F. 1920. Principal poisonous plants of Canada. Can. Dep. Agric. Exp. Farms. Bull. 39. 112 pp.

Reynard, G. B., Norton, J. B. 1942. Poisonous plants of Maryland in relation to livestock. Univ. MD. Agric. Exp. Stn. Bull., A10. 312 pp.

Humans

General symptoms of poisoning:

[blood pressure, low](#)

[heart rate, slow](#)

[nausea](#)

[vomiting](#)

Notes on poisoning:

Humans have ingested false hellebore, mistaking it for another plant. The symptoms include reduced heart rate, low blood pressure, and vomiting. Other symptoms include blurred vision, cramps, nausea, dizziness, and chills. Atropine is used in initial treatment (Boivin 1948, Underhill 1959, Jaffe et al. 1989). False hellebore was used by West Coast Indians to commit suicide (Long 1981).

References:

- Jaffe, A. M., Gephardt, D., Courtemanche, L. 1990. Poisoning due to ingestion of *Veratrum viride* (false hellebore). J. Emerg. Med., 8: 161-167.
- Long, R. 1981. Some liliaceae of British Columbia. Davidsonia, 12: 85-88.
- Underhill, J. E. 1959. A case of hellebore poisoning. Can. Field-Nat., 73: 128-129.

Poultry

Rodents

General symptoms of poisoning:

[oligodactylism](#)

References:

- Campbell, M. A., Brown, K. S., Hassell, J. R., Horigan, E. A., Keeler, R. F. 1985. Inhibition of limb chondrogenesis by a *Veratrum* alkaloid: temporal specificity in vivo and in vitro. Can. Dep. Agric. Exp. Farms Bull., 111: 464-470.

Sheep

General symptoms of poisoning:

[nausea](#)

[salivation](#)

Notes on poisoning:

Sheep are apparently less affected by ingesting false hellebore and can eat the leaves with apparent impunity after the leaves have been killed by frost (Reynard and Norton 1942, Dayton 1960).

References:

Dayton, W. A. 1960. Notes on western range forbes. U. S. For. Serv. Wash. Agric. Hand., 161. 254 pp.

Reynard, G. B., Norton, J. B. 1942. Poisonous plants of Maryland in relation to livestock. Univ. MD. Agric. Exp. Stn. Bull., A10. 312 pp.

[Another search?](#)

[Français](#) | [Contact Us](#) | [Help](#) | [Search](#) | [Canada site](#)

[Coming Events](#) | [About CBIF](#) | [Links](#) | [Reports and Publications](#) | [Home](#)

Date modified: 2003-02-06

[Important Notices](#)



Français	Contact us	Help	Search	Canada site
Coming events	About CBIF	Links	Reports and publications	Home

Canadian Biodiversity Information Facility



Notes on poisoning: false ragweed

[Introduction](#)[Interactive](#)[All poisonous plants by Botanical name](#)[All poisonous plants by Common name](#)[Important WWW Poisonous Plants sites](#)

General poisoning notes:

False ragweed (*Iva xanthifolia*) is a native herb found across southern Canada. The plant can cause dermatitis in sensitive humans after they come in contact with the leaves. Lactating cows that ingest the leaves produce bitter-tasting milk (Muenscher 1975, Mitchell and Rook 1979).



References:

Muenscher, W. C. 1975. Poisonous plants of the United States. Revised. Collier Books, New York, N.Y., USA. 277 pp.

Nomenclature:

Scientific Name: *Iva xanthifolia* Nutt.

Vernacular name(s): false ragweed

Scientific family name: *Compositae*

Vernacular family name: composite

Go to ITIS^{*ca} for more taxonomic information on: [Iva xanthifolia](#)

References:

Agriculture Quebec. 1975. Noms des maladies des plantes du Canada/ Names of plant diseases in Canada. , Quebec City, Que., Canada. 288 pp.

Alex, J. F., Cayouette, R., Mulligan, G. A. 1980. Common and botanical names of weeds in Canada/Noms populaire et scientifiques des plantes nuisibles du Canada. Revised. Agric. Can. Publ., Ottawa, Ont., Canada. 132 pp.

Bailey, L. H., Bailey, E. Z. 1976. Hortus third. Revised.

MacMillan, New York, N.Y., USA. 1290 pp.

Scoggan, H. J. 1978, 1979. The flora of Canada. Nat. Mus. Nat. Sci. (Ottawa) Publ. Bot. 7(1)-7(4). 1711 pp.

Van Wijk, H. L. 1911. A dictionary of plant names. Martinus Nijhoff, The Hague, The Netherlands. 1444 pp.

Victorin, M. 1964. Flore Laurentienne. 2nd ed. Univ. Montreal, Montreal, Que., Canada. 952 pp.

Geographic Information

Alberta

British Columbia

Manitoba

New Brunswick

Nova Scotia

Ontario

Prince Edward Island

Quebec

Saskatchewan

References:

Bailey, L. H., Bailey, E. Z. 1976. Hortus third. Revised. MacMillan, New York, N.Y., USA. 1290 pp.

Boivin, B. 1966, 1967. Énumération des plantes du Canada. Provencheria 6. Nat. Can. (Que.) 93: 253-274; 371-437; 583-646; 989-1063. 94: 131-157; 471-528; 625-655.

Image or illustration

false ragweed:

Images: images.google.com

Toxic parts:

leaves

References:

Mitchell, J. C., Rook, A. 1979. Botanical dermatology. Greenglass Ltd, Vancouver, B.C., Canada. 787 pp.

Muenschler, W. C. 1975. Poisonous plants of the United States. Revised. Collier Books, New York, N.Y., USA. 277 pp.

Notes on Toxic plant chemicals:

Mitchell and Rook (1979) report that potentially allergenic sesquiterpene lactones have been isolated from some members of the genus *Iva*.

Toxic plant chemicals:

unknown chemical

References:

Mitchell, J. C., Rook, A. 1979. Botanical dermatology. Greenglass Ltd, Vancouver, B.C., Canada. 787 pp.

Animals/Human Poisoning:

Note: When an animal is listed without additional information, the literature (as of 1993) contained no detailed explanation.

Humans

General symptoms of poisoning:

[erythema](#)

References:

Muenschler, W. C. 1975. Poisonous plants of the United States. Revised. Collier Books, New York, N.Y., USA. 277 pp.

[Another search?](#)

[Français](#) | [Contact Us](#) | [Help](#) | [Search](#) | [Canada site](#)

[Coming Events](#) | [About CBIF](#) | [Links](#) | [Reports and Publications](#) |

[Home](#)

Date modified: 2003-02-06

[Important Notices](#)



Français	Contact us	Help	Search	Canada site
Coming events	About CBIF	Links	Reports and publications	Home

Canadian Biodiversity Information Facility



Notes on poisoning: February daphne

[Introduction](#)[Interactive](#)[All poisonous plants by Botanical name](#)[All poisonous plants by Common name](#)[Important WWW Poisonous Plants sites](#)

General poisoning notes:

February daphne (*Daphne mezereum*) is an ornamental shrub that grows across southern Canada. This shrub and other *Daphne* species are poisonous to humans and animals. The plants contain irritant chemicals that cause pain, burning, and tingling sensations on exposed skin. These sensations are intensified on mucous membranes in the mouth, throat, and stomach after ingesting the fruits. More serious symptoms also occur in humans, including kidney damage, which may lead to death. With the exception of February daphne, the other *Daphne* species and cultivars are found only as ornamental plants in the more southerly and temperate parts of Canada. February daphne is naturalized in several eastern provinces. Horses and swine have been poisoned and have died after ingesting daphne leaves or berries, although poisoning of animals is a rare occurrence. Family pets can be poisoned if they have access to the plants. Several references give additional information (Frohne and Pfander 1983, Cooper and Johnson 1984, Lampe and McCann 1985, Fuller and McClintock 1986).

References:

- Cooper, M. R., Johnson, A. W. 1984. Poisonous plants in Britain and their effects on animals and man. Her Majesty's Stationery Office, London, England. 305 pp.
- Frohne, D., Pfander, H. J. 1983. A colour atlas of poisonous plants. Wolfe Publishing Ltd., London, England. 291 pp.
- Fuller, T. C., McClintock, E. 1986. Poisonous plants of California. Univ. California Press, Berkeley, Calif., USA. 432 pp.
- Fyles, F. 1920. Principal poisonous plants of Canada. Can. Dep. Agric. Exp. Farms. Bull. 39. 112 pp.
- Lampe, K. F., McCann, M. A. 1985. AMA Handbook of

poisonous and injurious plants. American Medical Assoc.
Chicago, Ill., USA. 432 pp.

Nomenclature:

Scientific Name: *Daphne mezereum* L.

Vernacular name(s): February daphne

Scientific family name: *Thymelaeaceae*

Vernacular family name: mezereum

Go to ITIS^{*ca} for more taxonomic information on: [Daphne mezereum](#)

References:

Agriculture Quebec. 1975. Noms des maladies des plantes du Canada/ Names of plant diseases in Canada. , Quebec City, Que., Canada. 288 pp.

Alex, J. F., Cayouette, R., Mulligan, G. A. 1980. Common and botanical names of weeds in Canada/Noms populaire et scientifiques des plantes nuisibles du Canada. Revised. Agric. Can. Publ., Ottawa, Ont., Canada. 132 pp.

Bailey, L. H., Bailey, E. Z. 1976. Hortus third. Revised. MacMillan, New York, N.Y., USA. 1290 pp.

Scoggan, H. J. 1978, 1979. The flora of Canada. Nat. Mus. Nat. Sci. (Ottawa) Publ. Bot. 7(1)-7(4). 1711 pp.

Van Wijk, H. L. 1911. A dictionary of plant names. Martinus Nijhoff, The Hague, The Netherlands. 1444 pp.

Victorin, M. 1964. Flore Laurentienne. 2nd ed. Univ. Montreal, Montreal, Que., Canada. 952 pp.

Geographic Information

Newfoundland

Nova Scotia

Ontario

Prince Edward Island

Quebec

References:

Bailey, L. H., Bailey, E. Z. 1976. Hortus third. Revised. MacMillan, New York, N.Y., USA. 1290 pp.

Boivin, B. 1966, 1967. Énumération des plantes du Canada.

Provencheria 6. Nat. Can. (Que.) 93: 253-274; 371-437; 583-646; 989-1063. 94: 131-157; 471-528; 625-655.

Image or illustration

February daphne:

Images: images.google.com

Notes on Poisonous plant parts:

All the *Daphne* species in this information system have the same toxic chemical found in all parts of the plant. The only part of the plants without mezerein is the fruit pulp. It is the broken seeds that are responsible for symptoms when fruit is chewed. Ingesting one or two of the bitter berries can cause severe poisoning in children. Twelve berries can be fatal to an adult human (Frohne and Pfander 1983, Fuller and McClintock 1986).

Toxic parts:

all parts
bark
flowers
mature fruit
seeds

References:

Frohne, D., Pfander, H. J. 1983. A colour atlas of poisonous plants. Wolfe Publishing Ltd., London, England. 291 pp.

Fuller, T. C., McClintock, E. 1986. Poisonous plants of California. Univ. California Press, Berkeley, Calif., USA. 432 pp.

Notes on Toxic plant chemicals:

Daphnetoxin and mezerein are diterpene alcohols with a daphnane skeleton. Mezerein has cocarcinogenic activity as does the chemically related phorbol esters found in many toxic members of the spurge family (Euphorbiaceae). In mice, daphnetoxin was determined to have an LD-50 of 275 micro g/kg and the mouse ear inflammation unit is 0.2 micro g of mezerein per ear (Frohne and Pfander 1983). The bark of these daphne plants contains a coumarin glycoside that has the aglycone dihydroxycoumarin (Fuller and McClintock 1986).

Toxic plant chemicals:

daphnetoxin
dihydroxycoumarin
mezerin

References:

Fuller, T. C., McClintock, E. 1986. Poisonous plants of California. Univ. California Press, Berkeley, Calif., USA. 432 pp.

Lampe, K. F., McCann, M. A. 1985. AMA Handbook of poisonous and injurious plants. American Medical Assoc. Chicago, Ill., USA. 432 pp.

Animals/Human Poisoning:

Note: When an animal is listed without additional information, the literature (as of 1993) contained no detailed explanation.

Dogs

Horses

General symptoms of poisoning:

[abdominal pains](#)

[death](#)

[vomiting](#)

Notes on poisoning:

Horses have been poisoned by the leaves and berries of the *Daphne* species. Abdominal pains, breathing problems, and death occurred. Post-mortem symptoms included inflammation, swelling, and blood-stained contents of the gastrointestinal tract. Experimental feeding produced similar symptoms but did not result in death. Only 100-150 g of the plants, which are bitter, were eaten (Cooper and Johnson 1984).

References:

Cooper, M. R., Johnson, A. W. 1984. Poisonous plants in Britain and their effects on animals and man. Her Majesty's Stationery Office, London, England. 305 pp.

Humans

General symptoms of poisoning:

[abdominal pains](#)

[breathing, labored](#)

[convulsions](#)

[death](#)

[diarrhea](#)

[dysphagia](#)

[gait, staggering](#)

[hoarseness](#)

[kidney failure](#)

[mouth, irritation of](#)

[muscle twitching](#)

[prostration](#)

[temperature, elevated](#)

[thirsty](#)

[vomiting](#)

Notes on poisoning:

Human poisoning by the *Daphne* species can include minor irritation of the mouth region including pain, burning, and tingling. If the plant material is also chewed and ingested, more severe symptoms occur, including bloody diarrhea, abdominal pains, vomiting, and convulsions. In severe cases, prostration, hallucinations, shedding of the lining of the oral and mucous membranes, and renal damage can occur. In one case, a child was killed in Nova Scotia after ingesting berries (Fyles 1920). Ingestion may lead to muscular twitching and somnolence, which persists for days. Few cases of poisoning actually occur, but the consequences of ingestion can be serious (Frohne and Pfander 1983, Cooper and Johnson 1984, Lampe and McCann 1985, Fuller and McClintock 1985).

References:

Cooper, M. R., Johnson, A. W. 1984. Poisonous plants in Britain and their effects on animals and man. Her Majesty's Stationery Office, London, England. 305 pp.

Frohne, D., Pfander, H. J. 1983. A colour atlas of poisonous plants. Wolfe Publishing Ltd., London, England. 291 pp.

Fuller, T. C., McClintock, E. 1986. Poisonous plants of California. Univ. California Press, Berkeley, Calif., USA. 432 pp.

Lampe, K. F., McCann, M. A. 1985. AMA Handbook of poisonous and injurious plants. American Medical Assoc. Chicago, Ill., USA. 432 pp.

Swine

General symptoms of poisoning:

[death](#)

[vomiting](#)

Notes on poisoning:

A litter of 10-week-old pigs were given daphne berries and they died suddenly. The pigs had vomited before they died. Postmortem examination revealed white, burned patches in the mouth and an intensely inflamed stomach (Cooper and Johnson 1984).

References:

Cooper, M. R., Johnson, A. W. 1984. Poisonous plants in Britain and their effects on animals and man. Her Majesty's Stationery Office, London, England. 305 pp.

[Another search?](#)

[Français](#) | [Contact Us](#) | [Help](#) | [Search](#) | [Canada site](#)

[Coming Events](#) | [About CBIF](#) | [Links](#) | [Reports and Publications](#) | [Home](#)

Date modified: 2003-02-06

[Important Notices](#)



Français	Contact us	Help	Search	Canada site
Coming events	About CBIF	Links	Reports and publications	Home

Canadian Biodiversity Information Facility



Notes on poisoning: fiddleneck

[Introduction](#)

[Interactive](#)

[All poisonous plants by Botanical name](#)

[All poisonous plants by Common name](#)

[Important WWW Poisonous Plants sites](#)



General poisoning notes:

Fiddleneck (*Amsinckia intermedia*) is an introduced plant found in parts of western Canada. Ingestion can cause severe diseases in horses, swine, and cattle. Hepatic cirrhosis results from ingesting the seeds of the plant. The symptoms are termed walking disease in horses and are known as hard liver disease in swine and cattle. These diseases were present mainly in California and the Pacific Northwest. With the advent of herbicides, the problems have mostly disappeared (Woolsey et al. 1952, Cheeke and Schull 1985).

References:

Cheeke, P. R., Shull, L. R. 1985. Natural toxicants in feeds and poisonous plants. AVI Publishing Company, Inc., Westport, Conn., USA. 492 pp.

Kennedy, P. C. 1957. Symposium on poisoning-part 2. Case 16-Tarweed poisoning in swine. J. Am. Vet. Med. Assoc., 130: 305-306.

McCulloch, E. C. 1940. Hepatic cirrhosis of horses, swine and cattle due to the ingestion of seeds of the tarweed, *Amsinckia intermedia*. J. Am. Vet. Med. Assoc., 96: 5-18.

Woolsey, J. H., Jasper, D. E., Cordy, D. R., Christensen, J. F. 1952. Two outbreaks of hepatic cirrhosis in swine in California, with evidence incriminating the tarweed, *Amsinckia intermedia*. Vet. Med. Small Anim. Clin., 47: 55-58.

Nomenclature:

Scientific Name: *Amsinckia intermedia* Fisch & Mey.

Vernacular name(s): fiddleneck

Scientific family name: *Boraginaceae*

Vernacular family name: borage

Go to ITIS^{*ca} for more taxonomic information on: [Amsinckia intermedia](#)

References:

Agriculture Quebec. 1975. Noms des maladies des plantes du Canada/ Names of plant diseases in Canada. , Quebec City, Que., Canada. 288 pp.

Alex, J. F., Cayouette, R., Mulligan, G. A. 1980. Common and botanical names of weeds in Canada/Noms populaire et scientifiques des plantes nuisibles du Canada. Revised. Agric. Can. Publ., Ottawa, Ont., Canada. 132 pp.

Bailey, L. H., Bailey, E. Z. 1976. Hortus third. Revised. MacMillan, New York, N.Y., USA. 1290 pp.

Scoggan, H. J. 1978, 1979. The flora of Canada. Nat. Mus. Nat. Sci. (Ottawa) Publ. Bot. 7(1)-7(4). 1711 pp.

Van Wijk, H. L. 1911. A dictionary of plant names. Martinus Nijhoff, The Hague, The Netherlands. 1444 pp.

Victorin, M. 1964. Flore Laurentienne. 2nd ed. Univ. Montreal, Montreal, Que., Canada. 952 pp.

Geographic Information

Alberta
British Columbia
Manitoba
Saskatchewan
Yukon Territory

References:

Bailey, L. H., Bailey, E. Z. 1976. Hortus third. Revised. MacMillan, New York, N.Y., USA. 1290 pp.

Boivin, B. 1966, 1967. Énumération des plantes du Canada. Provencheria 6. Nat. Can. (Que.) 93: 253-274; 371-437; 583-646; 989-1063. 94: 131-157; 471-528; 625-655.

Image or illustration

fiddleneck:

Images: images.google.com

Toxic parts:

seeds

References:

McCulloch, E. C. 1940. Hepatic cirrhosis of horses, swine and cattle due to the ingestion of seeds of the tarweed, *Amsinckia intermedia*. J. Am. Vet. Med. Assoc., 96: 5-18.

Woolsey, J. H., Jasper, D. E., Cordy, D. R., Christensen, J. F. 1952. Two outbreaks of hepatic cirrhosis in swine in California, with evidence incriminating the tarweed, *Amsinckia intermedia*. Vet. Med. Small Anim. Clin., 47: 55-58.

Notes on Toxic plant chemicals:

The pyrrolizidine alkaloids of fiddleneck cause hepatic cirrhosis in cattle, swine, and horses, mainly a result of the presence of the seeds in grain and grain screenings fed to livestock. With modern herbicides, the problem has disappeared (Cheeke and Schull 1985).

Toxic plant chemicals:

echiumine
intermedine
lycopsamine

References:

Cheeke, P. R., Shull, L. R. 1985. Natural toxicants in feeds and poisonous plants. AVI Publishing Company, Inc., Westport, Conn., USA. 492 pp.

Animals/Human Poisoning:

Note: When an animal is listed without additional information, the literature (as of 1993) contained no detailed explanation.

Cattle

General symptoms of poisoning:

[abdominal pains](#)

[death](#)

[icterus](#)

[liver, cirrhosis of](#)

References:

McCulloch, E. C. 1940. Hepatic cirrhosis of horses, swine and cattle due to the ingestion of seeds of the tarweed, *Amsinckia intermedia*. J. Am. Vet. Med. Assoc., 96: 5-18.

Horses

General symptoms of poisoning:

[death](#)

[hemoglobinuria](#)

[icterus](#)

[liver, cirrhosis of](#)

References:

McCulloch, E. C. 1940. Hepatic cirrhosis of horses, swine and cattle due to the ingestion of seeds of the tarweed, *Amsinckia intermedia*. J. Am. Vet. Med. Assoc., 96: 5-18.

Swine

General symptoms of poisoning:

[abdomen, distended](#)

[anemia](#)

[appetite, loss of](#)

[ascites](#)

[death](#)

[icterus](#)

[liver, cirrhosis of](#)

[prostration](#)

[weakness](#)

[weight gain, reduced](#)

[weight loss](#)

References:

Kennedy, P. C. 1957. Symposium on poisoning-part 2. Case 16-Tarweed poisoning in swine. J. Am. Vet. Med. Assoc., 130: 305-306.

McCulloch, E. C. 1940. Hepatic cirrhosis of horses, swine and cattle due to the ingestion of seeds of the tarweed, *Amsinckia intermedia*. J. Am. Vet. Med. Assoc., 96: 5-18.

Woolsey, J. H., Jasper, D. E., Cordy, D. R., Christensen, J. F.

1952. Two outbreaks of hepatic cirrhosis in swine in California, with evidence incriminating the tarweed, *Amsinckia intermedia*. Vet. Med. Small Anim. Clin., 47: 55-58.

[Another search?](#)

[Français](#) | [Contact Us](#) | [Help](#) | [Search](#) | [Canada site](#)

[Coming Events](#) | [About CBIF](#) | [Links](#) | [Reports and Publications](#) |

[Home](#)

Date modified: 2003-02-06

[Important Notices](#)



Français	Contact us	Help	Search	Canada site
Coming events	About CBIF	Links	Reports and publications	Home

Canadian Biodiversity Information Facility



Notes on poisoning: field horsetail

[Introduction](#)[Interactive](#)[All poisonous plants by Botanical name](#)[All poisonous plants by Common name](#)[Important WWW Poisonous Plants sites](#)

General poisoning notes:

Field horsetail (*Equisetum arvense*) is a native plant growing across Canada. This plant contains thiaminase which causes thiamine deficiency in horses. Ruminants are not generally affected by problems of thiamine deficiency because it is made in the rumen. However, some cattle were reported to have symptoms. In Canada, horses have been poisoned by ingesting field horsetail (Henderson et al. 1952, Cheeke and Schull 1985).

References:

[Cody, W. J.](#), Wagner, V. 1981. The biology of Canadian weeds. 49. *Equisetum arvense* L., 61: 123-133.

Henderson, J. A., Evans, E. V., McIntosh, R. A. 1951. The antithiamine action to *Equisetum*. J. Am. Vet. Med. Assoc., 120: 375-378.

Nomenclature:

Scientific Name: *Equisetum arvense* L.

Vernacular name(s): field horsetail

Scientific family name: *Equisetaceae*

Vernacular family name: horsetail

Go to ITIS*^{ca} for more taxonomic information on: [Equisetum arvense](#)

References:

Agriculture Quebec. 1975. Noms des maladies des plantes du Canada/ Names of plant diseases in Canada. , Quebec City, Que., Canada. 288 pp.

Alex, J. F., Cayouette, R., Mulligan, G. A. 1980. Common and botanical names of weeds in Canada/Noms populaire et scientifiques des plantes nuisibles du Canada. Revised. Agric. Can. Publ., Ottawa, Ont., Canada. 132 pp.

Bailey, L. H., Bailey, E. Z. 1976. Hortus third. Revised. MacMillan, New York, N.Y., USA. 1290 pp.

Scoggan, H. J. 1978, 1979. The flora of Canada. Nat. Mus. Nat. Sci. (Ottawa) Publ. Bot. 7(1)-7(4). 1711 pp.

Van Wijk, H. L. 1911. A dictionary of plant names. Martinus Nijhoff, The Hague, The Netherlands. 1444 pp.

Victorin, M. 1964. Flore Laurentienne. 2nd ed. Univ. Montreal, Montreal, Que., Canada. 952 pp.

Geographic Information

Alberta
British Columbia
Labrador
Manitoba
New Brunswick
Newfoundland
Northwest Territories
Nova Scotia
Ontario
Prince Edward Island
Quebec
Saskatchewan
Yukon Territory

References:

Bailey, L. H., Bailey, E. Z. 1976. Hortus third. Revised. MacMillan, New York, N.Y., USA. 1290 pp.

Boivin, B. 1966, 1967. Énumération des plantes du Canada. Provencheria 6. Nat. Can. (Que.) 93: 253-274; 371-437; 583-646; 989-1063. 94: 131-157; 471-528; 625-655.

Image or illustration

field horsetail:

Images: images.google.com

Notes on Poisonous plant parts:

The horsetails have separate fertile and sterile fronds. Field horsetail has a fertile frond that is flesh-colored and appears before the green sterile frond.

Toxic parts:

leaves
stems

References:

Cheeke, P. R., Shull, L. R. 1985. Natural toxicants in feeds and poisonous plants. AVI Publishing Company, Inc., Westport, Conn., USA. 492 pp.

Notes on Toxic plant chemicals:

Thiaminase is an enzyme that splits thiamine, a B vitamin, making it inactive. Thiamine is involved in decarboxylation reactions in animal bodies. Deficiency of thiamine leads to accumulation of pyruvate in the blood, with a resulting impairment in energy metabolism and cellular shortage of ATP. Hay that contains horsetail at a level of 20% or more may produce symptoms of thiamine deficiency in horses in 2-5 weeks (Cheeke and Schull 1985).

Toxic plant chemicals:

thiaminase

References:

Cheeke, P. R., Shull, L. R. 1985. Natural toxicants in feeds and poisonous plants. AVI Publishing Company, Inc., Westport, Conn., USA. 492 pp.

Animals/Human Poisoning:

Note: When an animal is listed without additional information, the literature (as of 1993) contained no detailed explanation.

Cattle

Horses

Sheep

[Another search?](#)

[Français](#) | [Contact Us](#) | [Help](#) | [Search](#) | [Canada site](#)

[Coming Events](#) | [About CBIF](#) | [Links](#) | [Reports and Publications](#) |

[Home](#)

Date modified: 2003-02-06

[Important Notices](#)



Français	Contact us	Help	Search	Canada site
Coming events	About CBIF	Links	Reports and publications	Home

Canadian Biodiversity Information Facility



Notes on poisoning: five-hooked bassia

[Introduction](#)

[Interactive](#)

[All poisonous plants by Botanical name](#)

[All poisonous plants by Common name](#)

[Important WWW Poisonous Plants sites](#)

General poisoning notes:

Five-hooked bassia (*Bassia hyssopifolia*) is a naturalized herb found in southern parts of western Canada. The plant is suspected of poisoning livestock. James et al. (1976) report experimental poisoning of sheep after they were fed macerated above-ground parts of the plant.



References:

James, L. F., Williams, M. C., Bleak, A. T. 1976. Toxicity of *Bassia hyssopifolia* to sheep. *J. Range Manage.*, 29: 284-285.

Nomenclature:

Scientific Name: *Bassia hyssopifolia* (Pall.) Ktze.

Vernacular name(s): five-hooked bassia

Scientific family name: *Chenopodiaceae*

Vernacular family name: goosefoot

Go to ITIS*^{ca} for more taxonomic information on: [Bassia hyssopifolia](#)

References:

Agriculture Quebec. 1975. Noms des maladies des plantes du Canada/ Names of plant diseases in Canada. , Quebec City, Que., Canada. 288 pp.

Alex, J. F., Cayouette, R., Mulligan, G. A. 1980. Common and botanical names of weeds in Canada/Noms populaire et scientifiques des plantes nuisibles du Canada. Revised. Agric. Can. Publ., Ottawa, Ont., Canada. 132 pp.

Bailey, L. H., Bailey, E. Z. 1976. Hortus third. Revised. MacMillan, New York, N.Y., USA. 1290 pp.

Scoggan, H. J. 1978, 1979. The flora of Canada. Nat. Mus. Nat. Sci. (Ottawa) Publ. Bot. 7(1)-7(4). 1711 pp.

Van Wijk, H. L. 1911. A dictionary of plant names. Martinus Nijhoff, The Hague, The Netherlands. 1444 pp.

Victorin, M. 1964. Flore Laurentienne. 2nd ed. Univ. Montreal, Montreal, Que., Canada. 952 pp.

Geographic Information

Alberta
British Columbia
Saskatchewan

References:

Bailey, L. H., Bailey, E. Z. 1976. Hortus third. Revised. MacMillan, New York, N.Y., USA. 1290 pp.

Boivin, B. 1966, 1967. Énumération des plantes du Canada. Provencheria 6. Nat. Can. (Que.) 93: 253-274; 371-437; 583-646; 989-1063. 94: 131-157; 471-528; 625-655.

Image or illustration

five-hooked bassia:

Images: images.google.com

Toxic parts:

flowers
leaves

References:

James, L. F., Williams, M. C., Bleak, A. T. 1976. Toxicity of *Bassia hyssopifolia* to sheep. J. Range Manage., 29: 284-285.

Toxic plant chemicals:

oxalate

References:

James, L. F., Williams, M. C., Bleak, A. T. 1976. Toxicity of

Bassia hyssopifolia to sheep. J. Range Manage., 29: 284-285.

Animals/Human Poisoning:

Note: When an animal is listed without additional information, the literature (as of 1993) contained no detailed explanation.

Sheep

General symptoms of poisoning:

[coma](#)

[death](#)

[gait, unsteady](#)

[incoordination](#)

[tetany](#)

[weakness](#)

Notes on poisoning:

In experimental feeding of sheep, five-hooked bassia caused symptoms similar to poisoning by *Kochia scoparia*. In addition to the symptoms listed, hemorrhaging on the rumen surface and enlarged kidneys occurred. Calcium concentrations in the serum of five sheep dropped from an average of 10.9 mg/mL to 3.6 mg/mL. Signs of photosensitization were also noted in some of the sheep (James et al. 1976).

References:

James, L. F., Williams, M. C., Bleak, A. T. 1976. Toxicity of *Bassia hyssopifolia* to sheep. J. Range Manage., 29: 284-285.

[Another search?](#)

[Français](#) | [Contact Us](#) | [Help](#) | [Search](#) | [Canada site](#)

[Coming Events](#) | [About CBIF](#) | [Links](#) | [Reports and Publications](#) | [Home](#)

Date modified: 2003-02-06

[Important Notices](#)



Français	Contact us	Help	Search	Canada site
Coming events	About CBIF	Links	Reports and publications	Home

Canadian Biodiversity Information Facility



Notes on poisoning: flamingo lily

[Introduction](#)[Interactive](#)[All poisonous plants by Botanical name](#)[All poisonous plants by Common name](#)[Important WWW Poisonous Plants sites](#)

General poisoning notes:

Flamingo lily (*Anthurium andraeanum*) is an indoor ornamental plant that produces striking flowers. Ingestion can cause painful irritation of the mouth and throat. Other species of the genus *Anthurium* may be cultivated in Canada, and all these plants should be regarded as containing calcium oxalate crystals, an irritant.



References:

- Fuller, T. C., McClintock, E. 1986. Poisonous plants of California. Univ. California Press, Berkeley, Calif., USA. 432 pp.
- Lampe, K. F., McCann, M. A. 1985. AMA Handbook of poisonous and injurious plants. American Medical Assoc. Chicago, Ill., USA. 432 pp.

Nomenclature:

Scientific Name: *Anthurium andraeanum* Lind.

Vernacular name(s): flamingo lily

Scientific family name: *Araceae*

Vernacular family name: arum

References:

- Agriculture Quebec. 1975. Noms des maladies des plantes du Canada/ Names of plant diseases in Canada. , Quebec City, Que., Canada. 288 pp.
- Alex, J. F., Cayouette, R., Mulligan, G. A. 1980. Common and botanical names of weeds in Canada/Noms populaire et scientifiques des plantes nuisibles du Canada. Revised. Agric.

Can. Publ., Ottawa, Ont., Canada. 132 pp.

Bailey, L. H., Bailey, E. Z. 1976. Hortus third. Revised. MacMillan, New York, N.Y., USA. 1290 pp.

Scoggan, H. J. 1978, 1979. The flora of Canada. Nat. Mus. Nat. Sci. (Ottawa) Publ. Bot. 7(1)-7(4). 1711 pp.

Van Wijk, H. L. 1911. A dictionary of plant names. Martinus Nijhoff, The Hague, The Netherlands. 1444 pp.

Victorin, M. 1964. Flore Laurentienne. 2nd ed. Univ. Montreal, Montreal, Que., Canada. 952 pp.

Geographic Information

Plant or plant parts used in or around the home.

References:

Bailey, L. H., Bailey, E. Z. 1976. Hortus third. Revised. MacMillan, New York, N.Y., USA. 1290 pp.

Boivin, B. 1966, 1967. Énumération des plantes du Canada. Provencheria 6. Nat. Can. (Que.) 93: 253-274; 371-437; 583-646; 989-1063. 94: 131-157; 471-528; 625-655.

Image or illustration

flamingo lily:

Images: images.google.com

Toxic parts:

leaves

stems

References:

Lampe, K. F., McCann, M. A. 1985. AMA Handbook of poisonous and injurious plants. American Medical Assoc. Chicago, Ill., USA. 432 pp.

Notes on Toxic plant chemicals:

Flamingo lily (*Anthurium andraeanum*) contains calcium oxalate raphide crystals, which cause painful swelling in the mouth and throat upon ingestion. These crystals readily penetrate mucous membranes, leading to irritation (Lampe and McCann 1985). Unidentified toxic proteins are also contained in the plants (Fuller

and McClintock 1986).

Toxic plant chemicals:

oxalate

References:

Fuller, T. C., McClintock, E. 1986. Poisonous plants of California. Univ. California Press, Berkeley, Calif., USA. 432 pp.

Lampe, K. F., McCann, M. A. 1985. AMA Handbook of poisonous and injurious plants. American Medical Assoc. Chicago, Ill., USA. 432 pp.

Animals/Human Poisoning:

Note: When an animal is listed without additional information, the literature (as of 1993) contained no detailed explanation.

Humans

General symptoms of poisoning:

[blistering](#)

[dysphagia](#)

[hoarseness](#)

References:

Lampe, K. F., McCann, M. A. 1985. AMA Handbook of poisonous and injurious plants. American Medical Assoc. Chicago, Ill., USA. 432 pp.

[Another search?](#)

[Français](#) | [Contact Us](#) | [Help](#) | [Search](#) | [Canada site](#)

[Coming Events](#) | [About CBIF](#) | [Links](#) | [Reports and Publications](#) |

[Home](#)

Date modified: 2003-02-06

[Important Notices](#)



Français	Contact us	Help	Search	Canada site
Coming events	About CBIF	Links	Reports and publications	Home

Canadian Biodiversity Information Facility



Notes on poisoning: fly honeysuckle

[Introduction](#)

[Interactive](#)

[All poisonous plants by Botanical name](#)

[All poisonous plants by Common name](#)

[Important WWW Poisonous Plants sites](#)



General poisoning notes:

Fly honeysuckle (*Lonicera xylosteum*) is cultivated in southwestern Quebec and southern Ontario. This ornamental shrub has been implicated in cases of poisoning of children in Europe. Recent literature indicates that cases of poisoning are rare, and the symptoms are considered mild. Experimental poisoning of rabbits has caused mild symptoms. Injecting fruit extracts at high doses has caused sickness and death in mice. Ingesting a large number of berries (ca. 30) may cause abdominal pain and vomiting in children (Frohne and Pfander 1983). Additional species of cultivated honeysuckle have also been implicated in cases of human poisoning. Woodbine (*Lonicera periclymenum*) may be poisonous. This climbing honeysuckle is occasionally planted. See the general notes under Tartarian honeysuckle, ([Lonicera tatarica](#)).

References:

Frohne, D., Pfander, H. J. 1983. A colour atlas of poisonous plants. Wolfe Publishing Ltd., London, England. 291 pp.

Lampe, K. F., McCann, M. A. 1985. AMA Handbook of poisonous and injurious plants. American Medical Assoc. Chicago, Ill., USA. 432 pp.

Nomenclature:

Scientific Name: *Lonicera xylosteum* L.

Vernacular name(s): fly honeysuckle

Scientific family name: *Caprifoliaceae*

Vernacular family name: honeysuckle

Go to ITIS^{*ca} for more taxonomic information on: [Lonicera](#)

[xylosteum](#)

References:

Agriculture Quebec. 1975. Noms des maladies des plantes du Canada/ Names of plant diseases in Canada. , Quebec City, Que., Canada. 288 pp.

Alex, J. F., Cayouette, R., Mulligan, G. A. 1980. Common and botanical names of weeds in Canada/Noms populaire et scientifiques des plantes nuisibles du Canada. Revised. Agric. Can. Publ., Ottawa, Ont., Canada. 132 pp.

Bailey, L. H., Bailey, E. Z. 1976. Hortus third. Revised. MacMillan, New York, N.Y., USA. 1290 pp.

Scoggan, H. J. 1978, 1979. The flora of Canada. Nat. Mus. Nat. Sci. (Ottawa) Publ. Bot. 7(1)-7(4). 1711 pp.

Van Wijk, H. L. 1911. A dictionary of plant names. Martinus Nijhoff, The Hague, The Netherlands. 1444 pp.

Victorin, M. 1964. Flore Laurentienne. 2nd ed. Univ. Montreal, Montreal, Que., Canada. 952 pp.

Geographic Information

Ontario

Quebec

References:

Bailey, L. H., Bailey, E. Z. 1976. Hortus third. Revised. MacMillan, New York, N.Y., USA. 1290 pp.

Boivin, B. 1966, 1967. Énumération des plantes du Canada. Provencheria 6. Nat. Can. (Que.) 93: 253-274; 371-437; 583-646; 989-1063. 94: 131-157; 471-528; 625-655.

Image or illustration

fly honeysuckle:

Images: images.google.com

Notes on Poisonous plant parts:

The berries have been implicated in cases of toxicity in Europe. In North America no cases of poisoning occurred after children ingested the berries (Lampe and McCann 1985).

Toxic parts:

mature fruit

References:

Frohne, D., Pfander, H. J. 1983. A colour atlas of poisonous plants. Wolfe Publishing Ltd., London, England. 291 pp.

Notes on Toxic plant chemicals:

The toxin is unknown, but saponins are thought to be responsible for the cases of poisoning. Traces of alkaloids were also found (Frohne and Pfander 1983).

Toxic plant chemicals:

unknown chemical

References:

Frohne, D., Pfander, H. J. 1983. A colour atlas of poisonous plants. Wolfe Publishing Ltd., London, England. 291 pp.

Animals/Human Poisoning:

Note: When an animal is listed without additional information, the literature (as of 1993) contained no detailed explanation.

Humans

General symptoms of poisoning:

[abdominal pains](#)

[diarrhea](#)

[vomiting](#)

Notes on poisoning:

Symptoms of ingestion include abdominal pain, diarrhea, and vomiting. More severe symptoms have been listed in early European literature, but severe toxicity has not been conclusively documented (Frohne and Pfander 1983).

References:

Frohne, D., Pfander, H. J. 1983. A colour atlas of poisonous plants. Wolfe Publishing Ltd., London, England. 291 pp.

Rabbits

General symptoms of poisoning:

[diarrhea](#)

Notes on poisoning:

Experimental feeding of berries (dry weight at 25 g/kg of body weight) to rabbits caused diarrhea and lack of movement within 24 h Frohne and Pfander 1983).

References:

Frohne, D., Pfander, H. J. 1983. A colour atlas of poisonous plants. Wolfe Publishing Ltd., London, England. 291 pp.

Rodents

General symptoms of poisoning:

[death](#)

[drowsiness](#)

Notes on poisoning:

Mice experimentally injected with berry extract (dry weight at 20-40 g/kg of body weight) experienced brief excitation, followed by drowsiness, abdominal spasms, and equilibrium and respiratory problems. Death sometimes followed in 10 min to several hours. A connection was made between saponin content and toxicity (Frohne and Pfander 1983).

References:

Frohne, D., Pfander, H. J. 1983. A colour atlas of poisonous plants. Wolfe Publishing Ltd., London, England. 291 pp.

[Another search?](#)

[Français](#) | [Contact Us](#) | [Help](#) | [Search](#) | [Canada site](#)

[Coming Events](#) | [About CBIF](#) | [Links](#) | [Reports and Publications](#) |

[Home](#)

Date modified: 2003-02-06

[Important Notices](#)



Français	Contact us	Help	Search	Canada site
Coming events	About CBIF	Links	Reports and publications	Home

Canadian Biodiversity Information Facility



Notes on poisoning: foxglove

[Introduction](#)[Interactive](#)[All poisonous plants by Botanical name](#)[All poisonous plants by Common name](#)[Important WWW Poisonous Plants sites](#)

General poisoning notes:

Foxglove (*Digitalis purpurea*) is an attractive biennial plant that is cultivated in Canada and is naturalized in several provinces. Upon ingestion, this plant can cause toxic reactions that lead to severe sickness and death in animals and in humans. Several important pharmaceutical drugs such as digitalis and digoxin are derived from this plant. The chemicals increase the force of contraction of the heart muscle and are therefore used in cases of heart congestion. Foxglove (*Digitalis purpurea*) is a naturalized herb found in eastern Canada and British Columbia. It is also a common outdoor ornamental. All classes of livestock are susceptible to poisoning by foxglove. However, because of the unpalatable nature of the plant, poisoning is infrequent, although when it does occur it is often severe and dramatic, frequently resulting in death. Human poisoning occurs rarely. However, poisoning was reported in the children who ate the flowers or drank water from vases. Accidentally including foxglove leaves in tea has led to poisoning and death. Cardiac glycosides are commonly described drugs that have a low margin of safety. Slight overdoses of prescribed medicine can cause symptoms of toxicity (Cooper and Johnson 1984, Cheeke and Schull 1985, Joubert 1989).

References:

- Cheeke, P. R., Shull, L. R. 1985. Natural toxicants in feeds and poisonous plants. AVI Publishing Company, Inc., Westport, Conn., USA. 492 pp.
- Cooper, M. R., Johnson, A. W. 1984. Poisonous plants in Britain and their effects on animals and man. Her Majesty's Stationery Office, London, England. 305 pp.
- Joubert, J. P. 1989. Cardiac glycosides. Pages 61-97 in Cheeke, P. R., ed. Toxicants of plant origin. Vol. II. Glycosides. CRC Press, Inc., Boca Raton, Fla., USA. 277 pp.
- Lampe, K. F., McCann, M. A. 1985. AMA Handbook of poisonous and

injurious plants. American Medical Assoc. Chicago, Ill., USA. 432 pp.

Parker, W. H. 1951. Foxglove (*Digitalis purpurea*) poisoning in turkeys. Vet. Rec., 63: 416.

Thomas, D. L., Quick, M. P., Morgan, R. P. 1987. Suspected foxglove (*Digitalis purpurea*) poisoning in a dairy cow. Vet. Rec., 120: 300-301.

Nomenclature:

Scientific Name: *Digitalis purpurea* L.

Vernacular name(s): foxglove

Scientific family name: *Scrophulariaceae*

Vernacular family name: frigwort

Go to ITIS*ca for more taxonomic information on: [Digitalis purpurea](#)

References:

Agriculture Quebec. 1975. Noms des maladies des plantes du Canada/ Names of plant diseases in Canada. , Quebec City, Que., Canada. 288 pp.

Alex, J. F., Cayouette, R., Mulligan, G. A. 1980. Common and botanical names of weeds in Canada/Noms populaire et scientifiques des plantes nuisibles du Canada. Revised. Agric. Can. Publ., Ottawa, Ont., Canada. 132 pp.

Bailey, L. H., Bailey, E. Z. 1976. Hortus third. Revised. MacMillan, New York, N.Y., USA. 1290 pp.

Scoggan, H. J. 1978, 1979. The flora of Canada. Nat. Mus. Nat. Sci. (Ottawa) Publ. Bot. 7(1)-7(4). 1711 pp.

Van Wijk, H. L. 1911. A dictionary of plant names. Martinus Nijhoff, The Hague, The Netherlands. 1444 pp.

Victorin, M. 1964. Flore Laurentienne. 2nd ed. Univ. Montreal, Montreal, Que., Canada. 952 pp.

Geographic Information

British Columbia

Newfoundland

Nova Scotia

Ontario

References:

Bailey, L. H., Bailey, E. Z. 1976. Hortus third. Revised. MacMillan, New York, N.Y., USA. 1290 pp.

Boivin, B. 1966, 1967. Énumération des plantes du Canada. Provencheria 6. Nat. Can. (Que.) 93: 253-274; 371-437; 583-646; 989-1063. 94: 131-157; 471-528; 625-655.

Image or illustration

foxglove:

Images: images.google.com

Notes on Poisonous plant parts:

The entire plant contains toxic compounds. The leaves and seeds are used to produce digoxin and other cardenolides for pharmaceutical use. The chemicals do not lose their toxicity by drying, storage, boiling or incorporation in hay. The plants are unpalatable and are seldom eaten by animals (Cooper and Johnson 1984, Joubert 1989).

Toxic parts:

all parts
flowers
leaves
seeds
stems

References:

Cooper, M. R., Johnson, A. W. 1984. Poisonous plants in Britain and their effects on animals and man. Her Majesty's Stationery Office, London, England. 305 pp.

Joubert, J. P. 1989. Cardiac glycosides. Pages 61-97 in Cheeke, P. R., ed. Toxicants of plant origin. Vol. II. Glycosides. CRC Press, Inc., Boca Raton, Fla., USA. 277 pp.

Notes on Toxic plant chemicals:

Digitoxin is one of several cardiac glycosides found in foxglove and is considered the most toxic of these chemicals. The toxins are split by hydrolysis into a sugar and an aglycone (nonsugar compound). The aglycones have a direct effect on the muscles to the heart (Joubert 1989).

Toxic plant chemicals:

digitoxin

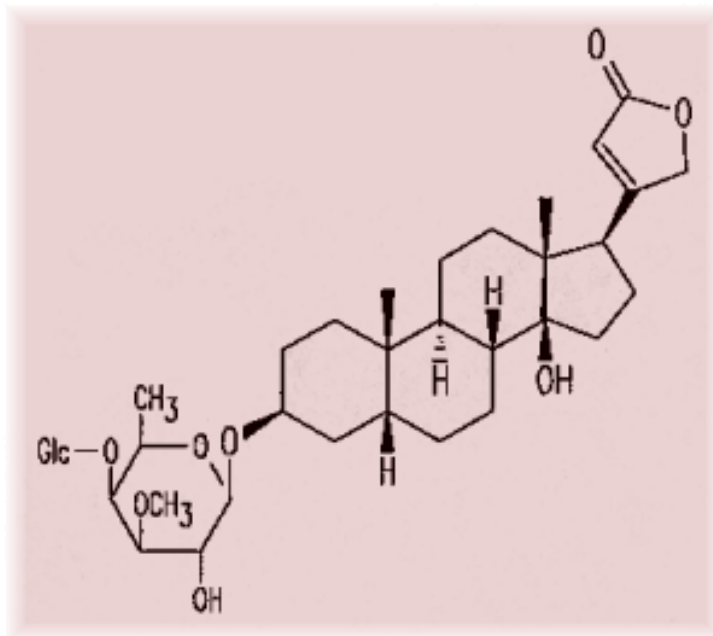

Chemical diagram(s) are courtesy of [Ruth McDiarmid](#), Biochemistry Technician, Kamloops Range Station, Agriculture and Agri-Food Canada, Kamloops, British Columbia, Canada.

References:

Joubert, J. P. 1989. Cardiac glycosides. Pages 61-97 in Cheeke, P. R., ed. Toxicants of plant origin. Vol. II. Glycosides. CRC Press, Inc., Boca Raton, Fla., USA. 277 pp.

Animals/Human Poisoning:

Note: When an animal is listed without additional information, the literature (as of 1993) contained no detailed explanation.

Cats

Cattle

General symptoms of poisoning:

[death](#)

[dyspnea](#)

[lungs, congestion of](#)

Notes on poisoning:

Dairy cattle have become poisoned after ingesting foxglove. Postmortem examination showed consolidation of the apical lobes of both lungs, with marked emphysema and bullae formation in the diaphragmatic lobes. Duodenal and jejunal mucosa were extremely congested and hemorrhagic. Some cattle recovered after treatment, whereas others took several days. One cow died 2 days after ingesting foxglove (Thomas et

al. 1987).

References:

Thomas, D. L., Quick, M. P., Morgan, R. P. 1987. Suspected foxglove (*Digitalis purpurea*) poisoning in a dairy cow. Vet. Rec., 120: 300-301.

Dogs

Goats

Horses

Humans

General symptoms of poisoning:

[abdominal pains](#)

[diarrhea](#)

[nausea](#)

Notes on poisoning:

Digitalis poisoning toxicity has a variable latent period depending on the quantity ingested. Gross disturbances in heartbeat and pulse are common. Most cases of human poisoning result from slight overdoses of prescribed drugs that contain digoxin or other related chemicals. Smith et al. (1982) describe the symptoms of digoxin and digitoxin toxicity, including nausea and severe vomiting. Many people develop hyperkalemia. Advanced cardiac rhythm disturbances are common, along with tachycardia and ventricular fibrillation. Treating patients with purified Fab fragments of digoxin-specific antibodies produces an initial favorable response and should lead to safe, effective reversal of life-threatening digitalis intoxication. Accidental ingestion of foxglove has occurred when the leaves were used in tea or when flowers were ingested (Cooper and Johnson 1984).

References:

Lampe, K. F., McCann, M. A. 1985. AMA Handbook of poisonous and injurious plants. American Medical Assoc. Chicago, Ill., USA. 432 pp.

Poultry

Sheep

Swine

General symptoms of poisoning:

[abdominal pains](#)

[convulsions](#)

[death](#)

[diarrhea](#)

Notes on poisoning:

General symptoms of foxglove poisoning for all types of animals include diarrhea, abdominal pain, irregular pulse, tremors, and convulsions. In severe cases, death occurs. Postmortem examination of pigs showed gastrointestinal inflammation, punctiform necrosis of the border of the spleen, and fatty degeneration of some nerve fibers in the heart. The presence of digitoxin in the body tissues confirms foxglove poisoning in animals (Cooper and Johnson 1984, Joubert 1989).

References:

Cooper, M. R., Johnson, A. W. 1984. Poisonous plants in Britain and their effects on animals and man. Her Majesty's Stationery Office, London, England. 305 pp.

Turkeys

General symptoms of poisoning:

[appetite, loss of](#)

[convulsions](#)

[death](#)

[drowsiness](#)

[pupil dilation](#)

Notes on poisoning:

Several turkeys died after ingesting foxglove leaves. Several turkeys slowly recovered. The crops were surgically removed from affected birds, a procedure which speeded up recovery time (Parker 1951).

References:

Parker, W. H. 1951. Foxglove (*Digitalis purpurea*) poisoning in turkeys. Vet. Rec., 63: 416.

[Another search?](#)

[Français](#) | [Contact Us](#) | [Help](#) | [Search](#) | [Canada site](#)

[Coming Events](#) | [About CBIF](#) | [Links](#) | [Reports and Publications](#) | [Home](#)

Date modified: 2003-02-06

[Important Notices](#)



Français	Contact us	Help	Search	Canada site
Coming events	About CBIF	Links	Reports and publications	Home

Canadian Biodiversity Information Facility



Notes on poisoning: garden-sorrel

[Introduction](#)

[Interactive](#)

[All poisonous plants by Botanical name](#)

[All poisonous plants by Common name](#)

[Important WWW Poisonous Plants sites](#)



General poisoning notes:

Garden-sorrel (*Rumex acetosa*) is a naturalized herb found across southern Canada. It is occasionally cultivated as a garden green.

Ingesting large quantities of the plant caused toxicity in sheep and cattle in other countries. Humans should restrict their intake of the leaves of this plant because they contain oxalate crystals (Cooper and Johnson 1984).

References:

Cooper, M. R., Johnson, A. W. 1984. Poisonous plants in Britain and their effects on animals and man. Her Majesty's Stationery Office, London, England. 305 pp.

Kingsbury, J. M. 1964. Poisonous plants of the United States and Canada. Prentice-Hall Inc., Englewood Cliffs, N.J., USA. 626 pp.

Nomenclature:

Scientific Name: *Rumex acetosa* L.

Vernacular name(s): garden-sorrel

Scientific family name: *Polygonaceae*

Vernacular family name: buckwheat

Go to ITIS^{*ca} for more taxonomic information on: [Rumex acetosa](#)

References:

Agriculture Quebec. 1975. Noms des maladies des plantes du Canada/ Names of plant diseases in Canada. , Quebec City, Que., Canada. 288 pp.

Alex, J. F., Cayouette, R., Mulligan, G. A. 1980. Common and botanical names of weeds in Canada/Noms populaire et scientifiques des plantes nuisibles du Canada. Revised. Agric. Can. Publ., Ottawa, Ont., Canada. 132 pp.

Bailey, L. H., Bailey, E. Z. 1976. Hortus third. Revised. MacMillan, New York, N.Y., USA. 1290 pp.

Scoggan, H. J. 1978, 1979. The flora of Canada. Nat. Mus. Nat. Sci. (Ottawa) Publ. Bot. 7(1)-7(4). 1711 pp.

Van Wijk, H. L. 1911. A dictionary of plant names. Martinus Nijhoff, The Hague, The Netherlands. 1444 pp.

Victorin, M. 1964. Flore Laurentienne. 2nd ed. Univ. Montreal, Montreal, Que., Canada. 952 pp.

Geographic Information

Alberta
British Columbia
Labrador
Manitoba
New Brunswick
Newfoundland
Nova Scotia
Ontario
Quebec
Saskatchewan

References:

Bailey, L. H., Bailey, E. Z. 1976. Hortus third. Revised. MacMillan, New York, N.Y., USA. 1290 pp.

Boivin, B. 1966, 1967. Énumération des plantes du Canada. Provencheria 6. Nat. Can. (Que.) 93: 253-274; 371-437; 583-646; 989-1063. 94: 131-157; 471-528; 625-655.

Image or illustration

garden-sorrel:

Images: images.google.com

Notes on Poisonous plant parts:

Ingesting large amounts of the aboveground portion of garden-sorrel can cause poisoning (Cooper and Johnson 1984).

Toxic parts:

leaves
stems

References:

Cooper, M. R., Johnson, A. W. 1984. Poisonous plants in Britain and their effects on animals and man. Her Majesty's Stationery Office, London, England. 305 pp.

Notes on Toxic plant chemicals:

Oxalates are considered the primary toxin. However, under certain circumstances, nitrates may accumulate to toxic levels. In recorded cases of poisoning, the symptoms were consistent with those of oxalate poisoning (Cooper and Johnson 1984).

Toxic plant chemicals:

oxalate

References:

Cooper, M. R., Johnson, A. W. 1984. Poisonous plants in Britain and their effects on animals and man. Her Majesty's Stationery Office, London, England. 305 pp.

Animals/Human Poisoning:

Note: When an animal is listed without additional information, the literature (as of 1993) contained no detailed explanation.

Cattle

General symptoms of poisoning:

[kidney failure](#)

Notes on poisoning:

Reports of poisoning in cattle are inconsistent. Lactating cows that ingested large quantities of garden-sorrel showed symptoms similar to those of milk fever. Treatment with calcium had transient effects because of subsequent kidney failure (Cooper and Johnson 1984).

References:

Cooper, M. R., Johnson, A. W. 1984. Poisonous plants in Britain and their effects on animals and man. Her Majesty's Stationery Office, London, England. 305 pp.

Sheep

General symptoms of poisoning:

[coma](#)

[death](#)

[incoordination](#)

[mouth, frothing of](#)

[pupil dilation](#)

[recumbency](#)

Notes on poisoning:

Ingesting large amounts of garden-sorrel caused toxicity in sheep in Britain. Symptoms included incoordination, falling, then inability to rise, dilation of the pupils, coma, and death (in five sheep). In lactating ewes, the initial signs resembled milk fever, but favorable response to calcium injection was transient because of kidney failure. No cases of poisoning from this plant have been reported in North America (Kingsbury 1964, Cooper and Johnson 1984).

References:

Cooper, M. R., Johnson, A. W. 1984. Poisonous plants in Britain and their effects on animals and man. Her Majesty's Stationery Office, London, England. 305 pp.

Kingsbury, J. M. 1964. Poisonous plants of the United States and Canada. Prentice-Hall Inc., Englewood Cliffs, N.J., USA. 626 pp.

[Another search?](#)

[Français](#) | [Contact Us](#) | [Help](#) | [Search](#) | [Canada site](#)

[Coming Events](#) | [About CBIF](#) | [Links](#) | [Reports and Publications](#) |

[Home](#)

Date modified: 2003-02-06

[Important Notices](#)



Français	Contact us	Help	Search	Canada site
Coming events	About CBIF	Links	Reports and publications	Home

Canadian Biodiversity Information Facility



Notes on poisoning: garland daphne

[Introduction](#)

[Interactive](#)

[All poisonous plants by Botanical name](#)

[All poisonous plants by Common name](#)

[Important WWW Poisonous Plants sites](#)



General poisoning notes:

Garland daphne (*Daphne cneorum*) is an ornamental shrub found in the warmest parts of Canada. This shrub contains the same toxins as the other *Daphne* spp. listed in this information system. It is capable of causing poisoning in humans and any animals that might ingest it, such as family pets. See additional information under general notes for [Daphne mezereum](#).

References:

Lampe, K. F., McCann, M. A. 1985. AMA Handbook of poisonous and injurious plants. American Medical Assoc. Chicago, Ill., USA. 432 pp.

Nomenclature:

Scientific Name: *Daphne cneorum* L.

Vernacular name(s): garland daphne

Scientific family name: *Thymelaeaceae*

Vernacular family name: mezereum

References:

Agriculture Quebec. 1975. Noms des maladies des plantes du Canada/ Names of plant diseases in Canada. , Quebec City, Que., Canada. 288 pp.

Alex, J. F., Cayouette, R., Mulligan, G. A. 1980. Common and botanical names of weeds in Canada/Noms populaire et scientifiques des plantes nuisibles du Canada. Revised. Agric. Can. Publ., Ottawa, Ont., Canada. 132 pp.

Bailey, L. H., Bailey, E. Z. 1976. Hortus third. Revised.

MacMillan, New York, N.Y., USA. 1290 pp.

Scoggan, H. J. 1978, 1979. The flora of Canada. Nat. Mus. Nat. Sci. (Ottawa) Publ. Bot. 7(1)-7(4). 1711 pp.

Van Wijk, H. L. 1911. A dictionary of plant names. Martinus Nijhoff, The Hague, The Netherlands. 1444 pp.

Victorin, M. 1964. Flore Laurentienne. 2nd ed. Univ. Montreal, Montreal, Que., Canada. 952 pp.

Geographic Information

Plant or plant parts used in or around the home.

References:

Bailey, L. H., Bailey, E. Z. 1976. Hortus third. Revised. MacMillan, New York, N.Y., USA. 1290 pp.

Boivin, B. 1966, 1967. Énumération des plantes du Canada. Provencheria 6. Nat. Can. (Que.) 93: 253-274; 371-437; 583-646; 989-1063. 94: 131-157; 471-528; 625-655.

Image or illustration

garland daphne:

Images: images.google.com

Toxic parts:

all parts
flowers
leaves
mature fruit
seeds

References:

Lampe, K. F., McCann, M. A. 1985. AMA Handbook of poisonous and injurious plants. American Medical Assoc. Chicago, Ill., USA. 432 pp.

Toxic plant chemicals:

daphnetoxin
dihydroxycoumarin
mezerein

References:

Fuller, T. C., McClintock, E. 1986. Poisonous plants of California. Univ. California Press, Berkeley, Calif., USA. 432 pp.

Lampe, K. F., McCann, M. A. 1985. AMA Handbook of poisonous and injurious plants. American Medical Assoc. Chicago, Ill., USA. 432 pp.

Animals/Human Poisoning:

Note: When an animal is listed without additional information, the literature (as of 1993) contained no detailed explanation.

Cats

Dogs

Humans

General symptoms of poisoning:

[abdominal pains](#)

[diarrhea](#)

[kidney, congestion of](#)

[mouth, irritation of](#)

[salivation](#)

[thirsty](#)

References:

Lampe, K. F., McCann, M. A. 1985. AMA Handbook of poisonous and injurious plants. American Medical Assoc. Chicago, Ill., USA. 432 pp.

[Another search?](#)

[Français](#) | [Contact Us](#) | [Help](#) | [Search](#) | [Canada site](#)

[Coming Events](#) | [About CBIF](#) | [Links](#) | [Reports and Publications](#) |

[Home](#)

Date modified: 2003-02-06

[Important Notices](#)



Français	Contact us	Help	Search	Canada site
Coming events	About CBIF	Links	Reports and publications	Home

Canadian Biodiversity Information Facility



Notes on poisoning: garlic

[Introduction](#)

[Interactive](#)

[All poisonous plants by Botanical name](#)

[All poisonous plants by Common name](#)

[Important WWW Poisonous Plants sites](#)

General poisoning notes:

Human allergy to garlic dust has been documented by Lybarger et al. 1982. Ingesting garlic leaves can also cause allergic reactions.

References:



Lybarger, J. A., Gallagher, J. S., Pulver, D. W., Litwin, A., Brooks, S., Bernstein, I. L. 1982. Occupational asthma induced by inhalation and ingestion of garlic. *J. All. Clin. Immunol.*, 69: 448-454.

Nomenclature:

Scientific Name: *Allium sativum* L.

Vernacular name(s): garlic

Scientific family name: *Liliaceae*

Vernacular family name: lily

Go to ITIS*^{ca} for more taxonomic information on: [Allium sativum](#)

References:

Agriculture Quebec. 1975. Noms des maladies des plantes du Canada/ Names of plant diseases in Canada. , Quebec City, Que., Canada. 288 pp.

Alex, J. F., Cayouette, R., Mulligan, G. A. 1980. Common and botanical names of weeds in Canada/Noms populaire et scientifiques des plantes nuisibles du Canada. Revised. Agric. Can. Publ., Ottawa, Ont., Canada. 132 pp.

Bailey, L. H., Bailey, E. Z. 1976. Hortus third. Revised.

MacMillan, New York, N.Y., USA. 1290 pp.

Scoggan, H. J. 1978, 1979. The flora of Canada. Nat. Mus. Nat. Sci. (Ottawa) Publ. Bot. 7(1)-7(4). 1711 pp.

Van Wijk, H. L. 1911. A dictionary of plant names. Martinus Nijhoff, The Hague, The Netherlands. 1444 pp.

Victorin, M. 1964. Flore Laurentienne. 2nd ed. Univ. Montreal, Montreal, Que., Canada. 952 pp.

Geographic Information

Plant or plant parts used in or around the home.

References:

Bailey, L. H., Bailey, E. Z. 1976. Hortus third. Revised. MacMillan, New York, N.Y., USA. 1290 pp.

Boivin, B. 1966, 1967. Énumération des plantes du Canada. Provencheria 6. Nat. Can. (Que.) 93: 253-274; 371-437; 583-646; 989-1063. 94: 131-157; 471-528; 625-655.

Image or illustration

garlic:

Images: images.google.com

Toxic parts:

bulb - dust of
bulbs

References:

Lybarger, J. A., Gallagher, J. S., Pulver, D. W., Litwin, A., Brooks, S., Bernstein, I. L. 1982. Occupational asthma induced by inhalation and ingestion of garlic. J. All. Clin. Immunol., 69: 448-454.

Toxic plant chemicals:

S-methyl-L-cysteine sulfoxide (SMCO)

References:

Benevenga, N. J., Case, G. L., Steele, R. D. 1989. Occurrence and metabolism of s-methyl-l-cysteine and s-methyl-l-cysteine

sulfoxide in plants and their toxicity and metabolism in animals. Pages 203-228 in Cheeke, P. R., ed. Toxicants of plant origin. Vol. III. Proteins and amino acids. CRC Press, Inc., Boca Raton, Fla., USA. 271 pp.

Animals/Human Poisoning:

Note: When an animal is listed without additional information, the literature (as of 1993) contained no detailed explanation.

Humans

General symptoms of poisoning:

[dyspnea](#)

[wheezing](#)

References:

Lybarger, J. A., Gallagher, J. S., Pulver, D. W., Litwin, A., Brooks, S., Bernstein, I. L. 1982. Occupational asthma induced by inhalation and ingestion of garlic. J. All. Clin. Immunol., 69: 448-454.

[Another search?](#)

[Français](#) | [Contact Us](#) | [Help](#) | [Search](#) | [Canada site](#)

[Coming Events](#) | [About CBIF](#) | [Links](#) | [Reports and Publications](#) | [Home](#)

Date modified: 2003-02-06

[Important Notices](#)



Français	Contact us	Help	Search	Canada site
Coming events	About CBIF	Links	Reports and publications	Home

Canadian Biodiversity Information Facility



Notes on poisoning: gas plant

[Introduction](#)[Interactive](#)[All poisonous plants by Botanical name](#)[All poisonous plants by Common name](#)[Important WWW Poisonous Plants sites](#)

General poisoning notes:

Gas plant (*Dictamnus albus*) has caused phytophotodermatitis in humans. In one case in Ottawa, a gardener suffered recurring skin eruptions for several summers. The original diagnosis was poison-ivy, but subsequent testing proved that the gas plant was causing the skin reactions. The plant juices are absorbed by the skin and, in the presence of long-wave ultraviolet light, cell damage occurs. Once this cause is recognized, careful avoidance of contact with the gas plant prevents further problems (Henderson and DesGroseilliers 1984). This is an uncommon and colorful plant found in Canadian herbaceous borders.

References:

Henderson, J. A., DesGroseilliers, J.-P. 1984. Gas plant (*Dictamnus albus*) phytophotodermatitis simulating poison ivy. *Can. Med. Assoc. J.*, 130: 889-891.

Nomenclature:

Scientific Name: *Dictamnus albus* L.

Vernacular name(s): gas plant

Scientific family name: *Rutaceae*

Vernacular family name: rue

Go to ITIS*^{ca} for more taxonomic information on: [Dictamnus albus](#)

References:

Agriculture Quebec. 1975. Noms des maladies des plantes du Canada/ Names of plant diseases in Canada. , Quebec City, Que.,

Canada. 288 pp.

Alex, J. F., Cayouette, R., Mulligan, G. A. 1980. Common and botanical names of weeds in Canada/Noms populaire et scientifiques des plantes nuisibles du Canada. Revised. Agric. Can. Publ., Ottawa, Ont., Canada. 132 pp.

Bailey, L. H., Bailey, E. Z. 1976. Hortus third. Revised. MacMillan, New York, N.Y., USA. 1290 pp.

Scoggan, H. J. 1978, 1979. The flora of Canada. Nat. Mus. Nat. Sci. (Ottawa) Publ. Bot. 7(1)-7(4). 1711 pp.

Van Wijk, H. L. 1911. A dictionary of plant names. Martinus Nijhoff, The Hague, The Netherlands. 1444 pp.

Victorin, M. 1964. Flore Laurentienne. 2nd ed. Univ. Montreal, Montreal, Que., Canada. 952 pp.

Geographic Information

Plant or plant parts used in or around the home.

References:

Bailey, L. H., Bailey, E. Z. 1976. Hortus third. Revised. MacMillan, New York, N.Y., USA. 1290 pp.

Boivin, B. 1966, 1967. Énumération des plantes du Canada. Provencheria 6. Nat. Can. (Que.) 93: 253-274; 371-437; 583-646; 989-1063. 94: 131-157; 471-528; 625-655.

Image or illustration

gas plant:

Images: images.google.com

Notes on Poisonous plant parts:

Exposure to the plant juices is required, which occurs when weeding around the plant or cutting the flowers (Henderson and DesGroseilliers 1984).

Toxic parts:

plant juices

References:

Cheeke, P. R., Shull, L. R. 1985. Natural toxicants in feeds and

poisonous plants. AVI Publishing Company, Inc., Westport, Conn., USA. 492 pp.

Henderson, J. A., DesGroseilliers, J.-P. 1984. Gas plant (*Dictamnus albus*) phytophotodermatitis simulating poison ivy. Can. Med. Assoc. J., 130: 889-891.

Notes on Toxic plant chemicals:

Furocoumarins, which are derived from psoralen, are found in several of the plants that cause phytophotodermatitis. These compounds are primary photodynamic agents that absorb long-wave ultraviolet light at the surface of the skin and then cause cell damage (Henderson and DesGroseilliers 1984, Cheeke and Schull 1985).

Toxic plant chemicals:

furocoumarin

References:

Cheeke, P. R., Shull, L. R. 1985. Natural toxicants in feeds and poisonous plants. AVI Publishing Company, Inc., Westport, Conn., USA. 492 pp.

Henderson, J. A., DesGroseilliers, J.-P. 1984. Gas plant (*Dictamnus albus*) phytophotodermatitis simulating poison ivy. Can. Med. Assoc. J., 130: 889-891.

Animals/Human Poisoning:

Note: When an animal is listed without additional information, the literature (as of 1993) contained no detailed explanation.

Humans

General symptoms of poisoning:

[blistering](#)

[erythema](#)

References:

Henderson, J. A., DesGroseilliers, J.-P. 1984. Gas plant (*Dictamnus albus*) phytophotodermatitis simulating poison ivy. Can. Med. Assoc. J., 130: 889-891.

[Another search?](#)

[Français](#) | [Contact Us](#) | [Help](#) | [Search](#) | [Canada site](#)
[Coming Events](#) | [About CBIF](#) | [Links](#) | [Reports and Publications](#) |
[Home](#)

Date modified: 2003-02-06

[Important Notices](#)



Français	Contact us	Help	Search	Canada site
Coming events	About CBIF	Links	Reports and publications	Home

Canadian Biodiversity Information Facility



Notes on poisoning: giant dumbcane

[Introduction](#)[Interactive](#)[All poisonous plants by Botanical name](#)[All poisonous plants by Common name](#)[Important WWW Poisonous Plants sites](#)

General poisoning notes:

Giant dumbcane (*Dieffenbachia amoena*) is an indoor ornamental plant. Experimental work on rodents proved the toxicity of leaf and stem tissue from giant dumbcane. Death occurred after administration of 3.0 g of plant extract in 10.0 mL of liquid per 100 g of body weight (Der Marderosian et al. 1976).



References:

Der Marderosian, A. H., Giller, F. B., Roia, F. C. 1976. Phytochemical and toxicological screening of household ornamental plants potentially toxic to humans. 1. J. Toxicol. Environ. Health, 1: 939-953.

Nomenclature:

Scientific Name: *Dieffenbachia amoena* Gentil

Vernacular name(s): giant dumbcane

Scientific family name: *Araceae*

Vernacular family name: arum

References:

Agriculture Quebec. 1975. Noms des maladies des plantes du Canada/ Names of plant diseases in Canada. , Quebec City, Que., Canada. 288 pp.

Alex, J. F., Cayouette, R., Mulligan, G. A. 1980. Common and botanical names of weeds in Canada/Noms populaire et scientifiques des plantes nuisibles du Canada. Revised. Agric. Can. Publ., Ottawa, Ont., Canada. 132 pp.

Bailey, L. H., Bailey, E. Z. 1976. Hortus third. Revised.

MacMillan, New York, N.Y., USA. 1290 pp.

Scoggan, H. J. 1978, 1979. The flora of Canada. Nat. Mus. Nat. Sci. (Ottawa) Publ. Bot. 7(1)-7(4). 1711 pp.

Van Wijk, H. L. 1911. A dictionary of plant names. Martinus Nijhoff, The Hague, The Netherlands. 1444 pp.

Victorin, M. 1964. Flore Laurentienne. 2nd ed. Univ. Montreal, Montreal, Que., Canada. 952 pp.

Geographic Information

Plant or plant parts used in or around the home.

References:

Bailey, L. H., Bailey, E. Z. 1976. Hortus third. Revised. MacMillan, New York, N.Y., USA. 1290 pp.

Boivin, B. 1966, 1967. Énumération des plantes du Canada. Provencheria 6. Nat. Can. (Que.) 93: 253-274; 371-437; 583-646; 989-1063. 94: 131-157; 471-528; 625-655.

Image or illustration

giant dumbcane:

Images: images.google.com

Toxic parts:

leaves

stems

References:

Der Marderosian, A. H., Giller, F. B., Roia, F. C. 1976. Phytochemical and toxicological screening of household ornamental plants potentially toxic to humans. 1. J. Toxicol. Environ. Health, 1: 939-953.

Toxic plant chemicals:

oxalate

References:

Der Marderosian, A. H., Giller, F. B., Roia, F. C. 1976. Phytochemical and toxicological screening of household

ornamental plants potentially toxic to humans. 1. J. Toxicol. Environ. Health, 1: 939-953.

Animals/Human Poisoning:

Note: When an animal is listed without additional information, the literature (as of 1993) contained no detailed explanation.

Rodents

[Another search?](#)

[Français](#) | [Contact Us](#) | [Help](#) | [Search](#) | [Canada site](#)

[Coming Events](#) | [About CBIF](#) | [Links](#) | [Reports and Publications](#) | [Home](#)

Date modified: 2003-02-06

[Important Notices](#)



Français	Contact us	Help	Search	Canada site
Coming events	About CBIF	Links	Reports and publications	Home

Canadian Biodiversity Information Facility



Notes on poisoning: giant hogweed

[Introduction](#)

[Interactive](#)

[All poisonous plants by Botanical name](#)

[All poisonous plants by Common name](#)

[Important WWW Poisonous Plants sites](#)

General poisoning notes:

Giant hogweed (*Heracleum mantegazzianum*) is naturalized in south central Ontario. It has caused photosensitization in children after exposure to the plant followed by sunlight (Morton 1975). This plant has also been introduced into New York State, where children have also contracted dermatitis from it (Gunby 1980).



References:

Anon. 1970. The giant hogweed. *Lancet*, 2: 32.

Drever, J. C., Hunter, J. A. 1970. Hazards of giant hogweed. *Br. Med. J.*, 3: 109.

Gunby, P. 1980. Keep away from that 'tree', folks! *J. Am. Med. Assoc.*, 244: 2596.

Morton, J. K. 1975. The giant cow parsnip, *Heracleum mantegazzianum* Umbelliferae, in Canada. *Can. Field-Nat.*, 89: 183-184.

Nomenclature:

Scientific Name: *Heracleum mantegazzianum* Somm. & Levier

Vernacular name(s): giant hogweed

Scientific family name: *Umbelliferae*

Vernacular family name: parsley

Go to ITIS*^{ca} for more taxonomic information on: [Heracleum mantegazzianum](#)

References:

Agriculture Quebec. 1975. Noms des maladies des plantes du Canada/ Names of plant diseases in Canada. , Quebec City, Que., Canada. 288 pp.

Alex, J. F., Cayouette, R., Mulligan, G. A. 1980. Common and botanical names of weeds in Canada/Noms populaire et scientifiques des plantes nuisibles du Canada. Revised. Agric. Can. Publ., Ottawa, Ont., Canada. 132 pp.

Bailey, L. H., Bailey, E. Z. 1976. Hortus third. Revised. MacMillan, New York, N.Y., USA. 1290 pp.

Scoggan, H. J. 1978, 1979. The flora of Canada. Nat. Mus. Nat. Sci. (Ottawa) Publ. Bot. 7(1)-7(4). 1711 pp.

Van Wijk, H. L. 1911. A dictionary of plant names. Martinus Nijhoff, The Hague, The Netherlands. 1444 pp.

Victorin, M. 1964. Flore Laurentienne. 2nd ed. Univ. Montreal, Montreal, Que., Canada. 952 pp.

Geographic Information

Ontario

References:

Bailey, L. H., Bailey, E. Z. 1976. Hortus third. Revised. MacMillan, New York, N.Y., USA. 1290 pp.

Boivin, B. 1966, 1967. Énumération des plantes du Canada. Provencheria 6. Nat. Can. (Que.) 93: 253-274; 371-437; 583-646; 989-1063. 94: 131-157; 471-528; 625-655.

Image or illustration

giant hogweed:

Images: images.google.com

Toxic parts:

all parts
plant juices
stems

References:

Anon. 1970. The giant hogweed. Lancet, 2: 32.

Drever, J. C., Hunter, J. A. 1970. Hazards of giant hogweed. Br. Med. J., 3: 109.

Gunby, P. 1980. Keep away from that 'tree', folks! J. Am. Med. Assoc., 244: 2596.

Morton, J. K. 1975. The giant cow parsnip, *Heracleum mantegazzianum* Umbelliferae, in Canada. Can. Field-Nat., 89: 183-184.

Notes on Toxic plant chemicals:

Giant hogweed contains furocoumarins (psoralens), which make human skin hypersensitive to sunlight, causing cellular damage at the surface. They absorb long-wave ultraviolet light and become photodynamic (Cooper and Johnson 1984).

Toxic plant chemicals:

furocoumarin

References:

Cooper, M. R., Johnson, A. W. 1984. Poisonous plants in Britain and their effects on animals and man. Her Majesty's Stationery Office, London, England. 305 pp.

Drever, J. C., Hunter, J. A. 1970. Hazards of giant hogweed. Br. Med. J., 3: 109.

Animals/Human Poisoning:

Note: When an animal is listed without additional information, the literature (as of 1993) contained no detailed explanation.

Humans

General symptoms of poisoning:

[blistering](#)

[erythema](#)

[skin, brown pigment of](#)

Notes on poisoning:

Symptoms of phytophotosensitization include serious and extensive weeping blisters. The lesions often occur in a line where the person has brushed aside the stems. The bullae can be massive and irritating, and brown pigmentation may remain for years after healing (Morton 1975, Gunby 1980).

References:

Anon. 1970. The giant hogweed. *Lancet*, 2: 32.

Drever, J. C., Hunter, J. A. 1970. Hazards of giant hogweed. *Br. Med. J.*, 3: 109.

Gunby, P. 1980. Keep away from that 'tree', folks! *J. Am. Med. Assoc.*, 244: 2596.

Morton, J. K. 1975. The giant cow parsnip, *Heracleum mantegazzianum* Umbelliferae, in Canada. *Can. Field-Nat.*, 89: 183-184.

[Another search?](#)

[Français](#) | [Contact Us](#) | [Help](#) | [Search](#) | [Canada site](#)

[Coming Events](#) | [About CBIF](#) | [Links](#) | [Reports and Publications](#) |

[Home](#)

Date modified: 2003-02-06

[Important Notices](#)



Français	Contact us	Help	Search	Canada site
Coming events	About CBIF	Links	Reports and publications	Home

Canadian Biodiversity Information Facility



Notes on poisoning: glory lily

[Introduction](#)

[Interactive](#)

[All poisonous plants by Botanical name](#)

[All poisonous plants by Common name](#)

[Important WWW Poisonous Plants sites](#)



General poisoning notes:

Glory lily (*Gloriosa superba*) is a rarely grown indoor ornamental vine best suited to greenhouses. Ingesting the tubers causes severe poisoning in humans. The plant contains two alkaloids, including colchicine, which cause severe gastroenteritis, vomiting, and possible unconsciousness. Severe hair loss is a consistent symptom of colchicine poisoning. Complete recovery is slow (Gooneratne 1966, Angunawela and Fernando 1971, Lampe and McCann 1985).

References:

Angunawela, R. M., Fernando, H. A. 1971. Acute ascending polyneuropathy and dermatitis following poisoning by tubers of *Gloriosa superba*. Ceylon Med. J., 16: 233-235.

Gooneratne, B. W. 1966. Massive generalized alopecia after poisoning by *Gloriosa superba*. Br. Med. J., 1: 1023-1024.

Lampe, K. F., McCann, M. A. 1985. AMA Handbook of poisonous and injurious plants. American Medical Assoc. Chicago, Ill., USA. 432 pp.

Nomenclature:

Scientific Name: *Gloriosa superba* L.

Vernacular name(s): glory lily

Scientific family name: *Liliaceae*

Vernacular family name: lily

Go to ITIS^{*ca} for more taxonomic information on: [Gloriosa superba](#)

References:

Agriculture Quebec. 1975. Noms des maladies des plantes du Canada/ Names of plant diseases in Canada. , Quebec City, Que., Canada. 288 pp.

Alex, J. F., Cayouette, R., Mulligan, G. A. 1980. Common and botanical names of weeds in Canada/Noms populaire et scientifiques des plantes nuisibles du Canada. Revised. Agric. Can. Publ., Ottawa, Ont., Canada. 132 pp.

Bailey, L. H., Bailey, E. Z. 1976. Hortus third. Revised. MacMillan, New York, N.Y., USA. 1290 pp.

Scoggan, H. J. 1978, 1979. The flora of Canada. Nat. Mus. Nat. Sci. (Ottawa) Publ. Bot. 7(1)-7(4). 1711 pp.

Van Wijk, H. L. 1911. A dictionary of plant names. Martinus Nijhoff, The Hague, The Netherlands. 1444 pp.

Victorin, M. 1964. Flore Laurentienne. 2nd ed. Univ. Montreal, Montreal, Que., Canada. 952 pp.

Geographic Information

Plant or plant parts used in or around the home.

References:

Bailey, L. H., Bailey, E. Z. 1976. Hortus third. Revised. MacMillan, New York, N.Y., USA. 1290 pp.

Boivin, B. 1966, 1967. Énumération des plantes du Canada. Provencheria 6. Nat. Can. (Que.) 93: 253-274; 371-437; 583-646; 989-1063. 94: 131-157; 471-528; 625-655.

Image or illustration

glory lily:

Images: images.google.com

Toxic parts:

tubers

References:

Angunawela, R. M., Fernando, H. A. 1971. Acute ascending polyneuropathy and dermatitis following poisoning by tubers of *Gloriosa superba*. Ceylon Med. J., 16: 233-235.

Gooneratne, B. W. 1966. Massive generalized alopecia after poisoning by *Gloriosa superba*. Br. Med. J., 1: 1023-1024.

Notes on Toxic plant chemicals:

Two alkaloids, colchicine and gloriosine, are found in the tubers of glory lily. In one case, a young women ingested 125 g of tubers containing 0.3% colchicine. She ingested the equivalent of 350 mg of colchicine and within 2 h she was vomiting, becoming unconscious by the next day (Gooneratne 1966).

Toxic plant chemicals:

colchicine
gloriosine

References:

Angunawela, R. M., Fernando, H. A. 1971. Acute ascending polyneuropathy and dermatitis following poisoning by tubers of *Gloriosa superba*. Ceylon Med. J., 16: 233-235.

Gooneratne, B. W. 1966. Massive generalized alopecia after poisoning by *Gloriosa superba*. Br. Med. J., 1: 1023-1024.

Animals/Human Poisoning:

Note: When an animal is listed without additional information, the literature (as of 1993) contained no detailed explanation.

Humans

General symptoms of poisoning:

[alopecia](#)
[dehydration](#)
[diarrhea](#)
[hemoglobinuria](#)
[unconsciousness](#)
[vomiting](#)
[weakness](#)

Notes on poisoning:

Ingesting the tubers causes severe vomiting, abdominal pain, severe and bloody diarrhea, vaginal bleeding, weakness, and retention of urine and waste. Swelling of the lower or upper limbs may occur. Partial to complete hair loss occurs, sometimes on all parts of the body. Recover is slow, because colchicine is slowly

secreted from the system. Treatment includes fluid retention, monitoring of renal function and blood pressure, and treatment for diarrhea (Gooneratne 1966, Angunawela and Fernando 1971, Lampe and McCann 1985).

References:

Angunawela, R. M., Fernando, H. A. 1971. Acute ascending polyneuropathy and dermatitis following poisoning by tubers of *Gloriosa superba*. Ceylon Med. J., 16: 233-235.

Gooneratne, B. W. 1966. Massive generalized alopecia after poisoning by *Gloriosa superba*. Br. Med. J., 1: 1023-1024.

Lampe, K. F., McCann, M. A. 1985. AMA Handbook of poisonous and injurious plants. American Medical Assoc. Chicago, Ill., USA. 432 pp.

[Another search?](#)

[Français](#) | [Contact Us](#) | [Help](#) | [Search](#) | [Canada site](#)

[Coming Events](#) | [About CBIF](#) | [Links](#) | [Reports and Publications](#) | [Home](#)

Date modified: 2003-02-06

[Important Notices](#)



Français	Contact us	Help	Search	Canada site
Coming events	About CBIF	Links	Reports and publications	Home

Canadian Biodiversity Information Facility



Notes on poisoning: golden-bean

[Introduction](#)

[Interactive](#)

[All poisonous plants by Botanical name](#)

[All poisonous plants by Common name](#)

[Important WWW Poisonous Plants sites](#)



General poisoning notes:

Golden-bean (*Thermopsis rhombifolia*) is a native plant that is found in the southern part of western Canada. This plant has been suspected since the late 1800s to be poisonous to cattle and horses, but conclusive evidence is lacking in the literature. The related plant, poison-bean (*Thermopsis montana*), causes poisoning in cattle. Poison-bean contains several quinolizidine alkaloids, and similar chemicals may be found in golden-bean. Ingesting seeds of golden-bean was suspected in a case of poisoning of a child in western Canada. Until more definitive studies appear in the literature, the plant is included in this Information System because of its potential for poisoning (Kingsbury 1964, Keeler et al. 1986).

References:

Keeler, R. F., Johnson, A. E., Chase, R. L. 1986. Toxicity of *Thermopsis montana* in cattle. *Cornell Vet.*, 76: 115-127.

Kingsbury, J. M. 1964. *Poisonous plants of the United States and Canada*. Prentice-Hall Inc., Englewood Cliffs, N.J., USA. 626 pp.

Nomenclature:

Scientific Name: *Thermopsis rhombifolia* (Nutt.) Richards.

Vernacular name(s): golden-bean

Scientific family name: *Leguminosae*

Vernacular family name: pea

Go to ITIS^{*ca} for more taxonomic information on: [Thermopsis rhombifolia](#)

References:

Agriculture Quebec. 1975. Noms des maladies des plantes du Canada/ Names of plant diseases in Canada. , Quebec City, Que., Canada. 288 pp.

Alex, J. F., Cayouette, R., Mulligan, G. A. 1980. Common and botanical names of weeds in Canada/Noms populaire et scientifiques des plantes nuisibles du Canada. Revised. Agric. Can. Publ., Ottawa, Ont., Canada. 132 pp.

Bailey, L. H., Bailey, E. Z. 1976. Hortus third. Revised. MacMillan, New York, N.Y., USA. 1290 pp.

Scoggan, H. J. 1978, 1979. The flora of Canada. Nat. Mus. Nat. Sci. (Ottawa) Publ. Bot. 7(1)-7(4). 1711 pp.

Van Wijk, H. L. 1911. A dictionary of plant names. Martinus Nijhoff, The Hague, The Netherlands. 1444 pp.

Victorin, M. 1964. Flore Laurentienne. 2nd ed. Univ. Montreal, Montreal, Que., Canada. 952 pp.

Geographic Information

Alberta
British Columbia
Manitoba
Saskatchewan

References:

Bailey, L. H., Bailey, E. Z. 1976. Hortus third. Revised. MacMillan, New York, N.Y., USA. 1290 pp.

Boivin, B. 1966, 1967. Énumération des plantes du Canada. Provencheria 6. Nat. Can. (Que.) 93: 253-274; 371-437; 583-646; 989-1063. 94: 131-157; 471-528; 625-655.

Image or illustration

golden-bean:

Images: images.google.com

Toxic parts:

leaves
seeds

References:

Keeler, R. F., Johnson, A. E., Chase, R. L. 1986. Toxicity of *Thermopsis montana* in cattle. Cornell Vet., 76: 115-127.

Notes on Toxic plant chemicals:

The chemicals listed here are found in the closely related poison-bean (*Thermopsis montana*), although similar chemicals are found in golden-bean (Keeler et al. 1986). Some of these chemicals are found in other members of the pea family, including anagyrine, which causes teratogenic effects in cattle that eat lupines containing this chemical.

Toxic plant chemicals:

anagyrine
cytisine
N-methylcytisine
thermopsine

References:

Keeler, R. F., Johnson, A. E., Chase, R. L. 1986. Toxicity of *Thermopsis montana* in cattle. Cornell Vet., 76: 115-127.

Animals/Human Poisoning:

Note: When an animal is listed without additional information, the literature (as of 1993) contained no detailed explanation.

Cattle

General symptoms of poisoning:

[appetite, loss of](#)
[death](#)
[depression](#)

References:

Keeler, R. F., Johnson, A. E., Chase, R. L. 1986. Toxicity of *Thermopsis montana* in cattle. Cornell Vet., 76: 115-127.

Horses

Humans

[Another search?](#)

[Français](#) | [Contact Us](#) | [Help](#) | [Search](#) | [Canada site](#)

[Coming Events](#) | [About CBIF](#) | [Links](#) | [Reports and Publications](#) |

[Home](#)

Date modified: 2003-02-06

[Important Notices](#)



Français	Contact us	Help	Search	Canada site
Coming events	About CBIF	Links	Reports and publications	Home

Canadian Biodiversity Information Facility



Notes on poisoning: golden-chain

[Introduction](#)

[Interactive](#)

[All poisonous plants by Botanical name](#)

[All poisonous plants by Common name](#)

[Important WWW Poisonous Plants sites](#)



General poisoning notes:

Golden-chain (*Laburnum anagyroides*) is an outdoor ornamental that survives only in southwestern Ontario and coastal British Columbia. This plant contains cytisine, an alkaloid, which has caused poisoning and death in cattle, dogs, horses, swine, and humans after twigs, fruit pods, and seeds were ingested. Most of the cases of poisoning are found in European literature. Children and family pets should be prevented from ingesting the pods or seeds (Cooper and Johnson 1984, Lampe and McCann 1985, Fuller and McClintock 1986).

References:

- Cooper, M. R., Johnson, A. W. 1984. Poisonous plants in Britain and their effects on animals and man. Her Majesty's Stationery Office, London, England. 305 pp.
- Fuller, T. C., McClintock, E. 1986. Poisonous plants of California. Univ. California Press, Berkeley, Calif., USA. 432 pp.
- Lampe, K. F., McCann, M. A. 1985. AMA Handbook of poisonous and injurious plants. American Medical Assoc. Chicago, Ill., USA. 432 pp.

Nomenclature:

Scientific Name: *Laburnum anagyroides* Medic.

Vernacular name(s): golden-chain

Scientific family name: *Leguminosae*

Vernacular family name: pea

Go to ITIS*^{ca} for more taxonomic information on: [Laburnum anagyroides](#)

References:

Agriculture Quebec. 1975. Noms des maladies des plantes du Canada/ Names of plant diseases in Canada. , Quebec City, Que., Canada. 288 pp.

Alex, J. F., Cayouette, R., Mulligan, G. A. 1980. Common and botanical names of weeds in Canada/Noms populaire et scientifiques des plantes nuisibles du Canada. Revised. Agric. Can. Publ., Ottawa, Ont., Canada. 132 pp.

Bailey, L. H., Bailey, E. Z. 1976. Hortus third. Revised. MacMillan, New York, N.Y., USA. 1290 pp.

Scoggan, H. J. 1978, 1979. The flora of Canada. Nat. Mus. Nat. Sci. (Ottawa) Publ. Bot. 7(1)-7(4). 1711 pp.

Van Wijk, H. L. 1911. A dictionary of plant names. Martinus Nijhoff, The Hague, The Netherlands. 1444 pp.

Victorin, M. 1964. Flore Laurentienne. 2nd ed. Univ. Montreal, Montreal, Que., Canada. 952 pp.

Geographic Information

Plant or plant parts used in or around the home.

References:

Bailey, L. H., Bailey, E. Z. 1976. Hortus third. Revised. MacMillan, New York, N.Y., USA. 1290 pp.

Boivin, B. 1966, 1967. Énumération des plantes du Canada. Provencheria 6. Nat. Can. (Que.) 93: 253-274; 371-437; 583-646; 989-1063. 94: 131-157; 471-528; 625-655.

Image or illustration

golden-chain:

Images: images.google.com

Notes on Poisonous plant parts:

All parts of the plant contain the alkaloid cytisine, but the bark and seeds have the highest amount of the chemical. The leaves become less toxic as the fruit pods develop, which become more toxic (Cooper and Johnson 1984).

Toxic parts:

all parts
bark
leaves
seeds

References:

Cooper, M. R., Johnson, A. W. 1984. Poisonous plants in Britain and their effects on animals and man. Her Majesty's Stationery Office, London, England. 305 pp.

Toxic plant chemicals:

cytisine

References:

Cooper, M. R., Johnson, A. W. 1984. Poisonous plants in Britain and their effects on animals and man. Her Majesty's Stationery Office, London, England. 305 pp.

Animals/Human Poisoning:

Note: When an animal is listed without additional information, the literature (as of 1993) contained no detailed explanation.

Cattle

General symptoms of poisoning:

[death](#)

[gait, unsteady](#)

[muscle spasms](#)

[recumbency](#)

Notes on poisoning:

Ingesting twigs and pods of golden-chain have produced toxic symptoms including stiff, unsteady gait, violent tremors, recumbency, and death. Milk yield has been reduced, and large yellow clots were found in the milk (Cooper and Johnson 1984).

References:

Cooper, M. R., Johnson, A. W. 1984. Poisonous plants in Britain and their effects on animals and man. Her Majesty's Stationery Office, London, England. 305 pp.

Dogs

General symptoms of poisoning:

[convulsions](#)

[death](#)

Notes on poisoning:

Dogs that were poisoned experienced convulsions and died after chewing golden-chain sticks (Cooper and Johnson 1984).

References:

Cooper, M. R., Johnson, A. W. 1984. Poisonous plants in Britain and their effects on animals and man. Her Majesty's Stationery Office, London, England. 305 pp.

Horses

General symptoms of poisoning:

[abdominal pains](#)

[coma](#)

[death](#)

[incoordination](#)

[muscle spasms](#)

References:

Cooper, M. R., Johnson, A. W. 1984. Poisonous plants in Britain and their effects on animals and man. Her Majesty's Stationery Office, London, England. 305 pp.

Humans

General symptoms of poisoning:

[abdominal pains](#)

[confusion](#)

[death](#)

[dizziness](#)

[drowsiness](#)

[headache](#)

[mouth, irritation of](#)

[nausea](#)

[temperature, elevated](#)

[vomiting](#)

Notes on poisoning:

Most cases of human poisoning occur when children eat the pods or seeds by mistake. Symptoms develop rapidly within half an hour because cytisine is rapidly absorbed through mucous membranes of the mouth, stomach, and intestine. Nausea, vomiting, pupil dilation, weakness, breathing difficulty, dizziness, and muscular incoordination can result. Ingesting large quantities can be fatal. In one case, a man ingested 23 pods of golden-chain and died. Toxicological analysis showed that 35-50 mg of cytisine had been absorbed (Cooper and Johnson 1984, Fuller and McClintock 1986).

References:

Cooper, M. R., Johnson, A. W. 1984. Poisonous plants in Britain and their effects on animals and man. Her Majesty's Stationery Office, London, England. 305 pp.

Fuller, T. C., McClintock, E. 1986. Poisonous plants of California. Univ. California Press, Berkeley, Calif., USA. 432 pp.

Swine

General symptoms of poisoning:

[diarrhea](#)

References:

Cooper, M. R., Johnson, A. W. 1984. Poisonous plants in Britain and their effects on animals and man. Her Majesty's Stationery Office, London, England. 305 pp.

[Another search?](#)

[Français](#) | [Contact Us](#) | [Help](#) | [Search](#) | [Canada site](#)

[Coming Events](#) | [About CBIF](#) | [Links](#) | [Reports and Publications](#) |

[Home](#)

Date modified: 2003-02-06

[Important Notices](#)



Français	Contact us	Help	Search	Canada site
Coming events	About CBIF	Links	Reports and publications	Home

Canadian Biodiversity Information Facility



Notes on poisoning: golden-trumpet

[Introduction](#)[Interactive](#)[All poisonous plants by Botanical name](#)[All poisonous plants by Common name](#)[Important WWW Poisonous Plants sites](#)

General poisoning notes:

Golden-trumpet (*Allamanda cathartica*) is an indoor ornamental vine that is suited to greenhouses. It is considered poisonous, but firm evidence is lacking. The plant was once used as a cathartic. Ingesting the fruits may cause upset stomach (Kingsbury 1964; Hardin and Arena 1969).

There is a case of a young boy who was sucking the end of the stem of this plant. He subsequently became nauseated, and developed a high temperature and swollen lips. Some individuals develop a rash from the plant sap (Morton 1962).

References:

- Hardin, J. W., Arena, J. M. 1969. Human poisoning from native and cultivated plants. Duke University Press, Durham, N.C., USA. 167 pp.
- Kingsbury, J. M. 1964. Poisonous plants of the United States and Canada. Prentice-Hall Inc., Englewood Cliffs, N.J., USA. 626 pp.
- Morton, J. F. 1962. Ornamental plants with toxic and or irritant properties. II. Proc. Fla. State Hortic. Soc., 75: 484-491.

Nomenclature:

Scientific Name: *Allamanda cathartica* L.

Vernacular name(s): golden-trumpet

Scientific family name: *Apocynaceae*

Vernacular family name: dogbane

Go to ITIS^{*ca} for more taxonomic information on: [Allamanda cathartica](#)

References:

Agriculture Quebec. 1975. Noms des maladies des plantes du Canada/ Names of plant diseases in Canada. , Quebec City, Que., Canada. 288 pp.

Alex, J. F., Cayouette, R., Mulligan, G. A. 1980. Common and botanical names of weeds in Canada/Noms populaire et scientifiques des plantes nuisibles du Canada. Revised. Agric. Can. Publ., Ottawa, Ont., Canada. 132 pp.

Bailey, L. H., Bailey, E. Z. 1976. Hortus third. Revised. MacMillan, New York, N.Y., USA. 1290 pp.

Scoggan, H. J. 1978, 1979. The flora of Canada. Nat. Mus. Nat. Sci. (Ottawa) Publ. Bot. 7(1)-7(4). 1711 pp.

Van Wijk, H. L. 1911. A dictionary of plant names. Martinus Nijhoff, The Hague, The Netherlands. 1444 pp.

Victorin, M. 1964. Flore Laurentienne. 2nd ed. Univ. Montreal, Montreal, Que., Canada. 952 pp.

Geographic Information

Plant or plant parts used in or around the home.

References:

Bailey, L. H., Bailey, E. Z. 1976. Hortus third. Revised. MacMillan, New York, N.Y., USA. 1290 pp.

Boivin, B. 1966, 1967. Énumération des plantes du Canada. Provencheria 6. Nat. Can. (Que.) 93: 253-274; 371-437; 583-646; 989-1063. 94: 131-157; 471-528; 625-655.

Image or illustration

golden-trumpet:

Images: images.google.com

Notes on Poisonous plant parts:

This plant has an unidentified toxin in the fruits and in the cell sap of the stem and leaves (Hardin and Arena 1969). The plant is used only as an indoor ornamental in Canada, most likely found in greenhouses because it is a large climbing vine.

Toxic parts:

mature fruit
plant juices

References:

Hardin, J. W., Arena, J. M. 1969. Human poisoning from native and cultivated plants. Duke University Press, Durham, N.C., USA. 167 pp.

Kingsbury, J. M. 1964. Poisonous plants of the United States and Canada. Prentice-Hall Inc., Englewood Cliffs, N.J., USA. 626 pp.

Animals/Human Poisoning:

Note: When an animal is listed without additional information, the literature (as of 1993) contained no detailed explanation.

Humans

General symptoms of poisoning:

[nausea](#)
[stomach cramps](#)
[temperature, elevated](#)
[thirsty](#)

References:

Hardin, J. W., Arena, J. M. 1969. Human poisoning from native and cultivated plants. Duke University Press, Durham, N.C., USA. 167 pp.

Morton, J. F. 1962. Ornamental plants with toxic and or irritant properties. II. Proc. Fla. State Hort. Soc., 75: 484-491.

[Another search?](#)

[Français](#) | [Contact Us](#) | [Help](#) | [Search](#) | [Canada site](#)
[Coming Events](#) | [About CBIF](#) | [Links](#) | [Reports and Publications](#) | [Home](#)

Date modified: 2003-02-06

[Important Notices](#)



Français	Contact us	Help	Search	Canada site
Coming events	About CBIF	Links	Reports and publications	Home

Canadian Biodiversity Information Facility



Notes on poisoning: grass pea

[Introduction](#)

[Interactive](#)

[All poisonous plants by Botanical name](#)

[All poisonous plants by Common name](#)

[Important WWW Poisonous Plants sites](#)



General poisoning notes:

Grass pea (*Lathyrus sativa*) has been used as a food and forage crop in Europe and Asia, where ingesting the seeds for 3-6 months can cause neurolathyrism, a syndrome characterized by muscular rigidity, weakness, and paralysis of the leg muscles. In severe cases, victims may be reduced to crawling. Young men between 20 and 30 years old are primarily affected. Livestock may also develop paralysis if they ingest grass pea for a long time. Neurolathyrism still occurs in India, where grass pea is used as flour (Cooper and Johnson 1984, Roy and Spencer 1989). Poisoning from grass pea is unlikely in Canada. However, some other *Lathyrus* species that occur in Canada may also contain BOAA.

References:

Cooper, M. R., Johnson, A. W. 1984. Poisonous plants in Britain and their effects on animals and man. Her Majesty's Stationery Office, London, England. 305 pp.

Liener, I. E. 1989. Antinutritional factors. Pages 339-382 in Matthews, R. H., ed. Legumes: chemistry, technology, and human nutrition. Marcel Dekker, Inc., New York, N.Y., USA. 934 pp.

Roy, D. N., Spencer, P. S. 1989. Lathyrogens. Pages 169-201 in Cheeke, P. R., ed. Toxicants of plant origin. Vol. III. Proteins and amino acids. CRC Press, Inc., Boca Raton, Fla., USA. 271 pp.

Selye, H. 1957. Lathyrism. Rev. Can. Biol., 16: 1-82.

Nomenclature:

Scientific Name: *Lathyrus sativus* L.

Vernacular name(s): grass pea

Scientific family name: *Leguminosae*

Vernacular family name: pea

Go to ITIS^{*ca} for more taxonomic information on: [Lathyrus sativus](#)

References:

Agriculture Quebec. 1975. Noms des maladies des plantes du Canada/ Names of plant diseases in Canada. , Quebec City, Que., Canada. 288 pp.

Alex, J. F., Cayouette, R., Mulligan, G. A. 1980. Common and botanical names of weeds in Canada/Noms populaire et scientifiques des plantes nuisibles du Canada. Revised. Agric. Can. Publ., Ottawa, Ont., Canada. 132 pp.

Bailey, L. H., Bailey, E. Z. 1976. Hortus third. Revised. MacMillan, New York, N.Y., USA. 1290 pp.

Scoggan, H. J. 1978, 1979. The flora of Canada. Nat. Mus. Nat. Sci. (Ottawa) Publ. Bot. 7(1)-7(4). 1711 pp.

Van Wijk, H. L. 1911. A dictionary of plant names. Martinus Nijhoff, The Hague, The Netherlands. 1444 pp.

Victorin, M. 1964. Flore Laurentienne. 2nd ed. Univ. Montreal, Montreal, Que., Canada. 952 pp.

Geographic Information

Plant or plant parts used in or around the home.

References:

Bailey, L. H., Bailey, E. Z. 1976. Hortus third. Revised. MacMillan, New York, N.Y., USA. 1290 pp.

Boivin, B. 1966, 1967. Énumération des plantes du Canada. Provencheria 6. Nat. Can. (Que.) 93: 253-274; 371-437; 583-646; 989-1063. 94: 131-157; 471-528; 625-655.

Image or illustration

grass pea:

Images: images.google.com

Toxic parts:

mature fruit

seeds

References:

Roy, D. N., Spencer, P. S. 1989. Lathyrogens. Pages 169-201 in Cheeke, P. R., ed. Toxicants of plant origin. Vol. III. Proteins and amino acids. CRC Press, Inc., Boca Raton, Fla., USA. 271 pp.

Notes on Toxic plant chemicals:

BOAA (beta-N-oxalylamino-L-alanine) is generally regarded as the cause of neurolathyrism, although the exact nomenclature is still under study. The concentration of BOAA in the seed varies from 0.1 to 2.5%. This variation may help explain the conflicting reports of toxicity (Roy and Spencer 1989).

Toxic plant chemicals:

beta-N-oxalylamino-L-alanine

References:

Roy, D. N., Spencer, P. S. 1989. Lathyrogens. Pages 169-201 in Cheeke, P. R., ed. Toxicants of plant origin. Vol. III. Proteins and amino acids. CRC Press, Inc., Boca Raton, Fla., USA. 271 pp.

Animals/Human Poisoning:

Note: When an animal is listed without additional information, the literature (as of 1993) contained no detailed explanation.

Humans

General symptoms of poisoning:

[paralysis](#)

References:

Selye, H. 1957. Lathyrism. Rev. Can. Biol., 16: 1-82.

[Another search?](#)

[Français](#) | [Contact Us](#) | [Help](#) | [Search](#) | [Canada site](#)

[Coming Events](#) | [About CBIF](#) | [Links](#) | [Reports and Publications](#) | [Home](#)

Date modified: 2003-02-06

[Important Notices](#)



Français	Contact us	Help	Search	Canada site
Coming events	About CBIF	Links	Reports and publications	Home

Canadian Biodiversity Information Facility



Notes on poisoning: greasewood

[Introduction](#)

[Interactive](#)

[All poisonous plants by Botanical name](#)

[All poisonous plants by Common name](#)

[Important WWW Poisonous Plants sites](#)



General poisoning notes:

Greasewood (*Sarcobatus vermiculatus*) is a native shrub found in western Canada from southwestern Saskatchewan to southeastern British Columbia. In the western United States, sheep that ingested this plant became ill and died. Oxalates are present in all parts of the plant but are concentrated in the leaves. This plant is regarded as valuable forage. Toxicity can be avoided with good animal management (Kingsbury 1964, Cheeke and Schull 1985).

References:

Cheeke, P. R., Shull, L. R. 1985. Natural toxicants in feeds and poisonous plants. AVI Publishing Company, Inc., Westport, Conn., USA. 492 pp.

Kingsbury, J. M. 1964. Poisonous plants of the United States and Canada. Prentice-Hall Inc., Englewood Cliffs, N.J., USA. 626 pp.

Scimeca, J. M., Oehme, F. W. 1985. Postmortem guide to common poisonous plants of livestock. Vet. Hum. Toxicol., 27: 189-199.

Nomenclature:

Scientific Name: *Sarcobatus vermiculatus* (Hook.) Torr.

Vernacular name(s): greasewood

Scientific family name: *Chenopodiaceae*

Vernacular family name: goosefoot

Go to ITIS*^{ca} for more taxonomic information on: [Sarcobatus vermiculatus](#)

References:

Agriculture Quebec. 1975. Noms des maladies des plantes du Canada/ Names of plant diseases in Canada. , Quebec City, Que., Canada. 288 pp.

Alex, J. F., Cayouette, R., Mulligan, G. A. 1980. Common and botanical names of weeds in Canada/Noms populaire et scientifiques des plantes nuisibles du Canada. Revised. Agric. Can. Publ., Ottawa, Ont., Canada. 132 pp.

Bailey, L. H., Bailey, E. Z. 1976. Hortus third. Revised. MacMillan, New York, N.Y., USA. 1290 pp.

Scoggan, H. J. 1978, 1979. The flora of Canada. Nat. Mus. Nat. Sci. (Ottawa) Publ. Bot. 7(1)-7(4). 1711 pp.

Van Wijk, H. L. 1911. A dictionary of plant names. Martinus Nijhoff, The Hague, The Netherlands. 1444 pp.

Victorin, M. 1964. Flore Laurentienne. 2nd ed. Univ. Montreal, Montreal, Que., Canada. 952 pp.

Geographic Information

Alberta
British Columbia
Saskatchewan

References:

Bailey, L. H., Bailey, E. Z. 1976. Hortus third. Revised. MacMillan, New York, N.Y., USA. 1290 pp.

Boivin, B. 1966, 1967. Énumération des plantes du Canada. Provencheria 6. Nat. Can. (Que.) 93: 253-274; 371-437; 583-646; 989-1063. 94: 131-157; 471-528; 625-655.

Image or illustration

greasewood:

Images: images.google.com

Toxic parts:

leaves

References:

Kingsbury, J. M. 1964. Poisonous plants of the United States and Canada. Prentice-Hall Inc., Englewood Cliffs, N.J., USA. 626 pp.

Notes on Toxic plant chemicals:

Oxalates are found in greasewood. On a dry-weight basis the total content was measured at between 10 and 22%, mostly as soluble salts. The oxalate content is greatest in the leaves, the amount increasing with maturity. Ingesting plant material equal to 1.5-5.0% of an animal's body weight can cause toxicity in sheep (Kingsbury 1964).

Toxic plant chemicals:

oxalate

References:

Kingsbury, J. M. 1964. Poisonous plants of the United States and Canada. Prentice-Hall Inc., Englewood Cliffs, N.J., USA. 626 pp.

Animals/Human Poisoning:

Note: When an animal is listed without additional information, the literature (as of 1993) contained no detailed explanation.

Sheep

General symptoms of poisoning:

[coma](#)

[death](#)

[depression](#)

[prostration](#)

[weakness](#)

Notes on poisoning:

In the western United States, 1000 sheep were lost at a single time. Symptoms occur within 3-5 h of ingesting a toxic quantity of greasewood plant. Symptoms may occur abruptly after animals have been watered. Toxic signs include depression, weakness, prostration, coma, and death. Respiration and heart action grow progressively weaker, and death occurs in 12-20 h. Hypocalcemia is caused by the formation of calcium oxalate in the system. Microscopic lesions occur in the kidney tubules (Kingsbury 1964, Scimeca and Oehme 1985).

References:

Kingsbury, J. M. 1964. Poisonous plants of the United States and

Canada. Prentice-Hall Inc., Englewood Cliffs, N.J., USA. 626 pp.

[Another search?](#)

[Français](#) | [Contact Us](#) | [Help](#) | [Search](#) | [Canada site](#)

[Coming Events](#) | [About CBIF](#) | [Links](#) | [Reports and Publications](#) |

[Home](#)

Date modified: 2003-02-06

[Important Notices](#)



Français	Contact us	Help	Search	Canada site
Coming events	About CBIF	Links	Reports and publications	Home

Canadian Biodiversity Information Facility



Notes on poisoning: greater celandine

[Introduction](#)

[Interactive](#)

[All poisonous plants by Botanical name](#)

[All poisonous plants by Common name](#)

[Important WWW Poisonous Plants sites](#)



General poisoning notes:

Greater celandine (*Chelidonium majus*) is a perennial naturalized herb found in parts of eastern Canada. This plant is suspected in the death of a four-year old boy (Koopman 1937). There are records of skin irritation and soreness after the latex is applied to the skin, a practice that was followed in Europe to help minor skin injuries (Cooper and Johnson 1984). Cattle were poisoned and died in Britain after ingesting the ripe fruit of this plant (Reeks 1903); 500 g of the plant can cause toxic effects in horses or cattle (Frohne and Pfander 1983).

References:

Cooper, M. R., Johnson, A. W. 1984. Poisonous plants in Britain and their effects on animals and man. Her Majesty's Stationery Office, London, England. 305 pp.

Frohne, D., Pfander, H. J. 1983. A colour atlas of poisonous plants. Wolfe Publishing Ltd., London, England. 291 pp.

Koopman, H. 1937. A fatal case of celandine poisoning. Sammlung von Vergiftungsfallen, 8: 93-98.

Reeks, H. C. 1903. Poisoning of cattle by common celandine. J. Comp. Pathol. Ther., 16: 367-371.

Nomenclature:

Scientific Name: *Chelidonium majus* L.

Vernacular name(s): greater celandine

Scientific family name: *Papaveraceae*

Vernacular family name: poppy

Go to ITIS*^{ca} for more taxonomic information on: [Chelidonium](#)

[*majus*](#)

References:

Agriculture Quebec. 1975. Noms des maladies des plantes du Canada/ Names of plant diseases in Canada. , Quebec City, Que., Canada. 288 pp.

Alex, J. F., Cayouette, R., Mulligan, G. A. 1980. Common and botanical names of weeds in Canada/Noms populaire et scientifiques des plantes nuisibles du Canada. Revised. Agric. Can. Publ., Ottawa, Ont., Canada. 132 pp.

Bailey, L. H., Bailey, E. Z. 1976. Hortus third. Revised. MacMillan, New York, N.Y., USA. 1290 pp.

Scoggan, H. J. 1978, 1979. The flora of Canada. Nat. Mus. Nat. Sci. (Ottawa) Publ. Bot. 7(1)-7(4). 1711 pp.

Van Wijk, H. L. 1911. A dictionary of plant names. Martinus Nijhoff, The Hague, The Netherlands. 1444 pp.

Victorin, M. 1964. Flore Laurentienne. 2nd ed. Univ. Montreal, Montreal, Que., Canada. 952 pp.

Geographic Information

New Brunswick

Ontario

Prince Edward Island

Quebec

References:

Bailey, L. H., Bailey, E. Z. 1976. Hortus third. Revised. MacMillan, New York, N.Y., USA. 1290 pp.

Boivin, B. 1966, 1967. Énumération des plantes du Canada. Provencheria 6. Nat. Can. (Que.) 93: 253-274; 371-437; 583-646; 989-1063. 94: 131-157; 471-528; 625-655.

Image or illustration

greater celandine:

Images: images.google.com

Notes on Poisonous plant parts:

The entire plant is considered poisonous. The plant contains bright yellow latex that turns reddish after exposure to air. The

plant is considered unpalatable because of its acrid taste and pungent, fetid smell (Frohne and Pfander 1983, Cooper and Johnson 1984).

Toxic parts:

latex

References:

Cooper, M. R., Johnson, A. W. 1984. Poisonous plants in Britain and their effects on animals and man. Her Majesty's Stationery Office, London, England. 305 pp.

Frohne, D., Pfander, H. J. 1983. A colour atlas of poisonous plants. Wolfe Publishing Ltd., London, England. 291 pp.

Notes on Toxic plant chemicals:

Chelidonine is the major alkaloid found in greater celandine. At least 20 other alkaloids have been found in the plant. The concentration of these alkaloids varies in various plant organs, depending on the stage of growth (Frohne and Pfander 1983).

Toxic plant chemicals:

chelidonine

References:

Cooper, M. R., Johnson, A. W. 1984. Poisonous plants in Britain and their effects on animals and man. Her Majesty's Stationery Office, London, England. 305 pp.

Frohne, D., Pfander, H. J. 1983. A colour atlas of poisonous plants. Wolfe Publishing Ltd., London, England. 291 pp.

Animals/Human Poisoning:

Note: When an animal is listed without additional information, the literature (as of 1993) contained no detailed explanation.

Cattle

General symptoms of poisoning:

[convulsions](#)

[death](#)

[drowsiness](#)

[gait, staggering](#)
[salivation](#)

Notes on poisoning:

One case of cattle poisoning is attributed to this plant. The cattle became drowsy, had a staggering gait, salivated, and some cows died. Calves that suckled the poisoned cows were unaffected. Postmortem examination revealed gastrointestinal irritation (Reeks 1903).

References:

Reeks, H. C. 1903. Poisoning of cattle by common celandine. J. Comp. Pathol. Ther., 16: 367-371.

Humans

General symptoms of poisoning:

[coma](#)
[death](#)
[diarrhea](#)
[drowsiness](#)
[headache](#)

Notes on poisoning:

The case of a 4-year-old boy who sickened and died is cited in the literature. Postmortem examination showed severe irritation of the large intestine. The cause of death was suspected to be greater celandine (Koopman 1937).

References:

Koopman, H. 1937. A fatal case of celandine poisoning. Sammlung von Vergiftungsfallen, 8: 93-98.

[Another search?](#)

[Français](#) | [Contact Us](#) | [Help](#) | [Search](#) | [Canada site](#)
[Coming Events](#) | [About CBIF](#) | [Links](#) | [Reports and Publications](#) | [Home](#)

Date modified: 2003-02-06

[Important Notices](#)



Français	Contact us	Help	Search	Canada site
Coming events	About CBIF	Links	Reports and publications	Home

Canadian Biodiversity Information Facility



Notes on poisoning: green tansy mustard

[Introduction](#)

[Interactive](#)

[All poisonous plants by Botanical name](#)

[All poisonous plants by Common name](#)

[Important WWW Poisonous Plants sites](#)

General poisoning notes:

Green tansy mustard (*Descurainia pinnata*) is a native herb found in fields and rangelands across central and western Canada.

Poisoning has occurred in cases where animals have fed almost exclusively on the plants over long periods. Cattle, goats, and horses have been poisoned (Kingsbury 1964, Staley 1976).



References:

Kingsbury, J. M. 1964. Poisonous plants of the United States and Canada. Prentice-Hall Inc., Englewood Cliffs, N.J., USA. 626 pp.

Staley, E. S. 1976. A treatment for tansy mustard poisoning. Bovine Pract., 11: 35.

Nomenclature:

Scientific Name: *Descurainia pinnata* (Walt.) Britt.

Vernacular name(s): green tansy mustard

Scientific family name: *Cruciferae*

Vernacular family name: mustard

Go to ITIS^{*ca} for more taxonomic information on: [Descurainia pinnata](#)

References:

Agriculture Quebec. 1975. Noms des maladies des plantes du Canada/ Names of plant diseases in Canada. , Quebec City, Que., Canada. 288 pp.

Alex, J. F., Cayouette, R., Mulligan, G. A. 1980. Common and botanical names of weeds in Canada/Noms populaire et

scientifiques des plantes nuisibles du Canada. Revised. Agric. Can. Publ., Ottawa, Ont., Canada. 132 pp.

Bailey, L. H., Bailey, E. Z. 1976. Hortus third. Revised. MacMillan, New York, N.Y., USA. 1290 pp.

Scoggan, H. J. 1978, 1979. The flora of Canada. Nat. Mus. Nat. Sci. (Ottawa) Publ. Bot. 7(1)-7(4). 1711 pp.

Van Wijk, H. L. 1911. A dictionary of plant names. Martinus Nijhoff, The Hague, The Netherlands. 1444 pp.

Victorin, M. 1964. Flore Laurentienne. 2nd ed. Univ. Montreal, Montreal, Que., Canada. 952 pp.

Geographic Information

Alberta
British Columbia
Manitoba
Northwest Territories
Ontario
Quebec
Saskatchewan

References:

Bailey, L. H., Bailey, E. Z. 1976. Hortus third. Revised. MacMillan, New York, N.Y., USA. 1290 pp.

Boivin, B. 1966, 1967. Énumération des plantes du Canada. Provencheria 6. Nat. Can. (Que.) 93: 253-274; 371-437; 583-646; 989-1063. 94: 131-157; 471-528; 625-655.

Image or illustration

green tansy mustard:

Images: images.google.com

Toxic parts:

leaves
seeds

References:

Staley, E. S. 1976. A treatment for tansy mustard poisoning. Bovine Pract., 11: 35.

Toxic plant chemicals:

unknown chemical

References:

Staley, E. S. 1976. A treatment for tansy mustard poisoning. Bovine Pract., 11: 35.

Animals/Human Poisoning:

Note: When an animal is listed without additional information, the literature (as of 1993) contained no detailed explanation.

Cattle

General symptoms of poisoning:

[blindness](#)

[death](#)

[weight loss](#)

Notes on poisoning:

Symptoms in cattle start with partial or complete blindness, followed by an inability to use the tongue or throat, leading to an inability to eat. Death occurs if treatment is not applied to recover the ability to eat and see. Treatment has included administering 9-14 L of water twice daily to improve digestion. More recent treatment involves intravenous injections of ethanol diluted in Ringers solution (Staley 1976).

References:

Kingsbury, J. M. 1964. Poisonous plants of the United States and Canada. Prentice-Hall Inc., Englewood Cliffs, N.J., USA. 626 pp.

Staley, E. S. 1976. A treatment for tansy mustard poisoning. Bovine Pract., 11: 35.

Goats

Horses

[Another search?](#)

[Français](#) | [Contact Us](#) | [Help](#) | [Search](#) | [Canada site](#)

[Coming Events](#) | [About CBIF](#) | [Links](#) | [Reports and Publications](#) | [Home](#)

Date modified: 2003-02-06

[Important Notices](#)



Français	Contact us	Help	Search	Canada site
Coming events	About CBIF	Links	Reports and publications	Home

Canadian Biodiversity Information Facility



Notes on poisoning: ground-cherry

[Introduction](#)[Interactive](#)[All poisonous plants by
Botanical name](#)[All poisonous plants by
Common name](#)[Important WWW Poisonous
Plants sites](#)

General poisoning notes:

Ground-cherry (*Physalis peruviana*) is an ornamental herb that is grown for its ripe fruits, which are used for making preserves. The immature fruits contain sufficient solanine to cause gastroenteritis and diarrhea if ingested. Children should be discouraged from eating the fruits (Lampe and McCann 1985).

References:

Lampe, K. F., McCann, M. A. 1985. AMA Handbook of poisonous and injurious plants. American Medical Assoc. Chicago, Ill., USA. 432 pp.

Nomenclature:

Scientific Name: *Physalis peruviana* L.

Vernacular name(s): ground-cherry

Scientific family name: *Solanaceae*

Vernacular family name: nightshade

Go to ITIS*^{ca} for more taxonomic information on: [Physalis peruviana](#)

References:

Agriculture Quebec. 1975. Noms des maladies des plantes du Canada/ Names of plant diseases in Canada. , Quebec City, Que., Canada. 288 pp.

Alex, J. F., Cayouette, R., Mulligan, G. A. 1980. Common and botanical names of weeds in Canada/Noms populaire et scientifiques des plantes nuisibles du Canada. Revised. Agric. Can. Publ., Ottawa, Ont., Canada. 132 pp.

Bailey, L. H., Bailey, E. Z. 1976. Hortus third. Revised. MacMillan, New York, N.Y., USA. 1290 pp.

Scoggan, H. J. 1978, 1979. The flora of Canada. Nat. Mus. Nat. Sci. (Ottawa) Publ. Bot. 7(1)-7(4). 1711 pp.

Van Wijk, H. L. 1911. A dictionary of plant names. Martinus Nijhoff, The Hague, The Netherlands. 1444 pp.

Victorin, M. 1964. Flore Laurentienne. 2nd ed. Univ. Montreal, Montreal, Que., Canada. 952 pp.

Geographic Information

Plant or plant parts used in or around the home.

References:

Bailey, L. H., Bailey, E. Z. 1976. Hortus third. Revised. MacMillan, New York, N.Y., USA. 1290 pp.

Boivin, B. 1966, 1967. Énumération des plantes du Canada. Provencheria 6. Nat. Can. (Que.) 93: 253-274; 371-437; 583-646; 989-1063. 94: 131-157; 471-528; 625-655.

Image or illustration

ground-cherry:

Images: images.google.com

Toxic parts:

immature fruit

References:

Lampe, K. F., McCann, M. A. 1985. AMA Handbook of poisonous and injurious plants. American Medical Assoc. Chicago, Ill., USA. 432 pp.

Notes on Toxic plant chemicals:

Solanine, a bitter glycoalkaloid, is found in the unripened berries (Lampe and McCann 1985).

Toxic plant chemicals:

solanine

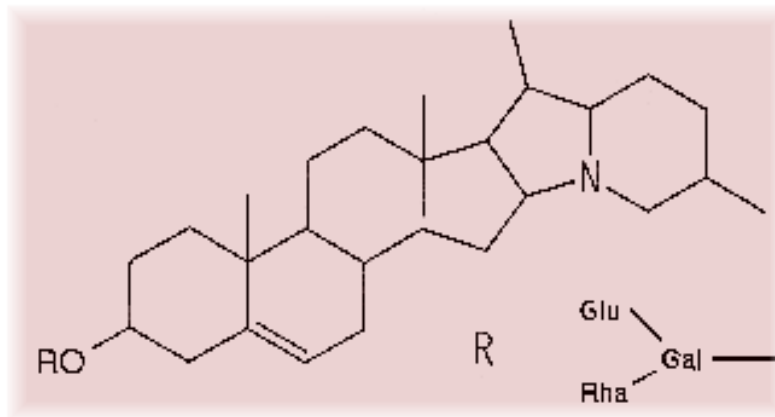

Chemical diagram(s) are courtesy of [Ruth McDiarmid](#), Biochemistry Technician, Kamloops Range Station, Agriculture and Agri-Food Canada, Kamloops, British Columbia, Canada.

References:

Lampe, K. F., McCann, M. A. 1985. AMA Handbook of poisonous and injurious plants. American Medical Assoc. Chicago, Ill., USA. 432 pp.

Animals/Human Poisoning:

Note: When an animal is listed without additional information, the literature (as of 1993) contained no detailed explanation.

Humans

General symptoms of poisoning:

[diarrhea](#)

[fever](#)

[gastroenteritis](#)

Notes on poisoning:

Symptoms of ingestion include gastroenteritis, diarrhea, and fever, with a scratchy feeling in the throat a few hours after ingestion. Children are more susceptible to poisoning than adults (Lampe and McCann 1985).

References:

Lampe, K. F., McCann, M. A. 1985. AMA Handbook of poisonous and injurious plants. American Medical Assoc. Chicago, Ill., USA. 432 pp.

[Another search?](#)

[Français](#) | [Contact Us](#) | [Help](#) | [Search](#) | [Canada site](#)

[Coming Events](#) | [About CBIF](#) | [Links](#) | [Reports and Publications](#) | [Home](#)

Date modified: 2003-02-06

[Important Notices](#)



Français	Contact us	Help	Search	Canada site
Coming events	About CBIF	Links	Reports and publications	Home

Canadian Biodiversity Information Facility



Notes on poisoning: ground-ivy

[Introduction](#)

[Interactive](#)

[All poisonous plants by Botanical name](#)

[All poisonous plants by Common name](#)

[Important WWW Poisonous Plants sites](#)



General poisoning notes:

Ground-ivy (*Glechoma hederacea*) is a creeping ground cover that can grow abundantly in uncultivated damp or shaded ground around houses and garden areas. This plant contains an irritant oil that is toxic to horses if they ingest large quantities of the fresh or dried plant. In one case in Canada the death of horses was reported (Fyles 1920, Fuller and McClintock 1986).

References:

- Fuller, T. C., McClintock, E. 1986. Poisonous plants of California. Univ. California Press, Berkeley, Calif., USA. 432 pp.
- Fyles, F. 1920. Principal poisonous plants of Canada. Can. Dep. Agric. Exp. Farms. Bull. 39. 112 pp.

Nomenclature:

Scientific Name: *Glechoma hederacea* L.

Vernacular name(s): ground-ivy

Scientific family name: *Labiatae*

Vernacular family name: mint

Go to ITIS^{*ca} for more taxonomic information on: [Glechoma hederacea](#)

References:

Agriculture Quebec. 1975. Noms des maladies des plantes du Canada/ Names of plant diseases in Canada. , Quebec City, Que., Canada. 288 pp.

Alex, J. F., Cayouette, R., Mulligan, G. A. 1980. Common and

botanical names of weeds in Canada/Noms populaire et scientifiques des plantes nuisibles du Canada. Revised. Agric. Can. Publ., Ottawa, Ont., Canada. 132 pp.

Bailey, L. H., Bailey, E. Z. 1976. Hortus third. Revised. MacMillan, New York, N.Y., USA. 1290 pp.

Scoggan, H. J. 1978, 1979. The flora of Canada. Nat. Mus. Nat. Sci. (Ottawa) Publ. Bot. 7(1)-7(4). 1711 pp.

Van Wijk, H. L. 1911. A dictionary of plant names. Martinus Nijhoff, The Hague, The Netherlands. 1444 pp.

Victorin, M. 1964. Flore Laurentienne. 2nd ed. Univ. Montreal, Montreal, Que., Canada. 952 pp.

Geographic Information

Alberta
British Columbia
Manitoba
New Brunswick
Newfoundland
Nova Scotia
Ontario
Prince Edward Island
Quebec
Saskatchewan

References:

Bailey, L. H., Bailey, E. Z. 1976. Hortus third. Revised. MacMillan, New York, N.Y., USA. 1290 pp.

Boivin, B. 1966, 1967. Énumération des plantes du Canada. Provencheria 6. Nat. Can. (Que.) 93: 253-274; 371-437; 583-646; 989-1063. 94: 131-157; 471-528; 625-655.

Image or illustration

ground-ivy:

Images: images.google.com

Toxic parts:

leaves
stems

References:

Fyles, F. 1920. Principal poisonous plants of Canada. Can. Dep. Agric. Exp. Farms. Bull. 39. 112 pp.

Toxic plant chemicals:

unknown chemical

References:

Fyles, F. 1920. Principal poisonous plants of Canada. Can. Dep. Agric. Exp. Farms. Bull. 39. 112 pp.

Animals/Human Poisoning:

Note: When an animal is listed without additional information, the literature (as of 1993) contained no detailed explanation.

Horses

General symptoms of poisoning:

[cyanosis](#)

[dyspnea](#)

[lungs, congestion of](#)

[pupil dilation](#)

[salivation](#)

[sweating](#)

Notes on poisoning:

In Prince Edward Island two horses ingested large quantities of ground-ivy in November when the ivy provided an abundance of green foliage. The horses panted continually and died within a week. One horse would lie down and the other horse would not. In Europe, horses have been reported to ingest large amounts of fresh or dried ground-ivy, with subsequent poisoning. Apparently, cattle and sheep were not poisoned after they ingested the plant (Fyles 1920).

References:

Fyles, F. 1920. Principal poisonous plants of Canada. Can. Dep. Agric. Exp. Farms. Bull. 39. 112 pp.

[Another search?](#)

[Français](#) | [Contact Us](#) | [Help](#) | [Search](#) | [Canada site](#)
[Coming Events](#) | [About CBIF](#) | [Links](#) | [Reports and Publications](#) |
[Home](#)

Date modified: 2003-02-06

[Important Notices](#)



Français	Contact us	Help	Search	Canada site
Coming events	About CBIF	Links	Reports and publications	Home

Canadian Biodiversity Information Facility



Notes on poisoning: Guelder-rose

[Introduction](#)

[Interactive](#)

[All poisonous plants by Botanical name](#)

[All poisonous plants by Common name](#)

[Important WWW Poisonous Plants sites](#)



General poisoning notes:

Guelder-rose (*Viburnum opulus*) was introduced as a cultivated ornamental and can grow across southern Canada. Occasionally, the shrub may become naturalized. The fears of serious poisoning reported in older literature seem unfounded. Humans who ingest the berries may experience mild symptoms (Frohne and Pfander 1983).

References:

Frohne, D., Pfander, H. J. 1983. A colour atlas of poisonous plants. Wolfe Publishing Ltd., London, England. 291 pp.

Nomenclature:

Scientific Name: *Viburnum opulus* L.

Vernacular name(s): Guelder-rose

Scientific family name: *Caprifoliaceae*

Vernacular family name: honeysuckle

Go to ITIS^{*ca} for more taxonomic information on: [Viburnum opulus](#)

References:

Agriculture Quebec. 1975. Noms des maladies des plantes du Canada/ Names of plant diseases in Canada. , Quebec City, Que., Canada. 288 pp.

Alex, J. F., Cayouette, R., Mulligan, G. A. 1980. Common and botanical names of weeds in Canada/Noms populaire et scientifiques des plantes nuisibles du Canada. Revised. Agric. Can. Publ., Ottawa, Ont., Canada. 132 pp.

Bailey, L. H., Bailey, E. Z. 1976. Hortus third. Revised. MacMillan, New York, N.Y., USA. 1290 pp.

Scoggan, H. J. 1978, 1979. The flora of Canada. Nat. Mus. Nat. Sci. (Ottawa) Publ. Bot. 7(1)-7(4). 1711 pp.

Van Wijk, H. L. 1911. A dictionary of plant names. Martinus Nijhoff, The Hague, The Netherlands. 1444 pp.

Victorin, M. 1964. Flore Laurentienne. 2nd ed. Univ. Montreal, Montreal, Que., Canada. 952 pp.

Geographic Information

Plant or plant parts used in or around the home.

References:

Bailey, L. H., Bailey, E. Z. 1976. Hortus third. Revised. MacMillan, New York, N.Y., USA. 1290 pp.

Boivin, B. 1966, 1967. Énumération des plantes du Canada. Provencheria 6. Nat. Can. (Que.) 93: 253-274; 371-437; 583-646; 989-1063. 94: 131-157; 471-528; 625-655.

Image or illustration

Guelder-rose:

Images: images.google.com

Toxic parts:

immature fruit

References:

Frohne, D., Pfander, H. J. 1983. A colour atlas of poisonous plants. Wolfe Publishing Ltd., London, England. 291 pp.

Animals/Human Poisoning:

Note: When an animal is listed without additional information, the literature (as of 1993) contained no detailed explanation.

Humans

General symptoms of poisoning:

[diarrhea](#)

[vomiting](#)

Notes on poisoning:

The older European literature suggests that ingesting the berries can cause serious poisoning or even death. However, no recent cases of serious poisoning have been reported. Ingesting the fruits can cause diarrhea or vomiting if unripe berries or large quantities of berries are eaten (Frohne and Pfander 1983).

References:

Frohne, D., Pfander, H. J. 1983. A colour atlas of poisonous plants. Wolfe Publishing Ltd., London, England. 291 pp.

[Another search?](#)

[Français](#) | [Contact Us](#) | [Help](#) | [Search](#) | [Canada site](#)

[Coming Events](#) | [About CBIF](#) | [Links](#) | [Reports and Publications](#) | [Home](#)

Date modified: 2003-02-06

[Important Notices](#)



Français	Contact us	Help	Search	Canada site
Coming events	About CBIF	Links	Reports and publications	Home

Canadian Biodiversity Information Facility



Notes on poisoning: hairy vetch

[Introduction](#)[Interactive](#)[All poisonous plants by Botanical name](#)[All poisonous plants by Common name](#)[Important WWW Poisonous Plants sites](#)

General poisoning notes:

Hairy vetch (*Vicia villosa*) was introduced as a forage in Canada and has become successfully naturalized in parts of southern Canada. This plant causes poisoning in cattle, horses, and poultry. Various syndromes occur in cattle, including a dermatitis that resembles photosensitization in many respects, except that the skin lesions appear on pigmented skin as well. Mortality occurs in cattle and poultry (Panciera 1978, Kerr and Edwards 1982, Cooper and Johnson 1984).

References:

- Anderson, C. A., Divers, T. J. 1983. Systemic granulation inflammation in a horse grazing hairy vetch. *J. Am. Vet. Med. Assoc.*, 183: 569-570.
- Cheeke, P. R., Shull, L. R. 1985. Natural toxicants in feeds and poisonous plants. AVI Publishing Company, Inc., Westport, Conn., USA. 492 pp.
- Cooper, M. R., Johnson, A. W. 1984. Poisonous plants in Britain and their effects on animals and man. Her Majesty's Stationery Office, London, England. 305 pp.
- Kerr, L. A., Edwards, W. C. 1982. Hairy vetch poisoning of cattle. *Vet. Med. Small Anim. Clin.*, 77: 257-258.
- Kingsbury, J. M. 1964. Poisonous plants of the United States and Canada. Prentice-Hall Inc., Englewood Cliffs, N.J., USA. 626 pp.
- Panciera, R. J. 1978. Hairy vetch (*Vicia villosa* Roth) poisoning in cattle. Pages 555-563 in Keeler, R. F., Van Kampen, K. R., James, L. F., eds. *Effects of poisonous plants on livestock*. Academic Press, New York, N.Y., USA. 600 pp.

Nomenclature:

Scientific Name: *Vicia villosa* Roth

Vernacular name(s): hairy vetch

Scientific family name: *Leguminosae*

Vernacular family name: pea

Go to ITIS^{*ca} for more taxonomic information on: [Vicia villosa](#)

References:

Agriculture Quebec. 1975. Noms des maladies des plantes du Canada/ Names of plant diseases in Canada. , Quebec City, Que., Canada. 288 pp.

Alex, J. F., Cayouette, R., Mulligan, G. A. 1980. Common and botanical names of weeds in Canada/Noms populaire et scientifiques des plantes nuisibles du Canada. Revised. Agric. Can. Publ., Ottawa, Ont., Canada. 132 pp.

Bailey, L. H., Bailey, E. Z. 1976. Hortus third. Revised. MacMillan, New York, N.Y., USA. 1290 pp.

Scoggan, H. J. 1978, 1979. The flora of Canada. Nat. Mus. Nat. Sci. (Ottawa) Publ. Bot. 7(1)-7(4). 1711 pp.

Van Wijk, H. L. 1911. A dictionary of plant names. Martinus Nijhoff, The Hague, The Netherlands. 1444 pp.

Victorin, M. 1964. Flore Laurentienne. 2nd ed. Univ. Montreal, Montreal, Que., Canada. 952 pp.

Geographic Information

British Columbia

Manitoba

Nova Scotia

Ontario

Quebec

References:

Bailey, L. H., Bailey, E. Z. 1976. Hortus third. Revised. MacMillan, New York, N.Y., USA. 1290 pp.

Boivin, B. 1966, 1967. Énumération des plantes du Canada. Provencheria 6. Nat. Can. (Que.) 93: 253-274; 371-437; 583-646; 989-1063. 94: 131-157; 471-528; 625-655.

Image or illustration

hairy vetch:

Images: images.google.com

Notes on Poisonous plant parts:

This plant has occasionally caused poisoning when used as a forage for livestock (Cheeke and Schull 1985).

Toxic parts:

leaves

seeds

References:

Kerr, L. A., Edwards, W. C. 1982. Hairy vetch poisoning of cattle. *Vet. Med. Small Anim. Clin.*, 77: 257-258.

Toxic plant chemicals:

unknown chemical

References:

Kerr, L. A., Edwards, W. C. 1982. Hairy vetch poisoning of cattle. *Vet. Med. Small Anim. Clin.*, 77: 257-258.

Animals/Human Poisoning:

Note: When an animal is listed without additional information, the literature (as of 1993) contained no detailed explanation.

Cattle

General symptoms of poisoning:

[anorexia](#)

[breathing, labored](#)

[coat, rough and dry](#)

[conjunctivitis](#)

[convulsions](#)

[death](#)

[diarrhea](#)

[pain](#)

[pneumonitis](#)
[restlessness](#)
[skin, peeling of](#)
[weakness](#)
[weight loss](#)

Notes on poisoning:

Two types of syndromes are suggested from the symptoms seen in cattle. The first syndrome is acute illness followed by death after ingesting raw seeds of hairy vetch. The animals were very restless, showed pain, experienced convulsions, and died. The second syndrome involves skin lesions, cough, respiration problems, and death after 2 weeks. Postmortem findings showed severe bronchitis with pneumonia, yellow- brown liver, and inflamed forestomachs (Panciera 1978, Cooper and Johnson 1984).

References:

Cooper, M. R., Johnson, A. W. 1984. Poisonous plants in Britain and their effects on animals and man. Her Majesty's Stationery Office, London, England. 305 pp.

Kerr, L. A., Edwards, W. C. 1982. Hairy vetch poisoning of cattle. *Vet. Med. Small Anim. Clin.*, 77: 257-258.

Kingsbury, J. M. 1964. Poisonous plants of the United States and Canada. Prentice-Hall Inc., Englewood Cliffs, N.J., USA. 626 pp.

Panciera, R. J. 1978. Hairy vetch (*Vicia villosa* Roth) poisoning in cattle. Pages 555-563 in Keeler, R. F., Van Kampen, K. R., James, L. F., eds. Effects of poisonous plants on livestock. Academic Press, New York, N.Y., USA. 600 pp.

Horses

General symptoms of poisoning:

[conjunctivitis](#)
[mouth, edema of](#)

Notes on poisoning:

Hairy vetch causes systemic granulomatous inflammation. Edema occurs especially around the lips and eyes. Conjunctivitis and corneal ulceration develops. The poisoning is most prevalent in mid to late spring as the hairy vetch reaches maturity (Anderson and Divers 1983).

References:

Anderson, C. A., Divers, T. J. 1983. Systemic granulation inflammation in a horse grazing hairy vetch. J. Am. Vet. Med. Assoc., 183: 569-570.

Cheeke, P. R., Shull, L. R. 1985. Natural toxicants in feeds and poisonous plants. AVI Publishing Company, Inc., Westport, Conn., USA. 492 pp.

Poultry

General symptoms of poisoning:

[breathing, labored](#)

[convulsions](#)

[incoordination](#)

[weight loss](#)

Notes on poisoning:

Feeding chicks experimentally on a diet of 30-80% hairy vetch seeds caused 20-40% mortality. Symptoms included weight loss, excitability, and sometimes violent convulsions (Cooper and Johnson 1984).

References:

Cooper, M. R., Johnson, A. W. 1984. Poisonous plants in Britain and their effects on animals and man. Her Majesty's Stationery Office, London, England. 305 pp.

[Another search?](#)

[Français](#) | [Contact Us](#) | [Help](#) | [Search](#) | [Canada site](#)

[Coming Events](#) | [About CBIF](#) | [Links](#) | [Reports and Publications](#) | [Home](#)

Date modified: 2003-02-06

[Important Notices](#)



Français	Contact us	Help	Search	Canada site
Coming events	About CBIF	Links	Reports and publications	Home

Canadian Biodiversity Information Facility



Notes on poisoning: heart-leaved philodendron

[Introduction](#)[Interactive](#)[All poisonous plants by Botanical name](#)[All poisonous plants by Common name](#)[Important WWW Poisonous Plants sites](#)

General poisoning notes:



Heart-leaved philodendron (*Philodendron scandens*) is an ornamental. Chewing the leaves of philodendrons results in painful burning and swelling of the mouth parts because of the oxalates. Contact dermatitis also occurs (Lampe and McCann 1985). A recent survey showed that even though 67% of 188 cases involved philodendrons, only one case developed minor symptoms (Mrvos et al. 1990). McIntire et al. (1990) describe the death of an infant after it had ingested a philodendron. The child had ulceration of lips and tongue as well as esophageal erosion. Death was caused by cardiac arrest secondary to vagotonia resulting from esophageal erosions. Family pets can also exhibit signs of toxicity if they chew on leaves of philodendrons. Hanna (1986) lists several symptoms attributable to ingestion of these plants by pets. However, Sellers et al. (1977) conducted laboratory feeding studies on cats and concluded that signs of acute toxicity were not found upon necropsy, even when large quantities of leaves were ingested. Experimental work on mice and rats showed that death occurred when the rodents were given extracts from leaves and stems (Der Marderosian et al. 1976).

References:

- Der Marderosian, A. H., Giller, F. B., Roia, F. C. 1976. Phytochemical and toxicological screening of household ornamental plants potentially toxic to humans. 1. J. Toxicol. Environ. Health, 1: 939-953.
- Hanna, G. 1986. Plant poisoning in canines and felines. Vet. Hum. Toxicol., 28: 38-40.
- Lampe, K. F., McCann, M. A. 1985. AMA Handbook of poisonous and injurious plants. American Medical Assoc.

Chicago, Ill., USA. 432 pp.

McIntire, M. S., Guest, J. R., Porterfield, J. F. 1990. *Philodendron* - an infant death. *Clin. Toxicol.*, 28: 177-183.

Mrvos, R., Dean, B. S., Krenzelok, E. P. 1990. *Philodendron/Dieffenbachia* ingestions: are they a problem? *Vet. Hum. Toxicol.*, 32: 369.

Sellers, S. J., King, M., Aronson, C. E., Der Marderosian, A. 1977. Toxicologic assessment of *Philodendron oxycardium* Schott (Araceae) in domestic cats. *Vet. Hum. Toxicol.*, 19: 92-96.

Nomenclature:

Scientific Name: *Philodendron scandens* C. Koch & H. Sello

Vernacular name(s): heart-leaved philodendron

Scientific family name: *Araceae*

Vernacular family name: arum

Go to ITIS^{*ca} for more taxonomic information on: [Philodendron scandens](#)

References:

Agriculture Quebec. 1975. Noms des maladies des plantes du Canada/ Names of plant diseases in Canada. , Quebec City, Que., Canada. 288 pp.

Alex, J. F., Cayouette, R., Mulligan, G. A. 1980. Common and botanical names of weeds in Canada/Noms populaire et scientifiques des plantes nuisibles du Canada. Revised. Agric. Can. Publ., Ottawa, Ont., Canada. 132 pp.

Bailey, L. H., Bailey, E. Z. 1976. Hortus third. Revised. MacMillan, New York, N.Y., USA. 1290 pp.

Scoggan, H. J. 1978, 1979. The flora of Canada. *Nat. Mus. Nat. Sci. (Ottawa) Publ. Bot.* 7(1)-7(4). 1711 pp.

Van Wijk, H. L. 1911. A dictionary of plant names. Martinus Nijhoff, The Hague, The Netherlands. 1444 pp.

Victorin, M. 1964. Flore Laurentienne. 2nd ed. Univ. Montreal, Montreal, Que., Canada. 952 pp.

Geographic Information

Plant or plant parts used in or around the home.

References:

Bailey, L. H., Bailey, E. Z. 1976. Hortus third. Revised. MacMillan, New York, N.Y., USA. 1290 pp.

Boivin, B. 1966, 1967. Énumération des plantes du Canada. Provencheria 6. Nat. Can. (Que.) 93: 253-274; 371-437; 583-646; 989-1063. 94: 131-157; 471-528; 625-655.

Image or illustration

heart-leaved philodendron:

Images: images.google.com

Toxic parts:

leaves

References:

Lampe, K. F., McCann, M. A. 1985. AMA Handbook of poisonous and injurious plants. American Medical Assoc. Chicago, Ill., USA. 432 pp.

Toxic plant chemicals:

oxalate

References:

Sellers, S. J., King, M., Aronson, C. E., Der Marderosian, A. 1977. Toxicologic assessment of *Philodendron oxycardium* Schott (Araceae) in domestic cats. Vet. Hum. Toxicol., 19: 92-96.

Animals/Human Poisoning:

Note: When an animal is listed without additional information, the literature (as of 1993) contained no detailed explanation.

Cats

General symptoms of poisoning:

[nephritis](#)

[nervousness](#)

[opisthotonos](#)

[temperature, elevated](#)

[trembling](#)

References:

Hanna, G. 1986. Plant poisoning in canines and felines. *Vet. Hum. Toxicol.*, 28: 38-40.

Sellers, S. J., King, M., Aronson, C. E., Der Marderosian, A. 1977. Toxicologic assessment of *Philodendron oxycardium* Schott (Araceae) in domestic cats. *Vet. Hum. Toxicol.*, 19: 92-96.

Humans

General symptoms of poisoning:

[mouth, irritation of](#)

Notes on poisoning:

Painful burning and swelling of lips, mouth, tongue, and throat can develop quickly after chewing of leaves. Contact dermatitis can also occur. Treatment includes administering cool liquids. The insoluble oxalates do not produce systemic poisoning in humans (Lampe and McCann 1985).

References:

Lampe, K. F., McCann, M. A. 1985. *AMA Handbook of poisonous and injurious plants*. American Medical Assoc. Chicago, Ill., USA. 432 pp.

McIntire, M. S., Guest, J. R., Porterfield, J. F. 1990. *Philodendron* - an infant death. *Clin. Toxicol.*, 28: 177-183.

Rodents

General symptoms of poisoning:

[death](#)

References:

Der Marderosian, A. H., Giller, F. B., Roia, F. C. 1976. Phytochemical and toxicological screening of household ornamental plants potentially toxic to humans. 1. *J. Toxicol. Environ. Health*, 1: 939-953.

[Another search?](#)

[Français](#) | [Contact Us](#) | [Help](#) | [Search](#) | [Canada site](#)

[Coming Events](#) | [About CBIF](#) | [Links](#) | [Reports and Publications](#) | [Home](#)

Date modified: 2003-02-06

[Important Notices](#)



Français	Contact us	Help	Search	Canada site
Coming events	About CBIF	Links	Reports and publications	Home



Notes on poisoning: hemp dogbane

[Introduction](#)

[Interactive](#)

[All poisonous plants by Botanical name](#)

[All poisonous plants by Common name](#)

[Important WWW Poisonous Plants sites](#)



General poisoning notes:

1909). Hemp dogbane (*Apocynum cannabinum*) is a native plant found across Canada. Fuller and McClintock (1986) report that two horses died after ingesting alfalfa hay that contained large quantities of hemp dogbane. The tops of the plants (up to 1 m tall) were found in the hay.

References:

Fuller, T. C., McClintock, E. 1986. Poisonous plants of California. Univ. California Press, Berkeley, Calif., USA. 432 pp.

Nomenclature:

Scientific Name: *Apocynum cannabinum* L.

Vernacular name(s): hemp dogbane

Scientific family name: *Apocynaceae*

Vernacular family name: dogbane

Go to ITIS^{*ca} for more taxonomic information on: [Apocynum cannabinum](#)

References:

Agriculture Quebec. 1975. Noms des maladies des plantes du Canada/ Names of plant diseases in Canada. , Quebec City, Que., Canada. 288 pp.

Alex, J. F., Cayouette, R., Mulligan, G. A. 1980. Common and botanical names of weeds in Canada/Noms populaire et scientifiques des plantes nuisibles du Canada. Revised. Agric. Can. Publ., Ottawa, Ont., Canada. 132 pp.

Bailey, L. H., Bailey, E. Z. 1976. Hortus third. Revised. MacMillan,

New York, N.Y., USA. 1290 pp.

Scoggan, H. J. 1978, 1979. The flora of Canada. Nat. Mus. Nat. Sci. (Ottawa) Publ. Bot. 7(1)-7(4). 1711 pp.

Van Wijk, H. L. 1911. A dictionary of plant names. Martinus Nijhoff, The Hague, The Netherlands. 1444 pp.

Victorin, M. 1964. Flore Laurentienne. 2nd ed. Univ. Montreal, Montreal, Que., Canada. 952 pp.

Geographic Information

Alberta
British Columbia
Manitoba
New Brunswick
Newfoundland
Northwest Territories
Nova Scotia
Ontario
Quebec
Saskatchewan

References:

Bailey, L. H., Bailey, E. Z. 1976. Hortus third. Revised. MacMillan, New York, N.Y., USA. 1290 pp.

Boivin, B. 1966, 1967. Énumération des plantes du Canada. Provencheria 6. Nat. Can. (Que.) 93: 253-274; 371-437; 583-646; 989-1063. 94: 131-157; 471-528; 625-655.

Image or illustration

hemp dogbane:

Images: images.google.com

Toxic parts:

all parts

References:

Fuller, T. C., McClintock, E. 1986. Poisonous plants of California. Univ. California Press, Berkeley, Calif., USA. 432 pp.

Notes on Toxic plant chemicals:

Hemp dogbane contains the chemical cymarin (a cardiac glycoside). Joubert (1989) lists this chemical under "**Apocynum camrabinum**," which is a typographical error and should read "**Apocynum cannabinum**."

Toxic plant chemicals:

apocynamarin

cymarin

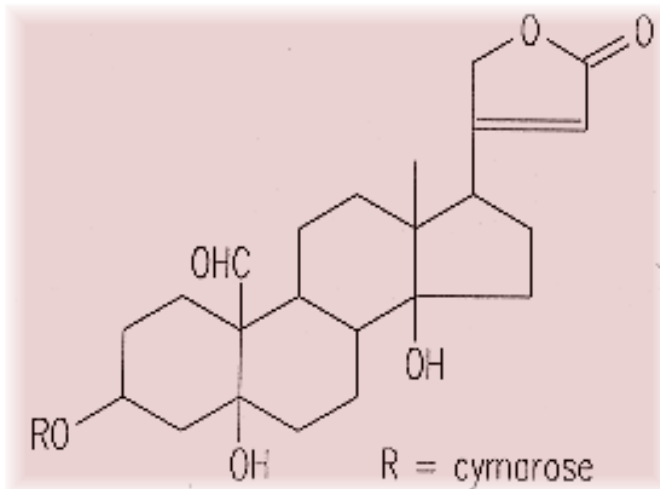

Chemical diagram(s) are courtesy of [Ruth McDiarmid](#), Biochemistry Technician, Kamloops Range Station, Agriculture and Agri-Food Canada, Kamloops, British Columbia, Canada.

References:

Fuller, T. C., McClintock, E. 1986. Poisonous plants of California. Univ. California Press, Berkeley, Calif., USA. 432 pp.

Joubert, J. P. 1989. Cardiac glycosides. Pages 61-97 in Cheeke, P. R., ed. Toxicants of plant origin. Vol. II. Glycosides. CRC Press, Inc., Boca Raton, Fla., USA. 277 pp.

Animals/Human Poisoning:

Note: When an animal is listed without additional information, the literature (as of 1993) contained no detailed explanation.

Horses

[Another search?](#)

[Français](#) | [Contact Us](#) | [Help](#) | [Search](#) | [Canada site](#)

[Coming Events](#) | [About CBIF](#) | [Links](#) | [Reports and Publications](#) | [Home](#)

Date modified: 2003-02-06

[Important Notices](#)



Français	Contact us	Help	Search	Canada site
Coming events	About CBIF	Links	Reports and publications	Home

Canadian Biodiversity Information Facility



Notes on poisoning: horse-chestnut

[Introduction](#)

[Interactive](#)

[All poisonous plants by Botanical name](#)

[All poisonous plants by Common name](#)

[Important WWW Poisonous Plants sites](#)

General poisoning notes:

Horse-chestnut (*Aesculus hippocastanum*) is an introduced tree that is found in the southern parts of Ontario and Quebec. It has poisoned cattle, horses, and pigs, causing sickness and death (Reynard and Norton 1942, Muenscher 1975). Human poisoning has also occurred.



References:

Cooper, M. R., Johnson, A. W. 1984. Poisonous plants in Britain and their effects on animals and man. Her Majesty's Stationery Office, London, England. 305 pp.

Hardin, J. W., Arena, J. M. 1969. Human poisoning from native and cultivated plants. Duke University Press, Durham, N.C., USA. 167 pp.

Lampe, K. F., McCann, M. A. 1985. AMA Handbook of poisonous and injurious plants. American Medical Assoc. Chicago, Ill., USA. 432 pp.

Reynard, G. B., Norton, J. B. 1942. Poisonous plants of Maryland in relation to livestock. Univ. MD. Agric. Exp. Stn. Bull., A10. 312 pp.

Nomenclature:

Scientific Name: *Aesculus hippocastanum* L.

Vernacular name(s): horse-chestnut

Scientific family name: *Hippocastanaceae*

Vernacular family name: horse-chestnut

Go to ITIS*^{ca} for more taxonomic information on: [Aesculus](#)

[hippocastanum](#)

References:

Agriculture Quebec. 1975. Noms des maladies des plantes du Canada/ Names of plant diseases in Canada. , Quebec City, Que., Canada. 288 pp.

Alex, J. F., Cayouette, R., Mulligan, G. A. 1980. Common and botanical names of weeds in Canada/Noms populaire et scientifiques des plantes nuisibles du Canada. Revised. Agric. Can. Publ., Ottawa, Ont., Canada. 132 pp.

Bailey, L. H., Bailey, E. Z. 1976. Hortus third. Revised. MacMillan, New York, N.Y., USA. 1290 pp.

Scoggan, H. J. 1978, 1979. The flora of Canada. Nat. Mus. Nat. Sci. (Ottawa) Publ. Bot. 7(1)-7(4). 1711 pp.

Van Wijk, H. L. 1911. A dictionary of plant names. Martinus Nijhoff, The Hague, The Netherlands. 1444 pp.

Victorin, M. 1964. Flore Laurentienne. 2nd ed. Univ. Montreal, Montreal, Que., Canada. 952 pp.

Geographic Information

Plant or plant parts used in or around the home.

References:

Bailey, L. H., Bailey, E. Z. 1976. Hortus third. Revised. MacMillan, New York, N.Y., USA. 1290 pp.

Boivin, B. 1966, 1967. Énumération des plantes du Canada. Provencheria 6. Nat. Can. (Que.) 93: 253-274; 371-437; 583-646; 989-1063. 94: 131-157; 471-528; 625-655.

Image or illustration

horse-chestnut:

Images: images.google.com

Notes on Poisonous plant parts:

Horse-chestnut fruits, leaves, and flowers contain the chemical aesculin. Young leaves and flowers are especially toxic to cattle (Reynard and Norton 1942). Children occasionally ingest the fruit but few authenticated cases of poisoning are found in the literature, although death has been reported (Lampe and McCann

1985).

Toxic parts:

flowers
leaves
mature fruit

References:

Cooper, M. R., Johnson, A. W. 1984. Poisonous plants in Britain and their effects on animals and man. Her Majesty's Stationery Office, London, England. 305 pp.

Hardin, J. W., Arena, J. M. 1969. Human poisoning from native and cultivated plants. Duke University Press, Durham, N.C., USA. 167 pp.

Lampe, K. F., McCann, M. A. 1985. AMA Handbook of poisonous and injurious plants. American Medical Assoc. Chicago, Ill., USA. 432 pp.

Reynard, G. B., Norton, J. B. 1942. Poisonous plants of Maryland in relation to livestock. Univ. MD. Agric. Exp. Stn. Bull., A10. 312 pp.

Notes on Toxic plant chemicals:

Aesculin is a saponin (7-hydroxycoumarin 6-glucoside) that yields aesculetin (6,7-dihydroxycoumarin) upon hydrolysis. Aesculin is related to hydrocoumarin found in spoiled sweet-clover hay (Cooper and Johnson 1984). LD-50 measurements from nut extracts were as follows (Williams and Olsen 1984):

10.6 mg/g of body weight for chicks
10.7 mg/g of body weight for hamsters.

Toxic plant chemicals:

aesculin

References:

Cooper, M. R., Johnson, A. W. 1984. Poisonous plants in Britain and their effects on animals and man. Her Majesty's Stationery Office, London, England. 305 pp.

Reynard, G. B., Norton, J. B. 1942. Poisonous plants of Maryland in relation to livestock. Univ. MD. Agric. Exp. Stn. Bull., A10. 312 pp.

Williams, M. C., Olsen, J. D. 1984. Toxicity of seeds of three *Aesculus* spp to chicks and hamsters. *Am. J. Vet. Res.*, 45: 539-542.

Animals/Human Poisoning:

Note: When an animal is listed without additional information, the literature (as of 1993) contained no detailed explanation.

Cattle

Humans

General symptoms of poisoning:

[death](#)

[depression](#)

[diarrhea](#)

[gastroenteritis](#)

[muscle twitching](#)

[paralysis](#)

[pupil dilation](#)

[restlessness](#)

[unconsciousness](#)

[vomiting](#)

[weakness](#)

References:

Cooper, M. R., Johnson, A. W. 1984. Poisonous plants in Britain and their effects on animals and man. Her Majesty's Stationery Office, London, England. 305 pp.

Hardin, J. W., Arena, J. M. 1969. Human poisoning from native and cultivated plants. Duke University Press, Durham, N.C., USA. 167 pp.

Lampe, K. F., McCann, M. A. 1985. AMA Handbook of poisonous and injurious plants. American Medical Assoc. Chicago, Ill., USA. 432 pp.

[Another search?](#)

[Français](#) | [Contact Us](#) | [Help](#) | [Search](#) | [Canada site](#)

[Coming Events](#) | [About CBIF](#) | [Links](#) | [Reports and Publications](#) |

[Home](#)

Date modified: 2003-02-06

[Important Notices](#)



Français	Contact us	Help	Search	Canada site
Coming events	About CBIF	Links	Reports and publications	Home

Canadian Biodiversity Information Facility



Notes on poisoning: horseradish

[Introduction](#)[Interactive](#)[All poisonous plants by Botanical name](#)[All poisonous plants by Common name](#)[Important WWW Poisonous Plants sites](#)

General poisoning notes:

Horseradish (*Armoracia rusticana*) is a cultivated plant that can persist after cultivation. The plant contains glucosinolates, which can cause toxicity in livestock. Irritation of the mucous membranes can occur in humans who grind the roots to produce horseradish condiment. See the notes under *Brassica oleracea* for more information on these chemicals. Under normal circumstances horseradish is safe.

References:



Fenwick, G. R., Heaney, R. K., Mawson, R. 1989. Glucosinolates. Pages 1-41 in Cheeke, P. R., ed. Toxicants of plant origin. Vol. II. Glycosides. CRC Press, Inc., Boca Raton, Fla., USA. 277 pp.

Kingsbury, J. M. 1964. Poisonous plants of the United States and Canada. Prentice-Hall Inc., Englewood Cliffs, N.J., USA. 626 pp.

Nomenclature:

Scientific Name: *Armoracia rusticana* P. Gaertn., Mey & Scherb.

Vernacular name(s): horseradish

Scientific family name: *Cruciferae*

Vernacular family name: mustard

Go to ITIS^{*ca} for more taxonomic information on: [Armoracia rusticana](#)

References:

Agriculture Quebec. 1975. Noms des maladies des plantes du Canada/ Names of plant diseases in Canada. , Quebec City, Que., Canada. 288 pp.

Alex, J. F., Cayouette, R., Mulligan, G. A. 1980. Common and botanical names of weeds in Canada/Noms populaire et scientifiques des plantes nuisibles du Canada. Revised. Agric. Can. Publ., Ottawa, Ont., Canada. 132 pp.

Bailey, L. H., Bailey, E. Z. 1976. Hortus third. Revised. MacMillan, New York, N.Y., USA. 1290 pp.

Scoggan, H. J. 1978, 1979. The flora of Canada. Nat. Mus. Nat. Sci. (Ottawa) Publ. Bot. 7(1)-7(4). 1711 pp.

Van Wijk, H. L. 1911. A dictionary of plant names. Martinus Nijhoff, The Hague, The Netherlands. 1444 pp.

Victorin, M. 1964. Flore Laurentienne. 2nd ed. Univ. Montreal, Montreal, Que., Canada. 952 pp.

Geographic Information

Alberta
British Columbia
Manitoba
Ontario
Prince Edward Island
Quebec
Saskatchewan

References:

Bailey, L. H., Bailey, E. Z. 1976. Hortus third. Revised. MacMillan, New York, N.Y., USA. 1290 pp.

Boivin, B. 1966, 1967. Énumération des plantes du Canada. Provencheria 6. Nat. Can. (Que.) 93: 253-274; 371-437; 583-646; 989-1063. 94: 131-157; 471-528; 625-655.

Image or illustration

horseradish:

Images: images.google.com

Notes on Poisonous plant parts:

Horseradish contains glucosinolates which, if ingested in sufficient quantities, can cause poisoning (Fenwick et al. 1989).

Toxic parts:

all parts

leaves
roots

References:

Fenwick, G. R., Heaney, R. K., Mawson, R. 1989. Glucosinolates. Pages 1-41 in Cheeke, P. R., ed. Toxicants of plant origin. Vol. II. Glycosides. CRC Press, Inc., Boca Raton, Fla., USA. 277 pp.

Notes on Toxic plant chemicals:

See the notes under [Brassica oleracea](#) for a discussion on this chemical and its effects on livestock and humans.

Toxic plant chemicals:

glucosinolates

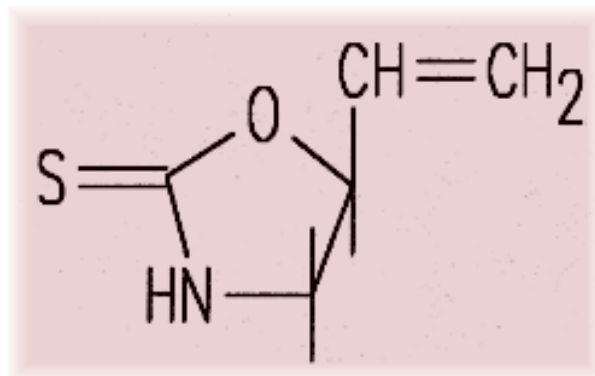

glucosinolates

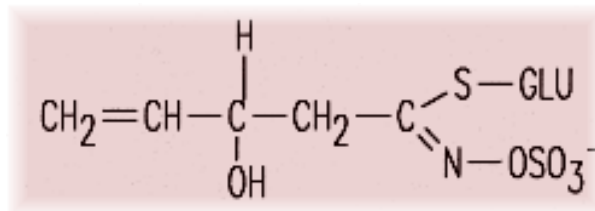

glucosinolates

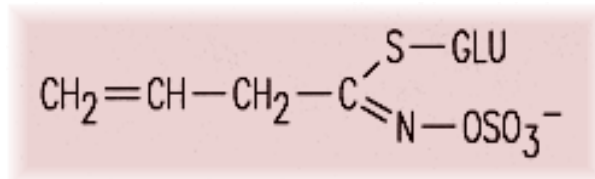

Chemical diagram(s) are courtesy of [Ruth McDiarmid](#), Biochemistry Technician, Kamloops Range Station, Agriculture and Agri-Food Canada, Kamloops, British Columbia, Canada.

References:

Fenwick, G. R., Heaney, R. K., Mawson, R. 1989. Glucosinolates. Pages 1-41 in Cheeke, P. R., ed. Toxicants of plant origin. Vol. II.

Glycosides. CRC Press, Inc., Boca Raton, Fla., USA. 277 pp.

Animals/Human Poisoning:

Note: When an animal is listed without additional information, the literature (as of 1993) contained no detailed explanation.

Humans

Swine

General symptoms of poisoning:

[collapse](#)

[death](#)

Notes on poisoning:

Swine have been poisoned after ingesting of horseradish root equal to 1% of body weight. The animals suffer acute inflammation of the mucous membranes of the stomach as well as pain, followed by collapse and death (Kingsbury 1964).

References:

Fenwick, G. R., Heaney, R. K., Mawson, R. 1989. Glucosinolates. Pages 1-41 in Cheeke, P. R., ed. Toxicants of plant origin. Vol. II. Glycosides. CRC Press, Inc., Boca Raton, Fla., USA. 277 pp.

Kingsbury, J. M. 1964. Poisonous plants of the United States and Canada. Prentice-Hall Inc., Englewood Cliffs, N.J., USA. 626 pp.

[Another search?](#)

[Français](#) | [Contact Us](#) | [Help](#) | [Search](#) | [Canada site](#)

[Coming Events](#) | [About CBIF](#) | [Links](#) | [Reports and Publications](#) |

[Home](#)

Date modified: 2003-02-06

[Important Notices](#)



Français	Contact us	Help	Search	Canada site
Coming events	About CBIF	Links	Reports and publications	Home

Canadian Biodiversity Information Facility



Notes on poisoning: hound's tongue

[Introduction](#)

[Interactive](#)

[All poisonous plants by Botanical name](#)

[All poisonous plants by Common name](#)

[Important WWW Poisonous Plants sites](#)



General poisoning notes:

Hound's-tongue (*Cynoglossum officinale*) is a naturalized biennial plant found across southern Canada. The plant contains pyrrolizidine alkaloids, which have caused poisoning and death in horses and cattle. The plant causes disorders of the central nervous system and can cause hepatic failure in horses (Knight et al. 1984).

References:

Cooper, M. R., Johnson, A. W. 1984. Poisonous plants in Britain and their effects on animals and man. Her Majesty's Stationery Office, London, England. 305 pp.

Knight, A. P., Kimberling, C. V., Stermitz, F. R., Roby, M. R. 1984. *Cynoglossum officinale* (hound's-tongue) - a cause of pyrrolizidine alkaloid poisoning in horses. J. Am. Vet. Med. Assoc., 185: 647-650.

Nomenclature:

Scientific Name: *Cynoglossum officinale* L.

Vernacular name(s): hound's tongue

Scientific family name: *Boraginaceae*

Vernacular family name: borage

Go to ITIS*^{ca} for more taxonomic information on: [Cynoglossum officinale](#)

References:

Agriculture Quebec. 1975. Noms des maladies des plantes du Canada/ Names of plant diseases in Canada. , Quebec City, Que.,

Canada. 288 pp.

Alex, J. F., Cayouette, R., Mulligan, G. A. 1980. Common and botanical names of weeds in Canada/Noms populaire et scientifiques des plantes nuisibles du Canada. Revised. Agric. Can. Publ., Ottawa, Ont., Canada. 132 pp.

Bailey, L. H., Bailey, E. Z. 1976. Hortus third. Revised. MacMillan, New York, N.Y., USA. 1290 pp.

Scoggan, H. J. 1978, 1979. The flora of Canada. Nat. Mus. Nat. Sci. (Ottawa) Publ. Bot. 7(1)-7(4). 1711 pp.

Van Wijk, H. L. 1911. A dictionary of plant names. Martinus Nijhoff, The Hague, The Netherlands. 1444 pp.

Victorin, M. 1964. Flore Laurentienne. 2nd ed. Univ. Montreal, Montreal, Que., Canada. 952 pp.

Geographic Information

Alberta
British Columbia
Manitoba
New Brunswick
Nova Scotia
Ontario
Quebec
Saskatchewan

References:

Bailey, L. H., Bailey, E. Z. 1976. Hortus third. Revised. MacMillan, New York, N.Y., USA. 1290 pp.

Boivin, B. 1966, 1967. Énumération des plantes du Canada. Provencheria 6. Nat. Can. (Que.) 93: 253-274; 371-437; 583-646; 989-1063. 94: 131-157; 471-528; 625-655.

Image or illustration

hound's tongue:

Images: images.google.com

Notes on Poisonous plant parts:

The concentration of the various alkaloids is highest in the rosette stage, i.e., when the leaves are all attached to the root crown and a stem has not grown yet (Knight et al. 1984).

Toxic parts:

leaves

References:

Knight, A. P., Kimberling, C. V., Stermitz, F. R., Roby, M. R. 1984. *Cynoglossum officinale* (hound's-tongue) - a cause of pyrrolizidine alkaloid poisoning in horses. J. Am. Vet. Med. Assoc., 185: 647-650.

Notes on Toxic plant chemicals:

The following LD-50 toxicities have been determined in male rats:

heliosupine	60 mg/kg
echinatine	350 mg/kg

The amount of pyrrolizidine alkaloid content in the plant has been reported to be 0.6-2.1% of dry matter (Cheeke and Schull 1985).

Toxic plant chemicals:

echinatine
heliosupine

References:

Cheeke, P. R., Shull, L. R. 1985. Natural toxicants in feeds and poisonous plants. AVI Publishing Company, Inc., Westport, Conn., USA. 492 pp.

Knight, A. P., Kimberling, C. V., Stermitz, F. R., Roby, M. R. 1984. *Cynoglossum officinale* (hound's-tongue) - a cause of pyrrolizidine alkaloid poisoning in horses. J. Am. Vet. Med. Assoc., 185: 647-650.

Animals/Human Poisoning:

Note: When an animal is listed without additional information, the literature (as of 1993) contained no detailed explanation.

Cattle

General symptoms of poisoning:

[death](#)

Notes on poisoning:

Cattle have also been poisoned after ingesting hound's-tongue. The animals often have staring expressions and diarrhea. They experience increased thirst, nervousness, and a drop in milk yield. Necropsy shows an inflamed stomach as well as swollen, edematous mesenteric lymph nodes. Death occurred within 24 h of plant ingestion (Cooper and Johnson 1984, Knight et al. 1984).

References:

Cooper, M. R., Johnson, A. W. 1984. Poisonous plants in Britain and their effects on animals and man. Her Majesty's Stationery Office, London, England. 305 pp.

Horses

General symptoms of poisoning:

[ataxia](#)

[breathing, rapid](#)

[coma](#)

[convulsions](#)

[death](#)

[depression](#)

[diarrhea](#)

[hemoglobinuria](#)

[icterus](#)

[liver, cirrhosis of](#)

[lungs, congestion of](#)

Notes on poisoning:

Actual and experimental cases of hound's-tongue ingestion by horses have resulted in sickness and death. Postmortem examinations show severe icterus and hepatic cirrhosis with diffuse, severe megalocytosis, biliary hyperplasia, and fibrosis (Knight 1984).

References:

Knight, A. P., Kimberling, C. V., Stermitz, F. R., Roby, M. R. 1984. *Cynoglossum officinale* (hound's-tongue) - a cause of pyrrolizidine alkaloid poisoning in horses. J. Am. Vet. Med. Assoc., 185: 647-650.

[Another search?](#)

[Français](#) | [Contact Us](#) | [Help](#) | [Search](#) | [Canada site](#)

[Coming Events](#) | [About CBIF](#) | [Links](#) | [Reports and Publications](#) |

[Home](#)

Date modified: 2003-02-06

[Important Notices](#)



Français	Contact us	Help	Search	Canada site
Coming events	About CBIF	Links	Reports and publications	Home

Canadian Biodiversity Information Facility



Notes on poisoning: hydrangea

[Introduction](#)[Interactive](#)[All poisonous plants by Botanical name](#)[All poisonous plants by Common name](#)[Important WWW Poisonous Plants sites](#)

General poisoning notes:

Hydrangea (*Hydrangea macrophylla*) is an outdoor ornamental that is grown in the warmer parts of Canada. This plant has poisoned humans after they ingested the flower buds. Sensitive individuals can develop dermatitis after exposure to hydrangea. Older case reports of poisoning of horses and cattle appear in the literature, but no recent reports are available (Apted 1973, Bruynzeel 1986, Fuller and McClintock 1986).

References:

Apted, J. H. 1973. Phytodermatitis from hydrangeas. Arch. Dermatol., 108: 427.

Bruynzeel, D. P. 1986. Allergic contact dermatitis to hydrangea. Contact Dermatitis, 14: 128.

Cooper, M. R., Johnson, A. W. 1984. Poisonous plants in Britain and their effects on animals and man. Her Majesty's Stationery Office, London, England. 305 pp.

Fuller, T. C., McClintock, E. 1986. Poisonous plants of California. Univ. California Press, Berkeley, Calif., USA. 432 pp.

Nomenclature:

Scientific Name: *Hydrangea macrophylla* (Thunb.) Ser.

Vernacular name(s): hydrangea

Scientific family name: *Saxifragaceae*

Vernacular family name: saxifrage

Go to ITIS^{*ca} for more taxonomic information on: [Hydrangea macrophylla](#)

References:

Agriculture Quebec. 1975. Noms des maladies des plantes du Canada/ Names of plant diseases in Canada. , Quebec City, Que., Canada. 288 pp.

Alex, J. F., Cayouette, R., Mulligan, G. A. 1980. Common and botanical names of weeds in Canada/Noms populaire et scientifiques des plantes nuisibles du Canada. Revised. Agric. Can. Publ., Ottawa, Ont., Canada. 132 pp.

Bailey, L. H., Bailey, E. Z. 1976. Hortus third. Revised. MacMillan, New York, N.Y., USA. 1290 pp.

Scoggan, H. J. 1978, 1979. The flora of Canada. Nat. Mus. Nat. Sci. (Ottawa) Publ. Bot. 7(1)-7(4). 1711 pp.

Van Wijk, H. L. 1911. A dictionary of plant names. Martinus Nijhoff, The Hague, The Netherlands. 1444 pp.

Victorin, M. 1964. Flore Laurentienne. 2nd ed. Univ. Montreal, Montreal, Que., Canada. 952 pp.

Geographic Information

Plant or plant parts used in or around the home.

References:

Bailey, L. H., Bailey, E. Z. 1976. Hortus third. Revised. MacMillan, New York, N.Y., USA. 1290 pp.

Boivin, B. 1966, 1967. Énumération des plantes du Canada. Provencheria 6. Nat. Can. (Que.) 93: 253-274; 371-437; 583-646; 989-1063. 94: 131-157; 471-528; 625-655.

Image or illustration

hydrangea:

Images: images.google.com

Toxic parts:

flower buds

leaves

References:

Der Marderosian, A. H., Giller, F. B., Roia, F. C. 1976. Phytochemical and toxicological screening of household ornamental plants potentially toxic to humans. 1. J. Toxicol.

Environ. Health, 1: 939-953.

Notes on Toxic plant chemicals:

Hydragin, a cyanogenetic glycoside, is presumed to be responsible for toxicity because it can release hydrocyanic acid upon hydrolysis. Der Marderosian and Roia (1976) administered 3 g of plant extract intraperitoneally, in 10 mL of liquid suspension per 100 g of body weight. All rats died when given extracts from hydrangea flowers and leaves. No mice died when orally fed 100 mg of flower material per 35 g body weight.

Toxic plant chemicals:

hydragin

References:

Der Marderosian, A. H., Giller, F. B., Roia, F. C. 1976. Phytochemical and toxicological screening of household ornamental plants potentially toxic to humans. 1. J. Toxicol. Environ. Health, 1: 939-953.

Lampe, K. F., McCann, M. A. 1985. AMA Handbook of poisonous and injurious plants. American Medical Assoc. Chicago, Ill., USA. 432 pp.

Animals/Human Poisoning:

Note: When an animal is listed without additional information, the literature (as of 1993) contained no detailed explanation.

Cattle

General symptoms of poisoning:

[abdominal pains](#)

[breathing, labored](#)

[diarrhea](#)

References:

Cooper, M. R., Johnson, A. W. 1984. Poisonous plants in Britain and their effects on animals and man. Her Majesty's Stationery Office, London, England. 305 pp.

Horses

General symptoms of poisoning:

[diarrhea](#)

Notes on poisoning:

A horse that ingested hydrangea experienced contraction of the abdominal muscles, diarrhea, and stiffness of limbs (Cooper and Johnson 1984).

References:

Cooper, M. R., Johnson, A. W. 1984. Poisonous plants in Britain and their effects on animals and man. Her Majesty's Stationery Office, London, England. 305 pp.

Humans

General symptoms of poisoning:

[abdominal pains](#)

[coma](#)

[diarrhea](#)

[erythema](#)

[gastroenteritis](#)

[lethargy](#)

[vomiting](#)

Notes on poisoning:

Ingesting hydrangea flower buds has resulted in poisoning (Fuller and McClintock 1986).

References:

Apted, J. H. 1973. Phytodermatitis from hydrangeas. Arch. Dermatol., 108: 427.

Fuller, T. C., McClintock, E. 1986. Poisonous plants of California. Univ. California Press, Berkeley, Calif., USA. 432 pp.

[Another search?](#)

[Français](#) | [Contact Us](#) | [Help](#) | [Search](#) | [Canada site](#)

[Coming Events](#) | [About CBIF](#) | [Links](#) | [Reports and Publications](#) |

[Home](#)

Date modified: 2003-02-06

[Important Notices](#)



Français	Contact us	Help	Search	Canada site
Coming events	About CBIF	Links	Reports and publications	Home

Canadian Biodiversity Information Facility



Notes on poisoning: Iceland poppy

[Introduction](#)

[Interactive](#)

[All poisonous plants by Botanical name](#)

[All poisonous plants by Common name](#)

[Important WWW Poisonous Plants sites](#)

General poisoning notes:

Iceland poppy (*Papaver nudicaule*) is an ornamental outdoor plant that occasionally escapes from cultivation. The plant contains alkaloids that may cause problems in animals that ingest it. Horses, cattle, and sheep were poisoned when discarded plants were given to livestock (Cooper and Johnson 1984).



References:

Cooper, M. R., Johnson, A. W. 1984. Poisonous plants in Britain and their effects on animals and man. Her Majesty's Stationery Office, London, England. 305 pp.

Kingsbury, J. M. 1964. Poisonous plants of the United States and Canada. Prentice-Hall Inc., Englewood Cliffs, N.J., USA. 626 pp.

Nomenclature:

Scientific Name: *Papaver nudicaule* L.

Vernacular name(s): Iceland poppy

Scientific family name: *Papaveraceae*

Vernacular family name: poppy

Go to ITIS^{*ca} for more taxonomic information on: [Papaver nudicaule](#)

References:

Agriculture Quebec. 1975. Noms des maladies des plantes du Canada/ Names of plant diseases in Canada. , Quebec City, Que., Canada. 288 pp.

Alex, J. F., Cayouette, R., Mulligan, G. A. 1980. Common and

botanical names of weeds in Canada/Noms populaire et scientifiques des plantes nuisibles du Canada. Revised. Agric. Can. Publ., Ottawa, Ont., Canada. 132 pp.

Bailey, L. H., Bailey, E. Z. 1976. Hortus third. Revised. MacMillan, New York, N.Y., USA. 1290 pp.

Scoggan, H. J. 1978, 1979. The flora of Canada. Nat. Mus. Nat. Sci. (Ottawa) Publ. Bot. 7(1)-7(4). 1711 pp.

Van Wijk, H. L. 1911. A dictionary of plant names. Martinus Nijhoff, The Hague, The Netherlands. 1444 pp.

Victorin, M. 1964. Flore Laurentienne. 2nd ed. Univ. Montreal, Montreal, Que., Canada. 952 pp.

Geographic Information

Plant or plant parts used in or around the home.

References:

Bailey, L. H., Bailey, E. Z. 1976. Hortus third. Revised. MacMillan, New York, N.Y., USA. 1290 pp.

Boivin, B. 1966, 1967. Énumération des plantes du Canada. Provencheria 6. Nat. Can. (Que.) 93: 253-274; 371-437; 583-646; 989-1063. 94: 131-157; 471-528; 625-655.

Image or illustration

Iceland poppy:

Images: images.google.com

Toxic parts:

all parts
plant juices

References:

Kingsbury, J. M. 1964. Poisonous plants of the United States and Canada. Prentice-Hall Inc., Englewood Cliffs, N.J., USA. 626 pp.

Notes on Toxic plant chemicals:

Physiological alkaloids have been found in Iceland poppy (Kingsbury 1964).

Toxic plant chemicals:

unknown chemical

References:

Kingsbury, J. M. 1964. Poisonous plants of the United States and Canada. Prentice-Hall Inc., Englewood Cliffs, N.J., USA. 626 pp.

Animals/Human Poisoning:

Note: When an animal is listed without additional information, the literature (as of 1993) contained no detailed explanation.

Cattle

General symptoms of poisoning:

[bloat](#)

[incoordination](#)

[muscle spasms](#)

[muscle twitching](#)

[nervousness](#)

[recumbency](#)

[restlessness](#)

Notes on poisoning:

Symptoms are similar in all species that have been poisoned, including initial restlessness and excitement followed by incoordination, spasms, falling, and bloat in some cases. Milk yield may be reduced (Cooper and Johnson 1984).

References:

Cooper, M. R., Johnson, A. W. 1984. Poisonous plants in Britain and their effects on animals and man. Her Majesty's Stationery Office, London, England. 305 pp.

Horses

General symptoms of poisoning:

[bloat](#)

[incoordination](#)

[muscle spasms](#)

[muscle twitching](#)

[nervousness](#)

[recumbency](#)

Notes on poisoning:

Symptoms of poisoning include restlessness, incoordination, stiffness, muscular twitching, falling, and bloat. This poppy has rarely proved fatal (Cooper and Johnson 1984).

References:

Cooper, M. R., Johnson, A. W. 1984. Poisonous plants in Britain and their effects on animals and man. Her Majesty's Stationery Office, London, England. 305 pp.

Sheep

General symptoms of poisoning:

[bloat](#)

[incoordination](#)

[muscle spasms](#)

[nervousness](#)

[recumbency](#)

Notes on poisoning:

Symptoms include restlessness, incoordination, muscular twitching, and falling down. Milk yield can remain depressed for long periods (Cooper and Johnson 1984).

References:

Cooper, M. R., Johnson, A. W. 1984. Poisonous plants in Britain and their effects on animals and man. Her Majesty's Stationery Office, London, England. 305 pp.

[Another search?](#)

[Français](#) | [Contact Us](#) | [Help](#) | [Search](#) | [Canada site](#)

[Coming Events](#) | [About CBIF](#) | [Links](#) | [Reports and Publications](#) |

[Home](#)

Date modified: 2003-02-06

[Important Notices](#)



Français	Contact us	Help	Search	Canada site
Coming events	About CBIF	Links	Reports and publications	Home

Canadian Biodiversity Information Facility



Notes on poisoning: Indian mustard

[Introduction](#)[Interactive](#)[All poisonous plants by Botanical name](#)[All poisonous plants by Common name](#)[Important WWW Poisonous Plants sites](#)

General poisoning notes:

Indian mustard (*Brassica juncea*) is a naturalized herb found across much of Canada. This plant can contain large quantities of toxins that are common to the genus *Brassica*. Many of these compounds are being reduced through plant breeding. See the comments under sections of *Brassica oleracea*, which include a discussion of problems in relation to this genus.

References:



Fenwick, G. R., Heaney, R. K., Mawson, R. 1989. Glucosinolates. Pages 1-41 in Cheeke, P. R., ed. Toxicants of plant origin. Vol. II. Glycosides. CRC Press, Inc., Boca Raton, Fla., USA. 277 pp.

Kernaleguen, A., Smith, R. A., Yong, C. W. 1989. Acute mustard seed toxicosis in beef cattle. Can. Vet. J., 30: 524.

Nomenclature:

Scientific Name: *Brassica juncea* (L.) Czern.

Vernacular name(s): Indian mustard

Scientific family name: *Cruciferae*

Vernacular family name: mustard

Go to ITIS*^{ca} for more taxonomic information on: [Brassica juncea](#)

References:

Agriculture Quebec. 1975. Noms des maladies des plantes du Canada/ Names of plant diseases in Canada. , Quebec City, Que., Canada. 288 pp.

Alex, J. F., Cayouette, R., Mulligan, G. A. 1980. Common and

botanical names of weeds in Canada/Noms populaire et scientifiques des plantes nuisibles du Canada. Revised. Agric. Can. Publ., Ottawa, Ont., Canada. 132 pp.

Bailey, L. H., Bailey, E. Z. 1976. Hortus third. Revised. MacMillan, New York, N.Y., USA. 1290 pp.

Scoggan, H. J. 1978, 1979. The flora of Canada. Nat. Mus. Nat. Sci. (Ottawa) Publ. Bot. 7(1)-7(4). 1711 pp.

Van Wijk, H. L. 1911. A dictionary of plant names. Martinus Nijhoff, The Hague, The Netherlands. 1444 pp.

Victorin, M. 1964. Flore Laurentienne. 2nd ed. Univ. Montreal, Montreal, Que., Canada. 952 pp.

Geographic Information

Alberta
British Columbia
Newfoundland
Northwest Territories
Ontario
Quebec
Saskatchewan

References:

Bailey, L. H., Bailey, E. Z. 1976. Hortus third. Revised. MacMillan, New York, N.Y., USA. 1290 pp.

Boivin, B. 1966, 1967. Énumération des plantes du Canada. Provencheria 6. Nat. Can. (Que.) 93: 253-274; 371-437; 583-646; 989-1063. 94: 131-157; 471-528; 625-655.

Image or illustration

Indian mustard:

Images: images.google.com

Toxic parts:

leaves
seeds

References:

Fenwick, G. R., Heaney, R. K., Mawson, R. 1989. Glucosinolates. Pages 1-41 in Cheeke, P. R., ed. Toxicants of plant origin. Vol. II. Glycosides. CRC Press, Inc., Boca Raton, Fla., USA. 277 pp.

Toxic plant chemicals:

glucosinolates

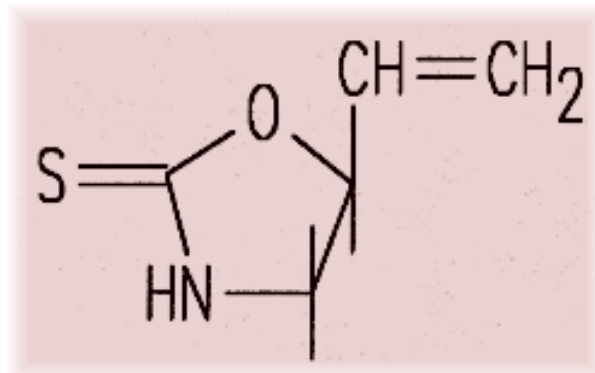

glucosinolates

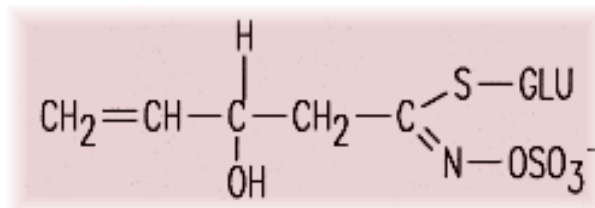

glucosinolates

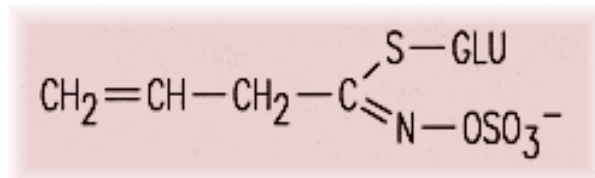

S-methyl-L-cysteine sulfoxide (SMCO)

Chemical diagram(s) are courtesy of [Ruth McDiarmid](#), Biochemistry Technician, Kamloops Range Station, Agriculture and Agri-Food Canada, Kamloops, British Columbia, Canada.

References:

Fenwick, G. R., Heaney, R. K., Mawson, R. 1989. Glucosinolates. Pages 1-41 in Cheeke, P. R., ed. Toxicants of plant origin. Vol. II. Glycosides. CRC Press, Inc., Boca Raton, Fla., USA. 277 pp.

Animals/Human Poisoning:

Note: When an animal is listed without additional information, the literature (as of 1993) contained no detailed explanation.

Cattle

General symptoms of poisoning:

[abortion](#)

[death](#)

[dehydration](#)

[gait, staggering](#)

Notes on poisoning:

In one case in Saskatchewan, a herd of cattle gained access to waste mustard seed. Six cows died and two were ill. Symptoms included depression, staggering, and reluctance to move. Several cows aborted, but most showed clinical signs of sickness. Postmortem findings revealed profuse edema of the forestomachs and abomasum. A 2-3 cm layer of clear, yellowish, gelatinous fluid was present under the serosa of the rumen, reticulum, and omasum. Allylisoithiocyanate at a rate of 1000 mg/100 mL was liberated from the seeds. A rate of 250 mg/100 mL is regarded as acutely toxic to cattle (Kernaleguen et al. 1989).

References:

Kernaleguen, A., Smith, R. A., Yong, C. W. 1989. Acute mustard seed toxicosis in beef cattle. *Can. Vet. J.*, 30: 524.

Swine

[Another search?](#)

[Français](#) | [Contact Us](#) | [Help](#) | [Search](#) | [Canada site](#)

[Coming Events](#) | [About CBIF](#) | [Links](#) | [Reports and Publications](#) |

[Home](#)

Date modified: 2003-02-06

[Important Notices](#)



Français	Contact us	Help	Search	Canada site
Coming events	About CBIF	Links	Reports and publications	Home

Canadian Biodiversity Information Facility



Notes on poisoning: Indian-tobacco

[Introduction](#)

[Interactive](#)

[All poisonous plants by Botanical name](#)

[All poisonous plants by Common name](#)

[Important WWW Poisonous Plants sites](#)



General poisoning notes:

Indian-tobacco (*Lobelia inflata*) is a herb native to Canada. In the past, aboriginal people smoked its dried leaves. This plant and related *Lobelia* species were used as medicinal plants. Overdoses led to cases of poisoning, which resulted in fatalities. No modern cases of poisoning are found in the literature. The dried leaves of *Lobelia* may be found in health food stores as a herbal medicine (Lampe and McCann 1985).

References:

Lampe, K. F., McCann, M. A. 1985. AMA Handbook of poisonous and injurious plants. American Medical Assoc. Chicago, Ill., USA. 432 pp.

Nomenclature:

Scientific Name: *Lobelia inflata* L.

Vernacular name(s): Indian-tobacco

Scientific family name: *Campanulaceae*

Vernacular family name: bellflower

Go to ITIS^{*ca} for more taxonomic information on: [Lobelia inflata](#)

References:

Agriculture Quebec. 1975. Noms des maladies des plantes du Canada/ Names of plant diseases in Canada. , Quebec City, Que., Canada. 288 pp.

Alex, J. F., Cayouette, R., Mulligan, G. A. 1980. Common and botanical names of weeds in Canada/Noms populaire et scientifiques des plantes nuisibles du Canada. Revised. Agric.

Can. Publ., Ottawa, Ont., Canada. 132 pp.

Bailey, L. H., Bailey, E. Z. 1976. Hortus third. Revised. MacMillan, New York, N.Y., USA. 1290 pp.

Scoggan, H. J. 1978, 1979. The flora of Canada. Nat. Mus. Nat. Sci. (Ottawa) Publ. Bot. 7(1)-7(4). 1711 pp.

Van Wijk, H. L. 1911. A dictionary of plant names. Martinus Nijhoff, The Hague, The Netherlands. 1444 pp.

Victorin, M. 1964. Flore Laurentienne. 2nd ed. Univ. Montreal, Montreal, Que., Canada. 952 pp.

Geographic Information

British Columbia

New Brunswick

Nova Scotia

Ontario

Prince Edward Island

Quebec

References:

Bailey, L. H., Bailey, E. Z. 1976. Hortus third. Revised. MacMillan, New York, N.Y., USA. 1290 pp.

Boivin, B. 1966, 1967. Énumération des plantes du Canada. Provencheria 6. Nat. Can. (Que.) 93: 253-274; 371-437; 583-646; 989-1063. 94: 131-157; 471-528; 625-655.

Image or illustration

Indian-tobacco:

Images: images.google.com

Toxic parts:

leaves

stems

References:

Lampe, K. F., McCann, M. A. 1985. AMA Handbook of poisonous and injurious plants. American Medical Assoc. Chicago, Ill., USA. 432 pp.

Notes on Toxic plant chemicals:

Lobeline is one of several alkaloids found in Indian-tobacco and other *Lobelia* species. This extract has been used in home medicine for various purposes. Overdoses have resulted in cases of poisoning, including death. The dry leaves of *Lobelia* may be sold in health food stores as a herbal remedy.

Toxic plant chemicals:

lobeline

References:

Lampe, K. F., McCann, M. A. 1985. AMA Handbook of poisonous and injurious plants. American Medical Assoc. Chicago, Ill., USA. 432 pp.

Animals/Human Poisoning:

Note: When an animal is listed without additional information, the literature (as of 1993) contained no detailed explanation.

Humans

General symptoms of poisoning:

[collapse](#)

[coma](#)

[death](#)

[pain](#)

[paralysis](#)

[sweating](#)

[vomiting](#)

Notes on poisoning:

In overdoses of the plant extract, symptoms included vomiting, sweating, pain, paralysis, depressed temperature, rapid but feeble pulse, coma, and death (Kingsbury 1964).

References:

Lampe, K. F., McCann, M. A. 1985. AMA Handbook of poisonous and injurious plants. American Medical Assoc. Chicago, Ill., USA. 432 pp.

[Another search?](#)

[Français](#) | [Contact Us](#) | [Help](#) | [Search](#) | [Canada site](#)
[Coming Events](#) | [About CBIF](#) | [Links](#) | [Reports and Publications](#) |
[Home](#)

Date modified: 2003-02-06

[Important Notices](#)



Français	Contact us	Help	Search	Canada site
Coming events	About CBIF	Links	Reports and publications	Home

Canadian Biodiversity Information Facility



Notes on poisoning: Jack-in-the-pulpit

[Introduction](#)[Interactive](#)[All poisonous plants by Botanical name](#)[All poisonous plants by Common name](#)[Important WWW Poisonous Plants sites](#)

General poisoning notes:

Jack-in-the-pulpit (*Arisaema triphyllum*) is a native plant found in wet soils in parts of eastern Canada. The plant contains calcium oxalate raphide crystals, as do many other members of the family Araceae. When ingested, these crystals can cause severe pain and burning in the lips, mouth, and throat (Lampe and McCann 1985).

References:

Lampe, K. F., McCann, M. A. 1985. AMA Handbook of poisonous and injurious plants. American Medical Assoc. Chicago, Ill., USA. 432 pp.

Muenschler, W. C. 1975. Poisonous plants of the United States. Revised. Collier Books, New York, N.Y., USA. 277 pp.

Nomenclature:

Scientific Name: *Arisaema triphyllum* (L.) Torr.

Vernacular name(s): Jack-in-the-pulpit

Scientific family name: *Araceae*

Vernacular family name: arum

Go to ITIS*^{ca} for more taxonomic information on: [Arisaema triphyllum](#)

References:

Agriculture Quebec. 1975. Noms des maladies des plantes du Canada/ Names of plant diseases in Canada. , Quebec City, Que., Canada. 288 pp.

Alex, J. F., Cayouette, R., Mulligan, G. A. 1980. Common and

botanical names of weeds in Canada/Noms populaire et scientifiques des plantes nuisibles du Canada. Revised. Agric. Can. Publ., Ottawa, Ont., Canada. 132 pp.

Bailey, L. H., Bailey, E. Z. 1976. Hortus third. Revised. MacMillan, New York, N.Y., USA. 1290 pp.

Scoggan, H. J. 1978, 1979. The flora of Canada. Nat. Mus. Nat. Sci. (Ottawa) Publ. Bot. 7(1)-7(4). 1711 pp.

Van Wijk, H. L. 1911. A dictionary of plant names. Martinus Nijhoff, The Hague, The Netherlands. 1444 pp.

Victorin, M. 1964. Flore Laurentienne. 2nd ed. Univ. Montreal, Montreal, Que., Canada. 952 pp.

Geographic Information

Manitoba
New Brunswick
Nova Scotia
Ontario
Prince Edward Island
Quebec

References:

Bailey, L. H., Bailey, E. Z. 1976. Hortus third. Revised. MacMillan, New York, N.Y., USA. 1290 pp.

Boivin, B. 1966, 1967. Énumération des plantes du Canada. Provencheria 6. Nat. Can. (Que.) 93: 253-274; 371-437; 583-646; 989-1063. 94: 131-157; 471-528; 625-655.

Image or illustration

Jack-in-the-pulpit:

Images: images.google.com

Toxic parts:

all parts
rhizome

References:

Lampe, K. F., McCann, M. A. 1985. AMA Handbook of poisonous and injurious plants. American Medical Assoc. Chicago, Ill., USA. 432 pp.

Toxic plant chemicals:

oxalate

References:

Lampe, K. F., McCann, M. A. 1985. AMA Handbook of poisonous and injurious plants. American Medical Assoc. Chicago, Ill., USA. 432 pp.

Animals/Human Poisoning:

Note: When an animal is listed without additional information, the literature (as of 1993) contained no detailed explanation.

Humans

General symptoms of poisoning:

[salivation](#)

Notes on poisoning:

Ingesting Jack-in-the-pulpit causes a burning sensation, with associated inflammation, edema, and salivation. Treatment includes cool liquids held in the mouth to provide relief. The oxalates are insoluble and do not cause systemic poisoning in plants (Lampe and McCann 1985).

References:

Lampe, K. F., McCann, M. A. 1985. AMA Handbook of poisonous and injurious plants. American Medical Assoc. Chicago, Ill., USA. 432 pp.

[Another search?](#)

[Français](#) | [Contact Us](#) | [Help](#) | [Search](#) | [Canada site](#)

[Coming Events](#) | [About CBIF](#) | [Links](#) | [Reports and Publications](#) |

[Home](#)

Date modified: 2003-02-06

[Important Notices](#)



Français	Contact us	Help	Search	Canada site
Coming events	About CBIF	Links	Reports and publications	Home

Canadian Biodiversity Information Facility



Notes on poisoning: Japanese wisteria

[Introduction](#)

[Interactive](#)

[All poisonous plants by Botanical name](#)

[All poisonous plants by Common name](#)

[Important WWW Poisonous Plants sites](#)



General poisoning notes:

Japanese wisteria (*Wisteria floribunda*) is an ornamental vine that is grown for its beautiful flowers. This plant is restricted to the warmer parts of Canada, such as southern Ontario and Vancouver Island. With care, the vine successfully overwinters in Ottawa, Ont. All parts of the plant are toxic, especially the seeds. Ingesting 1-2 seeds can cause serious poisoning in a child. However, no fatalities have been reported in the literature. Another plant in the same genus, Chinese wisteria (*Wisteria sinensis* (Sims) Sweet), may also be capable of surviving in southern Canada (Anon. 1961, Lampe and McCann 1985).

References:

Anon. 1961. *Wisteria*. Natl. Clgh. Poison Control Cent., July-Aug: 1-2.

Lampe, K. F., McCann, M. A. 1985. AMA Handbook of poisonous and injurious plants. American Medical Assoc. Chicago, Ill., USA. 432 pp.

Nomenclature:

Scientific Name: *Wisteria floribunda* (Willd.) DC.

Vernacular name(s): Japanese wisteria

Scientific family name: *Leguminosae*

Vernacular family name: pea

Go to ITIS*^{ca} for more taxonomic information on: [Wisteria floribunda](#)

References:

Agriculture Quebec. 1975. Noms des maladies des plantes du Canada/ Names of plant diseases in Canada. , Quebec City, Que., Canada. 288 pp.

Alex, J. F., Cayouette, R., Mulligan, G. A. 1980. Common and botanical names of weeds in Canada/Noms populaire et scientifiques des plantes nuisibles du Canada. Revised. Agric. Can. Publ., Ottawa, Ont., Canada. 132 pp.

Bailey, L. H., Bailey, E. Z. 1976. Hortus third. Revised. MacMillan, New York, N.Y., USA. 1290 pp.

Scoggan, H. J. 1978, 1979. The flora of Canada. Nat. Mus. Nat. Sci. (Ottawa) Publ. Bot. 7(1)-7(4). 1711 pp.

Van Wijk, H. L. 1911. A dictionary of plant names. Martinus Nijhoff, The Hague, The Netherlands. 1444 pp.

Victorin, M. 1964. Flore Laurentienne. 2nd ed. Univ. Montreal, Montreal, Que., Canada. 952 pp.

Geographic Information

Plant or plant parts used in or around the home.

References:

Bailey, L. H., Bailey, E. Z. 1976. Hortus third. Revised. MacMillan, New York, N.Y., USA. 1290 pp.

Boivin, B. 1966, 1967. Énumération des plantes du Canada. Provencheria 6. Nat. Can. (Que.) 93: 253-274; 371-437; 583-646; 989-1063. 94: 131-157; 471-528; 625-655.

Image or illustration

Japanese wisteria:

Images: images.google.com

Notes on Poisonous plant parts:

All parts of the plant, including the flowers, are toxic. The seeds are especially toxic (Lampe and McCann 1985).

Toxic parts:

all parts
flowers

leaves

seeds

References:

Lampe, K. F., McCann, M. A. 1985. AMA Handbook of poisonous and injurious plants. American Medical Assoc. Chicago, Ill., USA. 432 pp.

Notes on Toxic plant chemicals:

A glycoside, wistarine, has been found in the plant. It also contains a poisonous lectin (Lampe and McCann 1985).

Toxic plant chemicals:

wistarine

References:

Anon. 1961. *Wisteria*. Natl. Clgh. Poison Control Cent., July-Aug: 1-2.

Lampe, K. F., McCann, M. A. 1985. AMA Handbook of poisonous and injurious plants. American Medical Assoc. Chicago, Ill., USA. 432 pp.

Animals/Human Poisoning:

Note: When an animal is listed without additional information, the literature (as of 1993) contained no detailed explanation.

Humans

General symptoms of poisoning:

[abdominal pains](#)

[collapse](#)

[dehydration](#)

[diarrhea](#)

[nausea](#)

[vomiting](#)

Notes on poisoning:

Humans who ingest wisteria exhibited the following symptoms: nausea, vomiting, diarrhea, abdominal pain, and dehydration. Ingesting 1-2 seeds caused serious poisoning in a young adult. Patients usually recover in 1-2 days. Treatment includes

induction of emesis, followed by supportive treatments with antiemetics and fluid replacement (Anon. 1961, Lampe and McCann 1985).

References:

Anon. 1961. *Wisteria*. Natl. Clgh. Poison Control Cent., July-Aug: 1-2.

Lampe, K. F., McCann, M. A. 1985. AMA Handbook of poisonous and injurious plants. American Medical Assoc. Chicago, Ill., USA. 432 pp.

[Another search?](#)

[Français](#) | [Contact Us](#) | [Help](#) | [Search](#) | [Canada site](#)

[Coming Events](#) | [About CBIF](#) | [Links](#) | [Reports and Publications](#) |

[Home](#)

Date modified: 2003-02-06

[Important Notices](#)



Français	Contact us	Help	Search	Canada site
Coming events	About CBIF	Links	Reports and publications	Home

Canadian Biodiversity Information Facility



Notes on poisoning: Japanese yew

[Introduction](#)

[Interactive](#)

[All poisonous plants by Botanical name](#)

[All poisonous plants by Common name](#)

[Important WWW Poisonous Plants sites](#)



General poisoning notes:

Japanese yew (*Taxus cuspidata*) is an outdoor ornamental that is winter-hardy across southern Canada. This shrub contains toxic quantities of the alkaloid taxine. Cattle and horses became ill and died after ingesting the leaves and twigs of Japanese yew. In two cases in Ontario, several cattle died after gaining access to shrubs around houses or after being given hedge trimmings (Alden et al. 1977, Thomson and Barker 1978).

References:

Alden, C. L., Fosnaugh, C. J., Smith, J. B., Mohan, R. 1977. Japanese yew poisoning of large domestic animals in the midwest. J. Am. Vet. Med. Assoc., 170: 314-316.

Ogden, L. 1988. *Taxus* (yews) - a highly toxic plant. Vet. Hum. Toxicol., 30: 563-564.

Thomson, G. W., Barker, I. K. 1978. Japanese yew (*Taxus cuspidata*) poisoning in cattle. Can. Vet. J., 19: 320-321.

Veatch, J. K., Reid, F. M., Kennedy, G. A. 1988. Differentiating yew poisoning from other toxicoses. Vet. Med., 83: 298-300.

Nomenclature:

Scientific Name: *Taxus cuspidata* Siebold & Zucc.

References:

Agriculture Quebec. 1975. Noms des maladies des plantes du Canada/ Names of plant diseases in Canada. , Quebec City, Que., Canada. 288 pp.

Alex, J. F., Cayouette, R., Mulligan, G. A. 1980. Common and botanical names of weeds in Canada/Noms populaire et

scientifiques des plantes nuisibles du Canada. Revised. Agric. Can. Publ., Ottawa, Ont., Canada. 132 pp.

Bailey, L. H., Bailey, E. Z. 1976. Hortus third. Revised. MacMillan, New York, N.Y., USA. 1290 pp.

Scoggan, H. J. 1978, 1979. The flora of Canada. Nat. Mus. Nat. Sci. (Ottawa) Publ. Bot. 7(1)-7(4). 1711 pp.

Van Wijk, H. L. 1911. A dictionary of plant names. Martinus Nijhoff, The Hague, The Netherlands. 1444 pp.

Victorin, M. 1964. Flore Laurentienne. 2nd ed. Univ. Montreal, Montreal, Que., Canada. 952 pp.

Geographic Information

Plant or plant parts used in or around the home.

References:

Bailey, L. H., Bailey, E. Z. 1976. Hortus third. Revised. MacMillan, New York, N.Y., USA. 1290 pp.

Boivin, B. 1966, 1967. Énumération des plantes du Canada. Provencheria 6. Nat. Can. (Que.) 93: 253-274; 371-437; 583-646; 989-1063. 94: 131-157; 471-528; 625-655.

Image or illustration

Japanese yew:

Images: images.google.com

Notes on Poisonous plant parts:

Leaves, twigs, and seeds are toxic. Only the red arils, the fleshy outer parts of the fruits, are considered nontoxic (Ogden 1988).

Toxic parts:

leaves
seeds
twigs

References:

Ogden, L. 1988. *Taxus* (yews) - a highly toxic plant. Vet. Hum. Toxicol., 30: 563-564.

Notes on Toxic plant chemicals:

Taxine (taxin) is a complex mixture of alkaloids that is rapidly absorbed from the digestive tract and interferes with heart action (Feldman et al. 1987).

Toxic plant chemicals:

taxine

References:

Feldman, R., Szajewski, J. M., Chrobak, J., Liberek, Z. M. 1987. Four cases of self-poisoning with yew leaves decoction. *Vet. Hum. Toxicol.*, 29: 72.

Lampe, K. F., McCann, M. A. 1985. *AMA Handbook of poisonous and injurious plants*. American Medical Assoc. Chicago, Ill., USA. 432 pp.

Animals/Human Poisoning:

Note: When an animal is listed without additional information, the literature (as of 1993) contained no detailed explanation.

Cattle

General symptoms of poisoning:

[death](#)

References:

Ogden, L. 1988. *Taxus* (yews) - a highly toxic plant. *Vet. Hum. Toxicol.*, 30: 563-564.

Veatch, J. K., Reid, F. M., Kennedy, G. A. 1988. Differentiating yew poisoning from other toxicoses. *Vet. Med.*, 83: 298-300.

[Another search?](#)

[Français](#) | [Contact Us](#) | [Help](#) | [Search](#) | [Canada site](#)

[Coming Events](#) | [About CBIF](#) | [Links](#) | [Reports and Publications](#) |

[Home](#)

Date modified: 2003-02-06

[Important Notices](#)



Français	Contact us	Help	Search	Canada site
Coming events	About CBIF	Links	Reports and publications	Home



Notes on poisoning: Jerusalem-cherry

[Introduction](#)

[Interactive](#)

[All poisonous plants by Botanical name](#)

[All poisonous plants by Common name](#)

[Important WWW Poisonous Plants sites](#)



General poisoning notes:

Jerusalem-cherry (*Solanum pseudocapsicum*) is an indoor ornamental grown for its colorful berries. This plant contains an alkaloid, solanocapsine, that is related to solanine. Experiments have shown that the chemical can cause death, although it is unlikely because oral absorption of the toxin is minimal. Experiments with cats and rats have shown that oral ingesting leaves and berries has not caused severe symptoms. By extrapolation, children or family pets that ingest moderate amounts of leaf or berry material may experience mild gastroenteritis and vomiting (Der Marderosian et al. 1976, Spoerke and Smolinske 1990).

References:

- Der Marderosian, A. H., Giller, F. B., Roia, F. C. 1976. Phytochemical and toxicological screening of household ornamental plants potentially toxic to humans. 1. J. Toxicol. Environ. Health, 1: 939-953.
- Spoerke, D. G., Smolinske, S. C. 1990. Toxicity of houseplants. CRC Press, Inc., Boca Raton, Fla., USA. 335 pp.

Nomenclature:

Scientific Name: *Solanum pseudocapsicum* L.

Vernacular name(s): Jerusalem-cherry

Scientific family name: *Solanaceae*

Vernacular family name: nightshade

Go to ITIS*^{ca} for more taxonomic information on: [Solanum pseudocapsicum](#)

References:

Agriculture Quebec. 1975. Noms des maladies des plantes du Canada/ Names of plant diseases in Canada. , Quebec City, Que., Canada. 288 pp.

Alex, J. F., Cayouette, R., Mulligan, G. A. 1980. Common and botanical names of weeds in Canada/Noms populaire et scientifiques des plantes nuisibles du Canada. Revised. Agric. Can. Publ., Ottawa, Ont., Canada. 132 pp.

Bailey, L. H., Bailey, E. Z. 1976. Hortus third. Revised. MacMillan, New York, N.Y., USA. 1290 pp.

Scoggan, H. J. 1978, 1979. The flora of Canada. Nat. Mus. Nat. Sci. (Ottawa) Publ. Bot. 7(1)-7(4). 1711 pp.

Van Wijk, H. L. 1911. A dictionary of plant names. Martinus Nijhoff, The Hague, The Netherlands. 1444 pp.

Victorin, M. 1964. Flore Laurentienne. 2nd ed. Univ. Montreal, Montreal, Que., Canada. 952 pp.

Geographic Information

Plant or plant parts used in or around the home.

References:

Bailey, L. H., Bailey, E. Z. 1976. Hortus third. Revised. MacMillan, New York, N.Y., USA. 1290 pp.

Boivin, B. 1966, 1967. Énumération des plantes du Canada. Provencheria 6. Nat. Can. (Que.) 93: 253-274; 371-437; 583-646; 989-1063. 94: 131-157; 471-528; 625-655.

Image or illustration

Jerusalem-cherry:

Images: images.google.com

Notes on Poisonous plant parts:

In experiments, extracts of the unripe and ripe berries have caused deaths in rats; the doses were very high and were given intraperitoneally. However, rats that ingested leaves did not die. Humans who ingest berries probably experience only mild gastrointestinal effects (Spoerke and Smolinske 1990).

Toxic parts:

immature fruit
leaves
mature fruit

References:

Der Marderosian, A. H., Giller, F. B., Roia, F. C. 1976. Phytochemical and toxicological screening of household ornamental plants potentially toxic to humans. 1. J. Toxicol. Environ. Health, 1: 939-953.

Spoerke, D. G., Smolinske, S. C. 1990. Toxicity of houseplants. CRC Press, Inc., Boca Raton, Fla., USA. 335 pp.

Notes on Toxic plant chemicals:

Solanocapsine is an alkaloid that is structurally similar to solanine. It has a similar steroidal skeleton with an additional nitrogen group, but it is not a glycoside. Slowing of frog hearts has been shown with concentrations as low as 1:8 million. Oral absorption is minimal in animals. Rats experimentally injected with extracts from berries of Jerusalem-cherry (intraperitoneally, 3 g/100 g of body weight) resulted in the following fatalities:

- ripe fruit => 3 out of 5 rats killed
- unripe fruit => 4 out of 5 rats killed

These results indicate that death is possible, although the dosages given were very high (Der Marderosian et al. 1976, Spoerke and Smolinske 1990).

Toxic plant chemicals:

solanocapsine

References:

Der Marderosian, A. H., Giller, F. B., Roia, F. C. 1976. Phytochemical and toxicological screening of household ornamental plants potentially toxic to humans. 1. J. Toxicol. Environ. Health, 1: 939-953.

Spoerke, D. G., Smolinske, S. C. 1990. Toxicity of houseplants. CRC Press, Inc., Boca Raton, Fla., USA. 335 pp.

Animals/Human Poisoning:

Note: When an animal is listed without additional information, the literature (as of 1993) contained no detailed explanation.

Cats

General symptoms of poisoning:

[heart rate, slow](#)

Notes on poisoning:

Oral administration of pure solanocapsine has produced only slow heart rate and vomiting. Injection resulted in seizures and death. Oral ingestion of berries or leaves would likely produce only mild gastroenteritis and vomiting (Spoerke and Smolinske 1990).

References:

Der Marderosian, A. H., Giller, F. B., Roia, F. C. 1976. Phytochemical and toxicological screening of household ornamental plants potentially toxic to humans. 1. J. Toxicol. Environ. Health, 1: 939-953.

Spoerke, D. G., Smolinske, S. C. 1990. Toxicity of houseplants. CRC Press, Inc., Boca Raton, Fla., USA. 335 pp.

Humans

General symptoms of poisoning:

[abdominal pains](#)

[gastroenteritis](#)

[vomiting](#)

Notes on poisoning:

Experiments on animals suggest that children who ingest leaf or berry material might suffer only mild gastroenteritis or vomiting. Nevertheless, children should be taught to avoid eating these plants (Spoerke and Smolinske 1990).

References:

Spoerke, D. G., Smolinske, S. C. 1990. Toxicity of houseplants. CRC Press, Inc., Boca Raton, Fla., USA. 335 pp.

[Another search?](#)

[Français](#) | [Contact Us](#) | [Help](#) | [Search](#) | [Canada site](#)

[Coming Events](#) | [About CBIF](#) | [Links](#) | [Reports and Publications](#) |

[Home](#)

Date modified: 2003-02-06

[Important Notices](#)



Français	Contact us	Help	Search	Canada site
Coming events	About CBIF	Links	Reports and publications	Home

Canadian Biodiversity Information Facility



Notes on poisoning: jimsonweed

[Introduction](#)

[Interactive](#)

[All poisonous plants by Botanical name](#)

[All poisonous plants by Common name](#)

[Important WWW Poisonous Plants sites](#)



General poisoning notes:

Jimsonweed (*Datura stramonium*) is a naturalized annual herb found across most of southern Canada. This plant contains toxic tropane alkaloids, which have caused poisoning and death in humans and other animals. Jimsonweed is named for a case of human poisoning in Jamestown, Va., when soldiers were poisoned by eating the plant in a salad and then suffered delirium and hallucinations. The seeds and leaves are deliberately used to induce intoxication. Children are attracted by the large flowers and become poisoned after sucking the nectar from the base of flowers or ingesting the seeds. Occurrences of human poisoning are more frequent than livestock poisoning in recent literature reports. Animals of all types can be poisoned. The literature mentions poisoning of cattle, goats, horses, poultry, sheep, and swine. Because of the plant's strong odor and unpleasant taste, animals consume it only when other food is not available. The seeds are sometimes milled with other seeds and have caused problems (Cooper and Johnson 1984, Cheeke and Schull 1985, Lampe and McCann 1985).

References:

Callahan, R., Piccola, F., Gensheimer, K., Parkin, W. E., Prusakowski, J., Scheiber, G., Henry, S. 1981. Epidemiologic notes and reports. Plant poisonings - New Jersey. U.S. Dep. Health Hum. M. M. W. R., 30: 65-67.

Cheeke, P. R., Shull, L. R. 1985. Natural toxicants in feeds and poisonous plants. AVI Publishing Company, Inc., Westport, Conn., USA. 492 pp.

Cooper, M. R., Johnson, A. W. 1984. Poisonous plants in Britain and their effects on animals and man. Her Majesty's Stationery Office, London, England. 305 pp.

El Dirdiri, N. I., Wasfi, I. A., Adam, S. E., Edds, G. T. 1981.

Toxicity of *Datura stramonium* to sheep and goats. Vet. Hum. Toxicol., 23: 241-246.

Goldberg, R. E. 1951. The jimsonweed menace. Today's Health, 29: 38-39, 66.

Hughes, J. D., Clark, J. A. 1939. *Stramonium* poisoning. J. Am. Med. Assoc., 112: 2500-2502.

Jacobziner, H., Raybin, H. W. 1961. Fatal salicylate intoxication and stramonium poisoning. N. Y. State J. Med., 61: 301-303.

Keeler, R. F. 1981. Absence of arthrogryposis in newborn Hampshire pigs from sows ingesting toxic levels of jimsonweed during gestation. Vet. Hum. Toxicol., 23: 413-415.

Lampe, K. F., McCann, M. A. 1985. AMA Handbook of poisonous and injurious plants. American Medical Assoc. Chicago, Ill., USA. 432 pp.

Mitchell, J. E., Mitchell, F. N. 1955. Jimson weed (*Datura stramonium*) poisoning in childhood. J. Pediatr., 47: 227-230.

Moore, D. W. 1976. The autumnal high: jimsonweed in North Carolina. N. C. Med. J., 37: 492-494.

Nelson, P. D., Mercer, H. D., Essig, H. W., Minyard, J. P. 1982. Jimson weed seed toxicity in cattle. Vet. Hum. Toxicol., 24: 321-325.

Stiles, F. C. 1951. Stramonium poisoning. J. Pediatr., 39: 354-356.

Nomenclature:

Scientific Name: *Datura stramonium* L.

Vernacular name(s): jimsonweed

Scientific family name: *Solanaceae*

Vernacular family name: nightshade

Go to ITIS^{*ca} for more taxonomic information on: [Datura stramonium](#)

References:

Agriculture Quebec. 1975. Noms des maladies des plantes du Canada/ Names of plant diseases in Canada. , Quebec City, Que., Canada. 288 pp.

Alex, J. F., Cayouette, R., Mulligan, G. A. 1980. Common and botanical names of weeds in Canada/Noms populaire et scientifiques des plantes nuisibles du Canada. Revised. Agric.

Can. Publ., Ottawa, Ont., Canada. 132 pp.

Bailey, L. H., Bailey, E. Z. 1976. Hortus third. Revised. MacMillan, New York, N.Y., USA. 1290 pp.

Scoggan, H. J. 1978, 1979. The flora of Canada. Nat. Mus. Nat. Sci. (Ottawa) Publ. Bot. 7(1)-7(4). 1711 pp.

Van Wijk, H. L. 1911. A dictionary of plant names. Martinus Nijhoff, The Hague, The Netherlands. 1444 pp.

Victorin, M. 1964. Flore Laurentienne. 2nd ed. Univ. Montreal, Montreal, Que., Canada. 952 pp.

Geographic Information

Alberta
New Brunswick
Nova Scotia
Ontario
Prince Edward Island
Quebec
Saskatchewan

References:

Bailey, L. H., Bailey, E. Z. 1976. Hortus third. Revised. MacMillan, New York, N.Y., USA. 1290 pp.

Boivin, B. 1966, 1967. Énumération des plantes du Canada. Provencheria 6. Nat. Can. (Que.) 93: 253-274; 371-437; 583-646; 989-1063. 94: 131-157; 471-528; 625-655.

Image or illustration

jimsonweed:

Images: images.google.com

Notes on Poisonous plant parts:

The entire plant contains alkaloids, but the leaves and seeds are the usual sources of poisoning in humans and other animals. Even the nectar of this plant contains alkaloids that contaminate honey (Cooper and Johnson 1984).

Toxic parts:

all parts
flowers
leaves

mature fruit
seeds
stems

References:

- Callahan, R., Piccola, F., Gensheimer, K., Parkin, W. E., Prusakowski, J., Scheiber, G., Henry, S. 1981. Epidemiologic notes and reports. Plant poisonings - New Jersey. U.S. Dep. Health Hum. M. M. W. R., 30: 65-67.
- Cooper, M. R., Johnson, A. W. 1984. Poisonous plants in Britain and their effects on animals and man. Her Majesty's Stationery Office, London, England. 305 pp.
- El Dirdiri, N. I., Wasfi, I. A., Adam, S. E., Edds, G. T. 1981. Toxicity of *Datura stramonium* to sheep and goats. Vet. Hum. Toxicol., 23: 241-246.
- Hughes, J. D., Clark, J. A. 1939. *Stramonium* poisoning. J. Am. Med. Assoc., 112: 2500-2502.
- Jacobziner, H., Raybin, H. W. 1961. Fatal salicylate intoxication and stramonium poisoning. N. Y. State J. Med., 61: 301-303.
- Keeler, R. F. 1981. Absence of arthrogryposis in newborn Hampshire pigs from sows ingesting toxic levels of jimsonweed during gestation. Vet. Hum. Toxicol., 23: 413-415.
- Mitchell, J. E., Mitchell, F. N. 1955. Jimson weed (*Datura stramonium*) poisoning in childhood. J. Pediatr., 47: 227-230.
- Nelson, P. D., Mercer, H. D., Essig, H. W., Minyard, J. P. 1982. Jimson weed seed toxicity in cattle. Vet. Hum. Toxicol., 24: 321-325.
- Stiles, F. C. 1951. Stramonium poisoning. J. Pediatr., 39: 354-356.

Notes on Toxic plant chemicals:

Several tropane alkaloids including hyoscyamine, hyoscine (also called scopolamine), and traces of atropine are found in the plant. The total alkaloid content in the plant varies from 0.25 to 0.7%. The alkaloids are found even in the nectar and can contaminate honey (Cooper and Johnson 1984, Cheeke and Schull 1985).

Toxic plant chemicals:

atropine
hyoscine(scopolamine)
hyoscyamine

References:

- Cheeke, P. R., Shull, L. R. 1985. Natural toxicants in feeds and poisonous plants. AVI Publishing Company, Inc., Westport, Conn., USA. 492 pp.
- Cooper, M. R., Johnson, A. W. 1984. Poisonous plants in Britain and their effects on animals and man. Her Majesty's Stationery Office, London, England. 305 pp.
- Jacobziner, H., Raybin, H. W. 1961. Fatal salicylate intoxication and stramonium poisoning. N. Y. State J. Med., 61: 301-303.
- Keeler, R. F. 1981. Absence of arthrogryposis in newborn Hampshire pigs from sows ingesting toxic levels of jimsonweed during gestation. Vet. Hum. Toxicol., 23: 413-415.
- Moore, D. W. 1976. The autumnal high: jimsonweed in North Carolina. N. C. Med. J., 37: 492-494.
- Nelson, P. D., Mercer, H. D., Essig, H. W., Minyard, J. P. 1982. Jimson weed seed toxicity in cattle. Vet. Hum. Toxicol., 24: 321-325.

Animals/Human Poisoning:

Note: When an animal is listed without additional information, the literature (as of 1993) contained no detailed explanation.

Cattle

General symptoms of poisoning:

[anorexia](#)

[bloat](#)

[muzzle, dry](#)

[pupils, pinpoint](#)

[tenesmus](#)

Notes on poisoning:

Symptoms in cattle include incoordination, restlessness, and increased respiration rate. Nelson et al. (1982) conducted feeding experiments on heifers that were fed a normal diet with varying amounts of jimsonweed seeds added. The seeds contained 0.26% atropine and 0.55% hyoscyne. Death of cattle seemed unlikely because rumen atony and anorexia limited intake of the feed to below lethal levels. The toxic dosage is about 2.9 mg of atropine and 0.5 mg of hyoscyne per kilogram of body weight, which is about 107 seeds per kilogram of body weight.

References:

Cheeke, P. R., Shull, L. R. 1985. Natural toxicants in feeds and poisonous plants. AVI Publishing Company, Inc., Westport, Conn., USA. 492 pp.

Nelson, P. D., Mercer, H. D., Essig, H. W., Minyard, J. P. 1982. Jimson weed seed toxicity in cattle. *Vet. Hum. Toxicol.*, 24: 321-325.

Chickens

General symptoms of poisoning:

[weight gain, reduced](#)

References:

Cheeke, P. R., Shull, L. R. 1985. Natural toxicants in feeds and poisonous plants. AVI Publishing Company, Inc., Westport, Conn., USA. 492 pp.

Goats

General symptoms of poisoning:

[breathing, rapid](#)

[death](#)

[drowsiness](#)

[incoordination](#)

[recumbency](#)

[reflex excitability](#)

[trembling](#)

[water intake, reduced](#)

Notes on poisoning:

Goats have been poisoned by consuming jimsonweed. Experimental feeding of fresh leaves and fruit caused locomotion disturbances, tremors, drowsiness, and recumbency. Postmortem findings showed lung congestion, hemorrhagic and fatty liver, and heart dilation with hemorrhaging. The renal cortex was pale yellow and the medulla hemorrhagic. The cells of many renal tubes had also degenerated (El Dirdiri et al. 1981).

References:

El Dirdiri, N. I., Wasfi, I. A., Adam, S. E., Edds, G. T. 1981. Toxicity of *Datura stramonium* to sheep and goats. *Vet. Hum. Toxicol.*, 23: 241-246.

Horses

General symptoms of poisoning:

[anorexia](#)

[breathing, rapid](#)

[diarrhea](#)

[heart rate, elevated](#)

[pupil dilation](#)

[thirsty](#)

References:

Cheeke, P. R., Shull, L. R. 1985. Natural toxicants in feeds and poisonous plants. AVI Publishing Company, Inc., Westport, Conn., USA. 492 pp.

Humans

General symptoms of poisoning:

[agitation](#)

[babinski reflex](#)

[choreiform movement](#)

[confusion](#)

[convulsions](#)

[death](#)

[dizziness](#)

[drowsiness](#)

[faintness](#)

[gait, unsteady](#)

[hallucination](#)

[heart rate, elevated](#)

[inebriation](#)

[memory loss](#)

[mouth dry](#)

[nausea](#)

[pupil dilation](#)

[reflex excitability](#)

[skin, dry](#)

[skin, flushed](#)

[speech, slurred](#)

[temperature, elevated](#)

[thirsty](#)

[unconsciousness](#)

[urination, absent](#)

[vision, impaired](#)

Notes on poisoning:

Symptoms of *Datura* species poisoning include dry mouth, mydriasis, dry and warm skin, sometimes with reddening of the face and neck. Hallucinations are common, along with blurred vision, random movements, nausea, delirium, and sometimes coma and death. Tachycardia and elevated temperatures occur. Treatment with physostigmine is recommended at 0.5 mg for children and 2 mg for adults (Moore 1976, Cooper and Johnson 1984, Lampe and McCann 1985).

References:

- Callahan, R., Piccola, F., Gensheimer, K., Parkin, W. E., Prusakowski, J., Scheiber, G., Henry, S. 1981. Epidemiologic notes and reports. Plant poisonings - New Jersey. U.S. Dep. Health Hum. M. M. W. R., 30: 65-67.
- Cooper, M. R., Johnson, A. W. 1984. Poisonous plants in Britain and their effects on animals and man. Her Majesty's Stationery Office, London, England. 305 pp.
- Goldberg, R. E. 1951. The jimsonweed menace. Today's Health, 29: 38-39, 66.
- Hughes, J. D., Clark, J. A. 1939. *Stramonium* poisoning. J. Am. Med. Assoc., 112: 2500-2502.
- Jacobziner, H., Raybin, H. W. 1961. Fatal salicylate intoxication and stramonium poisoning. N. Y. State J. Med., 61: 301-303.
- Lampe, K. F., McCann, M. A. 1985. AMA Handbook of poisonous and injurious plants. American Medical Assoc. Chicago, Ill., USA. 432 pp.
- Mitchell, J. E., Mitchell, F. N. 1955. Jimson weed (*Datura stramonium*) poisoning in childhood. J. Pediatr., 47: 227-230.
- Moore, D. W. 1976. The autumnal high: jimsonweed in North Carolina. N. C. Med. J., 37: 492-494.
- Stiles, F. C. 1951. Stramonium poisoning. J. Pediatr., 39: 354-356.

Sheep

General symptoms of poisoning:

[ataxia](#)

[breathing, rapid](#)

[collapse](#)

[dyspnea](#)

[gait, unsteady](#)
[incoordination](#)
[recumbency](#)
[reflex excitability](#)
[trembling](#)
[water intake, reduced](#)

Notes on poisoning:

Jimsonweed poisoning in sheep causes symptoms such as locomotion disturbances, rapid respiration, inability to stand and death. Sheep that were experimentally fed fresh leaves and fruits became ill and died (El Dirdiri et al. 1981). Postmortem examination showed lung congestion, a dilated heart, and hemorrhagic, fatty liver. The renal cortex was pale yellow and the medulla was hemorrhagic. Sheep that received 10 g/kg/day died within 38 days.

References:

El Dirdiri, N. I., Wasfi, I. A., Adam, S. E., Edds, G. T. 1981. Toxicity of *Datura stramonium* to sheep and goats. *Vet. Hum. Toxicol.*, 23: 241-246.

Swine

General symptoms of poisoning:

[depression](#)
[gait, rigid](#)
[incoordination](#)
[lethargy](#)
[pupil dilation](#)

Notes on poisoning:

Swine exhibit symptoms of incoordination, stiff gait, pupil dilation, and drowsiness. Earlier reports had suggested that jimsonweed ingested by pregnant sows might cause arthrogryposis in newborn pigs, but Keeler (1981) determined that this was not the case after feeding experiments. Other studies have found that pigs tolerated, with little effect, and alkaloid intake of 2.2 mg/kg of body weight from seeds containing 0.2-0.6% alkaloid content. Because of the unpalatability of jimsonweed seeds, the feed is rejected and therefore lethal quantities are not likely to be ingested (Cheeke and Schull 1985).

References:

Keeler, R. F. 1981. Absence of arthrogryposis in newborn

Hampshire pigs from sows ingesting toxic levels of jimsonweed during gestation. *Vet. Hum. Toxicol.*, 23: 413-415.

[Another search?](#)

[Français](#) | [Contact Us](#) | [Help](#) | [Search](#) | [Canada site](#)

[Coming Events](#) | [About CBIF](#) | [Links](#) | [Reports and Publications](#) |

[Home](#)

Date modified: 2003-02-06

[Important Notices](#)



Français	Contact us	Help	Search	Canada site
Coming events	About CBIF	Links	Reports and publications	Home



Notes on poisoning: Johnson grass

[Introduction](#)

[Interactive](#)

[All poisonous plants by Botanical name](#)

[All poisonous plants by Common name](#)

[Important WWW Poisonous Plants sites](#)



General poisoning notes:

Johnson grass (*Sorghum halepense*) is a naturalized herb found as a weed in only a few counties of southwestern Ontario. This plant can produce toxic quantities of HCN if it is damaged through frost, mastication, or water stress. Johnson grass can also accumulate toxic amounts of nitrate under certain circumstances. Cattle and a horse were poisoned after ingesting Johnson grass. Plants are spread from rhizomes but susceptibility to severe frost has limited the plants to a few counties in southwestern Ontario. The grass is found in fields and field edges. Toxicity is not likely, but ingesting large quantities of Johnson grass can cause problems (Gray et al. 1968, Clay et al. 1976, Warwick and Black 1983).

References:

Clay, B. R., Edwards, W. C., Peterson, D. R. 1976. Toxic nitrate accumulation in the sorghums. *Bovine Pract.*, 11: 28-32.

Gray, E., Rice, J. S., Wattenbarger, D., Benson, J. A., Hester, A. J., Loyd, R. C., Greene, B. M. 1968. Hydrocyanic acid potential of *Sorghum* plants grown in Tennessee. *Tenn. Agric. Exp. Stn. Bull.*, 445. 48 pp.

Reynard, G. B., Norton, J. B. 1942. Poisonous plants of Maryland in relation to livestock. *Univ. MD. Agric. Exp. Stn. Bull.*, A10. 312 pp.

Warwick, S. I., Black, L. D. 1983. The biology of Canadian weeds. 61. *Sorghum halepense* (L.) Pers. *Can. J. Plant Sci.*, 63: 997-1014.

Nomenclature:

Scientific Name: *Sorghum halepense* (L.) Pers.

Vernacular name(s): Johnson grass

Scientific family name: *Gramineae*

Vernacular family name: grass

Go to ITIS^{*ca} for more taxonomic information on: [Sorghum halepense](#)

References:

Agriculture Quebec. 1975. Noms des maladies des plantes du Canada/ Names of plant diseases in Canada. , Quebec City, Que., Canada. 288 pp.

Alex, J. F., Cayouette, R., Mulligan, G. A. 1980. Common and botanical names of weeds in Canada/Noms populaire et scientifiques des plantes nuisibles du Canada. Revised. Agric. Can. Publ., Ottawa, Ont., Canada. 132 pp.

Bailey, L. H., Bailey, E. Z. 1976. Hortus third. Revised. MacMillan, New York, N.Y., USA. 1290 pp.

Scoggan, H. J. 1978, 1979. The flora of Canada. Nat. Mus. Nat. Sci. (Ottawa) Publ. Bot. 7(1)-7(4). 1711 pp.

Van Wijk, H. L. 1911. A dictionary of plant names. Martinus Nijhoff, The Hague, The Netherlands. 1444 pp.

Victorin, M. 1964. Flore Laurentienne. 2nd ed. Univ. Montreal, Montreal, Que., Canada. 952 pp.

Geographic Information

Ontario

References:

Bailey, L. H., Bailey, E. Z. 1976. Hortus third. Revised. MacMillan, New York, N.Y., USA. 1290 pp.

Boivin, B. 1966, 1967. Énumération des plantes du Canada. Provencheria 6. Nat. Can. (Que.) 93: 253-274; 371-437; 583-646; 989-1063. 94: 131-157; 471-528; 625-655.

Image or illustration

Johnson grass:

Images: images.google.com

Notes on Poisonous plant parts:

The hydrocyanic potential of Johnson grass is largest during early growth of the plant (Gray et al. 1968).

Toxic parts:

leaves

stems

References:

Gray, E., Rice, J. S., Wattenbarger, D., Benson, J. A., Hester, A. J., Loyd, R. C., Greene, B. M. 1968. Hydrocyanic acid potential of *Sorghum* plants grown in Tennessee. *Tenn. Agric. Exp. Stn. Bull.*, 445. 48 pp.

Sharma, R. P., Salunkhe, D. K. 1989. *Solanum* glycoalkaloids. Pages 179-236 in Cheeke, P. R., ed. *Toxicants of plant origin. Vol. I. Alkaloids.* CRC Press, Inc., Boca Raton, Fla., USA. 335 pp.

Notes on Toxic plant chemicals:

A cyanogenic glycoside, dhurrin, is found in Johnson grass. After the plant has been damaged by mastication, plant enzymes convert the glycoside to other chemicals, including HCN. Cyanide, which is lethal, is released into the animal's system. Nitrates can accumulate under some circumstances. Nitrate poisoning has occurred in cattle (Gray et al. 1968, Clay et al. 1976).

Toxic plant chemicals:

chaconine

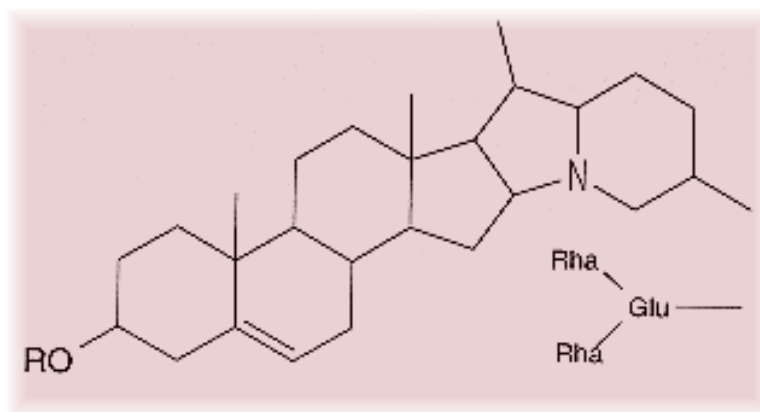

dhurrin

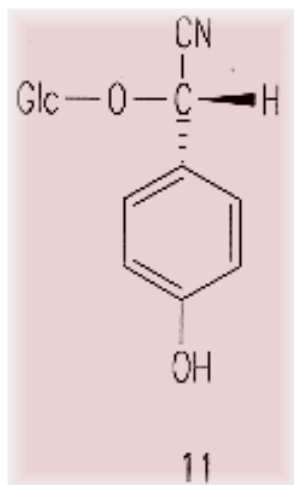

nitrate

Chemical diagram(s) are courtesy of [Ruth McDiarmid](#), Biochemistry Technician, Kamloops Range Station, Agriculture and Agri-Food Canada, Kamloops, British Columbia, Canada.

References:

Clay, B. R., Edwards, W. C., Peterson, D. R. 1976. Toxic nitrate accumulation in the sorghums. *Bovine Pract.*, 11: 28-32.

Gray, E., Rice, J. S., Wattenbarger, D., Benson, J. A., Hester, A. J., Loyd, R. C., Greene, B. M. 1968. Hydrocyanic acid potential of *Sorghum* plants grown in Tennessee. *Tenn. Agric. Exp. Stn. Bull.*, 445. 48 pp.

Sharma, R. P., Salunkhe, D. K. 1989. *Solanum* glycoalkaloids. Pages 179-236 in Cheeke, P. R., ed. Toxicants of plant origin. Vol. I. Alkaloids. CRC Press, Inc., Boca Raton, Fla., USA. 335 pp.

Animals/Human Poisoning:

Note: When an animal is listed without additional information, the literature (as of 1993) contained no detailed explanation.

Cattle

General symptoms of poisoning:

[abortion](#)

[breathing, rapid](#)

[death](#)

[death by asphyxiation](#)

[gait, staggering](#)

[methemoglobinemia](#)

[mouth, frothing of](#)

Notes on poisoning:

Johnson grass can accumulate toxic levels of nitrates, which leads to methemoglobinemia. In severe cases, death can occur 4-6 h after ingestion. Three to five days after acute poisoning, surviving pregnant animals may abort (Clay et al. 1976). Dhurrin, a cyanogenic glycoside, is found in plant material. When the plant is damaged by frost, mastication, or water stress, HCN can be released and cyanide can enter the animal's system. Symptoms are the result of cytotoxic hypoxia, leading in severe cases to death from asphyxiation. Other symptoms include increased respiration, irregular pulse, frothing at the mouth, and staggering (Gray et al. 1968, Fuller and McClintock 1986).

References:

Clay, B. R., Edwards, W. C., Peterson, D. R. 1976. Toxic nitrate accumulation in the sorghums. *Bovine Pract.*, 11: 28-32.

Gray, E., Rice, J. S., Wattenbarger, D., Benson, J. A., Hester, A. J., Loyd, R. C., Greene, B. M. 1968. Hydrocyanic acid potential of *Sorghum* plants grown in Tennessee. *Tenn. Agric. Exp. Stn. Bull.*, 445. 48 pp.

Horses

General symptoms of poisoning:

[death by asphyxiation](#)

Notes on poisoning:

In Maryland a horse died from cyanide poisoning after ingesting Johnson grass (Reynard and Norton 1942).

References:

Reynard, G. B., Norton, J. B. 1942. Poisonous plants of Maryland in relation to livestock. *Univ. MD. Agric. Exp. Stn. Bull.*, A10. 312 pp.

[Another search?](#)

[Français](#) | [Contact Us](#) | [Help](#) | [Search](#) | [Canada site](#)

[Coming Events](#) | [About CBIF](#) | [Links](#) | [Reports and Publications](#) | [Home](#)

Date modified: 2003-02-06

[Important Notices](#)



Français	Contact us	Help	Search	Canada site
Coming events	About CBIF	Links	Reports and publications	Home

Canadian Biodiversity Information Facility



Notes on poisoning: Kaffir lily

[Introduction](#)

[Interactive](#)

[All poisonous plants by Botanical name](#)

[All poisonous plants by Common name](#)

[Important WWW Poisonous Plants sites](#)

General poisoning notes:

Kaffir lily (*Clivia miniata*) is an indoor ornamental plant grown for its flowers. The plant contains small amounts of the alkaloid lycorine. Large quantities must be ingested to cause symptoms of toxicity. Children and family pets can be poisoned (Frohne and Pfander 1983, Lampe and McCann 1985).



References:

Frohne, D., Pfander, H. J. 1983. A colour atlas of poisonous plants. Wolfe Publishing Ltd., London, England. 291 pp.

Lampe, K. F., McCann, M. A. 1985. AMA Handbook of poisonous and injurious plants. American Medical Assoc. Chicago, Ill., USA. 432 pp.

Nomenclature:

Scientific Name: *Clivia miniata* Regel

Vernacular name(s): Kaffir lily

Scientific family name: *Amaryllidaceae*

Vernacular family name: amaryllis

References:

Agriculture Quebec. 1975. Noms des maladies des plantes du Canada/ Names of plant diseases in Canada. , Quebec City, Que., Canada. 288 pp.

Alex, J. F., Cayouette, R., Mulligan, G. A. 1980. Common and botanical names of weeds in Canada/Noms populaire et scientifiques des plantes nuisibles du Canada. Revised. Agric. Can. Publ., Ottawa, Ont., Canada. 132 pp.

Bailey, L. H., Bailey, E. Z. 1976. Hortus third. Revised. MacMillan, New York, N.Y., USA. 1290 pp.

Scoggan, H. J. 1978, 1979. The flora of Canada. Nat. Mus. Nat. Sci. (Ottawa) Publ. Bot. 7(1)-7(4). 1711 pp.

Van Wijk, H. L. 1911. A dictionary of plant names. Martinus Nijhoff, The Hague, The Netherlands. 1444 pp.

Victorin, M. 1964. Flore Laurentienne. 2nd ed. Univ. Montreal, Montreal, Que., Canada. 952 pp.

Geographic Information

Plant or plant parts used in or around the home.

References:

Bailey, L. H., Bailey, E. Z. 1976. Hortus third. Revised. MacMillan, New York, N.Y., USA. 1290 pp.

Boivin, B. 1966, 1967. Énumération des plantes du Canada. Provencheria 6. Nat. Can. (Que.) 93: 253-274; 371-437; 583-646; 989-1063. 94: 131-157; 471-528; 625-655.

Image or illustration

Kaffir lily:

Images: images.google.com

Toxic parts:

bulbs

References:

Frohne, D., Pfander, H. J. 1983. A colour atlas of poisonous plants. Wolfe Publishing Ltd., London, England. 291 pp.

Notes on Toxic plant chemicals:

Lycorine has been found in quantities of 0.43% (dry weight) in the Kaffir lily. The greatest concentration of the alkaloid is in the bulb (Frohne and Pfander 1983).

Toxic plant chemicals:

lycorine

References:

Frohne, D., Pfander, H. J. 1983. A colour atlas of poisonous plants. Wolfe Publishing Ltd., London, England. 291 pp.

Lampe, K. F., McCann, M. A. 1985. AMA Handbook of poisonous and injurious plants. American Medical Assoc. Chicago, Ill., USA. 432 pp.

Animals/Human Poisoning:

Note: When an animal is listed without additional information, the literature (as of 1993) contained no detailed explanation.

Humans

General symptoms of poisoning:

[collapse](#)

[diarrhea](#)

[paralysis](#)

[salivation](#)

[vomiting](#)

References:

Frohne, D., Pfander, H. J. 1983. A colour atlas of poisonous plants. Wolfe Publishing Ltd., London, England. 291 pp.

Lampe, K. F., McCann, M. A. 1985. AMA Handbook of poisonous and injurious plants. American Medical Assoc. Chicago, Ill., USA. 432 pp.

[Another search?](#)

[Français](#) | [Contact Us](#) | [Help](#) | [Search](#) | [Canada site](#)

[Coming Events](#) | [About CBIF](#) | [Links](#) | [Reports and Publications](#) |

[Home](#)

Date modified: 2003-02-06

[Important Notices](#)



Français	Contact us	Help	Search	Canada site
Coming events	About CBIF	Links	Reports and publications	Home

Canadian Biodiversity Information Facility



Notes on poisoning: Kentucky coffeetree

[Introduction](#)[Interactive](#)[All poisonous plants by Botanical name](#)[All poisonous plants by Common name](#)[Important WWW Poisonous Plants sites](#)

General poisoning notes:

Kentucky coffeetree (*Gymnocladus dioicus*) is a tree that is occasionally planted as an ornamental in the warmer parts of Canada. The seeds and fruit pulp of this tree have poisoned humans and cattle. The foliage has caused the death of sheep in Maryland (Reynard and Norton 1942, Lampe and McCann 1985).



References:

Hill, S. R., Duke, P. K. 1986. 100 poisonous plants of Maryland. Univ. MD. Coop. Ext. Serv. Bull., 314. 55 pp.

Lampe, K. F., McCann, M. A. 1985. AMA Handbook of poisonous and injurious plants. American Medical Assoc. Chicago, Ill., USA. 432 pp.

Reynard, G. B., Norton, J. B. 1942. Poisonous plants of Maryland in relation to livestock. Univ. MD. Agric. Exp. Stn. Bull., A10. 312 pp.

Nomenclature:

Scientific Name: *Gymnocladus dioicus* (L.) K. Koch

Vernacular name(s): Kentucky coffeetree

Scientific family name: *Leguminosae*

Vernacular family name: pea

Go to ITIS^{*ca} for more taxonomic information on: [Gymnocladus dioicus](#)

References:

Agriculture Quebec. 1975. Noms des maladies des plantes du

Canada/ Names of plant diseases in Canada. , Quebec City, Que., Canada. 288 pp.

Alex, J. F., Cayouette, R., Mulligan, G. A. 1980. Common and botanical names of weeds in Canada/Noms populaire et scientifiques des plantes nuisibles du Canada. Revised. Agric. Can. Publ., Ottawa, Ont., Canada. 132 pp.

Bailey, L. H., Bailey, E. Z. 1976. Hortus third. Revised. MacMillan, New York, N.Y., USA. 1290 pp.

Scoggan, H. J. 1978, 1979. The flora of Canada. Nat. Mus. Nat. Sci. (Ottawa) Publ. Bot. 7(1)-7(4). 1711 pp.

Van Wijk, H. L. 1911. A dictionary of plant names. Martinus Nijhoff, The Hague, The Netherlands. 1444 pp.

Victorin, M. 1964. Flore Laurentienne. 2nd ed. Univ. Montreal, Montreal, Que., Canada. 952 pp.

Geographic Information

Plant or plant parts used in or around the home.

References:

Bailey, L. H., Bailey, E. Z. 1976. Hortus third. Revised. MacMillan, New York, N.Y., USA. 1290 pp.

Boivin, B. 1966, 1967. Énumération des plantes du Canada. Provencheria 6. Nat. Can. (Que.) 93: 253-274; 371-437; 583-646; 989-1063. 94: 131-157; 471-528; 625-655.

Image or illustration

Kentucky coffeetree:

Images: images.google.com

Notes on Poisonous plant parts:

The seeds contain a low concentration of the alkaloid cytisine, and chewing one or two seeds would not be enough to produce toxic results. This tree is an ornamental that survives and produces seeds in the warmer parts of the country; it grows successfully in Ottawa. In feeding experiments the foliage has proved to be toxic to sheep and the seeds to cattle (Reynard and Norton 1942, Lampe and McCann 1985).

Toxic parts:

leaves
seeds

References:

Lampe, K. F., McCann, M. A. 1985. AMA Handbook of poisonous and injurious plants. American Medical Assoc. Chicago, Ill., USA. 432 pp.

Reynard, G. B., Norton, J. B. 1942. Poisonous plants of Maryland in relation to livestock. Univ. MD. Agric. Exp. Stn. Bull., A10. 312 pp.

Toxic plant chemicals:

cytisine

References:

Lampe, K. F., McCann, M. A. 1985. AMA Handbook of poisonous and injurious plants. American Medical Assoc. Chicago, Ill., USA. 432 pp.

Animals/Human Poisoning:

Note: When an animal is listed without additional information, the literature (as of 1993) contained no detailed explanation.

Cattle

General symptoms of poisoning:

[lungs, congestion of](#)

Notes on poisoning:

Experimental feeding of seeds to cattle has caused congestion of the lungs and the fourth stomach (Reynard and Norton 1942).

References:

Reynard, G. B., Norton, J. B. 1942. Poisonous plants of Maryland in relation to livestock. Univ. MD. Agric. Exp. Stn. Bull., A10. 312 pp.

Humans

General symptoms of poisoning:

[coma](#)

[diarrhea](#)

[gastroenteritis](#)

[nausea](#)

[sweating](#)

References:

Lampe, K. F., McCann, M. A. 1985. AMA Handbook of poisonous and injurious plants. American Medical Assoc. Chicago, Ill., USA. 432 pp.

Sheep

General symptoms of poisoning:

[death](#)

Notes on poisoning:

In one case in Maryland, 11 sheep died within 24 h of ingesting fresh cuttings from the Kentucky coffeetree (Hill and Duke 1985).

References:

Hill, S. R., Duke, P. K. 1986. 100 poisonous plants of Maryland. Univ. MD. Coop. Ext. Serv. Bull., 314. 55 pp.

[Another search?](#)

[Français](#) | [Contact Us](#) | [Help](#) | [Search](#) | [Canada site](#)

[Coming Events](#) | [About CBIF](#) | [Links](#) | [Reports and Publications](#) |

[Home](#)

Date modified: 2003-02-06

[Important Notices](#)



Français	Contact us	Help	Search	Canada site
Coming events	About CBIF	Links	Reports and publications	Home

Canadian Biodiversity Information Facility



Notes on poisoning: kochia

[Introduction](#)[Interactive](#)[All poisonous plants by Botanical name](#)[All poisonous plants by Common name](#)[Important WWW Poisonous Plants sites](#)

General poisoning notes:

Kochia (*Kochia scoparia*) is both naturalized and cultivated as an outdoor ornamental in various parts of Canada. Ingestion has caused poisoning in cattle, horses, and sheep. Hepatogenous photosensitivity and liver damage often occur together, along with the outward signs of photosensitization. In addition, polioencephalomalacia, toxic hepatitis, and nephrosis can occur. Kochia has been examined as a forage crop because it is very drought-tolerant. Toxicity varies from one year to the next. Increased rainfall has raised the oxalate content of the plants. Oxalates are at least partly responsible for the complicated toxic affects of kochia ingestion (Galitzer and Oehme 1978, Dickie and Berryman 1979, Thilsted et al. 1989).

References:

Dickie, C. W., Berryman, J. R. 1979. Polioencephalomalacia and photosensitization associated with *Kochia scoparia* consumption in range cattle. J. Am. Vet. Med. Assoc., 175: 463-465.

Dickie, C. W., James, L. F. 1983. *Kochia scoparia* poisoning in cattle. J. Am. Vet. Med. Assoc., 183: 765-768.

Galitzer, S. J., Oehme, F. W. 1978. *Kochia scoparia* (L.) Schrad toxicity in cattle: a literature review. Vet. Hum. Toxicol., 20: 421-423.

Johnson, A. E. 1983. Photosensitizing toxins from plants and their biologic effects. Pages 345-359 in Keeler, R. F., Tu, A. T., eds. Handbook of natural toxins. Vol. 1. Plant and Fungal toxins. Marcel Dekker, Inc., New York, N.Y., USA. 934 pp.

Thilsted, J., Hibbs, C., Kiesling, H., Hallford, D., Kirksey, R., Meininger, A., Tompkins, J. 1989. Kochia (*Kochia scoparia*) toxicosis in cattle: results of four experimental grazing trials. Vet. Hum. Toxicol., 31: 34-41.

Nomenclature:

Scientific Name: *Kochia scoparia* (L.) Schrad.

Vernacular name(s): kochia

Scientific family name: *Chenopodiaceae*

Vernacular family name: goosefoot

Go to ITIS^{*ca} for more taxonomic information on: [Kochia scoparia](#)

References:

Agriculture Quebec. 1975. Noms des maladies des plantes du Canada/ Names of plant diseases in Canada. , Quebec City, Que., Canada. 288 pp.

Alex, J. F., Cayouette, R., Mulligan, G. A. 1980. Common and botanical names of weeds in Canada/Noms populaire et scientifiques des plantes nuisibles du Canada. Revised. Agric. Can. Publ., Ottawa, Ont., Canada. 132 pp.

Bailey, L. H., Bailey, E. Z. 1976. Hortus third. Revised. MacMillan, New York, N.Y., USA. 1290 pp.

Scoggan, H. J. 1978, 1979. The flora of Canada. Nat. Mus. Nat. Sci. (Ottawa) Publ. Bot. 7(1)-7(4). 1711 pp.

Van Wijk, H. L. 1911. A dictionary of plant names. Martinus Nijhoff, The Hague, The Netherlands. 1444 pp.

Victorin, M. 1964. Flore Laurentienne. 2nd ed. Univ. Montreal, Montreal, Que., Canada. 952 pp.

Geographic Information

Alberta
British Columbia
Manitoba
Nova Scotia
Ontario
Quebec
Saskatchewan

References:

Bailey, L. H., Bailey, E. Z. 1976. Hortus third. Revised. MacMillan, New York, N.Y., USA. 1290 pp.

Boivin, B. 1966, 1967. Énumération des plantes du Canada.

Provencheria 6. Nat. Can. (Que.) 93: 253-274; 371-437; 583-646; 989-1063. 94: 131-157; 471-528; 625-655.

Image or illustration

kochia:

Images: images.google.com

Toxic parts:

flowers
leaves
seeds

References:

Dickie, C. W., Berryman, J. R. 1979. Polioencephalomalacia and photosensitization associated with *Kochia scoparia* consumption in range cattle. J. Am. Vet. Med. Assoc., 175: 463-465.

Dickie, C. W., James, L. F. 1983. *Kochia scoparia* poisoning in cattle. J. Am. Vet. Med. Assoc., 183: 765-768.

Thilsted, J., Hibbs, C., Kiesling, H., Hallford, D., Kirksey, R., Meininger, A., Tompkins, J. 1989. *Kochia (Kochia scoparia)* toxicosis in cattle: results of four experimental grazing trials. Vet. Hum. Toxicol., 31: 34-41.

Notes on Toxic plant chemicals:

Kochia has been found to contain total oxalates of up to 11.4% and maximum soluble oxalates of 4.7%. This level of soluble oxalates is sufficient to cause some of the signs of toxicity seen in poisoning. In addition, saponins and alkaloids have been described that may contribute to the complex symptoms of *kochia* ingestion (Dickie et al. 1989, Thilsted et al. 1989).

Toxic plant chemicals:

oxalate

References:

Dickie, C. W., Gerlach, M. L., Hamar, D. W. 1989. *Kochia scoparia* oxalate content. Vet. Hum. Toxicol., 31: 240-242.

Thilsted, J., Hibbs, C., Kiesling, H., Hallford, D., Kirksey, R., Meininger, A., Tompkins, J. 1989. *Kochia (Kochia scoparia)* toxicosis in cattle: results of four experimental grazing trials. Vet.

Hum. Toxicol., 31: 34-41.

Animals/Human Poisoning:

Note: When an animal is listed without additional information, the literature (as of 1993) contained no detailed explanation.

Cattle

General symptoms of poisoning:

[anorexia](#)

[ataxia](#)

[blindness](#)

[breathing, labored](#)

[death](#)

[dehydration](#)

[depression](#)

[diarrhea](#)

[erythema](#)

[eye, discharge of](#)

[eyelids, swollen](#)

[eyes, rolling](#)

[head, movement of](#)

[icterus](#)

[incoordination](#)

[itchiness](#)

[lacrimation, severe](#)

[lethargy](#)

[liver, congestion of](#)

[lungs, congestion of](#)

[muscle spasms](#)

[muscle, weakness of](#)

[muzzle, crusty](#)

[nephrosis, severe](#)

[opisthotonos](#)

[polioencephalomalacia](#)

[recumbency, ventral](#)

[reflex excitability](#)

[salivation](#)

[skin, peeling of](#)

[teat necrosis of](#)

[urine, coffee-colored](#)

Notes on poisoning:

In addition to photosensitization, symptoms can include ataxia,

incoordination, muscular spasms, recumbency, and death. Because kochia causes hepatogenous photosensitization, disseminated jaundice is often seen along with enlarged fatty liver (Galitzer and Oehme 1978, Johnson 1983).

References:

Dickie, C. W., Berryman, J. R. 1979. Polioencephalomalacia and photosensitization associated with *Kochia scoparia* consumption in range cattle. J. Am. Vet. Med. Assoc., 175: 463-465.

Dickie, C. W., James, L. F. 1983. *Kochia scoparia* poisoning in cattle. J. Am. Vet. Med. Assoc., 183: 765-768.

Galitzer, S. J., Oehme, F. W. 1978. *Kochia scoparia* (L.) Schrad toxicity in cattle: a literature review. Vet. Hum. Toxicol., 20: 421-423.

Thilsted, J., Hibbs, C., Kiesling, H., Hallford, D., Kirksey, R., Meininger, A., Tompkins, J. 1989. Kochia (*Kochia scoparia*) toxicosis in cattle: results of four experimental grazing trials. Vet. Hum. Toxicol., 31: 34-41.

[Another search?](#)

[Français](#) | [Contact Us](#) | [Help](#) | [Search](#) | [Canada site](#)
[Coming Events](#) | [About CBIF](#) | [Links](#) | [Reports and Publications](#) | [Home](#)

Date modified: 2003-02-06

[Important Notices](#)



Français	Contact us	Help	Search	Canada site
Coming events	About CBIF	Links	Reports and publications	Home

Canadian Biodiversity Information Facility



Notes on poisoning: lamb's-quarters

[Introduction](#)[Interactive](#)[All poisonous plants by Botanical name](#)[All poisonous plants by Common name](#)[Important WWW Poisonous Plants sites](#)

General poisoning notes:

Lamb's-quarters (*Chenopodium album*) is a naturalized annual herb found in disturbed soils across Canada. This plant can cause sickness and death in livestock if large quantities are ingested. The plants can accumulate both nitrates and soluble oxalates. Cattle and sheep have been poisoned. Humans who consume large quantities of the plant and are subsequently exposed to sunlight suffer photosensitization (Whitehead and Moxon 1952, Cooper and Johnson 1984).

References:

Cooper, M. R., Johnson, A. W. 1984. Poisonous plants in Britain and their effects on animals and man. Her Majesty's Stationery Office, London, England. 305 pp.

Nomenclature:

Scientific Name: *Chenopodium album* L.

Vernacular name(s): lamb's-quarters

Scientific family name: *Chenopodiaceae*

Vernacular family name: goosefoot

Go to ITIS*^{ca} for more taxonomic information on: [Chenopodium album](#)

References:

Agriculture Quebec. 1975. Noms des maladies des plantes du Canada/ Names of plant diseases in Canada. , Quebec City, Que., Canada. 288 pp.

Alex, J. F., Cayouette, R., Mulligan, G. A. 1980. Common and

botanical names of weeds in Canada/Noms populaire et scientifiques des plantes nuisibles du Canada. Revised. Agric. Can. Publ., Ottawa, Ont., Canada. 132 pp.

Bailey, L. H., Bailey, E. Z. 1976. Hortus third. Revised. MacMillan, New York, N.Y., USA. 1290 pp.

Scoggan, H. J. 1978, 1979. The flora of Canada. Nat. Mus. Nat. Sci. (Ottawa) Publ. Bot. 7(1)-7(4). 1711 pp.

Van Wijk, H. L. 1911. A dictionary of plant names. Martinus Nijhoff, The Hague, The Netherlands. 1444 pp.

Victorin, M. 1964. Flore Laurentienne. 2nd ed. Univ. Montreal, Montreal, Que., Canada. 952 pp.

Geographic Information

Alberta
British Columbia
Manitoba
New Brunswick
Newfoundland
Northwest Territories
Nova Scotia
Ontario
Prince Edward Island
Quebec
Saskatchewan
Yukon Territory

References:

Bailey, L. H., Bailey, E. Z. 1976. Hortus third. Revised. MacMillan, New York, N.Y., USA. 1290 pp.

Boivin, B. 1966, 1967. Énumération des plantes du Canada. Provencheria 6. Nat. Can. (Que.) 93: 253-274; 371-437; 583-646; 989-1063. 94: 131-157; 471-528; 625-655.

Image or illustration

lamb's-quarters:

Images: images.google.com

Toxic parts:

leaves
stems

References:

Gilbert, C. S., Eppson, H. F., Bradley, W. B., Beath, O. A. 1946. Nitrate accumulation in cultivated plants and weeds. Univ. Wyo. Agric. Exp. Stn. Bull., 277. 39 pp.

Whitehead, E. I., Moxon, A. L. 1952. Nitrate poisoning. S. D. Agric. Exp. Stn. Bull., 424. 24 pp.

Notes on Toxic plant chemicals:

This plant can accumulate high levels of nitrates and oxalates. The high oxalate content is thought to be responsible for most cases of poisoning (Cooper and Johnson 1984).

Toxic plant chemicals:

nitrate
oxalate

References:

Cooper, M. R., Johnson, A. W. 1984. Poisonous plants in Britain and their effects on animals and man. Her Majesty's Stationery Office, London, England. 305 pp.

Gilbert, C. S., Eppson, H. F., Bradley, W. B., Beath, O. A. 1946. Nitrate accumulation in cultivated plants and weeds. Univ. Wyo. Agric. Exp. Stn. Bull., 277. 39 pp.

Whitehead, E. I., Moxon, A. L. 1952. Nitrate poisoning. S. D. Agric. Exp. Stn. Bull., 424. 24 pp.

Animals/Human Poisoning:

Note: When an animal is listed without additional information, the literature (as of 1993) contained no detailed explanation.

Cattle

General symptoms of poisoning:

[breathing, shallow](#)

[death](#)

[diarrhea](#)

[recumbency](#)

[skin, yellow pigment](#)

[unconsciousness](#)

References:

Cooper, M. R., Johnson, A. W. 1984. Poisonous plants in Britain and their effects on animals and man. Her Majesty's Stationery Office, London, England. 305 pp.

Horses

Humans

Sheep

Swine

[Another search?](#)

[Français](#) | [Contact Us](#) | [Help](#) | [Search](#) | [Canada site](#)

[Coming Events](#) | [About CBIF](#) | [Links](#) | [Reports and Publications](#) |

[Home](#)

Date modified: 2003-02-06

[Important Notices](#)



Français	Contact us	Help	Search	Canada site
Coming events	About CBIF	Links	Reports and publications	Home

Canadian Biodiversity Information Facility



Notes on poisoning: large-leaved lupine

[Introduction](#)

[Interactive](#)

[All poisonous plants by Botanical name](#)

[All poisonous plants by Common name](#)

[Important WWW Poisonous Plants sites](#)



General poisoning notes:

Large-leaved lupine (*Lupinus polyphyllus*) is a native of British Columbia and has been introduced in eastern Canada. This species has been used in developing many of the cultivars of lupines grown in gardens. Davis and Stout (1986) measured quantities of anagryne that exceeded the minimum necessary to cause crooked calf disease (teratogenic deformities) in calves. The literature does not include any documented cases. Care should be taken to prevent pregnant cattle from feeding on this lupine from day 40 to day 70 of gestation. See additional notes under silky lupine (*Lupinus sericeus*).

References:

Davis, A. M., Stout, D. M. 1986. Anagryne in western American lupines. *J. Range Manage.*, 39: 29-30.

Keeler, R. F. 1989. Quinolizidine alkaloids in range and grain lupins. Pages 133-167 in Cheeke, P. R., ed. *Toxicants of plant origin*. Vol. I. Alkaloids. CRC Press, Inc., Boca Raton, Fla., USA. 335 pp.

Nomenclature:

Scientific Name: *Lupinus polyphyllus* Lindl.

Vernacular name(s): large-leaved lupine

Scientific family name: *Leguminosae*

Vernacular family name: pea

Go to ITIS^{*ca} for more taxonomic information on: [Lupinus polyphyllus](#)

References:

Agriculture Quebec. 1975. Noms des maladies des plantes du Canada/ Names of plant diseases in Canada. , Quebec City, Que., Canada. 288 pp.

Alex, J. F., Cayouette, R., Mulligan, G. A. 1980. Common and botanical names of weeds in Canada/Noms populaire et scientifiques des plantes nuisibles du Canada. Revised. Agric. Can. Publ., Ottawa, Ont., Canada. 132 pp.

Bailey, L. H., Bailey, E. Z. 1976. Hortus third. Revised. MacMillan, New York, N.Y., USA. 1290 pp.

Scoggan, H. J. 1978, 1979. The flora of Canada. Nat. Mus. Nat. Sci. (Ottawa) Publ. Bot. 7(1)-7(4). 1711 pp.

Van Wijk, H. L. 1911. A dictionary of plant names. Martinus Nijhoff, The Hague, The Netherlands. 1444 pp.

Victorin, M. 1964. Flore Laurentienne. 2nd ed. Univ. Montreal, Montreal, Que., Canada. 952 pp.

Geographic Information

British Columbia
New Brunswick
Nova Scotia
Ontario
Prince Edward Island
Quebec

References:

Bailey, L. H., Bailey, E. Z. 1976. Hortus third. Revised. MacMillan, New York, N.Y., USA. 1290 pp.

Boivin, B. 1966, 1967. Énumération des plantes du Canada. Provencheria 6. Nat. Can. (Que.) 93: 253-274; 371-437; 583-646; 989-1063. 94: 131-157; 471-528; 625-655.

Image or illustration

large-leaved lupine:

Images: images.google.com

Toxic parts:

leaves
stems

References:

Davis, A. M., Stout, D. M. 1986. Anagryne in western American lupines. *J. Range Manage.*, 39: 29-30.

Notes on Toxic plant chemicals:

Anagryne, a quinolizidine alkaloid, has been measured in amounts exceeding the minimum 1.44 g/kg required to cause teratogenic effects. A measurement of 6.10 g/kg is reported by Davis and Stout (1986) in the aboveground portion of a plant.

Toxic plant chemicals:

anagryne

References:

Davis, A. M., Stout, D. M. 1986. Anagryne in western American lupines. *J. Range Manage.*, 39: 29-30.

Animals/Human Poisoning:

Note: When an animal is listed without additional information, the literature (as of 1993) contained no detailed explanation.

Cattle

General symptoms of poisoning:

[arthrogryposis](#)

[palatoschisis](#)

[scoliosis](#)

[torticollis](#)

References:

Keeler, R. F. 1989. Quinolizidine alkaloids in range and grain lupins. Pages 133-167 in Cheeke, P. R., ed. *Toxicants of plant origin. Vol. I. Alkaloids.* CRC Press, Inc., Boca Raton, Fla., USA. 335 pp.

[Another search?](#)

[Français](#) | [Contact Us](#) | [Help](#) | [Search](#) | [Canada site](#)

[Coming Events](#) | [About CBIF](#) | [Links](#) | [Reports and Publications](#) | [Home](#)

Date modified: 2003-02-06

[Important Notices](#)



Français	Contact us	Help	Search	Canada site
Coming events	About CBIF	Links	Reports and publications	Home

Canadian Biodiversity Information Facility



Notes on poisoning: leafy spurge

[Introduction](#)[Interactive](#)[All poisonous plants by Botanical name](#)[All poisonous plants by Common name](#)[Important WWW Poisonous Plants sites](#)

General poisoning notes:

Leafy spurge (*Euphorbia esula*) is a naturalized herb that grows across southern Canada. The plant is usually not ingested by livestock, but if large amounts are incorporated in hay, poisoning can occur. Sheep are more resistant to leafy spurge, but collapse and death have occurred (Kingsbury 1964). Some humans can develop dermatitis and irritation from the latex.

References:

Kingsbury, J. M. 1964. Poisonous plants of the United States and Canada. Prentice-Hall Inc., Englewood Cliffs, N.J., USA. 626 pp.

Nomenclature:

Scientific Name: *Euphorbia esula* L.

Vernacular name(s): leafy spurge

Scientific family name: *Euphorbiaceae*

Vernacular family name: spurge

Go to ITIS^{*ca} for more taxonomic information on: [Euphorbia esula](#)

References:

Agriculture Quebec. 1975. Noms des maladies des plantes du Canada/ Names of plant diseases in Canada. , Quebec City, Que., Canada. 288 pp.

Alex, J. F., Cayouette, R., Mulligan, G. A. 1980. Common and botanical names of weeds in Canada/Noms populaire et scientifiques des plantes nuisibles du Canada. Revised. Agric. Can. Publ., Ottawa, Ont., Canada. 132 pp.

Bailey, L. H., Bailey, E. Z. 1976. Hortus third. Revised. MacMillan, New York, N.Y., USA. 1290 pp.

Scoggan, H. J. 1978, 1979. The flora of Canada. Nat. Mus. Nat. Sci. (Ottawa) Publ. Bot. 7(1)-7(4). 1711 pp.

Van Wijk, H. L. 1911. A dictionary of plant names. Martinus Nijhoff, The Hague, The Netherlands. 1444 pp.

Victorin, M. 1964. Flore Laurentienne. 2nd ed. Univ. Montreal, Montreal, Que., Canada. 952 pp.

Geographic Information

Alberta
British Columbia
Manitoba
Nova Scotia
Ontario
Prince Edward Island
Quebec
Saskatchewan

References:

Bailey, L. H., Bailey, E. Z. 1976. Hortus third. Revised. MacMillan, New York, N.Y., USA. 1290 pp.

Boivin, B. 1966, 1967. Énumération des plantes du Canada. Provencheria 6. Nat. Can. (Que.) 93: 253-274; 371-437; 583-646; 989-1063. 94: 131-157; 471-528; 625-655.

Image or illustration

leafy spurge:

Images: images.google.com

Toxic parts:

latex

References:

Seip, E. H., Hecker, E. 1982. Skin irritant ingenol esters from *Euphorbia esula*. Planta Med., 46: 215-218.

Notes on Toxic plant chemicals:

Seip and Hecker (1982) found ingenol derivatives, which are

diterpenes, to be the irritant factors in leafy spurge. Some of the chemicals were weak tumor promoters.

Toxic plant chemicals:

5-deoxyingenol

References:

Seip, E. H., Hecker, E. 1982. Skin irritant ingenol esters from *Euphorbia esula*. *Planta Med.*, 46: 215-218.

Animals/Human Poisoning:

Note: When an animal is listed without additional information, the literature (as of 1993) contained no detailed explanation.

Cattle

Horses

Humans

Sheep

General symptoms of poisoning:

[blistering](#)

[death](#)

References:

Kingsbury, J. M. 1964. *Poisonous plants of the United States and Canada*. Prentice-Hall Inc., Englewood Cliffs, N.J., USA. 626 pp.

[Another search?](#)

[Français](#) | [Contact Us](#) | [Help](#) | [Search](#) | [Canada site](#)

[Coming Events](#) | [About CBIF](#) | [Links](#) | [Reports and Publications](#) |

[Home](#)

Date modified: 2003-02-06

[Important Notices](#)



Français	Contact us	Help	Search	Canada site
Coming events	About CBIF	Links	Reports and publications	Home

Canadian Biodiversity Information Facility



Notes on poisoning: leatherwood

[Introduction](#)

[Interactive](#)

[All poisonous plants by Botanical name](#)

[All poisonous plants by Common name](#)

[Important WWW Poisonous Plants sites](#)



General poisoning notes:

Leatherwood (*Dirca palustris*) is a native shrub found in parts of eastern Canada in woodlands. This shrub contains unknown poisonous chemicals that are most potent in the bark. Chewing the bark can cause severe burning in the mouth and can produce a nauseating taste; dermatitis can occur, especially during flowering and fruiting time (Fyles 1920, Lampe and McCann 1985).

References:

Fyles, F. 1920. Principal poisonous plants of Canada. Can. Dep. Agric. Exp. Farms. Bull. 39. 112 pp.

Lampe, K. F., McCann, M. A. 1985. AMA Handbook of poisonous and injurious plants. American Medical Assoc. Chicago, Ill., USA. 432 pp.

Nomenclature:

Scientific Name: *Dirca palustris* L.

Vernacular name(s): leatherwood

Scientific family name: *Thymelaeaceae*

Vernacular family name: mezereum

Go to ITIS^{*ca} for more taxonomic information on: [Dirca palustris](#)

References:

Agriculture Quebec. 1975. Noms des maladies des plantes du Canada/ Names of plant diseases in Canada. , Quebec City, Que., Canada. 288 pp.

Alex, J. F., Cayouette, R., Mulligan, G. A. 1980. Common and botanical names of weeds in Canada/Noms populaire et scientifiques des plantes nuisibles du Canada. Revised. Agric. Can. Publ., Ottawa, Ont., Canada. 132 pp.

Bailey, L. H., Bailey, E. Z. 1976. Hortus third. Revised. MacMillan, New York, N.Y., USA. 1290 pp.

Scoggan, H. J. 1978, 1979. The flora of Canada. Nat. Mus. Nat. Sci. (Ottawa) Publ. Bot. 7(1)-7(4). 1711 pp.

Van Wijk, H. L. 1911. A dictionary of plant names. Martinus Nijhoff, The Hague, The Netherlands. 1444 pp.

Victorin, M. 1964. Flore Laurentienne. 2nd ed. Univ. Montreal, Montreal, Que., Canada. 952 pp.

Geographic Information

New Brunswick

Ontario

Quebec

References:

Bailey, L. H., Bailey, E. Z. 1976. Hortus third. Revised. MacMillan, New York, N.Y., USA. 1290 pp.

Boivin, B. 1966, 1967. Énumération des plantes du Canada. Provencheria 6. Nat. Can. (Que.) 93: 253-274; 371-437; 583-646; 989-1063. 94: 131-157; 471-528; 625-655.

Image or illustration

leatherwood:

Images: images.google.com

Toxic parts:

bark

References:

Fyles, F. 1920. Principal poisonous plants of Canada. Can. Dep. Agric. Exp. Farms. Bull. 39. 112 pp.

Toxic plant chemicals:

unknown chemical

References:

Fyles, F. 1920. Principal poisonous plants of Canada. Can. Dep. Agric. Exp. Farms. Bull. 39. 112 pp.

Animals/Human Poisoning:

Note: When an animal is listed without additional information, the literature (as of 1993) contained no detailed explanation.

Humans

General symptoms of poisoning:

[blistering](#)
[mouth, irritation of](#)

References:

Fyles, F. 1920. Principal poisonous plants of Canada. Can. Dep. Agric. Exp. Farms. Bull. 39. 112 pp.

Lampe, K. F., McCann, M. A. 1985. AMA Handbook of poisonous and injurious plants. American Medical Assoc. Chicago, Ill., USA. 432 pp.

[Another search?](#)

[Français](#) | [Contact Us](#) | [Help](#) | [Search](#) | [Canada site](#)
[Coming Events](#) | [About CBIF](#) | [Links](#) | [Reports and Publications](#) | [Home](#)

Date modified: 2003-02-06

[Important Notices](#)



Français	Contact us	Help	Search	Canada site
Coming events	About CBIF	Links	Reports and publications	Home

Canadian Biodiversity Information Facility



Notes on poisoning: lily-of-the-valley

[Introduction](#)

[Interactive](#)

[All poisonous plants by Botanical name](#)

[All poisonous plants by Common name](#)

[Important WWW Poisonous Plants sites](#)



General poisoning notes:

Lily-of-the-valley (*Convallaria majalis*) is a perennial outdoor ornamental herb. The plant contains cardiac glycosides as well as saponins. There are some references in the literature that mention poisoning and death in humans after accidental ingestion of the berries and leaves, and even by drinking the water that the plants were kept in. Frohne and Pfander (1983) suggest that serious cases are unlikely to occur because the glycosides are poorly absorbed. They cast doubt on the report of poisoning by ingesting water that lily-of-the-valley was standing in because experiments with animals did not substantiate these reports. However, in spite of these reservations, some cases of human poisoning are mentioned in the literature, and so these plants should be considered potentially poisonous. Because of the cardiac glycosides and saponins found in this plant, animals that have access to the plant material may be poisoned. Certainly, ingesting large quantities of lily-of-the-valley can cause problems to family pets such as cats and dogs.

References:

Cooper, M. R., Johnson, A. W. 1984. Poisonous plants in Britain and their effects on animals and man. Her Majesty's Stationery Office, London, England. 305 pp.

Frohne, D., Pfander, H. J. 1983. A colour atlas of poisonous plants. Wolfe Publishing Ltd., London, England. 291 pp.

Nomenclature:

Scientific Name: *Convallaria majalis* L.

Vernacular name(s): lily-of-the-valley

Scientific family name: *Liliaceae*

Vernacular family name: lily

Go to ITIS^{*ca} for more taxonomic information on: [Convallaria majalis](#)

References:

Agriculture Quebec. 1975. Noms des maladies des plantes du Canada/ Names of plant diseases in Canada. , Quebec City, Que., Canada. 288 pp.

Alex, J. F., Cayouette, R., Mulligan, G. A. 1980. Common and botanical names of weeds in Canada/Noms populaire et scientifiques des plantes nuisibles du Canada. Revised. Agric. Can. Publ., Ottawa, Ont., Canada. 132 pp.

Bailey, L. H., Bailey, E. Z. 1976. Hortus third. Revised. MacMillan, New York, N.Y., USA. 1290 pp.

Scoggan, H. J. 1978, 1979. The flora of Canada. Nat. Mus. Nat. Sci. (Ottawa) Publ. Bot. 7(1)-7(4). 1711 pp.

Van Wijk, H. L. 1911. A dictionary of plant names. Martinus Nijhoff, The Hague, The Netherlands. 1444 pp.

Victorin, M. 1964. Flore Laurentienne. 2nd ed. Univ. Montreal, Montreal, Que., Canada. 952 pp.

Geographic Information

Plant or plant parts used in or around the home.

References:

Bailey, L. H., Bailey, E. Z. 1976. Hortus third. Revised. MacMillan, New York, N.Y., USA. 1290 pp.

Boivin, B. 1966, 1967. Énumération des plantes du Canada. Provencheria 6. Nat. Can. (Que.) 93: 253-274; 371-437; 583-646; 989-1063. 94: 131-157; 471-528; 625-655.

Image or illustration

lily-of-the-valley:

Images: images.google.com

Toxic parts:

all parts
flowers
leaves

mature fruit

roots

References:

Lampe, K. F., McCann, M. A. 1985. AMA Handbook of poisonous and injurious plants. American Medical Assoc. Chicago, Ill., USA. 432 pp.

Notes on Toxic plant chemicals:

Convallotoxin is one of the most toxic naturally occurring substances affecting the heart. These glycosides cause irregularities in heart action (Cooper and Johnson 1984).

Toxic plant chemicals:

convallatoxin

convalloside

References:

Cooper, M. R., Johnson, A. W. 1984. Poisonous plants in Britain and their effects on animals and man. Her Majesty's Stationery Office, London, England. 305 pp.

Joubert, J. P. 1989. Cardiac glycosides. Pages 61-97 in Cheeke, P. R., ed. Toxicants of plant origin. Vol. II. Glycosides. CRC Press, Inc., Boca Raton, Fla., USA. 277 pp.

Animals/Human Poisoning:

Note: When an animal is listed without additional information, the literature (as of 1993) contained no detailed explanation.

Cats

Dogs

Humans

General symptoms of poisoning:

[abdominal pains](#)

[gastroenteritis](#)

[headache](#)

[nausea](#)

[pupil dilation](#)

[vomiting](#)

Notes on poisoning:

Symptoms of ingestion include irregular heart rate and cold and clammy skin. Coma and death from heart failure may occur if enough plant material is ingested (Cooper and Johnson 1984).

References:

Cooper, M. R., Johnson, A. W. 1984. Poisonous plants in Britain and their effects on animals and man. Her Majesty's Stationery Office, London, England. 305 pp.

Frohne, D., Pfander, H. J. 1983. A colour atlas of poisonous plants. Wolfe Publishing Ltd., London, England. 291 pp.

[Another search?](#)

[Français](#) | [Contact Us](#) | [Help](#) | [Search](#) | [Canada site](#)

[Coming Events](#) | [About CBIF](#) | [Links](#) | [Reports and Publications](#) |

[Home](#)

Date modified: 2003-02-06

[Important Notices](#)



Français	Contact us	Help	Search	Canada site
Coming events	About CBIF	Links	Reports and publications	Home

Canadian Biodiversity Information Facility



Notes on poisoning: locoweed (*Oxytropis sericea*)

[Introduction](#)[Interactive](#)[All poisonous plants by Botanical name](#)[All poisonous plants by Common name](#)[Important WWW Poisonous Plants sites](#)

General poisoning notes:



Locoweed (*Oxytropis sericea*) is a native herb in western Canada. This plant has caused a number of problems in cattle, horses, and sheep. Swainsonine, an indolizidine alkaloid, inhibits alpha-mannosidase in animal bodies, which can lead to disruption of cellular function. Locoism is a chronic disease that causes depression, incoordination, and nervousness under stress. Death can result. The cellular problems occur most readily in tissues of the nervous system. Pregnant animals often abort or give birth to young with congenital deformities. Congestive right heart disease occurs at high altitudes (above 2190 m) in cattle. Right ventricular hypertrophy and dilation, subcutaneous edema, and pulmonary hypertension are significant symptoms (James 1983, Cheeke and Schull 1985, James et al. 1986, Panter et al. 1988).

References:

Cheeke, P. R., Shull, L. R. 1985. Natural toxicants in feeds and poisonous plants. AVI Publishing Company, Inc., Westport, Conn., USA. 492 pp.

James, L. F., Hartley, W. J., Nielsen, D., Allen, S., Panter, K. E. 1986. Locoweed (*Oxytropis sericea*) poisoning and congestive heart failure in cattle. J. Am. Vet. Med. Assoc., 189: 1549-1556.

James, L. F. 1983. Neurotoxins and other toxins from *Astragalus* and related genera. Pages 445-462 in Keeler, R. F., Tu, A. T., eds. Handbook of natural toxins. Vol. 1. Plant and Fungal toxins. Marcel Dekker, Inc., New York, N.Y., USA. 934 pp.

Panter, K. E., James, L. F., Nielson, D., Molyneux, R. J., Ralphs, M. H. 1988. The relationship of *Oxytropis sericea* (green and dry) and *Astragalus lentiginosus* with high mountain disease in cattle. Vet. Hum. Toxicol., 30: 318-323.

Ralphs, M. H., James, L. F., Nielsen, D. B., Panter, K. E. 1984. Management practices reduce cattle loss to locoweed on high mountain range. *Rangelands*, 6: 175-177.

Ralphs, M. H., James, L. F., Pfister, J. A. 1986. Utilization of white locoweed (*Oxytropis sericea* Nutt.) by range cattle. *J. Range Manage.*, 39: 344-347.

Nomenclature:

Scientific Name: *Oxytropis sericea* Nutt.

Vernacular name(s): locoweed (*Oxytropis sericea*)

Scientific family name: *Leguminosae*

Vernacular family name: pea

Go to ITIS^{*ca} for more taxonomic information on: [Oxytropis sericea](#)

References:

Agriculture Quebec. 1975. Noms des maladies des plantes du Canada/ Names of plant diseases in Canada. , Quebec City, Que., Canada. 288 pp.

Alex, J. F., Cayouette, R., Mulligan, G. A. 1980. Common and botanical names of weeds in Canada/Noms populaire et scientifiques des plantes nuisibles du Canada. Revised. Agric. Can. Publ., Ottawa, Ont., Canada. 132 pp.

Bailey, L. H., Bailey, E. Z. 1976. Hortus third. Revised. MacMillan, New York, N.Y., USA. 1290 pp.

Scoggan, H. J. 1978, 1979. The flora of Canada. Nat. Mus. Nat. Sci. (Ottawa) Publ. Bot. 7(1)-7(4). 1711 pp.

Van Wijk, H. L. 1911. A dictionary of plant names. Martinus Nijhoff, The Hague, The Netherlands. 1444 pp.

Victorin, M. 1964. Flore Laurentienne. 2nd ed. Univ. Montreal, Montreal, Que., Canada. 952 pp.

Geographic Information

Alberta
British Columbia
Saskatchewan
Yukon Territory

References:

Bailey, L. H., Bailey, E. Z. 1976. Hortus third. Revised. MacMillan, New York, N.Y., USA. 1290 pp.

Boivin, B. 1966, 1967. Énumération des plantes du Canada. Provencheria 6. Nat. Can. (Que.) 93: 253-274; 371-437; 583-646; 989-1063. 94: 131-157; 471-528; 625-655.

Image or illustration

locoweed (*Oxytropis sericea*):

Images: images.google.com

Notes on Poisonous plant parts:

The blooms and mature fruit of locoweed have higher quantities of the toxin swainsonine than do the leaves. The concentration of this toxin remains constant in leaves throughout the grazing season (Ralphs et al. 1986.)

Toxic parts:

flowers
leaves
mature fruit
seeds
stems

References:

James, L. F., Hartley, W. J., Nielsen, D., Allen, S., Panter, K. E. 1986. Locoweed (*Oxytropis sericea*) poisoning and congestive heart failure in cattle. J. Am. Vet. Med. Assoc., 189: 1549-1556.

James, L. F. 1983. Neurotoxins and other toxins from *Astragalus* and related genera. Pages 445-462 in Keeler, R. F., Tu, A. T., eds. Handbook of natural toxins. Vol. 1. Plant and Fungal toxins. Marcel Dekker, Inc., New York, N.Y., USA. 934 pp.

Panter, K. E., James, L. F., Nielson, D., Molyneux, R. J., Ralphs, M. H. 1988. The relationship of *Oxytropis sericea* (green and dry) and *Astragalus lentiginosus* with high mountain disease in cattle. Vet. Hum. Toxicol., 30: 318-323.

Ralphs, M. H., James, L. F., Nielsen, D. B., Panter, K. E. 1984. Management practices reduce cattle loss to locoweed on high mountain range. Rangelands, 6: 175-177.

Ralphs, M. H., James, L. F., Pfister, J. A. 1986. Utilization of

white locoweed (*Oxytropis sericea* Nutt.) by range cattle. J. Range Manage., 39: 344-347.

Notes on Toxic plant chemicals:

Swainsonine, an indolizidine alkaloid, inhibits alpha-mannosidase in the animal's body. Inhibition results in the accumulation of oligosaccharides in cells because glycosidases remove their respective sugars until a mannose residue is reached. Hydrolysis of the carbohydrate then stops. Eventually disruption of cellular function results. The effect of swainsonine on alpha-mannosidase is reversible when locoweed is no longer consumed. However, advanced clinical signs are irreversible because axon degeneration occurs. The central nervous system is most sensitive to mannose accumulation (Cheeke and Schull 1985).

Toxic plant chemicals:

slaframine
swainsonine

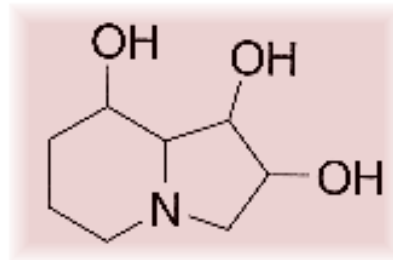

Chemical diagram(s) are courtesy of [Ruth McDiarmid](#), Biochemistry Technician, Kamloops Range Station, Agriculture and Agri-Food Canada, Kamloops, British Columbia, Canada.

References:

Cheeke, P. R., Shull, L. R. 1985. Natural toxicants in feeds and poisonous plants. AVI Publishing Company, Inc., Westport, Conn., USA. 492 pp.

Molyneux, R. J., James, L. F. 1982. Loco intoxication: indolizidine alkaloids of spotted locoweed (*Astragalus lentiginosus*). Science (Wash. D. C.), 216: 190-191.

Ralphs, M. H., James, L. F., Pfister, J. A. 1986. Utilization of white locoweed (*Oxytropis sericea* Nutt.) by range cattle. J. Range Manage., 39: 344-347.

Animals/Human Poisoning:

Note: When an animal is listed without additional information,

the literature (as of 1993) contained no detailed explanation.

Cattle

General symptoms of poisoning:

[abdominal edema](#)

[belligerence](#)

[coat, rough and dry](#)

[death](#)

[depression](#)

[diarrhea](#)

[duodenum, edema of](#)

[eyes, dull](#)

[gall bladder, enlarged](#)

[incoordination](#)

[jaw \(lower\), edema of](#)

[thorax \(ventral\),edema](#)

[throat, edema of](#)

[ventricular\(right\),edema](#)

References:

Cheeke, P. R., Shull, L. R. 1985. Natural toxicants in feeds and poisonous plants. AVI Publishing Company, Inc., Westport, Conn., USA. 492 pp.

James, L. F., Hartley, W. J., Nielsen, D., Allen, S., Panter, K. E. 1986. Locoweed (*Oxytropis sericea*) poisoning and congestive heart failure in cattle. J. Am. Vet. Med. Assoc., 189: 1549-1556.

Panter, K. E., James, L. F., Nielson, D., Molyneux, R. J., Ralphs, M. H. 1988. The relationship of *Oxytropis sericea* (green and dry) and *Astragalus lentiginosus* with high mountain disease in cattle. Vet. Hum. Toxicol., 30: 318-323.

Ralphs, M. H., James, L. F., Nielsen, D. B., Panter, K. E. 1984. Management practices reduce cattle loss to locoweed on high mountain range. Rangelands, 6: 175-177.

Horses

General symptoms of poisoning:

[arthrogryposis](#)

[coat, rough and dry](#)

[depression](#)

[gait, unsteady](#)

[incoordination](#)

[nervousness](#)

References:

James, L. F. 1983. Neurotoxins and other toxins from *Astragalus* and related genera. Pages 445-462 in Keeler, R. F., Tu, A. T., eds. Handbook of natural toxins. Vol. 1. Plant and Fungal toxins. Marcel Dekker, Inc., New York, N.Y., USA. 934 pp.

Sheep

General symptoms of poisoning:

[abortion](#)

[carpal joint, flexure](#)

[coat, rough and dry](#)

[death](#)

[depression](#)

[eyes, dull](#)

[incoordination](#)

[nervousness](#)

[recumbency](#)

References:

Cheeke, P. R., Shull, L. R. 1985. Natural toxicants in feeds and poisonous plants. AVI Publishing Company, Inc., Westport, Conn., USA. 492 pp.

[Another search?](#)

[Français](#) | [Contact Us](#) | [Help](#) | [Search](#) | [Canada site](#)

[Coming Events](#) | [About CBIF](#) | [Links](#) | [Reports and Publications](#) |

[Home](#)

Date modified: 2003-02-06

[Important Notices](#)



Français	Contact us	Help	Search	Canada site
Coming events	About CBIF	Links	Reports and publications	Home

Canadian Biodiversity Information Facility



Notes on poisoning: low larkspur

[Introduction](#)

[Interactive](#)

[All poisonous plants by Botanical name](#)

[All poisonous plants by Common name](#)

[Important WWW Poisonous Plants sites](#)



General poisoning notes:

Low larkspur (*Delphinium bicolor*) is a native herb found in southern parts of western Canada. This plant has poisoned cattle, symptoms are similar to those caused by tall larkspur ([Delphinium glaucum](#).)

References:

Olsen, J. D., Manners, G. D. 1989. Toxicology of diterpenoid alkaloids in rangeland larkspur (*Delphinium* spp.). Pages 291-326 in Cheeke, P. R., ed. Toxicants of plant origin. Vol. I. Alkaloids. CRC Press, Inc., Boca Raton, Fla., USA. 335 pp.

Nomenclature:

Scientific Name: *Delphinium bicolor* Nutt.

Vernacular name(s): low larkspur

Scientific family name: *Ranunculaceae*

Vernacular family name: crowfoot

Go to ITIS*^{ca} for more taxonomic information on: [Delphinium bicolor](#)

References:

Agriculture Quebec. 1975. Noms des maladies des plantes du Canada/ Names of plant diseases in Canada. , Quebec City, Que., Canada. 288 pp.

Alex, J. F., Cayouette, R., Mulligan, G. A. 1980. Common and botanical names of weeds in Canada/Noms populaire et scientifiques des plantes nuisibles du Canada. Revised. Agric. Can. Publ., Ottawa, Ont., Canada. 132 pp.

Bailey, L. H., Bailey, E. Z. 1976. Hortus third. Revised. MacMillan,

New York, N.Y., USA. 1290 pp.

Scoggan, H. J. 1978, 1979. The flora of Canada. Nat. Mus. Nat. Sci. (Ottawa) Publ. Bot. 7(1)-7(4). 1711 pp.

Van Wijk, H. L. 1911. A dictionary of plant names. Martinus Nijhoff, The Hague, The Netherlands. 1444 pp.

Victorin, M. 1964. Flore Laurentienne. 2nd ed. Univ. Montreal, Montreal, Que., Canada. 952 pp.

Geographic Information

Alberta

British Columbia

Saskatchewan

References:

Bailey, L. H., Bailey, E. Z. 1976. Hortus third. Revised. MacMillan, New York, N.Y., USA. 1290 pp.

Boivin, B. 1966, 1967. Énumération des plantes du Canada. Provencheria 6. Nat. Can. (Que.) 93: 253-274; 371-437; 583-646; 989-1063. 94: 131-157; 471-528; 625-655.

Image or illustration

low larkspur:

Images: images.google.com

Notes on Poisonous plant parts:

See additional information under general notes of [Delphinium glaucum](#).

Toxic parts:

leaves

seeds

References:

Olsen, J. D., Manners, G. D. 1989. Toxicology of diterpenoid alkaloids in rangeland larkspur (*Delphinium* spp.). Pages 291-326 in Cheeke, P. R., ed. Toxicants of plant origin. Vol. I. Alkaloids. CRC Press, Inc., Boca Raton, Fla., USA. 335 pp.

Notes on Toxic plant chemicals:

See additional information under general notes of [Delphinium glaucum](#).

Toxic plant chemicals:

methyllycaconitine

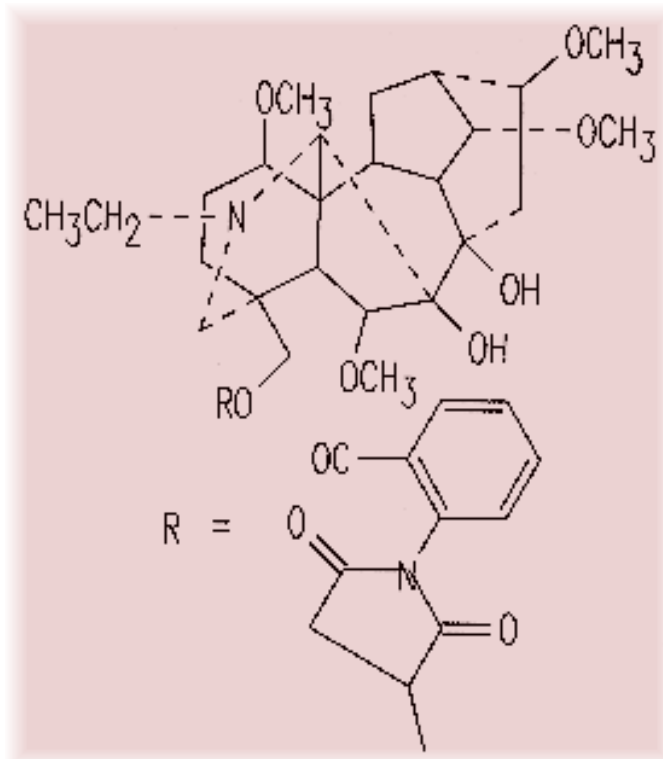

Chemical diagram(s) are courtesy of [Ruth McDiarmid](#), Biochemistry Technician, Kamloops Range Station, Agriculture and Agri-Food Canada, Kamloops, British Columbia, Canada.

References:

Olsen, J. D., Manners, G. D. 1989. Toxicology of diterpenoid alkaloids in rangeland larkspur (*Delphinium* spp.). Pages 291-326 in Cheeke, P. R., ed. Toxicants of plant origin. Vol. I. Alkaloids. CRC Press, Inc., Boca Raton, Fla., USA. 335 pp.

Animals/Human Poisoning:

Note: When an animal is listed without additional information, the literature (as of 1993) contained no detailed explanation.

Cattle

General symptoms of poisoning:

[bloat](#)

[constipation](#)

[death by asphyxiation](#)

[paralysis](#)

[salivation](#)

[weakness](#)

References:

Olsen, J. D., Manners, G. D. 1989. Toxicology of diterpenoid alkaloids in rangeland larkspur (*Delphinium* spp.). Pages 291-326 in Cheeke, P. R., ed. Toxicants of plant origin. Vol. I. Alkaloids. CRC Press, Inc., Boca Raton, Fla., USA. 335 pp.

Horses

Sheep

[Another search?](#)

[Français](#) | [Contact Us](#) | [Help](#) | [Search](#) | [Canada site](#)

[Coming Events](#) | [About CBIF](#) | [Links](#) | [Reports and Publications](#) | [Home](#)

Date modified: 2003-02-06

[Important Notices](#)



Français	Contact us	Help	Search	Canada site
Coming events	About CBIF	Links	Reports and publications	Home

Canadian Biodiversity Information Facility



Notes on poisoning: maidenhair tree

[Introduction](#)

[Interactive](#)

[All poisonous plants by Botanical name](#)

[All poisonous plants by Common name](#)

[Important WWW Poisonous Plants sites](#)



General poisoning notes:

Ginkgo (*Ginkgo biloba*) is an ornamental tree growing in the warmer parts of Canada. This plant is of botanical interest because it is the sole survivor of the order Ginkgoales, with fossil evidence tracing back over 200 million years. The tree now survives only in cultivation. The trees are planted for their beautifully shaped leaves, which turn an attractive yellow in autumn. Usually only male trees are planted because the fleshy pulp on the fruits develop an obnoxious smell resembling rancid butter when the pulp is deteriorating on the ground. The interior kernel of the fruit is considered a delicacy by people of Chinese, Japanese, and southeast Asian descent. Contact dermatitis occurs in sensitive individuals when they remove the fleshy pulp from the seeds in the autumn. Children who handle the attractive yellow fruits may develop dermatitis. The pulp is also used as a folk medicine in China and Japan. The crude extract contains a toxin that causes convulsions and death if used in excess. This type of poisoning is unlikely unless the extract (gin-nan) is available in Canada.

References:

Lepoittevin, J.-P., Benezra, C., Asakawa, Y. 1989. Allergic contact dermatitis to *Ginkgo biloba* L.: relationship with urushiol. Arch. Dermatol. Res., 281: 227-230.

Tomb, R. R., Fousereau, J., Sell, Y. 1988. Mini-epidemic of contact dermatitis from ginkgo tree fruit (*Ginkgo biloba* L.). Contact Dermatitis, 19: 281-283.

Wada, K., Ishigaki, S., Ueda, K., Take, Y., Sasaki, K., Sakata, M., Haga, M. 1988. Studies on the constitution of edible and medicinal plants. 1. Isolation and identification of 4-O-methylpyridoxine, toxic principle from the seed of *Ginkgo biloba* L. Chem. Pharm. Bull. (Tokyo), 36: 1779-1782.

Nomenclature:

Scientific Name: *Ginkgo biloba* L.

References:

Agriculture Quebec. 1975. Noms des maladies des plantes du Canada/ Names of plant diseases in Canada. , Quebec City, Que., Canada. 288 pp.

Alex, J. F., Cayouette, R., Mulligan, G. A. 1980. Common and botanical names of weeds in Canada/Noms populaire et scientifiques des plantes nuisibles du Canada. Revised. Agric. Can. Publ., Ottawa, Ont., Canada. 132 pp.

Bailey, L. H., Bailey, E. Z. 1976. Hortus third. Revised. MacMillan, New York, N.Y., USA. 1290 pp.

Scoggan, H. J. 1978, 1979. The flora of Canada. Nat. Mus. Nat. Sci. (Ottawa) Publ. Bot. 7(1)-7(4). 1711 pp.

Van Wijk, H. L. 1911. A dictionary of plant names. Martinus Nijhoff, The Hague, The Netherlands. 1444 pp.

Victorin, M. 1964. Flore Laurentienne. 2nd ed. Univ. Montreal, Montreal, Que., Canada. 952 pp.

Geographic Information

Plant or plant parts used in or around the home.

References:

Bailey, L. H., Bailey, E. Z. 1976. Hortus third. Revised. MacMillan, New York, N.Y., USA. 1290 pp.

Boivin, B. 1966, 1967. Énumération des plantes du Canada. Provencheria 6. Nat. Can. (Que.) 93: 253-274; 371-437; 583-646; 989-1063. 94: 131-157; 471-528; 625-655.

Image or illustration

maidenhair tree:

Images: images.google.com

Notes on Poisonous plant parts:

The endosperm (the food storage tissues) of the seeds contains a chemical that can cause convulsions and death in humans if taken

in excessive quantities. The Chinese and Japanese use a crude extract of ginkgo seed, called gin-nan, as an antitussive and expectorant in folk medicine. Excessive use of this extract has caused gin-nan food poisoning in China and Japan. Some deaths have occurred. Ginkgo seeds can be obtained in specialized food stores, and ginkgo trees grow and bear fruit at least in some areas of the country, such as Ottawa. The seeds are often picked by Chinese and Japanese for food consumption. The seed coat and the fruit pulp of ginkgo can cause allergic contact dermatitis. This most often happens when the fruit pulp is removed to get at the seed, which is considered a delicacy in Chinese and Japanese cooking (Nakamura 1985).

Toxic parts:

mature fruit
seeds

References:

Lepoittevin, J.-P., Benezra, C., Asakawa, Y. 1989. Allergic contact dermatitis to *Ginkgo biloba* L.: relationship with urushiol. Arch. Dermatol. Res., 281: 227-230.

Tomb, R. R., Foussereau, J., Sell, Y. 1988. Mini-epidemic of contact dermatitis from ginkgo tree fruit (*Ginkgo biloba* L.). Contact Dermatitis, 19: 281-283.

Wada, K., Ishigaki, S., Ueda, K., Take, Y., Sasaki, K., Sakata, M., Haga, M. 1988. Studies on the constitution of edible and medicinal plants. 1. Isolation and identification of 4-O-methylpyridoxine, toxic principle from the seed of *Ginkgo biloba* L. Chem. Pharm. Bull. (Tokyo), 36: 1779-1782.

Notes on Toxic plant chemicals:

4-O-Methylpyridoxine is a chemical that has an antivitamin B6 activity. This chemical is found in the endosperm (the food storage tissue) of the seeds. The chemical causes convulsions in guinea pigs at oral doses of 11 mg/kg. 4-O-Methylpyridoxine also inhibits the formation of 4-aminobutyric acid from glutamate, which might induce seizures (Wada et al. 1988). Ginkgolic acids 1 are aromatic compounds found in the pulpy exterior of the fruit of ginkgo. These chemicals cause allergic contact dermatitis. Lepoittevin et al. (1989) determined that despite the close structure between ginkgolic acids 1 and the components of urushiol 4 (the allergen of poison-ivy), the hypothesis that the acids transform into catechol 4 in vivo (as with poison-ivy) cannot be supported. Cross-reactivity between ginkgo and urushiol did not occur when tested on guinea pigs.

Toxic plant chemicals:

ginkgolic acids 1
4-O-methylpyridoxine

References:

Lepoittevin, J.-P., Benezra, C., Asakawa, Y. 1989. Allergic contact dermatitis to *Ginkgo biloba* L.: relationship with urushiol. Arch. Dermatol. Res., 281: 227-230.

Wada, K., Ishigaki, S., Ueda, K., Take, Y., Sasaki, K., Sakata, M., Haga, M. 1988. Studies on the constitution of edible and medicinal plants. 1. Isolation and identification of 4-O-methylpyridoxine, toxic principle from the seed of *Ginkgo biloba* L. Chem. Pharm. Bull. (Tokyo), 36: 1779-1782.

Animals/Human Poisoning:

Note: When an animal is listed without additional information, the literature (as of 1993) contained no detailed explanation.

Humans

General symptoms of poisoning:

[convulsions](#)

[death](#)

[erythema](#)

[unconsciousness](#)

Notes on poisoning:

A crude extract of ginkgo seeds is used in folk medicine in China and Japan. Excessive use can cause convulsions, unconsciousness, and death. Infants are especially vulnerable (Wada et al. 1988).

References:

Lepoittevin, J.-P., Benezra, C., Asakawa, Y. 1989. Allergic contact dermatitis to *Ginkgo biloba* L.: relationship with urushiol. Arch. Dermatol. Res., 281: 227-230.

Tomb, R. R., Foussereau, J., Sell, Y. 1988. Mini-epidemic of contact dermatitis from ginkgo tree fruit (*Ginkgo biloba* L.). Contact Dermatitis, 19: 281-283.

Wada, K., Ishigaki, S., Ueda, K., Take, Y., Sasaki, K., Sakata, M., Haga, M. 1988. Studies on the constitution of edible and medicinal plants. 1. Isolation and identification of

4-O-methylpyridoxine, toxic principle from the seed of *Ginkgo biloba* L. Chem. Pharm. Bull. (Tokyo), 36: 1779-1782.

[Another search?](#)

[Français](#) | [Contact Us](#) | [Help](#) | [Search](#) | [Canada site](#)

[Coming Events](#) | [About CBIF](#) | [Links](#) | [Reports and Publications](#) |

[Home](#)

Date modified: 2003-02-06

[Important Notices](#)



Français	Contact us	Help	Search	Canada site
Coming events	About CBIF	Links	Reports and publications	Home

Canadian Biodiversity Information Facility



Notes on poisoning: mango

[Introduction](#)[Interactive](#)[All poisonous plants by Botanical name](#)[All poisonous plants by Common name](#)[Important WWW Poisonous Plants sites](#)

General poisoning notes:

Mango (*Mangifera indica*) is a tropical fruit that is seasonally available in Canadian food stores. The skin of the fruit and the petiole, by which the fruit is attached to the stem, contain oleoresins. These chemicals are cross-reactive to the catechols contained in poison-ivy plants and in other members of *Rhus* species that cause dermatitis. Humans who are sensitized and develop dermatitis from these plants should be cautious about touching the skin of mangoes. The shells of cashews (*Anacardium occidentale*) are also cross-reactive with catechols of *Rhus* species. However, cashews shells are removed before the nuts are sold in Canada (Kingsbury 1964, Geller 1989).

References:

Geller, M. 1989. Poison ivy, mangoes, cashews, and dermatitis. *Ann. Intern. Med.*, 110: 1036-1037.

Kingsbury, J. M. 1964. *Poisonous plants of the United States and Canada*. Prentice-Hall Inc., Englewood Cliffs, N.J., USA. 626 pp.

Nomenclature:

Scientific Name: *Mangifera indica* L.

Vernacular name(s): mango

Scientific family name: *Anacardiaceae*

Vernacular family name: cashew

Go to ITIS*^{ca} for more taxonomic information on: [Mangifera indica](#)

References:

Agriculture Quebec. 1975. Noms des maladies des plantes du Canada/ Names of plant diseases in Canada. , Quebec City, Que., Canada. 288 pp.

Alex, J. F., Cayouette, R., Mulligan, G. A. 1980. Common and botanical names of weeds in Canada/Noms populaire et scientifiques des plantes nuisibles du Canada. Revised. Agric. Can. Publ., Ottawa, Ont., Canada. 132 pp.

Bailey, L. H., Bailey, E. Z. 1976. Hortus third. Revised. MacMillan, New York, N.Y., USA. 1290 pp.

Scoggan, H. J. 1978, 1979. The flora of Canada. Nat. Mus. Nat. Sci. (Ottawa) Publ. Bot. 7(1)-7(4). 1711 pp.

Van Wijk, H. L. 1911. A dictionary of plant names. Martinus Nijhoff, The Hague, The Netherlands. 1444 pp.

Victorin, M. 1964. Flore Laurentienne. 2nd ed. Univ. Montreal, Montreal, Que., Canada. 952 pp.

Geographic Information

Plant or plant parts used in or around the home.

References:

Bailey, L. H., Bailey, E. Z. 1976. Hortus third. Revised. MacMillan, New York, N.Y., USA. 1290 pp.

Boivin, B. 1966, 1967. Énumération des plantes du Canada. Provencheria 6. Nat. Can. (Que.) 93: 253-274; 371-437; 583-646; 989-1063. 94: 131-157; 471-528; 625-655.

Image or illustration

mango:

Images: images.google.com

Notes on Poisonous plant parts:

The skin of the fruit and the petiole, by which the fruit is attached to the stem, contain oleoresins (Geller 1989).

Toxic parts:

skin of fruit

References:

Geller, M. 1989. Poison ivy, mangoes, cashews, and dermatitis. *Ann. Intern. Med.*, 110: 1036-1037.

Notes on Toxic plant chemicals:

The oleoresins of the fruit peel (skin) of mango are cross-reactive with the catechols of poison-ivy, [Rhus spp.](#) (Geller 1989).

Toxic plant chemicals:

oleoresin

References:

Geller, M. 1989. Poison ivy, mangoes, cashews, and dermatitis. *Ann. Intern. Med.*, 110: 1036-1037.

Animals/Human Poisoning:

Note: When an animal is listed without additional information, the literature (as of 1993) contained no detailed explanation.

Humans

General symptoms of poisoning:

[blisters, weeping](#)

[erythema](#)

References:

Geller, M. 1989. Poison ivy, mangoes, cashews, and dermatitis. *Ann. Intern. Med.*, 110: 1036-1037.

[Another search?](#)

[Français](#) | [Contact Us](#) | [Help](#) | [Search](#) | [Canada site](#)

[Coming Events](#) | [About CBIF](#) | [Links](#) | [Reports and Publications](#) |

[Home](#)

Date modified: 2003-02-06

[Important Notices](#)



Français	Contact us	Help	Search	Canada site
Coming events	About CBIF	Links	Reports and publications	Home

Canadian Biodiversity Information Facility



Notes on poisoning: marijuana

[Introduction](#)

[Interactive](#)

[All poisonous plants by Botanical name](#)

[All poisonous plants by Common name](#)

[Important WWW Poisonous Plants sites](#)



General poisoning notes:

Accidental ingestion of marijuana (*Cannabis sativa*) by pets is an occasional problem. Family pets or young children may accidentally ingest the plant, which may be stored in plastic bags. A dog ingested hashish brownies and then exhibited various symptoms such as hyperactivity, vomiting, somnolence, staggering, and glazed eyes. In another case, in Edmonton, a pet ferret ingested the plant and became comatose after experiencing sneezing bouts and ataxia. Although no fatalities of humans have been reported, the effects on a young child accidentally ingesting marijuana are bound to be very disturbing to the parents (Jones 1978, Smith 1988).

References:

- Jones, D. L. 1978. A case of canine cannabis ingestion. *N. Z. Vet. J.*, 26: 135-136.
- Smith, R. A. 1988. Coma in a ferret after ingestion of cannabis. *Vet. Hum. Toxicol.*, 30: 486.

Nomenclature:

Scientific Name: *Cannabis sativa* L.

Vernacular name(s): marijuana

Scientific family name: *Cannabinaceae*

Vernacular family name: hemp

Go to ITIS*^{ca} for more taxonomic information on: [Cannabis sativa](#)

References:

Agriculture Quebec. 1975. Noms des maladies des plantes du Canada/ Names of plant diseases in Canada. , Quebec City, Que., Canada. 288 pp.

Alex, J. F., Cayouette, R., Mulligan, G. A. 1980. Common and botanical names of weeds in Canada/Noms populaire et scientifiques des plantes nuisibles du Canada. Revised. Agric. Can. Publ., Ottawa, Ont., Canada. 132 pp.

Bailey, L. H., Bailey, E. Z. 1976. Hortus third. Revised. MacMillan, New York, N.Y., USA. 1290 pp.

Scoggan, H. J. 1978, 1979. The flora of Canada. Nat. Mus. Nat. Sci. (Ottawa) Publ. Bot. 7(1)-7(4). 1711 pp.

Van Wijk, H. L. 1911. A dictionary of plant names. Martinus Nijhoff, The Hague, The Netherlands. 1444 pp.

Victorin, M. 1964. Flore Laurentienne. 2nd ed. Univ. Montreal, Montreal, Que., Canada. 952 pp.

Geographic Information

Alberta
British Columbia
Manitoba
Ontario
Quebec

References:

Bailey, L. H., Bailey, E. Z. 1976. Hortus third. Revised. MacMillan, New York, N.Y., USA. 1290 pp.

Boivin, B. 1966, 1967. Énumération des plantes du Canada. Provencheria 6. Nat. Can. (Que.) 93: 253-274; 371-437; 583-646; 989-1063. 94: 131-157; 471-528; 625-655.

Image or illustration

marijuana:

Images: images.google.com

Notes on Poisonous plant parts:

The resins in the leaves are psychoactive in mammals, including humans. These plants are cultivated indoors and outdoors for human use. The plants can overwinter as seed in warmer parts of

the country. The most common form that may be accidentally ingested by humans and pets is marijuana that has been left in houses for illegal human use.

Toxic parts:

flowers
leaves

References:

Small, E., Cronquist, A. 1976. A practical and natural taxonomy for *Cannabis*. *Taxon*, 25: 405-435.

Notes on Toxic plant chemicals:

Delta-tetrahydrocannabinol (THC) is the chemical most often cited as causing the psychoactive compound in marijuana. This chemical affects humans and many other mammals. Any children or pets that accidentally ingest quantities of marijuana may show various symptoms, including coma.

Toxic plant chemicals:

tetrahydrocannabinol

References:

Small, E., Cronquist, A. 1976. A practical and natural taxonomy for *Cannabis*. *Taxon*, 25: 405-435.

Animals/Human Poisoning:

Note: When an animal is listed without additional information, the literature (as of 1993) contained no detailed explanation.

Dogs

General symptoms of poisoning:

[agitation](#)

[drowsiness](#)

[gait, staggering](#)

[unconsciousness](#)

[vomiting](#)

References:

Jones, D. L. 1978. A case of canine cannabis ingestion. N. Z. Vet. J., 26: 135-136.

Ferrets

General symptoms of poisoning:

[ataxia](#)

[coma](#)

[temperature, depressed](#)

References:

Smith, R. A. 1988. Coma in a ferret after ingestion of cannabis. Vet. Hum. Toxicol., 30: 486.

[Another search?](#)

[Français](#) | [Contact Us](#) | [Help](#) | [Search](#) | [Canada site](#)

[Coming Events](#) | [About CBIF](#) | [Links](#) | [Reports and Publications](#) |

[Home](#)

Date modified: 2003-02-06

[Important Notices](#)



Français	Contact us	Help	Search	Canada site
Coming events	About CBIF	Links	Reports and publications	Home

Canadian Biodiversity Information Facility



Notes on poisoning: marsh arrow-grass

[Introduction](#)

[Interactive](#)

[All poisonous plants by Botanical name](#)

[All poisonous plants by Common name](#)

[Important WWW Poisonous Plants sites](#)



General poisoning notes:

Marsh arrow-grass (*Triglochin palustre*) is a native plant that is found sporadically across Canada in damp brackish or calcareous places. A cyanogenic glycoside, triglochinin, is found in the plant. This chemical becomes more abundant during times of moisture depletion within the plants. Occasional poisoning occurs with cattle and sheep in the lower Cariboo district of British Columbia (Majak et al. 1980, Looman et al. 1983).

References:

Cooper, M. R., Johnson, A. W. 1984. Poisonous plants in Britain and their effects on animals and man. Her Majesty's Stationery Office, London, England. 305 pp.

Looman, J., Majak, W., Smoliak, S. 1983. Stock-poisoning plants of western Canada. Agric. Can. Res. Branch Contrib. 1982-7E. 35 pp.

Nomenclature:

Scientific Name: *Triglochin palustre* L.

Vernacular name(s): marsh arrow-grass

Scientific family name: *Juncaginaceae*

Vernacular family name: arrow-grass

Go to ITIS*^{ca} for more taxonomic information on: [Triglochin palustre](#)

References:

Agriculture Quebec. 1975. Noms des maladies des plantes du Canada/ Names of plant diseases in Canada. , Quebec City, Que.,

Canada. 288 pp.

Alex, J. F., Cayouette, R., Mulligan, G. A. 1980. Common and botanical names of weeds in Canada/Noms populaire et scientifiques des plantes nuisibles du Canada. Revised. Agric. Can. Publ., Ottawa, Ont., Canada. 132 pp.

Bailey, L. H., Bailey, E. Z. 1976. Hortus third. Revised. MacMillan, New York, N.Y., USA. 1290 pp.

Scoggan, H. J. 1978, 1979. The flora of Canada. Nat. Mus. Nat. Sci. (Ottawa) Publ. Bot. 7(1)-7(4). 1711 pp.

Van Wijk, H. L. 1911. A dictionary of plant names. Martinus Nijhoff, The Hague, The Netherlands. 1444 pp.

Victorin, M. 1964. Flore Laurentienne. 2nd ed. Univ. Montreal, Montreal, Que., Canada. 952 pp.

Geographic Information

Alberta
British Columbia
Labrador
Manitoba
New Brunswick
Northwest Territories
Nova Scotia
Ontario
Prince Edward Island
Quebec
Saskatchewan
Yukon Territory

References:

Bailey, L. H., Bailey, E. Z. 1976. Hortus third. Revised. MacMillan, New York, N.Y., USA. 1290 pp.

Boivin, B. 1966, 1967. Énumération des plantes du Canada. Provencheria 6. Nat. Can. (Que.) 93: 253-274; 371-437; 583-646; 989-1063. 94: 131-157; 471-528; 625-655.

Image or illustration

marsh arrow-grass:

Images: images.google.com

Toxic parts:

flowers

leaves

References:

Majak, W., McDiarmid, R. E., Hall, J. W., Van Ryswyk, A. L. 1980. Seasonal variation in the cyanide potential of arrowgrass (*Triglochin maritima*). Can. J. Plant Sci., 60: 1235-1241.

Notes on Toxic plant chemicals:

A cyanogenic glycoside, triglochinin, is found in marsh arrow-grass. This chemical is also the main toxic component of seaside arrow-grass (Majak et al. 1980).

Toxic plant chemicals:

triglochinin

References:

Majak, W., McDiarmid, R. E., Hall, J. W., Van Ryswyk, A. L. 1980. Seasonal variation in the cyanide potential of arrowgrass (*Triglochin maritima*). Can. J. Plant Sci., 60: 1235-1241.

Animals/Human Poisoning:

Note: When an animal is listed without additional information, the literature (as of 1993) contained no detailed explanation.

Cattle

General symptoms of poisoning:

[convulsions](#)

[death](#)

[nervousness](#)

[recumbency](#)

[salivation](#)

Notes on poisoning:

In all animals, symptoms of poisoning are similar to those of cyanide poisoning, including convulsions, nervousness, trembling, and recumbency, followed by death. The blood is bright red Looman et al. 1983).

References:

Looman, J., Majak, W., Smoliak, S. 1983. Stock-poisoning plants

of western Canada. Agric. Can. Res. Branch Contrib. 1982-7E.
35 pp.

Sheep

General symptoms of poisoning:

[convulsions](#)

[nervousness](#)

[recumbency](#)

[salivation](#)

References:

Cooper, M. R., Johnson, A. W. 1984. Poisonous plants in Britain and their effects on animals and man. Her Majesty's Stationery Office, London, England. 305 pp.

[Another search?](#)

[Français](#) | [Contact Us](#) | [Help](#) | [Search](#) | [Canada site](#)

[Coming Events](#) | [About CBIF](#) | [Links](#) | [Reports and Publications](#) | [Home](#)

Date modified: 2003-02-06

[Important Notices](#)



Français	Contact us	Help	Search	Canada site
Coming events	About CBIF	Links	Reports and publications	Home

Canadian Biodiversity Information Facility



Notes on poisoning: marsh horsetail

[Introduction](#)[Interactive](#)[All poisonous plants by Botanical name](#)[All poisonous plants by Common name](#)[Important WWW Poisonous Plants sites](#)

General poisoning notes:

Marsh horsetail (*Equisetum palustre*) is a native horsetail growing across Canada. This plant has poisoned cattle and, rarely, sheep. In addition to thiaminase, it contains an alkaloid, that causes the toxicity (Kingsbury 1964, Cooper and Johnson 1984).



References:

Cooper, M. R., Johnson, A. W. 1984. Poisonous plants in Britain and their effects on animals and man. Her Majesty's Stationery Office, London, England. 305 pp.

Frohne, D., Pfander, H. J. 1983. A colour atlas of poisonous plants. Wolfe Publishing Ltd., London, England. 291 pp.

Kingsbury, J. M. 1964. Poisonous plants of the United States and Canada. Prentice-Hall Inc., Englewood Cliffs, N.J., USA. 626 pp.

Nomenclature:

Scientific Name: *Equisetum palustre* L.

Vernacular name(s): marsh horsetail

Scientific family name: *Equisetaceae*

Vernacular family name: horsetail

Go to ITIS^{*ca} for more taxonomic information on: [Equisetum palustre](#)

References:

Agriculture Quebec. 1975. Noms des maladies des plantes du Canada/ Names of plant diseases in Canada. , Quebec City, Que.,

Canada. 288 pp.

Alex, J. F., Cayouette, R., Mulligan, G. A. 1980. Common and botanical names of weeds in Canada/Noms populaire et scientifiques des plantes nuisibles du Canada. Revised. Agric. Can. Publ., Ottawa, Ont., Canada. 132 pp.

Bailey, L. H., Bailey, E. Z. 1976. Hortus third. Revised. MacMillan, New York, N.Y., USA. 1290 pp.

Scoggan, H. J. 1978, 1979. The flora of Canada. Nat. Mus. Nat. Sci. (Ottawa) Publ. Bot. 7(1)-7(4). 1711 pp.

Van Wijk, H. L. 1911. A dictionary of plant names. Martinus Nijhoff, The Hague, The Netherlands. 1444 pp.

Victorin, M. 1964. Flore Laurentienne. 2nd ed. Univ. Montreal, Montreal, Que., Canada. 952 pp.

Geographic Information

Alberta
British Columbia
Manitoba
New Brunswick
Newfoundland
Northwest Territories
Nova Scotia
Ontario
Prince Edward Island
Quebec
Saskatchewan
Yukon Territory

References:

Bailey, L. H., Bailey, E. Z. 1976. Hortus third. Revised. MacMillan, New York, N.Y., USA. 1290 pp.

Boivin, B. 1966, 1967. Énumération des plantes du Canada. Provencheria 6. Nat. Can. (Que.) 93: 253-274; 371-437; 583-646; 989-1063. 94: 131-157; 471-528; 625-655.

Image or illustration

marsh horsetail:

Images: images.google.com

Notes on Poisonous plant parts:

Marsh horsetail has separate fertile and sterile stems. Unlike field horsetail, both types of fronds are greenish, with the added fruiting sporangia body on top of the fertile frond.

Toxic parts:

leaves
stems

References:

Frohne, D., Pfander, H. J. 1983. A colour atlas of poisonous plants. Wolfe Publishing Ltd., London, England. 291 pp.

Notes on Toxic plant chemicals:

Palustrine, an alkaloid, has been found in marsh horsetail. This alkaloid may contribute to the poisoning of cattle by this plant. Thiaminase activity is usually not a problem in ruminants because thiamine is produced in the rumen. Therefore, the presence of alkaloids is suspected to cause the toxic responses. The alkaloid content varies greatly (96-302 mg/100 g of dry weight). Frosted plant material quickly loses most of its alkaloid content, whereas air-dried marsh horsetail can keep its alkaloid content for years (Frohne and Pfander 1983).

Toxic plant chemicals:

palustrine
thiaminase

References:

Frohne, D., Pfander, H. J. 1983. A colour atlas of poisonous plants. Wolfe Publishing Ltd., London, England. 291 pp.

Animals/Human Poisoning:

Note: When an animal is listed without additional information, the literature (as of 1993) contained no detailed explanation.

Cattle

General symptoms of poisoning:

[diarrhea](#)

References:

Kingsbury, J. M. 1964. Poisonous plants of the United States and Canada. Prentice-Hall Inc., Englewood Cliffs, N.J., USA. 626 pp.

Horses

Sheep

General symptoms of poisoning:

[diarrhea](#)
[muscle, weakness of](#)
[sweating](#)

References:

Cooper, M. R., Johnson, A. W. 1984. Poisonous plants in Britain and their effects on animals and man. Her Majesty's Stationery Office, London, England. 305 pp.

Kingsbury, J. M. 1964. Poisonous plants of the United States and Canada. Prentice-Hall Inc., Englewood Cliffs, N.J., USA. 626 pp.

[Another search?](#)

[Français](#) | [Contact Us](#) | [Help](#) | [Search](#) | [Canada site](#)

[Coming Events](#) | [About CBIF](#) | [Links](#) | [Reports and Publications](#) |

[Home](#)

Date modified: 2003-02-06

[Important Notices](#)



Français	Contact us	Help	Search	Canada site
Coming events	About CBIF	Links	Reports and publications	Home

Canadian Biodiversity Information Facility



Notes on poisoning: May-apple

[Introduction](#)[Interactive](#)[All poisonous plants by Botanical name](#)[All poisonous plants by Common name](#)[Important WWW Poisonous Plants sites](#)

General poisoning notes:

May-apple (*Podophyllum peltatum*) is a native herb of moist woods in parts of southeastern Canada. May-apple extracts have been used in folk medicine and pharmaceuticals. Misuse has caused toxic reactions and even fatalities. Workers in the extraction process have developed dermatitis. Ingesting the ripe fruit may, at worst, cause catharsis. Cattle, sheep, and swine have been poisoned after ingesting may-apple vegetation (McIntosh 1928, Rosenstein et al. 1976).

References:

Cassidy, D. E., Drewry, J., Fanning, J. P. 1982. *Podophyllum* toxicity: a report of a fatal case and a review of the literature. J. Toxicol. Clin. Toxicol., 19: 35-44.

Kingsbury, J. M. 1964. Poisonous plants of the United States and Canada. Prentice-Hall Inc., Englewood Cliffs, N.J., USA. 626 pp.

McIntosh, R. A. 1928. May apple poisoning in a cow. Ont. Vet. Coll. Rep., 29: 18-20.

Rosenstein, G., Rosenstein, H., Freeman, M., Weston, N. 1976. *Podophyllum* - a dangerous laxative. Pediatrics, 57: 419-421.

Nomenclature:

Scientific Name: *Podophyllum peltatum* L.

Vernacular name(s): May-apple

Scientific family name: *Berberidaceae*

Vernacular family name: barberry

Go to ITIS*^{ca} for more taxonomic information on: [Podophyllum](#)

[peltatum](#)

References:

Agriculture Quebec. 1975. Noms des maladies des plantes du Canada/ Names of plant diseases in Canada. , Quebec City, Que., Canada. 288 pp.

Alex, J. F., Cayouette, R., Mulligan, G. A. 1980. Common and botanical names of weeds in Canada/Noms populaire et scientifiques des plantes nuisibles du Canada. Revised. Agric. Can. Publ., Ottawa, Ont., Canada. 132 pp.

Bailey, L. H., Bailey, E. Z. 1976. Hortus third. Revised. MacMillan, New York, N.Y., USA. 1290 pp.

Scoggan, H. J. 1978, 1979. The flora of Canada. Nat. Mus. Nat. Sci. (Ottawa) Publ. Bot. 7(1)-7(4). 1711 pp.

Van Wijk, H. L. 1911. A dictionary of plant names. Martinus Nijhoff, The Hague, The Netherlands. 1444 pp.

Victorin, M. 1964. Flore Laurentienne. 2nd ed. Univ. Montreal, Montreal, Que., Canada. 952 pp.

Geographic Information

Nova Scotia

Ontario

Quebec

References:

Bailey, L. H., Bailey, E. Z. 1976. Hortus third. Revised. MacMillan, New York, N.Y., USA. 1290 pp.

Boivin, B. 1966, 1967. Énumération des plantes du Canada. Provencheria 6. Nat. Can. (Que.) 93: 253-274; 371-437; 583-646; 989-1063. 94: 131-157; 471-528; 625-655.

Image or illustration

May-apple:

Images: images.google.com

Notes on Poisonous plant parts:

All parts of the plant contain toxic chemicals, although the fruit may cause only slight catharsis. alpha- and beta-peltatin are found in the rhizomes (Rosenstein et al. 1976, Lampe and McCann

1986).

Toxic parts:

all parts

leaves

stems

References:

Lampe, K. F., McCann, M. A. 1985. AMA Handbook of poisonous and injurious plants. American Medical Assoc. Chicago, Ill., USA. 432 pp.

Rosenstein, G., Rosenstein, H., Freeman, M., Weston, N. 1976. Podophyllum - a dangerous laxative. Pediatrics, 57: 419-421.

Notes on Toxic plant chemicals:

The purgative podophylloresin, the glucoside of podophyllotoxin, and alpha- and beta-peltatin produce toxic reactions in animals. The LD-50 of podophyllotoxin, administered orally to mice, is 90 mg/kg (Rosenstein et al. 1976, Lampe and McCann 1986).

Toxic plant chemicals:

alpha- and beta- peltatin

podophylloresin

References:

Lampe, K. F., McCann, M. A. 1985. AMA Handbook of poisonous and injurious plants. American Medical Assoc. Chicago, Ill., USA. 432 pp.

Rosenstein, G., Rosenstein, H., Freeman, M., Weston, N. 1976. Podophyllum - a dangerous laxative. Pediatrics, 57: 419-421.

Animals/Human Poisoning:

Note: When an animal is listed without additional information, the literature (as of 1993) contained no detailed explanation.

Cattle

General symptoms of poisoning:

[agitation](#)

[lacrimation, severe](#)

[pupil dilation](#)

[salivation](#)

Notes on poisoning:

A cow in Ontario experienced toxic symptoms after ingesting may-apple. The symptoms included salivation, moaning, excitation, swollen eyes and muzzle, lacrimation, pupil dilation, and congestion of all visible mucous membranes (McIntosh 1928).

References:

McIntosh, R. A. 1928. May apple poisoning in a cow. Ont. Vet. Coll. Rep., 29: 18-20.

Humans

General symptoms of poisoning:

[catharsis](#)

[coma](#)

[confusion](#)

[conjunctivitis](#)

[death](#)

[erythema](#)

[gastroenteritis](#)

[vomiting](#)

Notes on poisoning:

In humans most cases of poisoning from May-apple have resulted from the use or handling of the pharmaceutical extracts from the plant. Because of its irritant qualities, may-apple has been used topically to remove papilloma and warts. It has also been used as an abortifacient, as shown experimentally with mice and rabbits. The use of these extracts as a laxative in pregnancy has been discouraged. The extracts have been shown to have an antimitotic capacity. In a case of suicide, a man ingested a bottle containing 10-11 g of podophyllum extract. Initially he experienced few symptoms, but after 10 h the patient became confused and comatose; respiration was assisted and the man died after 39 h (Rosenstein et al. 1976, Cassidy et al. 1982).

References:

Cassidy, D. E., Drewry, J., Fanning, J. P. 1982. *Podophyllum* toxicity: a report of a fatal case and a review of the literature. J. Toxicol. Clin. Toxicol., 19: 35-44.

Rosenstein, G., Rosenstein, H., Freeman, M., Weston, N. 1976.

Podophyllum - a dangerous laxative. Pediatrics, 57: 419-421.

Swine

General symptoms of poisoning:

[death](#)

Notes on poisoning:

Deaths were reported after few symptoms in swine that ingested young shoots of May-apple (Kingsbury 1964).

References:

Kingsbury, J. M. 1964. Poisonous plants of the United States and Canada. Prentice-Hall Inc., Englewood Cliffs, N.J., USA. 626 pp.

McIntosh, R. A. 1928. May apple poisoning in a cow. Ont. Vet. Coll. Rep., 29: 18-20.

[Another search?](#)

[Français](#) | [Contact Us](#) | [Help](#) | [Search](#) | [Canada site](#)

[Coming Events](#) | [About CBIF](#) | [Links](#) | [Reports and Publications](#) |

[Home](#)

Date modified: 2003-02-06

[Important Notices](#)



Français	Contact us	Help	Search	Canada site
Coming events	About CBIF	Links	Reports and publications	Home

Canadian Biodiversity Information Facility



Notes on poisoning: Menzies larkspur

[Introduction](#)[Interactive](#)[All poisonous plants by Botanical name](#)[All poisonous plants by Common name](#)[Important WWW Poisonous Plants sites](#)

General poisoning notes:

Menzies larkspur (*Delphinium menziesii*) is a native herb found on the rangelands of British Columbia. This plant has been implicated in poisoning rangeland cattle. Additional information can be found under general notes of tall larkspur (*Delphinium glaucum*).

References:

Cheeke, P. R., Shull, L. R. 1985. Natural toxicants in feeds and poisonous plants. AVI Publishing Company, Inc., Westport, Conn., USA. 492 pp.

Nomenclature:

Scientific Name: *Delphinium menziesii* DC.

Vernacular name(s): Menzies larkspur

Scientific family name: *Ranunculaceae*

Vernacular family name: crowfoot

Go to ITIS*^{ca} for more taxonomic information on: [Delphinium menziesii](#)

References:

Agriculture Quebec. 1975. Noms des maladies des plantes du Canada/ Names of plant diseases in Canada. , Quebec City, Que., Canada. 288 pp.

Alex, J. F., Cayouette, R., Mulligan, G. A. 1980. Common and botanical names of weeds in Canada/Noms populaire et scientifiques des plantes nuisibles du Canada. Revised. Agric. Can. Publ., Ottawa, Ont., Canada. 132 pp.

Bailey, L. H., Bailey, E. Z. 1976. Hortus third. Revised. MacMillan, New York, N.Y., USA. 1290 pp.

Scoggan, H. J. 1978, 1979. The flora of Canada. Nat. Mus. Nat. Sci. (Ottawa) Publ. Bot. 7(1)-7(4). 1711 pp.

Van Wijk, H. L. 1911. A dictionary of plant names. Martinus Nijhoff, The Hague, The Netherlands. 1444 pp.

Victorin, M. 1964. Flore Laurentienne. 2nd ed. Univ. Montreal, Montreal, Que., Canada. 952 pp.

Geographic Information

British Columbia

References:

Bailey, L. H., Bailey, E. Z. 1976. Hortus third. Revised. MacMillan, New York, N.Y., USA. 1290 pp.

Boivin, B. 1966, 1967. Énumération des plantes du Canada. Provencheria 6. Nat. Can. (Que.) 93: 253-274; 371-437; 583-646; 989-1063. 94: 131-157; 471-528; 625-655.

Image or illustration

Menzies larkspur:

Images: images.google.com

Toxic parts:

all parts

leaves

seeds

References:

Cheeke, P. R., Shull, L. R. 1985. Natural toxicants in feeds and poisonous plants. AVI Publishing Company, Inc., Westport, Conn., USA. 492 pp.

Notes on Toxic plant chemicals:

See additional information under general notes of [Delphinium glaucum](#).

Toxic plant chemicals:

methyllycaconitine

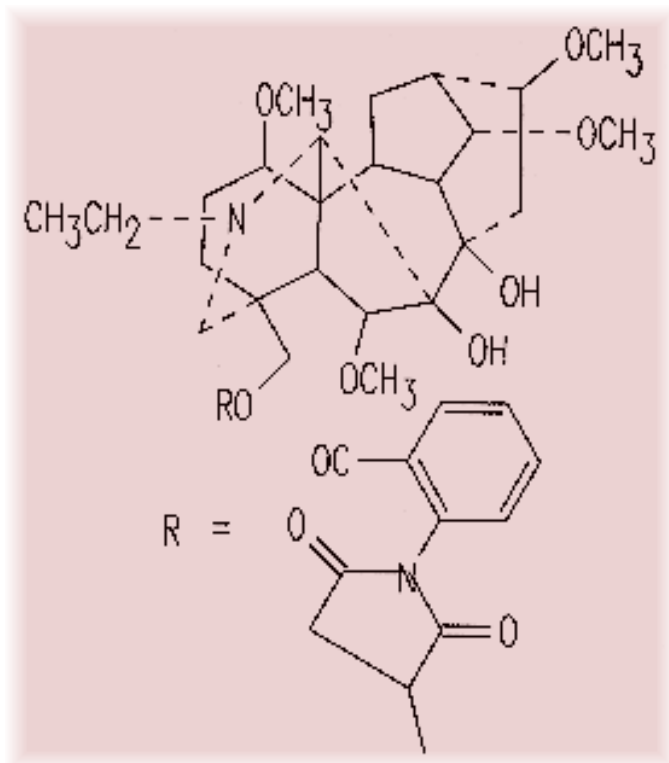

Chemical diagram(s) are courtesy of [Ruth McDiarmid](#), Biochemistry Technician, Kamloops Range Station, Agriculture and Agri-Food Canada, Kamloops, British Columbia, Canada.

References:

Cheeke, P. R., Shull, L. R. 1985. Natural toxicants in feeds and poisonous plants. AVI Publishing Company, Inc., Westport, Conn., USA. 492 pp.

Animals/Human Poisoning:

Note: When an animal is listed without additional information, the literature (as of 1993) contained no detailed explanation.

Cattle

General symptoms of poisoning:

[ataxia](#)

[bloat](#)

[constipation](#)

[death by asphyxiation](#)

References:

Cheeke, P. R., Shull, L. R. 1985. Natural toxicants in feeds and poisonous plants. AVI Publishing Company, Inc., Westport, Conn., USA. 492 pp.

Horses

Sheep

[Another search?](#)

[Français](#) | [Contact Us](#) | [Help](#) | [Search](#) | [Canada site](#)

[Coming Events](#) | [About CBIF](#) | [Links](#) | [Reports and Publications](#) | [Home](#)

Date modified: 2003-02-06

[Important Notices](#)



Français	Contact us	Help	Search	Canada site
Coming events	About CBIF	Links	Reports and publications	Home

Canadian Biodiversity Information Facility



Notes on poisoning: monk's hood

[Introduction](#)

[Interactive](#)

[All poisonous plants by Botanical name](#)

[All poisonous plants by Common name](#)

[Important WWW Poisonous Plants sites](#)

General poisoning notes:

Monk's hood (*Aconitum napellus*) is an outdoor ornamental herb. The plant contains poisonous alkaloids, which have proved toxic in humans when accidentally ingested (e.g., aconitine; see Fiddes 1958). Few cases of animal poisoning occur (Kingsbury 1964).



References:

Fiddes, F. S. 1958. Poisoning by aconitine. Report of two cases. Br. Med. J., 2: 779-780.

Nomenclature:

Scientific Name: *Aconitum napellus* L.

Vernacular name(s): monk's hood

Scientific family name: *Ranunculaceae*

Vernacular family name: crowfoot

Go to ITIS*^{ca} for more taxonomic information on: [Aconitum napellus](#)

References:

Agriculture Quebec. 1975. Noms des maladies des plantes du Canada/ Names of plant diseases in Canada. , Quebec City, Que., Canada. 288 pp.

Alex, J. F., Cayouette, R., Mulligan, G. A. 1980. Common and botanical names of weeds in Canada/Noms populaire et scientifiques des plantes nuisibles du Canada. Revised. Agric. Can. Publ., Ottawa, Ont., Canada. 132 pp.

Bailey, L. H., Bailey, E. Z. 1976. Hortus third. Revised.

MacMillan, New York, N.Y., USA. 1290 pp.

Scoggan, H. J. 1978, 1979. The flora of Canada. Nat. Mus. Nat. Sci. (Ottawa) Publ. Bot. 7(1)-7(4). 1711 pp.

Van Wijk, H. L. 1911. A dictionary of plant names. Martinus Nijhoff, The Hague, The Netherlands. 1444 pp.

Victorin, M. 1964. Flore Laurentienne. 2nd ed. Univ. Montreal, Montreal, Que., Canada. 952 pp.

Geographic Information

Plant or plant parts used in or around the home.

References:

Bailey, L. H., Bailey, E. Z. 1976. Hortus third. Revised. MacMillan, New York, N.Y., USA. 1290 pp.

Boivin, B. 1966, 1967. Énumération des plantes du Canada. Provencheria 6. Nat. Can. (Que.) 93: 253-274; 371-437; 583-646; 989-1063. 94: 131-157; 471-528; 625-655.

Image or illustration

monk's hood:

Images: images.google.com

Toxic parts:

all parts
leaves
roots

References:

Lampe, K. F., McCann, M. A. 1985. AMA Handbook of poisonous and injurious plants. American Medical Assoc. Chicago, Ill., USA. 432 pp.

Toxic plant chemicals:

aconitine

References:

Bonisteel, W. J. 1940. Polyploidy in relation to chemical analysis. J. Am. Pharm. Assoc., 6: 404-408.

Fiddes, F. S. 1958. Poisoning by aconitine. Report of two cases. Br. Med. J., 2: 779-780.

Animals/Human Poisoning:

Note: When an animal is listed without additional information, the literature (as of 1993) contained no detailed explanation.

Humans

General symptoms of poisoning:

[agitation](#)

[faintness](#)

[muscle, weakness of](#)

[nausea](#)

[salivation](#)

[skin, cold and moist](#)

[throat, constriction](#)

[tingling sensation](#)

[vomiting](#)

References:

Fiddes, F. S. 1958. Poisoning by aconitine. Report of two cases. Br. Med. J., 2: 779-780.

[Another search?](#)

[Français](#) | [Contact Us](#) | [Help](#) | [Search](#) | [Canada site](#)

[Coming Events](#) | [About CBIF](#) | [Links](#) | [Reports and Publications](#) |

[Home](#)

Date modified: 2003-02-06

[Important Notices](#)



Français	Contact us	Help	Search	Canada site
Coming events	About CBIF	Links	Reports and publications	Home

Canadian Biodiversity Information Facility



Notes on poisoning: moonseed

[Introduction](#)

[Interactive](#)

[All poisonous plants by Botanical name](#)

[All poisonous plants by Common name](#)

[Important WWW Poisonous Plants sites](#)

General poisoning notes:

Moonseed (*Menispermum canadense*) is a native vine found in south-central Canada. In Pennsylvania the fruits of this plant have apparently killed children (Gress 1935, Lampe and McCann 1985).



References:

Gress, E. M. 1935. Poisonous plants of Pennsylvania. Penn. Dep. Agric. Gen. Bull., 531. 51 pp.

Lampe, K. F., McCann, M. A. 1985. AMA Handbook of poisonous and injurious plants. American Medical Assoc. Chicago, Ill., USA. 432 pp.

Nomenclature:

Scientific Name: *Menispermum canadense* L.

Vernacular name(s): moonseed

Scientific family name: *Menispermaceae*

Vernacular family name: moonseed

Go to ITIS^{*ca} for more taxonomic information on: [Menispermum canadense](#)

References:

Agriculture Quebec. 1975. Noms des maladies des plantes du Canada/ Names of plant diseases in Canada. , Quebec City, Que., Canada. 288 pp.

Alex, J. F., Cayouette, R., Mulligan, G. A. 1980. Common and botanical names of weeds in Canada/Noms populaire et

scientifiques des plantes nuisibles du Canada. Revised. Agric. Can. Publ., Ottawa, Ont., Canada. 132 pp.

Bailey, L. H., Bailey, E. Z. 1976. Hortus third. Revised. MacMillan, New York, N.Y., USA. 1290 pp.

Scoggan, H. J. 1978, 1979. The flora of Canada. Nat. Mus. Nat. Sci. (Ottawa) Publ. Bot. 7(1)-7(4). 1711 pp.

Van Wijk, H. L. 1911. A dictionary of plant names. Martinus Nijhoff, The Hague, The Netherlands. 1444 pp.

Victorin, M. 1964. Flore Laurentienne. 2nd ed. Univ. Montreal, Montreal, Que., Canada. 952 pp.

Geographic Information

Manitoba

Ontario

Quebec

References:

Bailey, L. H., Bailey, E. Z. 1976. Hortus third. Revised. MacMillan, New York, N.Y., USA. 1290 pp.

Boivin, B. 1966, 1967. Énumération des plantes du Canada. Provencheria 6. Nat. Can. (Que.) 93: 253-274; 371-437; 583-646; 989-1063. 94: 131-157; 471-528; 625-655.

Image or illustration

moonseed:

Images: images.google.com

Toxic parts:

mature fruit

References:

Gress, E. M. 1935. Poisonous plants of Pennsylvania. Penn. Dep. Agric. Gen. Bull., 531. 51 pp.

Lampe, K. F., McCann, M. A. 1985. AMA Handbook of poisonous and injurious plants. American Medical Assoc. Chicago, Ill., USA. 432 pp.

Notes on Toxic plant chemicals:

Moonseed contains alkaloids that may be responsible for the toxicity of the fruit to humans (Lampe and McCann 1985). Acutumine, an alkaloid, has been found in the aboveground part of moonseed, but has not been proved to cause the toxicity. Other alkaloids have also been found in the rhizomes (Doskotch and Knapp 1971).

Toxic plant chemicals:

acutumine
unknown chemical

References:

Doskotch, R. W., Knapp, J. E. 1971. Alkaloids from *Menispermum canadense*. *Lloydia* (Cinci), 34: 292-300.

Lampe, K. F., McCann, M. A. 1985. *AMA Handbook of poisonous and injurious plants*. American Medical Assoc. Chicago, Ill., USA. 432 pp.

Animals/Human Poisoning:

Note: When an animal is listed without additional information, the literature (as of 1993) contained no detailed explanation.

Humans

General symptoms of poisoning:

[convulsions](#)

[death](#)

Notes on poisoning:

Gress (1935) describes a case where children ingested moonseed berries and later died. Lampe and McCann (1985) state that convulsions may result when the berries are ingested.

References:

Gress, E. M. 1935. *Poisonous plants of Pennsylvania*. Penn. Dep. Agric. Gen. Bull., 531. 51 pp.

[Another search?](#)

[Français](#) | [Contact Us](#) | [Help](#) | [Search](#) | [Canada site](#)
[Coming Events](#) | [About CBIF](#) | [Links](#) | [Reports and Publications](#) |
[Home](#)

Date modified: 2003-02-06

[Important Notices](#)



Français	Contact us	Help	Search	Canada site
Coming events	About CBIF	Links	Reports and publications	Home

Canadian Biodiversity Information Facility



Notes on poisoning: morning glory

[Introduction](#)

[Interactive](#)

[All poisonous plants by Botanical name](#)

[All poisonous plants by Common name](#)

[Important WWW Poisonous Plants sites](#)



General poisoning notes:

Hallucinations are the predominant effect after ingesting morning glory seeds. Ingesting 200-300 seeds produces an effect equivalent to 300 micro g of LSD. Vivid visual and tactile hallucinations, as well as increased awareness of colors have been described. Symptoms include facial flushing, nausea, mydriasis, diarrhea, and hypotension (Spoerke and Smolinske 1990).

Ipomoea tricolor has a long history of use as a human hallucinogen in southern Mexico, where the seeds were used in the preparation of a drink (Fuller and McClintock 1986). A single undocumented case of poisoning of a pet cat (after ingestion of seeds) has come to our attention. The cat showed erratic behavior and "looked like a lunatic". There was no apparent permanent damage afterwards. Several cultivars of *Ipomoea tricolor* are available in Canadian garden catalogs for home gardeners and, with few exceptions, no mention is made of any potential toxic affects from ingesting the seeds of these plants. Sample cultivars are "Heavenly Blue", "Pearly Gates", and "Scarlet O'Hara". The total alkaloid content is shown to vary, depending on the cultivar grown. It is advisable to remove and destroy the fruiting parts as they develop to avoid ingestion by children or pets.

References:

Fuller, T. C., McClintock, E. 1986. Poisonous plants of California. Univ. California Press, Berkeley, Calif., USA. 432 pp.

Spoerke, D. G., Smolinske, S. C. 1990. Toxicity of houseplants. CRC Press, Inc., Boca Raton, Fla., USA. 335 pp.

Nomenclature:

Vernacular name(s): morning glory

Scientific family name:

Vernacular family name: morning-glory

Go to ITIS^{*ca} for more taxonomic information on: [Ipomoea tricolor](#)

References:

Agriculture Quebec. 1975. Noms des maladies des plantes du Canada/ Names of plant diseases in Canada. , Quebec City, Que., Canada. 288 pp.

Alex, J. F., Cayouette, R., Mulligan, G. A. 1980. Common and botanical names of weeds in Canada/Noms populaire et scientifiques des plantes nuisibles du Canada. Revised. Agric. Can. Publ., Ottawa, Ont., Canada. 132 pp.

Bailey, L. H., Bailey, E. Z. 1976. Hortus third. Revised. MacMillan, New York, N.Y., USA. 1290 pp.

Scoggan, H. J. 1978, 1979. The flora of Canada. Nat. Mus. Nat. Sci. (Ottawa) Publ. Bot. 7(1)-7(4). 1711 pp.

Van Wijk, H. L. 1911. A dictionary of plant names. Martinus Nijhoff, The Hague, The Netherlands. 1444 pp.

Victorin, M. 1964. Flore Laurentienne. 2nd ed. Univ. Montreal, Montreal, Que., Canada. 952 pp.

Geographic Information

Plant or plant parts used in or around the home.

References:

Bailey, L. H., Bailey, E. Z. 1976. Hortus third. Revised. MacMillan, New York, N.Y., USA. 1290 pp.

Boivin, B. 1966, 1967. Énumération des plantes du Canada. Provencheria 6. Nat. Can. (Que.) 93: 253-274; 371-437; 583-646; 989-1063. 94: 131-157; 471-528; 625-655.

Image or illustration

morning glory:

Images: images.google.com

Notes on Poisonous plant parts:

The embryo of the seeds, and not the shell, contains the toxic chemicals. Ingesting 200-300 seeds can cause problems in adult

humans (Spoerke and Smolinske 1990).

Toxic parts:

seeds

References:

Spoerke, D. G., Smolinske, S. C. 1990. Toxicity of houseplants. CRC Press, Inc., Boca Raton, Fla., USA. 335 pp.

Notes on Toxic plant chemicals:

The seed embryos contain several indole alkaloids that have hallucinogenic activity. These include d-lysergic acid amide (0.035%), d-isolysergic acid amide (0.005%), and elymoclavine (0.005%). The total alkaloid content varies with different plant cultivars. For instance, the cultivar "Pearly Gates" had 0.041%, whereas "Scarlet O'Hara" had 0.002% total alkaloids (Spoerke and Smolinske 1990).

Toxic plant chemicals:

d-isolysergic acid amide

d-lysergic acid amide

elymoclavine

References:

Spoerke, D. G., Smolinske, S. C. 1990. Toxicity of houseplants. CRC Press, Inc., Boca Raton, Fla., USA. 335 pp.

Animals/Human Poisoning:

Note: When an animal is listed without additional information, the literature (as of 1993) contained no detailed explanation.

Cats

General symptoms of poisoning:

[pupil dilation](#)

Notes on poisoning:

In an undocumented case, a pet cat was attracted to the fruiting capsule of a morning glory vine growing on an apartment balcony. The dry fruiting capsule contained seeds that rattled in the wind. The cat ate an unknown quantity of seeds and later was

noted to run around chasing nothing. It meowed a lot and its eyes did not appear to focus on anything. The owner remarked that the cat "looked like a lunatic". There were no apparent lasting symptoms.

References:

Fuller, T. C., McClintock, E. 1986. Poisonous plants of California. Univ. California Press, Berkeley, Calif., USA. 432 pp.

Humans

General symptoms of poisoning:

[blood pressure, low](#)

[diarrhea](#)

[hallucination](#)

[nausea](#)

[pupil dilation](#)

Notes on poisoning:

In one reported case of deliberate ingestion of 250 seeds of morning glory, a 20-year-old women developed inappropriate responses and weeping. The pupils were dilated, the face flushed, and hyper- active reflexes were noted. After 5 h, anxiety, and increased awareness of colors was recorded, but without hallucinations. Diarrhea was noted after 9 h. Hypotension occurred intermittently. After 2 days most of the symptoms had disappeared, with the exception of dilated pupils and increased deep tendon reflexes (Spoerke and Smolinske 1990).

References:

Spoerke, D. G., Smolinske, S. C. 1990. Toxicity of houseplants. CRC Press, Inc., Boca Raton, Fla., USA. 335 pp.

[Another search?](#)

[Français](#) | [Contact Us](#) | [Help](#) | [Search](#) | [Canada site](#)

[Coming Events](#) | [About CBIF](#) | [Links](#) | [Reports and Publications](#) | [Home](#)

Date modified: 2003-02-06

[Important Notices](#)



Français	Contact us	Help	Search	Canada site
Coming events	About CBIF	Links	Reports and publications	Home

Canadian Biodiversity Information Facility



Notes on poisoning: mother-in-law plant

[Introduction](#)

[Interactive](#)

[All poisonous plants by Botanical name](#)

[All poisonous plants by Common name](#)

[Important WWW Poisonous Plants sites](#)



General poisoning notes:

Mother-in-law plant (*Dieffenbachia seguine*) is an ornamental. Chewing dumbcane (*Dieffenbachia* spp.) leaves or stems causes immediate pain and swelling in the mouth and throat. In severe cases, speech may become unintelligible, hence the name dumbcane. In the past these plants were used as a means of human torture. Family pets have also been poisoned after chewing on dumbcane plant material. The effects are almost instantaneous, before the plant material is actually ingested. The plant juices can also cause inflammation and contact dermatitis in some individuals (Arditti and Rodriguez 1982, Lampe and McCann 1985). Mrvos et al. (1990) determined that in many cases where people had contact with broken leaves of dumbcane plants, symptoms occurred within 5 min and were short and of minor consequence. The researchers concluded that concerns regarding oral complications may be exaggerated.

References:

- Arditti, J., Rodriguez, E. 1982. *Dieffenbachia*: uses, abuses and toxic constituents: a review. *J. Ethnopharmacol.*, 5: 293-302.
- Drach, G., Maloney, W. H. 1963. Toxicity of the common houseplant *Dieffenbachia*. *J. Am. Med. Assoc.*, 184: 1047-1048.
- Hanna, G. 1986. Plant poisoning in canines and felines. *Vet. Hum. Toxicol.*, 28: 38-40.
- Lampe, K. F., McCann, M. A. 1985. *AMA Handbook of poisonous and injurious plants*. American Medical Assoc. Chicago, Ill., USA. 432 pp.
- Mrvos, R., Dean, B. S., Krenzelok, E. P. 1990. *Philodendron/Dieffenbachia* ingestions: are they a problem? *Vet. Hum. Toxicol.*, 32: 369.

Nomenclature:

Scientific Name: *Dieffenbachia seguine* (Jacq.) Schott

Vernacular name(s): mother-in-law plant

Scientific family name: *Araceae*

Vernacular family name: arum

Go to ITIS^{*ca} for more taxonomic information on: [Dieffenbachia seguine](#)

References:

Agriculture Quebec. 1975. Noms des maladies des plantes du Canada/ Names of plant diseases in Canada. , Quebec City, Que., Canada. 288 pp.

Alex, J. F., Cayouette, R., Mulligan, G. A. 1980. Common and botanical names of weeds in Canada/Noms populaire et scientifiques des plantes nuisibles du Canada. Revised. Agric. Can. Publ., Ottawa, Ont., Canada. 132 pp.

Bailey, L. H., Bailey, E. Z. 1976. Hortus third. Revised. MacMillan, New York, N.Y., USA. 1290 pp.

Scoggan, H. J. 1978, 1979. The flora of Canada. Nat. Mus. Nat. Sci. (Ottawa) Publ. Bot. 7(1)-7(4). 1711 pp.

Van Wijk, H. L. 1911. A dictionary of plant names. Martinus Nijhoff, The Hague, The Netherlands. 1444 pp.

Victorin, M. 1964. Flore Laurentienne. 2nd ed. Univ. Montreal, Montreal, Que., Canada. 952 pp.

Geographic Information

Plant or plant parts used in or around the home.

References:

Bailey, L. H., Bailey, E. Z. 1976. Hortus third. Revised. MacMillan, New York, N.Y., USA. 1290 pp.

Boivin, B. 1966, 1967. Énumération des plantes du Canada. Provencheria 6. Nat. Can. (Que.) 93: 253-274; 371-437; 583-646; 989-1063. 94: 131-157; 471-528; 625-655.

Image or illustration

mother-in-law plant:

Images: images.google.com

Toxic parts:

leaves
stems

References:

Cheeke, P. R., Shull, L. R. 1985. Natural toxicants in feeds and poisonous plants. AVI Publishing Company, Inc., Westport, Conn., USA. 492 pp.

Walter, W. G., Khanna, P. N. 1972. Chemistry of the aroids 1. *Dieffenbachia seguine*, *amoena* and *picta*. Econ. Bot., 26: 364-372.

Notes on Toxic plant chemicals:

Dieffenbachia spp. contain calcium oxalate crystals, which are found in special cells called idioblasts; these cells have nozzle-like apertures at either end. The small needle-like crystals are small (0.2 mm long) and are forcibly extruded when the tissue is ruptured, as when chewed. This release of crystals from plant tissue can continue for several minutes. The initial sensation upon ingesting dumbcane tissue is one of pain (Dore 1963, Cheeke and Schull 1985). Proteolytic enzymes have also been found in dumbcanes and may account for some of the toxic effects (Walter and Khanna 1963, Arditti and Rodriguez 1982).

Toxic plant chemicals:

oxalate
proteolytic enzymes

References:

Arditti, J., Rodriguez, E. 1982. *Dieffenbachia*: uses, abuses and toxic constituents: a review. J. Ethnopharmacol., 5: 293-302.

Cheeke, P. R., Shull, L. R. 1985. Natural toxicants in feeds and poisonous plants. AVI Publishing Company, Inc., Westport, Conn., USA. 492 pp.

Walter, W. G., Khanna, P. N. 1972. Chemistry of the aroids 1. *Dieffenbachia seguine*, *amoena* and *picta*. Econ. Bot., 26: 364-372.

Animals/Human Poisoning:

Note: When an animal is listed without additional information, the literature (as of 1993) contained no detailed explanation.

Cats

General symptoms of poisoning:

[mouth, irritation of](#)
[salivation](#)

References:

Hanna, G. 1986. Plant poisoning in canines and felines. *Vet. Hum. Toxicol.*, 28: 38-40.

Dogs

Humans

General symptoms of poisoning:

[aphonia](#)
[breathing, labored](#)
[diarrhea](#)
[mouth, irritation of](#)
[salivation](#)
[vomiting](#)

Notes on poisoning:

Chewing dumbcane plants causes immediate intense pain and irritation of the lips, tongue, and mouth. There is edematous swelling of the oral mucosa. Bullae may form. Speech capability is often reduced or lost, a condition that can last for several days. The pain and irritation can also persist, and the edema can leave superficial necrosis. Excessive salivation is common. Treatment requires use of cool liquids; analgesics may be indicated (Arditti and Rodriguez 1982, Lampe and McCann 1985). Cut stem sections are particularly dangerous for nursery workers because of the possibility of getting plant juices into the eyes. Inflammation accompanied by intense pain, watering, and gross swelling can occur. Visual acuity may be reduced (Arditti and Rodriguez 1982).

References:

Arditti, J., Rodriguez, E. 1982. *Dieffenbachia*: uses, abuses and

toxic constituents: a review. *J. Ethnopharmacol.*, 5: 293-302.

Drach, G., Maloney, W. H. 1963. Toxicity of the common houseplant *Dieffenbachia*. *J. Am. Med. Assoc.*, 184: 1047-1048.

Lampe, K. F., McCann, M. A. 1985. *AMA Handbook of poisonous and injurious plants*. American Medical Assoc. Chicago, Ill., USA. 432 pp.

[Another search?](#)

[Français](#) | [Contact Us](#) | [Help](#) | [Search](#) | [Canada site](#)

[Coming Events](#) | [About CBIF](#) | [Links](#) | [Reports and Publications](#) |

[Home](#)

Date modified: 2003-02-06

[Important Notices](#)



Français	Contact us	Help	Search	Canada site
Coming events	About CBIF	Links	Reports and publications	Home

Canadian Biodiversity Information Facility



Notes on poisoning: motherwort

[Introduction](#)

[Interactive](#)

[All poisonous plants by Botanical name](#)

[All poisonous plants by Common name](#)

[Important WWW Poisonous Plants sites](#)

General poisoning notes:

Motherwort (*Leonurus cardiaca*) is a naturalized herb that is weedy in flower and fruit gardens. This plant can cause dermatitis in sensitive individuals. A fragrant lemon-scented oil caused photosensitivity when ingested (Muenscher 1975, Mitchell and Rook 1979).



References:

Mitchell, J. C., Rook, A. 1979. Botanical dermatology. Greenglass Ltd, Vancouver, B.C., Canada. 787 pp.

Muenscher, W. C. 1975. Poisonous plants of the United States. Revised. Collier Books, New York, N.Y., USA. 277 pp.

Nomenclature:

Scientific Name: *Leonurus cardiaca* L.

Vernacular name(s): motherwort

Scientific family name: *Labiatae*

Vernacular family name: mint

Go to ITIS^{*ca} for more taxonomic information on: [Leonurus cardiaca](#)

References:

Agriculture Quebec. 1975. Noms des maladies des plantes du Canada/ Names of plant diseases in Canada. , Quebec City, Que., Canada. 288 pp.

Alex, J. F., Cayouette, R., Mulligan, G. A. 1980. Common and botanical names of weeds in Canada/Noms populaire et

scientifiques des plantes nuisibles du Canada. Revised. Agric. Can. Publ., Ottawa, Ont., Canada. 132 pp.

Bailey, L. H., Bailey, E. Z. 1976. Hortus third. Revised. MacMillan, New York, N.Y., USA. 1290 pp.

Scoggan, H. J. 1978, 1979. The flora of Canada. Nat. Mus. Nat. Sci. (Ottawa) Publ. Bot. 7(1)-7(4). 1711 pp.

Van Wijk, H. L. 1911. A dictionary of plant names. Martinus Nijhoff, The Hague, The Netherlands. 1444 pp.

Victorin, M. 1964. Flore Laurentienne. 2nd ed. Univ. Montreal, Montreal, Que., Canada. 952 pp.

Geographic Information

British Columbia

Manitoba

New Brunswick

Nova Scotia

Ontario

Prince Edward Island

Quebec

Saskatchewan

References:

Bailey, L. H., Bailey, E. Z. 1976. Hortus third. Revised. MacMillan, New York, N.Y., USA. 1290 pp.

Boivin, B. 1966, 1967. Énumération des plantes du Canada. Provencheria 6. Nat. Can. (Que.) 93: 253-274; 371-437; 583-646; 989-1063. 94: 131-157; 471-528; 625-655.

Image or illustration

motherwort:

Images: images.google.com

Toxic parts:

leaves

References:

Mitchell, J. C., Rook, A. 1979. Botanical dermatology. Greenglass Ltd, Vancouver, B.C., Canada. 787 pp.

Notes on Toxic plant chemicals:

A fragrant lemon-scented oil from the plant can cause photosensitization (Mitchell and Rook 1979).

Toxic plant chemicals:

unknown chemical

References:

Mitchell, J. C., Rook, A. 1979. Botanical dermatology. Greenglass Ltd, Vancouver, B.C., Canada. 787 pp.

Animals/Human Poisoning:

Note: When an animal is listed without additional information, the literature (as of 1993) contained no detailed explanation.

Humans

[Another search?](#)

[Français](#) | [Contact Us](#) | [Help](#) | [Search](#) | [Canada site](#)

[Coming Events](#) | [About CBIF](#) | [Links](#) | [Reports and Publications](#) |

[Home](#)

Date modified: 2003-02-06

[Important Notices](#)



Français	Contact us	Help	Search	Canada site
Coming events	About CBIF	Links	Reports and publications	Home

Canadian Biodiversity Information Facility



Notes on poisoning: naked-flowered sneezeweed

[Introduction](#)[Interactive](#)[All poisonous plants by Botanical name](#)[All poisonous plants by Common name](#)[Important WWW Poisonous Plants sites](#)

General poisoning notes:

Naked-flowered sneezeweed (*Helenium flexuosum*) is a native herb found in Ontario and Quebec. This plant has caused poisoning in horses and sheep and, experimentally, in calves. It contains sesquiterpene lactones.



References:

Kingsbury, J. M. 1964. Poisonous plants of the United States and Canada. Prentice-Hall Inc., Englewood Cliffs, N.J., USA. 626 pp.

Nomenclature:

Scientific Name: *Helenium flexuosum* Raf.

Vernacular name(s): naked-flowered sneezeweed

Scientific family name: *Compositae*

Vernacular family name: composite

Go to ITIS^{*ca} for more taxonomic information on: [Helenium flexuosum](#)

References:

Agriculture Quebec. 1975. Noms des maladies des plantes du Canada/ Names of plant diseases in Canada. , Quebec City, Que., Canada. 288 pp.

Alex, J. F., Cayouette, R., Mulligan, G. A. 1980. Common and botanical names of weeds in Canada/Noms populaire et scientifiques des plantes nuisibles du Canada. Revised. Agric.

Can. Publ., Ottawa, Ont., Canada. 132 pp.

Bailey, L. H., Bailey, E. Z. 1976. Hortus third. Revised. MacMillan, New York, N.Y., USA. 1290 pp.

Scoggan, H. J. 1978, 1979. The flora of Canada. Nat. Mus. Nat. Sci. (Ottawa) Publ. Bot. 7(1)-7(4). 1711 pp.

Van Wijk, H. L. 1911. A dictionary of plant names. Martinus Nijhoff, The Hague, The Netherlands. 1444 pp.

Victorin, M. 1964. Flore Laurentienne. 2nd ed. Univ. Montreal, Montreal, Que., Canada. 952 pp.

Geographic Information

Ontario

Quebec

References:

Bailey, L. H., Bailey, E. Z. 1976. Hortus third. Revised. MacMillan, New York, N.Y., USA. 1290 pp.

Boivin, B. 1966, 1967. Énumération des plantes du Canada. Provencheria 6. Nat. Can. (Que.) 93: 253-274; 371-437; 583-646; 989-1063. 94: 131-157; 471-528; 625-655.

Image or illustration

naked-flowered sneezeweed:

Images: images.google.com

Toxic parts:

leaves

stems

References:

Herz, W. 1978. Sesquiterpene lactones from livestock poisons. Pages 487-497 in Keeler, R. F., Van Kampen, K. R., James, L. F., eds. Effects of poisonous plants on livestock. Academic Press, New York, N.Y., USA. 600 pp.

Notes on Toxic plant chemicals:

Flexuosin A and B are closely related to the chemical helenalin, which is found in sneezeweed (*Helenium autumnale*). These are all sesquiterpene lactones (Herz 1988).

Toxic plant chemicals:

flexuosin A

flexuosin B

References:

Herz, W. 1978. Sesquiterpene lactones from livestock poisons. Pages 487-497 in Keeler, R. F., Van Kampen, K. R., James, L. F., eds. Effects of poisonous plants on livestock. Academic Press, New York, N.Y., USA. 600 pp.

Animals/Human Poisoning:

Note: When an animal is listed without additional information, the literature (as of 1993) contained no detailed explanation.

Cattle

Horses

Sheep

General symptoms of poisoning:

[convulsions](#)

[dyspnea](#)

[weakness](#)

Notes on poisoning:

Horses are more susceptible than sheep to poisoning by naked-flowered sneezeweed (Kingsbury 1964).

References:

Kingsbury, J. M. 1964. Poisonous plants of the United States and Canada. Prentice-Hall Inc., Englewood Cliffs, N.J., USA. 626 pp.

[Another search?](#)

[Français](#) | [Contact Us](#) | [Help](#) | [Search](#) | [Canada site](#)

[Coming Events](#) | [About CBIF](#) | [Links](#) | [Reports and Publications](#) |

[Home](#)

Date modified: 2003-02-06

[Important Notices](#)



Français	Contact us	Help	Search	Canada site
Coming events	About CBIF	Links	Reports and publications	Home

Canadian Biodiversity Information Facility



Notes on poisoning: narcissus

[Introduction](#)

[Interactive](#)

[All poisonous plants by Botanical name](#)

[All poisonous plants by Common name](#)

[Important WWW Poisonous Plants sites](#)



General poisoning notes:

Narcissus (*Narcissus poeticus*) is an ornamental bulb that is planted outdoors as a perennial and is occasionally used indoors as a winter forced flower. This plant contains allergens in the aboveground plant parts, which cause dermatitis in sensitive humans. Ingesting the bulbs can cause poisoning in humans and has also poisoned some cattle. Family pets could be at risk if they ingest quantities of this plant. Serious cases of poisoning are rare. Humans have been poisoned only when the bulbs were mistaken for onions (Mitchell and Rook 1979, Litovitz and Fahey 1982, Cooper and Johnson 1984). See notes under daffodil ([Narcissus pseudonarcissus](#)) for more information.

References:

Cooper, M. R., Johnson, A. W. 1984. Poisonous plants in Britain and their effects on animals and man. Her Majesty's Stationery Office, London, England. 305 pp.

Lampe, K. F., McCann, M. A. 1985. AMA Handbook of poisonous and injurious plants. American Medical Assoc. Chicago, Ill., USA. 432 pp.

Litovitz, T. L., Fahey, B. A. 1982. Please don't eat the daffodils. N. Eng. J. Med., 306: 547.

Mitchell, J. C., Rook, A. 1979. Botanical dermatology. Greenglass Ltd, Vancouver, B.C., Canada. 787 pp.

Nomenclature:

Scientific Name: *Narcissus poeticus* L.

Vernacular name(s): narcissus

Scientific family name: *Amaryllidaceae*

Vernacular family name: amaryllis

Go to ITIS^{*ca} for more taxonomic information on: [Narcissus poeticus](#)

References:

Agriculture Quebec. 1975. Noms des maladies des plantes du Canada/ Names of plant diseases in Canada. , Quebec City, Que., Canada. 288 pp.

Alex, J. F., Cayouette, R., Mulligan, G. A. 1980. Common and botanical names of weeds in Canada/Noms populaire et scientifiques des plantes nuisibles du Canada. Revised. Agric. Can. Publ., Ottawa, Ont., Canada. 132 pp.

Bailey, L. H., Bailey, E. Z. 1976. Hortus third. Revised. MacMillan, New York, N.Y., USA. 1290 pp.

Scoggan, H. J. 1978, 1979. The flora of Canada. Nat. Mus. Nat. Sci. (Ottawa) Publ. Bot. 7(1)-7(4). 1711 pp.

Van Wijk, H. L. 1911. A dictionary of plant names. Martinus Nijhoff, The Hague, The Netherlands. 1444 pp.

Victorin, M. 1964. Flore Laurentienne. 2nd ed. Univ. Montreal, Montreal, Que., Canada. 952 pp.

Geographic Information

Plant or plant parts used in or around the home.

References:

Bailey, L. H., Bailey, E. Z. 1976. Hortus third. Revised. MacMillan, New York, N.Y., USA. 1290 pp.

Boivin, B. 1966, 1967. Énumération des plantes du Canada. Provencheria 6. Nat. Can. (Que.) 93: 253-274; 371-437; 583-646; 989-1063. 94: 131-157; 471-528; 625-655.

Image or illustration

narcissus:

Images: images.google.com

Notes on Poisonous plant parts:

See notes under daffodil ([Narcissus pseudonarcissus](#)) for more information.

Toxic parts:

bulbs
flowers
leaves

References:

Lampe, K. F., McCann, M. A. 1985. AMA Handbook of poisonous and injurious plants. American Medical Assoc. Chicago, Ill., USA. 432 pp.

Notes on Toxic plant chemicals:

The bulbs contain oxalate crystals as well as an alkaloid lycorine, which cause toxic problems. Unknown allergens in the leaves and flowers cause dermatitis in sensitive individuals (Mitchell and Rook 1979).

Toxic plant chemicals:

lycorine
oxalate

References:

Lampe, K. F., McCann, M. A. 1985. AMA Handbook of poisonous and injurious plants. American Medical Assoc. Chicago, Ill., USA. 432 pp.

Animals/Human Poisoning:

Note: When an animal is listed without additional information, the literature (as of 1993) contained no detailed explanation.

Cattle

General symptoms of poisoning:

[convulsions](#)
[gastroenteritis](#)

Notes on poisoning:

In World War II, cattle were fed bulbs of daffodils, with toxic results. Ingesting narcissus bulbs can have similar results. The animals were given these plants because of scarce food supplies (Cooper and Johnson 1984).

References:

Cooper, M. R., Johnson, A. W. 1984. Poisonous plants in Britain and their effects on animals and man. Her Majesty's Stationery Office, London, England. 305 pp.

Humans

General symptoms of poisoning:

[dizziness](#)

[eczema](#)

[erythema](#)

[nausea](#)

[skin, flushed](#)

[vomiting](#)

Notes on poisoning:

Symptoms of ingesting narcissus bulbs include lightheadedness, nausea, and vomiting. More severe symptoms are rare because of rapid emesis (Litovitz and Fahey 1982).

References:

Litovitz, T. L., Fahey, B. A. 1982. Please don't eat the daffodils. N. Eng. J. Med., 306: 547.

Mitchell, J. C., Rook, A. 1979. Botanical dermatology. Greenglass Ltd, Vancouver, B.C., Canada. 787 pp.

[Another search?](#)

[Français](#) | [Contact Us](#) | [Help](#) | [Search](#) | [Canada site](#)

[Coming Events](#) | [About CBIF](#) | [Links](#) | [Reports and Publications](#) |

[Home](#)

Date modified: 2003-02-06

[Important Notices](#)



Français	Contact us	Help	Search	Canada site
Coming events	About CBIF	Links	Reports and publications	Home

Canadian Biodiversity Information Facility



Notes on poisoning: northern water-hemlock

[Introduction](#)[Interactive](#)[All poisonous plants by Botanical name](#)[All poisonous plants by Common name](#)[Important WWW Poisonous Plants sites](#)

General poisoning notes:

Northern water-hemlock (*Cicuta virosa*) is a native perennial herb found in wet soils across northern Canada. It contains lower quantities of the toxic chemicals that cause poisoning in humans and livestock. However, Frohne and Pfander (1983) mention a case of human poisoning in Europe after ingestion of some rootstock of this plant. Livestock can also be poisoned if enough of the plants are ingested. Instances of poisoning in Canada should be fewer for northern water-hemlock because the concentration of chemicals is lower and the plant has essentially a boreal distribution outside of major livestock-growing areas. See additional information under [Cicuta maculata](#)



References:

Frohne, D., Pfander, H. J. 1983. A colour atlas of poisonous plants. Wolfe Publishing Ltd., London, England. 291 pp.

Nomenclature:

Scientific Name: *Cicuta virosa* L.

Vernacular name(s): northern water-hemlock

Scientific family name: *Umbelliferae*

Vernacular family name: parsley

Go to ITIS*^{ca} for more taxonomic information on: [Cicuta virosa](#)

References:

Agriculture Quebec. 1975. Noms des maladies des plantes du Canada/ Names of plant diseases in Canada. , Quebec City, Que., Canada. 288 pp.

Alex, J. F., Cayouette, R., Mulligan, G. A. 1980. Common and botanical names of weeds in Canada/Noms populaire et scientifiques des plantes nuisibles du Canada. Revised. Agric. Can. Publ., Ottawa, Ont., Canada. 132 pp.

Bailey, L. H., Bailey, E. Z. 1976. Hortus third. Revised. MacMillan, New York, N.Y., USA. 1290 pp.

Scoggan, H. J. 1978, 1979. The flora of Canada. Nat. Mus. Nat. Sci. (Ottawa) Publ. Bot. 7(1)-7(4). 1711 pp.

Van Wijk, H. L. 1911. A dictionary of plant names. Martinus Nijhoff, The Hague, The Netherlands. 1444 pp.

Victorin, M. 1964. Flore Laurentienne. 2nd ed. Univ. Montreal, Montreal, Que., Canada. 952 pp.

Geographic Information

Alberta
British Columbia
Manitoba
Northwest Territories
Ontario
Quebec
Saskatchewan
Yukon Territory

References:

Bailey, L. H., Bailey, E. Z. 1976. Hortus third. Revised. MacMillan, New York, N.Y., USA. 1290 pp.

Boivin, B. 1966, 1967. Énumération des plantes du Canada. Provencheria 6. Nat. Can. (Que.) 93: 253-274; 371-437; 583-646; 989-1063. 94: 131-157; 471-528; 625-655.

Image or illustration

northern water-hemlock:

Images: images.google.com

Toxic parts:

leaves
roots

References:

Frohne, D., Pfander, H. J. 1983. A colour atlas of poisonous plants. Wolfe Publishing Ltd., London, England. 291 pp.

Toxic plant chemicals:

cicutol

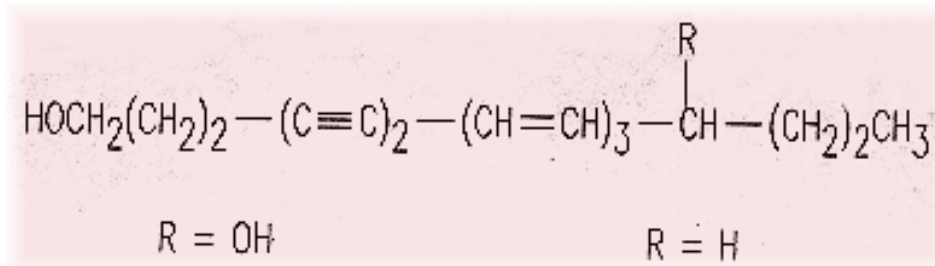

cicutoxin

Chemical diagram(s) are courtesy of [Ruth McDiarmid](#), Biochemistry Technician, Kamloops Range Station, Agriculture and Agri-Food Canada, Kamloops, British Columbia, Canada.

References:

Frohne, D., Pfander, H. J. 1983. A colour atlas of poisonous plants. Wolfe Publishing Ltd., London, England. 291 pp.

Animals/Human Poisoning:

Note: When an animal is listed without additional information, the literature (as of 1993) contained no detailed explanation.

Horses

Humans

[Another search?](#)

[Français](#) | [Contact Us](#) | [Help](#) | [Search](#) | [Canada site](#)

[Coming Events](#) | [About CBIF](#) | [Links](#) | [Reports and Publications](#) | [Home](#)

Date modified: 2003-02-06

[Important Notices](#)



Français	Contact us	Help	Search	Canada site
Coming events	About CBIF	Links	Reports and publications	Home

Canadian Biodiversity Information Facility

Notes on poisoning: oats

[Introduction](#)

[Interactive](#)

[All poisonous plants by Botanical name](#)

[All poisonous plants by Common name](#)

[Important WWW Poisonous Plants sites](#)

General poisoning notes:

Oats (*Avena sativa*) can cause nitrate toxicity in livestock. Cattle are more prone to toxicity, but swine and turkeys have been poisoned on oat stubble. Grass tetany also occurs during periods of lush growth when ruminants suffer from a mineral imbalance.

References:

Kingsbury, J. M. 1964. Poisonous plants of the United States and Canada. Prentice-Hall Inc., Englewood Cliffs, N.J., USA. 626 pp.

Newsom, I. E., Stout, E. N., Thorp, F., Barber, C. W., Groth, A. H. 1937. Oat hay poisoning. J. Am. Vet. Med. Assoc., 90: 66-75.

Nomenclature:

Scientific Name: *Avena sativa* L.

Vernacular name(s): oats

Scientific family name: *Gramineae*

Vernacular family name: grass

Go to ITIS^{*ca} for more taxonomic information on: [Avena sativa](#)

References:

Agriculture Quebec. 1975. Noms des maladies des plantes du Canada/ Names of plant diseases in Canada. , Quebec City, Que., Canada. 288 pp.

Alex, J. F., Cayouette, R., Mulligan, G. A. 1980. Common and botanical names of weeds in Canada/Noms populaire et scientifiques des plantes nuisibles du Canada. Revised. Agric. Can. Publ., Ottawa, Ont., Canada. 132 pp.

Bailey, L. H., Bailey, E. Z. 1976. Hortus third. Revised. MacMillan, New York, N.Y., USA. 1290 pp.

Scoggan, H. J. 1978, 1979. The flora of Canada. Nat. Mus. Nat. Sci. (Ottawa) Publ. Bot. 7(1)-7(4). 1711 pp.

Van Wijk, H. L. 1911. A dictionary of plant names. Martinus Nijhoff, The Hague, The Netherlands. 1444 pp.

Victorin, M. 1964. Flore Laurentienne. 2nd ed. Univ. Montreal, Montreal, Que., Canada. 952 pp.

Geographic Information

Alberta
British Columbia
Manitoba
New Brunswick
Newfoundland
Nova Scotia
Ontario
Prince Edward Island
Quebec
Saskatchewan
Yukon Territory

References:

Bailey, L. H., Bailey, E. Z. 1976. Hortus third. Revised. MacMillan, New York, N.Y., USA. 1290 pp.

Boivin, B. 1966, 1967. Énumération des plantes du Canada. Provencheria 6. Nat. Can. (Que.) 93: 253-274; 371-437; 583-646; 989-1063. 94: 131-157; 471-528; 625-655.

Image or illustration

oats:

Images: images.google.com

Toxic parts:

leaves
stems

References:

Kingsbury, J. M. 1964. Poisonous plants of the United States and Canada. Prentice-Hall Inc., Englewood Cliffs, N.J., USA. 626 pp.

Notes on Toxic plant chemicals:

Oat hay is a common source of plant poisoning by nitrates. Evidence suggests that moisture on outdoor hay may promote bacterial reduction of nitrate to the more toxic nitrite (Kingsbury 1964).

Toxic plant chemicals:

nitrate

References:

Kingsbury, J. M. 1964. Poisonous plants of the United States and Canada. Prentice-Hall Inc., Englewood Cliffs, N.J., USA. 626 pp.

Animals/Human Poisoning:

Note: When an animal is listed without additional information, the literature (as of 1993) contained no detailed explanation.

Cattle

General symptoms of poisoning:

[cyanosis](#)

[death](#)

[gait, staggering](#)

[trembling](#)

[weakness](#)

References:

Newsom, I. E., Stout, E. N., Thorp, F., Barber, C. W., Groth, A. H. 1937. Oat hay poisoning. J. Am. Vet. Med. Assoc., 90: 66-75.

Swine

Turkeys

[Another search?](#)

[Français](#) | [Contact Us](#) | [Help](#) | [Search](#) | [Canada site](#)

[Coming Events](#) | [About CBIF](#) | [Links](#) | [Reports and Publications](#) | [Home](#)

Date modified: 2003-02-06

[Important Notices](#)



Français	Contact us	Help	Search	Canada site
Coming events	About CBIF	Links	Reports and publications	Home

Canadian Biodiversity Information Facility



Notes on poisoning: Ohio buckeye

[Introduction](#)[Interactive](#)[All poisonous plants by Botanical name](#)[All poisonous plants by Common name](#)[Important WWW Poisonous Plants sites](#)

General poisoning notes:

Ohio buckeye (*Aesculus glabra*) is not native to Canada but is occasionally planted as an ornamental tree in southern Ontario. It is winter-hardy in Ottawa. Cattle have been poisoned in the eastern United States, where this tree is a native species. Symptoms are mostly gastrointestinal and neuromuscular (Kornheiser 1983). This plant is unlikely to cause livestock poisoning because it is rare in Canada. The fruits of this plant may be attractive to children and could cause poisoning if ingested.

References:

Kornheiser, K. M. 1983. Buckeye poisoning in cattle. *Vet. Med. Small Anim. Clin.*, 78: 769-770.

Lampe, K. F., McCann, M. A. 1985. *AMA Handbook of poisonous and injurious plants*. American Medical Assoc. Chicago, Ill., USA. 432 pp.

Nomenclature:

Scientific Name: *Aesculus glabra* Willd.

Vernacular name(s): Ohio buckeye

Scientific family name: *Hippocastanaceae*

Vernacular family name: horse-chestnut

Go to ITIS^{*ca} for more taxonomic information on: [Aesculus glabra](#)

References:

Agriculture Quebec. 1975. Noms des maladies des plantes du

Canada/ Names of plant diseases in Canada. , Quebec City, Que., Canada. 288 pp.

Alex, J. F., Cayouette, R., Mulligan, G. A. 1980. Common and botanical names of weeds in Canada/Noms populaire et scientifiques des plantes nuisibles du Canada. Revised. Agric. Can. Publ., Ottawa, Ont., Canada. 132 pp.

Bailey, L. H., Bailey, E. Z. 1976. Hortus third. Revised. MacMillan, New York, N.Y., USA. 1290 pp.

Scoggan, H. J. 1978, 1979. The flora of Canada. Nat. Mus. Nat. Sci. (Ottawa) Publ. Bot. 7(1)-7(4). 1711 pp.

Van Wijk, H. L. 1911. A dictionary of plant names. Martinus Nijhoff, The Hague, The Netherlands. 1444 pp.

Victorin, M. 1964. Flore Laurentienne. 2nd ed. Univ. Montreal, Montreal, Que., Canada. 952 pp.

Geographic Information

Plant or plant parts used in or around the home.

References:

Bailey, L. H., Bailey, E. Z. 1976. Hortus third. Revised. MacMillan, New York, N.Y., USA. 1290 pp.

Boivin, B. 1966, 1967. Énumération des plantes du Canada. Provencheria 6. Nat. Can. (Que.) 93: 253-274; 371-437; 583-646; 989-1063. 94: 131-157; 471-528; 625-655.

Image or illustration

Ohio buckeye:

Images: images.google.com

Toxic parts:

mature fruit

References:

Kornheiser, K. M. 1983. Buckeye poisoning in cattle. Vet. Med. Small Anim. Clin., 78: 769-770.

Animals/Human Poisoning:

Note: When an animal is listed without additional information,

the literature (as of 1993) contained no detailed explanation.

Cattle

General symptoms of poisoning:

[ataxia](#)

[gait, unsteady](#)

[opisthotonos](#)

[torticollis](#)

References:

Kornheiser, K. M. 1983. Buckeye poisoning in cattle. *Vet. Med. Small Anim. Clin.*, 78: 769-770.

Humans

General symptoms of poisoning:

[death](#)

[gastroenteritis](#)

References:

Lampe, K. F., McCann, M. A. 1985. *AMA Handbook of poisonous and injurious plants*. American Medical Assoc. Chicago, Ill., USA. 432 pp.

[Another search?](#)

[Français](#) | [Contact Us](#) | [Help](#) | [Search](#) | [Canada site](#)

[Coming Events](#) | [About CBIF](#) | [Links](#) | [Reports and Publications](#) |

[Home](#)

Date modified: 2003-02-06

[Important Notices](#)



Français	Contact us	Help	Search	Canada site
Coming events	About CBIF	Links	Reports and publications	Home

Canadian Biodiversity Information Facility



Notes on poisoning: oleander

[Introduction](#)

[Interactive](#)

[All poisonous plants by Botanical name](#)

[All poisonous plants by Common name](#)

[Important WWW Poisonous Plants sites](#)



General poisoning notes:

Oleander (*Nerium oleander*) is an ornamental indoor shrub found in Canadian homes and offices. This plant is quite toxic if the leaves or stems are ingested. Humans have died after eating meat that was skewered with oleander stems. Ingesting a single leaf may be toxic to a person. The dry leaves remain toxic. Cattle, horses, and sheep have been poisoned experimentally (Wilson 1909, Kingsbury 1964). Livestock are not likely to have access to oleander in Canada. Children and family pets should be prevented from ingesting green or dry leaves, chewing stems, or sucking the nectar from flowers.

References:

Kingsbury, J. M. 1964. Poisonous plants of the United States and Canada. Prentice-Hall Inc., Englewood Cliffs, N.J., USA. 626 pp.

Wilson, F. W. 1909. Oleander poisoning of livestock. Univ. Ariz. Agric. Exp. Stn. Bull., 59. 383-397 pp.

Nomenclature:

Scientific Name: *Nerium oleander* L.

Vernacular name(s): oleander

Scientific family name: *Apocynaceae*

Vernacular family name: dogbane

Go to ITIS^{*ca} for more taxonomic information on: [Nerium oleander](#)

References:

Agriculture Quebec. 1975. Noms des maladies des plantes du

Canada/ Names of plant diseases in Canada. , Quebec City, Que., Canada. 288 pp.

Alex, J. F., Cayouette, R., Mulligan, G. A. 1980. Common and botanical names of weeds in Canada/Noms populaire et scientifiques des plantes nuisibles du Canada. Revised. Agric. Can. Publ., Ottawa, Ont., Canada. 132 pp.

Bailey, L. H., Bailey, E. Z. 1976. Hortus third. Revised. MacMillan, New York, N.Y., USA. 1290 pp.

Scoggan, H. J. 1978, 1979. The flora of Canada. Nat. Mus. Nat. Sci. (Ottawa) Publ. Bot. 7(1)-7(4). 1711 pp.

Van Wijk, H. L. 1911. A dictionary of plant names. Martinus Nijhoff, The Hague, The Netherlands. 1444 pp.

Victorin, M. 1964. Flore Laurentienne. 2nd ed. Univ. Montreal, Montreal, Que., Canada. 952 pp.

Geographic Information

Plant or plant parts used in or around the home.

References:

Bailey, L. H., Bailey, E. Z. 1976. Hortus third. Revised. MacMillan, New York, N.Y., USA. 1290 pp.

Boivin, B. 1966, 1967. Énumération des plantes du Canada. Provencheria 6. Nat. Can. (Que.) 93: 253-274; 371-437; 583-646; 989-1063. 94: 131-157; 471-528; 625-655.

Image or illustration

oleander:

Images: images.google.com

Toxic parts:

all parts
flowers
leaves
stems
young shoots

References:

Fuller, T. C., McClintock, E. 1986. Poisonous plants of California. Univ. California Press, Berkeley, Calif., USA. 432 pp.

Notes on Toxic plant chemicals:

Oleandrin, a cardiac glycoside, is found throughout the plant, including the nectar of the flowers. Smoke from burning twigs is said to be toxic (Fuller and McClintock 1986).

Toxic plant chemicals:

oleandrin

References:

Fuller, T. C., McClintock, E. 1986. Poisonous plants of California. Univ. California Press, Berkeley, Calif., USA. 432 pp.

Animals/Human Poisoning:

Note: When an animal is listed without additional information, the literature (as of 1993) contained no detailed explanation.

Cattle

General symptoms of poisoning:

[breathing, rapid](#)

[death](#)

[heart rate, elevated](#)

[mouth, irritation of](#)

[pupil dilation](#)

Notes on poisoning:

Experimental poisoning of cattle has shown symptoms that include elevated breathing and heart rate. If a large dose is given, the heart action becomes so low that a pulse is almost undetectable. Green leaves at a rate of as little as 0.005% of a cow's body weight can cause death (Wilson 1909, Kingsbury 1964).

References:

Kingsbury, J. M. 1964. Poisonous plants of the United States and Canada. Prentice-Hall Inc., Englewood Cliffs, N.J., USA. 626 pp.

Wilson, F. W. 1909. Oleander poisoning of livestock. Univ. Ariz. Agric. Exp. Stn. Bull., 59. 383-397 pp.

Horses

General symptoms of poisoning:

[breathing, rapid](#)

[death](#)

[mouth, irritation of](#)

[pupil dilation](#)

Notes on poisoning:

Experimental poisoning of horses with fresh oleander leaves resulted in toxic symptoms, including elevated breathing and pulse, greenish feces, some abdominal pain, cold extremities, and a swollen and irritated mouth and tongue. A dose of green leaves equal to 0.005% of a horse's body weight is sufficient to kill a horse (Wilson 1909, Kingsbury 1964).

References:

Kingsbury, J. M. 1964. Poisonous plants of the United States and Canada. Prentice-Hall Inc., Englewood Cliffs, N.J., USA. 626 pp.

Wilson, F. W. 1909. Oleander poisoning of livestock. Univ. Ariz. Agric. Exp. Stn. Bull., 59. 383-397 pp.

Humans

General symptoms of poisoning:

[abdominal pains](#)

[coma](#)

[death](#)

[diarrhea](#)

[dizziness](#)

[drowsiness](#)

[dyspnea](#)

[mouth, irritation of](#)

[nausea](#)

Notes on poisoning:

Humans have been poisoned from using the twigs of oleander to skewer meat or roast frankfurters. Ingesting a single green or dry leaf may cause poisoning. Symptoms include dizziness, abdominal pain, vomiting, unconsciousness, bloody stools, and light and rapid pulse. Death has occurred in some cases. Symptoms occur several hours after ingesting a toxic dose (Wilson 1909, Kingsbury 1964).

References:

Kingsbury, J. M. 1964. Poisonous plants of the United States and Canada. Prentice-Hall Inc., Englewood Cliffs, N.J., USA. 626 pp.

Wilson, F. W. 1909. Oleander poisoning of livestock. Univ. Ariz. Agric. Exp. Stn. Bull., 59. 383-397 pp.

Sheep

General symptoms of poisoning:

[breathing, rapid](#)

[death](#)

[mouth, irritation of](#)

Notes on poisoning:

Experimental feeding of green oleander leaves has caused elevated breathing, partial unconsciousness, sore mouth and nostrils, discolored mucous membranes, and death (dose: 0.015% body weight of green leaves). Cold extremities and gastroenteritis also occur (Wilson 1909, Kingsbury 1964).

References:

Kingsbury, J. M. 1964. Poisonous plants of the United States and Canada. Prentice-Hall Inc., Englewood Cliffs, N.J., USA. 626 pp.

Wilson, F. W. 1909. Oleander poisoning of livestock. Univ. Ariz. Agric. Exp. Stn. Bull., 59. 383-397 pp.

[Another search?](#)

[Français](#) | [Contact Us](#) | [Help](#) | [Search](#) | [Canada site](#)

[Coming Events](#) | [About CBIF](#) | [Links](#) | [Reports and Publications](#) |

[Home](#)

Date modified: 2003-02-06

[Important Notices](#)



Français	Contact us	Help	Search	Canada site
Coming events	About CBIF	Links	Reports and publications	Home

Canadian Biodiversity Information Facility



Notes on poisoning: onion

[Introduction](#)

[Interactive](#)

[All poisonous plants by Botanical name](#)

[All poisonous plants by Common name](#)

[Important WWW Poisonous Plants sites](#)



General poisoning notes:

Cultivated onion (*Allium cepa*) has caused hemolytic anemia in livestock including cattle, horses, and experimentally in sheep. Death can occur in severe cases. The formation of Heinz bodies in the red blood cells is a common occurrence. Heinz bodies consist of a precipitate, denatured hemoglobin caused by oxidant attack (Hutchinson 1977).

References:

Hutchinson, T. W. 1977. Onions as a cause of Heinz body anaemia and death in cattle. *Can. Vet. J.*, 18: 358-360.

Kirk, J. H., Bulgin, M. S. 1979. Effects of feeding cull domestic onions (*Allium cepa*) to sheep. *Am. J. Vet. Res.*, 40: 397-399.

Thorp, F., Harshfield, G. S. 1939. Onion poisoning in horses. *J. Am. Vet. Med. Assoc.*, 94: 52-53.

Nomenclature:

Scientific Name: *Allium cepa* L.

Vernacular name(s): onion

Scientific family name: *Liliaceae*

Vernacular family name: lily

Go to ITIS^{*ca} for more taxonomic information on: [Allium cepa](#)

References:

Agriculture Quebec. 1975. Noms des maladies des plantes du Canada/ Names of plant diseases in Canada. , Quebec City, Que., Canada. 288 pp.

Alex, J. F., Cayouette, R., Mulligan, G. A. 1980. Common and botanical names of weeds in Canada/Noms populaire et scientifiques des plantes nuisibles du Canada. Revised. Agric. Can. Publ., Ottawa, Ont., Canada. 132 pp.

Bailey, L. H., Bailey, E. Z. 1976. Hortus third. Revised. MacMillan, New York, N.Y., USA. 1290 pp.

Scoggan, H. J. 1978, 1979. The flora of Canada. Nat. Mus. Nat. Sci. (Ottawa) Publ. Bot. 7(1)-7(4). 1711 pp.

Van Wijk, H. L. 1911. A dictionary of plant names. Martinus Nijhoff, The Hague, The Netherlands. 1444 pp.

Victorin, M. 1964. Flore Laurentienne. 2nd ed. Univ. Montreal, Montreal, Que., Canada. 952 pp.

Geographic Information

Plant or plant parts used in or around the home.

References:

Bailey, L. H., Bailey, E. Z. 1976. Hortus third. Revised. MacMillan, New York, N.Y., USA. 1290 pp.

Boivin, B. 1966, 1967. Énumération des plantes du Canada. Provencheria 6. Nat. Can. (Que.) 93: 253-274; 371-437; 583-646; 989-1063. 94: 131-157; 471-528; 625-655.

Image or illustration

onion:

Images: images.google.com

Toxic parts:

bulbs
leaves

References:

Hutchinson, T. W. 1977. Onions as a cause of Heinz body anaemia and death in cattle. Can. Vet. J., 18: 358-360.

Kirk, J. H., Bulgin, M. S. 1979. Effects of feeding cull domestic onions (*Allium cepa*) to sheep. Am. J. Vet. Res., 40: 397-399.

Thorp, F., Harshfield, G. S. 1939. Onion poisoning in horses. J. Am. Vet. Med. Assoc., 94: 52-53.

Notes on Toxic plant chemicals:

Onions (*Allium* spp.) contain various toxins that can cause problems. N-propyl disulphide, an alkaloid, has been implicated as the toxic chemical (Hutchinson 1977). More recent studies have shown that S-methyl-L-cysteine sulfoxide (SMCO) is involved in forming Heinz bodies and hemolytic anemia. This chemical is less toxic in nonruminant animals (Benevenga et al. 1989).

(Note: calcium oxalate crystals have been found in the dry outer skin or scale leaves of this plant (Sarma and Terpó 1980)). Garlic (*Allium sativum*) is a cultivated plant grown for its bulbs.

Toxic plant chemicals:

N-propyl disulphide

oxalate

S-methyl-L-cysteine sulfoxide (SMCO)

References:

Benevenga, N. J., Case, G. L., Steele, R. D. 1989. Occurrence and metabolism of s-methyl-l-cysteine and s-methyl-l-cysteine sulfoxide in plants and their toxicity and metabolism in animals. Pages 203-228 in Cheeke, P. R., ed. Toxicants of plant origin. Vol. III. Proteins and amino acids. CRC Press, Inc., Boca Raton, Fla., USA. 271 pp.

Hutchinson, T. W. 1977. Onions as a cause of Heinz body anaemia and death in cattle. *Can. Vet. J.*, 18: 358-360.

Kirk, J. H., Bulgin, M. S. 1979. Effects of feeding cull domestic onions (*Allium cepa*) to sheep. *Am. J. Vet. Res.*, 40: 397-399.

Sarma, S. K., Terpó, A. 1980. The occurrence of different types of calcium oxalate crystals in *Allium cepa* L. and *Allium fistulosum* L. and their importance in taxonomy. *Acta Agron. Acad. Sci. Hung.*, 29: 25-37.

Animals/Human Poisoning:

Note: When an animal is listed without additional information, the literature (as of 1993) contained no detailed explanation.

Cattle

General symptoms of poisoning:

[death](#)

[Heinz bodies](#)

References:

Hutchinson, T. W. 1977. Onions as a cause of Heinz body anaemia and death in cattle. *Can. Vet. J.*, 18: 358-360.

Horses

General symptoms of poisoning:

[anemia](#)

[breath, onion odor of](#)

[breathing, rapid](#)

[death](#)

[icterus](#)

[weight loss](#)

References:

Thorp, F., Harshfield, G. S. 1939. Onion poisoning in horses. *J. Am. Vet. Med. Assoc.*, 94: 52-53.

Sheep

General symptoms of poisoning:

[anemia](#)

References:

Kirk, J. H., Bulgin, M. S. 1979. Effects of feeding cull domestic onions (*Allium cepa*) to sheep. *Am. J. Vet. Res.*, 40: 397-399.

[Another search?](#)

[Français](#) | [Contact Us](#) | [Help](#) | [Search](#) | [Canada site](#)

[Coming Events](#) | [About CBIF](#) | [Links](#) | [Reports and Publications](#) | [Home](#)

Date modified: 2003-02-06

[Important Notices](#)



Français	Contact us	Help	Search	Canada site
Coming events	About CBIF	Links	Reports and publications	Home

Canadian Biodiversity Information Facility



Notes on poisoning: opium poppy

[Introduction](#)

[Interactive](#)

[All poisonous plants by Botanical name](#)

[All poisonous plants by Common name](#)

[Important WWW Poisonous Plants sites](#)



General poisoning notes:

Opium poppy (*Papaver somniferum*) is an ornamental flower that can still be found around some older homes. The plant persists by setting seed each year. This plant is the source of pharmacological and recreational drugs, as well as the poppy seeds that are used for oil and as a condiment on bagels, cakes, and other foods. Cattle have been poisoned in Europe after ingesting either stalks with pods that were being discarded or seed residue left over from oil extraction. Humans are either poisoned or addicted by various contained and derived chemicals found in the opium poppy (Frohne and Pfander 1983, Cooper and Johnson 1984). It is important to note that poppy seeds sold in stores are harmless, as the toxins have been destroyed by heat (Fuller and McClintock 1986).

References:

Cooper, M. R., Johnson, A. W. 1984. Poisonous plants in Britain and their effects on animals and man. Her Majesty's Stationery Office, London, England. 305 pp.

Frohne, D., Pfander, H. J. 1983. A colour atlas of poisonous plants. Wolfe Publishing Ltd., London, England. 291 pp.

Fuller, T. C., McClintock, E. 1986. Poisonous plants of California. Univ. California Press, Berkeley, Calif., USA. 432 pp.

Nomenclature:

Scientific Name: *Papaver somniferum* L.

Vernacular name(s): opium poppy

Scientific family name: *Papaveraceae*

Vernacular family name: poppy

Go to ITIS*^{ca} for more taxonomic information on: [Papaver somniferum](#)

References:

Agriculture Quebec. 1975. Noms des maladies des plantes du Canada/ Names of plant diseases in Canada. , Quebec City, Que., Canada. 288 pp.

Alex, J. F., Cayouette, R., Mulligan, G. A. 1980. Common and botanical names of weeds in Canada/Noms populaire et scientifiques des plantes nuisibles du Canada. Revised. Agric. Can. Publ., Ottawa, Ont., Canada. 132 pp.

Bailey, L. H., Bailey, E. Z. 1976. Hortus third. Revised. MacMillan, New York, N.Y., USA. 1290 pp.

Scoggan, H. J. 1978, 1979. The flora of Canada. Nat. Mus. Nat. Sci. (Ottawa) Publ. Bot. 7(1)-7(4). 1711 pp.

Van Wijk, H. L. 1911. A dictionary of plant names. Martinus Nijhoff, The Hague, The Netherlands. 1444 pp.

Victorin, M. 1964. Flore Laurentienne. 2nd ed. Univ. Montreal, Montreal, Que., Canada. 952 pp.

Geographic Information

Plant or plant parts used in or around the home.

References:

Bailey, L. H., Bailey, E. Z. 1976. Hortus third. Revised. MacMillan, New York, N.Y., USA. 1290 pp.

Boivin, B. 1966, 1967. Énumération des plantes du Canada. Provencheria 6. Nat. Can. (Que.) 93: 253-274; 371-437; 583-646; 989-1063. 94: 131-157; 471-528; 625-655.

Image or illustration

opium poppy:

Images: images.google.com

Toxic parts:

all parts
immature fruit
plant juices

References:

Cooper, M. R., Johnson, A. W. 1984. Poisonous plants in Britain and their effects on animals and man. Her Majesty's Stationery Office, London, England. 305 pp.

Notes on Toxic plant chemicals:

Opium poppy contains a crude resin, opium, that is found throughout the plant but is concentrated in the unripe seed pod in the milky sap. Medicinal drugs, such as morphine and codeine, as well as other alkaloids, such as papaverine and protopine, are found in opium poppy (Cooper and Johnson 1984).

Toxic plant chemicals:

codine
morphine
protopine

References:

Cooper, M. R., Johnson, A. W. 1984. Poisonous plants in Britain and their effects on animals and man. Her Majesty's Stationery Office, London, England. 305 pp.

Animals/Human Poisoning:

Note: When an animal is listed without additional information, the literature (as of 1993) contained no detailed explanation.

Cattle

General symptoms of poisoning:

[ataxia](#)
[breathing, rapid](#)
[gastroenteritis](#)
[nervousness](#)

Notes on poisoning:

Cattle that ingested plant material of opium poppy exhibited symptoms of restlessness and constant motion. Continuous lowing occurred. Feeding, rumination, and lactation ceased. Animals went into a deep sleep. Affected animals are an economic loss because of the slow recovery and reduced milk yield. Postmortem examination showed inflammation of the kidneys and intestines, with yellowing of the liver (Cooper and

Johnson 1984).

References:

Cooper, M. R., Johnson, A. W. 1984. Poisonous plants in Britain and their effects on animals and man. Her Majesty's Stationery Office, London, England. 305 pp.

Humans

General symptoms of poisoning:

[cyanosis](#)

[death by asphyxiation](#)

[eczema](#)

[headache](#)

[pupils, pinpoint](#)

[sweating](#)

References:

Cooper, M. R., Johnson, A. W. 1984. Poisonous plants in Britain and their effects on animals and man. Her Majesty's Stationery Office, London, England. 305 pp.

Frohne, D., Pfander, H. J. 1983. A colour atlas of poisonous plants. Wolfe Publishing Ltd., London, England. 291 pp.

Fuller, T. C., McClintock, E. 1986. Poisonous plants of California. Univ. California Press, Berkeley, Calif., USA. 432 pp.

[Another search?](#)

[Français](#) | [Contact Us](#) | [Help](#) | [Search](#) | [Canada site](#)

[Coming Events](#) | [About CBIF](#) | [Links](#) | [Reports and Publications](#) |

[Home](#)

Date modified: 2003-02-06

[Important Notices](#)



Français	Contact us	Help	Search	Canada site
Coming events	About CBIF	Links	Reports and publications	Home

Canadian Biodiversity Information Facility



Notes on poisoning: Oriental poppy

[Introduction](#)[Interactive](#)[All poisonous plants by Botanical name](#)[All poisonous plants by Common name](#)[Important WWW Poisonous Plants sites](#)

General poisoning notes:

Oriental poppy (*Papaver orientale*) is a perennial ornamental herb that is commonly planted in flower beds. This plant contains some alkaloidal chemicals that may be physiologically active in animals, but no cases of poisoning have occurred under natural conditions. During fall and spring clean-up, all old flower heads and pods should be picked up so that they are not left for animals to eat (Kingsbury 1964).

References:

Kingsbury, J. M. 1964. Poisonous plants of the United States and Canada. Prentice-Hall Inc., Englewood Cliffs, N.J., USA. 626 pp.

Nomenclature:

Scientific Name: *Papaver orientale* L.

Vernacular name(s): Oriental poppy

Scientific family name: *Papaveraceae*

Vernacular family name: poppy

Go to ITIS^{*ca} for more taxonomic information on: [Papaver orientale](#)

References:

Agriculture Quebec. 1975. Noms des maladies des plantes du Canada/ Names of plant diseases in Canada. , Quebec City, Que., Canada. 288 pp.

Alex, J. F., Cayouette, R., Mulligan, G. A. 1980. Common and botanical names of weeds in Canada/Noms populaire et scientifiques des plantes nuisibles du Canada. Revised. Agric.

Can. Publ., Ottawa, Ont., Canada. 132 pp.

Bailey, L. H., Bailey, E. Z. 1976. Hortus third. Revised. MacMillan, New York, N.Y., USA. 1290 pp.

Scoggan, H. J. 1978, 1979. The flora of Canada. Nat. Mus. Nat. Sci. (Ottawa) Publ. Bot. 7(1)-7(4). 1711 pp.

Van Wijk, H. L. 1911. A dictionary of plant names. Martinus Nijhoff, The Hague, The Netherlands. 1444 pp.

Victorin, M. 1964. Flore Laurentienne. 2nd ed. Univ. Montreal, Montreal, Que., Canada. 952 pp.

Geographic Information

Plant or plant parts used in or around the home.

References:

Bailey, L. H., Bailey, E. Z. 1976. Hortus third. Revised. MacMillan, New York, N.Y., USA. 1290 pp.

Boivin, B. 1966, 1967. Énumération des plantes du Canada. Provencheria 6. Nat. Can. (Que.) 93: 253-274; 371-437; 583-646; 989-1063. 94: 131-157; 471-528; 625-655.

Image or illustration

Oriental poppy:

Images: images.google.com

Toxic parts:

all parts
plant juices

References:

Kingsbury, J. M. 1964. Poisonous plants of the United States and Canada. Prentice-Hall Inc., Englewood Cliffs, N.J., USA. 626 pp.

Notes on Toxic plant chemicals:

Some alkaloidal chemicals that may be physiologically active have been found in Oriental poppy (Kingsbury 1964).

Toxic plant chemicals:

unknown chemical

References:

Cooper, M. R., Johnson, A. W. 1984. Poisonous plants in Britain and their effects on animals and man. Her Majesty's Stationery Office, London, England. 305 pp.

Kingsbury, J. M. 1964. Poisonous plants of the United States and Canada. Prentice-Hall Inc., Englewood Cliffs, N.J., USA. 626 pp.

Animals/Human Poisoning:

Note: When an animal is listed without additional information, the literature (as of 1993) contained no detailed explanation.

Cattle

[Another search?](#)

[Français](#) | [Contact Us](#) | [Help](#) | [Search](#) | [Canada site](#)

[Coming Events](#) | [About CBIF](#) | [Links](#) | [Reports and Publications](#) |

[Home](#)

Date modified: 2003-02-06

[Important Notices](#)



Français	Contact us	Help	Search	Canada site
Coming events	About CBIF	Links	Reports and publications	Home

Canadian Biodiversity Information Facility



Notes on poisoning: Osage-orange

[Introduction](#)

[Interactive](#)

[All poisonous plants by Botanical name](#)

[All poisonous plants by Common name](#)

[Important WWW Poisonous Plants sites](#)

General poisoning notes:

Osage-orange (*Maclura pomifera*) is occasionally planted as an ornamental shrub in the warmest parts of Canada. The milky sap causes dermatitis in sensitive individuals. It is unclear whether the sap is an irritant, is sensitizing, or both (Muenscher 1975, Mitchell and Rook 1979).



References:

Muenscher, W. C. 1975. Poisonous plants of the United States. Revised. Collier Books, New York, N.Y., USA. 277 pp.

Nomenclature:

Scientific Name: *Maclura pomifera* (Raf.) C. K. Schneid.

Vernacular name(s): Osage-orange

Scientific family name: *Moraceae*

Vernacular family name: mulberry

Go to ITIS^{*ca} for more taxonomic information on: [Maclura pomifera](#)

References:

Agriculture Quebec. 1975. Noms des maladies des plantes du Canada/ Names of plant diseases in Canada. , Quebec City, Que., Canada. 288 pp.

Alex, J. F., Cayouette, R., Mulligan, G. A. 1980. Common and botanical names of weeds in Canada/Noms populaire et scientifiques des plantes nuisibles du Canada. Revised. Agric. Can. Publ., Ottawa, Ont., Canada. 132 pp.

Bailey, L. H., Bailey, E. Z. 1976. Hortus third. Revised. MacMillan, New York, N.Y., USA. 1290 pp.

Scoggan, H. J. 1978, 1979. The flora of Canada. Nat. Mus. Nat. Sci. (Ottawa) Publ. Bot. 7(1)-7(4). 1711 pp.

Van Wijk, H. L. 1911. A dictionary of plant names. Martinus Nijhoff, The Hague, The Netherlands. 1444 pp.

Victorin, M. 1964. Flore Laurentienne. 2nd ed. Univ. Montreal, Montreal, Que., Canada. 952 pp.

Geographic Information

Plant or plant parts used in or around the home.

References:

Bailey, L. H., Bailey, E. Z. 1976. Hortus third. Revised. MacMillan, New York, N.Y., USA. 1290 pp.

Boivin, B. 1966, 1967. Énumération des plantes du Canada. Provencheria 6. Nat. Can. (Que.) 93: 253-274; 371-437; 583-646; 989-1063. 94: 131-157; 471-528; 625-655.

Image or illustration

Osage-orange:

Images: images.google.com

Notes on Poisonous plant parts:

A milky juice is contained in the leaves, stems, and large fruit of this plant. Some humans are sensitive to the plant juice (Muenscher 1975).

Toxic parts:

plant juices

References:

Muenscher, W. C. 1975. Poisonous plants of the United States. Revised. Collier Books, New York, N.Y., USA. 277 pp.

Toxic plant chemicals:

unknown chemical

References:

Muenschler, W. C. 1975. Poisonous plants of the United States. Revised. Collier Books, New York, N.Y., USA. 277 pp.

Animals/Human Poisoning:

Note: When an animal is listed without additional information, the literature (as of 1993) contained no detailed explanation.

Humans

[Another search?](#)

[Français](#) | [Contact Us](#) | [Help](#) | [Search](#) | [Canada site](#)

[Coming Events](#) | [About CBIF](#) | [Links](#) | [Reports and Publications](#) | [Home](#)

Date modified: 2003-02-06

[Important Notices](#)



Français	Contact us	Help	Search	Canada site
Coming events	About CBIF	Links	Reports and publications	Home

Canadian Biodiversity Information Facility



Notes on poisoning: pawpaw

[Introduction](#)

[Interactive](#)

[All poisonous plants by Botanical name](#)

[All poisonous plants by Common name](#)

[Important WWW Poisonous Plants sites](#)

General poisoning notes:

Pawpaw (*Asimina triloba*) is a native tree found in southwestern Ontario. The tree has edible fruit that has caused dermatitis in some individuals and can also cause severe gastroenteritis when it is ingested. This tree has limited distribution in southwestern Ontario (Kingsbury 1964).



References:

Kingsbury, J. M. 1964. Poisonous plants of the United States and Canada. Prentice-Hall Inc., Englewood Cliffs, N.J., USA. 626 pp.

Nomenclature:

Scientific Name: *Asimina triloba* (L.) Dunal

Vernacular name(s): pawpaw

Scientific family name: *Annonaceae*

Vernacular family name: custard-apple

Go to ITIS*^{ca} for more taxonomic information on: [Asimina triloba](#)

References:

Agriculture Quebec. 1975. Noms des maladies des plantes du Canada/ Names of plant diseases in Canada. , Quebec City, Que., Canada. 288 pp.

Alex, J. F., Cayouette, R., Mulligan, G. A. 1980. Common and botanical names of weeds in Canada/Noms populaire et scientifiques des plantes nuisibles du Canada. Revised. Agric. Can. Publ., Ottawa, Ont., Canada. 132 pp.

Bailey, L. H., Bailey, E. Z. 1976. Hortus third. Revised. MacMillan, New York, N.Y., USA. 1290 pp.

Scoggan, H. J. 1978, 1979. The flora of Canada. Nat. Mus. Nat. Sci. (Ottawa) Publ. Bot. 7(1)-7(4). 1711 pp.

Van Wijk, H. L. 1911. A dictionary of plant names. Martinus Nijhoff, The Hague, The Netherlands. 1444 pp.

Victorin, M. 1964. Flore Laurentienne. 2nd ed. Univ. Montreal, Montreal, Que., Canada. 952 pp.

Geographic Information

Ontario

References:

Bailey, L. H., Bailey, E. Z. 1976. Hortus third. Revised. MacMillan, New York, N.Y., USA. 1290 pp.

Boivin, B. 1966, 1967. Énumération des plantes du Canada. Provencheria 6. Nat. Can. (Que.) 93: 253-274; 371-437; 583-646; 989-1063. 94: 131-157; 471-528; 625-655.

Image or illustration

pawpaw:

Images: images.google.com

Toxic parts:

mature fruit

References:

Kingsbury, J. M. 1964. Poisonous plants of the United States and Canada. Prentice-Hall Inc., Englewood Cliffs, N.J., USA. 626 pp.

Animals/Human Poisoning:

Note: When an animal is listed without additional information, the literature (as of 1993) contained no detailed explanation.

Humans

[Another search?](#)

[Français](#) | [Contact Us](#) | [Help](#) | [Search](#) | [Canada site](#)
[Coming Events](#) | [About CBIF](#) | [Links](#) | [Reports and Publications](#) |
[Home](#)

Date modified: 2003-02-06

[Important Notices](#)



Français	Contact us	Help	Search	Canada site
Coming events	About CBIF	Links	Reports and publications	Home

Canadian Biodiversity Information Facility



Notes on poisoning: penciltree

[Introduction](#)

[Interactive](#)

[All poisonous plants by Botanical name](#)

[All poisonous plants by Common name](#)

[Important WWW Poisonous Plants sites](#)



General poisoning notes:

Penciltree (*Euphorbia tirucalli*) is an attractive indoor ornamental tree. The plant contains caustic and irritant chemicals in the latex which cause reactions with the skin, mucous membranes, and the eyes. Severe burning and inflammation result after the latex comes into contact with the skin. Ingestion causes burning and irritation of the mouth and stomach, accompanied by pain and perhaps diarrhea. Apparently, injudicious medicinal use of the latex of this plant has caused fatalities in East Africa (Fuller and McClintock 1986). Family pets should not be allowed to ingest the plant.

References:

Crowder, J. I., Sexton, R. R. 1964. Keratoconjunctivitis resulting from the sap of candelabra cactus and the pencil tree. Arch. Ophthalmol., 72: 476-484.

Fuller, T. C., McClintock, E. 1986. Poisonous plants of California. Univ. California Press, Berkeley, Calif., USA. 432 pp.

Nomenclature:

Scientific Name: *Euphorbia tirucalli* L.

Vernacular name(s): penciltree

Scientific family name: *Euphorbiaceae*

Vernacular family name: spurge

Go to ITIS*^{ca} for more taxonomic information on: [Euphorbia tirucalli](#)

References:

Agriculture Quebec. 1975. Noms des maladies des plantes du Canada/ Names of plant diseases in Canada. , Quebec City, Que., Canada. 288 pp.

Alex, J. F., Cayouette, R., Mulligan, G. A. 1980. Common and botanical names of weeds in Canada/Noms populaire et scientifiques des plantes nuisibles du Canada. Revised. Agric. Can. Publ., Ottawa, Ont., Canada. 132 pp.

Bailey, L. H., Bailey, E. Z. 1976. Hortus third. Revised. MacMillan, New York, N.Y., USA. 1290 pp.

Scoggan, H. J. 1978, 1979. The flora of Canada. Nat. Mus. Nat. Sci. (Ottawa) Publ. Bot. 7(1)-7(4). 1711 pp.

Van Wijk, H. L. 1911. A dictionary of plant names. Martinus Nijhoff, The Hague, The Netherlands. 1444 pp.

Victorin, M. 1964. Flore Laurentienne. 2nd ed. Univ. Montreal, Montreal, Que., Canada. 952 pp.

Geographic Information

Plant or plant parts used in or around the home.

References:

Bailey, L. H., Bailey, E. Z. 1976. Hortus third. Revised. MacMillan, New York, N.Y., USA. 1290 pp.

Boivin, B. 1966, 1967. Énumération des plantes du Canada. Provencheria 6. Nat. Can. (Que.) 93: 253-274; 371-437; 583-646; 989-1063. 94: 131-157; 471-528; 625-655.

Image or illustration

penciltree:

Images: images.google.com

Toxic parts:

latex

References:

Fürstenberger, G., Hecker, E. 1986. On the active principles of the Euphorbiaceae, XII. Highly unsaturated irritant diterpene esters from *Euphorbia tirucalli* originating from Madagascar. J. Nat. Prod. (Lloydia), 49: 386-397.

Notes on Toxic plant chemicals:

Toxic ingenol and 4-deoxyingenol are diterpenes that have been isolated from the latex of pencil tree (Frohne and Pfander 1983; Fürstenberger and Hecker 1986).

Toxic plant chemicals:

4-deoxyingenol

References:

Fürstenberger, G., Hecker, E. 1986. On the active principles of the Euphorbiaceae, XII. Highly unsaturated irritant diterpene esters from *Euphorbia tirucalli* originating from Madagascar. J. Nat. Prod. (Lloydia), 49: 386-397.

Animals/Human Poisoning:

Note: When an animal is listed without additional information, the literature (as of 1993) contained no detailed explanation.

Humans

General symptoms of poisoning:

[blindness, temporary](#)
[keratoconjunctivitis](#)

Notes on poisoning:

Pencil tree latex causes keratoconjunctivitis if it gets into the eyes. The symptoms include immediate burning pain of the eyeball and eyelids, tearing, and photophobia. These symptoms are followed by 8-12 h of chemosis of the lids and conjunctiva, with blurred vision and increased pain. Erosion of the corneal epithelium, decreased visual acuity, and corneal edema occur (Crowder and Sexton 1964).

References:

Crowder, J. I., Sexton, R. R. 1964. Keratoconjunctivitis resulting from the sap of candelabra cactus and the pencil tree. Arch. Ophthalmol., 72: 476-484.

[Another search?](#)

[Français](#) | [Contact Us](#) | [Help](#) | [Search](#) | [Canada site](#)
[Coming Events](#) | [About CBIF](#) | [Links](#) | [Reports and Publications](#) |
[Home](#)

Date modified: 2003-02-06

[Important Notices](#)



Français	Contact us	Help	Search	Canada site
Coming events	About CBIF	Links	Reports and publications	Home

Canadian Biodiversity Information Facility



Notes on poisoning: Peruvian lily

[Introduction](#)

[Interactive](#)

[All poisonous plants by Botanical name](#)

[All poisonous plants by Common name](#)

[Important WWW Poisonous Plants sites](#)



General poisoning notes:

Peruvian lily (*Alstroemeria ligtu*) is grown as a cut flower by the florist industry. Cut flowers are also flown into North America from Holland. This plant causes contact dermatitis to workers who may be sensitized to the chemical tuliposide A, which is also found in tulip plants. This chemical readily penetrates vinyl gloves. Nitrile gloves may prevent the allergic reaction of workers sensitive to this chemical (Marks 1988).

References:

- Marks, J. G. 1988. Allergic contact dermatitis to *Alstroemeria*. Arch. Dermatol., 124: 914-916.
- Santucci, B., Picardo, M., Iavaroni, C., Trogolo, C. 1985. Contact dermatitis to *Alstroemeria*. Contact Dermatitis, 12: 215-219.
- Spoerke, D. G., Smolinske, S. C. 1990. Toxicity of houseplants. CRC Press, Inc., Boca Raton, Fla., USA. 335 pp.

Nomenclature:

Scientific Name: *Alstroemeria ligtu* L.

Vernacular name(s): Peruvian lily

Scientific family name: *Amaryllidaceae*

Vernacular family name: amaryllis

References:

- Agriculture Quebec. 1975. Noms des maladies des plantes du Canada/ Names of plant diseases in Canada. , Quebec City, Que., Canada. 288 pp.

Alex, J. F., Cayouette, R., Mulligan, G. A. 1980. Common and botanical names of weeds in Canada/Noms populaire et scientifiques des plantes nuisibles du Canada. Revised. Agric. Can. Publ., Ottawa, Ont., Canada. 132 pp.

Bailey, L. H., Bailey, E. Z. 1976. Hortus third. Revised. MacMillan, New York, N.Y., USA. 1290 pp.

Scoggan, H. J. 1978, 1979. The flora of Canada. Nat. Mus. Nat. Sci. (Ottawa) Publ. Bot. 7(1)-7(4). 1711 pp.

Van Wijk, H. L. 1911. A dictionary of plant names. Martinus Nijhoff, The Hague, The Netherlands. 1444 pp.

Victorin, M. 1964. Flore Laurentienne. 2nd ed. Univ. Montreal, Montreal, Que., Canada. 952 pp.

Geographic Information

Plant or plant parts used in or around the home.

References:

Bailey, L. H., Bailey, E. Z. 1976. Hortus third. Revised. MacMillan, New York, N.Y., USA. 1290 pp.

Boivin, B. 1966, 1967. Énumération des plantes du Canada. Provencheria 6. Nat. Can. (Que.) 93: 253-274; 371-437; 583-646; 989-1063. 94: 131-157; 471-528; 625-655.

Image or illustration

Peruvian lily:

Images: images.google.com

Toxic parts:

plant juices

References:

Marks, J. G. 1988. Allergic contact dermatitis to *Alstroemeria*. Arch. Dermatol., 124: 914-916.

Santucci, B., Picardo, M., Iavaroni, C., Trogolo, C. 1985. Contact dermatitis to *Alstroemeria*. Contact Dermatitis, 12: 215-219.

Notes on Toxic plant chemicals:

The lactone 6-tuliposide A occurs in both the Peruvian lily and in

tulip plants. A human who becomes sensitized to one of the plants generally becomes cross-reactive to the other plant. In a series of tests, it took about 3 years for workers to become sensitive to Peruvian lily (Santucci et al. 1985).

Toxic plant chemicals:

tuliposide A
6-tuliposide A

References:

Marks, J. G. 1988. Allergic contact dermatitis to *Alstroemeria*. Arch. Dermatol., 124: 914-916.

Santucci, B., Picardo, M., Iavaroni, C., Trogolo, C. 1985. Contact dermatitis to *Alstroemeria*. Contact Dermatitis, 12: 215-219.

Spoerke, D. G., Smolinske, S. C. 1990. Toxicity of houseplants. CRC Press, Inc., Boca Raton, Fla., USA. 335 pp.

Animals/Human Poisoning:

Note: When an animal is listed without additional information, the literature (as of 1993) contained no detailed explanation.

Humans

General symptoms of poisoning:

[blistering](#)

[erythema](#)

References:

Marks, J. G. 1988. Allergic contact dermatitis to *Alstroemeria*. Arch. Dermatol., 124: 914-916.

Santucci, B., Picardo, M., Iavaroni, C., Trogolo, C. 1985. Contact dermatitis to *Alstroemeria*. Contact Dermatitis, 12: 215-219.

[Another search?](#)

[Français](#) | [Contact Us](#) | [Help](#) | [Search](#) | [Canada site](#)

[Coming Events](#) | [About CBIF](#) | [Links](#) | [Reports and Publications](#) | [Home](#)

Date modified: 2003-02-06

[Important Notices](#)



Français	Contact us	Help	Search	Canada site
Coming events	About CBIF	Links	Reports and publications	Home

Canadian Biodiversity Information Facility



Notes on poisoning: petty spurge

[Introduction](#)

[Interactive](#)

[All poisonous plants by Botanical name](#)

[All poisonous plants by Common name](#)

[Important WWW Poisonous Plants sites](#)



General poisoning notes:

Petty spurge (*Euphorbia peplus*) is a naturalized herb found across Canada. This plant contains a caustic and irritant chemical in the latex, which causes burning and inflammation of skin and eyes. Ingestion results in complications. Family pets should not be allowed to ingest this plant. Experimental poisoning occurred in a calf that was fed petty spurge (Kingsbury 1964).

References:

- Fuller, T. C., McClintock, E. 1986. Poisonous plants of California. Univ. California Press, Berkeley, Calif., USA. 432 pp.
- Kingsbury, J. M. 1964. Poisonous plants of the United States and Canada. Prentice-Hall Inc., Englewood Cliffs, N.J., USA. 626 pp.

Nomenclature:

Scientific Name: *Euphorbia peplus* L.

Vernacular name(s): petty spurge

Scientific family name: *Euphorbiaceae*

Vernacular family name: spurge

Go to ITIS^{*ca} for more taxonomic information on: [Euphorbia peplus](#)

References:

Agriculture Quebec. 1975. Noms des maladies des plantes du Canada/ Names of plant diseases in Canada. , Quebec City, Que., Canada. 288 pp.

Alex, J. F., Cayouette, R., Mulligan, G. A. 1980. Common and

botanical names of weeds in Canada/Noms populaire et scientifiques des plantes nuisibles du Canada. Revised. Agric. Can. Publ., Ottawa, Ont., Canada. 132 pp.

Bailey, L. H., Bailey, E. Z. 1976. Hortus third. Revised. MacMillan, New York, N.Y., USA. 1290 pp.

Scoggan, H. J. 1978, 1979. The flora of Canada. Nat. Mus. Nat. Sci. (Ottawa) Publ. Bot. 7(1)-7(4). 1711 pp.

Van Wijk, H. L. 1911. A dictionary of plant names. Martinus Nijhoff, The Hague, The Netherlands. 1444 pp.

Victorin, M. 1964. Flore Laurentienne. 2nd ed. Univ. Montreal, Montreal, Que., Canada. 952 pp.

Geographic Information

British Columbia
Manitoba
New Brunswick
Newfoundland
Nova Scotia
Ontario
Prince Edward Island
Quebec
Saskatchewan

References:

Bailey, L. H., Bailey, E. Z. 1976. Hortus third. Revised. MacMillan, New York, N.Y., USA. 1290 pp.

Boivin, B. 1966, 1967. Énumération des plantes du Canada. Provencheria 6. Nat. Can. (Que.) 93: 253-274; 371-437; 583-646; 989-1063. 94: 131-157; 471-528; 625-655.

Image or illustration

petty spurge:

Images: images.google.com

Toxic parts:

latex

References:

Fuller, T. C., McClintock, E. 1986. Poisonous plants of California. Univ. California Press, Berkeley, Calif., USA. 432 pp.

Notes on Toxic plant chemicals:

Petty spurge contains a toxic diterpene, 5-deoxyingenol, as well as ingenol (Frohne and Pfander 1983).

Toxic plant chemicals:

5-deoxyingenol

References:

Frohne, D., Pfander, H. J. 1983. A colour atlas of poisonous plants. Wolfe Publishing Ltd., London, England. 291 pp.

Animals/Human Poisoning:

Note: When an animal is listed without additional information, the literature (as of 1993) contained no detailed explanation.

Cattle

General symptoms of poisoning:

[salivation](#)

Notes on poisoning:

Experimental feeding of petty spurge caused blood-stained feces and excessive salivation in a calf (Kingsbury 1964).

References:

Kingsbury, J. M. 1964. Poisonous plants of the United States and Canada. Prentice-Hall Inc., Englewood Cliffs, N.J., USA. 626 pp.

Humans

General symptoms of poisoning:

[eye, discharge of](#)
[mouth, irritation of](#)

Notes on poisoning:

Skin and mucous membrane irritation result from contact with the latex. Severe eye irritation also occurs (Fuller and McClintock 1986).

References:

Fuller, T. C., McClintock, E. 1986. Poisonous plants of California. Univ. California Press, Berkeley, Calif., USA. 432 pp.

[Another search?](#)

[Français](#) | [Contact Us](#) | [Help](#) | [Search](#) | [Canada site](#)

[Coming Events](#) | [About CBIF](#) | [Links](#) | [Reports and Publications](#) | [Home](#)

Date modified: 2003-02-06

[Important Notices](#)



Français	Contact us	Help	Search	Canada site
Coming events	About CBIF	Links	Reports and publications	Home

Canadian Biodiversity Information Facility



Notes on poisoning: philodendron

[Introduction](#)

[Interactive](#)

[All poisonous plants by Botanical name](#)

[All poisonous plants by Common name](#)

[Important WWW Poisonous Plants sites](#)

General poisoning notes:

Philodendron (*Philodendron cordatum*) is an indoor ornamental. Philodendrons can cause poisoning in humans and pets because of the oxalates. See additional general notes under [Philodendron scandens](#).



References:

Ayres, S. Jr, Ayres, S. 1958. Philodendron as a cause of contact dermatitis. Arch. Dermatol., 78: 330-333.

Dorsey, C. 1958. *Philodendron* dermatitis. Calif. Med., 88: 329-330.

Lampe, K. F., McCann, M. A. 1985. AMA Handbook of poisonous and injurious plants. American Medical Assoc. Chicago, Ill., USA. 432 pp.

McIntire, M. S., Guest, J. R., Porterfield, J. F. 1990. Philodendron - an infant death. Clin. Toxicol., 28: 177-183.

Nomenclature:

Scientific Name: *Philodendron cordatum* (Vell.) Kunth.

Vernacular name(s): philodendron

Scientific family name: *Araceae*

Vernacular family name: arum

Go to ITIS*^{ca} for more taxonomic information on: [Philodendron cordatum](#)

References:

Agriculture Quebec. 1975. Noms des maladies des plantes du Canada/ Names of plant diseases in Canada. , Quebec City, Que., Canada. 288 pp.

Alex, J. F., Cayouette, R., Mulligan, G. A. 1980. Common and botanical names of weeds in Canada/Noms populaire et scientifiques des plantes nuisibles du Canada. Revised. Agric. Can. Publ., Ottawa, Ont., Canada. 132 pp.

Bailey, L. H., Bailey, E. Z. 1976. Hortus third. Revised. MacMillan, New York, N.Y., USA. 1290 pp.

Scoggan, H. J. 1978, 1979. The flora of Canada. Nat. Mus. Nat. Sci. (Ottawa) Publ. Bot. 7(1)-7(4). 1711 pp.

Van Wijk, H. L. 1911. A dictionary of plant names. Martinus Nijhoff, The Hague, The Netherlands. 1444 pp.

Victorin, M. 1964. Flore Laurentienne. 2nd ed. Univ. Montreal, Montreal, Que., Canada. 952 pp.

Geographic Information

Plant or plant parts used in or around the home.

References:

Bailey, L. H., Bailey, E. Z. 1976. Hortus third. Revised. MacMillan, New York, N.Y., USA. 1290 pp.

Boivin, B. 1966, 1967. Énumération des plantes du Canada. Provencheria 6. Nat. Can. (Que.) 93: 253-274; 371-437; 583-646; 989-1063. 94: 131-157; 471-528; 625-655.

Image or illustration

philodendron:

Images: images.google.com

Toxic parts:

leaves

plant juices

References:

Ayres, S. Jr, Ayres, S. 1958. Philodendron as a cause of contact dermatitis. Arch. Dermatol., 78: 330-333.

Dorsey, C. 1958. *Philodendron* dermatitis. Calif. Med., 88: 329-330.

Toxic plant chemicals:

oxalate

References:

Lampe, K. F., McCann, M. A. 1985. AMA Handbook of poisonous and injurious plants. American Medical Assoc. Chicago, Ill., USA. 432 pp.

Animals/Human Poisoning:

Note: When an animal is listed without additional information, the literature (as of 1993) contained no detailed explanation.

Humans

General symptoms of poisoning:

[erythema](#)

[itchiness](#)

References:

Ayres, S. Jr, Ayres, S. 1958. *Philodendron* as a cause of contact dermatitis. Arch. Dermatol., 78: 330-333.

Dorsey, C. 1958. *Philodendron* dermatitis. Calif. Med., 88: 329-330.

[Another search?](#)

[Français](#) | [Contact Us](#) | [Help](#) | [Search](#) | [Canada site](#)

[Coming Events](#) | [About CBIF](#) | [Links](#) | [Reports and Publications](#) |

[Home](#)

Date modified: 2003-02-06

[Important Notices](#)



Français	Contact us	Help	Search	Canada site
Coming events	About CBIF	Links	Reports and publications	Home

Canadian Biodiversity Information Facility



Notes on poisoning: pin cherry

[Introduction](#)[Interactive](#)[All poisonous plants by Botanical name](#)[All poisonous plants by Common name](#)[Important WWW Poisonous Plants sites](#)

General poisoning notes:

Pin cherry (*Prunus pensylvanica*) is a native tree found throughout most of Canada. The leaves have an average N rate of 91 mg/100 g, with as much as 143 mg/100 g recorded. These levels are potentially lethal to livestock if ingested. M. Pitcher (personal communication) notes that captive moose in Newfoundland and Alberta nature parks and zoos regurgitate a gray, chalky, paste-like substance when fed pin cherry browse mixed with their normal browse, white birch (*Betula papyrifera*). Livestock that ingest pin cherry plant material can be poisoned (Kingsbury 1964).

References:

Kingsbury, J. M. 1964. Poisonous plants of the United States and Canada. Prentice-Hall Inc., Englewood Cliffs, N.J., USA. 626 pp.

Nomenclature:

Scientific Name: *Prunus pensylvanica* L. f.

Vernacular name(s): pin cherry

Scientific family name: *Rosaceae*

Vernacular family name: rose

Go to ITIS*^{ca} for more taxonomic information on: [Prunus pensylvanica](#)

References:

Agriculture Quebec. 1975. Noms des maladies des plantes du Canada/ Names of plant diseases in Canada. , Quebec City, Que., Canada. 288 pp.

Alex, J. F., Cayouette, R., Mulligan, G. A. 1980. Common and

botanical names of weeds in Canada/Noms populaire et scientifiques des plantes nuisibles du Canada. Revised. Agric. Can. Publ., Ottawa, Ont., Canada. 132 pp.

Bailey, L. H., Bailey, E. Z. 1976. Hortus third. Revised. MacMillan, New York, N.Y., USA. 1290 pp.

Scoggan, H. J. 1978, 1979. The flora of Canada. Nat. Mus. Nat. Sci. (Ottawa) Publ. Bot. 7(1)-7(4). 1711 pp.

Van Wijk, H. L. 1911. A dictionary of plant names. Martinus Nijhoff, The Hague, The Netherlands. 1444 pp.

Victorin, M. 1964. Flore Laurentienne. 2nd ed. Univ. Montreal, Montreal, Que., Canada. 952 pp.

Geographic Information

Alberta
British Columbia
Labrador
Manitoba
New Brunswick
Northwest Territories
Nova Scotia
Ontario
Prince Edward Island
Quebec
Saskatchewan

References:

Bailey, L. H., Bailey, E. Z. 1976. Hortus third. Revised. MacMillan, New York, N.Y., USA. 1290 pp.

Boivin, B. 1966, 1967. Énumération des plantes du Canada. Provencheria 6. Nat. Can. (Que.) 93: 253-274; 371-437; 583-646; 989-1063. 94: 131-157; 471-528; 625-655.

Image or illustration

pin cherry:

Images: images.google.com

Toxic parts:

leaves

References:

Kingsbury, J. M. 1964. Poisonous plants of the United States and Canada. Prentice-Hall Inc., Englewood Cliffs, N.J., USA. 626 pp.

Toxic plant chemicals:

amygdalin

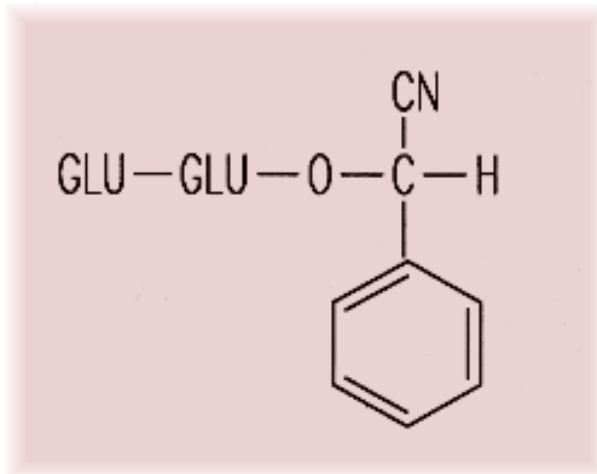

prunasin

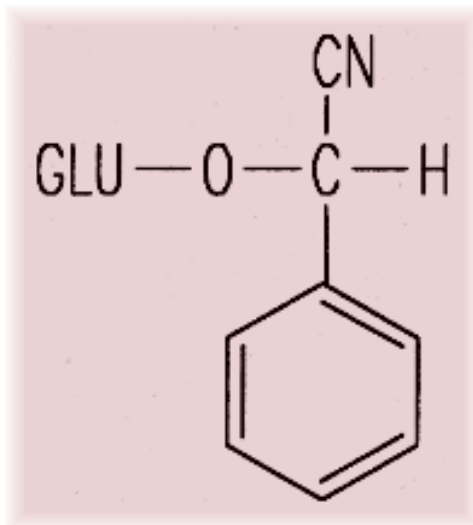

Chemical diagram(s) are courtesy of [Ruth McDiarmid](#), Biochemistry Technician, Kamloops Range Station, Agriculture and Agri-Food Canada, Kamloops, British Columbia, Canada.

References:

Cheeke, P. R., Shull, L. R. 1985. Natural toxicants in feeds and poisonous plants. AVI Publishing Company, Inc., Westport, Conn., USA. 492 pp.

Animals/Human Poisoning:

Note: When an animal is listed without additional information, the literature (as of 1993) contained no detailed explanation.

Moose

General symptoms of poisoning:

[vomiting](#)

Notes on poisoning:

M. Pitcher (personal communication) states that captive moose develop an adverse reaction to pin cherry when the plant is inadvertently mixed with their usual browse, white birch (*Betula papyrifera*). The moose regurgitate a gray, chalky paste-like substance. This has been noted both in Newfoundland and Alberta.

References:

Kingsbury, J. M. 1964. Poisonous plants of the United States and Canada. Prentice-Hall Inc., Englewood Cliffs, N.J., USA. 626 pp.

[Another search?](#)

[Français](#) | [Contact Us](#) | [Help](#) | [Search](#) | [Canada site](#)

[Coming Events](#) | [About CBIF](#) | [Links](#) | [Reports and Publications](#) |

[Home](#)

Date modified: 2003-02-06

[Important Notices](#)



Français	Contact us	Help	Search	Canada site
Coming events	About CBIF	Links	Reports and publications	Home

Canadian Biodiversity Information Facility



Notes on poisoning: pink lady's-slipper

[Introduction](#)

[Interactive](#)

[All poisonous plants by Botanical name](#)

[All poisonous plants by Common name](#)

[Important WWW Poisonous Plants sites](#)

General poisoning notes:

Pink lady's-slipper (*Cypripedium acaule*) is a native perennial orchid that grows across most of Canada. The plant can cause severe dermatitis in some individuals, as do the other *Cypripedium* spp., upon contact with the glandular hairs on the leaves and stem (Reddoch and Reddoch 1984).



References:

MaCaulay, J. C. 1987. Orchid allergy. Contact Dermatitis, 17: 112-113.

Mitchell, J. C., Rook, A. 1979. Botanical dermatology. Greenglass Ltd, Vancouver, B.C., Canada. 787 pp.

Reddoch, A. H., Reddoch, J. M. 1984. Warning: Lady's-slippers can be hazardous to your health. Plant Press, 2(1): 10.

Nomenclature:

Scientific Name: *Cypripedium acaule* Ait.

Vernacular name(s): pink lady's-slipper

Scientific family name: *Orchidaceae*

Vernacular family name: orchid

Go to ITIS^{*ca} for more taxonomic information on: [Cypripedium acaule](#)

References:

Agriculture Quebec. 1975. Noms des maladies des plantes du Canada/ Names of plant diseases in Canada. , Quebec City, Que., Canada. 288 pp.

Alex, J. F., Cayouette, R., Mulligan, G. A. 1980. Common and botanical names of weeds in Canada/Noms populaire et scientifiques des plantes nuisibles du Canada. Revised. Agric. Can. Publ., Ottawa, Ont., Canada. 132 pp.

Bailey, L. H., Bailey, E. Z. 1976. Hortus third. Revised. MacMillan, New York, N.Y., USA. 1290 pp.

Scoggan, H. J. 1978, 1979. The flora of Canada. Nat. Mus. Nat. Sci. (Ottawa) Publ. Bot. 7(1)-7(4). 1711 pp.

Van Wijk, H. L. 1911. A dictionary of plant names. Martinus Nijhoff, The Hague, The Netherlands. 1444 pp.

Victorin, M. 1964. Flore Laurentienne. 2nd ed. Univ. Montreal, Montreal, Que., Canada. 952 pp.

Geographic Information

Alberta
Manitoba
New Brunswick
Newfoundland
Nova Scotia
Ontario
Prince Edward Island
Quebec
Saskatchewan

References:

Bailey, L. H., Bailey, E. Z. 1976. Hortus third. Revised. MacMillan, New York, N.Y., USA. 1290 pp.

Boivin, B. 1966, 1967. Énumération des plantes du Canada. Provencheria 6. Nat. Can. (Que.) 93: 253-274; 371-437; 583-646; 989-1063. 94: 131-157; 471-528; 625-655.

Image or illustration

pink lady's-slipper:

Images: images.google.com

Notes on Poisonous plant parts:

The glandular hairs on the leaves and stems of the lady's-slippers contain the dermatogenic chemical that causes dermatitis in some individuals (Mitchell and Rook 1979).

Toxic parts:

leaves
stems

References:

Mitchell, J. C., Rook, A. 1979. Botanical dermatology. Greenglass Ltd, Vancouver, B.C., Canada. 787 pp.

Reddoch, A. H., Reddoch, J. M. 1984. Warning: Lady's-slippers can be hazardous to your health. Plant Press, 2(1): 10.

Notes on Toxic plant chemicals:

The dermatogenic quinone, cypripedin, has been identified in lady's-slippers (Reddoch and Reddoch 1984).

Toxic plant chemicals:

cypripedin

References:

Reddoch, A. H., Reddoch, J. M. 1984. Warning: Lady's-slippers can be hazardous to your health. Plant Press, 2(1): 10.

Animals/Human Poisoning:

Note: When an animal is listed without additional information, the literature (as of 1993) contained no detailed explanation.

Humans

General symptoms of poisoning:

[blisters, weeping](#)

References:

Reddoch, A. H., Reddoch, J. M. 1984. Warning: Lady's-slippers can be hazardous to your health. Plant Press, 2(1): 10.

[Another search?](#)

[Français](#) | [Contact Us](#) | [Help](#) | [Search](#) | [Canada site](#)

[Coming Events](#) | [About CBIF](#) | [Links](#) | [Reports and Publications](#) | [Home](#)

Date modified: 2003-02-06

[Important Notices](#)



Français	Contact us	Help	Search	Canada site
Coming events	About CBIF	Links	Reports and publications	Home

Canadian Biodiversity Information Facility



Notes on poisoning: poinsettia

[Introduction](#)

[Interactive](#)

[All poisonous plants by Botanical name](#)

[All poisonous plants by Common name](#)

[Important WWW Poisonous Plants sites](#)



General poisoning notes:

Poinsettia (*Euphorbia pulcherrima*) is a popular Christmas plant grown for its red leafy bracts. It has been listed as a known toxic plant that has caused a loss of human life. The case cited in all literature is based on the death of a child in Hawaii who ingested a leaf of poinsettia. The author of that report said that the incident was based on hearsay (Stone and Collins 1971). Various studies have not found any of the toxic diterpenes that occur in the latex of other spurges (*Euphorbia* spp.). Extensive studies on rats that were fed "extraordinarily" high doses of poinsettia showed no mortality, no symptoms of toxicity, and no changes in normal behaviour (Stone and Collins 1971). Klug et al. (1990) reviewed 353 calls to poison control centres and found that nausea and vomiting were cited in 0.02% of the cases with rash and sneezing cited in 0.0028%. An older dog that ingested poinsettia reportedly experienced protracted vomiting, followed by renal failure, coma, and death. This is the only case in the literature of death to an animal. Case histories show that some humans develop a sensitivity to the latex, resulting in dermatitis. Short exposures to poinsettia in a few cases have led to bouts of vomiting, but no substantiated cases of death can be found in the literature. Poinsettia should no longer be regarded as a severely toxic plant.

References:

- Klug, S., Saleem, G., Hocharuk, L., Marcus, S. 1990. Toxicity potential of poinsettia, is the plant really toxic? *Vet. Hum. Toxicol.*, 32: 368.
- Santucci, B., Picardo, M., Cristaudo, A. 1985. Contact dermatitis from *Euphorbia pulcherrima*. *Contact Dermatitis*, 12: 285-286.
- Spoerke, D. G., Smolinske, S. C. 1990. Toxicity of houseplants. CRC Press, Inc., Boca Raton, Fla., USA. 335 pp.
- Stone, R. P., Collins, W. J. 1971. *Euphorbia pulcherrima*:

toxicity to rats. *Toxicon*, 9: 301-302.

Nomenclature:

Scientific Name: *Euphorbia pulcherrima* Willd. ex Klotzsch

Vernacular name(s): poinsettia

Scientific family name: *Euphorbiaceae*

Vernacular family name: spurge

Go to ITIS^{*ca} for more taxonomic information on: [Euphorbia pulcherrima](#)

References:

Agriculture Quebec. 1975. Noms des maladies des plantes du Canada/ Names of plant diseases in Canada. , Quebec City, Que., Canada. 288 pp.

Alex, J. F., Cayouette, R., Mulligan, G. A. 1980. Common and botanical names of weeds in Canada/Noms populaire et scientifiques des plantes nuisibles du Canada. Revised. Agric. Can. Publ., Ottawa, Ont., Canada. 132 pp.

Bailey, L. H., Bailey, E. Z. 1976. Hortus third. Revised. MacMillan, New York, N.Y., USA. 1290 pp.

Scoggan, H. J. 1978, 1979. The flora of Canada. Nat. Mus. Nat. Sci. (Ottawa) Publ. Bot. 7(1)-7(4). 1711 pp.

Van Wijk, H. L. 1911. A dictionary of plant names. Martinus Nijhoff, The Hague, The Netherlands. 1444 pp.

Victorin, M. 1964. Flore Laurentienne. 2nd ed. Univ. Montreal, Montreal, Que., Canada. 952 pp.

Geographic Information

Plant or plant parts used in or around the home.

References:

Bailey, L. H., Bailey, E. Z. 1976. Hortus third. Revised. MacMillan, New York, N.Y., USA. 1290 pp.

Boivin, B. 1966, 1967. Énumération des plantes du Canada. Provencheria 6. Nat. Can. (Que.) 93: 253-274; 371-437; 583-646; 989-1063. 94: 131-157; 471-528; 625-655.

Image or illustration

poinsettia:

Images: images.google.com

Notes on Poisonous plant parts:

A few people have a positive reaction to the latex and to aqueous extracts of plant material (Santucci et al. 1985).

Toxic parts:

latex
leaves
stems

References:

Santucci, B., Picardo, M., Cristaudo, A. 1985. Contact dermatitis from *Euphorbia pulcherrima*. Contact Dermatitis, 12: 285-286.

Notes on Toxic plant chemicals:

The latex does not contain any diterpenes. The plant contains an unidentified chemical, which causes dermatitis in a few sensitive individuals (Santucci et al. 1985).

Toxic plant chemicals:

unknown chemical

References:

Santucci, B., Picardo, M., Cristaudo, A. 1985. Contact dermatitis from *Euphorbia pulcherrima*. Contact Dermatitis, 12: 285-286.

Animals/Human Poisoning:

Note: When an animal is listed without additional information, the literature (as of 1993) contained no detailed explanation.

Dogs

General symptoms of poisoning:

[coma](#)

[death](#)

[kidney failure](#)

[vomiting](#)

References:

Klug, S., Saleem, G., Hocharuk, L., Marcus, S. 1990. Toxicity potential of poinsettia, is the plant really toxic? Vet. Hum. Toxicol., 32: 368.

Humans

General symptoms of poisoning:

[eczema](#)

[nausea](#)

[vomiting](#)

Notes on poisoning:

The most severe symptoms of poinsettia ingestion substantiated in the literature are a few cases of nausea and vomiting, with an occasional rash (Klug et al. 1990).

References:

Klug, S., Saleem, G., Hocharuk, L., Marcus, S. 1990. Toxicity potential of poinsettia, is the plant really toxic? Vet. Hum. Toxicol., 32: 368.

Santucci, B., Picardo, M., Cristaudo, A. 1985. Contact dermatitis from *Euphorbia pulcherrima*. Contact Dermatitis, 12: 285-286.

Rodents

[Another search?](#)

[Français](#) | [Contact Us](#) | [Help](#) | [Search](#) | [Canada site](#)

[Coming Events](#) | [About CBIF](#) | [Links](#) | [Reports and Publications](#) | [Home](#)

Date modified: 2003-02-06

[Important Notices](#)



Français	Contact us	Help	Search	Canada site
Coming events	About CBIF	Links	Reports and publications	Home

Canadian Biodiversity Information Facility



Notes on poisoning: poison ivy

[Introduction](#)

[Interactive](#)

[All poisonous plants by Botanical name](#)

[All poisonous plants by Common name](#)

[Important WWW Poisonous Plants sites](#)



General poisoning notes:

Poison ivy (*Rhus radicans*; synonym *Toxicodendron radicans*) is a native shrub or vine found throughout southern Canada. Three recognized varieties are found in various parts of the country (Mulligan and Junkins 1977). Urushiol is the allergenic agent found in most parts of the plant. Damage to plant tissues causes the nonvolatile chemicals to be exposed. Humans are often sensitized, with symptoms ranging from mild itchiness and redness to severe oozing lesions with fever. Poison ivy is probably responsible for more cases of plant dermatitis in Canada than any other plant. Urushiol can contaminate clothes, tools, and the fur of domestic animals. Humans can subsequently develop dermatitis from contact. Humans do not contract the dermatitis on first contact, but most people are sensitized the first time (Mulligan 1990, Schwartz and Downham 1981, Gayer and Burnett 1988). For more information please see the bulletin "[Poison Ivy, Western Poison Oak, Poison Sumac](#)"

References:

Downham, T. F. 1986. Science has got its hands on poison-ivy, poison-oak, and poison-sumac. U.S. Dep. Agric. For. Serv. Man. N., 47: 23-28.

Epstein, W. L., Byers, V. S. 1981. Poison oak and poison ivy dermatitis. Prevention and treatment in forest service work. U.S. Dep. Agric. For. Serv. Rep., 14 pp.

Gaillard, G. E. 1956. The modern treatment of poison ivy. N. Y. State J. Med., 56:2255-2259.

Gayer, K. D., Burnett, J. W. 1988. *Toxicodendron* dermatitis. Cutis, 42: 99-100.

Goldsmith, M. F. 1984. Sensitivity test may aid in avoiding 'poison' plant-induced dermatitis. J. Am. Med. Assoc., 251:

1389-1390.

Guin, J. D. 1980. Reaction time in experimental poison ivy dermatitis. *Contact Dermatitis*, 6:289-290.

Mulligan, G. A., Junkins, B. E. 1977. The biology of Canadian weeds 23. *Rhus radicans* L. *Can. J. Plant Sci.*, 57: 515-523.

Mulligan, G. A. 1990. [Poison ivy. Western poison oak. Poison sumac](#). *Agric. Can. Publ.*, 1699. 13 pp.

Schwartz, R. S. 1981. Erythema multiforme associated with *Rhus* contact dermatitis. *Cutis*, 27: 85-86.

Nomenclature:

Scientific Name: *Rhus radicans* L.

Vernacular name(s): poison ivy

Scientific family name: *Anacardiaceae*

Vernacular family name: cashew

Go to ITIS^{*ca} for more taxonomic information on: [Rhus radicans](#)

References:

Agriculture Quebec. 1975. Noms des maladies des plantes du Canada/ Names of plant diseases in Canada. , Quebec City, Que., Canada. 288 pp.

Alex, J. F., Cayouette, R., Mulligan, G. A. 1980. Common and botanical names of weeds in Canada/Noms populaire et scientifiques des plantes nuisibles du Canada. Revised. *Agric. Can. Publ.*, Ottawa, Ont., Canada. 132 pp.

Bailey, L. H., Bailey, E. Z. 1976. *Hortus* third. Revised. MacMillan, New York, N.Y., USA. 1290 pp.

Scoggan, H. J. 1978, 1979. The flora of Canada. *Nat. Mus. Nat. Sci. (Ottawa) Publ. Bot.* 7(1)-7(4). 1711 pp.

Van Wijk, H. L. 1911. A dictionary of plant names. Martinus Nijhoff, The Hague, The Netherlands. 1444 pp.

Victorin, M. 1964. *Flore Laurentienne*. 2nd ed. Univ. Montreal, Montreal, Que., Canada. 952 pp.

Geographic Information

Alberta
British Columbia
Manitoba

New Brunswick
Nova Scotia
Ontario
Prince Edward Island
Quebec
Saskatchewan

References:

Bailey, L. H., Bailey, E. Z. 1976. Hortus third. Revised. MacMillan, New York, N.Y., USA. 1290 pp.

Boivin, B. 1966, 1967. Énumération des plantes du Canada. Provencheria 6. Nat. Can. (Que.) 93: 253-274; 371-437; 583-646; 989-1063. 94: 131-157; 471-528; 625-655.

Image or illustration

poison ivy:

Images: images.google.com

Toxic parts:

all parts
leaves
plant juices

References:

Gayer, K. D., Burnett, J. W. 1988. *Toxicodendron* dermatitis. Cutis, 42: 99-100.

Goldsmith, M. F. 1984. Sensitivity test may aid in avoiding 'poison' plant-induced dermatitis. J. Am. Med. Assoc., 251: 1389-1390.

Mulligan, G. A., Junkins, B. E. 1977. The biology of Canadian weeds 23. *Rhus radicans* L. Can. J. Plant Sci., 57: 515-523.

Mulligan, G. A. 1990. [Poison ivy. Western poison oak. Poison sumac](#). Agric. Can. Publ., 1699. 13 pp.

Schwartz, R. S. 1981. Erythema multiforme associated with *Rhus* contact dermatitis. Cutis, 27: 85-86.

Notes on Toxic plant chemicals:

Urushiol, a group of alkylcatechols, is found in the sap of poison-ivy plants. The allergic reaction has been traditionally thought to involve initial oxidation by which a protein-reactive

quinone is formed. Recent work indicates that redox cycling in the skin, following penetration of the allergenic alkybenzenes, initially depletes local levels of endogenous-reducing equivalents such as NADH and glutathione. Further cycling results in the uncontrolled generation of radical species that exhibit protein reactivity. The urushiol is not volatile and can contaminate clothing, tools, and domestic animals. Under dry conditions, the chemical can remain harmful for long periods (Mulligan 1990, Schmidt et al. 1990).

Toxic plant chemicals:

urushiol oil
3-pentadecyl catechol

References:

Downham, T. F. 1986. Science has got its hands on poison-ivy, poison-oak, and poison-sumac. U.S. Dep. Agric. For. Serv. Man. N., 47: 23-28.

Gaillard, G. E. 1956. The modern treatment of poison ivy. N. Y. State J. Med., 56:2255-2259.

Gayer, K. D., Burnett, J. W. 1988. *Toxicodendron* dermatitis. *Cutis*, 42: 99-100.

Goldsmith, M. F. 1984. Sensitivity test may aid in avoiding 'poison' plant-induced dermatitis. *J. Am. Med. Assoc.*, 251: 1389-1390.

Mulligan, G. A., Junkins, B. E. 1977. The biology of Canadian weeds 23. *Rhus radicans* L. *Can. J. Plant Sci.*, 57: 515-523.

Mulligan, G. A. 1990. [Poison ivy. Western poison oak. Poison sumac.](#) Agric. Can. Publ., 1699. 13 pp.

Schmidt, R. J., Khan, L., Chung, L. Y. 1990. Are free radicals and not quinones the haptenic species derived from urushiols and other contact allergenic mono- and dihydride alkylbenzenes? *Dermatol. Res.*, 282: 56-64.

Animals/Human Poisoning:

Note: When an animal is listed without additional information, the literature (as of 1993) contained no detailed explanation.

Humans

General symptoms of poisoning:

[blistering](#)

[blisters, weeping](#)

[erythema](#)

[face, edema of](#)

[itchiness](#)

[pneumonitis](#)

[temperature, elevated](#)

[tracheitis](#)

References:

Downham, T. F. 1986. Science has got its hands on poison-ivy, poison-oak, and poison-sumac. U.S. Dep. Agric. For. Serv. Man. N., 47: 23-28.

Epstein, W. L., Byers, V. S. 1981. Poison oak and poison ivy dermatitis. Prevention and treatment in forest service work. U.S. Dep. Agric. For. Serv. Rep., 14 pp.

Gayer, K. D., Burnett, J. W. 1988. *Toxicodendron* dermatitis. *Cutis*, 42: 99-100.

Goldsmith, M. F. 1984. Sensitivity test may aid in avoiding 'poison' plant-induced dermatitis. *J. Am. Med. Assoc.*, 251: 1389-1390.

Guin, J. D. 1980. Reaction time in experimental poison ivy dermatitis. *Contact Dermatitis*, 6:289-290.

Mulligan, G. A., Junkins, B. E. 1977. The biology of Canadian weeds 23. *Rhus radicans* L. *Can. J. Plant Sci.*, 57: 515-523.

Mulligan, G. A. 1990. [Poison ivy. Western poison oak. Poison sumac.](#) Agric. Can. Publ., 1699. 13 pp.

Schwartz, R. S. 1981. Erythema multiforme associated with *Rhus* contact dermatitis. *Cutis*, 27: 85-86.

[Another search?](#)

[Français](#) | [Contact Us](#) | [Help](#) | [Search](#) | [Canada site](#)

[Coming Events](#) | [About CBIF](#) | [Links](#) | [Reports and Publications](#) |

[Home](#)

Date modified: 2003-02-06

[Important Notices](#)



Français	Contact us	Help	Search	Canada site
Coming events	About CBIF	Links	Reports and publications	Home

Canadian Biodiversity Information Facility



Notes on poisoning: poison suckleya

[Introduction](#)

[Interactive](#)

[All poisonous plants by Botanical name](#)

[All poisonous plants by Common name](#)

[Important WWW Poisonous Plants sites](#)



General poisoning notes:

Poison suckleya (*Suckleya suckleyana*) is a native herb found in the southern Saskatchewan and southern Alberta. This plant has caused losses of cattle and possibly sheep in the western United States. The plant is not normally ingested, but in times of scarce forage, it may be eaten in sufficient amounts to cause death. It contains an unknown cyanogenic glycoside that upon ingestion of sufficient quantity can release cyanide in the animal system, resulting in cytotoxic hypoxia. Experiments with cattle, sheep, laboratory rabbits, and guinea pigs have shown the cyanogenic potential of poison suckleya. This plant is not usually ingested by animals and is not common in the southern prairies. However, poisoning can occur (Thorp and Deem 1938, Berry and Gonzales 1986).

References:

Thorp, F., Deem, A. W. 1938. *Suckleya suckleyana*, a poisonous plant. J. Am. Vet. Med. Assoc., 47: 192-197.

Nomenclature:

Scientific Name: *Suckleya suckleyana* (Torr.) Rydb.

Vernacular name(s): poison suckleya

Scientific family name: *Chenopodiaceae*

Vernacular family name: goosefoot

Go to ITIS^{*ca} for more taxonomic information on: [Suckleya suckleyana](#)

References:

Agriculture Quebec. 1975. Noms des maladies des plantes du Canada/ Names of plant diseases in Canada. , Quebec City, Que., Canada. 288 pp.

Alex, J. F., Cayouette, R., Mulligan, G. A. 1980. Common and botanical names of weeds in Canada/Noms populaire et scientifiques des plantes nuisibles du Canada. Revised. Agric. Can. Publ., Ottawa, Ont., Canada. 132 pp.

Bailey, L. H., Bailey, E. Z. 1976. Hortus third. Revised. MacMillan, New York, N.Y., USA. 1290 pp.

Scoggan, H. J. 1978, 1979. The flora of Canada. Nat. Mus. Nat. Sci. (Ottawa) Publ. Bot. 7(1)-7(4). 1711 pp.

Van Wijk, H. L. 1911. A dictionary of plant names. Martinus Nijhoff, The Hague, The Netherlands. 1444 pp.

Victorin, M. 1964. Flore Laurentienne. 2nd ed. Univ. Montreal, Montreal, Que., Canada. 952 pp.

Geographic Information

Alberta

British Columbia

References:

Bailey, L. H., Bailey, E. Z. 1976. Hortus third. Revised. MacMillan, New York, N.Y., USA. 1290 pp.

Boivin, B. 1966, 1967. Énumération des plantes du Canada. Provencheria 6. Nat. Can. (Que.) 93: 253-274; 371-437; 583-646; 989-1063. 94: 131-157; 471-528; 625-655.

Image or illustration

poison suckleya:

Images: images.google.com

Toxic parts:

leaves

stems

References:

Berry, T. J., Gonzales, P. 1986. Do your cattle-owning clients know about this poisonous range plant? Vet. Med., 81:

1055-1056.

Notes on Toxic plant chemicals:

An unknown cyanogenic glycoside is found in poison suckleya. Upon ingestion, cyanide is released in the animal's system. The cyanide potential of this plant was measured at 0.01-0.24%. After fasting, sheep showed transitory symptoms, with forced feedings of large amounts of the plant containing 0.011% cyanide potential. Plant material measured at 0.0364% cyanide potential is lethal to cattle, guinea pigs, and sheep (Thorp and Deem 1938).

Toxic plant chemicals:

unknown chemical

References:

Berry, T. J., Gonzales, P. 1986. Do your cattle-owning clients know about this poisonous range plant? *Vet. Med.*, 81: 1055-1056.

Thorp, F., Deem, A. W. 1938. *Suckleya suckleyana*, a poisonous plant. *J. Am. Vet. Med. Assoc.*, 47: 192-197.

Animals/Human Poisoning:

Note: When an animal is listed without additional information, the literature (as of 1993) contained no detailed explanation.

Cattle

General symptoms of poisoning:

[breathing, labored](#)

[cyanosis](#)

[death by asphyxiation](#)

[gait, staggering](#)

[muscle twitching](#)

Notes on poisoning:

Ingesting abundant plant material causes cyanide to be released into cattle. Symptoms include glassy eyes, muscular twitching, dribbling urine, staggering, cyanosis, fast and weak heart, labored breathing, spasms, and death by asphyxiation. Postmortem findings showed black-colored blood, congestion of the mucous membrane on the folds of the abomasum and initial part of the duodenum, and a distended bladder. Treatment includes

intravenous sodium nitrate and sodium thiosulfate, with a laxative to remove plant material from the rumen (Thorpe and Deem 1938, Berry and Gonzales 1986).

References:

Thorp, F., Deem, A. W. 1938. *Suckleya suckleyana*, a poisonous plant. J. Am. Vet. Med. Assoc., 47: 192-197.

Sheep

General symptoms of poisoning:

[collapse](#)

[death by asphyxiation](#)

[dyspnea](#)

[heart rate, slow](#)

[salivation](#)

Notes on poisoning:

On the rangelands of the western United States, sheep were believed to have died as a result of ingesting poison suckleya. Sheep were experimentally poisoned after they were force-fed plant material. Sickness and death resulted. Symptoms were similar to those of cattle that died from cytotoxic hypoxia (Thorpe and Deem 1938).

References:

Thorp, F., Deem, A. W. 1938. *Suckleya suckleyana*, a poisonous plant. J. Am. Vet. Med. Assoc., 47: 192-197.

[Another search?](#)

[Français](#) | [Contact Us](#) | [Help](#) | [Search](#) | [Canada site](#)

[Coming Events](#) | [About CBIF](#) | [Links](#) | [Reports and Publications](#) |

[Home](#)

Date modified: 2003-02-06

[Important Notices](#)



Français	Contact us	Help	Search	Canada site
Coming events	About CBIF	Links	Reports and publications	Home

Canadian Biodiversity Information Facility



Notes on poisoning: poison sumac

[Introduction](#)[Interactive](#)[All poisonous plants by Botanical name](#)[All poisonous plants by Common name](#)[Important WWW Poisonous Plants sites](#)

General poisoning notes:

Poison sumac (*Rhus vernix*; synonymy *Toxicodendron vernix*) is a native shrub or vine found in southern Quebec and southern Ontario. The sap of this plant contains the allergen urushiol. The chemical is released when plant tissue is damaged. Humans are highly sensitive to allergic reaction, although at least one exposure is needed for sensitization. Mild to severe dermatitis can result from exposure to poison sumac (Mulligan 1990, Gayer and Burnett 1988). For more information please see the bulletin "[Poison Ivy, Western Poison Oak, Poison Sumac](#)"

References:

- Epstein, W. L., Byers, V. S. 1981. Poison oak and poison ivy dermatitis. Prevention and treatment in forest service work. U.S. Dep. Agric. For. Serv. Rep., 14 pp.
- Gayer, K. D., Burnett, J. W. 1988. *Toxicodendron* dermatitis. *Cutis*, 42: 99-100.
- Mulligan, G. A. 1990. [Poison ivy. Western poison oak. Poison sumac](#). Agric. Can. Publ., 1699. 13 pp.

Nomenclature:

Scientific Name: *Rhus vernix* L.

Vernacular name(s): poison sumac

Scientific family name: *Anacardiaceae*

Vernacular family name: cashew

Go to ITIS*^{ca} for more taxonomic information on: [Rhus vernix](#)

References:

Agriculture Quebec. 1975. Noms des maladies des plantes du Canada/ Names of plant diseases in Canada. , Quebec City, Que., Canada. 288 pp.

Alex, J. F., Cayouette, R., Mulligan, G. A. 1980. Common and botanical names of weeds in Canada/Noms populaire et scientifiques des plantes nuisibles du Canada. Revised. Agric. Can. Publ., Ottawa, Ont., Canada. 132 pp.

Bailey, L. H., Bailey, E. Z. 1976. Hortus third. Revised. MacMillan, New York, N.Y., USA. 1290 pp.

Scoggan, H. J. 1978, 1979. The flora of Canada. Nat. Mus. Nat. Sci. (Ottawa) Publ. Bot. 7(1)-7(4). 1711 pp.

Van Wijk, H. L. 1911. A dictionary of plant names. Martinus Nijhoff, The Hague, The Netherlands. 1444 pp.

Victorin, M. 1964. Flore Laurentienne. 2nd ed. Univ. Montreal, Montreal, Que., Canada. 952 pp.

Geographic Information

Ontario

Quebec

References:

Bailey, L. H., Bailey, E. Z. 1976. Hortus third. Revised. MacMillan, New York, N.Y., USA. 1290 pp.

Boivin, B. 1966, 1967. Énumération des plantes du Canada. Provencheria 6. Nat. Can. (Que.) 93: 253-274; 371-437; 583-646; 989-1063. 94: 131-157; 471-528; 625-655.

Image or illustration

poison sumac:

Images: images.google.com

Notes on Poisonous plant parts:

Most parts of poison sumac contain the allergen except the pollen, anthers, xylem, and epidermis. Damage to plant parts releases the sap that contains the allergen (Mulligan 1990). The allergen occurs in the plant sap, which is found in all plant parts except the pollen, anthers, xylem, and epidermis. If the stems are damaged they can release the allergen, even in the winter. The

roots are also dangerous (Mulligan 1990).

Toxic parts:

all parts
leaves
mature fruit
plant juices
roots
stems

References:

Epstein, W. L., Byers, V. S. 1981. Poison oak and poison ivy dermatitis. Prevention and treatment in forest service work. U.S. Dep. Agric. For. Serv. Rep., 14 pp.

Mulligan, G. A. 1990. [Poison ivy. Western poison oak. Poison sumac.](#) Agric. Can. Publ., 1699. 13 pp.

Notes on Toxic plant chemicals:

Urushiol, an group of alkylcatechols, is found in the sap of poison sumac. The allergen is nonvolatile and can contaminate clothing, tools, and domestic animals. The allergen can be hazardous for a long time if the contaminated object remains dry (Gayer and Burnett 1988). See poison-ivy ([Rhus radicans](#)) for additional information.

Toxic plant chemicals:

urushiol oil

References:

Epstein, W. L., Byers, V. S. 1981. Poison oak and poison ivy dermatitis. Prevention and treatment in forest service work. U.S. Dep. Agric. For. Serv. Rep., 14 pp.

Gayer, K. D., Burnett, J. W. 1988. *Toxicodendron* dermatitis. *Cutis*, 42: 99-100.

Animals/Human Poisoning:

Note: When an animal is listed without additional information, the literature (as of 1993) contained no detailed explanation.

Humans

General symptoms of poisoning:

[blistering](#)

[blisters, weeping](#)

[itchiness](#)

[temperature, elevated](#)

References:

Epstein, W. L., Byers, V. S. 1981. Poison oak and poison ivy dermatitis. Prevention and treatment in forest service work. U.S. Dep. Agric. For. Serv. Rep., 14 pp.

Mulligan, G. A. 1990. [Poison ivy. Western poison oak. Poison sumac](#). Agric. Can. Publ., 1699. 13 pp.

[Another search?](#)

[Français](#) | [Contact Us](#) | [Help](#) | [Search](#) | [Canada site](#)

[Coming Events](#) | [About CBIF](#) | [Links](#) | [Reports and Publications](#) | [Home](#)

Date modified: 2003-02-06

[Important Notices](#)



Français	Contact us	Help	Search	Canada site
Coming events	About CBIF	Links	Reports and publications	Home

Canadian Biodiversity Information Facility



Notes on poisoning: poison-hemlock

[Introduction](#)[Interactive](#)[All poisonous plants by Botanical name](#)[All poisonous plants by Common name](#)[Important WWW Poisonous Plants sites](#)

General poisoning notes:

Poison-hemlock (*Conium maculatum*) is a naturalized herb found in parts of southern Canada. The plant grows on dry to moist soils. Cattle, goats, horses, swine, and sheep as well as rabbits, poultry, deer, and humans have been poisoned after ingesting poison-hemlock. Animal species vary in their susceptibility to acute toxicity (Keeler et al. 1980):

cows	3.3 mg/kg body weight	1.5-2 h
ewes	44 mg/kg body weight	1.5-2 h
mares	15.5 mg/kg body weight	30-40 min

Poison-hemlock causes toxicity and death in animals after it is ingested. It also causes teratogenic effects called crooked calf disease in young pigs and cattle, caused by the chemical coniine (Keeler 1974, Panter et al. 1985).

References:

Anon. 1951. Unusual case of hemlock poisoning in swine. Calif. Vet., 5(2): 26.

Cooper, M. R., Johnson, A. W. 1984. Poisonous plants in Britain and their effects on animals and man. Her Majesty's Stationery Office, London, England. 305 pp.

Edmonds, L. D., Selby, L. A., Case, A. A. 1972. Poisoning and congenital malformations associated with consumption of poison hemlock by sows. J. Am. Vet. Med. Assoc., 160: 1319-1324.

Frank, A. A., Reed, W. M. 1987. *Conium maculatum* (poison hemlock) toxicosis in a flock of range turkeys. Avian Dis., 31: 386-388.

Hannam, D. A. 1985. Hemlock (*Conium maculatum*) poisoning in the pig. Vet. Rec., 116: 322.

- Keeler, R. F., Balls, L. D., Shupe, J. L., Crowe, M. W. 1980. Teratogenicity and toxicity of coniine in cows, ewes and mares. *Cornell Vet.*, 70: 19-26.
- Keeler, R. F. 1974. Coniine, a teratogenic principle from *Conium maculatum* producing congenital malformations in calves. *Clin. Toxicol.*, 7: 195-206.
- Lampe, K. F., McCann, M. A. 1985. *AMA Handbook of poisonous and injurious plants*. American Medical Assoc. Chicago, Ill., USA. 432 pp.
- MacDonald, H. 1937. Hemlock poisoning in horses. *Vet. Rec.*, 49: 1211-1212.
- Panter, K. E., Bunch, T. D., Keeler, R. F. 1988. Maternal and fetal toxicity of poison hemlock (*Conium maculatum*) in sheep. *Am. J. Vet. Res.*, 49: 281-283.
- Panter, K. E., Keeler, R. F., Baker, D. C. 1988. Toxicoses in livestock from the hemlocks (*Conium* and *Cicuta* spp.). *J. Anim. Sci.*, 66: 2407-2413.
- Panter, K. E., Keeler, R. F., Buck, W. B. 1985. Congenital skeletal malformations induced by maternal ingestion of *Conium maculatum* (poison hemlock) in newborn pigs. *Am. J. Vet. Res.*, 46: 2064-2066.
- Panter, K. E., Keeler, R. F. 1989. Piperidine alkaloids of poison hemlock (*Conium maculatum*). Pages 109-132 in Cheeke, P. R., ed. *Toxicants of plant origin*. Vol. I. Alkaloids. CRC Press, Inc., Boca Raton, Fla., USA. 335 pp.
- Penny, R. H. 1953. Hemlock poisoning in cattle. *Vet. Rec.*, 42: 669-670.
- Short, S. B., Edwards, W. C. 1989. Accidental *Conium maculata* poisoning in the rabbit. *Vet. Hum. Toxicol.*, 31(1): 54-57.
- Widmer, W. R. 1984. Poison hemlock toxicosis in swine. *Vet. Med. Small Anim. Clin.*, 79: 405-408.

Nomenclature:

Scientific Name: *Conium maculatum* L.

Vernacular name(s): poison-hemlock

Scientific family name: *Umbelliferae*

Vernacular family name: parsley

Go to ITIS^{*ca} for more taxonomic information on: [Conium maculatum](#)

References:

Agriculture Quebec. 1975. Noms des maladies des plantes du Canada/ Names of plant diseases in Canada. , Quebec City, Que., Canada. 288 pp.

Alex, J. F., Cayouette, R., Mulligan, G. A. 1980. Common and botanical names of weeds in Canada/Noms populaire et scientifiques des plantes nuisibles du Canada. Revised. Agric. Can. Publ., Ottawa, Ont., Canada. 132 pp.

Bailey, L. H., Bailey, E. Z. 1976. Hortus third. Revised. MacMillan, New York, N.Y., USA. 1290 pp.

Scoggan, H. J. 1978, 1979. The flora of Canada. Nat. Mus. Nat. Sci. (Ottawa) Publ. Bot. 7(1)-7(4). 1711 pp.

Van Wijk, H. L. 1911. A dictionary of plant names. Martinus Nijhoff, The Hague, The Netherlands. 1444 pp.

Victorin, M. 1964. Flore Laurentienne. 2nd ed. Univ. Montreal, Montreal, Que., Canada. 952 pp.

Geographic Information

British Columbia

Nova Scotia

Ontario

Quebec

Saskatchewan

References:

Bailey, L. H., Bailey, E. Z. 1976. Hortus third. Revised. MacMillan, New York, N.Y., USA. 1290 pp.

Boivin, B. 1966, 1967. Énumération des plantes du Canada. Provencheria 6. Nat. Can. (Que.) 93: 253-274; 371-437; 583-646; 989-1063. 94: 131-157; 471-528; 625-655.

Image or illustration

poison-hemlock:

Images: images.google.com

Notes on Poisonous plant parts:

All parts of poison-hemlock contain some level of the alkaloids, except for the sap in young plants. The most toxic chemical, gamma-coniceine is abundant in leaves flowers and less common

in the fruits, where it is quickly converted to coniine and N-methylconiine (Cromwell 1956).

Toxic parts:

flowers
leaves
mature fruit
roots
seeds
stems
young shoots

References:

- Anon. 1951. Unusual case of hemlock poisoning in swine. *Calif. Vet.*, 5(2): 26.
- Cromwell, B. T. 1956. The separation, micro-estimation and distribution of the alkaloids of hemlock (*Conium maculatum* L.). *Biochem. J.*, 64: 259-266.
- Edmonds, L. D., Selby, L. A., Case, A. A. 1972. Poisoning and congenital malformations associated with consumption of poison hemlock by sows. *J. Am. Vet. Med. Assoc.*, 160: 1319-1324.
- Fairbairn, J. W., Suwal, P. N. 1961. The alkaloids of hemlock (*Conium maculatum* L.) - II. *Phytochemistry (Oxf.)*, 1: 38-46.
- Frank, A. A., Reed, W. M. 1987. *Conium maculatum* (poison hemlock) toxicosis in a flock of range turkeys. *Avian Dis.*, 31: 386-388.
- Hannam, D. A. 1985. Hemlock (*Conium maculatum*) poisoning in the pig. *Vet. Rec.*, 116: 322.
- MacDonald, H. 1937. Hemlock poisoning in horses. *Vet. Rec.*, 49: 1211-1212.
- Panter, K. E., Keeler, R. F. 1989. Piperidine alkaloids of poison hemlock (*Conium maculatum*). Pages 109-132 in Cheeke, P. R., ed. *Toxicants of plant origin. Vol. I. Alkaloids*. CRC Press, Inc., Boca Raton, Fla., USA. 335 pp.
- Penny, R. H. 1953. Hemlock poisoning in cattle. *Vet. Rec.*, 42: 669-670.
- Widmer, W. R. 1984. Poison hemlock toxicosis in swine. *Vet. Med. Small Anim. Clin.*, 79: 405-408.

Notes on Toxic plant chemicals:

gamma-Coniceine is the precursor of the other alkaloids in poison-

hemlock. This chemical is a partly unsaturated piperidine alkaloid. The other chemicals, including coniine and N-methylconiine, are saturated. During the first year of growth, gamma-coniceine is the predominant chemical. During the second year of growth, the content of both coniine and N-methylconiine increase, especially in the leaves and fruits, with a decrease in the first chemical. gamma-Coniceine is considered seven or eight times more toxic than coniine, with N-methylconiine even less toxic (Cromwell 1956, Fairbairn and Suwal 1961, Panter and Keeler 1989).

The following LD50 toxicities in mice have been reported (Bowman and Snaghvi 1963):

gamma-coniceine	death time
2.6 mg/kg (intravenous)	30 sec
12.0 mg/kg (subcutaneous)	12 min
12.0 mg/kg (oral)	8 min

coniine	death time
19.0 mg/kg (intravenous)	30 sec
80 mg/kg (subcutaneous)	15 min
100 mg/kg (oral)	10 min

N-methylconiine	death time
27.5 mg/kg (intravenous)	30 sec
150.5 mg/kg (subcutaneous)	16 min
204.5 mg/kg (oral)	12 min

Toxic plant chemicals:

coniine
gamma-coniceine
N-methylconiine

References:

- Bowman, W. C., Snaghvi, I. S. 1963. Pharmacological actions of hemlock (*Conium maculatum*) alkaloids. J. Pharm. Pharmacol., 15: 1.
- Cromwell, B. T. 1956. The separation, micro-estimation and distribution of the alkaloids of hemlock (*Conium maculatum* L.). Biochem. J., 64: 259-266.
- Fairbairn, J. W., Suwal, P. N. 1961. The alkaloids of hemlock (*Conium maculatum* L.) - II. Phytochemistry (Oxf.), 1: 38-46.
- Keeler, R. F., Balls, L. D., Shupe, J. L., Crowe, M. W. 1980. Teratogenicity and toxicity of coniine in cows, ewes and mares.

Cornell Vet., 70: 19-26.

Keeler, R. F. 1974. Coniine, a teratogenic principle from *Conium maculatum* producing congenital malformations in calves. Clin. Toxicol., 7: 195-206.

Panter, K. E., Bunch, T. D., Keeler, R. F. 1988. Maternal and fetal toxicity of poison hemlock (*Conium maculatum*) in sheep. Am. J. Vet. Res., 49: 281-283.

Panter, K. E., Keeler, R. F., Baker, D. C. 1988. Toxicoses in livestock from the hemlocks (*Conium* and *Cicuta* spp.). J. Anim. Sci., 66: 2407-2413.

Panter, K. E., Keeler, R. F., Buck, W. B. 1985. Congenital skeletal malformations induced by maternal ingestion of *Conium maculatum* (poison hemlock) in newborn pigs. Am. J. Vet. Res., 46: 2064-2066.

Panter, K. E., Keeler, R. F. 1989. Piperidine alkaloids of poison hemlock (*Conium maculatum*). Pages 109-132 in Cheeke, P. R., ed. Toxicants of plant origin. Vol. I. Alkaloids. CRC Press, Inc., Boca Raton, Fla., USA. 335 pp.

Animals/Human Poisoning:

Note: When an animal is listed without additional information, the literature (as of 1993) contained no detailed explanation.

Cattle

General symptoms of poisoning:

[arthrogryposis](#)

[breathing, rapid](#)

[carpal joint, flexure](#)

[depression](#)

[diarrhea](#)

[elbow joint, flexure](#)

[gait, unsteady](#)

[incoordination](#)

[limbs,lateral rotation](#)

[muscle spasms](#)

[salivation](#)

[scoliosis](#)

[teeth grinding](#)

[torticollis](#)

[trembling](#)

[urine, coffee-colored](#)

[vomiting](#)

Notes on poisoning:

General signs of poisoning in all types of livestock include apathy, salivation, frequent regurgitation, teeth grinding, and reduced milk production. For a lethal dose, cattle require coniine at a rate of about 16 mg/kg of body weight (Keeler et al. 1980).

References:

Cooper, M. R., Johnson, A. W. 1984. Poisonous plants in Britain and their effects on animals and man. Her Majesty's Stationery Office, London, England. 305 pp.

Keeler, R. F. 1974. Coniine, a teratogenic principle from *Conium maculatum* producing congenital malformations in calves. Clin. Toxicol., 7: 195-206.

Panter, K. E., Keeler, R. F., Baker, D. C. 1988. Toxicoses in livestock from the hemlocks (*Conium* and *Cicuta* spp.). J. Anim. Sci., 66: 2407-2413.

Penny, R. H. 1953. Hemlock poisoning in cattle. Vet. Rec., 42: 669-670.

Horses

General symptoms of poisoning:

[collapse](#)

[trembling](#)

[unconsciousness](#)

Notes on poisoning:

Horses exhibit symptoms similar to other types of livestock that have ingested poison-hemlock. Trembling and paralysis are common symptoms.

References:

MacDonald, H. 1937. Hemlock poisoning in horses. Vet. Rec., 49: 1211-1212.

Humans

General symptoms of poisoning:

[coma](#)

[convulsions](#)

[death by asphyxiation](#)

[dizziness](#)

[headache](#)

[incoordination](#)

[pupil dilation](#)

[thirsty](#)

[vomiting](#)

Notes on poisoning:

Poison-hemlock has been ingested on purpose and accidentally. Socrates was executed in 399 B.C. by an extract of this plant. Humans have accidentally ingested it, mistaking it for carrot or parsnip. The symptoms are similar to those in other animals. Coldness is often felt in the extremities. There is rapid onset of irritation of mucous membranes of the mouth and throat, accompanied by salivation and nausea. Severe poisoning may cause coma and death by respiratory failure. Treatment includes administering activated charcoal after emesis ceases. Treatment is otherwise symptomatic. Despite the severity of poisoning mortality is low (Cooper and Johnson 1984, Lampe and McCann 1985).

References:

Cooper, M. R., Johnson, A. W. 1984. Poisonous plants in Britain and their effects on animals and man. Her Majesty's Stationery Office, London, England. 305 pp.

Lampe, K. F., McCann, M. A. 1985. AMA Handbook of poisonous and injurious plants. American Medical Assoc. Chicago, Ill., USA. 432 pp.

Rabbits

General symptoms of poisoning:

[ataxia](#)

[breathing, shallow](#)

[death](#)

[trembling](#)

[weakness](#)

References:

Short, S. B., Edwards, W. C. 1989. Accidental *Conium maculata* poisoning in the rabbit. Vet. Hum. Toxicol., 31(1): 54-57.

Sheep

General symptoms of poisoning:

[ataxia](#)

[carpal joint, flexure](#)
[death](#)
[defecation, frequent](#)
[salivation](#)
[tail, kinked](#)
[trembling](#)
[urination, frequent](#)
[weakness](#)

References:

Panter, K. E., Bunch, T. D., Keeler, R. F. 1988. Maternal and fetal toxicity of poison hemlock (*Conium maculatum*) in sheep. Am. J. Vet. Res., 49: 281-283.

Swine

General symptoms of poisoning:

[arthrogryposis](#)
[articular rigidity](#)
[ataxia](#)
[blindness](#)
[blindness, temporary](#)
[breathing, labored](#)
[breathing, rapid](#)
[carpal joint, flexure](#)
[collapse](#)
[death](#)
[death by asphyxiation](#)
[fetlock joint, flexure](#)
[gait, staggering](#)
[gait, unsteady](#)
[heart rate, elevated](#)
[lacrimation, severe](#)
[palatoschisis](#)
[paralysis](#)
[prostration](#)
[pupil dilation](#)
[scoliosis](#)
[syndactylism](#)
[temperature, elevated](#)
[trembling](#)
[urination, frequent](#)
[vision, impaired](#)
[weakness](#)

References:

Anon. 1951. Unusual case of hemlock poisoning in swine. Calif. Vet., 5(2): 26.

Edmonds, L. D., Selby, L. A., Case, A. A. 1972. Poisoning and congenital malformations associated with consumption of poison hemlock by sows. J. Am. Vet. Med. Assoc., 160: 1319-1324.

Hannam, D. A. 1985. Hemlock (*Conium maculatum*) poisoning in the pig. Vet. Rec., 116: 322.

Panter, K. E., Keeler, R. F., Buck, W. B. 1985. Congenital skeletal malformations induced by maternal ingestion of *Conium maculatum* (poison hemlock) in newborn pigs. Am. J. Vet. Res., 46: 2064-2066.

Widmer, W. R. 1984. Poison hemlock toxicosis in swine. Vet. Med. Small Anim. Clin., 79: 405-408.

Turkeys

General symptoms of poisoning:

[death](#)

[diarrhea](#)

[enteritis](#)

[kidney, congestion of](#)

[liver, congestion of](#)

[lungs, congestion of](#)

[paralysis](#)

[salivation](#)

[weakness](#)

References:

Frank, A. A., Reed, W. M. 1987. *Conium maculatum* (poison hemlock) toxicosis in a flock of range turkeys. Avian Dis., 31: 386-388.

[Another search?](#)

[Français](#) | [Contact Us](#) | [Help](#) | [Search](#) | [Canada site](#)

[Coming Events](#) | [About CBIF](#) | [Links](#) | [Reports and Publications](#) |

[Home](#)

Date modified: 2003-02-06

[Important Notices](#)



Français	Contact us	Help	Search	Canada site
Coming events	About CBIF	Links	Reports and publications	Home



Notes on poisoning: pokeweed

[Introduction](#)

[Interactive](#)

[All poisonous plants by Botanical name](#)

[All poisonous plants by Common name](#)

[Important WWW Poisonous Plants sites](#)



General poisoning notes:

Pokeweed (*Phytolacca americana*) is a native herb found in the southwestern parts of Ontario and Quebec. The young shoots are used as poke salad and the leaves as a folk medicine or tea. In both cases, the plant material should be boiled at least twice to get rid of the toxin, according to literature reports. Failure to do so has caused poisoning in humans. Ingesting a few berries does not cause problems, but larger quantities, if uncooked, can be toxic to humans. Cattle, horses, sheep, and particularly swine, have been poisoned by ingesting pokeweed plant material. The berries have poisoned young turkeys experimentally (Patterson 1929, Barnett 1975, Callahan et al. 1981, Cooper and Johnson 1984).

References:

- Barnett, B. D. 1975. Toxicity of pokeberries (fruit of *Phytolacca americana* Large) for turkey poults. *Poult. Sci.*, 54: 1215-1217.
- Callahan, R., Piccola, F., Gensheimer, K., Parkin, W. E., Prusakowski, J., Scheiber, G., Henry, S. 1981. Epidemiologic notes and reports. *Plant poisonings - New Jersey*. U.S. Dep. Health Hum. M. M. W. R., 30: 65-67.
- Cooper, M. R., Johnson, A. W. 1984. *Poisonous plants in Britain and their effects on animals and man*. Her Majesty's Stationery Office, London, England. 305 pp.
- Jaackle, K. A., Freemon, F. R. 1981. Pokeweed poisoning. *South. Med. J.*, 74: 639-640.
- Lawrence, R. A. 1990. The clinical effects of pokeweed root ingestion upon 32 adults. *Vet. Hum. Toxicol.*, 32: 369.
- Lewis, W. H., Smith, P. R. 1979. Poke root herbal tea poisoning. *J. Am. Med. Assoc.*, 242: 2759-2760.
- Patterson, F. D. 1929. Pokeweed causes heavy losses in swine herd.

Vet. Med. Small Anim. Clin., 24: 114.

Stein, Z. L. 1979. Pokeweed-induced gastroenteritis. Am. J. Hosp. Pharm., 36: 1303.

Nomenclature:

Scientific Name: *Phytolacca americana* L.

Vernacular name(s): pokeweed

Scientific family name: *Phytolaccaceae*

Vernacular family name: pokeweed

Go to ITIS*^{ca} for more taxonomic information on: [Phytolacca americana](#)

References:

Agriculture Quebec. 1975. Noms des maladies des plantes du Canada/ Names of plant diseases in Canada. , Quebec City, Que., Canada. 288 pp.

Alex, J. F., Cayouette, R., Mulligan, G. A. 1980. Common and botanical names of weeds in Canada/Noms populaire et scientifiques des plantes nuisibles du Canada. Revised. Agric. Can. Publ., Ottawa, Ont., Canada. 132 pp.

Bailey, L. H., Bailey, E. Z. 1976. Hortus third. Revised. MacMillan, New York, N.Y., USA. 1290 pp.

Scoggan, H. J. 1978, 1979. The flora of Canada. Nat. Mus. Nat. Sci. (Ottawa) Publ. Bot. 7(1)-7(4). 1711 pp.

Van Wijk, H. L. 1911. A dictionary of plant names. Martinus Nijhoff, The Hague, The Netherlands. 1444 pp.

Victorin, M. 1964. Flore Laurentienne. 2nd ed. Univ. Montreal, Montreal, Que., Canada. 952 pp.

Geographic Information

Ontario

Quebec

References:

Bailey, L. H., Bailey, E. Z. 1976. Hortus third. Revised. MacMillan, New York, N.Y., USA. 1290 pp.

Boivin, B. 1966, 1967. Énumération des plantes du Canada. Provencheria 6. Nat. Can. (Que.) 93: 253-274; 371-437; 583-646;

989-1063. 94: 131-157; 471-528; 625-655.

Image or illustration

pokeweed:

Images: images.google.com

Notes on Poisonous plant parts:

Leaves, young shoots, and roots are poisonous. The berries are considered relatively nontoxic to humans, although toxicity to animals and humans has been reported. Barnett (1974) describes experimental poisoning and death in turkey poults.

Toxic parts:

all parts
leaves
mature fruit
roots
stems
young shoots

References:

- Barnett, B. D. 1975. Toxicity of pokeberries (fruit of *Phytolacca americana* Large) for turkey poults. *Poult. Sci.*, 54: 1215-1217.
- Callahan, R., Piccola, F., Gensheimer, K., Parkin, W. E., Prusakowski, J., Scheiber, G., Henry, S. 1981. Epidemiologic notes and reports. *Plant poisonings - New Jersey*. U.S. Dep. Health Hum. M. M. W. R., 30: 65-67.
- Jaeckle, K. A., Freemon, F. R. 1981. Pokeweed poisoning. *South. Med. J.*, 74: 639-640.
- Lawrence, R. A. 1990. The clinical effects of pokeweed root ingestion upon 32 adults. *Vet. Hum. Toxicol.*, 32: 369.
- Lewis, W. H., Smith, P. R. 1979. Poke root herbal tea poisoning. *J. Am. Med. Assoc.*, 242: 2759-2760.
- Patterson, F. D. 1929. Pokeweed causes heavy losses in swine herd. *Vet. Med. Small Anim. Clin.*, 24: 114.
- Stein, Z. L. 1979. Pokeweed-induced gastroenteritis. *Am. J. Hosp. Pharm.*, 36: 1303.

Notes on Toxic plant chemicals:

Phytolaccatoxin, a triterpene saponin, has been implicated in pokeweed toxicity. The toxin is water-soluble, which has led to the common assumption that boiling the plant material twice will get rid of toxicity. Such treatment is usually sufficient to remove the toxin (Lampe and McCann 1985).

Toxic plant chemicals:

phytolaccatoxin

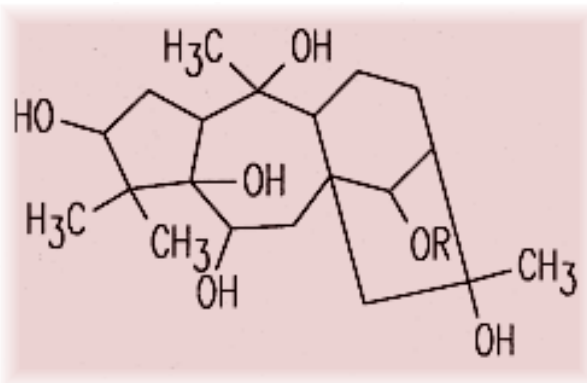

phytolaccigenin

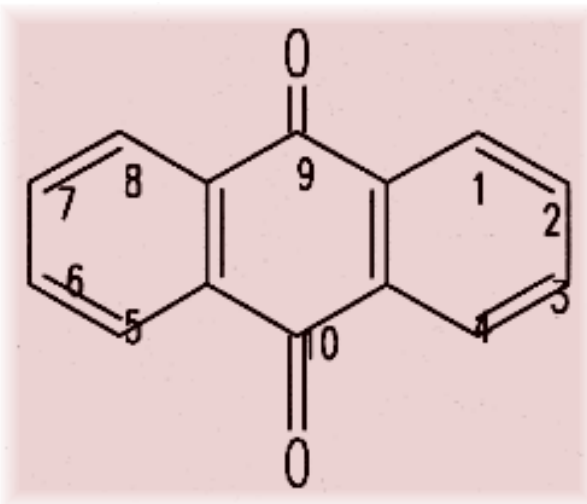

Chemical diagram(s) are courtesy of [Ruth McDiarmid](#), Biochemistry Technician, Kamloops Range Station, Agriculture and Agri-Food Canada, Kamloops, British Columbia, Canada.

References:

Lampe, K. F., McCann, M. A. 1985. AMA Handbook of poisonous and injurious plants. American Medical Assoc. Chicago, Ill., USA. 432 pp.

Lewis, W. H., Smith, P. R. 1979. Poke root herbal tea poisoning. J. Am. Med. Assoc., 242: 2759-2760.

Animals/Human Poisoning:

Note: When an animal is listed without additional information, the literature (as of 1993) contained no detailed explanation.

Cattle

General symptoms of poisoning:

[abortion](#)

[coma](#)

[convulsions](#)

[diarrhea](#)

[vomiting](#)

References:

Cooper, M. R., Johnson, A. W. 1984. Poisonous plants in Britain and their effects on animals and man. Her Majesty's Stationery Office, London, England. 305 pp.

Horses

General symptoms of poisoning:

[convulsions](#)

[diarrhea](#)

[gastroenteritis](#)

[salivation](#)

[vomiting](#)

References:

Cooper, M. R., Johnson, A. W. 1984. Poisonous plants in Britain and their effects on animals and man. Her Majesty's Stationery Office, London, England. 305 pp.

Humans

General symptoms of poisoning:

[abdominal pains](#)

[blood pressure, low](#)

[breathing, rapid](#)

[confusion](#)

[diarrhea](#)

[dizziness](#)

[gastroenteritis](#)
[headache](#)
[heart rate, elevated](#)
[nausea](#)
[salivation](#)
[stomach cramps](#)
[stool, bloody](#)
[sweating](#)
[thirsty](#)
[trembling](#)
[unconsciousness](#)
[urinary incontinence](#)
[vomiting](#)
[weakness](#)

Notes on poisoning:

Symptoms of toxicity include sweating, bloody diarrhea, abdominal pains, weakness, incontinence, vomiting, salivation, unconsciousness, tremors, and blurred vision. Ingesting the leaves or young shoots causes toxicity. Sometimes tea made from the leaves can cause poisoning. Symptomatic treatment and replacement of fluids are recommended (Callahan et al. 1981, Jaeckle and Freemon 1981).

References:

- Callahan, R., Piccola, F., Gensheimer, K., Parkin, W. E., Prusakowski, J., Scheiber, G., Henry, S. 1981. Epidemiologic notes and reports. Plant poisonings - New Jersey. U.S. Dep. Health Hum. M. M. W. R., 30: 65-67.
- Jaeckle, K. A., Freemon, F. R. 1981. Pokeweed poisoning. South. Med. J., 74: 639-640.
- Lawrence, R. A. 1990. The clinical effects of pokeweed root ingestion upon 32 adults. Vet. Hum. Toxicol., 32: 369.
- Lewis, W. H., Smith, P. R. 1979. Poke root herbal tea poisoning. J. Am. Med. Assoc., 242: 2759-2760.
- Stein, Z. L. 1979. Pokeweed-induced gastroenteritis. Am. J. Hosp. Pharm., 36: 1303.

Sheep

General symptoms of poisoning:

[diarrhea](#)
[drowsiness](#)
[gastroenteritis](#)

[vomiting](#)

References:

Cooper, M. R., Johnson, A. W. 1984. Poisonous plants in Britain and their effects on animals and man. Her Majesty's Stationery Office, London, England. 305 pp.

Swine

General symptoms of poisoning:

[death](#)

[gait, unsteady](#)

[gastroenteritis](#)

[liver, congestion of](#)

[muscle twitching](#)

[paralysis, posterior](#)

Notes on poisoning:

Swine are most frequently poisoned by pokeweed. Symptoms include staggering, vomiting, posterior paralysis, tremors, and death. Post-mortem findings show swollen, dark liver and severe hemorrhagic gastritis (Patterson 1929).

References:

Patterson, F. D. 1929. Pokeweed causes heavy losses in swine herd. Vet. Med. Small Anim. Clin., 24: 114.

Turkeys

General symptoms of poisoning:

[ascites](#)

[gall bladder, enlarged](#)

[hock, swollen](#)

[weight gain, reduced](#)

Notes on poisoning:

Experimental feeding of mashed berries to turkey poults caused weight-gain reduction, ascites, and swollen hocks, causing unsteadiness. Enlarged gall bladder filled with brown fluid was common in dead birds. Wild birds ingest the berries and spread seeds; no toxic cases have been mentioned. Chickens are not poisoned by the berries (Barnett 1975, Cooper and Johnson 1984).

References:

Barnett, B. D. 1975. Toxicity of pokeberries (fruit of *Phytolacca americana* Large) for turkey poults. *Poult. Sci.*, 54: 1215-1217.

[Another search?](#)

[Français](#) | [Contact Us](#) | [Help](#) | [Search](#) | [Canada site](#)

[Coming Events](#) | [About CBIF](#) | [Links](#) | [Reports and Publications](#) |

[Home](#)

Date modified: 2003-02-06

[Important Notices](#)



Français	Contact us	Help	Search	Canada site
Coming events	About CBIF	Links	Reports and publications	Home

Canadian Biodiversity Information Facility



Notes on poisoning: ponderosa pine

[Introduction](#)

[Interactive](#)

[All poisonous plants by Botanical name](#)

[All poisonous plants by Common name](#)

[Important WWW Poisonous Plants sites](#)



General poisoning notes:

Ponderosa pine (*Pinus ponderosa*) is a native tree in British Columbia. Pregnant cows that ingest the needles abort within 2 days to 2 weeks. Calves near full term may be born in good condition. Cows in the third trimester are affected; the problem usually occurs during winter and spring, when forage is scarce. Cows may retain the placenta. If medical attention is not given, a high degree of fatality can occur. Annual losses in the entire western United States have been estimated at 4.5 million dollars. This problem has also occurred in British Columbia (MacDonald 1952, Stevenson et al. 1972, Gartner et al. 1988, Lacey et al. 1988).

References:

Gartner, F. R., Johnson, F. D., Morgan, P. 1988. Cattle abortion from ponderosa pine needles: ecological and range management considerations. Pages 71-94 in James, L. F., Ralphs, M. H., Nielsen, D. B., eds. The ecology and economic impact of poisonous plants on livestock production. Westview Press, Boulder, Colo., USA. 428 pp.

James, L. F., Call, J. W. 1972. Pine-needle (*Pinus ponderosa*) - induced abortion in range cattle. Cornell Vet., 62: 519-524.

Lacey, J. R., James, L. F., Short, R. E. 1988. Ponderosa pine: economic impact. Pages 95-106 in James, L. F., Ralphs, M. H., Nielsen, D. B., eds. The ecology and economic impact of poisonous plants on livestock production. Westview Press, Boulder, Colo., USA. 428 pp.

MacDonald, M. A. 1952. Pine needle abortion in range beef cattle. J. Range Manage., 5: 150-155.

Molyneux, R. J., Baker, D. C., Short, R. E. 1988. Effects of various parts of the ponderosa pine on bovine pregnancy. J.

Anim. Sci., 66(1): 372.

Murdoch, W. J., Becerra, V. M., Mills, K. W., Robinson, J. L. 1989. Evaluation of histopathologic and physiologic changes in cows having premature births after consuming ponderosa pine needles. Am. J. Vet. Res., 50: 285-289.

Nomenclature:

Scientific Name: *Pinus ponderosa* Dougl.

Vernacular name(s): ponderosa pine

Scientific family name: *Pinaceae*

Vernacular family name: pine

Go to ITIS^{*ca} for more taxonomic information on: [Pinus ponderosa](#)

References:

Agriculture Quebec. 1975. Noms des maladies des plantes du Canada/ Names of plant diseases in Canada. , Quebec City, Que., Canada. 288 pp.

Alex, J. F., Cayouette, R., Mulligan, G. A. 1980. Common and botanical names of weeds in Canada/Noms populaire et scientifiques des plantes nuisibles du Canada. Revised. Agric. Can. Publ., Ottawa, Ont., Canada. 132 pp.

Bailey, L. H., Bailey, E. Z. 1976. Hortus third. Revised. MacMillan, New York, N.Y., USA. 1290 pp.

Scoggan, H. J. 1978, 1979. The flora of Canada. Nat. Mus. Nat. Sci. (Ottawa) Publ. Bot. 7(1)-7(4). 1711 pp.

Van Wijk, H. L. 1911. A dictionary of plant names. Martinus Nijhoff, The Hague, The Netherlands. 1444 pp.

Victorin, M. 1964. Flore Laurentienne. 2nd ed. Univ. Montreal, Montreal, Que., Canada. 952 pp.

Geographic Information

British Columbia

References:

Bailey, L. H., Bailey, E. Z. 1976. Hortus third. Revised. MacMillan, New York, N.Y., USA. 1290 pp.

Boivin, B. 1966, 1967. Énumération des plantes du Canada.

Provencheria 6. Nat. Can. (Que.) 93: 253-274; 371-437; 583-646; 989-1063. 94: 131-157; 471-528; 625-655.

Image or illustration

ponderosa pine:

Images: images.google.com

Toxic parts:

needles (pine)

young shoots

References:

Gartner, F. R., Johnson, F. D., Morgan, P. 1988. Cattle abortion from ponderosa pine needles: ecological and range management considerations. Pages 71-94 in James, L. F., Ralphs, M. H., Nielsen, D. B., eds. The ecology and economic impact of poisonous plants on livestock production. Westview Press, Boulder, Colo., USA. 428 pp.

James, L. F., Call, J. W. 1972. Pine-needle (*Pinus ponderosa*) - induced abortion in range cattle. Cornell Vet., 62: 519-524.

MacDonald, M. A. 1952. Pine needle abortion in range beef cattle. J. Range Manage., 5: 150-155.

Molyneux, R. J., Baker, D. C., Short, R. E. 1988. Effects of various parts of the ponderosa pine on bovine pregnancy. J. Anim. Sci., 66(1): 372.

Murdoch, W. J., Becerra, V. M., Mills, K. W., Robinson, J. L. 1989. Evaluation of histopathologic and physiologic changes in cows having premature births after consuming ponderosa pine needles. Am. J. Vet. Res., 50: 285-289.

Notes on Toxic plant chemicals:

Although no chemical has been proved to cause toxicity and abortion in cattle, several toxic compounds have been suspected, including diterpene resin acids. Additional factors such as stage of gestation when ingestion occurs, environmental stress, and condition of the cow compound the problem. Inducting experimental abortion has not been consistent (Gartner et al. 1988).

Toxic plant chemicals:

unknown chemical

References:

Gartner, F. R., Johnson, F. D., Morgan, P. 1988. Cattle abortion from ponderosa pine needles: ecological and range management considerations. Pages 71-94 in James, L. F., Ralphs, M. H., Nielsen, D. B., eds. The ecology and economic impact of poisonous plants on livestock production. Westview Press, Boulder, Colo., USA. 428 pp.

Animals/Human Poisoning:

Note: When an animal is listed without additional information, the literature (as of 1993) contained no detailed explanation.

Cattle

General symptoms of poisoning:

[abortion](#)

[cervix dilation,narrow](#)

[death](#)

[fetus, dead](#)

[metritis septic](#)

[parturition, early](#)

[placenta, persistent](#)

[progesterone,decreased](#)

[uterine hemorrhage](#)

References:

James, L. F., Call, J. W. 1972. Pine-needle (*Pinus ponderosa*) - induced abortion in range cattle. Cornell Vet., 62: 519-524.

MacDonald, M. A. 1952. Pine needle abortion in range beef cattle. J. Range Manage., 5: 150-155.

Molyneux, R. J., Baker, D. C., Short, R. E. 1988. Effects of various parts of the ponderosa pine on bovine pregnancy. J. Anim. Sci., 66(1): 372.

Murdoch, W. J., Becerra, V. M., Mills, K. W., Robinson, J. L. 1989. Evaluation of histopathologic and physiologic changes in cows having premature births after consuming ponderosa pine needles. Am. J. Vet. Res., 50: 285-289.

[Another search?](#)

[Français](#) | [Contact Us](#) | [Help](#) | [Search](#) | [Canada site](#)
[Coming Events](#) | [About CBIF](#) | [Links](#) | [Reports and Publications](#) |
[Home](#)

Date modified: 2003-02-06

[Important Notices](#)



Français	Contact us	Help	Search	Canada site
Coming events	About CBIF	Links	Reports and publications	Home



Notes on poisoning: potato

[Introduction](#)

[Interactive](#)

[All poisonous plants by Botanical name](#)

[All poisonous plants by Common name](#)

[Important WWW Poisonous Plants sites](#)



General poisoning notes:

Potato (*Solanum tuberosum*) is a common introduced garden plant cultivated for its edible tubers. The entire plant contains toxic glycoalkaloids but usually in harmless quantities in the edible tubers. However, in the presence of light, the tubers photosynthesize and coincidentally increase the amount of toxins. The skin, eyes, and sprouts of the tubers can develop toxic amounts. Even the flesh of the tuber can develop toxic quantities of the glycoalkaloids. Cattle, sheep, and swine as well as humans were poisoned and died after ingesting parts of potato plant. Other animals were also been poisoned experimentally. A dog became comatose after ingesting green potato tubers. The aboveground plant portion can also be toxic. The berries produced by the plant can contain 10-20 times more glycoalkaloids than the tubers (Cooper and Johnson 1984). The glycoalkaloids solanine and chaconine are not destroyed by normal cooking. Alkaloidal levels above 20 mg/100 g are considered unsafe for human consumption. Some cultivars have naturally high concentrations of alkaloids and have been rejected for use. Care should be taken to store potatoes in light-proof paper bags. If any green-colored potatoes are found, they should be discarded. Potato peelings and sprouts destined for a compost heap should be buried and kept from dogs or other animals. Sharma and Salunkhe (1989) provide an excellent review of potatoes and toxins and their effects on animals.

References:

Clay, B. R., Edwards, W. C., Peterson, D. R. 1976. Toxic nitrate accumulation in the sorghums. *Bovine Pract.*, 11: 28-32.

Cooper, M. R., Johnson, A. W. 1984. Poisonous plants in Britain and their effects on animals and man. Her Majesty's Stationery Office, London, England. 305 pp.

Keeler, R. F., Baker, D. C., Gaffield, W. 1990. Spirosolane-containing *Solanum* species and induction of congenital craniofacial malformations. *Toxicon*, 28: 873-884.

McMillan, M., Thompson, J. C. 1979. An outbreak of suspected solanine poisoning in schoolboys: examination of criteria of solanine poisoning. *Q.*

J. Med., 48: 227-243.

Sharma, R. P., Salunkhe, D. K. 1989. *Solanum* glycoalkaloids. Pages 179-236 in Cheeke, P. R., ed. Toxicants of plant origin. Vol. I. Alkaloids. CRC Press, Inc., Boca Raton, Fla., USA. 335 pp.

Nomenclature:

Scientific Name: *Solanum tuberosum* L.

Vernacular name(s): potato

Scientific family name: *Solanaceae*

Vernacular family name: nightshade

Go to ITIS^{*ca} for more taxonomic information on: [Solanum tuberosum](#)

References:

Agriculture Quebec. 1975. Noms des maladies des plantes du Canada/ Names of plant diseases in Canada. , Quebec City, Que., Canada. 288 pp.

Alex, J. F., Cayouette, R., Mulligan, G. A. 1980. Common and botanical names of weeds in Canada/Noms populaire et scientifiques des plantes nuisibles du Canada. Revised. Agric. Can. Publ., Ottawa, Ont., Canada. 132 pp.

Bailey, L. H., Bailey, E. Z. 1976. Hortus third. Revised. MacMillan, New York, N.Y., USA. 1290 pp.

Scoggan, H. J. 1978, 1979. The flora of Canada. Nat. Mus. Nat. Sci. (Ottawa) Publ. Bot. 7(1)-7(4). 1711 pp.

Van Wijk, H. L. 1911. A dictionary of plant names. Martinus Nijhoff, The Hague, The Netherlands. 1444 pp.

Victorin, M. 1964. Flore Laurentienne. 2nd ed. Univ. Montreal, Montreal, Que., Canada. 952 pp.

Geographic Information

Plant or plant parts used in or around the home.

References:

Bailey, L. H., Bailey, E. Z. 1976. Hortus third. Revised. MacMillan, New York, N.Y., USA. 1290 pp.

Boivin, B. 1966, 1967. Énumération des plantes du Canada. Provencheria 6. Nat. Can. (Que.) 93: 253-274; 371-437; 583-646; 989-1063. 94: 131-157; 471-528; 625-655.

Image or illustration

potato:

Images: images.google.com

Notes on Poisonous plant parts:

Potato tubers can develop toxic levels of glycoalkaloids if they are exposed to sunlight. The development of the toxins coincides with the production of chlorophyll in the presence of light. The toxins are highest in the skin, eyes, and sprouts. In a test on rats fed 10% sprouts from early pregnancy, 55% of litters died because of failure to lactate. Potato cultivars, such as "Lenape" have been developed with natural toxic levels of alkaloids in the tubers; these cultivars have not been released for use. The leaves, stems, and berries of potato also contain toxic substances. The concentration of alkaloids in the berries may be 10-20 times that of the tubers (Butterworth and Pelling 1980, Cooper and Johnson 1984, Cheeke and Schull 1985, Salunkhe 1989).

Toxic parts:

immature fruit
leaves
stems
tubers

References:

Butterworth, K. R., Pelling, D. 1980. Are potato 'apples' toxic? *J. Pharm. Pharmacol.*, 32: 79 P.

Cheeke, P. R., Shull, L. R. 1985. *Natural toxicants in feeds and poisonous plants*. AVI Publishing Company, Inc., Westport, Conn., USA. 492 pp.

Cooper, M. R., Johnson, A. W. 1984. *Poisonous plants in Britain and their effects on animals and man*. Her Majesty's Stationery Office, London, England. 305 pp.

Notes on Toxic plant chemicals:

Two glycoalkaloids, alpha-solanine and alpha-chaconine, are the major alkaloids in potatoes. The major effects are gastrointestinal tract irritation and nervous system impairment. Exposing the potato tubers to light may increase the concentration of glycoalkaloids to 0.05% in the tuber instead of the usual 0.008%. Potatoes are now screened for toxin levels, which must be below 20 mg/100 g. Levels above 14 mg/100 g are bitter. One variety developed in the 1960s, "Lenape", had levels over 30 mg/100 g and was rejected. Berries of potatoes have also been tested and an LD-50 of 677 g/kg was found in mice. It has been estimated that ingesting 400 g of

literature (as of 1993) contained no detailed explanation.

Cattle

General symptoms of poisoning:

[anemia](#)

[anorexia](#)

[convulsions](#)

[death](#)

[diarrhea](#)

[restlessness](#)

Notes on poisoning:

Cattle were poisoning after they were given access to green, decayed, or sprouting potatoes. In Europe, feeding large quantities of stored potatoes to young cattle over long periods is recognised as causing severe anemia (Cooper and Johnson 1984).

References:

Cooper, M. R., Johnson, A. W. 1984. Poisonous plants in Britain and their effects on animals and man. Her Majesty's Stationery Office, London, England. 305 pp.

Dogs

General symptoms of poisoning:

[breathing, labored](#)

[coma](#)

[pupil dilation](#)

References:

Cooper, M. R., Johnson, A. W. 1984. Poisonous plants in Britain and their effects on animals and man. Her Majesty's Stationery Office, London, England. 305 pp.

Humans

General symptoms of poisoning:

[abdominal pains](#)

[confusion](#)

[death](#)

[drowsiness](#)

[gastroenteritis](#)

[hallucination](#)

[headache](#)

[trembling](#)

[vomiting](#)

Notes on poisoning:

Ingesting potatoes with green flesh, skin, or tubers causes sickness and, in some cases, human fatalities. Symptoms of ingestion include those common to gastrointestinal problems and nervous disorders. Clinical signs include headache, vomiting, diarrhea and abdominal pain. Neurological symptoms include apathy, restlessness, drowsiness, stupor, confusion, hallucinations, dizziness, trembling, and visual impairment. In severe cases, fatalities occur. Certain birth defects are believed to result from ingesting potatoes infected with potato blight (*Phytophthora infestans*). However, no definitive proof has been found yet (McMillan and Thompson 1979, Sharma and Salunkhe 1989).

References:

McMillan, M., Thompson, J. C. 1979. An outbreak of suspected solanine poisoning in schoolboys: examination of criteria of solanine poisoning. *Q. J. Med.*, 48: 227-243.

Sharma, R. P., Salunkhe, D. K. 1989. *Solanum* glycoalkaloids. Pages 179-236 in Cheeke, P. R., ed. Toxicants of plant origin. Vol. I. Alkaloids. CRC Press, Inc., Boca Raton, Fla., USA. 335 pp.

Rodents

General symptoms of poisoning:

[craniofacial problems](#)

[gastroenteritis](#)

Notes on poisoning:

Pregnant hamsters were gavaged with potato sprout material. Some dams died as a result of experimentally ingesting sprout material. Fetal craniofacial malformations occurred in 24% of cases (Keeler et al. 1990).

References:

Keeler, R. F., Baker, D. C., Gaffield, W. 1990. Spirosolane-containing *Solanum* species and induction of congenital craniofacial malformations. *Toxicon*, 28: 873-884.

Sheep

General symptoms of poisoning:

[death](#)

[incoordination](#)

[weakness](#)

References:

Cooper, M. R., Johnson, A. W. 1984. Poisonous plants in Britain and their effects on animals and man. Her Majesty's Stationery Office, London, England. 305 pp.

Swine

General symptoms of poisoning:

[anorexia](#)

[coma](#)

[convulsions](#)

[diarrhea](#)

[incoordination](#)

[pupil dilation](#)

[restlessness](#)

[salivation](#)

[vomiting](#)

[weakness](#)

Notes on poisoning:

In Europe, swine that ingested potatoes were poisoned and subsequently died. Some animals died suddenly, whereas others showed signs of incoordination, convulsions, and appeared dazed. Additional symptoms included anorexia, excess salivation, vomiting, diarrhea or constipation, and circulatory failure. Some cases required amputation, resulting from necrosis of the feet (Cooper and Johnson 1984).

References:

Cooper, M. R., Johnson, A. W. 1984. Poisonous plants in Britain and their effects on animals and man. Her Majesty's Stationery Office, London, England. 305 pp.

[Another search?](#)

[Français](#) | [Contact Us](#) | [Help](#) | [Search](#) | [Canada site](#)

[Coming Events](#) | [About CBIF](#) | [Links](#) | [Reports and Publications](#) | [Home](#)

Date modified: 2003-02-06

[Important Notices](#)



Français	Contact us	Help	Search	Canada site
Coming events	About CBIF	Links	Reports and publications	Home

Canadian Biodiversity Information Facility



Notes on poisoning: precatory-pea

[Introduction](#)

[Interactive](#)

[All poisonous plants by Botanical name](#)

[All poisonous plants by Common name](#)

[Important WWW Poisonous Plants sites](#)



General poisoning notes:

Precatory-pea (*Abrus precatorius*) seeds contain a chemical called abrin, which is highly toxic. A single well-masticated seed can kill an adult human (Kingsbury 1964).

In Canada the seeds of this plant are imported into the country on necklaces and perhaps on other decorative items. These attractive seeds are shiny, red, and black and about 5-8 mm long (Hoy and Catling 1981).

References:

Davis, J. H. 1978. *Abrus precatorius* (rosary pea). The most common lethal plant poison. J. Fla. Med. Assoc., 65: 189-191.

Gunn, C. R. 1969. *Abrus precatorius*: a deadly gift. Gard. J., 19:2-5.

Hoy, D. L., Catling, P. M. 1981. Necklaces from nature - seed jewelry. Davidsonia, 12: 63-77.

Kingsbury, J. M. 1964. Poisonous plants of the United States and Canada. Prentice-Hall Inc., Englewood Cliffs, N.J., USA. 626 pp.

Stirpe, F., Barbieri, L. 1986. Ribosome-inactivating proteins up to date. FEBS (Fed. Eur. Biochem. Soc.) Lett., 195: 1-8.

Nomenclature:

Scientific Name: *Abrus precatorius* L.

Vernacular name(s): precatory-pea

Scientific family name: *Leguminosae*

Vernacular family name: pea

Go to ITIS*^{ca} for more taxonomic information on: [Abrus](#)

[preparatorius](#)

References:

Agriculture Quebec. 1975. Noms des maladies des plantes du Canada/ Names of plant diseases in Canada. , Quebec City, Que., Canada. 288 pp.

Alex, J. F., Cayouette, R., Mulligan, G. A. 1980. Common and botanical names of weeds in Canada/Noms populaire et scientifiques des plantes nuisibles du Canada. Revised. Agric. Can. Publ., Ottawa, Ont., Canada. 132 pp.

Bailey, L. H., Bailey, E. Z. 1976. Hortus third. Revised. MacMillan, New York, N.Y., USA. 1290 pp.

Scoggan, H. J. 1978, 1979. The flora of Canada. Nat. Mus. Nat. Sci. (Ottawa) Publ. Bot. 7(1)-7(4). 1711 pp.

Van Wijk, H. L. 1911. A dictionary of plant names. Martinus Nijhoff, The Hague, The Netherlands. 1444 pp.

Victorin, M. 1964. Flore Laurentienne. 2nd ed. Univ. Montreal, Montreal, Que., Canada. 952 pp.

Geographic Information

Plant or plant parts used in or around the home.

References:

Bailey, L. H., Bailey, E. Z. 1976. Hortus third. Revised. MacMillan, New York, N.Y., USA. 1290 pp.

Boivin, B. 1966, 1967. Énumération des plantes du Canada. Provencheria 6. Nat. Can. (Que.) 93: 253-274; 371-437; 583-646; 989-1063. 94: 131-157; 471-528; 625-655.

Image or illustration

precatory-pea:

Images: images.google.com

Toxic parts:

seeds

References:

Davis, J. H. 1978. *Abrus preparatorius* (rosary pea). The most common lethal plant poison. J. Fla. Med. Assoc., 65: 189-191.

Gunn, C. R. 1969. *Abrus precatorius*: a deadly gift. Gard. J., 19:2-5.

Hoy, D. L., Catling, P. M. 1981. Necklaces from nature - seed jewelry. Davidsonia, 12: 63-77.

Notes on Toxic plant chemicals:

Abrin is a lectin of *Abrus precatorius* and is a ribosome-inactivating protein. This chemical is regarded as one of the most deadly plant toxins known.

LD-50: 0.56 micro gm/kg in mice (Stirpe and Barbieri 1986). Kingsbury (1964) states that a toxicity dose is about 0.00015% of a human subject's weight. A single well-masticated seed can kill an adult. Abrin causes large-scale disruption in lymphoid tissues, with apoptotic cell death. Apoptotic bodies have increased in the small intestine of experimental rats (Griffiths et al. 1987).

Toxic plant chemicals:

abrin

References:

Davis, J. H. 1978. *Abrus precatorius* (rosary pea). The most common lethal plant poison. J. Fla. Med. Assoc., 65: 189-191.

Griffiths, G. D., Leek, M. D., Gee, D. J. 1987. The toxic plant proteins ricin and abrin induce apoptotic changes in mammalian lymphoid tissues and intestine. J. Pathol., 151: 221-229.

Kingsbury, J. M. 1964. Poisonous plants of the United States and Canada. Prentice-Hall Inc., Englewood Cliffs, N.J., USA. 626 pp.

Stirpe, F., Barbieri, L. 1986. Ribosome-inactivating proteins up to date. FEBS (Fed. Eur. Biochem. Soc.) Lett., 195: 1-8.

Animals/Human Poisoning:

Note: When an animal is listed without additional information, the literature (as of 1993) contained no detailed explanation.

Humans

General symptoms of poisoning:

[abdominal pains](#)

[cecum, red and inflamed](#)

[cerebral edema](#)

[death](#)

[diarrhea](#)

[gastric mucosa, purple](#)

[nausea](#)

[stomach, gray mucous](#)

[vomiting](#)

References:

Davis, J. H. 1978. *Abrus precatorius* (rosary pea). The most common lethal plant poison. J. Fla. Med. Assoc., 65: 189-191.

Gunn, C. R. 1969. *Abrus precatorius*: a deadly gift. Gard. J., 19:2-5.

Hoy, D. L., Catling, P. M. 1981. Necklaces from nature - seed jewelry. Davidsonia, 12: 63-77.

Rodents

General symptoms of poisoning:

[death](#)

References:

Stirpe, F., Barbieri, L. 1986. Ribosome-inactivating proteins up to date. FEBS (Fed. Eur. Biochem. Soc.) Lett., 195: 1-8.

[Another search?](#)

[Français](#) | [Contact Us](#) | [Help](#) | [Search](#) | [Canada site](#)

[Coming Events](#) | [About CBIF](#) | [Links](#) | [Reports and Publications](#) |

[Home](#)

Date modified: 2003-02-06

[Important Notices](#)



Français	Contact us	Help	Search	Canada site
Coming events	About CBIF	Links	Reports and publications	Home

Canadian Biodiversity Information Facility



Notes on poisoning: prickly comfrey

[Introduction](#)

[Interactive](#)

[All poisonous plants by Botanical name](#)

[All poisonous plants by Common name](#)

[Important WWW Poisonous Plants sites](#)



General poisoning notes:

Prickly comfrey (*Symphytum asperum*) is a naturalized herb found in parts of southern Canada. The plant contains pyrrolizidine alkaloids, which can cause veno-occlusive symptoms leading to liver cirrhosis. The plant can also accumulate toxic amounts of nitrates. Animals do not normally eat the plant because of the bristly hairs on the leaves. However, swine given the plant as green fodder showed signs of nitrate poisoning. Long-term use of the plant as food could lead to liver dysfunction (Cooper and Huxtable 1984, Huxtable 1989).

References:

Cooper, M. R., Johnson, A. W. 1984. Poisonous plants in Britain and their effects on animals and man. Her Majesty's Stationery Office, London, England. 305 pp.

Huxtable, R. J. 1989. Human health implications of pyrrolizidine alkaloids and herbs containing them. Pages 41-86 in Cheeke, P. R., ed. Toxicants of plant origin. Vol. I. Alkaloids. CRC Press, Inc., Boca Raton, Fla., USA. 335 pp.

Nomenclature:

Scientific Name: *Symphytum asperum* Lepech.

Vernacular name(s): prickly comfrey

Scientific family name: *Boraginaceae*

Vernacular family name: borage

Go to ITIS^{*ca} for more taxonomic information on: [Symphytum asperum](#)

References:

Agriculture Quebec. 1975. Noms des maladies des plantes du Canada/ Names of plant diseases in Canada. , Quebec City, Que., Canada. 288 pp.

Alex, J. F., Cayouette, R., Mulligan, G. A. 1980. Common and botanical names of weeds in Canada/Noms populaire et scientifiques des plantes nuisibles du Canada. Revised. Agric. Can. Publ., Ottawa, Ont., Canada. 132 pp.

Bailey, L. H., Bailey, E. Z. 1976. Hortus third. Revised. MacMillan, New York, N.Y., USA. 1290 pp.

Scoggan, H. J. 1978, 1979. The flora of Canada. Nat. Mus. Nat. Sci. (Ottawa) Publ. Bot. 7(1)-7(4). 1711 pp.

Van Wijk, H. L. 1911. A dictionary of plant names. Martinus Nijhoff, The Hague, The Netherlands. 1444 pp.

Victorin, M. 1964. Flore Laurentienne. 2nd ed. Univ. Montreal, Montreal, Que., Canada. 952 pp.

Geographic Information

British Columbia
Manitoba
Nova Scotia
Ontario
Prince Edward Island
Quebec

References:

Bailey, L. H., Bailey, E. Z. 1976. Hortus third. Revised. MacMillan, New York, N.Y., USA. 1290 pp.

Boivin, B. 1966, 1967. Énumération des plantes du Canada. Provencheria 6. Nat. Can. (Que.) 93: 253-274; 371-437; 583-646; 989-1063. 94: 131-157; 471-528; 625-655.

Image or illustration

prickly comfrey:

Images: images.google.com

Toxic parts:

all parts
leaves
roots

stems

References:

Cooper, M. R., Johnson, A. W. 1984. Poisonous plants in Britain and their effects on animals and man. Her Majesty's Stationery Office, London, England. 305 pp.

Huxtable, R. J. 1989. Human health implications of pyrrolizidine alkaloids and herbs containing them. Pages 41-86 in Cheeke, P. R., ed. Toxicants of plant origin. Vol. I. Alkaloids. CRC Press, Inc., Boca Raton, Fla., USA. 335 pp.

Notes on Toxic plant chemicals:

This plant contains pyrrolizidine alkaloids such as echimidine. These alkaloids cause veno-occlusive symptoms in animals. Total alkaloid content (as a percentage of dry weight) for fresh leaves is about 0.01% and for dry leaves, about 0.059%. Many members of the genus contain much higher concentrations of alkaloids in the roots (Huxtable 1989).

Toxic plant chemicals:

echimidine
nitrate

References:

Cooper, M. R., Johnson, A. W. 1984. Poisonous plants in Britain and their effects on animals and man. Her Majesty's Stationery Office, London, England. 305 pp.

Huxtable, R. J. 1989. Human health implications of pyrrolizidine alkaloids and herbs containing them. Pages 41-86 in Cheeke, P. R., ed. Toxicants of plant origin. Vol. I. Alkaloids. CRC Press, Inc., Boca Raton, Fla., USA. 335 pp.

Animals/Human Poisoning:

Note: When an animal is listed without additional information, the literature (as of 1993) contained no detailed explanation.

Swine

General symptoms of poisoning:

[breathing, labored](#)
[cyanosis](#)

[methemoglobinemia](#)

Notes on poisoning:

Prickly comfrey is not normally ingested by animals because of the bristly hairs on the leaves. This plant can accumulate nitrates. In Britain, swine were poisoned when given prickly comfrey as green fodder. Symptoms were typical for nitrate poisoning, including apathy, labored breathing, cyanosis, and methemoglobinemia (Cooper and Johnson 1984).

References:

Cooper, M. R., Johnson, A. W. 1984. Poisonous plants in Britain and their effects on animals and man. Her Majesty's Stationery Office, London, England. 305 pp.

[Another search?](#)

[Français](#) | [Contact Us](#) | [Help](#) | [Search](#) | [Canada site](#)

[Coming Events](#) | [About CBIF](#) | [Links](#) | [Reports and Publications](#) | [Home](#)

Date modified: 2003-02-06

[Important Notices](#)



Français	Contact us	Help	Search	Canada site
Coming events	About CBIF	Links	Reports and publications	Home

Canadian Biodiversity Information Facility



Notes on poisoning: prickly lettuce

[Introduction](#)[Interactive](#)[All poisonous plants by Botanical name](#)[All poisonous plants by Common name](#)[Important WWW Poisonous Plants sites](#)

General poisoning notes:

Prickly lettuce (*Lactuca scariola*) is a naturalized herb found across parts of southern Canada. In the western United States, cattle developed pulmonary emphysema after ingesting the plant. The injury appears to be associated with a deficiency, because the toxicity develops after the cattle have fed on dry rangelands. When they are subsequently moved to lush, autumn pasture, some cattle feed ravenously on the prickly lettuce regrowth and, in a few days, the symptoms may develop (Beath et al. 1953).

References:

Beath, O. A., Gilbert, C. S., Eppson, H. F., Rosenfeld, I. 1953. Poisonous plants and livestock poisoning. Wyo. Agric. Exp. Stn. Bull., 324. 94 pp.

Nomenclature:

Scientific Name: *Lactuca scariola* L.

Vernacular name(s): prickly lettuce

Scientific family name: *Compositae*

Vernacular family name: composite

Go to ITIS^{*ca} for more taxonomic information on: [Lactuca scariola](#)

References:

Agriculture Quebec. 1975. Noms des maladies des plantes du Canada/ Names of plant diseases in Canada. , Quebec City, Que., Canada. 288 pp.

Alex, J. F., Cayouette, R., Mulligan, G. A. 1980. Common and

botanical names of weeds in Canada/Noms populaire et scientifiques des plantes nuisibles du Canada. Revised. Agric. Can. Publ., Ottawa, Ont., Canada. 132 pp.

Bailey, L. H., Bailey, E. Z. 1976. Hortus third. Revised. MacMillan, New York, N.Y., USA. 1290 pp.

Scoggan, H. J. 1978, 1979. The flora of Canada. Nat. Mus. Nat. Sci. (Ottawa) Publ. Bot. 7(1)-7(4). 1711 pp.

Van Wijk, H. L. 1911. A dictionary of plant names. Martinus Nijhoff, The Hague, The Netherlands. 1444 pp.

Victorin, M. 1964. Flore Laurentienne. 2nd ed. Univ. Montreal, Montreal, Que., Canada. 952 pp.

Geographic Information

Manitoba
New Brunswick
Nova Scotia
Ontario
Prince Edward Island
Quebec

References:

Bailey, L. H., Bailey, E. Z. 1976. Hortus third. Revised. MacMillan, New York, N.Y., USA. 1290 pp.

Boivin, B. 1966, 1967. Énumération des plantes du Canada. Provencheria 6. Nat. Can. (Que.) 93: 253-274; 371-437; 583-646; 989-1063. 94: 131-157; 471-528; 625-655.

Image or illustration

prickly lettuce:

Images: images.google.com

Notes on Poisonous plant parts:

Mature plants and dried plant material are reported to be harmless. Regrowth of the plants in autumn has caused poisoning in field cases in the western rangelands of the United States (Beath et al. 1953).

Toxic parts:

young shoots

References:

Beath, O. A., Gilbert, C. S., Eppson, H. F., Rosenfeld, I. 1953. Poisonous plants and livestock poisoning. Wyo. Agric. Exp. Stn. Bull., 324. 94 pp.

Toxic plant chemicals:

unknown chemical

References:

Beath, O. A., Gilbert, C. S., Eppson, H. F., Rosenfeld, I. 1953. Poisonous plants and livestock poisoning. Wyo. Agric. Exp. Stn. Bull., 324. 94 pp.

Animals/Human Poisoning:

Note: When an animal is listed without additional information, the literature (as of 1993) contained no detailed explanation.

Cattle

General symptoms of poisoning:

[breathing, labored](#)

[emphysema](#)

[weakness](#)

Notes on poisoning:

Symptoms include pulmonary emphysema, characterized by weakness and difficult breathing. Postmortem examination shows the lung tissue inflamed, with almost complete destruction of the air-cell tissue (Beath et al. 1953).

References:

Beath, O. A., Gilbert, C. S., Eppson, H. F., Rosenfeld, I. 1953. Poisonous plants and livestock poisoning. Wyo. Agric. Exp. Stn. Bull., 324. 94 pp.

[Another search?](#)

[Français](#) | [Contact Us](#) | [Help](#) | [Search](#) | [Canada site](#)

[Coming Events](#) | [About CBIF](#) | [Links](#) | [Reports and Publications](#) | [Home](#)

Date modified: 2003-02-06

[Important Notices](#)



Français	Contact us	Help	Search	Canada site
Coming events	About CBIF	Links	Reports and publications	Home

Canadian Biodiversity Information Facility



Notes on poisoning: primula

[Introduction](#)

[Interactive](#)

[All poisonous plants by Botanical name](#)

[All poisonous plants by Common name](#)

[Important WWW Poisonous Plants sites](#)



General poisoning notes:

Primula (*Primula obconica*) is an ornamental herb that may be grown indoors or outdoors. Sensitized humans develop dermatitis from exposure to the allergen contained in hairs on leaves and other plant parts. Pollen also can cause dermatitis. Some other species of the genus *Primula* can cause dermatitis as well (Mitchell and Rook 1979).

References:

Fernandez De Corr,s, L., Leanizbarrutia, I., Munoz, D., Bernaola, G., Fernandez, E. 1987. Contact dermatitis from a neighbour's primula. *Contact Dermatitis*, 16: 234-235.

Mitchell, J. C., Rook, A. 1979. *Botanical dermatology*. Greenglass Ltd, Vancouver, B.C., Canada. 787 pp.

Spoerke, D. G., Smolinske, S. C. 1990. *Toxicity of houseplants*. CRC Press, Inc., Boca Raton, Fla., USA. 335 pp.

Nomenclature:

Scientific Name: *Primula obconica* Hance.

Vernacular name(s): primula

Scientific family name: *Primulaceae*

Vernacular family name: primrose

References:

Agriculture Quebec. 1975. *Noms des maladies des plantes du Canada/ Names of plant diseases in Canada*. , Quebec City, Que., Canada. 288 pp.

Alex, J. F., Cayouette, R., Mulligan, G. A. 1980. Common and botanical names of weeds in Canada/Noms populaire et scientifiques des plantes nuisibles du Canada. Revised. Agric. Can. Publ., Ottawa, Ont., Canada. 132 pp.

Bailey, L. H., Bailey, E. Z. 1976. Hortus third. Revised. MacMillan, New York, N.Y., USA. 1290 pp.

Scoggan, H. J. 1978, 1979. The flora of Canada. Nat. Mus. Nat. Sci. (Ottawa) Publ. Bot. 7(1)-7(4). 1711 pp.

Van Wijk, H. L. 1911. A dictionary of plant names. Martinus Nijhoff, The Hague, The Netherlands. 1444 pp.

Victorin, M. 1964. Flore Laurentienne. 2nd ed. Univ. Montreal, Montreal, Que., Canada. 952 pp.

Geographic Information

Plant or plant parts used in or around the home.

References:

Bailey, L. H., Bailey, E. Z. 1976. Hortus third. Revised. MacMillan, New York, N.Y., USA. 1290 pp.

Boivin, B. 1966, 1967. Énumération des plantes du Canada. Provencheria 6. Nat. Can. (Que.) 93: 253-274; 371-437; 583-646; 989-1063. 94: 131-157; 471-528; 625-655.

Image or illustration

primula:

Images: images.google.com

Notes on Poisonous plant parts:

Minute glandular hairs accumulate the allergen, which is exuded in tiny drops. The hairs are most common on the leaves but are also found on other plant parts. The pollen grains can also cause dermatitis (Mitchell and Rook 1979).

Toxic parts:

flowers

hairs

leaves

References:

Mitchell, J. C., Rook, A. 1979. Botanical dermatology. Greenglass Ltd, Vancouver, B.C., Canada. 787 pp.

Notes on Toxic plant chemicals:

Primin, a quinone, is the allergen in primula. This chemical is found in minute (0.05-0.3 mm long) glandular hairs. The concentrated allergen accumulates as irregular resinous drops on the hairs. Highly sensitive people may react to 20 micro gm of the allergen. The allergen content of primula is highest between April and August, when grown outdoors (Mitchell and Rook 1979).

Toxic plant chemicals:

primin

References:

Mitchell, J. C., Rook, A. 1979. Botanical dermatology. Greenglass Ltd, Vancouver, B.C., Canada. 787 pp.

Animals/Human Poisoning:

Note: When an animal is listed without additional information, the literature (as of 1993) contained no detailed explanation.

Humans

General symptoms of poisoning:

[blistering](#)

[conjunctivitis](#)

[eczema](#)

[erythema](#)

[fever](#)

References:

Fernandez De Corr,s, L., Leanizbarrutia, I., Munoz, D., Bernaola, G., Fernandez, E. 1987. Contact dermatitis from a neighbour's primula. Contact Dermatitis, 16: 234-235.

[Another search?](#)

[Français](#) | [Contact Us](#) | [Help](#) | [Search](#) | [Canada site](#)
[Coming Events](#) | [About CBIF](#) | [Links](#) | [Reports and Publications](#) |
[Home](#)

Date modified: 2003-02-06

[Important Notices](#)



Français	Contact us	Help	Search	Canada site
Coming events	About CBIF	Links	Reports and publications	Home

Canadian Biodiversity Information Facility



Notes on poisoning: prostrate pigweed

[Introduction](#)

[Interactive](#)

[All poisonous plants by Botanical name](#)

[All poisonous plants by Common name](#)

[Important WWW Poisonous Plants sites](#)

General poisoning notes:

Prostrate pigweed (*Amaranthus blitoides*) is a naturalized herb found across parts of southern Canada. This plant accumulates nitrogen and can cause nitrate poisoning because it can accumulate amounts sufficient to kill cattle (Fuller and McClintock 1986).



References:

Fuller, T. C., McClintock, E. 1986. Poisonous plants of California. Univ. California Press, Berkeley, Calif., USA. 432 pp.

Nomenclature:

Scientific Name: *Amaranthus blitoides* S. Wats.

Vernacular name(s): prostrate pigweed

Scientific family name: *Amaranthaceae*

Vernacular family name: amaranth

Go to ITIS*^{ca} for more taxonomic information on: [Amaranthus blitoides](#)

References:

Agriculture Quebec. 1975. Noms des maladies des plantes du Canada/ Names of plant diseases in Canada. , Quebec City, Que., Canada. 288 pp.

Alex, J. F., Cayouette, R., Mulligan, G. A. 1980. Common and botanical names of weeds in Canada/Noms populaire et scientifiques des plantes nuisibles du Canada. Revised. Agric. Can. Publ., Ottawa, Ont., Canada. 132 pp.

Bailey, L. H., Bailey, E. Z. 1976. Hortus third. Revised. MacMillan, New York, N.Y., USA. 1290 pp.

Scoggan, H. J. 1978, 1979. The flora of Canada. Nat. Mus. Nat. Sci. (Ottawa) Publ. Bot. 7(1)-7(4). 1711 pp.

Van Wijk, H. L. 1911. A dictionary of plant names. Martinus Nijhoff, The Hague, The Netherlands. 1444 pp.

Victorin, M. 1964. Flore Laurentienne. 2nd ed. Univ. Montreal, Montreal, Que., Canada. 952 pp.

Geographic Information

Alberta
British Columbia
Manitoba
Ontario
Quebec
Saskatchewan

References:

Bailey, L. H., Bailey, E. Z. 1976. Hortus third. Revised. MacMillan, New York, N.Y., USA. 1290 pp.

Boivin, B. 1966, 1967. Énumération des plantes du Canada. Provencheria 6. Nat. Can. (Que.) 93: 253-274; 371-437; 583-646; 989-1063. 94: 131-157; 471-528; 625-655.

Image or illustration

prostrate pigweed:

Images: images.google.com

Toxic parts:

leaves

References:

Fuller, T. C., McClintock, E. 1986. Poisonous plants of California. Univ. California Press, Berkeley, Calif., USA. 432 pp.

Toxic plant chemicals:

nitrate

References:

Fuller, T. C., McClintock, E. 1986. Poisonous plants of California. Univ. California Press, Berkeley, Calif., USA. 432 pp.

Animals/Human Poisoning:

Note: When an animal is listed without additional information, the literature (as of 1993) contained no detailed explanation.

Cattle

Swine

[Another search?](#)

[Français](#) | [Contact Us](#) | [Help](#) | [Search](#) | [Canada site](#)

[Coming Events](#) | [About CBIF](#) | [Links](#) | [Reports and Publications](#) | [Home](#)

Date modified: 2003-02-06

[Important Notices](#)



Français	Contact us	Help	Search	Canada site
Coming events	About CBIF	Links	Reports and publications	Home

Canadian Biodiversity Information Facility



Notes on poisoning: purple cockle

[Introduction](#)

[Interactive](#)

[All poisonous plants by Botanical name](#)

[All poisonous plants by Common name](#)

[Important WWW Poisonous Plants sites](#)



General poisoning notes:

Purple cockle (*Agrostemma githago*) is a naturalized herb found across southern Canada. The seeds are contaminants of wheat seeds and they are considered to be poisonous to poultry, cattle, and humans. Human poisoning is rare. Feeding trials have been conducted with ground seeds, which are unappetizing to poultry (Quigley and Waite 1931).

References:

Hardin, J. W., Arena, J. M. 1969. Human poisoning from native and cultivated plants. Duke University Press, Durham, N.C., USA. 167 pp.

Heuser, G. F., Shumacher, A. E. 1942. The feeding of corn cockle to chickens. *Poult. Sci.*, 21:86-93.

Quigley, G. D., Waite, R. H. 1931. Miscellaneous feeding trials with poultry. *Univ. MD. Agric. Exp. Stn. Bull.*, 325: 343-354.

Nomenclature:

Scientific Name: *Agrostemma githago* L.

Vernacular name(s): purple cockle

Scientific family name: *Caryophyllaceae*

Vernacular family name: pink

Go to ITIS^{*ca} for more taxonomic information on: [Agrostemma githago](#)

References:

Agriculture Quebec. 1975. Noms des maladies des plantes du

Canada/ Names of plant diseases in Canada. , Quebec City, Que., Canada. 288 pp.

Alex, J. F., Cayouette, R., Mulligan, G. A. 1980. Common and botanical names of weeds in Canada/Noms populaire et scientifiques des plantes nuisibles du Canada. Revised. Agric. Can. Publ., Ottawa, Ont., Canada. 132 pp.

Bailey, L. H., Bailey, E. Z. 1976. Hortus third. Revised. MacMillan, New York, N.Y., USA. 1290 pp.

Scoggan, H. J. 1978, 1979. The flora of Canada. Nat. Mus. Nat. Sci. (Ottawa) Publ. Bot. 7(1)-7(4). 1711 pp.

Van Wijk, H. L. 1911. A dictionary of plant names. Martinus Nijhoff, The Hague, The Netherlands. 1444 pp.

Victorin, M. 1964. Flore Laurentienne. 2nd ed. Univ. Montreal, Montreal, Que., Canada. 952 pp.

Geographic Information

Alberta
British Columbia
Manitoba
New Brunswick
Nova Scotia
Ontario
Prince Edward Island
Quebec
Saskatchewan

References:

Bailey, L. H., Bailey, E. Z. 1976. Hortus third. Revised. MacMillan, New York, N.Y., USA. 1290 pp.

Boivin, B. 1966, 1967. Énumération des plantes du Canada. Provencheria 6. Nat. Can. (Que.) 93: 253-274; 371-437; 583-646; 989-1063. 94: 131-157; 471-528; 625-655.

Image or illustration

purple cockle:

Images: images.google.com

Toxic parts:

seeds

References:

Heuser, G. F., Shumacher, A. E. 1942. The feeding of corn cockle to chickens. *Poult. Sci.*, 21:86-93.

Quigley, G. D., Waite, R. H. 1931. Miscellaneous feeding trials with poultry. *Univ. MD. Agric. Exp. Stn. Bull.*, 325: 343-354.

Notes on Toxic plant chemicals:

Purple cockle (*Agrostemma githago*) contains the saponin githagin, which is toxic mainly to poultry. The toxin is destroyed in seeds at 50 C. The following quantities have been found to be toxic in experiments with animals:

calf 0.0025% of body weight

poultry 0.0025%

pig 0.0010%

dog 0.0009%

Most feeding experiments have been conducted on chickens (Quigley and Waite 1931; Heuser and Schumacher 1942).

Toxic plant chemicals:

githagin

References:

Heuser, G. F., Shumacher, A. E. 1942. The feeding of corn cockle to chickens. *Poult. Sci.*, 21:86-93.

Animals/Human Poisoning:

Note: When an animal is listed without additional information, the literature (as of 1993) contained no detailed explanation.

Humans

General symptoms of poisoning:

[breathing, shallow](#)

[diarrhea](#)

[dizziness](#)

[stomach cramps](#)

[vomiting](#)

[weakness](#)

Notes on poisoning:

Purple cockle (*Agrostemma githago*) seeds can contaminate wheat because the seeds are difficult to screen. Highly contaminated wheat is unsalable. The seeds are a danger if present in home-ground wheat, corn, or oats (Hardin and Arena 1969).

References:

Hardin, J. W., Arena, J. M. 1969. Human poisoning from native and cultivated plants. Duke University Press, Durham, N.C., USA. 167 pp.

Poultry

General symptoms of poisoning:

[appetite, loss of](#)
[breathing, labored](#)
[death](#)
[diarrhea](#)
[gait, staggering](#)
[heart, cheesy material](#)
[mouth, cheesy material](#)

References:

Heuser, G. F., Shumacher, A. E. 1942. The feeding of corn cockle to chickens. *Poult. Sci.*, 21:86-93.

Quigley, G. D., Waite, R. H. 1931. Miscellaneous feeding trials with poultry. *Univ. MD. Agric. Exp. Stn. Bull.*, 325: 343-354.

[Another search?](#)

[Français](#) | [Contact Us](#) | [Help](#) | [Search](#) | [Canada site](#)
[Coming Events](#) | [About CBIF](#) | [Links](#) | [Reports and Publications](#) | [Home](#)

Date modified: 2003-02-06

[Important Notices](#)



Français	Contact us	Help	Search	Canada site
Coming events	About CBIF	Links	Reports and publications	Home

Canadian Biodiversity Information Facility



Notes on poisoning: purple locoweed

[Introduction](#)

[Interactive](#)

[All poisonous plants by Botanical name](#)

[All poisonous plants by Common name](#)

[Important WWW Poisonous Plants sites](#)



General poisoning notes:

Purple locoweed (*Oxytropis lambertii*) is found in the southern parts of Manitoba and Saskatchewan. This species can cause locoism, a chronic disease that results after long-term grazing. The plant contains swainsonine, an alkaloid, which results in cellular dysfunction through a long biological process. Affected animals show nervous system impairment, with symptoms such as dullness and excitement, as well as immune system impairment. Abortion and congenital birth deformities may occur. Animals affected include cattle, horses, and sheep. Animals may become habituated to locoweed. Death can result (James 1983, Cheeke and Schull 1985).

References:

Cheeke, P. R., Shull, L. R. 1985. Natural toxicants in feeds and poisonous plants. AVI Publishing Company, Inc., Westport, Conn., USA. 492 pp.

James, L. F. 1983. Neurotoxins and other toxins from *Astragalus* and related genera. Pages 445-462 in Keeler, R. F., Tu, A. T., eds. Handbook of natural toxins. Vol. 1. Plant and Fungal toxins. Marcel Dekker, Inc., New York, N.Y., USA. 934 pp.

Nomenclature:

Scientific Name: *Oxytropis lambertii* Pursh

Vernacular name(s): purple locoweed

Scientific family name: *Leguminosae*

Vernacular family name: pea

Go to ITIS*^{ca} for more taxonomic information on: [Oxytropis lambertii](#)

References:

Agriculture Quebec. 1975. Noms des maladies des plantes du Canada/ Names of plant diseases in Canada. , Quebec City, Que., Canada. 288 pp.

Alex, J. F., Cayouette, R., Mulligan, G. A. 1980. Common and botanical names of weeds in Canada/Noms populaire et scientifiques des plantes nuisibles du Canada. Revised. Agric. Can. Publ., Ottawa, Ont., Canada. 132 pp.

Bailey, L. H., Bailey, E. Z. 1976. Hortus third. Revised. MacMillan, New York, N.Y., USA. 1290 pp.

Scoggan, H. J. 1978, 1979. The flora of Canada. Nat. Mus. Nat. Sci. (Ottawa) Publ. Bot. 7(1)-7(4). 1711 pp.

Van Wijk, H. L. 1911. A dictionary of plant names. Martinus Nijhoff, The Hague, The Netherlands. 1444 pp.

Victorin, M. 1964. Flore Laurentienne. 2nd ed. Univ. Montreal, Montreal, Que., Canada. 952 pp.

Geographic Information

Manitoba
Saskatchewan

References:

Bailey, L. H., Bailey, E. Z. 1976. Hortus third. Revised. MacMillan, New York, N.Y., USA. 1290 pp.

Boivin, B. 1966, 1967. Énumération des plantes du Canada. Provencheria 6. Nat. Can. (Que.) 93: 253-274; 371-437; 583-646; 989-1063. 94: 131-157; 471-528; 625-655.

Image or illustration

purple locoweed:

Images: images.google.com

Notes on Poisonous plant parts:

The blooms of locoweeds contain more swainsonine than the leaves. The immature pods contain less swainsonine than the blooms, but this amount increases with the maturity of the seeds (Ralphs et al. 1986).

Toxic parts:

flowers
leaves
mature fruit

References:

James, L. F. 1983. Neurotoxins and other toxins from *Astragalus* and related genera. Pages 445-462 in Keeler, R. F., Tu, A. T., eds. Handbook of natural toxins. Vol. 1. Plant and Fungal toxins. Marcel Dekker, Inc., New York, N.Y., USA. 934 pp.

Ralphs, M. H., James, L. F., Pfister, J. A. 1986. Utilization of white locoweed (*Oxytropis sericea* Nutt.) by range cattle. J. Range Manage., 39: 344-347.

Notes on Toxic plant chemicals:

Swainsonine, an indolizidine alkaloid, inhibits alpha-mannosidase in the animal's body, which results in eventual disruption of cellular function when inhibited (Cheeke and Schull 1985).

Toxic plant chemicals:

swainsonine

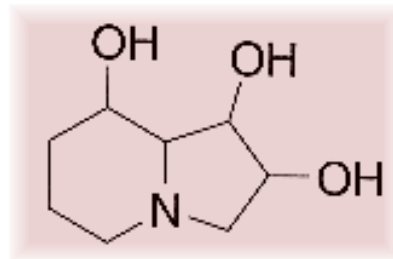

Chemical diagram(s) are courtesy of [Ruth McDiarmid](#), Biochemistry Technician, Kamloops Range Station, Agriculture and Agri-Food Canada, Kamloops, British Columbia, Canada.

References:

James, L. F. 1983. Neurotoxins and other toxins from *Astragalus* and related genera. Pages 445-462 in Keeler, R. F., Tu, A. T., eds. Handbook of natural toxins. Vol. 1. Plant and Fungal toxins. Marcel Dekker, Inc., New York, N.Y., USA. 934 pp.

Animals/Human Poisoning:

Note: When an animal is listed without additional information,

the literature (as of 1993) contained no detailed explanation.

Cattle

General symptoms of poisoning:

[abortion](#)

[agitation](#)

[carpal joint, flexure](#)

[death](#)

[depression](#)

References:

Cheeke, P. R., Shull, L. R. 1985. Natural toxicants in feeds and poisonous plants. AVI Publishing Company, Inc., Westport, Conn., USA. 492 pp.

James, L. F. 1983. Neurotoxins and other toxins from *Astragalus* and related genera. Pages 445-462 in Keeler, R. F., Tu, A. T., eds. Handbook of natural toxins. Vol. 1. Plant and Fungal toxins. Marcel Dekker, Inc., New York, N.Y., USA. 934 pp.

Horses

General symptoms of poisoning:

[agitation](#)

[death](#)

[depression](#)

References:

Cheeke, P. R., Shull, L. R. 1985. Natural toxicants in feeds and poisonous plants. AVI Publishing Company, Inc., Westport, Conn., USA. 492 pp.

Sheep

General symptoms of poisoning:

[abortion](#)

[agitation](#)

[carpal joint, flexure](#)

[death](#)

[incoordination](#)

References:

Cheeke, P. R., Shull, L. R. 1985. Natural toxicants in feeds and poisonous plants. AVI Publishing Company, Inc., Westport, Conn., USA. 492 pp.

[Another search?](#)

[Français](#) | [Contact Us](#) | [Help](#) | [Search](#) | [Canada site](#)

[Coming Events](#) | [About CBIF](#) | [Links](#) | [Reports and Publications](#) |

[Home](#)

Date modified: 2003-02-06

[Important Notices](#)



Français	Contact us	Help	Search	Canada site
Coming events	About CBIF	Links	Reports and publications	Home



Notes on poisoning: radish

[Introduction](#)

[Interactive](#)

[All poisonous plants by Botanical name](#)

[All poisonous plants by Common name](#)

[Important WWW Poisonous Plants sites](#)

General poisoning notes:

Radish (*Raphanus sativus*) is a cultivated plant with the potential for livestock poisoning from SMCO or glucosinolate toxins contained in the leaves and seeds. However, no occurrence was reported in the literature. See general notes under [Brassica oleracea](#) on the effects of these chemicals.

References:

Cheeke, P. R., Shull, L. R. 1985. Natural toxicants in feeds and poisonous plants. AVI Publishing Company, Inc., Westport, Conn., USA. 492 pp.



Nomenclature:

Scientific Name: *Raphanus sativus* L.

Vernacular name(s): radish

Scientific family name: *Cruciferae*

Vernacular family name: mustard

Go to ITIS^{*ca} for more taxonomic information on: [Raphanus sativus](#)

References:

Agriculture Quebec. 1975. Noms des maladies des plantes du Canada/ Names of plant diseases in Canada. , Quebec City, Que., Canada. 288 pp.

Alex, J. F., Cayouette, R., Mulligan, G. A. 1980. Common and botanical names of weeds in Canada/Noms populaire et scientifiques des plantes nuisibles du Canada. Revised. Agric. Can. Publ., Ottawa, Ont., Canada. 132 pp.

Bailey, L. H., Bailey, E. Z. 1976. Hortus third. Revised. MacMillan, New York, N.Y., USA. 1290 pp.

Scoggan, H. J. 1978, 1979. The flora of Canada. Nat. Mus. Nat. Sci. (Ottawa) Publ. Bot. 7(1)-7(4). 1711 pp.

Van Wijk, H. L. 1911. A dictionary of plant names. Martinus Nijhoff, The Hague, The Netherlands. 1444 pp.

Victorin, M. 1964. Flore Laurentienne. 2nd ed. Univ. Montreal, Montreal, Que., Canada. 952 pp.

Geographic Information

References:

Bailey, L. H., Bailey, E. Z. 1976. Hortus third. Revised. MacMillan, New York, N.Y., USA. 1290 pp.

Boivin, B. 1966, 1967. Énumération des plantes du Canada. Provencheria 6. Nat. Can. (Que.) 93: 253-274; 371-437; 583-646; 989-1063. 94: 131-157; 471-528; 625-655.

Image or illustration

radish:

Images: images.google.com

Toxic parts:

leaves

seeds

References:

Cheeke, P. R., Shull, L. R. 1985. Natural toxicants in feeds and poisonous plants. AVI Publishing Company, Inc., Westport, Conn., USA. 492 pp.

Notes on Toxic plant chemicals:

See the general notes under [Brassica oleracea](#) for further discussion of these chemicals.

Toxic plant chemicals:

glucosinolates

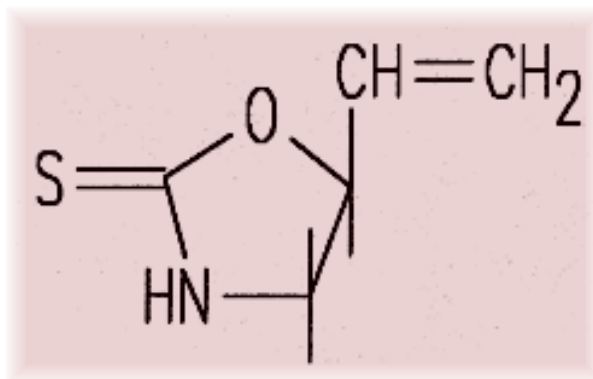

glucosinolates

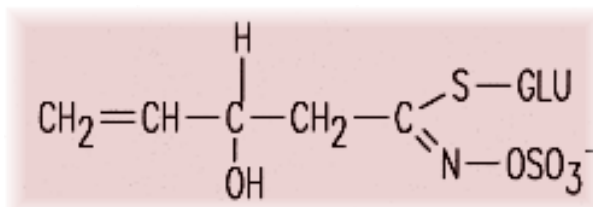

glucosinolates

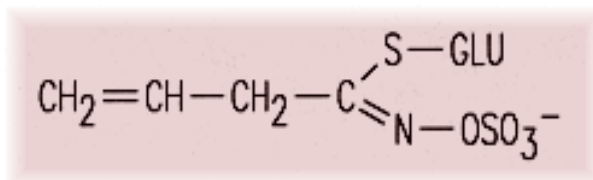

S-methyl-L-cysteine sulfoxide (SMCO)

Chemical diagram(s) are courtesy of [Ruth McDiarmid](#), Biochemistry Technician, Kamloops Range Station, Agriculture and Agri-Food Canada, Kamloops, British Columbia, Canada.

References:

Benevenga, N. J., Case, G. L., Steele, R. D. 1989. Occurrence and metabolism of s-methyl-l-cysteine and s-methyl-l-cysteine sulfoxide in plants and their toxicity and metabolism in animals. Pages 203-228 in Cheeke, P. R., ed. Toxicants of plant origin. Vol. III. Proteins and amino acids. CRC Press, Inc., Boca Raton, Fla., USA. 271 pp.

Cheeke, P. R., Shull, L. R. 1985. Natural toxicants in feeds and poisonous plants. AVI Publishing Company, Inc., Westport, Conn., USA. 492 pp.

Fenwick, G. R., Heaney, R. K., Mawson, R. 1989. Glucosinolates. Pages 1-41 in Cheeke, P. R., ed. Toxicants of plant origin. Vol. II. Glycosides. CRC Press, Inc., Boca Raton, Fla., USA. 277 pp.

Animals/Human Poisoning:

Note: When an animal is listed without additional information, the

literature (as of 1993) contained no detailed explanation.

Cattle

[Another search?](#)

[Français](#) | [Contact Us](#) | [Help](#) | [Search](#) | [Canada site](#)

[Coming Events](#) | [About CBIF](#) | [Links](#) | [Reports and Publications](#) |

[Home](#)

Date modified: 2003-02-06

[Important Notices](#)



Français	Contact us	Help	Search	Canada site
Coming events	About CBIF	Links	Reports and publications	Home

Canadian Biodiversity Information Facility



Notes on poisoning: rapeseed

[Introduction](#)

[Interactive](#)

[All poisonous plants by Botanical name](#)

[All poisonous plants by Common name](#)

[Important WWW Poisonous Plants sites](#)

General poisoning notes:

Rapeseed (*Brassica napus*) meal is used as an additive to livestock feed, but toxicity occurs from glucosinolates and erucic acid, which form in the seeds. Canadian breeders have developed new cultivars called canola, which are low in these compounds (Cheeke and Schull 1985). See discussions under [Brassica oleracea](#) for more information on poisoning by *Brassica* species.

References:



Cheeke, P. R., Shull, L. R. 1985. Natural toxicants in feeds and poisonous plants. AVI Publishing Company, Inc., Westport, Conn., USA. 492 pp.

Kingsbury, J. M. 1964. Poisonous plants of the United States and Canada. Prentice-Hall Inc., Englewood Cliffs, N.J., USA. 626 pp.

Nomenclature:

Scientific Name: *Brassica napus* L.

Vernacular name(s): rapeseed

Scientific family name: *Cruciferae*

Vernacular family name: mustard

Go to ITIS*^{ca} for more taxonomic information on: [Brassica napus](#)

References:

Agriculture Quebec. 1975. Noms des maladies des plantes du Canada/ Names of plant diseases in Canada. , Quebec City, Que., Canada. 288 pp.

Alex, J. F., Cayouette, R., Mulligan, G. A. 1980. Common and

botanical names of weeds in Canada/Noms populaire et scientifiques des plantes nuisibles du Canada. Revised. Agric. Can. Publ., Ottawa, Ont., Canada. 132 pp.

Bailey, L. H., Bailey, E. Z. 1976. Hortus third. Revised. MacMillan, New York, N.Y., USA. 1290 pp.

Scoggan, H. J. 1978, 1979. The flora of Canada. Nat. Mus. Nat. Sci. (Ottawa) Publ. Bot. 7(1)-7(4). 1711 pp.

Van Wijk, H. L. 1911. A dictionary of plant names. Martinus Nijhoff, The Hague, The Netherlands. 1444 pp.

Victorin, M. 1964. Flore Laurentienne. 2nd ed. Univ. Montreal, Montreal, Que., Canada. 952 pp.

Geographic Information

Alberta
British Columbia
Labrador
Manitoba
New Brunswick
Newfoundland
Northwest Territories
Nova Scotia
Ontario
Prince Edward Island
Quebec
Saskatchewan
Yukon Territory

References:

Bailey, L. H., Bailey, E. Z. 1976. Hortus third. Revised. MacMillan, New York, N.Y., USA. 1290 pp.

Boivin, B. 1966, 1967. Énumération des plantes du Canada. Provencheria 6. Nat. Can. (Que.) 93: 253-274; 371-437; 583-646; 989-1063. 94: 131-157; 471-528; 625-655.

Image or illustration

rapeseed:

Images: images.google.com

Notes on Poisonous plant parts:

Rapeseed meal is used as an additive to feeds for livestock. The recent development of canola cultivars allows a much higher amount

of rapeseed meal to be added to diets without toxic affects (Cheeke and Schull 1985).

Toxic parts:

leaves
seeds

References:

Cheeke, P. R., Shull, L. R. 1985. Natural toxicants in feeds and poisonous plants. AVI Publishing Company, Inc., Westport, Conn., USA. 492 pp.

Notes on Toxic plant chemicals:

See the notes under [Brassica oleracea](#) for a discussion on these chemicals, which are common to the genus *Brassica*.

Toxic plant chemicals:

glucosinolates

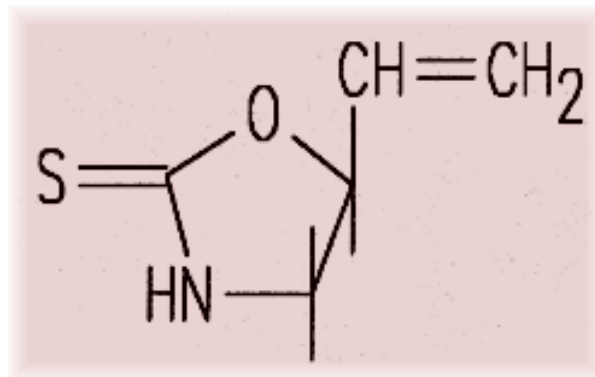

glucosinolates

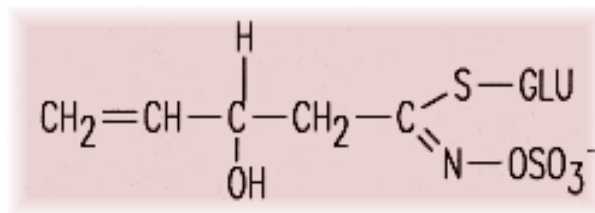

glucosinolates

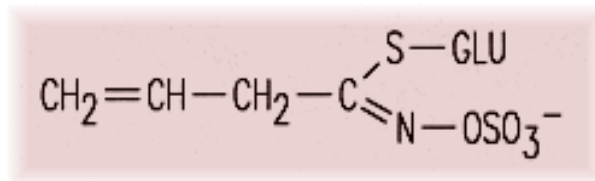

S-methyl-L-cysteine sulfoxide (SMCO)

Chemical diagram(s) are courtesy of [Ruth McDiarmid](#), Biochemistry

Technician, Kamloops Range Station, Agriculture and Agri-Food Canada, Kamloops, British Columbia, Canada.

References:

Cheeke, P. R., Shull, L. R. 1985. Natural toxicants in feeds and poisonous plants. AVI Publishing Company, Inc., Westport, Conn., USA. 492 pp.

Animals/Human Poisoning:

Note: When an animal is listed without additional information, the literature (as of 1993) contained no detailed explanation.

Cattle

Poultry

General symptoms of poisoning:

[liver, congestion of](#)
[thyroid, enlarged](#)
[weight gain, reduced](#)

Notes on poisoning:

Poultry exhibit growth depression and enlarged thyroid glands from ingesting too much rapeseed meal. Perosis, lowered egg production, and off-flavors in eggs also occur (Cheeke and Schull 1985).

References:

Cheeke, P. R., Shull, L. R. 1985. Natural toxicants in feeds and poisonous plants. AVI Publishing Company, Inc., Westport, Conn., USA. 492 pp.

Swine

[Another search?](#)

[Français](#) | [Contact Us](#) | [Help](#) | [Search](#) | [Canada site](#)

[Coming Events](#) | [About CBIF](#) | [Links](#) | [Reports and Publications](#) | [Home](#)

Date modified: 2003-02-06

[Important Notices](#)



Français	Contact us	Help	Search	Canada site
Coming events	About CBIF	Links	Reports and publications	Home

Canadian Biodiversity Information Facility



Notes on poisoning: red chokecherry

[Introduction](#)[Interactive](#)[All poisonous plants by Botanical name](#)[All poisonous plants by Common name](#)[Important WWW Poisonous Plants sites](#)

General poisoning notes:

Chokecherry (*Prunus virginiana*) is a native shrub or small tree found through most of Canada. Children have been poisoned and have died after ingesting large quantities of berries, which contain the seeds. All types of livestock can be poisoned by ingesting the plant material. Cattle and sheep have been poisoned by red chokecherry (Pardee 1847, Kingsbury 1964). Related species, including peach (*Prunus persica*) and apricot (*Prunus armeniaca*), have pits with enough toxin to cause poisoning and death in humans and animals.



References:

Kingsbury, J. M. 1964. Poisonous plants of the United States and Canada. Prentice-Hall Inc., Englewood Cliffs, N.J., USA. 626 pp.

Mulligan, G. A., Munro, D. B. 1981. The biology of Canadian weeds. 51. *Prunus virginiana* L. and *P. serotina* Ehrh. Can. J. Plant Sci., 61: 977-992.

Pardee, G. K. 1847. Case of poisoning by the wild cherry. West. Lancet, 6: 289-291.

Scimeca, J. M., Oehme, F. W. 1985. Postmortem guide to common poisonous plants of livestock. Vet. Hum. Toxicol., 27: 189-199.

Nomenclature:

Scientific Name: *Prunus virginiana* L.

Vernacular name(s): red chokecherry

Scientific family name: *Rosaceae*

Vernacular family name: rose

Go to ITIS*^{ca} for more taxonomic information on: [Prunus virginiana](#)

References:

Agriculture Quebec. 1975. Noms des maladies des plantes du Canada/ Names of plant diseases in Canada. , Quebec City, Que., Canada. 288 pp.

Alex, J. F., Cayouette, R., Mulligan, G. A. 1980. Common and botanical names of weeds in Canada/Noms populaire et scientifiques des plantes nuisibles du Canada. Revised. Agric. Can. Publ., Ottawa, Ont., Canada. 132 pp.

Bailey, L. H., Bailey, E. Z. 1976. Hortus third. Revised. MacMillan, New York, N.Y., USA. 1290 pp.

Scoggan, H. J. 1978, 1979. The flora of Canada. Nat. Mus. Nat. Sci. (Ottawa) Publ. Bot. 7(1)-7(4). 1711 pp.

Van Wijk, H. L. 1911. A dictionary of plant names. Martinus Nijhoff, The Hague, The Netherlands. 1444 pp.

Victorin, M. 1964. Flore Laurentienne. 2nd ed. Univ. Montreal, Montreal, Que., Canada. 952 pp.

Geographic Information

Alberta
British Columbia
Labrador
Manitoba
New Brunswick
Newfoundland
Nova Scotia
Ontario
Prince Edward Island
Quebec
Saskatchewan

References:

Bailey, L. H., Bailey, E. Z. 1976. Hortus third. Revised. MacMillan, New York, N.Y., USA. 1290 pp.

Boivin, B. 1966, 1967. Énumération des plantes du Canada. Provencheria 6. Nat. Can. (Que.) 93: 253-274; 371-437; 583-646; 989-1063. 94: 131-157; 471-528; 625-655.

Image or illustration

red chokecherry:

Images: images.google.com

Notes on Poisonous plant parts:

At all stages of growth, leaves of red chokecherry contained quantities of prunasin that were well above the minimum 1.4% level required for acute poisoning. Twigs also contained levels of prunasin at or above the level required to cause acute poisoning. Twigs developed more toxin during dry years. The prunasin level of buds and flowers was above the minimum level as well (Majak et al. 1981).

Toxic parts:

leaves
seeds
twigs

References:

Majak, W., McDiarmid, R. E., Hall, J. W. 1981. The cyanide potential of Saskatoon serviceberry (*Amelanchier alnifolia*) and chokecherry (*Prunus virginiana*). *Can. J. Anim. Sci.*, 61: 681-686.

Notes on Toxic plant chemicals:

Two cyanogenetic glycosides, amygdalin and prunasin, are found in red chokecherry plant material. Levels of HCN at 143-243 mg have been found in 100 g of leaves. The higher amounts apply to wilted leaves. A lethal dose in cattle occurs after ingesting fresh leaves equivalent to about 0.25% of body weight (Kingsbury 1964, Cheek and Schull 1985).

Toxic plant chemicals:

amygdalin

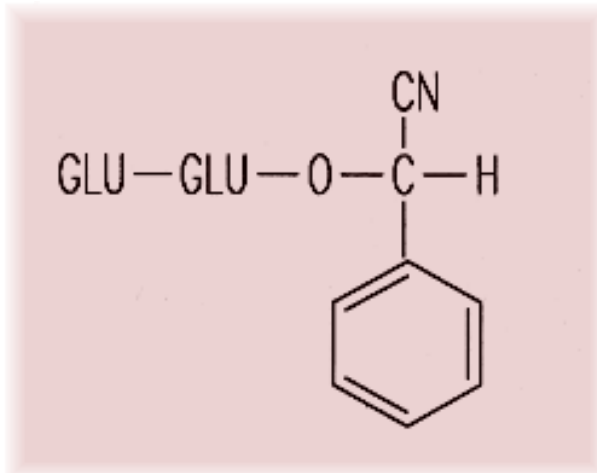

prunasin

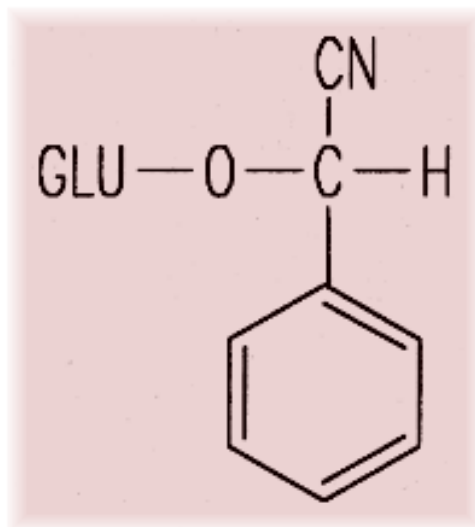

Chemical diagram(s) are courtesy of [Ruth McDiarmid](#), Biochemistry Technician, Kamloops Range Station, Agriculture and Agri-Food Canada, Kamloops, British Columbia, Canada.

References:

Cheeke, P. R., Shull, L. R. 1985. Natural toxicants in feeds and poisonous plants. AVI Publishing Company, Inc., Westport, Conn., USA. 492 pp.

Kingsbury, J. M. 1964. Poisonous plants of the United States and Canada. Prentice-Hall Inc., Englewood Cliffs, N.J., USA. 626 pp.

Animals/Human Poisoning:

Note: When an animal is listed without additional information, the literature (as of 1993) contained no detailed explanation.

Cattle

General symptoms of poisoning:

[agitation](#)

[coma](#)

[convulsions](#)

[death by asphyxiation](#)

[dyspnea](#)

[gait, staggering](#)

Notes on poisoning:

Experimental work on cattle showed that fresh leaves consumed at a rate equivalent to 0.25% of an animal's body weight constitute a lethal dose. Symptoms listed above are applicable to all types of animals. Postmortem findings usually show bright red blood and congested internal organs (Kingsbury 1964, Scimeca and Oehme

1985).

References:

Kingsbury, J. M. 1964. Poisonous plants of the United States and Canada. Prentice-Hall Inc., Englewood Cliffs, N.J., USA. 626 pp.

Scimeca, J. M., Oehme, F. W. 1985. Postmortem guide to common poisonous plants of livestock. *Vet. Hum. Toxicol.*, 27: 189-199.

Humans

General symptoms of poisoning:

[abdominal pains](#)

[babinski reflex](#)

[coma](#)

[convulsions](#)

[cyanosis](#)

[death by asphyxiation](#)

[vomiting](#)

Notes on poisoning:

Ingesting large quantities of red chokecherry fruits, without removing the seeds, has caused illness and death in children. The onset of symptoms is usually sudden and includes abdominal pain, vomiting, convulsions, inability to speak, labored breathing, coma, and death from asphyxiation. The blood is initially bright red because cell respiration is interrupted (Pardee 1847, Kingsbury 1964).

References:

Kingsbury, J. M. 1964. Poisonous plants of the United States and Canada. Prentice-Hall Inc., Englewood Cliffs, N.J., USA. 626 pp.

Pardee, G. K. 1847. Case of poisoning by the wild cherry. *West. Lancet*, 6: 289-291.

Sheep

General symptoms of poisoning:

[coma](#)

[convulsions](#)

[death by asphyxiation](#)

[dyspnea](#)

[paralysis](#)

Notes on poisoning:

See additional information under cattle.

References:

Kingsbury, J. M. 1964. Poisonous plants of the United States and Canada. Prentice-Hall Inc., Englewood Cliffs, N.J., USA. 626 pp.

[Another search?](#)

[Français](#) | [Contact Us](#) | [Help](#) | [Search](#) | [Canada site](#)

[Coming Events](#) | [About CBIF](#) | [Links](#) | [Reports and Publications](#) |

[Home](#)

Date modified: 2003-02-06

[Important Notices](#)



Français	Contact us	Help	Search	Canada site
Coming events	About CBIF	Links	Reports and publications	Home

Canadian Biodiversity Information Facility



Notes on poisoning: red clover

[Introduction](#)[Interactive](#)[All poisonous plants by Botanical name](#)[All poisonous plants by Common name](#)[Important WWW Poisonous Plants sites](#)

General poisoning notes:

Red clover (*Trifolium pratense*) is a common clover that is used in both cultivation for forage and food for animals. It is also widely naturalized across Canada. Ingesting of this plant can cause bloat in animals. This plant is also involved in a condition called **congenital joint laxity and dwarfism**, which occurs sporadically across the northern part of British Columbia, Alberta, and Ontario. This disorder results in teratogenic problems in beef calves when their dams have overwintered exclusively on clover and grass silage. Red clover can also develop phytoestrogens, which affect fertility in livestock (Cheeke and Schull 1985, Ribble et al. 1989).

References:

Cheeke, P. R., Shull, L. R. 1985. Natural toxicants in feeds and poisonous plants. AVI Publishing Company, Inc., Westport, Conn., USA. 492 pp.

Hall, J. W., Majak, W. 1989. Plant and animal factors in legume bloat. Pages 93-106 in Cheeke, P. R., ed. Toxicants of plant origin. Vol. III. Proteins and amino acids. CRC Press, Inc., Boca Raton, Fla., USA. 271 pp.

Ribble, C. S., Janzen, E. D., Proulx, J. G. 1989. Congenital joint laxity and dwarfism: a feed-associated congenital anomaly of beef calves in Canada. Can. Vet. J., 30: 331-338.

Nomenclature:

Scientific Name: *Trifolium pratense* L.

Vernacular name(s): red clover

Scientific family name: *Leguminosae*

Vernacular family name: pea

Go to ITIS^{*ca} for more taxonomic information on: [Trifolium pratense](#)

References:

Agriculture Quebec. 1975. Noms des maladies des plantes du Canada/ Names of plant diseases in Canada. , Quebec City, Que., Canada. 288 pp.

Alex, J. F., Cayouette, R., Mulligan, G. A. 1980. Common and botanical names of weeds in Canada/Noms populaire et scientifiques des plantes nuisibles du Canada. Revised. Agric. Can. Publ., Ottawa, Ont., Canada. 132 pp.

Bailey, L. H., Bailey, E. Z. 1976. Hortus third. Revised. MacMillan, New York, N.Y., USA. 1290 pp.

Scoggan, H. J. 1978, 1979. The flora of Canada. Nat. Mus. Nat. Sci. (Ottawa) Publ. Bot. 7(1)-7(4). 1711 pp.

Van Wijk, H. L. 1911. A dictionary of plant names. Martinus Nijhoff, The Hague, The Netherlands. 1444 pp.

Victorin, M. 1964. Flore Laurentienne. 2nd ed. Univ. Montreal, Montreal, Que., Canada. 952 pp.

Geographic Information

Alberta
British Columbia
Labrador
Manitoba
New Brunswick
Newfoundland
Nova Scotia
Ontario
Prince Edward Island
Quebec
Saskatchewan
Yukon Territory

References:

Bailey, L. H., Bailey, E. Z. 1976. Hortus third. Revised. MacMillan, New York, N.Y., USA. 1290 pp.

Boivin, B. 1966, 1967. Énumération des plantes du Canada. Provencheria 6. Nat. Can. (Que.) 93: 253-274; 371-437; 583-646; 989-1063. 94: 131-157; 471-528; 625-655.

Image or illustration

red clover:

Images: images.google.com

Toxic parts:

all parts

References:

Ribble, C. S., Janzen, E. D., Proulx, J. G. 1989. Congenital joint laxity and dwarfism: a feed-associated congenital anomaly of beef calves in Canada. *Can. Vet. J.*, 30: 331-338.

Notes on Toxic plant chemicals:

Isoflavones, which are glycosides, can occur in red clover. These chemicals are plant estrogens that can cause infertility problems in livestock (Cheeke and Schull 1985).

Toxic plant chemicals:

isoflavones

References:

Cheeke, P. R., Shull, L. R. 1985. *Natural toxicants in feeds and poisonous plants*. AVI Publishing Company, Inc., Westport, Conn., USA. 492 pp.

Animals/Human Poisoning:

Note: When an animal is listed without additional information, the literature (as of 1993) contained no detailed explanation.

Cattle

General symptoms of poisoning:

[bloat](#)

[brachygnatha, superior](#)

[dwarfism](#)

[joint laxity](#)

References:

Cheeke, P. R., Shull, L. R. 1985. Natural toxicants in feeds and poisonous plants. AVI Publishing Company, Inc., Westport, Conn., USA. 492 pp.

Hall, J. W., Majak, W. 1989. Plant and animal factors in legume bloat. Pages 93-106 in Cheeke, P. R., ed. Toxicants of plant origin. Vol. III. Proteins and amino acids. CRC Press, Inc., Boca Raton, Fla., USA. 271 pp.

Ribble, C. S., Janzen, E. D., Proulx, J. G. 1989. Congenital joint laxity and dwarfism: a feed-associated congenital anomaly of beef calves in Canada. Can. Vet. J., 30: 331-338.

[Another search?](#)

[Français](#) | [Contact Us](#) | [Help](#) | [Search](#) | [Canada site](#)

[Coming Events](#) | [About CBIF](#) | [Links](#) | [Reports and Publications](#) | [Home](#)

Date modified: 2003-02-06

[Important Notices](#)



Français	Contact us	Help	Search	Canada site
Coming events	About CBIF	Links	Reports and publications	Home

Canadian Biodiversity Information Facility



Notes on poisoning: red maple

[Introduction](#)[Interactive](#)[All poisonous plants by Botanical name](#)[All poisonous plants by Common name](#)[Important WWW Poisonous Plants sites](#)

General poisoning notes:

Red maple (*Acer rubrum*) is a native tree found in eastern Canada. Leaves of this plant have poisoned horses in the New England States and Georgia. Divers et al. (1982) noted that three of four horses died in one case. Experimental symptoms of hemolytic anemia indistinguishable from the field case were induced in a pony. This problem should be suspected in horses in which acute hemolytic anemia occurs after they ingest red maple leaves.

Horses are poisoned sporadically in the northeastern United States after they ingest red maple leaves. Signs of toxicity are similar to those seen with the *Brassica* anemia factor after animals ingest plants of the genus *Brassica* (such as canola, kale, cabbage). Tennant et al. (1981) noted 33 cases of hemolytic anemia in horses in the New England States in the late 1970s. These cases were attributed to red maple leaves.

References:

Cheeke, P. R., Shull, L. R. 1985. Natural toxicants in feeds and poisonous plants. AVI Publishing Company, Inc., Westport, Conn., USA. 492 pp.

Divers, T. J., George, L. W., George, J. W. 1982. Hemolytic anemia in horses after the ingestion of red maple leaves. *Toxicology*, 180: 300-302.

George, L. W., Divers, T. J., Mahaffey, E. A., Suarez, M. J. 1982. Heinz body anemia and methemoglobinemia in ponies given red maple (*Acer rubrum* L.) leaves. *Vet. Pathol.*, 19: 521-533.

Long, P. H., Payne, J. W. 1984. Red maple-associated pulmonary thrombosis in a horse. *J. Am. Vet. Med. Assoc.*, 184: 977-978.

Plumlee, K. H. 1991. Red maple toxicity in a horse. *Vet. Hum. Toxicol.*, 33: 66-67.

Tennant, B., Dill, S. G., Glickman, L. T., Mirro, E. J., King, J. M., Polak, D. M., Smith, M. C., Kradel, D. C. 1981. Acute hemolytic anemia, methemoglobinemia, and Heinz body formation associated with ingestion of red maple leaves by horses. J. Am. Vet. Med. Assoc., 179: 143-150.

Nomenclature:

Scientific Name: *Acer rubrum* L.

Vernacular name(s): red maple

Scientific family name: *Aceraceae*

Vernacular family name: maple

Go to ITIS^{*ca} for more taxonomic information on: [Acer rubrum](#)

References:

Agriculture Quebec. 1975. Noms des maladies des plantes du Canada/ Names of plant diseases in Canada. , Quebec City, Que., Canada. 288 pp.

Alex, J. F., Cayouette, R., Mulligan, G. A. 1980. Common and botanical names of weeds in Canada/Noms populaire et scientifiques des plantes nuisibles du Canada. Revised. Agric. Can. Publ., Ottawa, Ont., Canada. 132 pp.

Bailey, L. H., Bailey, E. Z. 1976. Hortus third. Revised. MacMillan, New York, N.Y., USA. 1290 pp.

Scoggan, H. J. 1978, 1979. The flora of Canada. Nat. Mus. Nat. Sci. (Ottawa) Publ. Bot. 7(1)-7(4). 1711 pp.

Van Wijk, H. L. 1911. A dictionary of plant names. Martinus Nijhoff, The Hague, The Netherlands. 1444 pp.

Victorin, M. 1964. Flore Laurentienne. 2nd ed. Univ. Montreal, Montreal, Que., Canada. 952 pp.

Geographic Information

New Brunswick
Newfoundland
Nova Scotia
Ontario
Prince Edward Island
Quebec

References:

Bailey, L. H., Bailey, E. Z. 1976. Hortus third. Revised. MacMillan, New York, N.Y., USA. 1290 pp.

Boivin, B. 1966, 1967. Énumération des plantes du Canada. Provencheria 6. Nat. Can. (Que.) 93: 253-274; 371-437; 583-646; 989-1063. 94: 131-157; 471-528; 625-655.

Image or illustration

red maple:

Images: images.google.com

Notes on Poisonous plant parts:

The wilted leaves of red maple (*Acer rubrum*) have caused poisoning and death in horses. This toxicity is most prevalent from June through October. Cases become symptomatic 3-4 days after ingesting the leaves (Divers et al. 1982).

Wilted leaves administered to a pony at the rate of 3.0 g/kg of body weight caused illness and death within 1-5 days. Freshly harvested leaves did not cause any symptoms. Dried leaves remained toxic for 30 days (George et al. 1982).

Toxic parts:

leaves

References:

Cheeke, P. R., Shull, L. R. 1985. Natural toxicants in feeds and poisonous plants. AVI Publishing Company, Inc., Westport, Conn., USA. 492 pp.

Divers, T. J., George, L. W., George, J. W. 1982. Hemolytic anemia in horses after the ingestion of red maple leaves. Toxicology, 180: 300-302.

George, L. W., Divers, T. J., Mahaffey, E. A., Suarez, M. J. 1982. Heinz body anemia and methemoglobinemia in ponies given red maple (*Acer rubrum* L.) leaves. Vet. Pathol., 19: 521-533.

Long, P. H., Payne, J. W. 1984. Red maple-associated pulmonary thrombosis in a horse. J. Am. Vet. Med. Assoc., 184: 977-978.

Plumlee, K. H. 1991. Red maple toxicity in a horse. Vet. Hum. Toxicol., 33: 66-67.

Tennant, B., Dill, S. G., Glickman, L. T., Mirro, E. J., King, J.

M., Polak, D. M., Smith, M. C., Kradel, D. C. 1981. Acute hemolytic anemia, methemoglobinemia, and Heinz body formation associated with ingestion of red maple leaves by horses. J. Am. Vet. Med. Assoc., 179: 143-150.

Notes on Toxic plant chemicals:

The chemical that causes hemolytic anemia poisoning in horses is not yet known for red maple (*Acer rubrum*). The chemical probably works as an oxidant. In Georgia, ponies poisoned by red maple leaves died rapidly when fed dried leaves after mid September, whereas ponies fed leaves collected earlier in the summer had a more prolonged illness. This finding suggests that the toxin increases in quantity during autumn (George et al. 1982).

Toxic plant chemicals:

unknown chemical

References:

George, L. W., Divers, T. J., Mahaffey, E. A., Suarez, M. J. 1982. Heinz body anemia and methemoglobinemia in ponies given red maple (*Acer rubrum* L.) leaves. Vet. Pathol., 19: 521-533.

Tennant, B., Dill, S. G., Glickman, L. T., Mirro, E. J., King, J. M., Polak, D. M., Smith, M. C., Kradel, D. C. 1981. Acute hemolytic anemia, methemoglobinemia, and Heinz body formation associated with ingestion of red maple leaves by horses. J. Am. Vet. Med. Assoc., 179: 143-150.

Animals/Human Poisoning:

Note: When an animal is listed without additional information, the literature (as of 1993) contained no detailed explanation.

Horses

General symptoms of poisoning:

[anorexia](#)

[blood brownish](#)

[brain, vacuolation of](#)

[breathing, rapid](#)

[coma](#)

[cyanosis](#)

[death](#)

[dehydration](#)
[depression](#)
[heart rate, elevated](#)
[Heinz bodies](#)
[hemoglobinuria](#)
[icterus](#)
[kidney, edema of](#)
[lungs, congestion of](#)
[lungs, thrombosis of](#)
[mucous membrane, brown](#)
[nephrosis, severe](#)
[urine, brownish](#)
[weakness](#)

References:

Divers, T. J., George, L. W., George, J. W. 1982. Hemolytic anemia in horses after the ingestion of red maple leaves. *Toxicology*, 180: 300-302.

George, L. W., Divers, T. J., Mahaffey, E. A., Suarez, M. J. 1982. Heinz body anemia and methemoglobinemia in ponies given red maple (*Acer rubrum* L.) leaves. *Vet. Pathol.*, 19: 521-533.

Long, P. H., Payne, J. W. 1984. Red maple-associated pulmonary thrombosis in a horse. *J. Am. Vet. Med. Assoc.*, 184: 977-978.

Plumlee, K. H. 1991. Red maple toxicity in a horse. *Vet. Hum. Toxicol.*, 33: 66-67.

[Another search?](#)

[Français](#) | [Contact Us](#) | [Help](#) | [Search](#) | [Canada site](#)

[Coming Events](#) | [About CBIF](#) | [Links](#) | [Reports and Publications](#) |

[Home](#)

Date modified: 2003-02-06

[Important Notices](#)



Français	Contact us	Help	Search	Canada site
Coming events	About CBIF	Links	Reports and publications	Home

Canadian Biodiversity Information Facility



Notes on poisoning: red oak

[Introduction](#)[Interactive](#)[All poisonous plants by Botanical name](#)[All poisonous plants by Common name](#)[Important WWW Poisonous Plants sites](#)

General poisoning notes:

Red oak (*Quercus rubra*) is a native tree found in eastern Canada. This plant contains toxic tannins that have caused poisoning and death in cattle and horses. Sheep may have also been poisoned by this oak. Poisoning can lead to depression, anorexia, loss of condition, and kidney damage. Kidney failure usually results in death (Duncan 1961, Cockerill and Beasley 1979).



References:

Cockrill, J. M., Beasley, J. N. 1979. Renal damage to cattle during acorn poisoning. *Vet. Med. Small Anim. Clin.*, 74: 82, 84-85.

Duncan, C. S. 1961. Oak leaf poisoning in two horses. *Cornell Vet.*, 51: 159-162.

Nomenclature:

Scientific Name: *Quercus rubra* L.

Vernacular name(s): red oak

Scientific family name: *Fagaceae*

Vernacular family name: beech

Go to ITIS^{*ca} for more taxonomic information on: [Quercus rubra](#)

References:

Agriculture Quebec. 1975. Noms des maladies des plantes du Canada/ Names of plant diseases in Canada. , Quebec City, Que., Canada. 288 pp.

Alex, J. F., Cayouette, R., Mulligan, G. A. 1980. Common and

botanical names of weeds in Canada/Noms populaire et scientifiques des plantes nuisibles du Canada. Revised. Agric. Can. Publ., Ottawa, Ont., Canada. 132 pp.

Bailey, L. H., Bailey, E. Z. 1976. Hortus third. Revised. MacMillan, New York, N.Y., USA. 1290 pp.

Scoggan, H. J. 1978, 1979. The flora of Canada. Nat. Mus. Nat. Sci. (Ottawa) Publ. Bot. 7(1)-7(4). 1711 pp.

Van Wijk, H. L. 1911. A dictionary of plant names. Martinus Nijhoff, The Hague, The Netherlands. 1444 pp.

Victorin, M. 1964. Flore Laurentienne. 2nd ed. Univ. Montreal, Montreal, Que., Canada. 952 pp.

Geographic Information

New Brunswick
Nova Scotia
Ontario
Prince Edward Island
Quebec

References:

Bailey, L. H., Bailey, E. Z. 1976. Hortus third. Revised. MacMillan, New York, N.Y., USA. 1290 pp.

Boivin, B. 1966, 1967. Énumération des plantes du Canada. Provencheria 6. Nat. Can. (Que.) 93: 253-274; 371-437; 583-646; 989-1063. 94: 131-157; 471-528; 625-655.

Image or illustration

red oak:

Images: images.google.com

Notes on Poisonous plant parts:

The leaves and acorns are toxic. The immature acorns contain more toxin than the mature acorns (Cockrill and Beasley 1979).

Toxic parts:

acorns
immature fruit
leaves

References:

Cockrill, J. M., Beasley, J. N. 1979. Renal damage to cattle during acorn poisoning. *Vet. Med. Small Anim. Clin.*, 74: 82, 84-85.

Notes on Toxic plant chemicals:

The toxic agents are polyhydroxyphenolic compounds (tannins) including gallic acid, pyrogallol, and tannic acid. The concentration of these compounds is higher in immature, green acorns than in mature ones. The following quantities of phenolics were found in acorns (Basden and Dalvi 1987):

Oak species	Total phenolics (% of total weight)
Quercus alba (white oak)	1.09 (0.41-2.54)
Quercus rubra (red oak)	3.72
Quercus velutina (black oak)	4.51 (3.29-6.13)

Black oak and red oak contain a greater total average of phenolics in the acorns does than white oak.

Toxic plant chemicals:

gallic acid
pyrogallol
tannic acid

References:

Basden, K. W., Dalvi, R. R. 1987. Determination of total phenolics in acorns from different species of oak trees in conjunction with acorn poisoning in cattle. *Vet. Hum. Toxicol.*, 29: 305-306.

Animals/Human Poisoning:

Note: When an animal is listed without additional information, the literature (as of 1993) contained no detailed explanation.

Cattle

General symptoms of poisoning:

[anorexia](#)

[constipation](#)

[depression](#)

[kidney failure](#)

[teeth grinding](#)

Notes on poisoning:

Cattle that ingest a small number of acorns may show some loss of condition. However, they often develop a preference for eating the acorns. Toxic amounts cause depression, anorexia, constipation, the passing of small fecal balls covered in mucous and blood, teeth grinding, and submandibular edema. Death is usually caused by kidney failure. Postmortem findings reveal a large number of acorns in the rumen, gastroenteritis in the caudal portion of the digestive tract, and small, shrunken kidneys with diminished reserve capacity. If renal stress occurs, the reserve function of the kidney may be exceeded. Perirenal edema and hemorrhagic enteritis were the prominent lesions. Multifocal necrosis of the proximal convoluted tubules of the kidney is characteristic (Sandusky et al. 1977, Cockrill and Beasley 1979).

References:

Cockrill, J. M., Beasley, J. N. 1979. Renal damage to cattle during acorn poisoning. *Vet. Med. Small Anim. Clin.*, 74: 82, 84-85.

Horses

General symptoms of poisoning:

[abdominal pains](#)

[anorexia](#)

[colic](#)

[constipation](#)

[depression](#)

[diarrhea](#)

[hematuria](#)

[icterus](#)

Notes on poisoning:

Horses that ingested leaves of red oak developed symptoms of depression, anorexia, abdominal pain, constipation, slight icterus, hematuria, edema, and weakness. The symptoms occurred 6-9 days after ingestion. Blood transfusions were thought to speed recovery (Duncan 1961).

References:

Duncan, C. S. 1961. Oak leaf poisoning in two horses. Cornell Vet., 51: 159-162.

Sheep

[Another search?](#)

[Français](#) | [Contact Us](#) | [Help](#) | [Search](#) | [Canada site](#)

[Coming Events](#) | [About CBIF](#) | [Links](#) | [Reports and Publications](#) |

[Home](#)

Date modified: 2003-02-06

[Important Notices](#)



Français	Contact us	Help	Search	Canada site
Coming events	About CBIF	Links	Reports and publications	Home

Canadian Biodiversity Information Facility



Notes on poisoning: redroot pigweed

[Introduction](#)

[Interactive](#)

[All poisonous plants by Botanical name](#)

[All poisonous plants by Common name](#)

[Important WWW Poisonous Plants sites](#)



General poisoning notes:

Redroot pigweed (*Amaranthus retroflexus*) is a naturalized herb that is found across much of Canada. This plant can cause a variety of toxic problems, including perirenal edema in pigs. However, the nature of the toxic compound is not known. This plant can also accumulate oxalates to as much as 30% of dry weight. Redroot pigweed is capable of accumulating toxic concentrations of nitrates (Osweiler et al. 1985).

References:

Crawford, R. F., Kennedy, W. K., Davison, K. L. 1966. Factors influencing the toxicity of forages that contain nitrate when fed to cattle. *Cornell Vet.*, 56: 3-17.

Duckworth, R. H. 1975. Poisoning of cattle by *Amaranthus*. *N. Z. Vet. J.*, 23: 154-155.

Hibbs, C. M., Stencel, E. L., Hill, R. M. 1978. Nitrate toxicosis in cattle. *Vet. Hum. Toxicol.*, 20: 1-2.

Osweiler, G. D., Buck, W. B., Bicknell, E. J. 1969. Production of perirenal edema in swine with *Amaranthus retroflexus*. *Am. J. Vet. Res.*, 30: 557-566.

Osweiler, G. D., Carson, T. L., Buck, W. B., Van Gelder, G. A. 1985. *Clinical and diagnostic veterinary toxicology*. Third edition. Kendall/Hunt Publishing Co., Dubuque, Iowa, USA. 494 pp.

Scimeca, J. M., Oehme, F. W. 1985. Postmortem guide to common poisonous plants of livestock. *Vet. Hum. Toxicol.*, 27: 189-199.

Stuart, B. P., Nicholson, S. S., Smith, J. B. 1975. Perirenal edema and toxic nephrosis in cattle, associated with ingestion of pigweed. *J. Am. Vet. Med. Assoc.*, 167: 949-950.

Nomenclature:

Scientific Name: *Amaranthus retroflexus* L.

Vernacular name(s): redroot pigweed

Scientific family name: *Amaranthaceae*

Vernacular family name: amaranth

Go to ITIS^{*ca} for more taxonomic information on: [Amaranthus retroflexus](#)

References:

Agriculture Quebec. 1975. Noms des maladies des plantes du Canada/ Names of plant diseases in Canada. , Quebec City, Que., Canada. 288 pp.

Alex, J. F., Cayouette, R., Mulligan, G. A. 1980. Common and botanical names of weeds in Canada/Noms populaire et scientifiques des plantes nuisibles du Canada. Revised. Agric. Can. Publ., Ottawa, Ont., Canada. 132 pp.

Bailey, L. H., Bailey, E. Z. 1976. Hortus third. Revised. MacMillan, New York, N.Y., USA. 1290 pp.

Scoggan, H. J. 1978, 1979. The flora of Canada. Nat. Mus. Nat. Sci. (Ottawa) Publ. Bot. 7(1)-7(4). 1711 pp.

Van Wijk, H. L. 1911. A dictionary of plant names. Martinus Nijhoff, The Hague, The Netherlands. 1444 pp.

Victorin, M. 1964. Flore Laurentienne. 2nd ed. Univ. Montreal, Montreal, Que., Canada. 952 pp.

Geographic Information

Alberta
British Columbia
Manitoba
New Brunswick
Northwest Territories
Nova Scotia
Ontario
Prince Edward Island
Quebec
Saskatchewan

References:

Bailey, L. H., Bailey, E. Z. 1976. Hortus third. Revised.

MacMillan, New York, N.Y., USA. 1290 pp.

Boivin, B. 1966, 1967. Énumération des plantes du Canada. Provencheria 6. Nat. Can. (Que.) 93: 253-274; 371-437; 583-646; 989-1063. 94: 131-157; 471-528; 625-655.

Image or illustration

redroot pigweed:

Images: images.google.com

Toxic parts:

leaves

stems

References:

Osweiler, G. D., Buck, W. B., Bicknell, E. J. 1969. Production of perirenal edema in swine with *Amaranthus retroflexus*. Am. J. Vet. Res., 30: 557-566.

Stuart, B. P., Nicholson, S. S., Smith, J. B. 1975. Perirenal edema and toxic nephrosis in cattle, associated with ingestion of pigweed. J. Am. Vet. Med. Assoc., 167: 949-950.

Notes on Toxic plant chemicals:

Nitrates have the following LD-50 values (Crawford et al. 1966):

LD-50 1.0 g/kg body weight in cattle

LD-50 0.5 g/kg body weight in other ruminants.

Acute poisoning occurs when forage nitrates exceed 1.0% nitrate (dry weight) or 1500 ppm in water (Osweiler et al. 1985). All *Amaranthus* spp. mentioned in this information system can accumulate toxic quantities of nitrates.

Toxic plant chemicals:

nitrate

References:

Crawford, R. F., Kennedy, W. K., Davison, K. L. 1966. Factors influencing the toxicity of forages that contain nitrate when fed to cattle. Cornell Vet., 56: 3-17.

Animals/Human Poisoning:

Note: When an animal is listed without additional information, the literature (as of 1993) contained no detailed explanation.

Cattle

General symptoms of poisoning:

[abortion](#)

[bloat](#)

[blood brownish](#)

[breathing, rapid](#)

[death](#)

[dyspnea](#)

[kidney, edema of](#)

[mucous membrane, brown](#)

[nephrosis, severe](#)

[nervousness](#)

[recumbency](#)

[recumbency, ventral](#)

[regurgitation](#)

[weakness, posterior](#)

References:

Crawford, R. F., Kennedy, W. K., Davison, K. L. 1966. Factors influencing the toxicity of forages that contain nitrate when fed to cattle. *Cornell Vet.*, 56: 3-17.

Duckworth, R. H. 1975. Poisoning of cattle by *Amaranthus*. *N. Z. Vet. J.*, 23: 154-155.

Hibbs, C. M., Stencel, E. L., Hill, R. M. 1978. Nitrate toxicosis in cattle. *Vet. Hum. Toxicol.*, 20: 1-2.

Stuart, B. P., Nicholson, S. S., Smith, J. B. 1975. Perirenal edema and toxic nephrosis in cattle, associated with ingestion of pigweed. *J. Am. Vet. Med. Assoc.*, 167: 949-950.

Swine

General symptoms of poisoning:

[ataxia](#)

[death](#)

[gait, crouching](#)

[kidney, edema of](#)

[nephrosis, severe](#)
[recumbency, ventral](#)
[trembling](#)
[weakness](#)

References:

Oswailer, G. D., Buck, W. B., Bicknell, E. J. 1969. Production of perirenal edema in swine with *Amaranthus retroflexus*. Am. J. Vet. Res., 30: 557-566.

Scimeca, J. M., Oehme, F. W. 1985. Postmortem guide to common poisonous plants of livestock. Vet. Hum. Toxicol., 27: 189-199.

[Another search?](#)

[Français](#) | [Contact Us](#) | [Help](#) | [Search](#) | [Canada site](#)

[Coming Events](#) | [About CBIF](#) | [Links](#) | [Reports and Publications](#) | [Home](#)

Date modified: 2003-02-06

[Important Notices](#)



Français	Contact us	Help	Search	Canada site
Coming events	About CBIF	Links	Reports and publications	Home

Canadian Biodiversity Information Facility



Notes on poisoning: reed canarygrass

[Introduction](#)[Interactive](#)[All poisonous plants by Botanical name](#)[All poisonous plants by Common name](#)[Important WWW Poisonous Plants sites](#)

General poisoning notes:

Reed canarygrass (*Phalaris arundinacea*) is cultivated and has also escaped across much of southern Canada. The plant grows well in poorly drained soils subject to prolonged flooding. The plant has caused animal performance lower than the nutritional composition of the plant suggests. Sheep in New Zealand exhibited Phalaris staggers, which includes distress, convulsions, and death. No cases of this have been reported in North America (Majak et al. 1979, Cheeke and Schull 1985).

References:

Cheeke, P. R., Shull, L. R. 1985. Natural toxicants in feeds and poisonous plants. AVI Publishing Company, Inc., Westport, Conn., USA. 492 pp.

Corcuera, L. J. 1989. Indole alkaloids from *Phalaris* and other gramineae. Pages 169-177 in Cheeke, P. R., ed. Toxicants of plant origin. Vol. I. Alkaloids. CRC Press, Inc., Boca Raton, Fla., USA. 335 pp.

Nomenclature:

Scientific Name: *Phalaris arundinacea* L.

Vernacular name(s): reed canarygrass

Scientific family name: *Gramineae*

Vernacular family name: grass

Go to ITIS*^{ca} for more taxonomic information on: [Phalaris arundinacea](#)

References:

Agriculture Quebec. 1975. Noms des maladies des plantes du Canada/ Names of plant diseases in Canada. , Quebec City, Que., Canada. 288 pp.

Alex, J. F., Cayouette, R., Mulligan, G. A. 1980. Common and botanical names of weeds in Canada/Noms populaire et scientifiques des plantes nuisibles du Canada. Revised. Agric. Can. Publ., Ottawa, Ont., Canada. 132 pp.

Bailey, L. H., Bailey, E. Z. 1976. Hortus third. Revised. MacMillan, New York, N.Y., USA. 1290 pp.

Scoggan, H. J. 1978, 1979. The flora of Canada. Nat. Mus. Nat. Sci. (Ottawa) Publ. Bot. 7(1)-7(4). 1711 pp.

Van Wijk, H. L. 1911. A dictionary of plant names. Martinus Nijhoff, The Hague, The Netherlands. 1444 pp.

Victorin, M. 1964. Flore Laurentienne. 2nd ed. Univ. Montreal, Montreal, Que., Canada. 952 pp.

Geographic Information

Alberta
British Columbia
Manitoba
New Brunswick
Newfoundland
Northwest Territories
Nova Scotia
Ontario
Prince Edward Island
Quebec
Saskatchewan

References:

Bailey, L. H., Bailey, E. Z. 1976. Hortus third. Revised. MacMillan, New York, N.Y., USA. 1290 pp.

Boivin, B. 1966, 1967. Énumération des plantes du Canada. Provencheria 6. Nat. Can. (Que.) 93: 253-274; 371-437; 583-646; 989-1063. 94: 131-157; 471-528; 625-655.

Image or illustration

reed canarygrass:

Images: images.google.com

Toxic parts:

leaves

References:

Corcuera, L. J. 1989. Indole alkaloids from *Phalaris* and other gramineae. Pages 169-177 in Cheeke, P. R., ed. Toxicants of plant origin. Vol. I. Alkaloids. CRC Press, Inc., Boca Raton, Fla., USA. 335 pp.

Notes on Toxic plant chemicals:

Several indole alkaloids are found in reed canarygrass, including hordenine, gramine and 5-methoxy-N-methyltryptamine. Other indole alkaloids were also found. In the interior of British Columbia the concentration of the latter two was found to increase towards the end of the growing season. Differences were also found in various cultivars. Cultural practices and environmental factors such as moisture stress may also increase the amount of alkaloids (Majak et al. 1979, Corcuera 1989).

Toxic plant chemicals:

gramine
hordenine
5MMethyltryptamine

References:

Corcuera, L. J. 1989. Indole alkaloids from *Phalaris* and other gramineae. Pages 169-177 in Cheeke, P. R., ed. Toxicants of plant origin. Vol. I. Alkaloids. CRC Press, Inc., Boca Raton, Fla., USA. 335 pp.

Animals/Human Poisoning:

Note: When an animal is listed without additional information, the literature (as of 1993) contained no detailed explanation.

Cattle

General symptoms of poisoning:

[convulsions](#)

[death](#)

[incoordination](#)

[muscle spasms](#)

[weight gain, reduced](#)

Notes on poisoning:

Sheep in New Zealand have developed *Phalaris* staggers. Symptoms include incoordination, stiff stilted gait, muscle spasms, convulsions, recumbency, and death. Similar symptoms have not been recorded in North America. Gross lesions are found in the nervous system, including gray to blue discoloration of the brain stem and yellow brown granules in the cytoplasm of nerve cells (Cheeke and Schull 1985).

References:

Corcuera, L. J. 1989. Indole alkaloids from *Phalaris* and other gramineae. Pages 169-177 in Cheeke, P. R., ed. Toxicants of plant origin. Vol. I. Alkaloids. CRC Press, Inc., Boca Raton, Fla., USA. 335 pp.

Sheep

General symptoms of poisoning:

[coma](#)

References:

Cheeke, P. R., Shull, L. R. 1985. Natural toxicants in feeds and poisonous plants. AVI Publishing Company, Inc., Westport, Conn., USA. 492 pp.

[Another search?](#)

[Français](#) | [Contact Us](#) | [Help](#) | [Search](#) | [Canada site](#)

[Coming Events](#) | [About CBIF](#) | [Links](#) | [Reports and Publications](#) |

[Home](#)

Date modified: 2003-02-06

[Important Notices](#)



Français	Contact us	Help	Search	Canada site
Coming events	About CBIF	Links	Reports and publications	Home

Canadian Biodiversity Information Facility



Notes on poisoning: rhubarb

[Introduction](#)

[Interactive](#)

[All poisonous plants by Botanical name](#)

[All poisonous plants by Common name](#)

[Important WWW Poisonous Plants sites](#)



General poisoning notes:

Rhubarb (*Rheum rhaponticum*) is a perennial cultivated plant that persists around old farm sites. The plant contains oxalate crystals, which have been reported to cause poisoning when large quantities of raw or cooked leaves are ingested. Anthraquinones (glycosides) have been implicated more recently in the poisoning. The stalks are widely used as preserves and are also eaten raw, without problems. The toxic content is much lower in the stalks. Humans have been poisoned after ingesting the leaves. Human poisoning was a particular problem in World War I, when the leaves were recommended as a food source in Britain. Some animals, including goats and swine, have also been poisoned by ingesting the leaves. Children should be taught to eat only the rhubarb stalks, preferably under supervision (Robb 1919; Cooper and Johnson 1984).

References:

Cooper, M. R., Johnson, A. W. 1984. Poisonous plants in Britain and their effects on animals and man. Her Majesty's Stationery Office, London, England. 305 pp.

Robb, H. F. 1919. Death from rhubarb leaves due to oxalic acid poisoning. J. Am. Med. Assoc., 73: 627-628.

Spoerke, D. G., Smolinske, S. C. 1990. Toxicity of houseplants. CRC Press, Inc., Boca Raton, Fla., USA. 335 pp.

Nomenclature:

Scientific Name: *Rheum rhaponticum* L.

Vernacular name(s): rhubarb

Scientific family name: *Polygonaceae*

Vernacular family name: buckwheat

Go to ITIS*^{ca} for more taxonomic information on: [Rheum rhaponticum](#)

References:

Agriculture Quebec. 1975. Noms des maladies des plantes du Canada/ Names of plant diseases in Canada. , Quebec City, Que., Canada. 288 pp.

Alex, J. F., Cayouette, R., Mulligan, G. A. 1980. Common and botanical names of weeds in Canada/Noms populaire et scientifiques des plantes nuisibles du Canada. Revised. Agric. Can. Publ., Ottawa, Ont., Canada. 132 pp.

Bailey, L. H., Bailey, E. Z. 1976. Hortus third. Revised. MacMillan, New York, N.Y., USA. 1290 pp.

Scoggan, H. J. 1978, 1979. The flora of Canada. Nat. Mus. Nat. Sci. (Ottawa) Publ. Bot. 7(1)-7(4). 1711 pp.

Van Wijk, H. L. 1911. A dictionary of plant names. Martinus Nijhoff, The Hague, The Netherlands. 1444 pp.

Victorin, M. 1964. Flore Laurentienne. 2nd ed. Univ. Montreal, Montreal, Que., Canada. 952 pp.

Geographic Information

Plant or plant parts used in or around the home.

References:

Bailey, L. H., Bailey, E. Z. 1976. Hortus third. Revised. MacMillan, New York, N.Y., USA. 1290 pp.

Boivin, B. 1966, 1967. Énumération des plantes du Canada. Provencheria 6. Nat. Can. (Que.) 93: 253-274; 371-437; 583-646; 989-1063. 94: 131-157; 471-528; 625-655.

Image or illustration

rhubarb:

Images: images.google.com

Notes on Poisonous plant parts:

Rhubarb leaves contain the highest amounts of oxalates and perhaps anthraquinones, which may be partly responsible for toxicity. The stalks also contain some low levels of oxalates, but this is not a problem (Cooper and Johnson 1984).

Toxic parts:

leaves

References:

Cooper, M. R., Johnson, A. W. 1984. Poisonous plants in Britain and their effects on animals and man. Her Majesty's Stationery Office, London, England. 305 pp.

Notes on Toxic plant chemicals:

Oxalates are contained in all parts of rhubarb plants, especially in the green leaves. There is some evidence that anthraquinone glycosides are also present and may be partly responsible (Cooper and Johnson 1984).

Toxic plant chemicals:

anthraquinones

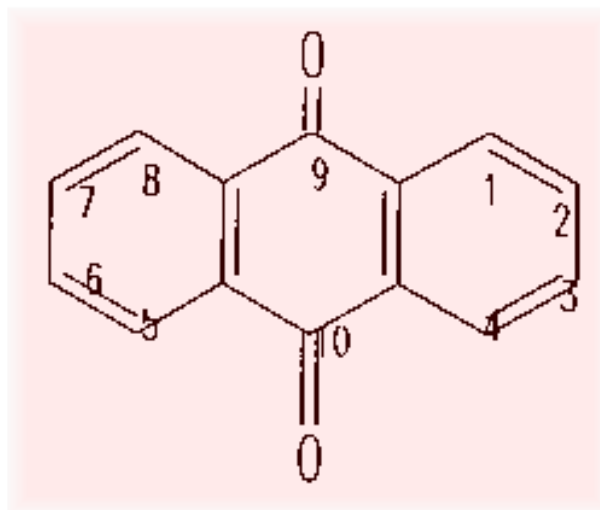

oxalate

Chemical diagram(s) are courtesy of [Ruth McDiarmid](#), Biochemistry Technician, Kamloops Range Station, Agriculture and Agri-Food Canada, Kamloops, British Columbia, Canada.

References:

Cooper, M. R., Johnson, A. W. 1984. Poisonous plants in Britain and their effects on animals and man. Her Majesty's Stationery Office, London, England. 305 pp.

Animals/Human Poisoning:

Note: When an animal is listed without additional information, the literature (as of 1993) contained no detailed explanation.

Goats

General symptoms of poisoning:

[diarrhea](#)
[mouth, frothing of](#)
[vomiting](#)

Notes on poisoning:

A goat that ate rhubarb leaves stood with outspread legs, an open mouth, and protruding eyes. The animal was crying and produced sour green vomit and profuse diarrhea (Cooper and Johnson 1984).

References:

Cooper, M. R., Johnson, A. W. 1984. Poisonous plants in Britain and their effects on animals and man. Her Majesty's Stationery Office, London, England. 305 pp.

Humans

General symptoms of poisoning:

[abdominal pains](#)
[abortion](#)
[convulsions](#)
[death](#)
[drowsiness](#)
[muscle twitching](#)
[nausea](#)
[vomiting](#)

Notes on poisoning:

Ingesting rhubarb leaves has caused many fatalities, especially during World War II, when the leaves were recommended as food for a short time. In one fatal case, oxalic acid was ingested at a rate of only 1.3 g/kg, whereas five or six times this amount normally constitutes a fatal dose. More recent evidence indicates that anthraquinone glycosides may be involved. Symptoms include abdominal pain, nausea, vomiting, weakness, and drowsiness. Blood clotting is reduced. A woman in early pregnancy aborted before she died. Two children ingested 20-100 g of leaves and stalks. They vomited and developed jaundice, with some kidney and liver damage. Analysis for

oxalate crystals in the urine may help diagnosis (Robb 1919, Cooper and Johnson 1984).

References:

Cooper, M. R., Johnson, A. W. 1984. Poisonous plants in Britain and their effects on animals and man. Her Majesty's Stationery Office, London, England. 305 pp.

Robb, H. F. 1919. Death from rhubarb leaves due to oxalic acid poisoning. J. Am. Med. Assoc., 73: 627-628.

Spoerke, D. G., Smolinske, S. C. 1990. Toxicity of houseplants. CRC Press, Inc., Boca Raton, Fla., USA. 335 pp.

Swine

General symptoms of poisoning:

[convulsions](#)

[death](#)

[gait, staggering](#)

[mouth, frothing of](#)

Notes on poisoning:

Swine that ingested rhubarb plants exhibited the following symptoms: foaming at the mouth, staggering, and convulsions, followed by death. Postmortem examination revealed severe inflammation of the stomach and intestines (Cooper and Johnson 1984).

References:

Cooper, M. R., Johnson, A. W. 1984. Poisonous plants in Britain and their effects on animals and man. Her Majesty's Stationery Office, London, England. 305 pp.

[Another search?](#)

[Français](#) | [Contact Us](#) | [Help](#) | [Search](#) | [Canada site](#)

[Coming Events](#) | [About CBIF](#) | [Links](#) | [Reports and Publications](#) |

[Home](#)

Date modified: 2003-02-06

[Important Notices](#)



Français	Contact us	Help	Search	Canada site
Coming events	About CBIF	Links	Reports and publications	Home

Canadian Biodiversity Information Facility



Notes on poisoning: Russian knapweed

[Introduction](#)[Interactive](#)[All poisonous plants by Botanical name](#)[All poisonous plants by Common name](#)[Important WWW Poisonous Plants sites](#)

General poisoning notes:

Russian knapweed (*Centaurea repens*) and yellow star-thistle (*Centaurea solstitialis*) are both naturalized in western Canada. Both plants cause chewing disease in horses. The problem is restricted to horses. Prolonged consumption of the plants is required to produce the symptoms. Russian knapweed is more toxic than yellow star-thistle (Cheeke and Schull 1985, Panter 1990):



- intake of 1.8-2.5 kg/100 kg of body weight per day of Russian knapweed causes toxicity after ingesting 59-71% of its body weight of the plant material in about 30 days;

- intake of 2.3-2.6 kg/100 kg of body weight per day of yellow star-thistle causes toxicity after ingesting 86-200% of its body weight of the plant material in about 54 days.

There are no known treatments for horses once the symptoms appear.

References:

Cheeke, P. R., Shull, L. R. 1985. Natural toxicants in feeds and poisonous plants. AVI Publishing Company, Inc., Westport, Conn., USA. 492 pp.

Cordy, D. R. 1978. *Centaurea* species and equine nigropallidal encephalomalacia. Pages 327-336 in Keeler, R. F., Van Kampen, K. R., James, L. F., eds. Effects of poisonous plants on livestock. Academic Press, New York, N.Y., USA. 600 pp.

Panter, K. E. 1990. Toxicity of knapweed in horses. Wash. State Univ. Knapweed, 4(3): 2.

Nomenclature:

Scientific Name: *Centaurea repens* L.

Vernacular name(s): Russian knapweed

Scientific family name: *Compositae*

Vernacular family name: composite

Go to ITIS*^{ca} for more taxonomic information on:

[Centaurea repens](#)

References:

Agriculture Quebec. 1975. Noms des maladies des plantes du Canada/ Names of plant diseases in Canada. , Quebec City, Que., Canada. 288 pp.

Alex, J. F., Cayouette, R., Mulligan, G. A. 1980. Common and botanical names of weeds in Canada/Noms populaire et scientifiques des plantes nuisibles du Canada. Revised. Agric. Can. Publ., Ottawa, Ont., Canada. 132 pp.

Bailey, L. H., Bailey, E. Z. 1976. Hortus third. Revised. MacMillan, New York, N.Y., USA. 1290 pp.

Scoggan, H. J. 1978, 1979. The flora of Canada. Nat. Mus. Nat. Sci. (Ottawa) Publ. Bot. 7(1)-7(4). 1711 pp.

Van Wijk, H. L. 1911. A dictionary of plant names. Martinus Nijhoff, The Hague, The Netherlands. 1444 pp.

Victorin, M. 1964. Flore Laurentienne. 2nd ed. Univ. Montreal, Montreal, Que., Canada. 952 pp.

Geographic Information

Alberta

British Columbia

Manitoba

Ontario

Saskatchewan

References:

Bailey, L. H., Bailey, E. Z. 1976. Hortus third. Revised. MacMillan, New York, N.Y., USA. 1290 pp.

Boivin, B. 1966, 1967. Énumération des plantes du Canada. Provencheria 6. Nat. Can. (Que.) 93: 253-274; 371-437; 583-646; 989-1063. 94: 131-157; 471-528; 625-655.

Image or illustration

Russian knapweed:

Images: images.google.com

Notes on Poisonous plant parts:

Horses must ingest fresh aboveground plant material for prolonged periods to reach a threshold level of unknown toxicity and then the symptoms appear abruptly. Chewing disease in horses has occurred in parts of the western United States. In California the peak times of disease onset are June-July and October-November (Cordy 1978).

Toxic parts:

leaves
mature fruit
stems

References:

Cheeke, P. R., Shull, L. R. 1985. Natural toxicants in feeds and poisonous plants. AVI Publishing Company, Inc., Westport, Conn., USA. 492 pp.

Cordy, D. R. 1978. *Centaurea* species and equine nigropallidal encephalomalacia. Pages 327-336 in Keeler, R. F., Van Kampen, K. R., James, L. F., eds. Effects of poisonous plants on livestock. Academic Press, New York, N.Y., USA. 600 pp.

Mettler, F. A., Stern, G. M. 1963. Observations on the toxic effects of yellow star thistle. J. Neuropathol. & Exp. Neurol., 22: 164-169.

Toxic plant chemicals:

unknown chemical

References:

Cheeke, P. R., Shull, L. R. 1985. Natural toxicants in feeds and poisonous plants. AVI Publishing Company, Inc., Westport, Conn., USA. 492 pp.

Animals/Human Poisoning:

Note: When an animal is listed without additional information, the literature (as of 1993) contained no detailed explanation.

Horses

General symptoms of poisoning:

[drowsiness](#)

[gait, unsteady](#)

[incoordination](#)

[restlessness](#)

References:

Cheeke, P. R., Shull, L. R. 1985. Natural toxicants in feeds and poisonous plants. AVI Publishing Company, Inc., Westport, Conn., USA. 492 pp.

[Another search?](#)

[Français](#) | [Contact Us](#) | [Help](#) | [Search](#) | [Canada site](#)

[Coming Events](#) | [About CBIF](#) | [Links](#) | [Reports and Publications](#) |

[Home](#)

Date modified: 2003-02-06

[Important Notices](#)



Français	Contact us	Help	Search	Canada site
Coming events	About CBIF	Links	Reports and publications	Home

Canadian Biodiversity Information Facility



Notes on poisoning: Saskatoon (a serviceberry)

[Introduction](#)[Interactive](#)[All poisonous plants by Botanical name](#)[All poisonous plants by Common name](#)[Important WWW Poisonous Plants sites](#)

General poisoning notes:

Saskatoon, a serviceberry (*Amelanchier alnifolia*), is a shrub native to western Canada. The shrub has an hydrogen cyanide (HCN) potential high enough to kill cattle and mule deer. Mule deer that ingested 1 kg of fresh weight per day were poisoned and died within 24 h of the appearance of clinical signs. Experiments with cattle also showed the poisoning potential (Majak et al. 1978, Majak et al. 1980).

References:

Majak, W., Bose, R. J., Quinton, D. A. 1978. Prunasin, the cyanogenic glycoside in *Amelanchier alnifolia*. *Phytochemistry* (Oxf.), 17: 803.

Majak, W., Udenberg, T., Clark, L. J., McLean, A. 1980. Toxicity of Saskatoon serviceberry to cattle. *Can. Vet. J.*, 21: 74-76.

Nomenclature:

Scientific Name: *Amelanchier alnifolia* Nutt.

Vernacular name(s): Saskatoon (a serviceberry)

Scientific family name: *Rosaceae*

Vernacular family name: rose

Go to ITIS^{*ca} for more taxonomic information on: [Amelanchier alnifolia](#)

References:

Agriculture Quebec. 1975. Noms des maladies des plantes du Canada/ Names of plant diseases in Canada. , Quebec City, Que., Canada. 288 pp.

Alex, J. F., Cayouette, R., Mulligan, G. A. 1980. Common and botanical names of weeds in Canada/Noms populaire et scientifiques des plantes nuisibles du Canada. Revised. Agric. Can. Publ., Ottawa, Ont., Canada. 132 pp.

Bailey, L. H., Bailey, E. Z. 1976. Hortus third. Revised. MacMillan, New York, N.Y., USA. 1290 pp.

Scoggan, H. J. 1978, 1979. The flora of Canada. Nat. Mus. Nat. Sci. (Ottawa) Publ. Bot. 7(1)-7(4). 1711 pp.

Van Wijk, H. L. 1911. A dictionary of plant names. Martinus Nijhoff, The Hague, The Netherlands. 1444 pp.

Victorin, M. 1964. Flore Laurentienne. 2nd ed. Univ. Montreal, Montreal, Que., Canada. 952 pp.

Geographic Information

Alberta
British Columbia
Manitoba
Northwest Territories
Ontario
Quebec
Saskatchewan
Yukon Territory

References:

Bailey, L. H., Bailey, E. Z. 1976. Hortus third. Revised. MacMillan, New York, N.Y., USA. 1290 pp.

Boivin, B. 1966, 1967. Énumération des plantes du Canada. Provencheria 6. Nat. Can. (Que.) 93: 253-274; 371-437; 583-646; 989-1063. 94: 131-157; 471-528; 625-655.

Image or illustration

Saskatoon (a serviceberry):

Images: images.google.com

Notes on Poisonous plant parts:

Saskatoon contains a large quantity of prunasin, which has a hydrogen cyanide (HCN) potential exceeding the level required to cause of poisoning in cattle. HCN occurs in the twigs before the leaves appear and during the bloom period. The level of HCN potential is highest in new-growth twigs, especially during dry years (Majak et al. 1981).

Toxic parts:

flower buds
leaves
seeds
twigs
young shoots

References:

Majak, W., Bose, R. J., Quinton, D. A. 1978. Prunasin, the cyanogenic glycoside in *Amelanchier alnifolia*. *Phytochemistry* (Oxf.), 17: 803.

Majak, W., McDiarmid, R. E., Hall, J. W. 1981. The cyanide potential of Saskatoon serviceberry (*Amelanchier alnifolia*) and chokecherry (*Prunus virginiana*). *Can. J. Anim. Sci.*, 61: 681-686.

Majak, W., Quinton, D. A., Broersma, K. 1980. Cyanogenic glycoside levels in Saskatoon serviceberry. *J. Range Manage.*, 33: 197-199.

Majak, W., Udenberg, T., Clark, L. J., McLean, A. 1980. Toxicity of Saskatoon serviceberry to cattle. *Can. Vet. J.*, 21: 74-76.

Toxic plant chemicals:

prunasin

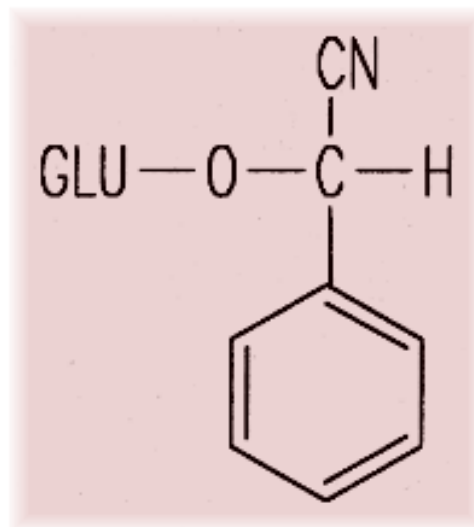

Chemical diagram(s) are courtesy of [Ruth McDiarmid](#), Biochemistry Technician, Kamloops Range Station, Agriculture and Agri-Food Canada, Kamloops, British Columbia, Canada.

References:

Majak, W., Bose, R. J., Quinton, D. A. 1978. Prunasin, the cyanogenic glycoside in *Amelanchier alnifolia*. *Phytochemistry (Oxf.)*, 17: 803.

Majak, W., Quinton, D. A., Broersma, K. 1980. Cyanogenic glycoside levels in Saskatoon serviceberry. *J. Range Manage.*, 33: 197-199.

Majak, W., Udenberg, T., Clark, L. J., McLean, A. 1980. Toxicity of Saskatoon serviceberry to cattle. *Can. Vet. J.*, 21: 74-76.

Animals/Human Poisoning:

Note: When an animal is listed without additional information, the literature (as of 1993) contained no detailed explanation.

Cattle

General symptoms of poisoning:

[breathing, labored](#)

[death](#)

[diarrhea](#)

[heart rate, elevated](#)

[recumbency, lateral](#)

[restlessness](#)

[shivering](#)

[weight loss](#)

Notes on poisoning:

Hydrogen cyanide (HCN) poisoning was experimentally induced in cattle. The experiment showed that a single dose of the browse with 1.43% prunasin can be lethal to cattle. Peak cyanide levels occurred in the blood 1-2 h after ingestion. The rumen had a distinct almond smell (Majak et al. 1980).

References:

Majak, W., Udenberg, T., Clark, L. J., McLean, A. 1980. Toxicity of Saskatoon serviceberry to cattle. *Can. Vet. J.*, 21: 74-76.

[Another search?](#)

[Français](#) | [Contact Us](#) | [Help](#) | [Search](#) | [Canada site](#)

[Coming Events](#) | [About CBIF](#) | [Links](#) | [Reports and Publications](#) |

[Home](#)

Date modified: 2003-02-06

[Important Notices](#)



Français	Contact us	Help	Search	Canada site
Coming events	About CBIF	Links	Reports and publications	Home



Notes on poisoning: scarlet pimpernel

[Introduction](#)

[Interactive](#)

[All poisonous plants by Botanical name](#)

[All poisonous plants by Common name](#)

[Important WWW Poisonous Plants sites](#)



General poisoning notes:

Scarlet pimpernel (*Anagallis arvensis*) is a naturalized plant found across parts of southern Canada. The plant contains several toxins that have poisoned livestock, and an irritant in the plant hairs can cause allergies in humans. The occurrence of poisoning appears to depend on unknown conditions, which may account for the conflicting literature reports. However, the plant has been implicated in enough cases of poisoning to be treated as a potentially toxic plant (Cooper and Johnson 1984, Fuller and McClintock 1986).

References:

- Cooper, M. R., Johnson, A. W. 1984. Poisonous plants in Britain and their effects on animals and man. Her Majesty's Stationery Office, London, England. 305 pp.
- Fuller, T. C., McClintock, E. 1986. Poisonous plants of California. Univ. California Press, Berkeley, Calif., USA. 432 pp.
- Perkins, K. D., Payne, W. W. 1978. Guide to the poisonous and irritant plants of Florida. Univ. Fla. Agric. Ext. Serv. Circ., 441. 84 pp.
- Reynard, G. B., Norton, J. B. 1942. Poisonous plants of Maryland in relation to livestock. Univ. MD. Agric. Exp. Stn. Bull., A10. 312 pp.

Nomenclature:

Scientific Name: *Anagallis arvensis* L.

Vernacular name(s): scarlet pimpernel

Scientific family name: *Primulaceae*

Vernacular family name: primrose

Go to ITIS^{*ca} for more taxonomic information on: [Anagallis arvensis](#)

References:

Agriculture Quebec. 1975. Noms des maladies des plantes du Canada/ Names of plant diseases in Canada. , Quebec City, Que., Canada. 288 pp.

Alex, J. F., Cayouette, R., Mulligan, G. A. 1980. Common and botanical names of weeds in Canada/Noms populaire et scientifiques des plantes nuisibles du Canada. Revised. Agric. Can. Publ., Ottawa, Ont., Canada. 132 pp.

Bailey, L. H., Bailey, E. Z. 1976. Hortus third. Revised. MacMillan, New York, N.Y., USA. 1290 pp.

Scoggan, H. J. 1978, 1979. The flora of Canada. Nat. Mus. Nat. Sci. (Ottawa) Publ. Bot. 7(1)-7(4). 1711 pp.

Van Wijk, H. L. 1911. A dictionary of plant names. Martinus Nijhoff, The Hague, The Netherlands. 1444 pp.

Victorin, M. 1964. Flore Laurentienne. 2nd ed. Univ. Montreal, Montreal, Que., Canada. 952 pp.

Geographic Information

Alberta
British Columbia
Labrador
Nova Scotia
Ontario
Quebec

References:

Bailey, L. H., Bailey, E. Z. 1976. Hortus third. Revised. MacMillan, New York, N.Y., USA. 1290 pp.

Boivin, B. 1966, 1967. Énumération des plantes du Canada. Provencheria 6. Nat. Can. (Que.) 93: 253-274; 371-437; 583-646; 989-1063. 94: 131-157; 471-528; 625-655.

Image or illustration

scarlet pimpernel:

Images: images.google.com

Toxic parts:

all parts

References:

Cooper, M. R., Johnson, A. W. 1984. Poisonous plants in Britain and their effects on animals and man. Her Majesty's Stationery Office, London, England. 305 pp.

Notes on Toxic plant chemicals:

Scarlet pimpernel contains a triterpenoid saponin in the above-ground plant parts, a glycoside (cyclamine) in the roots, and an acrid volatile oil. The plant hairs contain primin, which can cause human dermatitis (Perkins and Payne 1987, Cooper and Johnson 1984).

Toxic plant chemicals:

cyclamin

References:

Cooper, M. R., Johnson, A. W. 1984. Poisonous plants in Britain and their effects on animals and man. Her Majesty's Stationery Office, London, England. 305 pp.

Perkins, K. D., Payne, W. W. 1978. Guide to the poisonous and irritant plants of Florida. Univ. Fla. Agric. Ext. Serv. Circ., 441. 84 pp.

Animals/Human Poisoning:

Note: When an animal is listed without additional information, the literature (as of 1993) contained no detailed explanation.

Cattle

General symptoms of poisoning:

[death](#)

References:

Fuller, T. C., McClintock, E. 1986. Poisonous plants of California. Univ. California Press, Berkeley, Calif., USA. 432 pp.

Reynard, G. B., Norton, J. B. 1942. Poisonous plants of Maryland

in relation to livestock. Univ. MD. Agric. Exp. Stn. Bull., A10.
312 pp.

Horses

Humans

General symptoms of poisoning:

[constipation](#)

[erythema](#)

[gait, staggering](#)

[headache](#)

[kidney, congestion of](#)

[nausea](#)

References:

Fuller, T. C., McClintock, E. 1986. Poisonous plants of California. Univ. California Press, Berkeley, Calif., USA. 432 pp.

Perkins, K. D., Payne, W. W. 1978. Guide to the poisonous and irritant plants of Florida. Univ. Fla. Agric. Ext. Serv. Circ., 441. 84 pp.

Sheep

[Another search?](#)

[Français](#) | [Contact Us](#) | [Help](#) | [Search](#) | [Canada site](#)

[Coming Events](#) | [About CBIF](#) | [Links](#) | [Reports and Publications](#) |

[Home](#)

Date modified: 2003-02-06

[Important Notices](#)



Français	Contact us	Help	Search	Canada site
Coming events	About CBIF	Links	Reports and publications	Home

Canadian Biodiversity Information Facility



Notes on poisoning: seaside arrow-grass

[Introduction](#)

[Interactive](#)

[All poisonous plants by Botanical name](#)

[All poisonous plants by Common name](#)

[Important WWW Poisonous Plants sites](#)



General poisoning notes:

Seaside arrow-grass (*Triglochin maritima*) is a native plant found sporadically across Canada in saline, brackish, or fresh marshes and shores. This plant contains cyanogenic glycosides, which can release HCN during mastication by animals. Poisoning occurs primarily with ruminants, including cattle and sheep. The concentration of toxic chemicals increases during times of moisture depletion (Majak et al. 1980, Cooper and Johnson 1984, Poulton 1989).

References:

Beath, O. A., Draize, J. H., Eppson, H. F. 1933. Arrow grass - chemical and physiological considerations. Univ. Wyo. Agric. Exp. Stn. Bull., 193. 36 pp.

Cooper, M. R., Johnson, A. W. 1984. Poisonous plants in Britain and their effects on animals and man. Her Majesty's Stationery Office, London, England. 305 pp.

Nomenclature:

Scientific Name: *Triglochin maritima* L.

Vernacular name(s): seaside arrow-grass

Scientific family name: *Juncaginaceae*

Vernacular family name: arrow-grass

Go to ITIS^{*ca} for more taxonomic information on: [Triglochin maritima](#)

References:

Agriculture Quebec. 1975. Noms des maladies des plantes du

Canada/ Names of plant diseases in Canada. , Quebec City, Que., Canada. 288 pp.

Alex, J. F., Cayouette, R., Mulligan, G. A. 1980. Common and botanical names of weeds in Canada/Noms populaire et scientifiques des plantes nuisibles du Canada. Revised. Agric. Can. Publ., Ottawa, Ont., Canada. 132 pp.

Bailey, L. H., Bailey, E. Z. 1976. Hortus third. Revised. MacMillan, New York, N.Y., USA. 1290 pp.

Scoggan, H. J. 1978, 1979. The flora of Canada. Nat. Mus. Nat. Sci. (Ottawa) Publ. Bot. 7(1)-7(4). 1711 pp.

Van Wijk, H. L. 1911. A dictionary of plant names. Martinus Nijhoff, The Hague, The Netherlands. 1444 pp.

Victorin, M. 1964. Flore Laurentienne. 2nd ed. Univ. Montreal, Montreal, Que., Canada. 952 pp.

Geographic Information

Alberta
British Columbia
Labrador
Manitoba
New Brunswick
Northwest Territories
Nova Scotia
Ontario
Prince Edward Island
Quebec
Saskatchewan
Yukon Territory

References:

Bailey, L. H., Bailey, E. Z. 1976. Hortus third. Revised. MacMillan, New York, N.Y., USA. 1290 pp.

Boivin, B. 1966, 1967. Énumération des plantes du Canada. Provencheria 6. Nat. Can. (Que.) 93: 253-274; 371-437; 583-646; 989-1063. 94: 131-157; 471-528; 625-655.

Image or illustration

seaside arrow-grass:

Images: images.google.com

Toxic parts:

all parts
flowers
leaves

References:

Majak, W., McDiarmid, R. E., Hall, J. W., Van Ryswyk, A. L. 1980. Seasonal variation in the cyanide potential of arrowgrass (*Triglochin maritima*). *Can. J. Plant Sci.*, 60: 1235-1241.

Notes on Toxic plant chemicals:

Two cyanogenic glycosides, triglochinin and taxiphillin, have been found in seaside arrow-grass. The cyanogenic levels in leaves are substantially elevated during periods of severe moisture stress. Newly initiated spikes (flowering stalks) yielded high levels of glycosides. Spikes therefore pose a potential threat if they are selectively grazed. A cyanogenic glycoside content of 50 mg/100 g of green seaside arrow-grass is considered lethal, even if only 0.5% of body weight is ingested (Majak et al. 1980, Cooper and Johnson 1984).

Toxic plant chemicals:

taxiphillin

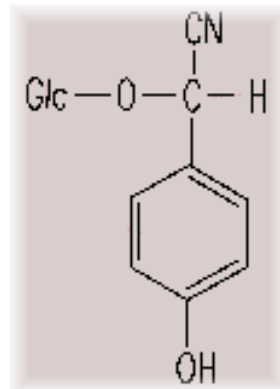

triglochinin

Chemical diagram(s) are courtesy of [Ruth McDiarmid](#), Biochemistry Technician, Kamloops Range Station, Agriculture and Agri-Food Canada, Kamloops, British Columbia, Canada.

References:

Majak, W., McDiarmid, R. E., Hall, J. W., Van Ryswyk, A. L. 1980. Seasonal variation in the cyanide potential of arrowgrass (*Triglochin maritima*). *Can. J. Plant Sci.*, 60: 1235-1241.

Poulton, J. E. 1983. Cyanogenic compounds in plants and their toxic effects. Pages 117-157 in Keeler, R. F., Tu, A. T., eds. Handbook of natural toxins. Vol. 1. Plant and Fungal toxins. Marcel Dekker, Inc., New York, N.Y., USA. 934 pp.

Animals/Human Poisoning:

Note: When an animal is listed without additional information, the literature (as of 1993) contained no detailed explanation.

Cattle

General symptoms of poisoning:

[convulsions](#)

[death by asphyxiation](#)

[nervousness](#)

[recumbency](#)

[trembling](#)

[vomiting](#)

Notes on poisoning:

Cyanide poisoning from seaside arrow-grass is similar to symptoms discussed under sheep.

References:

Cooper, M. R., Johnson, A. W. 1984. Poisonous plants in Britain and their effects on animals and man. Her Majesty's Stationery Office, London, England. 305 pp.

Sheep

General symptoms of poisoning:

[convulsions](#)

[death by asphyxiation](#)

[nervousness](#)

[recumbency](#)

[salivation](#)

[trembling](#)

[vomiting](#)

Notes on poisoning:

Cyanide poisoning of sheep by seaside arrow-grass includes the following symptoms: nervousness, trembling, erratic breathing, convulsions, recumbency, and death. Postmortem findings reveal bright red blood and the smell of bitter almonds in the stomach.

Treatment, if started early enough, can be successful. Intravenous injections of an aqueous solution of sodium thiosulfate have proved to be effective (Cooper and Johnson 1984).

References:

Cooper, M. R., Johnson, A. W. 1984. Poisonous plants in Britain and their effects on animals and man. Her Majesty's Stationery Office, London, England. 305 pp.

[Another search?](#)

[Français](#) | [Contact Us](#) | [Help](#) | [Search](#) | [Canada site](#)

[Coming Events](#) | [About CBIF](#) | [Links](#) | [Reports and Publications](#) | [Home](#)

Date modified: 2003-02-06

[Important Notices](#)



Français	Contact us	Help	Search	Canada site
Coming events	About CBIF	Links	Reports and publications	Home

Canadian Biodiversity Information Facility



Notes on poisoning: sensitive fern

[Introduction](#)[Interactive](#)[All poisonous plants by Botanical name](#)[All poisonous plants by Common name](#)[Important WWW Poisonous Plants sites](#)

General poisoning notes:

Sensitive fern (*Onoclea sensibilis*) is a native plant that is found through eastern Canada into Manitoba. The plant, often abundant in low, wet areas, has been implicated in the poisoning and death of horses in field cases. Only one set of experimental poisonings has been undertaken, but the resulting symptoms were similar when horses were fed hay containing sensitive fern (Waller et al. 1944).

References:

Waller, E. F., Prince, F. S., Hodgson, A. R., Colovos, N. F. 1944. Sensitive-fern poisoning of horses. Univ. N. H. Agric. Stn. Tech. Bull., 83. 7 pp.

Nomenclature:

Scientific Name: *Onoclea sensibilis* L.

Vernacular name(s): sensitive fern

Scientific family name: *Polypodiaceae*

Vernacular family name: ffern

Go to ITIS^{*ca} for more taxonomic information on: [Onoclea sensibilis](#)

References:

Agriculture Quebec. 1975. Noms des maladies des plantes du Canada/ Names of plant diseases in Canada. , Quebec City, Que., Canada. 288 pp.

Alex, J. F., Cayouette, R., Mulligan, G. A. 1980. Common and botanical names of weeds in Canada/Noms populaire et

scientifiques des plantes nuisibles du Canada. Revised. Agric. Can. Publ., Ottawa, Ont., Canada. 132 pp.

Bailey, L. H., Bailey, E. Z. 1976. Hortus third. Revised. MacMillan, New York, N.Y., USA. 1290 pp.

Scoggan, H. J. 1978, 1979. The flora of Canada. Nat. Mus. Nat. Sci. (Ottawa) Publ. Bot. 7(1)-7(4). 1711 pp.

Van Wijk, H. L. 1911. A dictionary of plant names. Martinus Nijhoff, The Hague, The Netherlands. 1444 pp.

Victorin, M. 1964. Flore Laurentienne. 2nd ed. Univ. Montreal, Montreal, Que., Canada. 952 pp.

Geographic Information

Labrador
Manitoba
New Brunswick
Nova Scotia
Ontario
Prince Edward Island
Quebec

References:

Bailey, L. H., Bailey, E. Z. 1976. Hortus third. Revised. MacMillan, New York, N.Y., USA. 1290 pp.

Boivin, B. 1966, 1967. Énumération des plantes du Canada. Provencheria 6. Nat. Can. (Que.) 93: 253-274; 371-437; 583-646; 989-1063. 94: 131-157; 471-528; 625-655.

Image or illustration

sensitive fern:

Images: images.google.com

Notes on Poisonous plant parts:

When the fronds (aboveground leaves) are included in hay, they produce toxic symptoms in horses. The fertile fronds (spore-bearing stalks) are also included in hay. A literature search did not reveal any reports on the toxin, nor was the plant organ that contains the toxin identified.

Toxic parts:

leaves

References:

Waller, E. F., Prince, F. S., Hodgson, A. R., Colovos, N. F. 1944. Sensitive-fern poisoning of horses. Univ. N. H. Agric. Stn. Tech. Bull., 83. 7 pp.

Toxic plant chemicals:

unknown chemical

References:

Waller, E. F., Prince, F. S., Hodgson, A. R., Colovos, N. F. 1944. Sensitive-fern poisoning of horses. Univ. N. H. Agric. Stn. Tech. Bull., 83. 7 pp.

Animals/Human Poisoning:

Note: When an animal is listed without additional information, the literature (as of 1993) contained no detailed explanation.

Horses

General symptoms of poisoning:

[brain, congestion of](#)

[colic](#)

[death](#)

[falling down](#)

[gait, unsteady](#)

[icterus](#)

[incoordination](#)

Notes on poisoning:

Ingesting hay containing sensitive fern produces the following symptoms: difficulty in eating, falling down, walking as if blind, rubbing against objects, and death. Postmortem examination showed extreme icterus, swollen liver, paralysis of the alimentary tract, and brain edema. Old horses are more affected than younger ones. Horses that are worked and are fed a grain supplement, in addition to hay that includes the fern, are not affected. Recovery may occur if the horses are given good hay and grain before serious nervous symptoms develop (Waller et al. 1944).

References:

Waller, E. F., Prince, F. S., Hodgson, A. R., Colovos, N. F. 1944.

Sensitive-fern poisoning of horses. Univ. N. H. Agric. Stn. Tech. Bull., 83. 7 pp.

[Another search?](#)

[Français](#) | [Contact Us](#) | [Help](#) | [Search](#) | [Canada site](#)

[Coming Events](#) | [About CBIF](#) | [Links](#) | [Reports and Publications](#) |

[Home](#)

Date modified: 2003-02-06

[Important Notices](#)



Français	Contact us	Help	Search	Canada site
Coming events	About CBIF	Links	Reports and publications	Home

Canadian Biodiversity Information Facility



Notes on poisoning: sheep sorrel

[Introduction](#)[Interactive](#)[All poisonous plants by Botanical name](#)[All poisonous plants by Common name](#)[Important WWW Poisonous Plants sites](#)

General poisoning notes:

Sheep sorrel (*Rumex acetosella*) is a naturalized herb found across Canada. The plant can become abundant in poor disturbed soils. Ingesting large quantities of the plants caused poisoning and death in sheep in other countries (Cooper and Johnson 1984).



References:

Cooper, M. R., Johnson, A. W. 1984. Poisonous plants in Britain and their effects on animals and man. Her Majesty's Stationery Office, London, England. 305 pp.

Nomenclature:

Scientific Name: *Rumex acetosella* L.

Vernacular name(s): sheep sorrel

Scientific family name: *Polygonaceae*

Vernacular family name: buckwheat

Go to ITIS*^{ca} for more taxonomic information on: [Rumex acetosella](#)

References:

Agriculture Quebec. 1975. Noms des maladies des plantes du Canada/ Names of plant diseases in Canada. , Quebec City, Que., Canada. 288 pp.

Alex, J. F., Cayouette, R., Mulligan, G. A. 1980. Common and botanical names of weeds in Canada/Noms populaire et scientifiques des plantes nuisibles du Canada. Revised. Agric. Can. Publ., Ottawa, Ont., Canada. 132 pp.

Bailey, L. H., Bailey, E. Z. 1976. Hortus third. Revised. MacMillan, New York, N.Y., USA. 1290 pp.

Scoggan, H. J. 1978, 1979. The flora of Canada. Nat. Mus. Nat. Sci. (Ottawa) Publ. Bot. 7(1)-7(4). 1711 pp.

Van Wijk, H. L. 1911. A dictionary of plant names. Martinus Nijhoff, The Hague, The Netherlands. 1444 pp.

Victorin, M. 1964. Flore Laurentienne. 2nd ed. Univ. Montreal, Montreal, Que., Canada. 952 pp.

Geographic Information

Alberta
British Columbia
Labrador
Manitoba
New Brunswick
Nova Scotia
Ontario
Prince Edward Island
Quebec
Saskatchewan
Yukon Territory

References:

Bailey, L. H., Bailey, E. Z. 1976. Hortus third. Revised. MacMillan, New York, N.Y., USA. 1290 pp.

Boivin, B. 1966, 1967. Énumération des plantes du Canada. Provencheria 6. Nat. Can. (Que.) 93: 253-274; 371-437; 583-646; 989-1063. 94: 131-157; 471-528; 625-655.

Image or illustration

sheep sorrel:

Images: images.google.com

Toxic parts:

leaves
stems

References:

Cooper, M. R., Johnson, A. W. 1984. Poisonous plants in Britain and their effects on animals and man. Her Majesty's Stationery Office, London, England. 305 pp.

Notes on Toxic plant chemicals:

Oxalate crystals are found in sheep sorrel. Under certain circumstances, nitrates can accumulate in sufficient quantity to cause poisoning. If large enough quantities of oxalates are absorbed by ruminants, they combine with blood calcium, forming calcium oxalate and causing calcium deficiency. The crystal can accumulate in the kidneys and brain causing renal failure and nervous disorders (Cooper and Johnson 1984).

Toxic plant chemicals:

oxalate

References:

Cooper, M. R., Johnson, A. W. 1984. Poisonous plants in Britain and their effects on animals and man. Her Majesty's Stationery Office, London, England. 305 pp.

Animals/Human Poisoning:

Note: When an animal is listed without additional information, the literature (as of 1993) contained no detailed explanation.

Sheep

General symptoms of poisoning:

[coma](#)

[death](#)

[falling down](#)

[gait, staggering](#)

[muscle spasms](#)

[nasal discharge](#)

Notes on poisoning:

Several sheep in New Zealand were poisoned and died. Symptoms included staggering, nasal discharge, muscular spasms, abnormal breathing, and falling down. In severe cases, coma preceded death. Postmortem findings revealed oxalate crystals and inflammation of the kidneys. Up to 10% of flocks died (Cooper and Johnson 1984).

References:

Cooper, M. R., Johnson, A. W. 1984. Poisonous plants in Britain

and their effects on animals and man. Her Majesty's Stationery Office, London, England. 305 pp.

[Another search?](#)

[Français](#) | [Contact Us](#) | [Help](#) | [Search](#) | [Canada site](#)

[Coming Events](#) | [About CBIF](#) | [Links](#) | [Reports and Publications](#) |

[Home](#)

Date modified: 2003-02-06

[Important Notices](#)



Français	Contact us	Help	Search	Canada site
Coming events	About CBIF	Links	Reports and publications	Home

Canadian Biodiversity Information Facility



Notes on poisoning: sheep-laurel

[Introduction](#)

[Interactive](#)

[All poisonous plants by
Botanical name](#)

[All poisonous plants by
Common name](#)

[Important WWW Poisonous
Plants sites](#)

General poisoning notes:

Sheep-laurel (*Kalmia angustifolia*) is a native shrub found in eastern Canada in boggy areas. This plant contains a toxin that has poisoned cattle, goats, and sheep as well as humans. Poisoning rarely happens in the wild. Other animals have been poisoned by sheep-laurel, including zebras at a zoo, as well as horses. Meat of chickens that had ingested sheep-laurel may be toxic to other animals. The nectar contains the toxin that results in toxic honey (Marsh 1930, Kingsbury 1964, Verlangieri 1976, Lampe and McCann 1985).



References:

- Kingsbury, J. M. 1964. Poisonous plants of the United States and Canada. Prentice-Hall Inc., Englewood Cliffs, N.J., USA. 626 pp.
- Lampe, K. F., McCann, M. A. 1985. AMA Handbook of poisonous and injurious plants. American Medical Assoc. Chicago, Ill., USA. 432 pp.
- Marsh, C. D. 1930. Mountain-laurel (*Kalmia latifolia*) and sheep laurel (*Kalmia angustifolia*) as stock-poisoning plants. U. S. Dept. Agric. Tech. Bull., 219. 22 pp.
- Pritchard, W. R. 1956. Laurel (*Kalmia angustifolia*) poisoning of sheep. N. Am. Vet., 37: 461-462.
- Verlangieri, A. J., Gawlikowski, J. N., Shapiro, R. 1976. Acute toxicity of *Kalmia angustifolia*, (sheep laurel) extracts in the rat. Vet. Toxicol., 18: 122-124.

Nomenclature:

Scientific Name: *Kalmia angustifolia* L.

Vernacular name(s): sheep-laurel

Scientific family name: *Ericaceae*

Vernacular family name: heath

Go to ITIS^{*ca} for more taxonomic information on: [Kalmia angustifolia](#)

References:

Agriculture Quebec. 1975. Noms des maladies des plantes du Canada/ Names of plant diseases in Canada. , Quebec City, Que., Canada. 288 pp.

Alex, J. F., Cayouette, R., Mulligan, G. A. 1980. Common and botanical names of weeds in Canada/Noms populaire et scientifiques des plantes nuisibles du Canada. Revised. Agric. Can. Publ., Ottawa, Ont., Canada. 132 pp.

Bailey, L. H., Bailey, E. Z. 1976. Hortus third. Revised. MacMillan, New York, N.Y., USA. 1290 pp.

Scoggan, H. J. 1978, 1979. The flora of Canada. Nat. Mus. Nat. Sci. (Ottawa) Publ. Bot. 7(1)-7(4). 1711 pp.

Van Wijk, H. L. 1911. A dictionary of plant names. Martinus Nijhoff, The Hague, The Netherlands. 1444 pp.

Victorin, M. 1964. Flore Laurentienne. 2nd ed. Univ. Montreal, Montreal, Que., Canada. 952 pp.

Geographic Information

New Brunswick

Newfoundland

Nova Scotia

Ontario

Prince Edward Island

Quebec

References:

Bailey, L. H., Bailey, E. Z. 1976. Hortus third. Revised. MacMillan, New York, N.Y., USA. 1290 pp.

Boivin, B. 1966, 1967. Énumération des plantes du Canada. Provencheria 6. Nat. Can. (Que.) 93: 253-274; 371-437; 583-646; 989-1063. 94: 131-157; 471-528; 625-655.

Image or illustration

sheep-laurel:

Images: images.google.com

Notes on Poisonous plant parts:

The entire plant is poisonous, including the nectar and honey made from it (Pritchard 1956, Kingsbury 1964).

Toxic parts:

all parts
flowers
leaves
mature fruit
stems

References:

Pritchard, W. R. 1956. Laurel (*Kalmia angustifolia*) poisoning of sheep. N. Am. Vet., 37: 461-462.

Verlangieri, A. J., Gawlikowski, J. N., Shapiro, R. 1976. Acute toxicity of *Kalmia angustifolia*, (sheep laurel) extracts in the rat. Vet. Toxicol., 18: 122-124.

Notes on Toxic plant chemicals:

Andromedotoxin and resins derived from diterpenes are the toxic compounds found in all the toxic species of the heath plant family. The toxin is found even in the nectar of flowers (Fuller and McClintock 1986). Experimental poisoning of rats using leaf extracts resulted in an average LD-50 (female) of 8.2 g of green leaves per kilogram body weight. The leaves were toxic only in the spring. Leaves of plants growing in wet areas were more toxic than those growing in dry areas (Verlangieri et al. 1976).

Toxic plant chemicals:

andromedotoxins

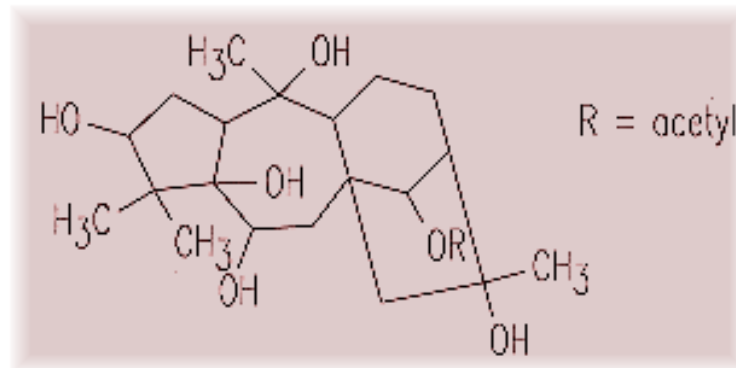

Chemical diagram(s) are courtesy of [Ruth McDiarmid](#), Biochemistry Technician, Kamloops Range Station, Agriculture and Agri-Food Canada,

Kamploops, British Columbia, Canada.

References:

Verlangieri, A. J., Gawlikowski, J. N., Shapiro, R. 1976. Acute toxicity of *Kalmia angustifolia*, (sheep laurel) extracts in the rat. *Vet. Toxicol.*, 18: 122-124.

Animals/Human Poisoning:

Note: When an animal is listed without additional information, the literature (as of 1993) contained no detailed explanation.

Cattle

General symptoms of poisoning:

[breathing, shallow](#)

[diarrhea](#)

[gait, staggering](#)

[incoordination](#)

[recumbency](#)

[salivation](#)

[vomiting](#)

Notes on poisoning:

Experimental poisoning of cattle showed symptoms, including soft feces, salivation, vomiting, diarrhea, and incoordination. Consuming green leaves equivalent to 0.2% of an animal's body weight was determined to cause toxic signs in cattle (Marsh 1930). A few cattle in the field were poisoned after ingesting sheep-laurel (Kingsbury 1964).

References:

Kingsbury, J. M. 1964. *Poisonous plants of the United States and Canada*. Prentice-Hall Inc., Englewood Cliffs, N.J., USA. 626 pp.

Marsh, C. D. 1930. Mountain-laurel (*Kalmia latifolia*) and sheep laurel (*Kalmia angustifolia*) as stock-poisoning plants. *U. S. Dept. Agric. Tech. Bull.*, 219. 22 pp.

Goats

General symptoms of poisoning:

[incoordination](#)

[recumbency](#)

[vomiting](#)

[weakness](#)

Notes on poisoning:

Experimental poisoning of goats fed green leaves resulted in symptoms, including profuse vomiting, staggering, recumbency, weakness, shallow breath, and teeth grinding. Sheep-laurel causes toxic signs in goats if ingested green material equaled at least 0.25% of animal body weight (Marsh 1930).

References:

Kingsbury, J. M. 1964. Poisonous plants of the United States and Canada. Prentice-Hall Inc., Englewood Cliffs, N.J., USA. 626 pp.

Humans

General symptoms of poisoning:

[coma](#)

References:

Lampe, K. F., McCann, M. A. 1985. AMA Handbook of poisonous and injurious plants. American Medical Assoc. Chicago, Ill., USA. 432 pp.

Rodents

General symptoms of poisoning:

[coma](#)

[convulsions](#)

[death](#)

[nasal discharge](#)

[paralysis](#)

[salivation](#)

[vomiting](#)

References:

Verlangieri, A. J., Gawlikowski, J. N., Shapiro, R. 1976. Acute toxicity of *Kalmia angustifolia*, (sheep laurel) extracts in the rat. Vet. Toxicol., 18: 122-124.

Sheep

General symptoms of poisoning:

[ataxia](#)

[coma](#)

[convulsions](#)

[death](#)

[depression](#)

[dyspnea](#)

[headache](#)

[nasal discharge](#)

[pupil dilation](#)

[recumbency](#)

[salivation](#)

[vomiting](#)

Notes on poisoning:

Experimental poisoning of a goat caused symptoms of poisoning similar to those seen in sheep. A dosage of green leaves equal to 0.5% of an animal's body weight caused symptoms to occur (Clawson 1933).

References:

Kingsbury, J. M. 1964. Poisonous plants of the United States and Canada. Prentice-Hall Inc., Englewood Cliffs, N.J., USA. 626 pp.

Pritchard, W. R. 1956. Laurel (*Kalmia angustifolia*) poisoning of sheep. N. Am. Vet., 37: 461-462.

[Another search?](#)

[Français](#) | [Contact Us](#) | [Help](#) | [Search](#) | [Canada site](#)

[Coming Events](#) | [About CBIF](#) | [Links](#) | [Reports and Publications](#) | [Home](#)

Date modified: 2003-02-06

[Important Notices](#)



Français	Contact us	Help	Search	Canada site
Coming events	About CBIF	Links	Reports and publications	Home

Canadian Biodiversity Information Facility



Notes on poisoning: showy lady's-slipper

[Introduction](#)

[Interactive](#)

[All poisonous plants by Botanical name](#)

[All poisonous plants by Common name](#)

[Important WWW Poisonous Plants sites](#)

General poisoning notes:

Showy lady's-slipper (*Cypripedium reginae*) is a native orchid found in eastern Canada. The plant can cause dermatitis in sensitive individuals. The symptoms are similar to those of poison-ivy (*Rhus spp.*). See additional information under general notes of [Cypripedium acaule](#).



References:

Reddoch, A. H., Reddoch, J. M. 1984. Warning: Lady's-slippers can be hazardous to your health. Plant Press, 2(1): 10.

Nomenclature:

Scientific Name: *Cypripedium reginae* Walt.

Vernacular name(s): showy lady's-slipper

Scientific family name: *Orchidaceae*

Vernacular family name: orchid

Go to ITIS*^{ca} for more taxonomic information on: [Cypripedium reginae](#)

References:

Agriculture Quebec. 1975. Noms des maladies des plantes du Canada/ Names of plant diseases in Canada. , Quebec City, Que., Canada. 288 pp.

Alex, J. F., Cayouette, R., Mulligan, G. A. 1980. Common and botanical names of weeds in Canada/Noms populaire et scientifiques des plantes nuisibles du Canada. Revised. Agric. Can. Publ., Ottawa, Ont., Canada. 132 pp.

Bailey, L. H., Bailey, E. Z. 1976. Hortus third. Revised. MacMillan, New York, N.Y., USA. 1290 pp.

Scoggan, H. J. 1978, 1979. The flora of Canada. Nat. Mus. Nat. Sci. (Ottawa) Publ. Bot. 7(1)-7(4). 1711 pp.

Van Wijk, H. L. 1911. A dictionary of plant names. Martinus Nijhoff, The Hague, The Netherlands. 1444 pp.

Victorin, M. 1964. Flore Laurentienne. 2nd ed. Univ. Montreal, Montreal, Que., Canada. 952 pp.

Geographic Information

Manitoba
New Brunswick
Newfoundland
Nova Scotia
Ontario
Prince Edward Island
Quebec

References:

Bailey, L. H., Bailey, E. Z. 1976. Hortus third. Revised. MacMillan, New York, N.Y., USA. 1290 pp.

Boivin, B. 1966, 1967. Énumération des plantes du Canada. Provencheria 6. Nat. Can. (Que.) 93: 253-274; 371-437; 583-646; 989-1063. 94: 131-157; 471-528; 625-655.

Image or illustration

showy lady's-slipper:

Images: images.google.com

Toxic parts:

leaves
stems

References:

Reddoch, A. H., Reddoch, J. M. 1984. Warning: Lady's-slippers can be hazardous to your health. Plant Press, 2(1): 10.

Toxic plant chemicals:

cypripedin

References:

Reddoch, A. H., Reddoch, J. M. 1984. Warning: Lady's-slippers can be hazardous to your health. Plant Press, 2(1): 10.

Animals/Human Poisoning:

Note: When an animal is listed without additional information, the literature (as of 1993) contained no detailed explanation.

Humans

General symptoms of poisoning:

[blisters, weeping](#)

References:

Reddoch, A. H., Reddoch, J. M. 1984. Warning: Lady's-slippers can be hazardous to your health. Plant Press, 2(1): 10.

[Another search?](#)

[Français](#) | [Contact Us](#) | [Help](#) | [Search](#) | [Canada site](#)

[Coming Events](#) | [About CBIF](#) | [Links](#) | [Reports and Publications](#) | [Home](#)

Date modified: 2003-02-06

[Important Notices](#)



Français	Contact us	Help	Search	Canada site
Coming events	About CBIF	Links	Reports and publications	Home

Canadian Biodiversity Information Facility



Notes on poisoning: showy milkweed

[Introduction](#)

[Interactive](#)

[All poisonous plants by Botanical name](#)

[All poisonous plants by Common name](#)

[Important WWW Poisonous Plants sites](#)

General poisoning notes:

Showy milkweed (*Asclepias speciosa*) is a native plant found in dry rangelands in western Canada. The plant is poisonous to sheep and cattle. However, this plant is so distasteful to livestock that they ingest it only under extreme circumstances (Fleming et al. 1920)



References:

Fleming, C. E., Peterson, N. F., Miller, M. R., Vawter, L. R., Wright, L. H. 1920. The narrow-leaved milkweed and the broad-leaved or showy milkweed. Plants poisonous to livestock in Nevada. Univ. Nev. Agric. Exp. Stn. Bull., 99. 32 pp.

Nomenclature:

Scientific Name: *Asclepias speciosa* Torr.

Vernacular name(s): showy milkweed

Scientific family name: *Asclepiadaceae*

Vernacular family name: milkweed

Go to ITIS*^{ca} for more taxonomic information on: [Asclepias speciosa](#)

References:

Agriculture Quebec. 1975. Noms des maladies des plantes du Canada/ Names of plant diseases in Canada. , Quebec City, Que., Canada. 288 pp.

Alex, J. F., Cayouette, R., Mulligan, G. A. 1980. Common and botanical names of weeds in Canada/Noms populaire et scientifiques des plantes nuisibles du Canada. Revised. Agric.

Can. Publ., Ottawa, Ont., Canada. 132 pp.

Bailey, L. H., Bailey, E. Z. 1976. Hortus third. Revised. MacMillan, New York, N.Y., USA. 1290 pp.

Scoggan, H. J. 1978, 1979. The flora of Canada. Nat. Mus. Nat. Sci. (Ottawa) Publ. Bot. 7(1)-7(4). 1711 pp.

Van Wijk, H. L. 1911. A dictionary of plant names. Martinus Nijhoff, The Hague, The Netherlands. 1444 pp.

Victorin, M. 1964. Flore Laurentienne. 2nd ed. Univ. Montreal, Montreal, Que., Canada. 952 pp.

Geographic Information

Alberta
British Columbia
Manitoba
Saskatchewan

References:

Bailey, L. H., Bailey, E. Z. 1976. Hortus third. Revised. MacMillan, New York, N.Y., USA. 1290 pp.

Boivin, B. 1966, 1967. Énumération des plantes du Canada. Provencheria 6. Nat. Can. (Que.) 93: 253-274; 371-437; 583-646; 989-1063. 94: 131-157; 471-528; 625-655.

Image or illustration

showy milkweed:

Images: images.google.com

Notes on Poisonous plant parts:

Experimental feeding tests on sheep showed that leaves are poisonous, but that large amounts must be ingested: (a 43-kg ewe died after ingesting 1 kg of green leaves. The pods and seeds are also poisonous (Fleming et al. 1920).

Toxic parts:

leaves
mature fruit
seeds

References:

Fleming, C. E., Peterson, N. F., Miller, M. R., Vawter, L. R., Wright, L. H. 1920. The narrow-leaved milkweed and the broad-leaved or showy milkweed. Plants poisonous to livestock in Nevada. Univ. Nev. Agric. Exp. Stn. Bull., 99. 32 pp.

Toxic plant chemicals:

desglucosyrioside
syrioside

References:

Joubert, J. P. 1989. Cardiac glycosides. Pages 61-97 in Cheeke, P. R., ed. Toxicants of plant origin. Vol. II. Glycosides. CRC Press, Inc., Boca Raton, Fla., USA. 277 pp.

Animals/Human Poisoning:

Note: When an animal is listed without additional information, the literature (as of 1993) contained no detailed explanation.

Cattle

Sheep

General symptoms of poisoning:

[appetite, loss of](#)
[breathing, labored](#)
[breathing with grunts](#)
[recumbency](#)

References:

Fleming, C. E., Peterson, N. F., Miller, M. R., Vawter, L. R., Wright, L. H. 1920. The narrow-leaved milkweed and the broad-leaved or showy milkweed. Plants poisonous to livestock in Nevada. Univ. Nev. Agric. Exp. Stn. Bull., 99. 32 pp.

[Another search?](#)

[Français](#) | [Contact Us](#) | [Help](#) | [Search](#) | [Canada site](#)

[Coming Events](#) | [About CBIF](#) | [Links](#) | [Reports and Publications](#) | [Home](#)

Date modified: 2003-02-06

[Important Notices](#)



Français	Contact us	Help	Search	Canada site
Coming events	About CBIF	Links	Reports and publications	Home

Canadian Biodiversity Information Facility



Notes on poisoning: Siberian scilla

[Introduction](#)[Interactive](#)[All poisonous plants by Botanical name](#)[All poisonous plants by Common name](#)[Important WWW Poisonous Plants sites](#)

General poisoning notes:

Siberian scilla (*Scilla siberica*) is a hardy perennial bulb planted outdoors, and sometimes forced indoors, for its beautiful early spring flowers. The entire plant contains cardiac glycosides, which can potentially cause poisoning if ingested. No cases of poisoning have been documented. This is not a good plant to have around children or pets, which have a habit of chewing leaves. Other *Scilla* species may be available in Canada and may also contain toxins. *Scilla* species may also cause skin irritation in sensitive individuals (Lampe and McCann 1985, Spoerke and Smolinske 1990).



References:

Lampe, K. F., McCann, M. A. 1985. AMA Handbook of poisonous and injurious plants. American Medical Assoc. Chicago, Ill., USA. 432 pp.

Spoerke, D. G., Smolinske, S. C. 1990. Toxicity of houseplants. CRC Press, Inc., Boca Raton, Fla., USA. 335 pp.

Nomenclature:

Scientific Name: *Scilla siberica* Andr.

Vernacular name(s): Siberian scilla

Scientific family name: *Liliaceae*

Vernacular family name: lily

Go to ITIS^{*ca} for more taxonomic information on: [Scilla siberica](#)

References:

Agriculture Quebec. 1975. Noms des maladies des plantes du Canada/ Names of plant diseases in Canada. , Quebec City, Que., Canada. 288 pp.

Alex, J. F., Cayouette, R., Mulligan, G. A. 1980. Common and botanical names

of weeds in Canada/Noms populaire et scientifiques des plantes nuisibles du Canada. Revised. Agric. Can. Publ., Ottawa, Ont., Canada. 132 pp.

Bailey, L. H., Bailey, E. Z. 1976. Hortus third. Revised. MacMillan, New York, N.Y., USA. 1290 pp.

Scoggan, H. J. 1978, 1979. The flora of Canada. Nat. Mus. Nat. Sci. (Ottawa) Publ. Bot. 7(1)-7(4). 1711 pp.

Van Wijk, H. L. 1911. A dictionary of plant names. Martinus Nijhoff, The Hague, The Netherlands. 1444 pp.

Victorin, M. 1964. Flore Laurentienne. 2nd ed. Univ. Montreal, Montreal, Que., Canada. 952 pp.

Geographic Information

Plant or plant parts used in or around the home.

References:

Bailey, L. H., Bailey, E. Z. 1976. Hortus third. Revised. MacMillan, New York, N.Y., USA. 1290 pp.

Boivin, B. 1966, 1967. Énumération des plantes du Canada. Provencheria 6. Nat. Can. (Que.) 93: 253-274; 371-437; 583-646; 989-1063. 94: 131-157; 471-528; 625-655.

Image or illustration

Siberian scilla:

Images: images.google.com

Notes on Poisonous plant parts:

The entire plant contains the toxins, including the bulbs and flowers (Lampe and McCann 1985).

Toxic parts:

all parts
bulbs
flowers
leaves

References:

Lampe, K. F., McCann, M. A. 1985. AMA Handbook of poisonous and injurious plants. American Medical Assoc. Chicago, Ill., USA. 432 pp.

Spoerke, D. G., Smolinske, S. C. 1990. Toxicity of houseplants. CRC Press, Inc., Boca Raton, Fla., USA. 335 pp.

Notes on Toxic plant chemicals:

Many *Scilla* species contain cardiac glycosides, scilla-dienolides, which act like digitalis (Spoerke and Smolinske 1990).

Toxic plant chemicals:

scilla-dienolides

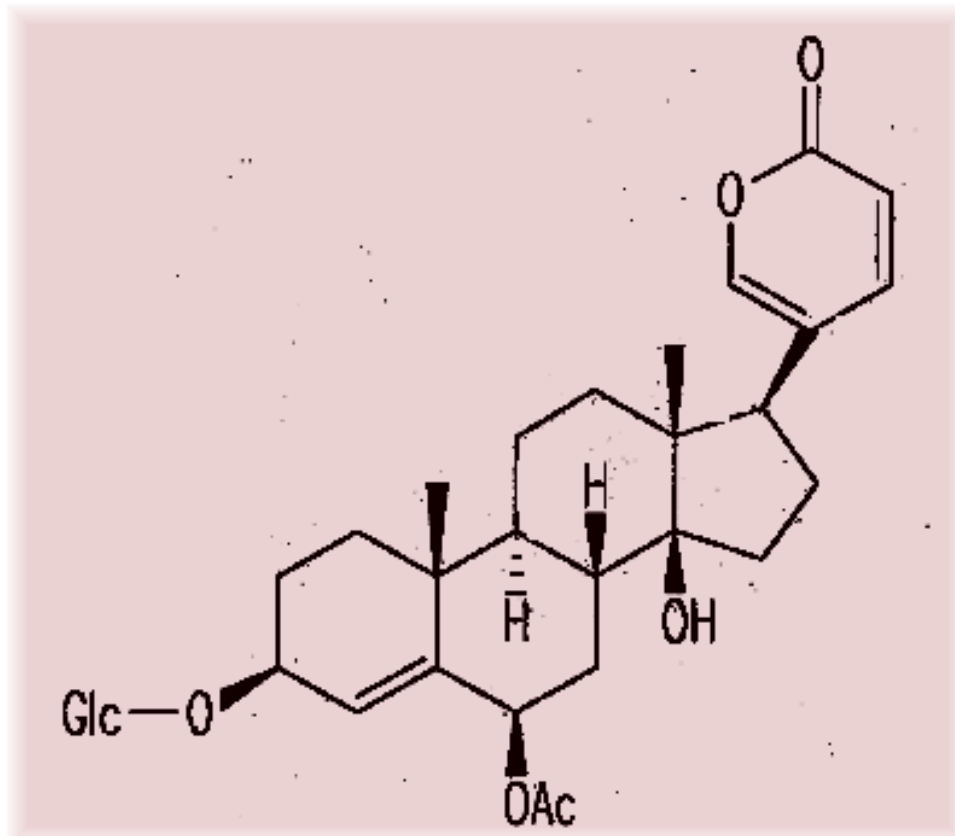

Chemical diagram(s) are courtesy of [Ruth McDiarmid](#), Biochemistry Technician, Kamloops Range Station, Agriculture and Agri-Food Canada, Kamloops, British Columbia, Canada.

References:

Spoerke, D. G., Smolinske, S. C. 1990. Toxicity of houseplants. CRC Press, Inc., Boca Raton, Fla., USA. 335 pp.

Animals/Human Poisoning:

Note: When an animal is listed without additional information, the literature (as of 1993) contained no detailed explanation.

Humans

General symptoms of poisoning:

[abdominal pains](#)

[diarrhea](#)

[vomiting](#)

Notes on poisoning:

Symptoms can include pain in the mouth cavity, abdominal pains, cramps, diarrhea, and an irregular pulse. Several species of *Scilla* are reported to irritate the skin of sensitive individuals (Spoerke and Smolinske 1990).

References:

Lampe, K. F., McCann, M. A. 1985. AMA Handbook of poisonous and injurious plants. American Medical Assoc. Chicago, Ill., USA. 432 pp.

Spoerke, D. G., Smolinske, S. C. 1990. Toxicity of houseplants. CRC Press, Inc., Boca Raton, Fla., USA. 335 pp.

[Another search?](#)

[Français](#) | [Contact Us](#) | [Help](#) | [Search](#) | [Canada site](#)

[Coming Events](#) | [About CBIF](#) | [Links](#) | [Reports and Publications](#) | [Home](#)

Date modified: 2003-02-06

[Important Notices](#)



Français	Contact us	Help	Search	Canada site
Coming events	About CBIF	Links	Reports and publications	Home

Canadian Biodiversity Information Facility



Notes on poisoning: silky lupine

[Introduction](#)

[Interactive](#)

[All poisonous plants by Botanical name](#)

[All poisonous plants by Common name](#)

[Important WWW Poisonous Plants sites](#)



General poisoning notes:

Silky lupine (*Lupinus sericeus*) is a native herb of western Canada. This lupine has caused poisoning and death in cattle, goats, horses, and sheep. Sheep eat the plants more readily than do other animals and are therefore more commonly poisoned. Cattle also suffer from crooked calf disease, a teratogenic syndrome caused by maternal ingestion of certain lupines between day 40 and day 70 of gestation. The calves can suffer from arthrogryposis, scoliosis, and other deformities. Humans are also at risk from lupine toxins. In one case in California, a child was born with limb deformities. The family raised milk goats that had also given birth to kids with deformed limbs, and a dog gave birth to deformed pups. All had ingested the goat's milk during pregnancy. Anagryne in a local lupine species was believed to cause the problem. Tests showed that lactating goats that ingest lupine seeds pass anagryne in the milk. Edible lupine seeds are being marketed in health food stores. In Edmonton (Smith 1987), a woman suffered mild dizziness and incoordination after ingesting the seeds. She did not follow specific instructions to soak and boil the seeds in several changes of water, which is necessary to remove the toxins.

References:

Keeler, R. F. 1989. Quinolizidine alkaloids in range and grain lupins. Pages 133-167 in Cheeke, P. R., ed. Toxicants of plant origin. Vol. I. Alkaloids. CRC Press, Inc., Boca Raton, Fla., USA. 335 pp.

Kingsbury, J. M. 1964. Poisonous plants of the United States and Canada. Prentice-Hall Inc., Englewood Cliffs, N.J., USA. 626 pp.

Nomenclature:

Scientific Name: *Lupinus sericeus* Pursh

Vernacular name(s): silky lupine

Scientific family name: *Leguminosae*

Vernacular family name: pea

Go to ITIS*^{ca} for more taxonomic information on: [Lupinus sericeus](#)

References:

Agriculture Quebec. 1975. Noms des maladies des plantes du Canada/ Names of plant diseases in Canada. , Quebec City, Que., Canada. 288 pp.

Alex, J. F., Cayouette, R., Mulligan, G. A. 1980. Common and botanical names of weeds in Canada/Noms populaire et scientifiques des plantes nuisibles du Canada. Revised. Agric. Can. Publ., Ottawa, Ont., Canada. 132 pp.

Bailey, L. H., Bailey, E. Z. 1976. Hortus third. Revised. MacMillan, New York, N.Y., USA. 1290 pp.

Scoggan, H. J. 1978, 1979. The flora of Canada. Nat. Mus. Nat. Sci. (Ottawa) Publ. Bot. 7(1)-7(4). 1711 pp.

Van Wijk, H. L. 1911. A dictionary of plant names. Martinus Nijhoff, The Hague, The Netherlands. 1444 pp.

Victorin, M. 1964. Flore Laurentienne. 2nd ed. Univ. Montreal, Montreal, Que., Canada. 952 pp.

Geographic Information

Alberta
British Columbia
Yukon Territory

References:

Bailey, L. H., Bailey, E. Z. 1976. Hortus third. Revised. MacMillan, New York, N.Y., USA. 1290 pp.

Boivin, B. 1966, 1967. Énumération des plantes du Canada. Provencheria 6. Nat. Can. (Que.) 93: 253-274; 371-437; 583-646; 989-1063. 94: 131-157; 471-528; 625-655.

Image or illustration

silky lupine:

Images: images.google.com

Notes on Poisonous plant parts:

The teratogenic alkaloid anagyrine is highest in the seeds, pods, and young leaves. The quinolizidine alkaloids implicated in lupine poisoning and death are found mostly in the seeds and pods. Large quantities of the plant material must be ingested in a short time. The alkaloids remain after drying, so that hay containing sufficient quantities of lupine can be toxic (Kingsbury 1964, Keeler 1989).

Toxic parts:

leaves
mature fruit
seeds
stems

References:

Davis, A. M., Stout, D. M. 1986. Anagyrine in western American lupines. *J. Range Manage.*, 39: 29-30.

Keeler, R. F. 1989. Quinolizidine alkaloids in range and grain lupins. Pages 133-167 in Cheeke, P. R., ed. *Toxicants of plant origin. Vol. I. Alkaloids.* CRC Press, Inc., Boca Raton, Fla., USA. 335 pp.

Kingsbury, J. M. 1964. *Poisonous plants of the United States and Canada.* Prentice-Hall Inc., Englewood Cliffs, N.J., USA. 626 pp.

Notes on Toxic plant chemicals:

Silky lupine contains two major quinolizidine alkaloids, lupanine and sparteine. These alkaloids and their derivatives cause poisoning and death in livestock. This species also contains a teratogenic chemical, anagyrine, which causes birth deformities in calves after maternal ingestion of the plants between day 40 and day 70. Amounts of up to 6.84 g/kg have been measured, which exceeds the minimum of 1.44 g/kg required to cause crooked calf disease (Davis and Stout 1986, Keeler 1989). The LD-50 of lupanine by oral ingestion in rats is 1464 mg/kg. This alkaloid is rapidly cleared from the body (Pettersen et al. 1987).

Toxic plant chemicals:

anagyrine
lupanine

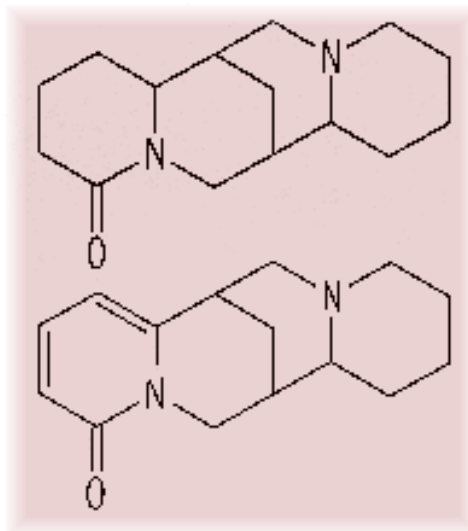

sparteine

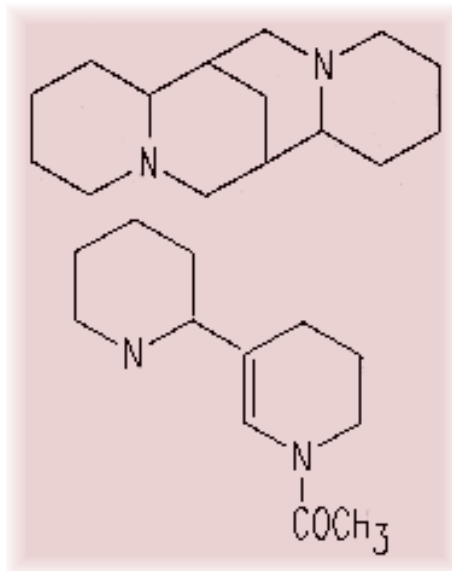

Chemical diagram(s) are courtesy of [Ruth McDiarmid](#), Biochemistry Technician, Kamloops Range Station, Agriculture and Agri-Food Canada, Kamloops, British Columbia, Canada.

References:

Davis, A. M., Stout, D. M. 1986. Anagryne in western American lupines. *J. Range Manage.*, 39: 29-30.

Keeler, R. F. 1989. Quinolizidine alkaloids in range and grain lupins. Pages 133-167 in Cheeke, P. R., ed. *Toxicants of plant origin. Vol. I. Alkaloids.* CRC Press, Inc., Boca Raton, Fla., USA. 335 pp.

Petterson, D. S., Ellis, Z. L., Harris, D. J., Spadek, Z. E. 1987. Acute toxicity of the major alkaloids of cultivated *Lupinus angustifolius* seed to rats. *J. Appl. Toxicol.*, 7: 51-53.

Animals/Human Poisoning:

Note: When an animal is listed without additional information, the literature (as of 1993) contained no detailed explanation.

Cattle

General symptoms of poisoning:

[arthrogryposis](#)

[breathing, labored](#)

[convulsions](#)

[palatoschisis](#)

[scoliosis](#)

[torticollis](#)

[trembling](#)

Notes on poisoning:

Cattle do not eat lupines as readily as sheep and therefore seldom ingest lethal quantities. Symptoms are similar to those of sheep (Kingsbury 1964).

References:

Keeler, R. F. 1989. Quinolizidine alkaloids in range and grain lupins. Pages 133-167 in Cheeke, P. R., ed. Toxicants of plant origin. Vol. I. Alkaloids. CRC Press, Inc., Boca Raton, Fla., USA. 335 pp.

Kingsbury, J. M. 1964. Poisonous plants of the United States and Canada. Prentice-Hall Inc., Englewood Cliffs, N.J., USA. 626 pp.

Horses

General symptoms of poisoning:

[breathing, labored](#)

[convulsions](#)

[trembling](#)

Notes on poisoning:

Horses do not ingest lupines as readily as do sheep. Toxic symptoms therefore seldom appear in horses. Symptoms are similar to those seen in sheep (Kingsbury 1964).

References:

Kingsbury, J. M. 1964. Poisonous plants of the United States and

Humans

General symptoms of poisoning:

[dizziness](#)

[incoordination](#)

Notes on poisoning:

Smith (1987) reports the case of a woman who complained of dizziness and incoordination after ingesting edible lupine seeds purchased in Edmonton. The women had not followed the cooking instructions, which required soaking and boiling the seeds in several changes of water. The toxic alkaloids are removed through several stages of cooking; the process must be continued until no bitterness is left. In lupine seeds a lethal dose of lupanine has been determined to be about 100 mg/kg. If not properly cooked, 10 g of seeds may liberate more than 100 mg of lupanine. Keeler (1989) discusses a possible link between ingesting goat's milk and the occurrence of birth deformities in a baby. The goats may have been eating a lupine species that contained the teratogenic chemical anagryne, which was passed through the woman when she drank goat's milk during pregnancy.

References:

Keeler, R. F. 1989. Quinolizidine alkaloids in range and grain lupins. Pages 133-167 in Cheeke, P. R., ed. Toxicants of plant origin. Vol. I. Alkaloids. CRC Press, Inc., Boca Raton, Fla., USA. 335 pp.

Sheep

General symptoms of poisoning:

[breathing, labored](#)

[coma](#)

[convulsions](#)

[death by asphyxiation](#)

[depression](#)

[dyspnea](#)

Notes on poisoning:

Symptoms of lupine ingestion in sheep include labored breathing, depression, coma (often with snoring), and death from asphyxiation. Tremors and convulsions may occur. The animal may butt other sheep or stand leaning against an object. Teeth

grinding and frothing have been observed. Sheep consume lupine more readily than do other livestock and are therefore the major species susceptible to lupine toxicity. Ingesting seeds equal to 0.25-0.5% of body weight can cause poisoning (Keeler 1964).

References:

Kingsbury, J. M. 1964. Poisonous plants of the United States and Canada. Prentice-Hall Inc., Englewood Cliffs, N.J., USA. 626 pp.

[Another search?](#)

[Français](#) | [Contact Us](#) | [Help](#) | [Search](#) | [Canada site](#)

[Coming Events](#) | [About CBIF](#) | [Links](#) | [Reports and Publications](#) | [Home](#)

Date modified: 2003-02-06

[Important Notices](#)



Français	Contact us	Help	Search	Canada site
Coming events	About CBIF	Links	Reports and publications	Home

Canadian Biodiversity Information Facility



Notes on poisoning: silvery lupine

[Introduction](#)

[Interactive](#)

[All poisonous plants by Botanical name](#)

[All poisonous plants by Common name](#)

[Important WWW Poisonous Plants sites](#)

General poisoning notes:

Silvery lupine (*Lupinus argenteus*) is a western range plant that has caused sickness and death in sheep in western North America. Ingestion of this plant by pregnant cattle can also cause teratogenic effects in calves (Cheeke and Schull 1985, Keeler 1989). See additional notes under silky lupine ([Lupinus sericeus](#)).



References:

Cheeke, P. R., Shull, L. R. 1985. Natural toxicants in feeds and poisonous plants. AVI Publishing Company, Inc., Westport, Conn., USA. 492 pp.

Keeler, R. F. 1989. Quinolizidine alkaloids in range and grain lupins. Pages 133-167 in Cheeke, P. R., ed. Toxicants of plant origin. Vol. I. Alkaloids. CRC Press, Inc., Boca Raton, Fla., USA. 335 pp.

Nomenclature:

Scientific Name: *Lupinus argenteus* Pursh

Vernacular name(s): silvery lupine

Scientific family name: *Leguminosae*

Vernacular family name: pea

Go to ITIS*^{ca} for more taxonomic information on: [Lupinus argenteus](#)

References:

Agriculture Quebec. 1975. Noms des maladies des plantes du Canada/ Names of plant diseases in Canada. , Quebec City, Que., Canada. 288 pp.

Alex, J. F., Cayouette, R., Mulligan, G. A. 1980. Common and botanical names of weeds in Canada/Noms populaire et scientifiques des plantes nuisibles du Canada. Revised. Agric. Can. Publ., Ottawa, Ont., Canada. 132 pp.

Bailey, L. H., Bailey, E. Z. 1976. Hortus third. Revised. MacMillan, New York, N.Y., USA. 1290 pp.

Scoggan, H. J. 1978, 1979. The flora of Canada. Nat. Mus. Nat. Sci. (Ottawa) Publ. Bot. 7(1)-7(4). 1711 pp.

Van Wijk, H. L. 1911. A dictionary of plant names. Martinus Nijhoff, The Hague, The Netherlands. 1444 pp.

Victorin, M. 1964. Flore Laurentienne. 2nd ed. Univ. Montreal, Montreal, Que., Canada. 952 pp.

Geographic Information

Alberta
British Columbia
Manitoba
Saskatchewan

References:

Bailey, L. H., Bailey, E. Z. 1976. Hortus third. Revised. MacMillan, New York, N.Y., USA. 1290 pp.

Boivin, B. 1966, 1967. Énumération des plantes du Canada. Provencheria 6. Nat. Can. (Que.) 93: 253-274; 371-437; 583-646; 989-1063. 94: 131-157; 471-528; 625-655.

Image or illustration

silvery lupine:

Images: images.google.com

Notes on Poisonous plant parts:

The concentration of anagryne decreases in the leaves once the seeds begin to form, and then is greatest in the seeds. Total alkaloid content is greatest in the seeds. See notes under silky lupine (*Lupinus sericeus*) for additional information.

Toxic parts:

leaves
seeds

References:

Keeler, R. F. 1989. Quinolizidine alkaloids in range and grain lupins. Pages 133-167 in Cheeke, P. R., ed. Toxicants of plant origin. Vol. I. Alkaloids. CRC Press, Inc., Boca Raton, Fla., USA. 335 pp.

Notes on Toxic plant chemicals:

Two alkaloids, lupanine and sparteine, (both quinolizidine alkaloids), are probably involved in causing poisoning in sheep (Keeler 1989). This species also has been found to contain 3.34 g/kg of anagryne, exceeding the minimum level of 1.44 g/kg needed to cause crooked calf disease (Davis 1982, Davis and Stout 1986).

Toxic plant chemicals:

anagryne

lupanine

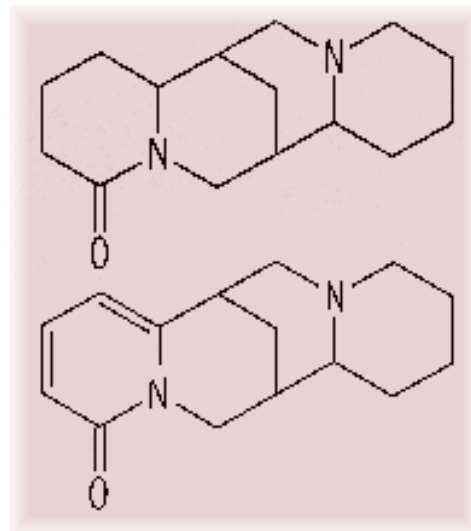

Chemical diagram(s) are courtesy of [Ruth McDiarmid](#), Biochemistry Technician, Kamloops Range Station, Agriculture and Agri-Food Canada, Kamloops, British Columbia, Canada.

References:

Davis, A. M., Stout, D. M. 1986. Anagryne in western American lupines. *J. Range Manage.*, 39: 29-30.

Davis, A. M. 1982. The occurrence of anagryne in a collection of western American lupines. *J. Range Manage.*, 35: 81-84.

Keeler, R. F. 1989. Quinolizidine alkaloids in range and grain lupins. Pages 133-167 in Cheeke, P. R., ed. Toxicants of plant origin. Vol. I. Alkaloids. CRC Press, Inc., Boca Raton, Fla.,

USA. 335 pp.

Animals/Human Poisoning:

Note: When an animal is listed without additional information, the literature (as of 1993) contained no detailed explanation.

Cattle

General symptoms of poisoning:

[arthrogryposis](#)

[palatoschisis](#)

[scoliosis](#)

[torticollis](#)

References:

Keeler, R. F. 1989. Quinolizidine alkaloids in range and grain lupins. Pages 133-167 in Cheeke, P. R., ed. Toxicants of plant origin. Vol. I. Alkaloids. CRC Press, Inc., Boca Raton, Fla., USA. 335 pp.

Sheep

General symptoms of poisoning:

[breathing, labored](#)

[coma](#)

[convulsions](#)

[death by asphyxiation](#)

[trembling](#)

Notes on poisoning:

Symptoms of ingestion include labored breathing, which may be accompanied by snoring, trembling, convulsions, coma, and death from respiratory paralysis (Keeler 1989). See additional notes under silky lupine [Lupinus sericeus](#)).

References:

Keeler, R. F. 1989. Quinolizidine alkaloids in range and grain lupins. Pages 133-167 in Cheeke, P. R., ed. Toxicants of plant origin. Vol. I. Alkaloids. CRC Press, Inc., Boca Raton, Fla., USA. 335 pp.

[Another search?](#)

[Français](#) | [Contact Us](#) | [Help](#) | [Search](#) | [Canada site](#)
[Coming Events](#) | [About CBIF](#) | [Links](#) | [Reports and Publications](#) |
[Home](#)

Date modified: 2003-02-06

[Important Notices](#)



Français	Contact us	Help	Search	Canada site
Coming events	About CBIF	Links	Reports and publications	Home

Canadian Biodiversity Information Facility



Notes on poisoning: skunk cabbage

[Introduction](#)

[Interactive](#)

[All poisonous plants by Botanical name](#)

[All poisonous plants by Common name](#)

[Important WWW Poisonous Plants sites](#)



General poisoning notes:

Skunk cabbage (*Symplocarpus foetidus*) is a robust native herb found in wet marshy areas in parts of eastern Canada. Ingesting the plant can cause intense pain and irritation in the mouth area after chewing the roots or leaves (Lampe and McCann 1985). No case reports of such irritation were found in the literature for humans or livestock.

References:

- Kingsbury, J. M. 1964. Poisonous plants of the United States and Canada. Prentice-Hall Inc., Englewood Cliffs, N.J., USA. 626 pp.
- Lampe, K. F., McCann, M. A. 1985. AMA Handbook of poisonous and injurious plants. American Medical Assoc. Chicago, Ill., USA. 432 pp.

Nomenclature:

Scientific Name: *Symplocarpus foetidus* (L.) Nutt.

Vernacular name(s): skunk cabbage

Scientific family name: *Araceae*

Vernacular family name: arum

Go to ITIS*^{ca} for more taxonomic information on: [Symplocarpus foetidus](#)

References:

- Agriculture Quebec. 1975. Noms des maladies des plantes du Canada/ Names of plant diseases in Canada. , Quebec City, Que., Canada. 288 pp.

Alex, J. F., Cayouette, R., Mulligan, G. A. 1980. Common and botanical names of weeds in Canada/Noms populaire et scientifiques des plantes nuisibles du Canada. Revised. Agric. Can. Publ., Ottawa, Ont., Canada. 132 pp.

Bailey, L. H., Bailey, E. Z. 1976. Hortus third. Revised. MacMillan, New York, N.Y., USA. 1290 pp.

Scoggan, H. J. 1978, 1979. The flora of Canada. Nat. Mus. Nat. Sci. (Ottawa) Publ. Bot. 7(1)-7(4). 1711 pp.

Van Wijk, H. L. 1911. A dictionary of plant names. Martinus Nijhoff, The Hague, The Netherlands. 1444 pp.

Victorin, M. 1964. Flore Laurentienne. 2nd ed. Univ. Montreal, Montreal, Que., Canada. 952 pp.

Geographic Information

New Brunswick
Nova Scotia
Ontario
Quebec

References:

Bailey, L. H., Bailey, E. Z. 1976. Hortus third. Revised. MacMillan, New York, N.Y., USA. 1290 pp.

Boivin, B. 1966, 1967. Énumération des plantes du Canada. Provencheria 6. Nat. Can. (Que.) 93: 253-274; 371-437; 583-646; 989-1063. 94: 131-157; 471-528; 625-655.

Image or illustration

skunk cabbage:

Images: images.google.com

Toxic parts:

leaves
roots

References:

Lampe, K. F., McCann, M. A. 1985. AMA Handbook of poisonous and injurious plants. American Medical Assoc. Chicago, Ill., USA. 432 pp.

Toxic plant chemicals:

oxalate

References:

Kingsbury, J. M. 1964. Poisonous plants of the United States and Canada. Prentice-Hall Inc., Englewood Cliffs, N.J., USA. 626 pp.

Lampe, K. F., McCann, M. A. 1985. AMA Handbook of poisonous and injurious plants. American Medical Assoc. Chicago, Ill., USA. 432 pp.

Animals/Human Poisoning:

Note: When an animal is listed without additional information, the literature (as of 1993) contained no detailed explanation.

Humans

General symptoms of poisoning:

[aphonia](#)

[dysphagia](#)

[hoarseness](#)

[mouth, irritation of](#)

References:

Kingsbury, J. M. 1964. Poisonous plants of the United States and Canada. Prentice-Hall Inc., Englewood Cliffs, N.J., USA. 626 pp.

Lampe, K. F., McCann, M. A. 1985. AMA Handbook of poisonous and injurious plants. American Medical Assoc. Chicago, Ill., USA. 432 pp.

[Another search?](#)

[Français](#) | [Contact Us](#) | [Help](#) | [Search](#) | [Canada site](#)

[Coming Events](#) | [About CBIF](#) | [Links](#) | [Reports and Publications](#) |

[Home](#)

Date modified: 2003-02-06

[Important Notices](#)



Français	Contact us	Help	Search	Canada site
Coming events	About CBIF	Links	Reports and publications	Home

Canadian Biodiversity Information Facility



Notes on poisoning: small lupine

[Introduction](#)

[Interactive](#)

[All poisonous plants by Botanical name](#)

[All poisonous plants by Common name](#)

[Important WWW Poisonous Plants sites](#)

General poisoning notes:

Small lupine (*Lupine pusillus*) is a native herb in the southern prairies. This species has been involved in poisoning of sheep (Fuller and McClintock 1986). See additional information under silky lupine ([Lupinus sericeus](#)).



References:

Fuller, T. C., McClintock, E. 1986. Poisonous plants of California. Univ. California Press, Berkeley, Calif., USA. 432 pp.

Nomenclature:

Scientific Name: *Lupinus pusillus* Pursh

Vernacular name(s): small lupine

Scientific family name: *Leguminosae*

Vernacular family name: pea

Go to ITIS^{*ca} for more taxonomic information on: [Lupinus pusillus](#)

References:

Agriculture Quebec. 1975. Noms des maladies des plantes du Canada/ Names of plant diseases in Canada. , Quebec City, Que., Canada. 288 pp.

Alex, J. F., Cayouette, R., Mulligan, G. A. 1980. Common and botanical names of weeds in Canada/Noms populaire et scientifiques des plantes nuisibles du Canada. Revised. Agric. Can. Publ., Ottawa, Ont., Canada. 132 pp.

Bailey, L. H., Bailey, E. Z. 1976. Hortus third. Revised.

MacMillan, New York, N.Y., USA. 1290 pp.

Scoggan, H. J. 1978, 1979. The flora of Canada. Nat. Mus. Nat. Sci. (Ottawa) Publ. Bot. 7(1)-7(4). 1711 pp.

Van Wijk, H. L. 1911. A dictionary of plant names. Martinus Nijhoff, The Hague, The Netherlands. 1444 pp.

Victorin, M. 1964. Flore Laurentienne. 2nd ed. Univ. Montreal, Montreal, Que., Canada. 952 pp.

Geographic Information

Alberta

Saskatchewan

References:

Bailey, L. H., Bailey, E. Z. 1976. Hortus third. Revised. MacMillan, New York, N.Y., USA. 1290 pp.

Boivin, B. 1966, 1967. Énumération des plantes du Canada. Provencheria 6. Nat. Can. (Que.) 93: 253-274; 371-437; 583-646; 989-1063. 94: 131-157; 471-528; 625-655.

Image or illustration

small lupine:

Images: images.google.com

Toxic parts:

leaves

seeds

References:

Kingsbury, J. M. 1964. Poisonous plants of the United States and Canada. Prentice-Hall Inc., Englewood Cliffs, N.J., USA. 626 pp.

Notes on Toxic plant chemicals:

Small lupine contains quinolizidine alkaloids, which have resulted in poisoning (Kingsbury 1964, Fuller and McClintock 1986).

Toxic plant chemicals:

unknown chemical

References:

Fuller, T. C., McClintock, E. 1986. Poisonous plants of California. Univ. California Press, Berkeley, Calif., USA. 432 pp.

Kingsbury, J. M. 1964. Poisonous plants of the United States and Canada. Prentice-Hall Inc., Englewood Cliffs, N.J., USA. 626 pp.

Animals/Human Poisoning:

Note: When an animal is listed without additional information, the literature (as of 1993) contained no detailed explanation.

Sheep

General symptoms of poisoning:

[breathing, labored](#)

[coma](#)

[convulsions](#)

[depression](#)

[muscle twitching](#)

References:

Fuller, T. C., McClintock, E. 1986. Poisonous plants of California. Univ. California Press, Berkeley, Calif., USA. 432 pp.

[Another search?](#)

[Français](#) | [Contact Us](#) | [Help](#) | [Search](#) | [Canada site](#)

[Coming Events](#) | [About CBIF](#) | [Links](#) | [Reports and Publications](#) | [Home](#)

Date modified: 2003-02-06

[Important Notices](#)



Français	Contact us	Help	Search	Canada site
Coming events	About CBIF	Links	Reports and publications	Home

Canadian Biodiversity Information Facility



Notes on poisoning: smooth pigweed

[Introduction](#)

[Interactive](#)

[All poisonous plants by Botanical name](#)

[All poisonous plants by Common name](#)

[Important WWW Poisonous Plants sites](#)

General poisoning notes:

Smooth pigweed (*Amaranthus retroflexus*) is a naturalized herb found in waste places across Canada. Ingesting this plant has caused nitrate poisoning of cattle in New Zealand. No other literature references to poisoning were found (Duckworth 1975).



References:

Duckworth, R. H. 1975. Poisoning of cattle by *Amaranthus*. N. Z. Vet. J., 23: 154-155.

Nomenclature:

Scientific Name: *Amaranthus hybridus* L.

Vernacular name(s): smooth pigweed

Scientific family name: *Amaranthaceae*

Vernacular family name: amaranth

Go to ITIS*^{ca} for more taxonomic information on: [Amaranthus hybridus](#)

References:

Agriculture Quebec. 1975. Noms des maladies des plantes du Canada/ Names of plant diseases in Canada. , Quebec City, Que., Canada. 288 pp.

Alex, J. F., Cayouette, R., Mulligan, G. A. 1980. Common and botanical names of weeds in Canada/Noms populaire et scientifiques des plantes nuisibles du Canada. Revised. Agric. Can. Publ., Ottawa, Ont., Canada. 132 pp.

Bailey, L. H., Bailey, E. Z. 1976. Hortus third. Revised.

MacMillan, New York, N.Y., USA. 1290 pp.

Scoggan, H. J. 1978, 1979. The flora of Canada. Nat. Mus. Nat. Sci. (Ottawa) Publ. Bot. 7(1)-7(4). 1711 pp.

Van Wijk, H. L. 1911. A dictionary of plant names. Martinus Nijhoff, The Hague, The Netherlands. 1444 pp.

Victorin, M. 1964. Flore Laurentienne. 2nd ed. Univ. Montreal, Montreal, Que., Canada. 952 pp.

Geographic Information

Ontario

References:

Bailey, L. H., Bailey, E. Z. 1976. Hortus third. Revised. MacMillan, New York, N.Y., USA. 1290 pp.

Boivin, B. 1966, 1967. Énumération des plantes du Canada. Provencheria 6. Nat. Can. (Que.) 93: 253-274; 371-437; 583-646; 989-1063. 94: 131-157; 471-528; 625-655.

Image or illustration

smooth pigweed:

Images: images.google.com

Toxic parts:

stems

References:

Duckworth, R. H. 1975. Poisoning of cattle by *Amaranthus*. N. Z. Vet. J., 23: 154-155.

Notes on Toxic plant chemicals:

Smooth pigweed (*Amaranthus hybridus*) has caused poisoning of cattle from nitrate accumulation. All the *Amaranthus* spp. listed in this information system are nitrate accumulators. In serious cases, poisoning and death can occur (Duckworth 1975, Osweiler et al. 1985).

Toxic plant chemicals:

nitrate

References:

Duckworth, R. H. 1975. Poisoning of cattle by *Amaranthus*. N. Z. Vet. J., 23: 154-155.

Animals/Human Poisoning:

Note: When an animal is listed without additional information, the literature (as of 1993) contained no detailed explanation.

Cattle

General symptoms of poisoning:

[blood brownish](#)

[death](#)

[gait, unsteady](#)

[mucous membrane, brown](#)

[nervousness](#)

Notes on poisoning:

In one case in New Zealand, cattle were poisoned and one died as a result of suspected nitrate poisoning after ingesting smooth pigweed. The mucous membranes were brown and the blood was dark. The animals were unsteady. Postmortem findings showed the rumen to be full of the plants, but no obvious lesions were present (Duckworth 1975).

References:

Duckworth, R. H. 1975. Poisoning of cattle by *Amaranthus*. N. Z. Vet. J., 23: 154-155.

Swine

[Another search?](#)

[Français](#) | [Contact Us](#) | [Help](#) | [Search](#) | [Canada site](#)

[Coming Events](#) | [About CBIF](#) | [Links](#) | [Reports and Publications](#) |

[Home](#)

Date modified: 2003-02-06

[Important Notices](#)



Français	Contact us	Help	Search	Canada site
Coming events	About CBIF	Links	Reports and publications	Home

Canadian Biodiversity Information Facility



Notes on poisoning: sneezeweed

[Introduction](#)

[Interactive](#)

[All poisonous plants by Botanical name](#)

[All poisonous plants by Common name](#)

[Important WWW Poisonous Plants sites](#)



General poisoning notes:

Sneezeweed (*Helenium autumnale*) is a native herb found in parts of central and western Canada. This plant causes illness and occasional death in cattle and horses. It has been proved to be experimentally toxic to dogs but it is very unlikely that dogs would voluntarily ingest it. The plant is well-named because it is highly irritating to the nose, eyes, and stomach (Kingsbury 1964, Cheeke and Schull 1985, Fuller and McClintock 1986, Herz 1988).

References:

Cheeke, P. R., Shull, L. R. 1985. Natural toxicants in feeds and poisonous plants. AVI Publishing Company, Inc., Westport, Conn., USA. 492 pp.

Fuller, T. C., McClintock, E. 1986. Poisonous plants of California. Univ. California Press, Berkeley, Calif., USA. 432 pp.

Herz, W. 1978. Sesquiterpene lactones from livestock poisons. Pages 487-497 in Keeler, R. F., Van Kampen, K. R., James, L. F., eds. Effects of poisonous plants on livestock. Academic Press, New York, N.Y., USA. 600 pp.

Kingsbury, J. M. 1964. Poisonous plants of the United States and Canada. Prentice-Hall Inc., Englewood Cliffs, N.J., USA. 626 pp.

Nomenclature:

Scientific Name: *Helenium autumnale* L.

Vernacular name(s): sneezeweed

Scientific family name: *Compositae*

Vernacular family name: composite

Go to ITIS^{*ca} for more taxonomic information on: [Helenium autumnale](#)

References:

Agriculture Quebec. 1975. Noms des maladies des plantes du Canada/ Names of plant diseases in Canada. , Quebec City, Que., Canada. 288 pp.

Alex, J. F., Cayouette, R., Mulligan, G. A. 1980. Common and botanical names of weeds in Canada/Noms populaire et scientifiques des plantes nuisibles du Canada. Revised. Agric. Can. Publ., Ottawa, Ont., Canada. 132 pp.

Bailey, L. H., Bailey, E. Z. 1976. Hortus third. Revised. MacMillan, New York, N.Y., USA. 1290 pp.

Scoggan, H. J. 1978, 1979. The flora of Canada. Nat. Mus. Nat. Sci. (Ottawa) Publ. Bot. 7(1)-7(4). 1711 pp.

Van Wijk, H. L. 1911. A dictionary of plant names. Martinus Nijhoff, The Hague, The Netherlands. 1444 pp.

Victorin, M. 1964. Flore Laurentienne. 2nd ed. Univ. Montreal, Montreal, Que., Canada. 952 pp.

Geographic Information

Alberta
British Columbia
Manitoba
Northwest Territories
Ontario
Quebec
Saskatchewan

References:

Bailey, L. H., Bailey, E. Z. 1976. Hortus third. Revised. MacMillan, New York, N.Y., USA. 1290 pp.

Boivin, B. 1966, 1967. Énumération des plantes du Canada. Provencheria 6. Nat. Can. (Que.) 93: 253-274; 371-437; 583-646; 989-1063. 94: 131-157; 471-528; 625-655.

Image or illustration

sneezeweed:

Images: images.google.com

Toxic parts:

leaves
stems

References:

Herz, W. 1978. Sesquiterpene lactones from livestock poisons. Pages 487-497 in Keeler, R. F., Van Kampen, K. R., James, L. F., eds. Effects of poisonous plants on livestock. Academic Press, New York, N.Y., USA. 600 pp.

Notes on Toxic plant chemicals:

Helenalin, a sesquiterpene lactone, is the major toxin found in sneezeweed. The LD-50 for helenalin is between 85 and 150 mg/kg, given orally to sheep. This compound contains a seven-membered ring, a lactone structure, and an exocyclic methylene group (Cheeke and Schull 1985, Herz 1988).

Toxic plant chemicals:

helenalin

References:

Herz, W. 1978. Sesquiterpene lactones from livestock poisons. Pages 487-497 in Keeler, R. F., Van Kampen, K. R., James, L. F., eds. Effects of poisonous plants on livestock. Academic Press, New York, N.Y., USA. 600 pp.

Animals/Human Poisoning:

Note: When an animal is listed without additional information, the literature (as of 1993) contained no detailed explanation.

Cattle

General symptoms of poisoning:

[breathing, labored](#)

[convulsions](#)

[death](#)

[incoordination](#)

[mouth, frothing of](#)

Notes on poisoning:

Sneezeweed causes poisoning and death in cattle. Symptoms

include frothing at the mouth, incoordination, and convulsions. The plant is highly irritating to the nose, eyes, and stomach. Cows that ingest this plant produce bitter-tasting milk (Kingsbury 1964, Fuller and McClintock 1986).

References:

Cheeke, P. R., Shull, L. R. 1985. Natural toxicants in feeds and poisonous plants. AVI Publishing Company, Inc., Westport, Conn., USA. 492 pp.

Herz, W. 1978. Sesquiterpene lactones from livestock poisons. Pages 487-497 in Keeler, R. F., Van Kampen, K. R., James, L. F., eds. Effects of poisonous plants on livestock. Academic Press, New York, N.Y., USA. 600 pp.

Kingsbury, J. M. 1964. Poisonous plants of the United States and Canada. Prentice-Hall Inc., Englewood Cliffs, N.J., USA. 626 pp.

Horses

General symptoms of poisoning:

[convulsions](#)

[incoordination](#)

[weakness](#)

References:

Fuller, T. C., McClintock, E. 1986. Poisonous plants of California. Univ. California Press, Berkeley, Calif., USA. 432 pp.

Herz, W. 1978. Sesquiterpene lactones from livestock poisons. Pages 487-497 in Keeler, R. F., Van Kampen, K. R., James, L. F., eds. Effects of poisonous plants on livestock. Academic Press, New York, N.Y., USA. 600 pp.

Humans

[Another search?](#)

[Français](#) | [Contact Us](#) | [Help](#) | [Search](#) | [Canada site](#)

[Coming Events](#) | [About CBIF](#) | [Links](#) | [Reports and Publications](#) |

[Home](#)

Date modified: 2003-02-06

[Important Notices](#)



Français	Contact us	Help	Search	Canada site
Coming events	About CBIF	Links	Reports and publications	Home

Canadian Biodiversity Information Facility



Notes on poisoning: snowdrop

[Introduction](#)[Interactive](#)[All poisonous plants by Botanical name](#)[All poisonous plants by Common name](#)[Important WWW Poisonous Plants sites](#)

General poisoning notes:

Snowdrop (*Galanthus nivalis*) is an outdoor ornamental spring flower. This plant contains the alkaloid lycorine, which can cause poisoning. Some individuals were poisoned after ingesting the bulbs as emergency food in Holland during World War II. Large amounts of bulbs need to be ingested to produce toxic reactions (Lampe and McCann 1985, Fuller and McClintock 1986).



References:

Frohne, D., Pfander, H. J. 1983. A colour atlas of poisonous plants. Wolfe Publishing Ltd., London, England. 291 pp.

Fuller, T. C., McClintock, E. 1986. Poisonous plants of California. Univ. California Press, Berkeley, Calif., USA. 432 pp.

Nomenclature:

Scientific Name: *Galanthus nivalis* L.

Vernacular name(s): snowdrop

Scientific family name: *Amaryllidaceae*

Vernacular family name: amaryllis

Go to ITIS^{*ca} for more taxonomic information on: [Galanthus nivalis](#)

References:

Agriculture Quebec. 1975. Noms des maladies des plantes du Canada/ Names of plant diseases in Canada. , Quebec City, Que., Canada. 288 pp.

Alex, J. F., Cayouette, R., Mulligan, G. A. 1980. Common and

botanical names of weeds in Canada/Noms populaire et scientifiques des plantes nuisibles du Canada. Revised. Agric. Can. Publ., Ottawa, Ont., Canada. 132 pp.

Bailey, L. H., Bailey, E. Z. 1976. Hortus third. Revised. MacMillan, New York, N.Y., USA. 1290 pp.

Scoggan, H. J. 1978, 1979. The flora of Canada. Nat. Mus. Nat. Sci. (Ottawa) Publ. Bot. 7(1)-7(4). 1711 pp.

Van Wijk, H. L. 1911. A dictionary of plant names. Martinus Nijhoff, The Hague, The Netherlands. 1444 pp.

Victorin, M. 1964. Flore Laurentienne. 2nd ed. Univ. Montreal, Montreal, Que., Canada. 952 pp.

Geographic Information

Plant or plant parts used in or around the home.

References:

Bailey, L. H., Bailey, E. Z. 1976. Hortus third. Revised. MacMillan, New York, N.Y., USA. 1290 pp.

Boivin, B. 1966, 1967. Énumération des plantes du Canada. Provencheria 6. Nat. Can. (Que.) 93: 253-274; 371-437; 583-646; 989-1063. 94: 131-157; 471-528; 625-655.

Image or illustration

snowdrop:

Images: images.google.com

Toxic parts:

bulbs

References:

Frohne, D., Pfander, H. J. 1983. A colour atlas of poisonous plants. Wolfe Publishing Ltd., London, England. 291 pp.

Toxic plant chemicals:

lycorine

References:

Frohne, D., Pfander, H. J. 1983. A colour atlas of poisonous

plants. Wolfe Publishing Ltd., London, England. 291 pp.

Animals/Human Poisoning:

Note: When an animal is listed without additional information, the literature (as of 1993) contained no detailed explanation.

Humans

General symptoms of poisoning:

[diarrhea](#)

[nausea](#)

[vomiting](#)

References:

Frohne, D., Pfander, H. J. 1983. A colour atlas of poisonous plants. Wolfe Publishing Ltd., London, England. 291 pp.

[Another search?](#)

[Français](#) | [Contact Us](#) | [Help](#) | [Search](#) | [Canada site](#)

[Coming Events](#) | [About CBIF](#) | [Links](#) | [Reports and Publications](#) |

[Home](#)

Date modified: 2003-02-06

[Important Notices](#)



Français	Contact us	Help	Search	Canada site
Coming events	About CBIF	Links	Reports and publications	Home

Canadian Biodiversity Information Facility



Notes on poisoning: Sorghum

[Introduction](#)[Interactive](#)[All poisonous plants by Botanical name](#)[All poisonous plants by Common name](#)[Important WWW Poisonous Plants sites](#)

General poisoning notes:

Sorghum (*Sorghum bicolor*) is a cultivated plant grown as ensilage, as poultry feed, or sometimes as broomcorn, for its long, flexible, high-quality broom fibers. Sorghum can contain a cyanogenic glycoside that can produce HCN during times of stress or if damaged by frost or mastication. Modern sorghums have been developed for their low HCN potential and are normally safe. Sorghum can also accumulate toxic levels of nitrates. Cattle and rarely horses have been poisoned (Kingsbury 1964, Gray et al. 1968, Clay et al. 1976).

References:

- Cheeke, P. R., Shull, L. R. 1985. Natural toxicants in feeds and poisonous plants. AVI Publishing Company, Inc., Westport, Conn., USA. 492 pp.
- Clay, B. R., Edwards, W. C., Peterson, D. R. 1976. Toxic nitrate accumulation in the sorghums. *Bovine Pract.*, 11: 28-32.
- Fuller, T. C., McClintock, E. 1986. Poisonous plants of California. Univ. California Press, Berkeley, Calif., USA. 432 pp.
- Gray, E., Rice, J. S., Wattenbarger, D., Benson, J. A., Hester, A. J., Loyd, R. C., Greene, B. M. 1968. Hydrocyanic acid potential of *Sorghum* plants grown in Tennessee. *Tenn. Agric. Exp. Stn. Bull.*, 445. 48 pp.
- Kingsbury, J. M. 1964. Poisonous plants of the United States and Canada. Prentice-Hall Inc., Englewood Cliffs, N.J., USA. 626 pp.
- Morgan, S. E., Johnson, B., Brewer, B., Walker, J. 1990. Sorghum cystitis ataxia syndrome in horses. *Vet. Hum. Toxicol.*, 32: 582.

Nomenclature:

Scientific Name: *Sorghum bicolor* (L.) Moench

Vernacular name(s): Sorghum

Scientific family name: *Gramineae*

Vernacular family name: grass

Go to ITIS^{*ca} for more taxonomic information on: [Sorghum bicolor](#)

References:

Agriculture Quebec. 1975. Noms des maladies des plantes du Canada/ Names of plant diseases in Canada. , Quebec City, Que., Canada. 288 pp.

Alex, J. F., Cayouette, R., Mulligan, G. A. 1980. Common and botanical names of weeds in Canada/Noms populaire et scientifiques des plantes nuisibles du Canada. Revised. Agric. Can. Publ., Ottawa, Ont., Canada. 132 pp.

Bailey, L. H., Bailey, E. Z. 1976. Hortus third. Revised. MacMillan, New York, N.Y., USA. 1290 pp.

Scoggan, H. J. 1978, 1979. The flora of Canada. Nat. Mus. Nat. Sci. (Ottawa) Publ. Bot. 7(1)-7(4). 1711 pp.

Van Wijk, H. L. 1911. A dictionary of plant names. Martinus Nijhoff, The Hague, The Netherlands. 1444 pp.

Victorin, M. 1964. Flore Laurentienne. 2nd ed. Univ. Montreal, Montreal, Que., Canada. 952 pp.

Geographic Information

Plant or plant parts used in or around the home.

References:

Bailey, L. H., Bailey, E. Z. 1976. Hortus third. Revised. MacMillan, New York, N.Y., USA. 1290 pp.

Boivin, B. 1966, 1967. Énumération des plantes du Canada. Provencheria 6. Nat. Can. (Que.) 93: 253-274; 371-437; 583-646; 989-1063. 94: 131-157; 471-528; 625-655.

Image or illustration

Sorghum:

Images: images.google.com

Notes on Poisonous plant parts:

Damaged leaves and stems can release HCN. Since HCN is volatile, silage made from this plant is generally safe (Cheeke and Schull 1985).

Toxic parts:

leaves
stems

References:

Cheeke, P. R., Shull, L. R. 1985. Natural toxicants in feeds and poisonous plants. AVI Publishing Company, Inc., Westport, Conn., USA. 492 pp.

Notes on Toxic plant chemicals:

In the presence of plant enzymes released by damage, a cyanogenic glycoside, dhurrin, produces hydrocyanic acid (HCN) in the animal's system. Levels of cyanide at 250 mg/100 g of plant tissue have been measured after damage. A lethal dose of cyanide is 0.5-3 mg/kg of body weight. Some sorghum plants have been measured with levels 10 times a lethal of HCN (Cheeke and Schull 1985).

Toxic plant chemicals:

dhurrin

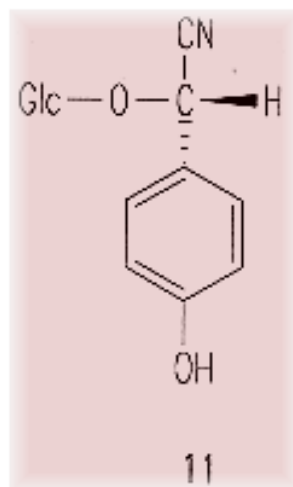

nitrate

Chemical diagram(s) are courtesy of [Ruth McDiarmid](#),

Biochemistry Technician, Kamloops Range Station, Agriculture and Agri-Food Canada, Kamloops, British Columbia, Canada.

References:

Cheeke, P. R., Shull, L. R. 1985. Natural toxicants in feeds and poisonous plants. AVI Publishing Company, Inc., Westport, Conn., USA. 492 pp.

Fuller, T. C., McClintock, E. 1986. Poisonous plants of California. Univ. California Press, Berkeley, Calif., USA. 432 pp.

Animals/Human Poisoning:

Note: When an animal is listed without additional information, the literature (as of 1993) contained no detailed explanation.

Cattle

General symptoms of poisoning:

[abortion](#)

[coma](#)

[convulsions](#)

[cyanosis](#)

[death](#)

[dyspnea](#)

[gait, staggering](#)

[methemoglobinemia](#)

References:

Cheeke, P. R., Shull, L. R. 1985. Natural toxicants in feeds and poisonous plants. AVI Publishing Company, Inc., Westport, Conn., USA. 492 pp.

Clay, B. R., Edwards, W. C., Peterson, D. R. 1976. Toxic nitrate accumulation in the sorghums. *Bovine Pract.*, 11: 28-32.

Gray, E., Rice, J. S., Wattenbarger, D., Benson, J. A., Hester, A. J., Loyd, R. C., Greene, B. M. 1968. Hydrocyanic acid potential of *Sorghum* plants grown in Tennessee. *Tenn. Agric. Exp. Stn. Bull.*, 445. 48 pp.

Kingsbury, J. M. 1964. Poisonous plants of the United States and Canada. Prentice-Hall Inc., Englewood Cliffs, N.J., USA. 626 pp.

Horses

General symptoms of poisoning:

[abortion](#)

[incoordination](#)

[urinary incontinence](#)

Notes on poisoning:

In the United States sublethal doses of HCN caused degeneration of the lumbar and sacral segments of the spinal cord in horses after they ingested sorghum. Large quantities of sediment occur in the urine. If forced to move, affected horses sway from side to side and dribble urine, a condition known as sorghum cystitis ataxia. Other symptoms include an extremely enlarged bladder and patchy encephalomalacia with axonal degeneration. Damage is permanent. When fed sorghums during early pregnancy, mares have aborted. The causal toxin has not been determined yet (Fuller and McClintock 1986, Morgan et al. 1990).

References:

Fuller, T. C., McClintock, E. 1986. Poisonous plants of California. Univ. California Press, Berkeley, Calif., USA. 432 pp.

Morgan, S. E., Johnson, B., Brewer, B., Walker, J. 1990. Sorghum cystitis ataxia syndrome in horses. Vet. Hum. Toxicol., 32: 582.

[Another search?](#)

[Français](#) | [Contact Us](#) | [Help](#) | [Search](#) | [Canada site](#)

[Coming Events](#) | [About CBIF](#) | [Links](#) | [Reports and Publications](#) |

[Home](#)

Date modified: 2003-02-06

[Important Notices](#)



Français	Contact us	Help	Search	Canada site
Coming events	About CBIF	Links	Reports and publications	Home

Canadian Biodiversity Information Facility



Notes on poisoning: spatulate-leaved heliotrope

[Introduction](#)[Interactive](#)[All poisonous plants by Botanical name](#)[All poisonous plants by Common name](#)[Important WWW Poisonous Plants sites](#)

General poisoning notes:

Spatulate-leaved heliotrope (*Heliotropium curassavicum*) is a native herb found in southern parts of western Canada. This plant contains pyrrolizidine alkaloids. It and other members of the genus (*Heliotropium species*) are used in herbal teas and have been used in several parts of the world for medicinal reasons. Over consumption of such teas may cause veno-occlusive disease of the liver (Budd-Chiari syndrome), with hepatic vein thrombosis (Lampe and McCann 1985, Huxtable 1989).

References:

Huxtable, R. J. 1989. Human health implications of pyrrolizidine alkaloids and herbs containing them. Pages 41-86 in Cheeke, P. R., ed. Toxicants of plant origin. Vol. I. Alkaloids. CRC Press, Inc., Boca Raton, Fla., USA. 335 pp.

Lampe, K. F., McCann, M. A. 1985. AMA Handbook of poisonous and injurious plants. American Medical Assoc. Chicago, Ill., USA. 432 pp.

Nomenclature:

Scientific Name: *Heliotropium curassavicum* L.

Vernacular name(s): spatulate-leaved heliotrope

Scientific family name: *Boraginaceae*

Vernacular family name: borage

Go to ITIS^{*ca} for more taxonomic information on: [Heliotropium curassavicum](#)

References:

Agriculture Quebec. 1975. Noms des maladies des plantes du Canada/ Names of plant diseases in Canada. , Quebec City, Que., Canada. 288 pp.

Alex, J. F., Cayouette, R., Mulligan, G. A. 1980. Common and botanical names of weeds in Canada/Noms populaire et scientifiques des plantes nuisibles du Canada. Revised. Agric. Can. Publ., Ottawa, Ont., Canada. 132 pp.

Bailey, L. H., Bailey, E. Z. 1976. Hortus third. Revised. MacMillan, New York, N.Y., USA. 1290 pp.

Scoggan, H. J. 1978, 1979. The flora of Canada. Nat. Mus. Nat. Sci. (Ottawa) Publ. Bot. 7(1)-7(4). 1711 pp.

Van Wijk, H. L. 1911. A dictionary of plant names. Martinus Nijhoff, The Hague, The Netherlands. 1444 pp.

Victorin, M. 1964. Flore Laurentienne. 2nd ed. Univ. Montreal, Montreal, Que., Canada. 952 pp.

Geographic Information

Alberta
Manitoba
Saskatchewan

References:

Bailey, L. H., Bailey, E. Z. 1976. Hortus third. Revised. MacMillan, New York, N.Y., USA. 1290 pp.

Boivin, B. 1966, 1967. Énumération des plantes du Canada. Provencheria 6. Nat. Can. (Que.) 93: 253-274; 371-437; 583-646; 989-1063. 94: 131-157; 471-528; 625-655.

Image or illustration

spatulate-leaved heliotrope:

Images: images.google.com

Toxic parts:

leaves

References:

Huxtable, R. J. 1989. Human health implications of pyrrolizidine alkaloids and herbs containing them. Pages 41-86 in Cheeke, P. R.,

ed. Toxicants of plant origin. Vol. I. Alkaloids. CRC Press, Inc., Boca Raton, Fla., USA. 335 pp.

Notes on Toxic plant chemicals:

The heliotropes contain hepatotoxic pyrrolizidine alkaloids of the nonacyclic diester type. These alkaloids can cause veno-occlusive disease (Huxtable 1989).

Toxic plant chemicals:

unknown chemical

References:

Huxtable, R. J. 1989. Human health implications of pyrrolizidine alkaloids and herbs containing them. Pages 41-86 in Cheeke, P. R., ed. Toxicants of plant origin. Vol. I. Alkaloids. CRC Press, Inc., Boca Raton, Fla., USA. 335 pp.

Animals/Human Poisoning:

Note: When an animal is listed without additional information, the literature (as of 1993) contained no detailed explanation.

Humans

General symptoms of poisoning:

[abdominal pains](#)

[anorexia](#)

[ascites](#)

[death](#)

[diarrhea](#)

[liver, cirrhosis of](#)

[nausea](#)

[vomiting](#)

Notes on poisoning:

Symptoms of over-consumption of these plants may result in veno-occlusive disease of the liver. This is accompanied by abdominal pain and ascites. Cirrhosis of the liver can result. Other results are hepatomegaly and splenomegaly. Death may result. There is no specific treatment for toxin-induced hepatic veno-occlusive disease (Lampe and McCann 1985, Huxtable 1989).

References:

Huxtable, R. J. 1989. Human health implications of pyrrolizidine alkaloids and herbs containing them. Pages 41-86 in Cheeke, P. R., ed. Toxicants of plant origin. Vol. I. Alkaloids. CRC Press, Inc., Boca Raton, Fla., USA. 335 pp.

Lampe, K. F., McCann, M. A. 1985. AMA Handbook of poisonous and injurious plants. American Medical Assoc. Chicago, Ill., USA. 432 pp.

[Another search?](#)

[Français](#) | [Contact Us](#) | [Help](#) | [Search](#) | [Canada site](#)

[Coming Events](#) | [About CBIF](#) | [Links](#) | [Reports and Publications](#) |

[Home](#)

Date modified: 2003-02-06

[Important Notices](#)



Français	Contact us	Help	Search	Canada site
Coming events	About CBIF	Links	Reports and publications	Home

Canadian Biodiversity Information Facility



Notes on poisoning: spotted dumbcane

[Introduction](#)

[Interactive](#)

[All poisonous plants by Botanical name](#)

[All poisonous plants by Common name](#)

[Important WWW Poisonous Plants sites](#)



General poisoning notes:

Spotted dumbcane (*Dieffenbachia maculata*) is an indoor ornamental. Experimental work with leaf and stem material caused death in mice and rats (Der Marderosian et al. 1976). Toxic symptoms have also occurred in humans and house pets. Chewing produces painful irritation of the mouth and throat. Symptoms may take several days to disappear. The insoluble oxalates do not cause systemic poisoning in humans (Lampe and McCann 1985).

References:

Der Marderosian, A. H., Giller, F. B., Roia, F. C. 1976. Phytochemical and toxicological screening of household ornamental plants potentially toxic to humans. 1. J. Toxicol. Environ. Health, 1: 939-953.

Nomenclature:

Scientific Name: *Dieffenbachia maculata* (Lodd.) G. Don

Vernacular name(s): spotted dumbcane

Scientific family name: *Araceae*

Vernacular family name: arum

Go to ITIS*^{ca} for more taxonomic information on: [Dieffenbachia maculata](#)

References:

Agriculture Quebec. 1975. Noms des maladies des plantes du Canada/ Names of plant diseases in Canada. , Quebec City, Que., Canada. 288 pp.

Alex, J. F., Cayouette, R., Mulligan, G. A. 1980. Common and botanical names of weeds in Canada/Noms populaire et scientifiques des plantes nuisibles du Canada. Revised. Agric. Can. Publ., Ottawa, Ont., Canada. 132 pp.

Bailey, L. H., Bailey, E. Z. 1976. Hortus third. Revised. MacMillan, New York, N.Y., USA. 1290 pp.

Scoggan, H. J. 1978, 1979. The flora of Canada. Nat. Mus. Nat. Sci. (Ottawa) Publ. Bot. 7(1)-7(4). 1711 pp.

Van Wijk, H. L. 1911. A dictionary of plant names. Martinus Nijhoff, The Hague, The Netherlands. 1444 pp.

Victorin, M. 1964. Flore Laurentienne. 2nd ed. Univ. Montreal, Montreal, Que., Canada. 952 pp.

Geographic Information

Plant or plant parts used in or around the home.

References:

Bailey, L. H., Bailey, E. Z. 1976. Hortus third. Revised. MacMillan, New York, N.Y., USA. 1290 pp.

Boivin, B. 1966, 1967. Énumération des plantes du Canada. Provencheria 6. Nat. Can. (Que.) 93: 253-274; 371-437; 583-646; 989-1063. 94: 131-157; 471-528; 625-655.

Image or illustration

spotted dumbcane:

Images: images.google.com

Toxic parts:

leaves
stems

References:

Der Marderosian, A. H., Giller, F. B., Roia, F. C. 1976. Phytochemical and toxicological screening of household ornamental plants potentially toxic to humans. 1. J. Toxicol. Environ. Health, 1: 939-953.

Notes on Toxic plant chemicals:

See notes under [Dieffenbachia seguine](#) for additional information

on toxic chemicals in *Dieffenbachia* spp.

Toxic plant chemicals:

oxalate

References:

Der Marderosian, A. H., Giller, F. B., Roia, F. C. 1976. Phytochemical and toxicological screening of household ornamental plants potentially toxic to humans. 1. J. Toxicol. Environ. Health, 1: 939-953.

Animals/Human Poisoning:

Note: When an animal is listed without additional information, the literature (as of 1993) contained no detailed explanation.

Humans

General symptoms of poisoning:

[mouth, irritation of](#)

Notes on poisoning:

See additional notes under [Dieffenbachia seguine](#).

References:

Der Marderosian, A. H., Giller, F. B., Roia, F. C. 1976. Phytochemical and toxicological screening of household ornamental plants potentially toxic to humans. 1. J. Toxicol. Environ. Health, 1: 939-953.

Rodents

[Another search?](#)

[Français](#) | [Contact Us](#) | [Help](#) | [Search](#) | [Canada site](#)

[Coming Events](#) | [About CBIF](#) | [Links](#) | [Reports and Publications](#) |

[Home](#)

Date modified: 2003-02-06

[Important Notices](#)



Français	Contact us	Help	Search	Canada site
Coming events	About CBIF	Links	Reports and publications	Home

Canadian Biodiversity Information Facility



Notes on poisoning: spotted water-hemlock

[Introduction](#)[Interactive](#)[All poisonous plants by Botanical name](#)[All poisonous plants by Common name](#)[Important WWW Poisonous Plants sites](#)

General poisoning notes:

Spotted water-hemlock (*Cicuta maculata*) is a native perennial herb found in wet soils and marshes across most of Canada and is considered the most violently toxic plant in North America. Humans and all classes of livestock are susceptible to poisoning and death after ingesting plant material. The onset of symptoms is often so sudden and traumatic that treatments are not always successful. The symptoms are similar in all cases of poisoning: salivation, muscular spasms, violent convulsions, coma, and death from asphyxiation. Death can occur within 15 minutes to 2-3 h after a lethal dose (Starrveld and Hope 1976, Panter et al. 1988).



References:

- Campbell, E. W. 1966. Plant poisoning Umbelliferae (parsley family). *Maine Med. Assoc.*, 57(2): 40-42.
- Haggerty, D. R., Conway, J. A. 1936. Report of poisoning by *Cicuta maculata*. *Water hemlock*. *N. Y. State J. Med.*, 36: 1511-1514.
- Pammel, L. H. 1928. Cowbane (wild parsnip). *N. Am. Vet.*, 9: 25-26.
- Panter, K. E., Keeler, R. F., Baker, D. C. 1988. Toxicoses in livestock from the hemlocks (*Conium* and *Cicuta* spp.). *J. Anim. Sci.*, 66: 2407-2413.
- Skidmore, L. V. 1933. Water hemlock (*Cicuta maculata* L.) poisoning in swine. *Vet. J.*, 89: 76-80.
- Smith, R. A., Lewis, D. 1987. *Cicuta* toxicosis in cattle: case history and simplified analytical method. *Vet. Hum. Toxicol.*, 29(3): 240-241.
- Starreveld, E., Hope, C. E. 1975. Cicutoxin poisoning (water hemlock). *Neurology*, 25: 730-734.

Nomenclature:

Scientific Name: *Cicuta maculata* L.

Vernacular name(s): spotted water-hemlock

Scientific family name: *Umbelliferae*

Vernacular family name: parsley

Go to ITIS*^{ca} for more taxonomic information on: [Cicuta maculata](#)

References:

Agriculture Quebec. 1975. Noms des maladies des plantes du Canada/ Names of plant diseases in Canada. , Quebec City, Que., Canada. 288 pp.

Alex, J. F., Cayouette, R., Mulligan, G. A. 1980. Common and botanical names of weeds in Canada/Noms populaire et scientifiques des plantes nuisibles du Canada. Revised. Agric. Can. Publ., Ottawa, Ont., Canada. 132 pp.

Bailey, L. H., Bailey, E. Z. 1976. Hortus third. Revised. MacMillan, New York, N.Y., USA. 1290 pp.

Scoggan, H. J. 1978, 1979. The flora of Canada. Nat. Mus. Nat. Sci. (Ottawa) Publ. Bot. 7(1)-7(4). 1711 pp.

Van Wijk, H. L. 1911. A dictionary of plant names. Martinus Nijhoff, The Hague, The Netherlands. 1444 pp.

Victorin, M. 1964. Flore Laurentienne. 2nd ed. Univ. Montreal, Montreal, Que., Canada. 952 pp.

Geographic Information

Alberta
British Columbia
Manitoba
New Brunswick
Northwest Territories
Nova Scotia
Ontario
Prince Edward Island
Quebec
Saskatchewan
Yukon Territory

References:

Bailey, L. H., Bailey, E. Z. 1976. Hortus third. Revised. MacMillan, New York, N.Y., USA. 1290 pp.

Boivin, B. 1966, 1967. Énumération des plantes du Canada. Provencheria 6. Nat. Can. (Que.) 93: 253-274; 371-437; 583-646; 989-1063. 94: 131-157; 471-528; 625-655.

Image or illustration

spotted water-hemlock:

Images: images.google.com

Notes on Poisonous plant parts:

The toxin is concentrated in the rootstock in the spring. Later during the growing season, the roots contain less toxin, and the leaves and stems contain sufficient chemical to cause lethal poisoning (Starreveld and Hope 1975).

Toxic parts:

all parts
roots

References:

Pammel, L. H. 1928. Cowbane (wild parsnip). *N. Am. Vet.*, 9: 25-26.

Skidmore, L. V. 1933. Water hemlock (*Cicuta maculata* L.) poisoning in swine. *Vet. J.*, 89: 76-80.

Smith, R. A., Lewis, D. 1987. *Cicuta* toxicosis in cattle: case history and simplified analytical method. *Vet. Hum. Toxicol.*, 29(3): 240-241.

Starreveld, E., Hope, C. E. 1975. Cicutoxin poisoning (water hemlock). *Neurology*, 25: 730-734.

Notes on Toxic plant chemicals:

The chemical cicutoxin, (trans)heptadeca-8:10:12-triene-4:6-diene- 1:4-diol, is a highly unsaturated higher alcohol. Cicutol is also present. Bohlman (pers. comm.) in Mulligan and Munro (1981) found the following concentrations of these chemicals in *Cicuta* rootstocks:

<i>Cicuta maculata</i> var. <i>maculata</i>	1.01 mg/g active ingredients
<i>Cicuta douglasii</i>	0.75 mg/g
<i>Cicuta virosa</i>	0.07 mg/g
<i>Cicuta bulbifera</i>	0.01 mg/g

The first two *Cicuta* spp. are considered the most violently toxic plants in North America. *Cicuta virosa* is less likely to cause poisoning because of its reduced concentration of toxic compounds. *Cicuta bulbifera* contains too little toxin to be considered a threat.

Toxic plant chemicals:

cicutol

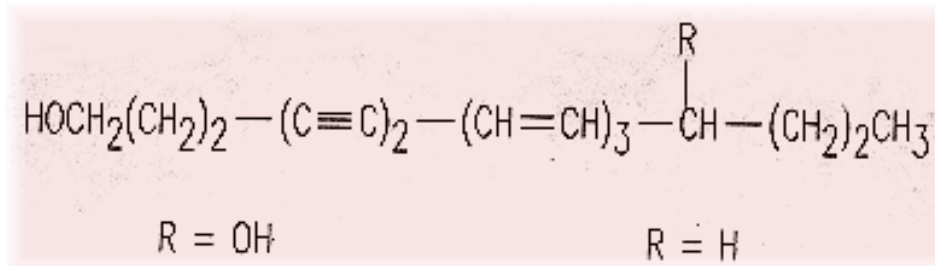

cicutoxin

Chemical diagram(s) are courtesy of [Ruth McDiarmid](#), Biochemistry Technician, Kamloops Range Station, Agriculture and Agri-Food Canada, Kamloops, British Columbia, Canada.

References:

Campbell, E. W. 1966. Plant poisoning Umbelliferae (parsley family). Maine Med. Assoc., 57(2): 40-42.

Skidmore, L. V. 1933. Water hemlock (*Cicuta maculata* L.) poisoning in swine. Vet. J., 89: 76-80.

Smith, R. A., Lewis, D. 1987. *Cicuta* toxicosis in cattle: case history and simplified analytical method. Vet. Hum. Toxicol., 29(3): 240-241.

Starreveld, E., Hope, C. E. 1975. Cicutoxin poisoning (water hemlock). Neurology, 25: 730-734.

Animals/Human Poisoning:

Note: When an animal is listed without additional information, the literature (as of 1993) contained no detailed explanation.

Cattle

General symptoms of poisoning:

[convulsions](#)

[death](#)

[falling down](#)

[nervousness](#)

[salivation](#)

Notes on poisoning:

Cattle have symptoms of poisoning similar to those of other livestock. The symptoms include salivation, grinding of teeth, muscular spasms, violent convulsions, and death by asphyxiation. Smith and Lewis (1987) developed a

rapid technique for identifying the presence of the toxic compounds of water-hemlocks in rumen samples.

References:

Pammel, L. H. 1928. Cowbane (wild parsnip). N. Am. Vet., 9: 25-26.

Panter, K. E., Keeler, R. F., Baker, D. C. 1988. Toxicoses in livestock from the hemlocks (*Conium* and *Cicuta* spp.). J. Anim. Sci., 66: 2407-2413.

Smith, R. A., Lewis, D. 1987. *Cicuta* toxicosis in cattle: case history and simplified analytical method. Vet. Hum. Toxicol., 29(3): 240-241.

Humans

General symptoms of poisoning:

[abdominal pains](#)

[cardiac arrest](#)

[coma](#)

[confusion](#)

[convulsions](#)

[cyanosis](#)

[death](#)

[dizziness](#)

[eyeballs, protruding](#)

[eyes, rolling](#)

[faintness](#)

[heart rate, elevated](#)

[inebriation](#)

[metabolic acidosis](#)

[mouth, frothing of](#)

[muscle contractions](#)

[muscle spasms](#)

[muscle twitching](#)

[nausea](#)

[neck, rigid](#)

[opisthotonos](#)

[pupil dilation](#)

[pupils, pinpoint](#)

[reflex excitability](#)

[salivation](#)

[teeth grinding](#)

[unconsciousness](#)

[voiding, involuntary](#)

[vomiting](#)

Notes on poisoning:

Symptoms of poisoning by the genus *Cicuta* include dizziness, salivation, clenching and grinding of teeth, violent convulsions, cyanosis, coma, and death from asphyxiation. In one case, a fisherman took two bites from the roots and then felt dizzy and fell unconscious within 30 min. The patient endured pain and convulsions for some time. Recommended treatment includes administration of oxygen, anesthesia to control gross wild movements, and intravenous sodium bicarbonate to correct metabolic acidosis. At least 83 cases of human poisoning by water-hemlock have been reported since 1900, of which 21 were fatal. The rootstocks are generally distasteful, but ingesting of only one bite causes symptoms in humans (Starrveld and Hope 1976). These notes apply to all water-hemlock species (*Cicuta*) listed in this information system.

References:

- Campbell, E. W. 1966. Plant poisoning Umbelliferae (parsley family). Maine Med. Assoc., 57(2): 40-42.
- Haggerty, D. R., Conway, J. A. 1936. Report of poisoning by *Cicuta maculata*. Water hemlock. N. Y. State J. Med., 36: 1511-1514.
- Pammel, L. H. 1928. Cowbane (wild parsnip). N. Am. Vet., 9: 25-26.
- Panter, K. E., Keeler, R. F., Baker, D. C. 1988. Toxicoses in livestock from the hemlocks (*Conium* and *Cicuta* spp.). J. Anim. Sci., 66: 2407-2413.
- Starreveld, E., Hope, C. E. 1975. Cicutoxin poisoning (water hemlock). Neurology, 25: 730-734.

Sheep

General symptoms of poisoning:

[breathing, labored](#)
[death](#)
[recumbency](#)

Notes on poisoning:

Ewes weighing 70 kg were experimentally poisoned with fresh rootstock. The ewe given 100 g showed few symptoms; 200 g of plant material caused extensive symptoms including seizures, recumbency, and labored breathing. Recovery occurred after several days. Gavage with 450 g of the rootstock caused death in 90 min (Panter et al. 1988).

References:

- Panter, K. E., Keeler, R. F., Baker, D. C. 1988. Toxicoses in livestock from the hemlocks (*Conium* and *Cicuta* spp.). J. Anim. Sci., 66: 2407-2413.

Swine

General symptoms of poisoning:

[agonal squeals](#)

[brain, congestion of](#)

[convulsions](#)

[death](#)

[lesions, no specific](#)

[lungs, congestion of](#)

[muscle contractions](#)

[paralysis](#)

[reflex excitability](#)

References:

Skidmore, L. V. 1933. Water hemlock (*Cicuta maculata* L.) poisoning in swine. Vet. J., 89: 76-80.

[Another search?](#)

[Français](#) | [Contact Us](#) | [Help](#) | [Search](#) | [Canada site](#)

[Coming Events](#) | [About CBIF](#) | [Links](#) | [Reports and Publications](#) | [Home](#)

Date modified: 2003-02-06

[Important Notices](#)



Français	Contact us	Help	Search	Canada site
Coming events	About CBIF	Links	Reports and publications	Home

Canadian Biodiversity Information Facility



Notes on poisoning: spreading dogbane

[Introduction](#)[Interactive](#)[All poisonous plants by Botanical name](#)[All poisonous plants by Common name](#)[Important WWW Poisonous Plants sites](#)

General poisoning notes:

Spreading dogbane (*Apocynum androsaemifolium*) is a native herb found across Canada. This plant has been reported to cause serious poisoning potential in cattle, horses, and sheep after ingestion (Johnson and Archer 1922). This information was credited to a report from the Arizona Experiment Station and to an article that was erroneously stated to be about *Apocynum*. However, that article actually concerned [Nerium](#) (oleander) poisoning of livestock. Therefore, the various signs and symptoms attributed to dogbane poisoning since 1922 are usually based on this mistake (Kingsbury 1959).

References:

- Fleurbec Inc. 1981. Plantes sauvages comestibles. Le groupe Fleurbec Inc., Sainte-Cuthbert, Que, Canada. 167 pp.
- Fuller, T. C., McClintock, E. 1986. Poisonous plants of California. Univ. California Press, Berkeley, Calif., USA. 432 pp.
- Johnson, E. P., Archer, W. A. 1922. The principal stock-poisoning plants of New Mexico. N. M. Agric. Ext. Serv. Circ., 71. 40 pp.
- Kingsbury, J. M. 1959. Toxicity of *Apocynum* (dogbane) to stock; a correction. Cornell Vet., 49: 285-287.
- Moore, C. W. 1909. LXXXV. - The constituents of the rhizome of *Apocynum androsaemifolium*. J. Chem. Soc. (Lond.), 95: 734-751.

Nomenclature:

Scientific Name: *Apocynum androsaemifolium* L.

Vernacular name(s): spreading dogbane

Scientific family name: *Apocynaceae*

Vernacular family name: dogbane

Go to ITIS^{*ca} for more taxonomic information on: [Apocynum androsaemifolium](#)

References:

Agriculture Quebec. 1975. Noms des maladies des plantes du Canada/ Names of plant diseases in Canada. , Quebec City, Que., Canada. 288 pp.

Alex, J. F., Cayouette, R., Mulligan, G. A. 1980. Common and botanical names of weeds in Canada/Noms populaire et scientifiques des plantes nuisibles du Canada. Revised. Agric. Can. Publ., Ottawa, Ont., Canada. 132 pp.

Bailey, L. H., Bailey, E. Z. 1976. Hortus third. Revised. MacMillan, New York, N.Y., USA. 1290 pp.

Scoggan, H. J. 1978, 1979. The flora of Canada. Nat. Mus. Nat. Sci. (Ottawa) Publ. Bot. 7(1)-7(4). 1711 pp.

Van Wijk, H. L. 1911. A dictionary of plant names. Martinus Nijhoff, The Hague, The Netherlands. 1444 pp.

Victorin, M. 1964. Flore Laurentienne. 2nd ed. Univ. Montreal, Montreal, Que., Canada. 952 pp.

Geographic Information

Alberta
British Columbia
Manitoba
New Brunswick
Newfoundland
Northwest Territories
Nova Scotia
Ontario
Prince Edward Island
Quebec
Saskatchewan
Yukon Territory

References:

Bailey, L. H., Bailey, E. Z. 1976. Hortus third. Revised. MacMillan, New York, N.Y., USA. 1290 pp.

Boivin, B. 1966, 1967. Énumération des plantes du Canada. Provencheria 6. Nat. Can. (Que.) 93: 253-274; 371-437; 583-646;

989-1063. 94: 131-157; 471-528; 625-655.

Image or illustration

spreading dogbane:

Images: images.google.com

Toxic parts:

rhizome

References:

Moore, C. W. 1909. LXXXV. - The constituents of the rhizome of *Apocynum androsaemifolium*. J. Chem. Soc. (Lond.), 95: 734-751.

Notes on Toxic plant chemicals:

Experimental evidence shows that spreading dogbane contains apocynamarin, a cardiac glycoside, as well as other glycosides and resins. These chemicals have caused sickness and death when administered cats and dogs. The potential for poisoning therefore exists (Moore

Toxic plant chemicals:

apocynamarin

References:

Moore, C. W. 1909. LXXXV. - The constituents of the rhizome of *Apocynum androsaemifolium*. J. Chem. Soc. (Lond.), 95: 734-751.

Animals/Human Poisoning:

Note: When an animal is listed without additional information, the literature (as of 1993) contained no detailed explanation.

Cats

General symptoms of poisoning:

[blood pressure, high](#)
[death](#)

References:

Moore, C. W. 1909. LXXXV. - The constituents of the rhizome of *Apocynum androsaemifolium*. J. Chem. Soc. (Lond.), 95: 734-751.

Dogs

General symptoms of poisoning:

[death](#)

[vomiting](#)

References:

Moore, C. W. 1909. LXXXV. - The constituents of the rhizome of *Apocynum androsaemifolium*. J. Chem. Soc. (Lond.), 95: 734-751.

Horses

Humans

General symptoms of poisoning:

[convulsions](#)

[death](#)

[diarrhea](#)

[sweating](#)

[urination, frequent](#)

[vomiting](#)

Notes on poisoning:

The root of spreading dogbane has been used for medicinal purposes. Excessive doses of the extracts apparently cause sickness and death in humans (Fleurbec 1981).

References:

Fleurbec Inc. 1981. Plantes sauvages comestibles. Le groupe Fleurbec Inc., Sainte-Cuthbert, Que, Canada. 167 pp.

[Another search?](#)

[Français](#) | [Contact Us](#) | [Help](#) | [Search](#) | [Canada site](#)

[Coming Events](#) | [About CBIF](#) | [Links](#) | [Reports and Publications](#) |

[Home](#)

Date modified: 2003-02-06

[Important Notices](#)



Français	Contact us	Help	Search	Canada site
Coming events	About CBIF	Links	Reports and publications	Home

Canadian Biodiversity Information Facility



Notes on poisoning: spurge-laurel

[Introduction](#)

[Interactive](#)

[All poisonous plants by Botanical name](#)

[All poisonous plants by Common name](#)

[Important WWW Poisonous Plants sites](#)

General poisoning notes:

Spurge-laurel (*Daphne laureola*) is an ornamental shrub that is poisonous to animals that ingest it. The *Daphne* species listed in this information system cause few cases of poisoning, but children or family pets can be affected. See additional information under general notes of [Daphne mezereum](#).



References:

Lampe, K. F., McCann, M. A. 1985. AMA Handbook of poisonous and injurious plants. American Medical Assoc. Chicago, Ill., USA. 432 pp.

Nomenclature:

Scientific Name: *Daphne laureola* L.

Vernacular name(s): spurge-laurel

Scientific family name: *Thymelaeaceae*

Vernacular family name: mezereum

Go to ITIS^{*ca} for more taxonomic information on: [Daphne laureola](#)

References:

Agriculture Quebec. 1975. Noms des maladies des plantes du Canada/ Names of plant diseases in Canada. , Quebec City, Que., Canada. 288 pp.

Alex, J. F., Cayouette, R., Mulligan, G. A. 1980. Common and botanical names of weeds in Canada/Noms populaire et scientifiques des plantes nuisibles du Canada. Revised. Agric. Can. Publ., Ottawa, Ont., Canada. 132 pp.

Bailey, L. H., Bailey, E. Z. 1976. Hortus third. Revised. MacMillan, New York, N.Y., USA. 1290 pp.

Scoggan, H. J. 1978, 1979. The flora of Canada. Nat. Mus. Nat. Sci. (Ottawa) Publ. Bot. 7(1)-7(4). 1711 pp.

Van Wijk, H. L. 1911. A dictionary of plant names. Martinus Nijhoff, The Hague, The Netherlands. 1444 pp.

Victorin, M. 1964. Flore Laurentienne. 2nd ed. Univ. Montreal, Montreal, Que., Canada. 952 pp.

Geographic Information

Plant or plant parts used in or around the home.

References:

Bailey, L. H., Bailey, E. Z. 1976. Hortus third. Revised. MacMillan, New York, N.Y., USA. 1290 pp.

Boivin, B. 1966, 1967. Énumération des plantes du Canada. Provencheria 6. Nat. Can. (Que.) 93: 253-274; 371-437; 583-646; 989-1063. 94: 131-157; 471-528; 625-655.

Image or illustration

spurge-laurel:

Images: images.google.com

Toxic parts:

all parts
bark
flowers
leaves
mature fruit

References:

Lampe, K. F., McCann, M. A. 1985. AMA Handbook of poisonous and injurious plants. American Medical Assoc. Chicago, Ill., USA. 432 pp.

Toxic plant chemicals:

daphnetoxin
dihydroxycoumarin
mezerein

References:

Fuller, T. C., McClintock, E. 1986. Poisonous plants of California. Univ. California Press, Berkeley, Calif., USA. 432 pp.

Lampe, K. F., McCann, M. A. 1985. AMA Handbook of poisonous and injurious plants. American Medical Assoc. Chicago, Ill., USA. 432 pp.

Animals/Human Poisoning:

Note: When an animal is listed without additional information, the literature (as of 1993) contained no detailed explanation.

Cats

Dogs

Humans

General symptoms of poisoning:

[abdominal pains](#)

[diarrhea](#)

[dysphagia](#)

[mouth, irritation of](#)

[salivation](#)

[thirsty](#)

References:

Lampe, K. F., McCann, M. A. 1985. AMA Handbook of poisonous and injurious plants. American Medical Assoc. Chicago, Ill., USA. 432 pp.

[Another search?](#)

[Français](#) | [Contact Us](#) | [Help](#) | [Search](#) | [Canada site](#)

[Coming Events](#) | [About CBIF](#) | [Links](#) | [Reports and Publications](#) |

[Home](#)

Date modified: 2003-02-06

[Important Notices](#)



Français	Contact us	Help	Search	Canada site
Coming events	About CBIF	Links	Reports and publications	Home

Canadian Biodiversity Information Facility



Notes on poisoning: squirrel-corn

[Introduction](#)

[Interactive](#)

[All poisonous plants by Botanical name](#)

[All poisonous plants by Common name](#)

[Important WWW Poisonous Plants sites](#)



General poisoning notes:

Squirrel-corn (*Dicentra canadensis*) is a native herb found in rich woodlands in southern Ontario and Quebec. The plant contains alkaloids that are known to be toxic. However, feeding experiments on cattle using the aboveground parts, as well as the entire plant failed, to produce any symptoms other than slight restlessness and uneasiness (Black et al. 1923). See additional notes under general notes of [Dicentra cucullaria](#).

References:

Black, O. F., Eggleston, W. W., Kelly, J. W., Turner, H. C. 1923. Poisonous properties of *Bikukulla cucullaria* (Dutchman's-breeches) and *B. canadensis* (squirrel-corn). J. Agric. Res., 23: 69-78.

Nomenclature:

Scientific Name: *Dicentra canadensis* (Goldie) Walp.

Vernacular name(s): squirrel-corn

Scientific family name: *Fumariaceae*

Vernacular family name: frumitory

Go to ITIS*^{ca} for more taxonomic information on: [Dicentra canadensis](#)

References:

Agriculture Quebec. 1975. Noms des maladies des plantes du Canada/ Names of plant diseases in Canada. , Quebec City, Que., Canada. 288 pp.

Alex, J. F., Cayouette, R., Mulligan, G. A. 1980. Common and

botanical names of weeds in Canada/Noms populaire et scientifiques des plantes nuisibles du Canada. Revised. Agric. Can. Publ., Ottawa, Ont., Canada. 132 pp.

Bailey, L. H., Bailey, E. Z. 1976. Hortus third. Revised. MacMillan, New York, N.Y., USA. 1290 pp.

Scoggan, H. J. 1978, 1979. The flora of Canada. Nat. Mus. Nat. Sci. (Ottawa) Publ. Bot. 7(1)-7(4). 1711 pp.

Van Wijk, H. L. 1911. A dictionary of plant names. Martinus Nijhoff, The Hague, The Netherlands. 1444 pp.

Victorin, M. 1964. Flore Laurentienne. 2nd ed. Univ. Montreal, Montreal, Que., Canada. 952 pp.

Geographic Information

Ontario

Quebec

References:

Bailey, L. H., Bailey, E. Z. 1976. Hortus third. Revised. MacMillan, New York, N.Y., USA. 1290 pp.

Boivin, B. 1966, 1967. Énumération des plantes du Canada. Provencheria 6. Nat. Can. (Que.) 93: 253-274; 371-437; 583-646; 989-1063. 94: 131-157; 471-528; 625-655.

Image or illustration

squirrel-corn:

Images: images.google.com

Notes on Poisonous plant parts:

See additional information under general notes of [Dicentra cucullaria](#).

Toxic parts:

leaves

tubers

References:

Black, O. F., Eggleston, W. W., Kelly, J. W., Turner, H. C. 1923. Poisonous properties of *Bikukulla cucullaria* (Dutchman's-breeches) and *B. canadensis* (squirrel-corn). J.

Agric. Res., 23: 69-78.

Notes on Toxic plant chemicals:

Aporphine and protopine, which are isoquinoline alkaloids, have been found in *Dicentra* species. Several other alkaloids have also been found in the plants (Black et al. 1923).

Toxic plant chemicals:

aporphine

protopine

References:

Black, O. F., Eggleston, W. W., Kelly, J. W., Turner, H. C. 1923. Poisonous properties of *Bikukulla cucullaria* (Dutchman's-breeches) and *B. canadensis* (squirrel-corn). J. Agric. Res., 23: 69-78.

Animals/Human Poisoning:

Note: When an animal is listed without additional information, the literature (as of 1993) contained no detailed explanation.

Cattle

General symptoms of poisoning:

[restlessness](#)

References:

Black, O. F., Eggleston, W. W., Kelly, J. W., Turner, H. C. 1923. Poisonous properties of *Bikukulla cucullaria* (Dutchman's-breeches) and *B. canadensis* (squirrel-corn). J. Agric. Res., 23: 69-78.

[Another search?](#)

[Français](#) | [Contact Us](#) | [Help](#) | [Search](#) | [Canada site](#)

[Coming Events](#) | [About CBIF](#) | [Links](#) | [Reports and Publications](#) | [Home](#)

Date modified: 2003-02-06

[Important Notices](#)



Français	Contact us	Help	Search	Canada site
Coming events	About CBIF	Links	Reports and publications	Home

Canadian Biodiversity Information Facility



Notes on poisoning: St. John's-wort

[Introduction](#)

[Interactive](#)

[All poisonous plants by Botanical name](#)

[All poisonous plants by Common name](#)

[Important WWW Poisonous Plants sites](#)



General poisoning notes:

St. John's-wort (*Hypericum perforatum*) is a naturalized herb found in eastern Canada and British Columbia. The plant contains hypericin, which is a primary photosensitizing chemical. Ingestion has caused skin problems in cattle, horses, rabbits, sheep, and swine. The skin problems occur on white or light-colored skin; dark skin is not affected. Severe symptoms such as convulsions, staggering, and coma have occurred in some animals. Loss of wool quality occurs in sheep, and the meat of affected animals is of poor quality. This plant is widespread in Canada. The reaction is more severe if fresh plants are eaten, but dried plants can also cause photosensitization, even though 80% of the hypericin is lost (Araya and Ford 1981, Cooper and Johnson 1984, Crompton et al. 1988).

References:

- Araya, O. S., Ford, E. J. 1981. An investigation of the type of photosensitization caused by the ingestion of St John's wort (*Hypericum perforatum*) by calves. *J. Comp. Pathol.*, 91: 135-141.
- Cooper, M. R., Johnson, A. W. 1984. Poisonous plants in Britain and their effects on animals and man. Her Majesty's Stationery Office, London, England. 305 pp.
- Crompton, C. W., Hall, I. V., Jensen, K. I., Hildebrand, P. D. 1988. The biology of Canadian weeds. 83. *Hypericum perforatum* L. *Can. J. Plant Sci.*, 68: 149-162.

Nomenclature:

Scientific Name: *Hypericum perforatum* L.

Vernacular name(s): St. John's-wort

Scientific family name: *Guttiferae*

Vernacular family name: St. John's-wort

Go to ITIS^{*ca} for more taxonomic information on: [Hypericum perforatum](#)

References:

Agriculture Quebec. 1975. Noms des maladies des plantes du Canada/ Names of plant diseases in Canada. , Quebec City, Que., Canada. 288 pp.

Alex, J. F., Cayouette, R., Mulligan, G. A. 1980. Common and botanical names of weeds in Canada/Noms populaire et scientifiques des plantes nuisibles du Canada. Revised. Agric. Can. Publ., Ottawa, Ont., Canada. 132 pp.

Bailey, L. H., Bailey, E. Z. 1976. Hortus third. Revised. MacMillan, New York, N.Y., USA. 1290 pp.

Scoggan, H. J. 1978, 1979. The flora of Canada. Nat. Mus. Nat. Sci. (Ottawa) Publ. Bot. 7(1)-7(4). 1711 pp.

Van Wijk, H. L. 1911. A dictionary of plant names. Martinus Nijhoff, The Hague, The Netherlands. 1444 pp.

Victorin, M. 1964. Flore Laurentienne. 2nd ed. Univ. Montreal, Montreal, Que., Canada. 952 pp.

Geographic Information

British Columbia
New Brunswick
Newfoundland
Nova Scotia
Ontario
Prince Edward Island
Quebec

References:

Bailey, L. H., Bailey, E. Z. 1976. Hortus third. Revised. MacMillan, New York, N.Y., USA. 1290 pp.

Boivin, B. 1966, 1967. Énumération des plantes du Canada. Provencheria 6. Nat. Can. (Que.) 93: 253-274; 371-437; 583-646; 989-1063. 94: 131-157; 471-528; 625-655.

Image or illustration

St. John's-wort:

Images: images.google.com

Toxic parts:

flowers
leaves

References:

Araya, O. S., Ford, E. J. 1981. An investigation of the type of photosensitization caused by the ingestion of St John's wort (*Hypericum perforatum*) by calves. J. Comp. Pathol., 91: 135-141.

Notes on Toxic plant chemicals:

Hypericin, a fluorescent pigment, is regarded as a derivative of naphthodianthrone. The pigment is contained in small black dots that are just visible to the naked eye on leaves and petals. The chemical is a primary photosensitizer because the photodynamic action occurs in the skin (Araya and Ford 1981).

Toxic plant chemicals:

hypericin

References:

Araya, O. S., Ford, E. J. 1981. An investigation of the type of photosensitization caused by the ingestion of St John's wort (*Hypericum perforatum*) by calves. J. Comp. Pathol., 91: 135-141.

Animals/Human Poisoning:

Note: When an animal is listed without additional information, the literature (as of 1993) contained no detailed explanation.

Cattle

General symptoms of poisoning:

[muzzle, dry](#)

[restlessness](#)

[skin, dry](#)

References:

Araya, O. S., Ford, E. J. 1981. An investigation of the type of photosensitization caused by the ingestion of St John's wort (*Hypericum perforatum*) by calves. J. Comp. Pathol., 91: 135-141.

Horses

General symptoms of poisoning:

[appetite, loss of](#)

[coma](#)

[gait, staggering](#)

[skin, peeling of](#)

References:

Cooper, M. R., Johnson, A. W. 1984. Poisonous plants in Britain and their effects on animals and man. Her Majesty's Stationery Office, London, England. 305 pp.

Rabbits

General symptoms of poisoning:

[death](#)

[liver, cirrhosis of](#)

[skin, peeling of](#)

References:

Cooper, M. R., Johnson, A. W. 1984. Poisonous plants in Britain and their effects on animals and man. Her Majesty's Stationery Office, London, England. 305 pp.

Sheep

General symptoms of poisoning:

[convulsions](#)

[erythema](#)

[skin, peeling of](#)

References:

Cooper, M. R., Johnson, A. W. 1984. Poisonous plants in Britain and their effects on animals and man. Her Majesty's Stationery Office, London, England. 305 pp.

Swine

General symptoms of poisoning:

[skin, flushed](#)

[skin, peeling of](#)

References:

Cooper, M. R., Johnson, A. W. 1984. Poisonous plants in Britain and their effects on animals and man. Her Majesty's Stationery Office, London, England. 305 pp.

[Another search?](#)

[Français](#) | [Contact Us](#) | [Help](#) | [Search](#) | [Canada site](#)

[Coming Events](#) | [About CBIF](#) | [Links](#) | [Reports and Publications](#) | [Home](#)

Date modified: 2003-02-06

[Important Notices](#)



Français	Contact us	Help	Search	Canada site
Coming events	About CBIF	Links	Reports and publications	Home

Canadian Biodiversity Information Facility



Notes on poisoning: star-of-Bethlehem

[Introduction](#)

[Interactive](#)

[All poisonous plants by Botanical name](#)

[All poisonous plants by Common name](#)

[Important WWW Poisonous Plants sites](#)



General poisoning notes:

Star-of-Bethlehem (*Ornithogalum umbellatum*), an outdoor ornamental flower, contains glycosides similar to digitalis. In some countries children have been poisoned after ingesting the flowers or bulbs. Ingesting two bulbs by an adult caused shortness of breath. The bulbs contain the highest quantity of these toxins. Cattle in South Africa (the native region for star-of-Bethlehem) have been poisoned, resulting in permanent blindness and death after ingestion. Children and family pets should be prevented from ingesting material from this plant (Cooper and Johnson 1984, Lampe and McCann 1985, Spoerke and Smolinske 1990).

References:

Cooper, M. R., Johnson, A. W. 1984. Poisonous plants in Britain and their effects on animals and man. Her Majesty's Stationery Office, London, England. 305 pp.

Lampe, K. F., McCann, M. A. 1985. AMA Handbook of poisonous and injurious plants. American Medical Assoc. Chicago, Ill., USA. 432 pp.

Spoerke, D. G., Smolinske, S. C. 1990. Toxicity of houseplants. CRC Press, Inc., Boca Raton, Fla., USA. 335 pp.

Nomenclature:

Scientific Name: *Ornithogalum umbellatum* L.

Vernacular name(s): star-of-Bethlehem

Scientific family name: *Liliaceae*

Vernacular family name: lily

Go to ITIS*^{ca} for more taxonomic information on: [Ornithogalum](#)

[*umbellatum*](#)

References:

Agriculture Quebec. 1975. Noms des maladies des plantes du Canada/ Names of plant diseases in Canada. , Quebec City, Que., Canada. 288 pp.

Alex, J. F., Cayouette, R., Mulligan, G. A. 1980. Common and botanical names of weeds in Canada/Noms populaire et scientifiques des plantes nuisibles du Canada. Revised. Agric. Can. Publ., Ottawa, Ont., Canada. 132 pp.

Bailey, L. H., Bailey, E. Z. 1976. Hortus third. Revised. MacMillan, New York, N.Y., USA. 1290 pp.

Scoggan, H. J. 1978, 1979. The flora of Canada. Nat. Mus. Nat. Sci. (Ottawa) Publ. Bot. 7(1)-7(4). 1711 pp.

Van Wijk, H. L. 1911. A dictionary of plant names. Martinus Nijhoff, The Hague, The Netherlands. 1444 pp.

Victorin, M. 1964. Flore Laurentienne. 2nd ed. Univ. Montreal, Montreal, Que., Canada. 952 pp.

Geographic Information

Plant or plant parts used in or around the home.

References:

Bailey, L. H., Bailey, E. Z. 1976. Hortus third. Revised. MacMillan, New York, N.Y., USA. 1290 pp.

Boivin, B. 1966, 1967. Énumération des plantes du Canada. Provencheria 6. Nat. Can. (Que.) 93: 253-274; 371-437; 583-646; 989-1063. 94: 131-157; 471-528; 625-655.

Image or illustration

star-of-Bethlehem:

Images: images.google.com

Toxic parts:

bulbs
flowers

References:

Lampe, K. F., McCann, M. A. 1985. AMA Handbook of poisonous

and injurious plants. American Medical Assoc. Chicago, Ill., USA. 432 pp.

Notes on Toxic plant chemicals:

Two digitalis-like glycosides, convallatoxin and convalloside, are found through the plant but are concentrated in the bulbs and the flowers (Lampe and McCann 1985).

Toxic plant chemicals:

convallatoxin
convalloside

References:

Lampe, K. F., McCann, M. A. 1985. AMA Handbook of poisonous and injurious plants. American Medical Assoc. Chicago, Ill., USA. 432 pp.

Animals/Human Poisoning:

Note: When an animal is listed without additional information, the literature (as of 1993) contained no detailed explanation.

Humans

General symptoms of poisoning:

[diarrhea](#)

[nausea](#)

Notes on poisoning:

Symptoms of ingestion include pain in the mouth, nausea, abdominal pain, and diarrhea. Stomach lavage or use of emetics is recommended (Cooper and Johnson 1984, Lampe and McCann 1985).

References:

Cooper, M. R., Johnson, A. W. 1984. Poisonous plants in Britain and their effects on animals and man. Her Majesty's Stationery Office, London, England. 305 pp.

Lampe, K. F., McCann, M. A. 1985. AMA Handbook of poisonous and injurious plants. American Medical Assoc. Chicago, Ill., USA. 432 pp.

[Another search?](#)

[Français](#) | [Contact Us](#) | [Help](#) | [Search](#) | [Canada site](#)
[Coming Events](#) | [About CBIF](#) | [Links](#) | [Reports and Publications](#) |
[Home](#)

Date modified: 2003-02-06

[Important Notices](#)



Français	Contact us	Help	Search	Canada site
Coming events	About CBIF	Links	Reports and publications	Home



Notes on poisoning: stinging nettle

[Introduction](#)

[Interactive](#)

[All poisonous plants by Botanical name](#)

[All poisonous plants by Common name](#)

[Important WWW Poisonous Plants sites](#)



General poisoning notes:

Stinging nettle (*Urtica dioica*) is found across Canada and includes a wide-ranging native subspecies and an introduced subspecies found in the Maritime Provinces. The plant can form large colonies in orchards, farmyards, old pastures, ditches, and waste places. The stinging hairs readily break, allowing the secretions to enter skin. Humans receive a painful sting, followed by a small reddish swelling and prolonged itching and numbness. Initial reactions last only a few minutes but repeated contact can cause the pain to intensify and last for days. Hunting dogs in the United States were poisoned and died after massive exposure to the plants (Bassett et al. 1977, Mitchell and Rook 1979, Anon. 1982).

References:

Anon. 1982. Stinging nettle (*Urtica* sp.) and dogs. *Vet. Hum. Toxicol.*, 24: 247.

Bassett, I. J., [Crompton, C. W.](#), Woodland, D. W. 1977. The biology of Canadian weeds. 21. *Urtica dioica* L. *Can. J. Plant Sci.*, 57: 491-498.

Mitchell, J. C., Rook, A. 1979. *Botanical dermatology*. Greenglass Ltd, Vancouver, B.C., Canada. 787 pp.

Nomenclature:

Scientific Name: *Urtica dioica* L.

Vernacular name(s): stinging nettle

Scientific family name: *Urticaceae*

Vernacular family name: nettle

Go to ITIS^{*ca} for more taxonomic information on: [Urtica dioica](#)

References:

Agriculture Quebec. 1975. Noms des maladies des plantes du Canada/ Names of plant diseases in Canada. , Quebec City, Que., Canada. 288 pp.

Alex, J. F., Cayouette, R., Mulligan, G. A. 1980. Common and botanical names of weeds in Canada/Noms populaire et scientifiques des plantes nuisibles du Canada. Revised. Agric. Can. Publ., Ottawa, Ont., Canada. 132 pp.

Bailey, L. H., Bailey, E. Z. 1976. Hortus third. Revised. MacMillan, New York, N.Y., USA. 1290 pp.

Scoggan, H. J. 1978, 1979. The flora of Canada. Nat. Mus. Nat. Sci. (Ottawa) Publ. Bot. 7(1)-7(4). 1711 pp.

Van Wijk, H. L. 1911. A dictionary of plant names. Martinus Nijhoff, The Hague, The Netherlands. 1444 pp.

Victorin, M. 1964. Flore Laurentienne. 2nd ed. Univ. Montreal, Montreal, Que., Canada. 952 pp.

Geographic Information

Alberta
British Columbia
Manitoba
New Brunswick
Newfoundland
Northwest Territories
Nova Scotia
Ontario
Prince Edward Island
Quebec
Saskatchewan
Yukon Territory

References:

Bailey, L. H., Bailey, E. Z. 1976. Hortus third. Revised. MacMillan, New York, N.Y., USA. 1290 pp.

Boivin, B. 1966, 1967. Énumération des plantes du Canada. Provencheria 6. Nat. Can. (Que.) 93: 253-274; 371-437; 583-646; 989-1063. 94: 131-157; 471-528; 625-655.

Image or illustration

stinging nettle:

Images: images.google.com

Notes on Poisonous plant parts:

The stinging hairs on the stem, leaves, and flowers produce a painful sting. The hairs consist of a long shaft that narrows towards the point and has a small bulbous tip. The hair just below the tip is not silicified, unlike the rest of the hair, so that the tip is easily broken. A fine hollow shaft remains that can puncture the skin, through which secretions can enter (Mitchell and Rook 1979).

Toxic parts:

hairs

References:

Mitchell, J. C., Rook, A. 1979. Botanical dermatology. Greenglass Ltd, Vancouver, B.C., Canada. 787 pp.

Notes on Toxic plant chemicals:

The stinging hairs of stinging nettle contain the compounds acetylcholine, histamine, and 5-hydroxytryptamine. Acetylcholine is found naturally in mammals and is involved in firing nerves, whereas histamine causes swelling (Mitchell and Rook 1979).

Toxic plant chemicals:

acetylcholine
histamine
5-hydroxytryptamine

References:

Mitchell, J. C., Rook, A. 1979. Botanical dermatology. Greenglass Ltd, Vancouver, B.C., Canada. 787 pp.

Animals/Human Poisoning:

Note: When an animal is listed without additional information, the literature (as of 1993) contained no detailed explanation.

Dogs

General symptoms of poisoning:

[death](#)

[dyspnea](#)

[pain](#)

[trembling](#)

[vomiting](#)

Notes on poisoning:

Hunting dogs in the United States were poisoned after massive exposure to the hairs of stinging nettle. Symptoms included trembling, pain, slobbering, dyspnea, and vomiting. Some dogs died 2-3 days after exposure without treatment (Anon. 1982).

References:

Anon. 1982. Stinging nettle (*Urtica* sp.) and dogs. *Vet. Hum. Toxicol.*, 24: 247.

Humans

General symptoms of poisoning:

[erythema](#)

References:

Mitchell, J. C., Rook, A. 1979. *Botanical dermatology*. Greenglass Ltd, Vancouver, B.C., Canada. 787 pp.

[Another search?](#)

[Français](#) | [Contact Us](#) | [Help](#) | [Search](#) | [Canada site](#)

[Coming Events](#) | [About CBIF](#) | [Links](#) | [Reports and Publications](#) |

[Home](#)

Date modified: 2003-02-06

[Important Notices](#)



Français	Contact us	Help	Search	Canada site
Coming events	About CBIF	Links	Reports and publications	Home

Canadian Biodiversity Information Facility



Notes on poisoning: stinking rabbitbrush

[Introduction](#)

[Interactive](#)

[All poisonous plants by Botanical name](#)

[All poisonous plants by Common name](#)

[Important WWW Poisonous Plants sites](#)



General poisoning notes:

Stinking rabbitbrush (*Chrysothamnus nauseosus*) is a native shrub found on rangeland in western Canada. This plant has been reported to be toxic to livestock, and some feeding experiments have supported this conclusion. However, the plant is so unpalatable that quantities sufficient to cause toxicity are not likely to be ingested (Sampson and Malmsten 1935, Kingsbury 1964, Fuller and McClintock 1986).

References:

- Fuller, T. C., McClintock, E. 1986. Poisonous plants of California. Univ. California Press, Berkeley, Calif., USA. 432 pp.
- Kingsbury, J. M. 1964. Poisonous plants of the United States and Canada. Prentice-Hall Inc., Englewood Cliffs, N.J., USA. 626 pp.
- Sampson, A. W., Malmsten, H. E. 1935. Stock-poisoning plants of California. Univ. Calif. Div. Agric. Sci. Bull., 593. 90 pp.

Nomenclature:

Scientific Name: *Chrysothamnus nauseosus* (Pall.) Britt.

Vernacular name(s): stinking rabbitbrush

Scientific family name: *Compositae*

Vernacular family name: composite

Go to ITIS^{*ca} for more taxonomic information on:

[Chrysothamnus nauseosus](#)

References:

Agriculture Quebec. 1975. Noms des maladies des plantes du

Canada/ Names of plant diseases in Canada. , Quebec City, Que., Canada. 288 pp.

Alex, J. F., Cayouette, R., Mulligan, G. A. 1980. Common and botanical names of weeds in Canada/Noms populaire et scientifiques des plantes nuisibles du Canada. Revised. Agric. Can. Publ., Ottawa, Ont., Canada. 132 pp.

Bailey, L. H., Bailey, E. Z. 1976. Hortus third. Revised. MacMillan, New York, N.Y., USA. 1290 pp.

Scoggan, H. J. 1978, 1979. The flora of Canada. Nat. Mus. Nat. Sci. (Ottawa) Publ. Bot. 7(1)-7(4). 1711 pp.

Van Wijk, H. L. 1911. A dictionary of plant names. Martinus Nijhoff, The Hague, The Netherlands. 1444 pp.

Victorin, M. 1964. Flore Laurentienne. 2nd ed. Univ. Montreal, Montreal, Que., Canada. 952 pp.

Geographic Information

Alberta
British Columbia
Saskatchewan

References:

Bailey, L. H., Bailey, E. Z. 1976. Hortus third. Revised. MacMillan, New York, N.Y., USA. 1290 pp.

Boivin, B. 1966, 1967. Énumération des plantes du Canada. Provencheria 6. Nat. Can. (Que.) 93: 253-274; 371-437; 583-646; 989-1063. 94: 131-157; 471-528; 625-655.

Image or illustration

stinking rabbitbrush:

Images: images.google.com

Notes on Poisonous plant parts:

This plant is considered unpalatable for livestock under most circumstances (Fuller and McClintock 1986).

Toxic parts:

leaves

References:

Fuller, T. C., McClintock, E. 1986. Poisonous plants of California. Univ. California Press, Berkeley, Calif., USA. 432 pp.

Sampson, A. W., Malmsten, H. E. 1935. Stock-poisoning plants of California. Univ. Calif. Div. Agric. Sci. Bull., 593. 90 pp.

Toxic plant chemicals:

unknown chemical

References:

Fuller, T. C., McClintock, E. 1986. Poisonous plants of California. Univ. California Press, Berkeley, Calif., USA. 432 pp.

Sampson, A. W., Malmsten, H. E. 1935. Stock-poisoning plants of California. Univ. Calif. Div. Agric. Sci. Bull., 593. 90 pp.

Animals/Human Poisoning:

Note: When an animal is listed without additional information, the literature (as of 1993) contained no detailed explanation.

Cattle

[Another search?](#)

[Français](#) | [Contact Us](#) | [Help](#) | [Search](#) | [Canada site](#)

[Coming Events](#) | [About CBIF](#) | [Links](#) | [Reports and Publications](#) |

[Home](#)

Date modified: 2003-02-06

[Important Notices](#)



Français	Contact us	Help	Search	Canada site
Coming events	About CBIF	Links	Reports and publications	Home

Canadian Biodiversity Information Facility



Notes on poisoning: stinkweed

[Introduction](#)

[Interactive](#)

[All poisonous plants by Botanical name](#)

[All poisonous plants by Common name](#)

[Important WWW Poisonous Plants sites](#)

General poisoning notes:

Stinkweed (*Thlaspi arvense*) is a naturalized herb found in fields and waste places across Canada. The plant contains sufficient quantities of glucosinolates to be toxic. During dry periods, cattle in western Canada have ingested hay containing high quantities of stinkweed. Poisoning, death and abortion occurred (Smith and Crowe 1987). See [Brassica oleracea](#) for additional notes on glucosinolate poisoning.

References:



Cheeke, P. R., Shull, L. R. 1985. Natural toxicants in feeds and poisonous plants. AVI Publishing Company, Inc., Westport, Conn., USA. 492 pp.

Majak, W., McDiarmid, R. E., Benn, M. H., Willms, W. D. 1991. Autolysis of *Thlaspi arvense* in bovine rumen fluid. Phytochemistry (Oxf.), 30: 127-129.

Martin, T., Morgan, S. 1987. What caused the photosensitivity in these dairy heifers. Vet. Med. Small Anim. Clin., 82: 848-851.

Smith, R. A., Crowe, S. P. 1987. Fanweed toxicosis in cattle: case history, analytical method, suggested treatment, and fanweed detoxification. Vet. Hum. Toxicol., 29: 155-159.

Nomenclature:

Scientific Name: *Thlaspi arvense* L.

Vernacular name(s): stinkweed

Scientific family name: *Cruciferae*

Vernacular family name: mustard

Go to ITIS*^{ca} for more taxonomic information on: [Thlaspi arvense](#)

References:

Agriculture Quebec. 1975. Noms des maladies des plantes du Canada/ Names of plant diseases in Canada. , Quebec City, Que., Canada. 288 pp.

Alex, J. F., Cayouette, R., Mulligan, G. A. 1980. Common and botanical names of weeds in Canada/Noms populaire et scientifiques des plantes nuisibles du Canada. Revised. Agric. Can. Publ., Ottawa, Ont., Canada. 132 pp.

Bailey, L. H., Bailey, E. Z. 1976. Hortus third. Revised. MacMillan, New York, N.Y., USA. 1290 pp.

Scoggan, H. J. 1978, 1979. The flora of Canada. Nat. Mus. Nat. Sci. (Ottawa) Publ. Bot. 7(1)-7(4). 1711 pp.

Van Wijk, H. L. 1911. A dictionary of plant names. Martinus Nijhoff, The Hague, The Netherlands. 1444 pp.

Victorin, M. 1964. Flore Laurentienne. 2nd ed. Univ. Montreal, Montreal, Que., Canada. 952 pp.

Geographic Information

Alberta
British Columbia
Labrador
Manitoba
New Brunswick
Northwest Territories
Nova Scotia
Ontario
Prince Edward Island
Quebec
Saskatchewan
Yukon Territory

References:

Bailey, L. H., Bailey, E. Z. 1976. Hortus third. Revised. MacMillan, New York, N.Y., USA. 1290 pp.

Boivin, B. 1966, 1967. Énumération des plantes du Canada. Provencheria 6. Nat. Can. (Que.) 93: 253-274; 371-437; 583-646; 989-1063. 94: 131-157; 471-528; 625-655.

Image or illustration

stinkweed:

Images: images.google.com

Toxic parts:

leaves
seeds

References:

Best, K. F., McIntyre, G. I. 1975. The biology of Canadian weeds 9. *Thlaspi arvense* L. Can. J. Plant Sci., 55: 279-292.

Cheeke, P. R., Shull, L. R. 1985. Natural toxicants in feeds and poisonous plants. AVI Publishing Company, Inc., Westport, Conn., USA. 492 pp.

Smith, R. A., Crowe, S. P. 1987. Fanweed toxicosis in cattle: case history, analytical method, suggested treatment, and fanweed detoxification. Vet. Hum. Toxicol., 29: 155-159.

Notes on Toxic plant chemicals:

Tests of stinkweed showed that the allylthiocyanate (a glucosinolate) content is sufficient to cause sickness and death in cattle; fatalities occurred at about 65 mg/kg of body weight. The amount of this chemical varies with the stage of maturity of the plant; the highest amount is in the seeds (Smith and Crowe 1987, Majak et al. 1991).

Toxic plant chemicals:

glucosinolates

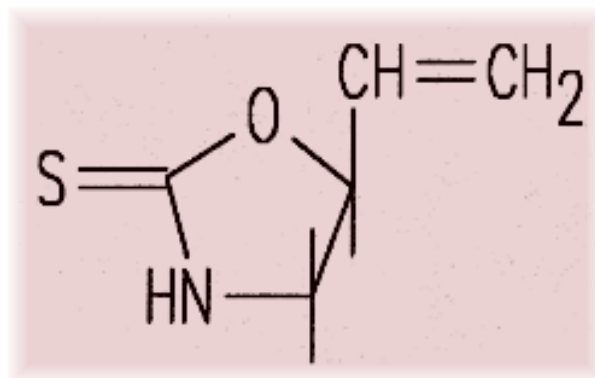

glucosinolates

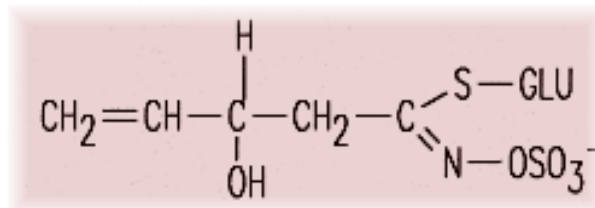

glucosinolates

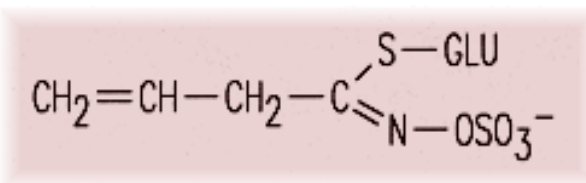

Chemical diagram(s) are courtesy of [Ruth McDiarmid](#), Biochemistry Technician, Kamloops Range Station, Agriculture and Agri-Food Canada, Kamloops, British Columbia, Canada.

References:

Best, K. F., McIntyre, G. I. 1975. The biology of Canadian weeds 9. *Thlaspi arvense* L. Can. J. Plant Sci., 55: 279-292.

Cheeke, P. R., Shull, L. R. 1985. Natural toxicants in feeds and poisonous plants. AVI Publishing Company, Inc., Westport, Conn., USA. 492 pp.

Majak, W., McDiarmid, R. E., Benn, M. H., Willms, W. D. 1991. Autolysis of *Thlaspi arvense* in bovine rumen fluid. Phytochemistry (Oxf.), 30: 127-129.

Smith, R. A., Crowe, S. P. 1987. Fanweed toxicosis in cattle: case history, analytical method, suggested treatment, and fanweed detoxification. Vet. Hum. Toxicol., 29: 155-159.

Animals/Human Poisoning:

Note: When an animal is listed without additional information, the literature (as of 1993) contained no detailed explanation.

Cattle

General symptoms of poisoning:

[abortion](#)

[colic](#)

[death](#)

[skin, peeling of](#)

Notes on poisoning:

Cattle that ingested hay containing between 25-100% stinkweed were colicky and some abortions occurred. Necropsy of cows revealed massive submucosal edema of the wall of forestomachs, particularly in the rumen. Lowering the rumen pH to 5 reportedly stops the allylthiocyanate from forming. However, more recent work found that lower pH did not significantly affect the liberation of allylthiocyanate. Administering large doses of piperazine (110 mg/kg) to rapidly reduce the concentration of toxin has been

suggested. Ensiling hay containing stinkweed apparently prevented liberation of allylthiocyanate (Smith and Crowe 1987). Yield of the chemical is a function of the diet, with alfalfa herbage allowing the lowest release quantity (30%) and alfalfa hay the highest yield (72%) (Majak et al. 1991).

References:

Cheeke, P. R., Shull, L. R. 1985. Natural toxicants in feeds and poisonous plants. AVI Publishing Company, Inc., Westport, Conn., USA. 492 pp.

Majak, W., McDiarmid, R. E., Benn, M. H., Willms, W. D. 1991. Autolysis of *Thlapsi arvense* in bovine rumen fluid. *Phytochemistry* (Oxf.), 30: 127-129.

Martin, T., Morgan, S. 1987. What caused the photosensitivity in these dairy heifers. *Vet. Med. Small Anim. Clin.*, 82: 848-851.

Smith, R. A., Crowe, S. P. 1987. Fanweed toxicosis in cattle: case history, analytical method, suggested treatment, and fanweed detoxification. *Vet. Hum. Toxicol.*, 29: 155-159.

[Another search?](#)

[Français](#) | [Contact Us](#) | [Help](#) | [Search](#) | [Canada site](#)

[Coming Events](#) | [About CBIF](#) | [Links](#) | [Reports and Publications](#) | [Home](#)

Date modified: 2003-02-06

[Important Notices](#)



Français	Contact us	Help	Search	Canada site
Coming events	About CBIF	Links	Reports and publications	Home

Canadian Biodiversity Information Facility



Notes on poisoning: Sudan grass

[Introduction](#)[Interactive](#)[All poisonous plants by Botanical name](#)[All poisonous plants by Common name](#)[Important WWW Poisonous Plants sites](#)

General poisoning notes:

Sudan grass (*Sorghum sudanense*) is a cultivated forage that is planted as a late-season emergency forage crop and is either pastured or cut for green feed. Some naturalized plants are occasionally found in waste places. Sudan grass can have an HCN potential after damage to the plant. It can also accumulate toxic quantities of nitrates. These problems can be avoided by proper management. Cattle are the main livestock animals that have been poisoned. In one case in California, sheep became photosensitive after ingesting Sudan grass pasture for several days. The photodynamic pigment was not determined (Gray et al. 1968, Clay et al. 1976, Fuller and McClintock 1986).

References:

- Clay, B. R., Edwards, W. C., Peterson, D. R. 1976. Toxic nitrate accumulation in the sorghums. *Bovine Pract.*, 11: 28-32.
- Fuller, T. C., McClintock, E. 1986. *Poisonous plants of California*. Univ. California Press, Berkeley, Calif., USA. 432 pp.
- Gray, E., Rice, J. S., Wattenbarger, D., Benson, J. A., Hester, A. J., Loyd, R. C., Greene, B. M. 1968. Hydrocyanic acid potential of *Sorghum* plants grown in Tennessee. *Tenn. Agric. Exp. Stn. Bull.*, 445. 48 pp.

Nomenclature:

Scientific Name: *Sorghum sudanense* (Piper) Stapf

Vernacular name(s): Sudan grass

Scientific family name: *Gramineae*

Vernacular family name: grass

Go to ITIS^{*ca} for more taxonomic information on: [Sorghum sudanense](#)

References:

Agriculture Quebec. 1975. Noms des maladies des plantes du Canada/ Names of plant diseases in Canada. , Quebec City, Que., Canada. 288 pp.

Alex, J. F., Cayouette, R., Mulligan, G. A. 1980. Common and botanical names of weeds in Canada/Noms populaire et scientifiques des plantes nuisibles du Canada. Revised. Agric. Can. Publ., Ottawa, Ont., Canada. 132 pp.

Bailey, L. H., Bailey, E. Z. 1976. Hortus third. Revised. MacMillan, New York, N.Y., USA. 1290 pp.

Scoggan, H. J. 1978, 1979. The flora of Canada. Nat. Mus. Nat. Sci. (Ottawa) Publ. Bot. 7(1)-7(4). 1711 pp.

Van Wijk, H. L. 1911. A dictionary of plant names. Martinus Nijhoff, The Hague, The Netherlands. 1444 pp.

Victorin, M. 1964. Flore Laurentienne. 2nd ed. Univ. Montreal, Montreal, Que., Canada. 952 pp.

Geographic Information

Ontario

Quebec

References:

Bailey, L. H., Bailey, E. Z. 1976. Hortus third. Revised. MacMillan, New York, N.Y., USA. 1290 pp.

Boivin, B. 1966, 1967. Énumération des plantes du Canada. Provencheria 6. Nat. Can. (Que.) 93: 253-274; 371-437; 583-646; 989-1063. 94: 131-157; 471-528; 625-655.

Image or illustration

Sudan grass:

Images: images.google.com

Notes on Poisonous plant parts:

The HCN potential is greatest in younger plants. Damage to the plant material is required for release of the volatile HCN (Gray et al. 1968).

Toxic parts:

leaves
stems

References:

Clay, B. R., Edwards, W. C., Peterson, D. R. 1976. Toxic nitrate accumulation in the sorghums. *Bovine Pract.*, 11: 28-32.

Gray, E., Rice, J. S., Wattenbarger, D., Benson, J. A., Hester, A. J., Loyd, R. C., Greene, B. M. 1968. Hydrocyanic acid potential of *Sorghum* plants grown in Tennessee. *Tenn. Agric. Exp. Stn. Bull.*, 445. 48 pp.

Notes on Toxic plant chemicals:

Sudan grass contains a cyanogenic glycoside, dhurrin, that can release HCN after plant damage such as frost, mastication, and water stress and allows plant enzymes to alter the glycoside. If enough HCN is released into the animal's system, cyanide leads to cytotoxic hypoxia, which can result in death by asphyxiation. Nitrates can also accumulate to toxic levels in Sudan grass. A case of photosensitization occurred in sheep. A photodynamic pigment may be contained in Sudan grass (Gray et al. 1968, Clay et al. 1976, Fuller and McClintock 1986).

Toxic plant chemicals:

dhurrin

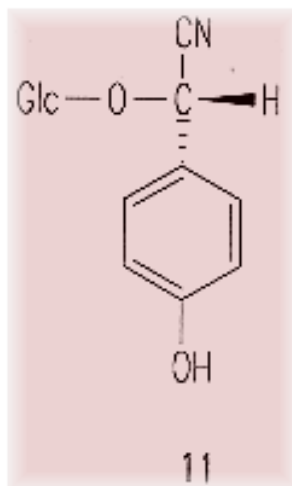

nitrate

Chemical diagram(s) are courtesy of [Ruth McDiarmid](#), Biochemistry Technician, Kamloops Range Station, Agriculture and Agri-Food Canada, Kamloops, British Columbia, Canada.

References:

Clay, B. R., Edwards, W. C., Peterson, D. R. 1976. Toxic nitrate accumulation in the sorghums. *Bovine Pract.*, 11: 28-32.

Fuller, T. C., McClintock, E. 1986. *Poisonous plants of California*. Univ. California Press, Berkeley, Calif., USA. 432 pp.

Gray, E., Rice, J. S., Wattenbarger, D., Benson, J. A., Hester, A. J., Loyd, R. C., Greene, B. M. 1968. Hydrocyanic acid potential of *Sorghum* plants grown in Tennessee. *Tenn. Agric. Exp. Stn. Bull.*, 445. 48 pp.

Animals/Human Poisoning:

Note: When an animal is listed without additional information, the literature (as of 1993) contained no detailed explanation.

Cattle

General symptoms of poisoning:

[abortion](#)

[breathing, rapid](#)

[death](#)

[death by asphyxiation](#)

[gait, staggering](#)

[methemoglobinemia](#)

[mouth, frothing of](#)

Notes on poisoning:

The release of cyanide into the animal's system leads to cytotoxic hypoxia. In severe cases, death has resulted from asphyxiation. Other symptoms include increased breathing rate, irregular pulse, staggering, and frothing at the mouth. Nitrate poisoning causes methemoglobinemia, which can result in death. From 3-5 days after surviving acute poisoning, pregnant cows may abort (Gray et al. 1968, Clay et al. 1976).

References:

Clay, B. R., Edwards, W. C., Peterson, D. R. 1976. Toxic nitrate accumulation in the sorghums. *Bovine Pract.*, 11: 28-32.

Gray, E., Rice, J. S., Wattenbarger, D., Benson, J. A., Hester, A. J., Loyd, R. C., Greene, B. M. 1968. Hydrocyanic acid potential of *Sorghum* plants grown in Tennessee. *Tenn. Agric. Exp. Stn. Bull.*, 445. 48 pp.

Sheep

General symptoms of poisoning:

[breathing, labored](#)

[erythema](#)

[itchiness](#)

[nasal discharge](#)

References:

Fuller, T. C., McClintock, E. 1986. Poisonous plants of California. Univ. California Press, Berkeley, Calif., USA. 432 pp.

[Another search?](#)

[Français](#) | [Contact Us](#) | [Help](#) | [Search](#) | [Canada site](#)

[Coming Events](#) | [About CBIF](#) | [Links](#) | [Reports and Publications](#) |

[Home](#)

Date modified: 2003-02-06

[Important Notices](#)



Français	Contact us	Help	Search	Canada site
Coming events	About CBIF	Links	Reports and publications	Home

Canadian Biodiversity Information Facility



Notes on poisoning: sun spurge

[Introduction](#)[Interactive](#)[All poisonous plants by Botanical name](#)[All poisonous plants by Common name](#)[Important WWW Poisonous Plants sites](#)

General poisoning notes:

Sun spurge (*Euphorbia helioscopia*) is a naturalized herb occasionally found in southern Canada. The latex contains a strong irritant that causes burning and swelling in animals that ingest it. Sheep were poisoned and a human child died after ingesting the plant. This plant can cause irritation to livestock that ingestion it.



References:

Cooper, M. R., Johnson, A. W. 1984. Poisonous plants in Britain and their effects on animals and man. Her Majesty's Stationery Office, London, England. 305 pp.

Nomenclature:

Scientific Name: *Euphorbia helioscopia* L.

Vernacular name(s): sun spurge

Scientific family name: *Euphorbiaceae*

Vernacular family name: spurge

Go to ITIS*^{ca} for more taxonomic information on: [Euphorbia helioscopia](#)

References:

Agriculture Quebec. 1975. Noms des maladies des plantes du Canada/ Names of plant diseases in Canada. , Quebec City, Que., Canada. 288 pp.

Alex, J. F., Cayouette, R., Mulligan, G. A. 1980. Common and botanical names of weeds in Canada/Noms populaire et scientifiques des plantes nuisibles du Canada. Revised. Agric.

Can. Publ., Ottawa, Ont., Canada. 132 pp.

Bailey, L. H., Bailey, E. Z. 1976. Hortus third. Revised. MacMillan, New York, N.Y., USA. 1290 pp.

Scoggan, H. J. 1978, 1979. The flora of Canada. Nat. Mus. Nat. Sci. (Ottawa) Publ. Bot. 7(1)-7(4). 1711 pp.

Van Wijk, H. L. 1911. A dictionary of plant names. Martinus Nijhoff, The Hague, The Netherlands. 1444 pp.

Victorin, M. 1964. Flore Laurentienne. 2nd ed. Univ. Montreal, Montreal, Que., Canada. 952 pp.

Geographic Information

Plant or plant parts used in or around the home.

References:

Bailey, L. H., Bailey, E. Z. 1976. Hortus third. Revised. MacMillan, New York, N.Y., USA. 1290 pp.

Boivin, B. 1966, 1967. Énumération des plantes du Canada. Provencheria 6. Nat. Can. (Que.) 93: 253-274; 371-437; 583-646; 989-1063. 94: 131-157; 471-528; 625-655.

Image or illustration

sun spurge:

Images: images.google.com

Toxic parts:

latex

References:

Cooper, M. R., Johnson, A. W. 1984. Poisonous plants in Britain and their effects on animals and man. Her Majesty's Stationery Office, London, England. 305 pp.

Toxic plant chemicals:

12-deoxyphorbol

References:

Cooper, M. R., Johnson, A. W. 1984. Poisonous plants in Britain and their effects on animals and man. Her Majesty's Stationery

Office, London, England. 305 pp.

Frohne, D., Pfander, H. J. 1983. A colour atlas of poisonous plants. Wolfe Publishing Ltd., London, England. 291 pp.

Animals/Human Poisoning:

Note: When an animal is listed without additional information, the literature (as of 1993) contained no detailed explanation.

Humans

Sheep

General symptoms of poisoning:

[abdominal pains](#)

[coma](#)

[death](#)

[diarrhea](#)

[lungs, congestion of](#)

[mouth, irritation of](#)

[salivation](#)

[vomiting](#)

Notes on poisoning:

In Britain, sheep that had ingested sun spurge experienced severe swelling and inflammation of the mouth, diarrhea, and salivation. The animals recovered fully when moved to new pasture that did not contain this plant (Cooper and Johnson 1984). One of two children died after sucking the juice of sun spurge. Symptoms included burning of the mouth, esophagus, and stomach, salivation, vomiting, narrowing of the pupils, and lung edema. One child went into a coma before death (Cooper and Johnson 1984).

References:

Cooper, M. R., Johnson, A. W. 1984. Poisonous plants in Britain and their effects on animals and man. Her Majesty's Stationery Office, London, England. 305 pp.

[Another search?](#)

[Français](#) | [Contact Us](#) | [Help](#) | [Search](#) | [Canada site](#)

[Coming Events](#) | [About CBIF](#) | [Links](#) | [Reports and Publications](#) |

[Home](#)

Date modified: 2003-02-06

[Important Notices](#)



Français	Contact us	Help	Search	Canada site
Coming events	About CBIF	Links	Reports and publications	Home

Canadian Biodiversity Information Facility



Notes on poisoning: sunflower

[Introduction](#)

[Interactive](#)

[All poisonous plants by Botanical name](#)

[All poisonous plants by Common name](#)

[Important WWW Poisonous Plants sites](#)



General poisoning notes:

Sunflower (*Helianthus annuus*) causes allergic contact dermatitis in sensitive individuals after contact with the sesquiterpene lactones contained in fragile, multicellular, capitate glandular hairs (Hausen and Spring 1989). Cattle have been poisoned in Europe after ingesting plants that did not have mature seeds. This is a result of nitrate toxicity, which has caused sickness and death (Cooper and Johnson 1984).

References:

Cooper, M. R., Johnson, A. W. 1984. Poisonous plants in Britain and their effects on animals and man. Her Majesty's Stationery Office, London, England. 305 pp.

Hausen, B. M., Spring, O. 1989. Sunflower allergy. On the constituents of the trichomes of *Helianthus annuus* L. (Compositae). Contact Dermatitis, 20: 326-334.

Nomenclature:

Scientific Name: *Helianthus annuus* L.

Vernacular name(s): sunflower

Scientific family name: *Compositae*

Vernacular family name: composite

Go to ITIS*^{ca} for more taxonomic information on: [Helianthus annuus](#)

References:

Agriculture Quebec. 1975. Noms des maladies des plantes du Canada/ Names of plant diseases in Canada. , Quebec City, Que.,

Canada. 288 pp.

Alex, J. F., Cayouette, R., Mulligan, G. A. 1980. Common and botanical names of weeds in Canada/Noms populaire et scientifiques des plantes nuisibles du Canada. Revised. Agric. Can. Publ., Ottawa, Ont., Canada. 132 pp.

Bailey, L. H., Bailey, E. Z. 1976. Hortus third. Revised. MacMillan, New York, N.Y., USA. 1290 pp.

Scoggan, H. J. 1978, 1979. The flora of Canada. Nat. Mus. Nat. Sci. (Ottawa) Publ. Bot. 7(1)-7(4). 1711 pp.

Van Wijk, H. L. 1911. A dictionary of plant names. Martinus Nijhoff, The Hague, The Netherlands. 1444 pp.

Victorin, M. 1964. Flore Laurentienne. 2nd ed. Univ. Montreal, Montreal, Que., Canada. 952 pp.

Geographic Information

References:

Bailey, L. H., Bailey, E. Z. 1976. Hortus third. Revised. MacMillan, New York, N.Y., USA. 1290 pp.

Boivin, B. 1966, 1967. Énumération des plantes du Canada. Provencheria 6. Nat. Can. (Que.) 93: 253-274; 371-437; 583-646; 989-1063. 94: 131-157; 471-528; 625-655.

Image or illustration

sunflower:

Images: images.google.com

Toxic parts:

hairs

References:

Hausen, B. M., Spring, O. 1989. Sunflower allergy. On the constituents of the trichomes of *Helianthus annuus* L. (Compositae). Contact Dermatitis, 20: 326-334.

Notes on Toxic plant chemicals:

Sunflower contains several sesquiterpene lactones, including the most active chemical, 1-O-methyl-4,5-dihydroxyniveusin A, in the hemiketal form. The complete mixture of sesquiterpene lactones

contributes to the allergic response in humans. These chemicals are found in the capitata glands on sunflower leaves (Hausen and Spring 1989). Sunflowers can also accumulate toxic amounts of nitrates, which have poisoned cattle in Europe (Cooper and Johnson 1984).

Toxic plant chemicals:

-dihydroniveusin A
nitrate

References:

Cooper, M. R., Johnson, A. W. 1984. Poisonous plants in Britain and their effects on animals and man. Her Majesty's Stationery Office, London, England. 305 pp.

Hausen, B. M., Spring, O. 1989. Sunflower allergy. On the constituents of the trichomes of *Helianthus annuus* L. (Compositae). Contact Dermatitis, 20: 326-334.

Animals/Human Poisoning:

Note: When an animal is listed without additional information, the literature (as of 1993) contained no detailed explanation.

Cattle

General symptoms of poisoning:

[agitation](#)

[collapse](#)

[death](#)

[lungs, congestion of](#)

Notes on poisoning:

Cattle that ingest sunflower plants that have not formed mature seeds develop nitrate poisoning. Symptoms include circulatory failure, swaying of hind quarters, excitation, and collapse 1-3 h after ingestion. Postmortem findings include lung edema, small hemorrhages and congestion of intestinal blood vessels, and dark-colored blood (Cooper and Johnson 1984).

References:

Cooper, M. R., Johnson, A. W. 1984. Poisonous plants in Britain and their effects on animals and man. Her Majesty's Stationery Office, London, England. 305 pp.

Humans

General symptoms of poisoning:

[eczema](#)

[erythema](#)

References:

Hausen, B. M., Spring, O. 1989. Sunflower allergy. On the constituents of the trichomes of *Helianthus annuus* L. (Compositae). Contact Dermatitis, 20: 326-334.

[Another search?](#)

[Français](#) | [Contact Us](#) | [Help](#) | [Search](#) | [Canada site](#)

[Coming Events](#) | [About CBIF](#) | [Links](#) | [Reports and Publications](#) |

[Home](#)

Date modified: 2003-02-06

[Important Notices](#)



Français	Contact us	Help	Search	Canada site
Coming events	About CBIF	Links	Reports and publications	Home

Canadian Biodiversity Information Facility



Notes on poisoning: sweet pea

[Introduction](#)[Interactive](#)[All poisonous plants by Botanical name](#)[All poisonous plants by Common name](#)[Important WWW Poisonous Plants sites](#)

General poisoning notes:

Sweet pea (*Lathyrus odoratus*) is a summer annual commonly cultivated because of its beautiful fragrant flowers. The pods and seeds contain BAPN (beta-aminopropionitrile), which causes osteolathyrism, a syndrome characterized by skeletal deformities and aortic rupture. This chemical was first extracted from sweet pea plants and has since been found in some other members of the genus *Lathyrus*. Horses are more susceptible to this syndrome than other livestock. Most of the information on osteolathyrism is based on experimental work. This problem has not occurred in humans; instead, see neurolathyrins under grass pea (*Lathyrus sativus*). In Canada, ingesting enough sweet pea to cause osteolathyrism is not likely (Selye 1957, Cheeke and Schull 1985).

References:

Cheeke, P. R., Shull, L. R. 1985. Natural toxicants in feeds and poisonous plants. AVI Publishing Company, Inc., Westport, Conn., USA. 492 pp.

Lalich, J. J., Barnett, B. D., Bird, H. R. 1957. Production of aortic rupture in turkey poultts fed beta-aminopropionitrile. Arch. Pathol., 64: 643-648.

Selye, H. 1957. Lathyrism. Rev. Can. Biol., 16: 1-82.

Simpson, C. F., Cardeilhac, P. T. 1983. Mortality, hemodynamics, an aortic properties among male and female turkeys fed beta-aminopropionitrile (41541). Proc. Soc. Exp. Biol. Med., 172: 168-172.

Nomenclature:

Scientific Name: *Lathyrus odoratus* L.

Vernacular name(s): sweet pea

Scientific family name: *Leguminosae*

Vernacular family name: pea

Go to ITIS^{*ca} for more taxonomic information on: [Lathyrus odoratus](#)

References:

Agriculture Quebec. 1975. Noms des maladies des plantes du Canada/ Names of plant diseases in Canada. , Quebec City, Que., Canada. 288 pp.

Alex, J. F., Cayouette, R., Mulligan, G. A. 1980. Common and botanical names of weeds in Canada/Noms populaire et scientifiques des plantes nuisibles du Canada. Revised. Agric. Can. Publ., Ottawa, Ont., Canada. 132 pp.

Bailey, L. H., Bailey, E. Z. 1976. Hortus third. Revised. MacMillan, New York, N.Y., USA. 1290 pp.

Scoggan, H. J. 1978, 1979. The flora of Canada. Nat. Mus. Nat. Sci. (Ottawa) Publ. Bot. 7(1)-7(4). 1711 pp.

Van Wijk, H. L. 1911. A dictionary of plant names. Martinus Nijhoff, The Hague, The Netherlands. 1444 pp.

Victorin, M. 1964. Flore Laurentienne. 2nd ed. Univ. Montreal, Montreal, Que., Canada. 952 pp.

Geographic Information

Plant or plant parts used in or around the home.

References:

Bailey, L. H., Bailey, E. Z. 1976. Hortus third. Revised. MacMillan, New York, N.Y., USA. 1290 pp.

Boivin, B. 1966, 1967. Énumération des plantes du Canada. Provencheria 6. Nat. Can. (Que.) 93: 253-274; 371-437; 583-646; 989-1063. 94: 131-157; 471-528; 625-655.

Image or illustration

sweet pea:

Images: images.google.com

Toxic parts:

seeds

References:

Roy, D. N., Spencer, P. S. 1989. Lathyrogens. Pages 169-201 in Cheeke, P. R., ed. Toxicants of plant origin. Vol. III. Proteins and amino acids. CRC Press, Inc., Boca Raton, Fla., USA. 271 pp.

Toxic plant chemicals:

beta-aminopropionitrile

References:

Roy, D. N., Spencer, P. S. 1989. Lathyrogens. Pages 169-201 in Cheeke, P. R., ed. Toxicants of plant origin. Vol. III. Proteins and amino acids. CRC Press, Inc., Boca Raton, Fla., USA. 271 pp.

Animals/Human Poisoning:

Note: When an animal is listed without additional information, the literature (as of 1993) contained no detailed explanation.

Horses

General symptoms of poisoning:

[aneurysm](#)

[gait, rigid](#)

[scoliosis](#)

Notes on poisoning:

Literature reports of osteolathyrism show that horses are particularly susceptible. Symptoms include skeletal deformity, such as long bone curvature, kyphosis, scoliosis, osteoporosis, and poor development of connective tissue. Aortic rupture also occurs. These effects are due to defective synthesis of collagen and elastin tissue caused by BAPN (Cheeke and Schull 1985).

References:

Cheeke, P. R., Shull, L. R. 1985. Natural toxicants in feeds and poisonous plants. AVI Publishing Company, Inc., Westport, Conn., USA. 492 pp.

Rodents

General symptoms of poisoning:

[abortion](#)

[aneurysm](#)

[bones, fragile](#)

Notes on poisoning:

Experimental feeding of sweet pea seeds to rats has caused symptoms of osteolathyrism, including the production of fragile bones, muscle atrophy, fatty bone marrow, hernias, thin skin, and scoliosis (Selye 1957, Cheeke and Schull 1985).

References:

Selye, H. 1957. Lathyrism. Rev. Can. Biol., 16: 1-82.

Turkeys

General symptoms of poisoning:

[aneurysm](#)

Notes on poisoning:

Experimental feeding of the toxic chemical beta-aminopropionitrile (BAPN) caused aortic dissecting aneurysms in turkey poults. Mortality was quite high as a result. See additional information under general notes of [Lathyrus sativus](#) (Lalich et al. 1957, Simpson and Cardeilhac 1983).

References:

Lalich, J. J., Barnett, B. D., Bird, H. R. 1957. Production of aortic rupture in turkey poults fed beta-aminopropionitrile. Arch. Pathol., 64: 643-648.

Simpson, C. F., Cardeilhac, P. T. 1983. Mortality, hemodynamics, an aortic properties among male and female turkeys fed beta-aminopropionitrile (41541). Proc. Soc. Exp. Biol. Med., 172: 168-172.

[Another search?](#)

[Français](#) | [Contact Us](#) | [Help](#) | [Search](#) | [Canada site](#)

[Coming Events](#) | [About CBIF](#) | [Links](#) | [Reports and Publications](#) |

[Home](#)

Date modified: 2003-02-06

[Important Notices](#)



Français	Contact us	Help	Search	Canada site
Coming events	About CBIF	Links	Reports and publications	Home

Canadian Biodiversity Information Facility



Notes on poisoning: Swiss-cheese plant

[Introduction](#)[Interactive](#)[All poisonous plants by Botanical name](#)[All poisonous plants by Common name](#)[Important WWW Poisonous Plants sites](#)

General poisoning notes:

Swiss-cheese plant (*Monstera deliciosa*) is an indoor ornamental. The leaves can cause problems if chewed by humans or family pets. Experimental rats and mice died after they were fed plant extracts (Der Marderosian et al. 1976, Lampe and McCann 1985).



References:

Der Marderosian, A. H., Giller, F. B., Roia, F. C. 1976. Phytochemical and toxicological screening of household ornamental plants potentially toxic to humans. 1. *J. Toxicol. Environ. Health*, 1: 939-953.

Lampe, K. F., McCann, M. A. 1985. *AMA Handbook of poisonous and injurious plants*. American Medical Assoc. Chicago, Ill., USA. 432 pp.

Mitchell, J. C., Rook, A. 1979. *Botanical dermatology*. Greenglass Ltd, Vancouver, B.C., Canada. 787 pp.

Nomenclature:

Scientific Name: *Monstera deliciosa* Liebm.

Vernacular name(s): Swiss-cheese plant

Scientific family name: *Araceae*

Vernacular family name: arum

Go to ITIS^{*ca} for more taxonomic information on: [Monstera deliciosa](#)

References:

Agriculture Quebec. 1975. Noms des maladies des plantes du

Canada/ Names of plant diseases in Canada. , Quebec City, Que., Canada. 288 pp.

Alex, J. F., Cayouette, R., Mulligan, G. A. 1980. Common and botanical names of weeds in Canada/Noms populaire et scientifiques des plantes nuisibles du Canada. Revised. Agric. Can. Publ., Ottawa, Ont., Canada. 132 pp.

Bailey, L. H., Bailey, E. Z. 1976. Hortus third. Revised. MacMillan, New York, N.Y., USA. 1290 pp.

Scoggan, H. J. 1978, 1979. The flora of Canada. Nat. Mus. Nat. Sci. (Ottawa) Publ. Bot. 7(1)-7(4). 1711 pp.

Van Wijk, H. L. 1911. A dictionary of plant names. Martinus Nijhoff, The Hague, The Netherlands. 1444 pp.

Victorin, M. 1964. Flore Laurentienne. 2nd ed. Univ. Montreal, Montreal, Que., Canada. 952 pp.

Geographic Information

Plant or plant parts used in or around the home.

References:

Bailey, L. H., Bailey, E. Z. 1976. Hortus third. Revised. MacMillan, New York, N.Y., USA. 1290 pp.

Boivin, B. 1966, 1967. Énumération des plantes du Canada. Provencheria 6. Nat. Can. (Que.) 93: 253-274; 371-437; 583-646; 989-1063. 94: 131-157; 471-528; 625-655.

Image or illustration

Swiss-cheese plant:

Images: images.google.com

Toxic parts:

leaves

References:

Der Marderosian, A. H., Giller, F. B., Roia, F. C. 1976. Phytochemical and toxicological screening of household ornamental plants potentially toxic to humans. 1. J. Toxicol. Environ. Health, 1: 939-953.

Lampe, K. F., McCann, M. A. 1985. AMA Handbook of poisonous and injurious plants. American Medical Assoc.

Chicago, Ill., USA. 432 pp.

Animals/Human Poisoning:

Note: When an animal is listed without additional information, the literature (as of 1993) contained no detailed explanation.

Humans

General symptoms of poisoning:

[aphonia](#)

[blistering](#)

[hoarseness](#)

[mouth, irritation of](#)

[urticaria](#)

Notes on poisoning:

Chewing the leaf causes severe pain and irritation, along with blistering and edema of mouth tissue. Hoarseness and loss of voice can also occur. The insoluble oxalates do not cause systemic poisoning in humans (Lampe and McCann 1985). Ingesting the ripened fruit can cause rapidly developing urticaria (hives) in sensitive individuals (Mitchell and Rook 1979). The ripe fruit is edible but is not normally produced indoors in Canada.

References:

Lampe, K. F., McCann, M. A. 1985. AMA Handbook of poisonous and injurious plants. American Medical Assoc. Chicago, Ill., USA. 432 pp.

Mitchell, J. C., Rook, A. 1979. Botanical dermatology. Greenglass Ltd, Vancouver, B.C., Canada. 787 pp.

Rodents

[Another search?](#)

[Français](#) | [Contact Us](#) | [Help](#) | [Search](#) | [Canada site](#)

[Coming Events](#) | [About CBIF](#) | [Links](#) | [Reports and Publications](#) | [Home](#)

Date modified: 2003-02-06

[Important Notices](#)



Français	Contact us	Help	Search	Canada site
Coming events	About CBIF	Links	Reports and publications	Home



Notes on poisoning: tall larkspur

[Introduction](#)

[Interactive](#)

[All poisonous plants by Botanical name](#)

[All poisonous plants by Common name](#)

[Important WWW Poisonous Plants sites](#)



General poisoning notes:

Tall larkspur (*Delphinium glaucum*) is a native herb found in central and western Canada. The plant is poisonous to cattle and can be poisonous to horses and sheep when ingested in higher amounts. In an experiment with *Delphinium barbei* (not found in Canada), six times as much plant material (per kilogram of body weight) was needed to poison sheep than to poison cattle. Why cattle are sensitive to larkspur poisoning is not understood. The alkaloid methyllycaconitine causes curare-like effects on the skeletal muscles and can cause motor paralysis, followed by death from asphyxiation (Nation et al. 1982, Cheeke and Schull 1985, Olsen and Manners 1989).

References:

Cheeke, P. R., Shull, L. R. 1985. Natural toxicants in feeds and poisonous plants. AVI Publishing Company, Inc., Westport, Conn., USA. 492 pp.

Olsen, J. D., Manners, G. D. 1989. Toxicology of diterpenoid alkaloids in rangeland larkspur (*Delphinium* spp.). Pages 291-326 in Cheeke, P. R., ed. Toxicants of plant origin. Vol. I. Alkaloids. CRC Press, Inc., Boca Raton, Fla., USA. 335 pp.

Nomenclature:

Scientific Name: *Delphinium glaucum* S. Wats.

Vernacular name(s): tall larkspur

Scientific family name: *Ranunculaceae*

Vernacular family name: crowfoot

Go to ITIS*^{ca} for more taxonomic information on: [Delphinium glaucum](#)

References:

Agriculture Quebec. 1975. Noms des maladies des plantes du Canada/Names of plant diseases in Canada. , Quebec City, Que., Canada. 288 pp.

Alex, J. F., Cayouette, R., Mulligan, G. A. 1980. Common and botanical names of weeds in Canada/Noms populaire et scientifiques des plantes nuisibles du Canada. Revised. Agric. Can. Publ., Ottawa, Ont., Canada. 132 pp.

Bailey, L. H., Bailey, E. Z. 1976. Hortus third. Revised. MacMillan, New York, N.Y., USA. 1290 pp.

Scoggan, H. J. 1978, 1979. The flora of Canada. Nat. Mus. Nat. Sci. (Ottawa) Publ. Bot. 7(1)-7(4). 1711 pp.

Van Wijk, H. L. 1911. A dictionary of plant names. Martinus Nijhoff, The Hague, The Netherlands. 1444 pp.

Victorin, M. 1964. Flore Laurentienne. 2nd ed. Univ. Montreal, Montreal, Que., Canada. 952 pp.

Geographic Information

Alberta
British Columbia
Manitoba
Northwest Territories
Ontario
Quebec
Saskatchewan
Yukon Territory

References:

Bailey, L. H., Bailey, E. Z. 1976. Hortus third. Revised. MacMillan, New York, N.Y., USA. 1290 pp.

Boivin, B. 1966, 1967. Énumération des plantes du Canada. Provencheria 6. Nat. Can. (Que.) 93: 253-274; 371-437; 583-646; 989-1063. 94: 131-157; 471-528; 625-655.

Image or illustration

tall larkspur:

Images: images.google.com

Notes on Poisonous plant parts:

All parts of larkspur plants contain alkaloids. Cattle have been poisoned after browsing on the aboveground plant material. Sheep and horses have been experimentally poisoned by various larkspur species, but they are much more tolerant of the toxic alkaloids (Olsen and Manners 1989).

Toxic parts:

all parts
leaves
seeds

References:

Looman, J. 1984. The biological flora of Canada. 5. *Delphinium glaucum* Watson, tall larkspur. Can. Field-Nat., 98: 345-361.

Olsen, J. D., Manners, G. D. 1989. Toxicology of diterpenoid alkaloids in rangeland larkspur (*Delphinium* spp.). Pages 291-326 in Cheeke, P. R., ed. Toxicants of plant origin. Vol. I. Alkaloids. CRC Press, Inc., Boca Raton, Fla., USA. 335 pp.

Notes on Toxic plant chemicals:

Methyllycaconitine, a diterpene alkaloid, is considered to be the most toxic of the alkaloids occurring in larkspurs that are likely to be grazed by cattle on rangelands. Many other alkaloids occur in larkspurs, but they are much less toxic than methyllycaconitine. The LD-50 of this chemical on mice is 3.2 mg/kg administered intravenously. It has a pronounced curare-like effect on skeletal muscle (Olsen and Manners 1989).

Toxic plant chemicals:

methyllycaconitine

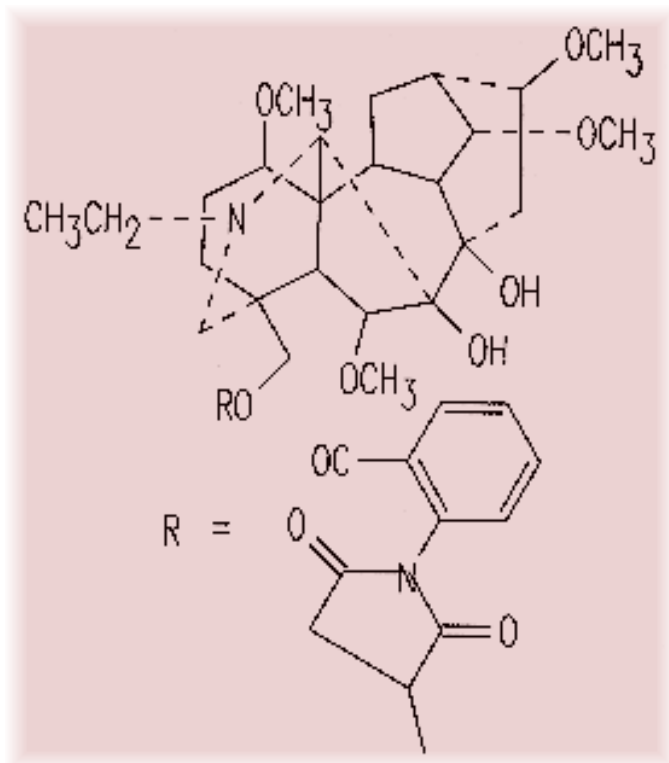

Chemical diagram(s) are courtesy of [Ruth McDiarmid](#), Biochemistry Technician, Kamloops Range Station, Agriculture and Agri-Food Canada, Kamloops, British Columbia, Canada.

References:

Looman, J. 1984. The biological flora of Canada. 5. *Delphinium glaucum* Watson, tall larkspur. Can. Field-Nat., 98: 345-361.

Olsen, J. D., Manners, G. D. 1989. Toxicology of diterpenoid alkaloids in rangeland larkspur (*Delphinium* spp.). Pages 291-326 in Cheeke, P. R., ed. Toxicants of plant origin. Vol. I. Alkaloids. CRC Press, Inc., Boca Raton, Fla., USA. 335 pp.

Animals/Human Poisoning:

Note: When an animal is listed without additional information, the literature (as of 1993) contained no detailed explanation.

Cattle

Horses

Sheep

[Another search?](#)

[Français](#) | [Contact Us](#) | [Help](#) | [Search](#) | [Canada site](#)

[Coming Events](#) | [About CBIF](#) | [Links](#) | [Reports and Publications](#) | [Home](#)

Date modified: 2003-02-06

[Important Notices](#)



Français	Contact us	Help	Search	Canada site
Coming events	About CBIF	Links	Reports and publications	Home

Canadian Biodiversity Information Facility



Notes on poisoning: tall manna grass

[Introduction](#)

[Interactive](#)

[All poisonous plants by Botanical name](#)

[All poisonous plants by Common name](#)

[Important WWW Poisonous Plants sites](#)



General poisoning notes:

Tall manna grass (*Glyceria grandis*) is a native and naturalized grass found across Canada. This plant has caused sickness and death in a herd of cattle in British Columbia. The poisoning took place early in the season, suggesting that the amount of cyanogenic potential decreases in the plant later in the season (Puls et al. 1978).

References:

Puls, R., Newschwander, F. P., Greenway, J. A. 1978. Cyanide poisoning from *Glyceria grandis* S. Wats. ex Gray (tall mannagrass) in a British Columbia beef herd. Can. Vet. J., 19: 264-265.

Nomenclature:

Scientific Name: *Glyceria grandis* S. Wats.

Vernacular name(s): tall manna grass

Scientific family name: *Gramineae*

Vernacular family name: grass

Go to ITIS^{*ca} for more taxonomic information on: [Glyceria grandis](#)

References:

Agriculture Quebec. 1975. Noms des maladies des plantes du Canada/ Names of plant diseases in Canada. , Quebec City, Que., Canada. 288 pp.

Alex, J. F., Cayouette, R., Mulligan, G. A. 1980. Common and botanical names of weeds in Canada/Noms populaire et

scientifiques des plantes nuisibles du Canada. Revised. Agric. Can. Publ., Ottawa, Ont., Canada. 132 pp.

Bailey, L. H., Bailey, E. Z. 1976. Hortus third. Revised. MacMillan, New York, N.Y., USA. 1290 pp.

Scoggan, H. J. 1978, 1979. The flora of Canada. Nat. Mus. Nat. Sci. (Ottawa) Publ. Bot. 7(1)-7(4). 1711 pp.

Van Wijk, H. L. 1911. A dictionary of plant names. Martinus Nijhoff, The Hague, The Netherlands. 1444 pp.

Victorin, M. 1964. Flore Laurentienne. 2nd ed. Univ. Montreal, Montreal, Que., Canada. 952 pp.

Geographic Information

Alberta
British Columbia
Manitoba
New Brunswick
Northwest Territories
Ontario
Prince Edward Island
Quebec
Saskatchewan

References:

Bailey, L. H., Bailey, E. Z. 1976. Hortus third. Revised. MacMillan, New York, N.Y., USA. 1290 pp.

Boivin, B. 1966, 1967. Énumération des plantes du Canada. Provencheria 6. Nat. Can. (Que.) 93: 253-274; 371-437; 583-646; 989-1063. 94: 131-157; 471-528; 625-655.

Image or illustration

tall manna grass:

Images: images.google.com

Toxic parts:

leaves
stems

References:

Puls, R., Newschwander, F. P., Greenway, J. A. 1978. Cyanide poisoning from *Glyceria grandis* S. Wats. ex Gray (tall

mannagrass) in a British Columbia beef herd. Can. Vet. J., 19: 264-265.

Notes on Toxic plant chemicals:

An unknown cyanogenic glycoside that can be converted to cyanide in the animal body is found in tall manna grass. Cyanide in concentrations of more than 10 ppm was detected in whole blood taken from poisoned cattle (Puls et al. 1978).

Toxic plant chemicals:

unknown chemical

References:

Puls, R., Newschwander, F. P., Greenway, J. A. 1978. Cyanide poisoning from *Glyceria grandis* S. Wats. ex Gray (tall mannagrass) in a British Columbia beef herd. Can. Vet. J., 19: 264-265.

Animals/Human Poisoning:

Note: When an animal is listed without additional information, the literature (as of 1993) contained no detailed explanation.

Cattle

General symptoms of poisoning:

[death](#)

[gait, staggering](#)

[liver, congestion of](#)

Notes on poisoning:

Symptoms included staggering and death. The liver was congested and lung lobes showed interlobular edema and slight emphysema. Animals that were staggering, but did not fall, recovered (Puls et al. 1978).

References:

Puls, R., Newschwander, F. P., Greenway, J. A. 1978. Cyanide poisoning from *Glyceria grandis* S. Wats. ex Gray (tall mannagrass) in a British Columbia beef herd. Can. Vet. J., 19: 264-265.

[Another search?](#)

[Français](#) | [Contact Us](#) | [Help](#) | [Search](#) | [Canada site](#)
[Coming Events](#) | [About CBIF](#) | [Links](#) | [Reports and Publications](#) |
[Home](#)

Date modified: 2003-02-06

[Important Notices](#)



Français	Contact us	Help	Search	Canada site
Coming events	About CBIF	Links	Reports and publications	Home

Canadian Biodiversity Information Facility



Notes on poisoning: tansy

[Introduction](#)

[Interactive](#)

[All poisonous plants by Botanical name](#)

[All poisonous plants by Common name](#)

[Important WWW Poisonous Plants sites](#)



Nomenclature:

Scientific Name: *Tanacetum vulgare* L.

Vernacular name(s): tansy

Scientific family name: *Compositae*

Vernacular family name: composite

Go to ITIS^{*ca} for more taxonomic information on: [Tanacetum vulgare](#)

References:

Agriculture Quebec. 1975. Noms des maladies des plantes du Canada/ Names of plant diseases in Canada. , Quebec City, Que., Canada. 288 pp.

Alex, J. F., Cayouette, R., Mulligan, G. A. 1980. Common and botanical names of weeds in Canada/Noms populaire et scientifiques des plantes nuisibles du Canada. Revised. Agric. Can. Publ., Ottawa, Ont., Canada. 132 pp.

Bailey, L. H., Bailey, E. Z. 1976. Hortus third. Revised. MacMillan, New York, N.Y., USA. 1290 pp.

Scoggan, H. J. 1978, 1979. The flora of Canada. Nat. Mus. Nat. Sci. (Ottawa) Publ. Bot. 7(1)-7(4). 1711 pp.

Van Wijk, H. L. 1911. A dictionary of plant names. Martinus Nijhoff, The Hague, The Netherlands. 1444 pp.

Victorin, M. 1964. Flore Laurentienne. 2nd ed. Univ. Montreal, Montreal, Que., Canada. 952 pp.

Geographic Information

British Columbia
Nova Scotia
Ontario
Quebec
Saskatchewan

References:

Bailey, L. H., Bailey, E. Z. 1976. Hortus third. Revised. MacMillan, New York, N.Y., USA. 1290 pp.

Boivin, B. 1966, 1967. Énumération des plantes du Canada. Provencheria 6. Nat. Can. (Que.) 93: 253-274; 371-437; 583-646; 989-1063. 94: 131-157; 471-528; 625-655.

Image or illustration

tansy:

Images: images.google.com

Notes on Poisonous plant parts:

All parts of the plant have a strong scent and contain a bitter essential oil that can be toxic (Fuller and McClintock 1986).

Toxic parts:

all parts
flowers
leaves

References:

Fuller, T. C., McClintock, E. 1986. Poisonous plants of California. Univ. California Press, Berkeley, Calif., USA. 432 pp.

Animals/Human Poisoning:

Note: When an animal is listed without additional information, the literature (as of 1993) contained no detailed explanation.

[Another search?](#)

[Français](#) | [Contact Us](#) | [Help](#) | [Search](#) | [Canada site](#)

[Coming Events](#) | [About CBIF](#) | [Links](#) | [Reports and Publications](#) | [Home](#)

Date modified: 2003-02-06

[Important Notices](#)



Français	Contact us	Help	Search	Canada site
Coming events	About CBIF	Links	Reports and publications	Home

Canadian Biodiversity Information Facility



Notes on poisoning: tansy ragwort

[Introduction](#)

[Interactive](#)

[All poisonous plants by Botanical name](#)

[All poisonous plants by Common name](#)

[Important WWW Poisonous Plants sites](#)



General poisoning notes:

Tansy ragwort (*Senecio jacobaea*) is a naturalized herb that is found in fields in eastern Canada and British Columbia. This plant contains pyrrolizidine alkaloids which primarily cause irreversible liver cirrhosis in animals that ingest them. This plant has poisoned cattle and horses, and possibly goats. In the late 19th century and early 20th century, the mysterious Pictou cattle disease in Nova Scotia resulted in heavy losses of cattle. Tansy ragwort ingestion was recognized as causing the problem. In the 1960s cattle losses in Oregon valued at several million dollars were attributed to tansy ragwort ingestion. This plant should be eradicated from forage and crops (Cheeke and Schull 1985, Huxtable 1989). Animals and humans may be poisoned if they drink the milk of animals that have ingested this plant (Molyneux and James 1990, Bain 1990).

References:

- Bain, J. F. 1991. The biology of Canadian weeds. 96. *Senecio jacobaea* L. Can. J. Plant Sci., 71: 127-140.
- Cheeke, P. R., Shull, L. R. 1985. Natural toxicants in feeds and poisonous plants. AVI Publishing Company, Inc., Westport, Conn., USA. 492 pp.
- Fuller, T. C., McClintock, E. 1986. Poisonous plants of California. Univ. California Press, Berkeley, Calif., USA. 432 pp.
- Huxtable, R. J. 1989. Human health implications of pyrrolizidine alkaloids and herbs containing them. Pages 41-86 in Cheeke, P. R., ed. Toxicants of plant origin. Vol. I. Alkaloids. CRC Press, Inc., Boca Raton, Fla., USA. 335 pp.
- Molyneux, R. J., James, L. F. 1990. Pyrrolizidine alkaloids in milk: thresholds of intoxication. Vet. Hum. Toxicol., 32: 94-103.
- Pearson, E. G. 1977. Clinical manifestations of tansy ragwort

poisoning. Mod. Vet. Pract., 57: 421-424.

Pearson, E. G. 1991. Liver failure attributable to pyrrolizidine alkaloid toxicosis and associated with inspiratory dyspnea in ponies: three cases (1982-1988). J. Am. Vet. Med. Assoc., 198: 1651-1654.

Pethick, W. H. 1921. Pictou cattle disease. Can. Vet. Rec., 2: 13-16.

Nomenclature:

Scientific Name: *Senecio jacobaea* L.

Vernacular name(s): tansy ragwort

Scientific family name: *Compositae*

Vernacular family name: composite

Go to ITIS^{*ca} for more taxonomic information on: [Senecio jacobaea](#)

References:

Agriculture Quebec. 1975. Noms des maladies des plantes du Canada/ Names of plant diseases in Canada. , Quebec City, Que., Canada. 288 pp.

Alex, J. F., Cayouette, R., Mulligan, G. A. 1980. Common and botanical names of weeds in Canada/Noms populaire et scientifiques des plantes nuisibles du Canada. Revised. Agric. Can. Publ., Ottawa, Ont., Canada. 132 pp.

Bailey, L. H., Bailey, E. Z. 1976. Hortus third. Revised. MacMillan, New York, N.Y., USA. 1290 pp.

Scoggan, H. J. 1978, 1979. The flora of Canada. Nat. Mus. Nat. Sci. (Ottawa) Publ. Bot. 7(1)-7(4). 1711 pp.

Van Wijk, H. L. 1911. A dictionary of plant names. Martinus Nijhoff, The Hague, The Netherlands. 1444 pp.

Victorin, M. 1964. Flore Laurentienne. 2nd ed. Univ. Montreal, Montreal, Que., Canada. 952 pp.

Geographic Information

British Columbia
New Brunswick
Newfoundland
Nova Scotia
Ontario

Prince Edward Island
Quebec

References:

Bailey, L. H., Bailey, E. Z. 1976. Hortus third. Revised. MacMillan, New York, N.Y., USA. 1290 pp.

Boivin, B. 1966, 1967. Énumération des plantes du Canada. Provencheria 6. Nat. Can. (Que.) 93: 253-274; 371-437; 583-646; 989-1063. 94: 131-157; 471-528; 625-655.

Image or illustration

tansy ragwort:

Images: images.google.com

Notes on Poisonous plant parts:

All parts of the plant contain toxic pyrrolizidine alkaloids. The flowers contain the highest concentration of the toxins. The concentration in the leaves increases to a maximum just before flower maturity (Johnson and Molyneux 1986).

Toxic parts:

all parts
flowers
leaves
stems

References:

Johnson, A. E., Molyneux, R. J. 1986. The pyrrolizidine alkaloid free base and N-oxide content of toxic range plants. J. Toxicol. Toxin Rev., 5: 256.

Pethick, W. H. 1921. Pictou cattle disease. Can. Vet. Rec., 2: 13-16.

Notes on Toxic plant chemicals:

Pyrrolizidine alkaloids such as jacobine and seneciphylline are found in tansy ragwort. The content of these alkaloids has been measured at a mean of 0.31% (Cheeke and Schull 1985, Johnson and Molyneux 1986).

Toxic plant chemicals:

jacobine
seneciphylline

References:

Cheeke, P. R., Shull, L. R. 1985. Natural toxicants in feeds and poisonous plants. AVI Publishing Company, Inc., Westport, Conn., USA. 492 pp.

Johnson, A. E., Molyneux, R. J. 1986. The pyrrolizidine alkaloid free base and N-oxide content of toxic range plants. J. Toxicol. Toxin Rev., 5: 256.

Animals/Human Poisoning:

Note: When an animal is listed without additional information, the literature (as of 1993) contained no detailed explanation.

Cattle

General symptoms of poisoning:

[abdominal edema](#)

[agitation](#)

[anorexia](#)

[diarrhea](#)

[jaundice](#)

[liver, cirrhosis of](#)

[nervousness](#)

Notes on poisoning:

So-called Pictou disease was identified in Pictou county, N. S., in cattle and horses; it also occurred in Prince Edward Island. For 20 years, the Canadian government ordered affected herds to be slaughtered before feeding trials confirmed, in 1906, that ingestion of tansy ragwort was responsible. The pyrrolizidine alkaloids cause irreversible liver cirrhosis, with pronounced fibrosis and biliary hyperplasia. Other symptoms include a peculiar bleached color of the hair, nervousness, incoordination, coma, and death. A rapid loss of milk production occurs in lactating cattle, and the milk may taste bitter with an unpleasant odor. Postmortem findings showed liver cirrhosis, often an enlarged gall bladder, abdominal edema, and edema in the mucosa and submucosa of the stomach and intestine (Pethick 1921, Cheeke and Schull 1985, Scimeca and Oehme 1985).

In a case in Oregon, a 3-week-old calf died. Post-mortem findings

showed signs of liver cirrhosis; tansy ragwort poisoning was diagnosed. The dam did not show any signs of tansy ragwort poisoning. Milk from goats was also shown to pass the pyrrolizidine alkaloid (Pearson 1977).

References:

Cheeke, P. R., Shull, L. R. 1985. Natural toxicants in feeds and poisonous plants. AVI Publishing Company, Inc., Westport, Conn., USA. 492 pp.

Pearson, E. G. 1977. Clinical manifestations of tansy ragwort poisoning. *Mod. Vet. Pract.*, 57: 421-424.

Pethick, W. H. 1921. Pictou cattle disease. *Can. Vet. Rec.*, 2: 13-16.

Goats

General symptoms of poisoning:

[abdominal edema](#)

[liver, cirrhosis of](#)

Notes on poisoning:

Goats are not usually poisoned, but if they are fed tansy ragwort they produce mutagenic milk. The pyrrolizidine alkaloids are found in the milk (Huxtable 1989).

References:

Cheeke, P. R., Shull, L. R. 1985. Natural toxicants in feeds and poisonous plants. AVI Publishing Company, Inc., Westport, Conn., USA. 492 pp.

Huxtable, R. J. 1989. Human health implications of pyrrolizidine alkaloids and herbs containing them. Pages 41-86 in Cheeke, P. R., ed. Toxicants of plant origin. Vol. I. Alkaloids. CRC Press, Inc., Boca Raton, Fla., USA. 335 pp.

Horses

General symptoms of poisoning:

[abdominal edema](#)

[coma](#)

[death](#)

[depression](#)

[dyspnea](#)

[gait, staggering](#)

[incoordination](#)
[jaundice](#)
[liver, cirrhosis of](#)
[skin, peeling of](#)
[weight loss](#)

References:

Cheeke, P. R., Shull, L. R. 1985. Natural toxicants in feeds and poisonous plants. AVI Publishing Company, Inc., Westport, Conn., USA. 492 pp.

Pearson, E. G. 1991. Liver failure attributable to pyrrolizidine alkaloid toxicosis and associated with inspiratory dyspnea in ponies: three cases (1982-1988). J. Am. Vet. Med. Assoc., 198: 1651-1654.

Humans

General symptoms of poisoning:

[liver, cirrhosis of](#)

Notes on poisoning:

Pyrrolizidine alkaloids from tansy ragwort were found in honey produced in Oregon and Washington states. The honey is off-color and bitter and is usually not sold. The amount of toxin is so low that acute symptoms of poisoning are unlikely. However, because the effects are cumulative, long term ingestion of this honey cannot be considered safe. There are no records of toxicity from ingesting honey (Fuller and McClintock 1986).

References:

Fuller, T. C., McClintock, E. 1986. Poisonous plants of California. Univ. California Press, Berkeley, Calif., USA. 432 pp.

Sheep

[Another search?](#)

[Français](#) | [Contact Us](#) | [Help](#) | [Search](#) | [Canada site](#)

[Coming Events](#) | [About CBIF](#) | [Links](#) | [Reports and Publications](#) | [Home](#)

Date modified: 2003-02-06

[Important Notices](#)



Français	Contact us	Help	Search	Canada site
Coming events	About CBIF	Links	Reports and publications	Home

Canadian Biodiversity Information Facility



Notes on poisoning: Tartarian honeysuckle

[Introduction](#)

[Interactive](#)

[All poisonous plants by Botanical name](#)

[All poisonous plants by Common name](#)

[Important WWW Poisonous Plants sites](#)

General poisoning notes:

Tartarian honeysuckle (*Lonicera tatarica*) is an ornamental shrub that has become naturalized throughout much of southern Canada. In European literature this plant have been implicated in the poisoning of children. See additional notes under fly honeysuckle, ([Lonicera xylosteum](#)).



References:

Frohne, D., Pfander, H. J. 1983. A colour atlas of poisonous plants. Wolfe Publishing Ltd., London, England. 291 pp.

Nomenclature:

Scientific Name: *Lonicera tatarica* L.

Vernacular name(s): Tartarian honeysuckle

Scientific family name: *Caprifoliaceae*

Vernacular family name: honeysuckle

Go to ITIS^{*ca} for more taxonomic information on: [Lonicera tatarica](#)

References:

Agriculture Quebec. 1975. Noms des maladies des plantes du Canada/ Names of plant diseases in Canada. , Quebec City, Que., Canada. 288 pp.

Alex, J. F., Cayouette, R., Mulligan, G. A. 1980. Common and botanical names of weeds in Canada/Noms populaire et scientifiques des plantes nuisibles du Canada. Revised. Agric. Can. Publ., Ottawa, Ont., Canada. 132 pp.

Bailey, L. H., Bailey, E. Z. 1976. Hortus third. Revised. MacMillan, New York, N.Y., USA. 1290 pp.

Scoggan, H. J. 1978, 1979. The flora of Canada. Nat. Mus. Nat. Sci. (Ottawa) Publ. Bot. 7(1)-7(4). 1711 pp.

Van Wijk, H. L. 1911. A dictionary of plant names. Martinus Nijhoff, The Hague, The Netherlands. 1444 pp.

Victorin, M. 1964. Flore Laurentienne. 2nd ed. Univ. Montreal, Montreal, Que., Canada. 952 pp.

Geographic Information

Alberta
Manitoba
New Brunswick
Ontario
Quebec
Saskatchewan

References:

Bailey, L. H., Bailey, E. Z. 1976. Hortus third. Revised. MacMillan, New York, N.Y., USA. 1290 pp.

Boivin, B. 1966, 1967. Énumération des plantes du Canada. Provencheria 6. Nat. Can. (Que.) 93: 253-274; 371-437; 583-646; 989-1063. 94: 131-157; 471-528; 625-655.

Image or illustration

Tartarian honeysuckle:

Images: images.google.com

Notes on Poisonous plant parts:

Ingesting the berries has caused mild toxicity in children (Frohne and Pfander 1983).

Toxic parts:

mature fruit

References:

Frohne, D., Pfander, H. J. 1983. A colour atlas of poisonous plants. Wolfe Publishing Ltd., London, England. 291 pp.

Notes on Toxic plant chemicals:

The toxic compounds are unknown, but they are suspected to be saponins (Frohne and Pfander 1983).

Toxic plant chemicals:

unknown chemical

References:

Frohne, D., Pfander, H. J. 1983. A colour atlas of poisonous plants. Wolfe Publishing Ltd., London, England. 291 pp.

Animals/Human Poisoning:

Note: When an animal is listed without additional information, the literature (as of 1993) contained no detailed explanation.

Humans

[Another search?](#)

[Français](#) | [Contact Us](#) | [Help](#) | [Search](#) | [Canada site](#)

[Coming Events](#) | [About CBIF](#) | [Links](#) | [Reports and Publications](#) |

[Home](#)

Date modified: 2003-02-06

[Important Notices](#)



Français	Contact us	Help	Search	Canada site
Coming events	About CBIF	Links	Reports and publications	Home

Canadian Biodiversity Information Facility



Notes on poisoning: thin-leaved snowberry

[Introduction](#)[Interactive](#)[All poisonous plants by Botanical name](#)[All poisonous plants by Common name](#)[Important WWW Poisonous Plants sites](#)

General poisoning notes:

Thin-leaved snowberry (*Symphoricarpos albus*) is a native shrub found throughout much of Canada in woods and open slopes. The plant is also used as an ornamental shrub in many areas. The white berries contain the isoquinoline alkaloid chelidonium, as well as other alkaloids. Ingesting the berries causes mild symptoms of vomiting, dizziness, and slight sedation in children. The risk of severe poisoning does not appear great because of vomiting that occurs after ingestion. Children should be discouraged from eating the attractive white fruit (Lewis 1979, Lampe and McCann 1985).

References:

Lampe, K. F., McCann, M. A. 1985. AMA Handbook of poisonous and injurious plants. American Medical Assoc. Chicago, Ill., USA. 432 pp.

Lewis, W. H. 1979. Snowberry (*Symphoricarpos*) poisoning in children. J. Am. Med. Assoc., 242: 2663.

Turner, N. J., Szczawinski, A. F. 1991. Common poisonous plants and mushrooms of North America. Timber Press, Portland, Oreg., USA. 311 pp.

Nomenclature:

Scientific Name: *Symphoricarpos albus* (L.) Blake

Vernacular name(s): thin-leaved snowberry

Scientific family name: *Caprifoliaceae*

Vernacular family name: honeysuckle

Go to ITIS*^{ca} for more taxonomic information on:

[*Symphoricarpos albus*](#)

References:

Agriculture Quebec. 1975. Noms des maladies des plantes du Canada/ Names of plant diseases in Canada. , Quebec City, Que., Canada. 288 pp.

Alex, J. F., Cayouette, R., Mulligan, G. A. 1980. Common and botanical names of weeds in Canada/Noms populaire et scientifiques des plantes nuisibles du Canada. Revised. Agric. Can. Publ., Ottawa, Ont., Canada. 132 pp.

Bailey, L. H., Bailey, E. Z. 1976. Hortus third. Revised. MacMillan, New York, N.Y., USA. 1290 pp.

Scoggan, H. J. 1978, 1979. The flora of Canada. Nat. Mus. Nat. Sci. (Ottawa) Publ. Bot. 7(1)-7(4). 1711 pp.

Van Wijk, H. L. 1911. A dictionary of plant names. Martinus Nijhoff, The Hague, The Netherlands. 1444 pp.

Victorin, M. 1964. Flore Laurentienne. 2nd ed. Univ. Montreal, Montreal, Que., Canada. 952 pp.

Geographic Information

Alberta
British Columbia
Manitoba
New Brunswick
Northwest Territories
Nova Scotia
Ontario
Quebec
Saskatchewan

References:

Bailey, L. H., Bailey, E. Z. 1976. Hortus third. Revised. MacMillan, New York, N.Y., USA. 1290 pp.

Boivin, B. 1966, 1967. Énumération des plantes du Canada. Provencheria 6. Nat. Can. (Que.) 93: 253-274; 371-437; 583-646; 989-1063. 94: 131-157; 471-528; 625-655.

Image or illustration

thin-leaved snowberry:

Images: images.google.com

Toxic parts:

mature fruit

References:

Lewis, W. H. 1979. Snowberry (*Symphoricarpos*) poisoning in children. J. Am. Med. Assoc., 242: 2663.

Notes on Toxic plant chemicals:

An isoquinoline alkaloid, chelidonine, was found in the fruits of thin-leaved snowberry. This chemical is also found in greater celandine (*Chelidonium majus*), an unrelated plant (Lewis 1979).

Toxic plant chemicals:

chelidonine

References:

Lewis, W. H. 1979. Snowberry (*Symphoricarpos*) poisoning in children. J. Am. Med. Assoc., 242: 2663.

Animals/Human Poisoning:

Note: When an animal is listed without additional information, the literature (as of 1993) contained no detailed explanation.

Humans

General symptoms of poisoning:

[dizziness](#)

[vomiting](#)

Notes on poisoning:

Children who ingested the attractive white fruits experienced vomiting, dizziness, and mild sedation. Blood-stained urine was also reported (Lewis 1979, Cooper and Johnson 1984).

References:

Lewis, W. H. 1979. Snowberry (*Symphoricarpos*) poisoning in children. J. Am. Med. Assoc., 242: 2663.

Turner, N. J., Szczawinski, A. F. 1991. Common poisonous plants and mushrooms of North America. Timber Press, Portland,

Oreg., USA. 311 pp.

[Another search?](#)

[Français](#) | [Contact Us](#) | [Help](#) | [Search](#) | [Canada site](#)

[Coming Events](#) | [About CBIF](#) | [Links](#) | [Reports and Publications](#) |

[Home](#)

Date modified: 2003-02-06

[Important Notices](#)



Français	Contact us	Help	Search	Canada site
Coming events	About CBIF	Links	Reports and publications	Home

Canadian Biodiversity Information Facility



Notes on poisoning: timber milk-vetch

[Introduction](#)[Interactive](#)[All poisonous plants by Botanical name](#)[All poisonous plants by Common name](#)[Important WWW Poisonous Plants sites](#)

General poisoning notes:

Timber milk-vetch (*Astragalus miser*) is a native herb that is found in southern British Columbia and southern Alberta. This plant causes acute and chronic toxicity in cattle and sheep. Experimental poisoning has been caused in other livestock. Honey bees that forage on the flowers of timber milk-vetch were also poisoned (Majak and Pass 1989).

References:



James, L. F., Hartley, W. J., Van Kampen, K. R. 1981. Syndromes of *Astragalus* poisoning in livestock. J. Am. Vet. Med. Assoc., 178: 146-150.

Majak, W., Neufeld, R., Corner, J. 1980. Toxicity of *Astragalus miser* v. *serotinus* to the honeybee. J. Apic. Res., 19: 196-199.

Majak, W., Pass, M. A. 1989. Aliphatic nitrocompounds. Pages 143-159 in Cheeke, P. R., ed. Toxicants of plant origin. Vol. II Glycosides. CRC Press, Inc., Boca Raton, Fla., USA. 277 pp.

Quinton, D. A., Majak, W., Hall, J. W. 1989. The effect of cattle grazing on the growth and miserotoxin content of Columbia milkvetch. J. Range Manage., 42: 368-371.

Nomenclature:

Scientific Name: *Astragalus miser* Dougl. ex Hook.

Vernacular name(s): timber milk-vetch

Scientific family name: *Leguminosae*

Vernacular family name: pea

Go to ITIS*^{ca} for more taxonomic information on: [Astragalus miser](#)

References:

Agriculture Quebec. 1975. Noms des maladies des plantes du Canada/ Names of plant diseases in Canada. , Quebec City, Que., Canada. 288 pp.

Alex, J. F., Cayouette, R., Mulligan, G. A. 1980. Common and botanical names of weeds in Canada/Noms populaire et scientifiques des plantes nuisibles du Canada. Revised. Agric. Can. Publ., Ottawa, Ont., Canada. 132 pp.

Bailey, L. H., Bailey, E. Z. 1976. Hortus third. Revised. MacMillan, New York, N.Y., USA. 1290 pp.

Scoggan, H. J. 1978, 1979. The flora of Canada. Nat. Mus. Nat. Sci. (Ottawa) Publ. Bot. 7(1)-7(4). 1711 pp.

Van Wijk, H. L. 1911. A dictionary of plant names. Martinus Nijhoff, The Hague, The Netherlands. 1444 pp.

Victorin, M. 1964. Flore Laurentienne. 2nd ed. Univ. Montreal, Montreal, Que., Canada. 952 pp.

Geographic Information

Alberta

British Columbia

References:

Bailey, L. H., Bailey, E. Z. 1976. Hortus third. Revised. MacMillan, New York, N.Y., USA. 1290 pp.

Boivin, B. 1966, 1967. Énumération des plantes du Canada. Provencheria 6. Nat. Can. (Que.) 93: 253-274; 371-437; 583-646; 989-1063. 94: 131-157; 471-528; 625-655.

Image or illustration

timber milk-vetch:

Images: images.google.com

Notes on Poisonous plant parts:

Timber milk-vetch contains miserotoxin. This toxic principle is found primarily in the leaves and reaches its highest concentration during the bud and mature-flower stages of growth. The levels drop rapidly when leaves dry. Herbicides bleach leaves and cause a reduction in the concentration of miserotoxin. Tests with fertilizer on range plants showed that use of urea (nitrogen at 200 kg/ha)

increased the level of miserotoxin during the second year of fertilizer use on a clearcut site. Use of urea (nitrogen at 100 kg/ha) on grassland sites did not affect miserotoxin levels (Cheeke and Schull 1985; Majak and Wikeem 1986).

Toxic parts:

leaves
stems

References:

Cheeke, P. R., Shull, L. R. 1985. Natural toxicants in feeds and poisonous plants. AVI Publishing Company, Inc., Westport, Conn., USA. 492 pp.

Quinton, D. A., Majak, W., Hall, J. W. 1989. The effect of cattle grazing on the growth and miserotoxin content of Columbia milkvetch. *J. Range Manage.*, 42: 368-371.

Notes on Toxic plant chemicals:

The glycoside (3-nitro-1-propyl-beta-D-glucopyranoside), called miserotoxin, is the poisonous principle in timber milk-vetch. Other toxic chemicals have been found including the following:

3-nitro-1-propyl-beta-D-gentiobioside (called gentitoxin)
3-nitropropyl-beta-D-allolactoside.

Miserotoxin is rapidly hydrolysed by rumen organisms. The acute toxic effect is related to methemoglobinemia, where hemoglobin is oxidized by nitrite (Cheeke and Schull 1985, Majak et al. 1988).

Miserotoxin is not converted to NPA (3-nitro-1-propionic acid) in the digestive tract of nonruminants. Cattle and sheep can be intoxicated by feeding the chemical NPOH (3-nitro-1-propanal) at 20-60 mg/kg of body weight. NPOH is lethal at 30-35 mg/kg in cattle when fed intravenously:

LD-50 » 77 mg/kg for oral acute toxicity in rats
LD-50 » 25 mg/kg for chronic toxicity in rats fed twice daily for several days.

The acute and chronic syndromes were caused experimentally in rats, pigs, chicks, pigeons, rabbits, and mice (Majak and Pass 1989).

Toxic plant chemicals:

miserotoxin

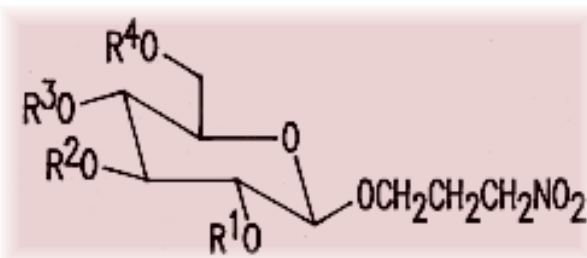

3-nitropropanol

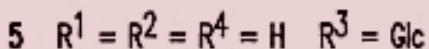
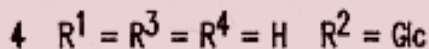
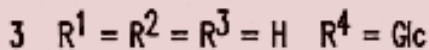
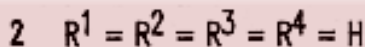

Chemical diagram(s) are courtesy of [Ruth McDiarmid](#), Biochemistry Technician, Kamloops Range Station, Agriculture and Agri-Food Canada, Kamloops, British Columbia, Canada.

References:

Cheeke, P. R., Shull, L. R. 1985. Natural toxicants in feeds and poisonous plants. AVI Publishing Company, Inc., Westport, Conn., USA. 492 pp.

James, L. F., Hartley, W. J., Van Kampen, K. R. 1981. Syndromes of *Astragalus* poisoning in livestock. J. Am. Vet. Med. Assoc., 178: 146-150.

Majak, W., Benn, M. H., Huang, Y. Y. 1988. A new glycoside of 3-nitropropanol from *Astragalus miser* var. *serotinus*. J. Nat. Prod. (Lloydia), 51: 985-988.

Majak, W., Pass, M. A. 1989. Aliphatic nitrocompounds. Pages 143-159 in Cheeke, P. R., ed. Toxicants of plant origin. Vol. II Glycosides. CRC Press, Inc., Boca Raton, Fla., USA. 277 pp.

Quinton, D. A., Majak, W., Hall, J. W. 1989. The effect of cattle grazing on the growth and miserotoxin content of Columbia milkvetch. J. Range Manage., 42: 368-371.

Animals/Human Poisoning:

Note: When an animal is listed without additional information, the literature (as of 1993) contained no detailed explanation.

Cattle

General symptoms of poisoning:

[breathing, labored](#)

[collapse](#)

[cyanosis](#)

[death](#)

[emphysema](#)

[incoordination](#)

[liver, congestion of
muscle, weakness of
weakness](#)

Notes on poisoning:

Cattle that have ingested timber milk-vetch can suffer from acute syndrome, in which a rapid onset with death occurs a few hours to a day after ingestion. Chronically affected animals have liver damage, emphysema, Wallerian degeneration of the spinal cord and peripheral nerves, and focal hemorrhages in the brain. Lactating animals are most susceptible to the toxin (Majak and Pass 1989).

References:

James, L. F., Hartley, W. J., Van Kampen, K. R. 1981. Syndromes of *Astragalus* poisoning in livestock. J. Am. Vet. Med. Assoc., 178: 146-150.

Majak, W., Pass, M. A. 1989. Aliphatic nitrocompounds. Pages 143-159 in Cheeke, P. R., ed. Toxicants of plant origin. Vol. II Glycosides. CRC Press, Inc., Boca Raton, Fla., USA. 277 pp.

Honey bees

General symptoms of poisoning:

[death](#)

[incoordination](#)

[weakness](#)

Notes on poisoning:

Honey bees were poisoned after ingesting the nectar of timber milk-vetch. Sickness and death occur with 0.1-0.8% daily mortality rate of the hive population. In experiments, 2.5% miserotoxin in a 50% sugar solution killed 100% of bees within 48 h. Poisoned bees were unable to fly, and dead bees were usually seen with the wings extended and the proboscis protruding (Majak et al. 1980).

References:

Majak, W., Neufeld, R., Corner, J. 1980. Toxicity of *Astragalus*

miser v. serotinus to the honeybee. J. Apic. Res., 19: 196-199.

Majak, W., Pass, M. A. 1989. Aliphatic nitrocompounds. Pages 143-159 in Cheeke, P. R., ed. Toxicants of plant origin. Vol. II Glycosides. CRC Press, Inc., Boca Raton, Fla., USA. 277 pp.

Horses

Sheep

General symptoms of poisoning:

[breathing, labored](#)

[cyanosis](#)

[death](#)

[incoordination](#)

Notes on poisoning:

Sheep often collapse and die from acute miserotoxin poisoning after exhibiting few clinical signs. In sheep the respiratory signs of chronic poisoning are more prominent than the nervous system signs. The animals lose weight and develop respiratory distress, hind limb paresis, nasal discharge, and a roaring sound. Lactating sheep are more susceptible to intoxication than nonlactating ones (Majak and Pass 1989).

References:

James, L. F., Hartley, W. J., Van Kampen, K. R. 1981. Syndromes of *Astragalus* poisoning in livestock. J. Am. Vet. Med. Assoc., 178: 146-150.

Majak, W., Pass, M. A. 1989. Aliphatic nitrocompounds. Pages 143-159 in Cheeke, P. R., ed. Toxicants of plant origin. Vol. II Glycosides. CRC Press, Inc., Boca Raton, Fla., USA. 277 pp.

[Another search?](#)

[Français](#) | [Contact Us](#) | [Help](#) | [Search](#) | [Canada site](#)

[Coming Events](#) | [About CBIF](#) | [Links](#) | [Reports and Publications](#) |

[Home](#)

Date modified: 2003-02-06

[Important Notices](#)



Français	Contact us	Help	Search	Canada site
Coming events	About CBIF	Links	Reports and publications	Home

Canadian Biodiversity Information Facility



Notes on poisoning: tobacco

[Introduction](#)

[Interactive](#)

[All poisonous plants by Botanical name](#)

[All poisonous plants by Common name](#)

[Important WWW Poisonous Plants sites](#)



General poisoning notes:

Tobacco (*Nicotiana tabacum*) is cultivated in some areas of Canada as a commercial crop for the tobacco industry.

Teratogenic problems have occurred in the United States when pregnant swine were allowed to forage on tobacco stalks. The sows showed no toxic signs. Pregnant swine should be denied access to tobacco plants. Rare cases of human dermatitis from contact with tobacco leaves have been reported (Bush and Crowe 1989, Gonçalo et al. 1990).

References:

Bush, L. P., Crowe, M. W. 1989. *Nicotiana* alkaloids. Pages 87-107 in Cheeke, P. R., ed. Toxicants of plant origin. Vol. I. Alkaloids. CRC Press, Inc., Boca Raton, Fla., USA. 335 pp.

Crowe, M. W., Swerczek, T. W. 1974. Congenital arthrogryposis in offspring of sows fed tobacco (*Nicotiana tabacum*). *Am. J. Vet. Res.*, 35: 1071-1073.

Crowe, M. W. 1969. Skeletal anomalies in pigs associated with tobacco. *Mod. Vet. Pract.*, 50-13: 54-55.

Gonçalo, M., Couto, J., Gonçalo, S. 1990. Allergic contact dermatitis from *Nicotiana tabacum*. *Contact Dermatitis*, 22: 188-189.

Nomenclature:

Scientific Name: *Nicotiana tabacum* L.

Vernacular name(s): tobacco

Scientific family name: *Solanaceae*

Vernacular family name: nightshade

Go to ITIS^{*ca} for more taxonomic information on: [Nicotiana tabacum](#)

References:

Agriculture Quebec. 1975. Noms des maladies des plantes du Canada/ Names of plant diseases in Canada. , Quebec City, Que., Canada. 288 pp.

Alex, J. F., Cayouette, R., Mulligan, G. A. 1980. Common and botanical names of weeds in Canada/Noms populaire et scientifiques des plantes nuisibles du Canada. Revised. Agric. Can. Publ., Ottawa, Ont., Canada. 132 pp.

Bailey, L. H., Bailey, E. Z. 1976. Hortus third. Revised. MacMillan, New York, N.Y., USA. 1290 pp.

Scoggan, H. J. 1978, 1979. The flora of Canada. Nat. Mus. Nat. Sci. (Ottawa) Publ. Bot. 7(1)-7(4). 1711 pp.

Van Wijk, H. L. 1911. A dictionary of plant names. Martinus Nijhoff, The Hague, The Netherlands. 1444 pp.

Victorin, M. 1964. Flore Laurentienne. 2nd ed. Univ. Montreal, Montreal, Que., Canada. 952 pp.

Geographic Information

Plant or plant parts used in or around the home.

References:

Bailey, L. H., Bailey, E. Z. 1976. Hortus third. Revised. MacMillan, New York, N.Y., USA. 1290 pp.

Boivin, B. 1966, 1967. Énumération des plantes du Canada. Provencheria 6. Nat. Can. (Que.) 93: 253-274; 371-437; 583-646; 989-1063. 94: 131-157; 471-528; 625-655.

Image or illustration

tobacco:

Images: images.google.com

Notes on Poisonous plant parts:

The left-over stalks of tobacco plants that remain in the field have caused teratogenic problems. Problems are related to high-yield tobacco crops where heavy fertilization produces yields of dry leaf that exceed 1300 kg/0.40 ha. Experimental feeding of

aqueous filtrate of the leaves and juice of tobacco stalks has also caused teratogenic problems in swine (Crowe and Swerczek 1974).

Toxic parts:

leaves
stems

References:

Crowe, M. W., Swerczek, T. W. 1974. Congenital arthrogryposis in offspring of sows fed tobacco (*Nicotiana tabacum*). Am. J. Vet. Res., 35: 1071-1073.

Notes on Toxic plant chemicals:

Pyridine alkaloids such as anabasine, anatabine, and perhaps anabasine, are responsible for teratogenic problems in swine. Anabasine is the major alkaloid of related *Nicotiana glauca*, in the southern United States, and it has caused teratogenic problems in calves, sheep, and swine. However, anabasine is found in much smaller quantities in tobacco. Anatabine and perhaps anabaseine are therefore believed to be involved in the teratogenic effects on swine (Bush and Crowe 1989).

Toxic plant chemicals:

anabasine
anatabine

References:

Bush, L. P., Crowe, M. W. 1989. *Nicotiana* alkaloids. Pages 87-107 in Cheeke, P. R., ed. Toxicants of plant origin. Vol. I. Alkaloids. CRC Press, Inc., Boca Raton, Fla., USA. 335 pp.

Animals/Human Poisoning:

Note: When an animal is listed without additional information, the literature (as of 1993) contained no detailed explanation.

Humans

General symptoms of poisoning:

[eczema](#)

References:

Gonçalo, M., Couto, J., Gonçalo, S. 1990. Allergic contact dermatitis from *Nicotiana tabacum*. Contact Dermatitis, 22: 188-189.

Swine

General symptoms of poisoning:

[arthrogryposis](#)

Notes on poisoning:

Pregnant sows that ingested tobacco stalks between day 10 and day 50 of gestation developed arthrogryposis, often involving all limbs of the pigs. Occasionally, vertebral column arching has occurred (Crowe 1969, Crowe and Swerczek 1974, Bush and Crowe 1989).

References:

Crowe, M. W., Swerczek, T. W. 1974. Congenital arthrogryposis in offspring of sows fed tobacco (*Nicotiana tabacum*). Am. J. Vet. Res., 35: 1071-1073.

[Another search?](#)

[Français](#) | [Contact Us](#) | [Help](#) | [Search](#) | [Canada site](#)

[Coming Events](#) | [About CBIF](#) | [Links](#) | [Reports and Publications](#) |

[Home](#)

Date modified: 2003-02-06

[Important Notices](#)



Français	Contact us	Help	Search	Canada site
Coming events	About CBIF	Links	Reports and publications	Home

Canadian Biodiversity Information Facility



Notes on poisoning: tree-of-heaven

[Introduction](#)

[Interactive](#)

[All poisonous plants by Botanical name](#)

[All poisonous plants by Common name](#)

[Important WWW Poisonous Plants sites](#)



General poisoning notes:

Tree-of-heaven (*Ailanthus altissima*) is an ornamental found in the warmest parts of Canada. Exposure to the leaves may have caused dermatitis in humans and it is suspected of being a poisonous plant as well. However, convincing documentation of poisoning is lacking. The tree has been suspected of causing gastroenteritis. (Muenscher 1975, Mitchell and Rook 1979).

References:

Mitchell, J. C., Rook, A. 1979. Botanical dermatology. Greenglass Ltd, Vancouver, B.C., Canada. 787 pp.

Muenscher, W. C. 1975. Poisonous plants of the United States. Revised. Collier Books, New York, N.Y., USA. 277 pp.

Perkins, K. D., Payne, W. W. 1978. Guide to the poisonous and irritant plants of Florida. Univ. Fla. Agric. Ext. Serv. Circ., 441. 84 pp.

Nomenclature:

Scientific Name: *Ailanthus altissima* (Mill.) Swingle

Vernacular name(s): tree-of-heaven

Scientific family name: *Simaroubaceae*

Vernacular family name: ginkgo

Go to ITIS^{*ca} for more taxonomic information on: [Ailanthus altissima](#)

Vernacular name(s): tree-of-heaven

Scientific family name: *Simaroubaceae*

Vernacular family name: quassia

Go to ITIS^{*ca} for more taxonomic information on: [Ailanthus altissima](#)

References:

Agriculture Quebec. 1975. Noms des maladies des plantes du Canada/ Names of plant diseases in Canada. , Quebec City, Que., Canada. 288 pp.

Alex, J. F., Cayouette, R., Mulligan, G. A. 1980. Common and botanical names of weeds in Canada/Noms populaire et scientifiques des plantes nuisibles du Canada. Revised. Agric. Can. Publ., Ottawa, Ont., Canada. 132 pp.

Bailey, L. H., Bailey, E. Z. 1976. Hortus third. Revised. MacMillan, New York, N.Y., USA. 1290 pp.

Scoggan, H. J. 1978, 1979. The flora of Canada. Nat. Mus. Nat. Sci. (Ottawa) Publ. Bot. 7(1)-7(4). 1711 pp.

Van Wijk, H. L. 1911. A dictionary of plant names. Martinus Nijhoff, The Hague, The Netherlands. 1444 pp.

Victorin, M. 1964. Flore Laurentienne. 2nd ed. Univ. Montreal, Montreal, Que., Canada. 952 pp.

Geographic Information

Plant or plant parts used in or around the home.

References:

Bailey, L. H., Bailey, E. Z. 1976. Hortus third. Revised. MacMillan, New York, N.Y., USA. 1290 pp.

Boivin, B. 1966, 1967. Énumération des plantes du Canada. Provencheria 6. Nat. Can. (Que.) 93: 253-274; 371-437; 583-646; 989-1063. 94: 131-157; 471-528; 625-655.

Image or illustration

tree-of-heaven:

Images: images.google.com

Toxic parts:

flowers

leaves

References:

Muenschler, W. C. 1975. Poisonous plants of the United States. Revised. Collier Books, New York, N.Y., USA. 277 pp.

Animals/Human Poisoning:

Note: When an animal is listed without additional information, the literature (as of 1993) contained no detailed explanation.

Humans

General symptoms of poisoning:

[erythema](#)

References:

Mitchell, J. C., Rook, A. 1979. Botanical dermatology. Greenglass Ltd, Vancouver, B.C., Canada. 787 pp.

[Another search?](#)

[Français](#) | [Contact Us](#) | [Help](#) | [Search](#) | [Canada site](#)

[Coming Events](#) | [About CBIF](#) | [Links](#) | [Reports and Publications](#) | [Home](#)

Date modified: 2003-02-06

[Important Notices](#)



Français	Contact us	Help	Search	Canada site
Coming events	About CBIF	Links	Reports and publications	Home



Notes on poisoning: tulip

[Introduction](#)

[Interactive](#)

[All poisonous plants by Botanical name](#)

[All poisonous plants by Common name](#)

[Important WWW Poisonous Plants sites](#)



General poisoning notes:

Tulip (*Tulipa* spp.), including *Tulipa gesneriana*, is a widely cultivated plant used as a perennial spring flower in Canada. Many species and hybrids as well as numerous cultivars of tulips may be found in Canada. Tulips contain an allergen, tuliposide A, which causes dermatitis in sensitive individuals. Poisoning of humans and dogs has also been reported when tulip bulbs mistaken for onions were ingested. The allergen tuliposide A is also found in the Peruvian lily (*Alstroemeria* spp.), and there is cross-sensitivity to onion and garlic (*Allium* spp.). Tulips are not normally a problem to humans, but sensitive individuals should avoid touching the plants (Mitchell and Rook 1979, Cooper and Johnson 1984).

References:

- Cooper, M. R., Johnson, A. W. 1984. Poisonous plants in Britain and their effects on animals and man. Her Majesty's Stationery Office, London, England. 305 pp.
- Marks, J. G. 1988. Allergic contact dermatitis to *Alstroemeria*. Arch. Dermatol., 124: 914-916.
- Mitchell, J. C., Rook, A. 1979. Botanical dermatology. Greenglass Ltd, Vancouver, B.C., Canada. 787 pp.

Nomenclature:

Scientific Name: *Tulipa gesneriana* L.

Vernacular name(s): tulip

Scientific family name: *Liliaceae*

Vernacular family name: lily

Go to ITIS*^{ca} for more taxonomic information on: [Tulipa gesneriana](#)

References:

Agriculture Quebec. 1975. Noms des maladies des plantes du Canada/ Names of plant diseases in Canada. , Quebec City, Que., Canada. 288 pp.

Alex, J. F., Cayouette, R., Mulligan, G. A. 1980. Common and botanical names of weeds in Canada/Noms populaire et scientifiques des plantes nuisibles du Canada. Revised. Agric. Can. Publ., Ottawa, Ont., Canada. 132 pp.

Bailey, L. H., Bailey, E. Z. 1976. Hortus third. Revised. MacMillan, New York, N.Y., USA. 1290 pp.

Scoggan, H. J. 1978, 1979. The flora of Canada. Nat. Mus. Nat. Sci. (Ottawa) Publ. Bot. 7(1)-7(4). 1711 pp.

Van Wijk, H. L. 1911. A dictionary of plant names. Martinus Nijhoff, The Hague, The Netherlands. 1444 pp.

Victorin, M. 1964. Flore Laurentienne. 2nd ed. Univ. Montreal, Montreal, Que., Canada. 952 pp.

Geographic Information

Plant or plant parts used in or around the home.

References:

Bailey, L. H., Bailey, E. Z. 1976. Hortus third. Revised. MacMillan, New York, N.Y., USA. 1290 pp.

Boivin, B. 1966, 1967. Énumération des plantes du Canada. Provencheria 6. Nat. Can. (Que.) 93: 253-274; 371-437; 583-646; 989-1063. 94: 131-157; 471-528; 625-655.

Image or illustration

tulip:

Images: images.google.com

Notes on Poisonous plant parts:

Tulips contain an allergen that causes dermatitis in sensitive individuals. The allergen concentration is highest in the bulbs, less in the stem and leaves, and least in the flowers. The allergen decreases in the outermost leaves immediately before harvest time. Some cultivars of tulips cause less severe dermatitis than others (Mitchell and Rook 1979).

Toxic parts:

bulb - dust of
bulbs
leaves
stems

References:

Mitchell, J. C., Rook, A. 1979. Botanical dermatology. Greenglass Ltd, Vancouver, B.C., Canada. 787 pp.

Notes on Toxic plant chemicals:

Tuliposide A is the precursor of the sensitizing agent called alpha-methylene-gamma-butyrolactone (tulipalin A), which results from the hydrolysis of tuliposide A and the lactonization of its aglycone. This chemical causes dermatitis in sensitive individuals (Mitchell and Rook 1979).

Toxic plant chemicals:

tuliposide A

References:

Mitchell, J. C., Rook, A. 1979. Botanical dermatology. Greenglass Ltd, Vancouver, B.C., Canada. 787 pp.

Animals/Human Poisoning:

Note: When an animal is listed without additional information, the literature (as of 1993) contained no detailed explanation.

Dogs

Humans

General symptoms of poisoning:

[breathing, labored](#)

[eczema](#)

[erythema](#)

[nausea](#)

[salivation](#)

[sweating](#)

[vomiting](#)

[weakness](#)

Notes on poisoning:

A few cases of poisoning have occurred after tulip bulbs were ingested either to supplement food or when the bulbs were mistaken for onions. Symptoms included nausea, salivation, sweating, difficult breathing, and palpitations. Weakness persisted for days and vomiting occurred (Cooper and Johnson 1984).

References:

Cooper, M. R., Johnson, A. W. 1984. Poisonous plants in Britain and their effects on animals and man. Her Majesty's Stationery Office, London, England. 305 pp.

Mitchell, J. C., Rook, A. 1979. Botanical dermatology. Greenglass Ltd, Vancouver, B.C., Canada. 787 pp.

[Another search?](#)

[Français](#) | [Contact Us](#) | [Help](#) | [Search](#) | [Canada site](#)

[Coming Events](#) | [About CBIF](#) | [Links](#) | [Reports and Publications](#) |

[Home](#)

Date modified: 2003-02-06

[Important Notices](#)



Français	Contact us	Help	Search	Canada site
Coming events	About CBIF	Links	Reports and publications	Home

Canadian Biodiversity Information Facility



Notes on poisoning: two-grooved milk-vetch

[Introduction](#)

[Interactive](#)

[All poisonous plants by Botanical name](#)

[All poisonous plants by Common name](#)

[Important WWW Poisonous Plants sites](#)



General poisoning notes:

Two-grooved milk-vetch (*Astragalus bisulcatus*) is a native plant found on rangelands in western Canada. This plant can accumulate quantities of selenium high enough to cause toxicity in cattle, horses, sheep, and swine. High quantities of selenium cause acute toxicity, with symptoms including staggering, diarrhea, prostration, and abdominal pain. Plants that contain a selenium content of less than 200 ppm cause chronic toxicity. James et al.(1983) used this plant (selenium content of 180 ppm) to conduct feeding experiments on sheep. They found that the symptoms and microscopic lesions of tissues collected from the sheep were similar to those caused by locoweed poisoning and not selenium poisoning. This finding suggests that other toxic compounds in addition to selenium may be present.

Swainsonine is also found in this plant, which may explain why, in experiments, sheep exhibited symptoms more appropriate to locoism than to selenium poisoning (Cheeke and Schull 1985).

References:

Baker, D. C., James, L. F., Panter, K. E., Mayland, H. F., Pfister, J. A. 1987. Selenosis in developing pigs fed selenium from different sources. Am . Soc. Anim. Sci. Abstr., 65: 351.

Cheeke, P. R., Shull, L. R. 1985. Natural toxicants in feeds and poisonous plants. AVI Publishing Company, Inc., Westport, Conn., USA. 492 pp.

James, L. F., Van Kampen, K. V., Hartley, W. J. 1983. *Astragalus bisulcatus*--a cause of selenium or locoweed poisoning? Vet. Hum. Toxicol., 25: 86-89.

Nomenclature:

Scientific Name: *Astragalus bisulcatus* (Hook.) A. Gray

Vernacular name(s): two-grooved milk-vetch

Scientific family name: *Leguminosae*

Vernacular family name: pea

Go to ITIS^{*ca} for more taxonomic information on: [Astragalus bisulcatus](#)

References:

Agriculture Quebec. 1975. Noms des maladies des plantes du Canada/ Names of plant diseases in Canada. , Quebec City, Que., Canada. 288 pp.

Alex, J. F., Cayouette, R., Mulligan, G. A. 1980. Common and botanical names of weeds in Canada/Noms populaire et scientifiques des plantes nuisibles du Canada. Revised. Agric. Can. Publ., Ottawa, Ont., Canada. 132 pp.

Bailey, L. H., Bailey, E. Z. 1976. Hortus third. Revised. MacMillan, New York, N.Y., USA. 1290 pp.

Scoggan, H. J. 1978, 1979. The flora of Canada. Nat. Mus. Nat. Sci. (Ottawa) Publ. Bot. 7(1)-7(4). 1711 pp.

Van Wijk, H. L. 1911. A dictionary of plant names. Martinus Nijhoff, The Hague, The Netherlands. 1444 pp.

Victorin, M. 1964. Flore Laurentienne. 2nd ed. Univ. Montreal, Montreal, Que., Canada. 952 pp.

Geographic Information

Alberta

Manitoba

Saskatchewan

References:

Bailey, L. H., Bailey, E. Z. 1976. Hortus third. Revised. MacMillan, New York, N.Y., USA. 1290 pp.

Boivin, B. 1966, 1967. Énumération des plantes du Canada. Provencheria 6. Nat. Can. (Que.) 93: 253-274; 371-437; 583-646; 989-1063. 94: 131-157; 471-528; 625-655.

Image or illustration

two-grooved milk-vetch:

Images: images.google.com

Toxic parts:

flowers
leaves
stems

References:

James, L. F., Van Kampen, K. V., Hartley, W. J. 1983. *Astragalus bisulcatus*--a cause of selenium or locoweed poisoning? *Vet. Hum. Toxicol.*, 25: 86-89.

Notes on Toxic plant chemicals:

This plant is a recognized selenium accumulator. Selenium has been found to be toxic to sheep and cattle at levels of 4-5 mg/kg of dry matter. Two-grooved milk-vetch collected in Canada contained selenium at 43 mg/kg, well above the level required for toxicity (Davis 1986).

Toxic plant chemicals:

selenium
swainsonine

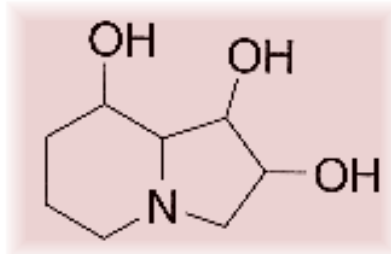

Chemical diagram(s) are courtesy of [Ruth McDiarmid](#), Biochemistry Technician, Kamloops Range Station, Agriculture and Agri-Food Canada, Kamloops, British Columbia, Canada.

References:

Cheeke, P. R., Shull, L. R. 1985. *Natural toxicants in feeds and poisonous plants*. AVI Publishing Company, Inc., Westport, Conn., USA. 492 pp.

Davis, A. M. 1986. Selenium uptake in *Astragalus* and *Lupinus* species. *Agron. J.*, 78: 727-729.

Animals/Human Poisoning:

Note: When an animal is listed without additional information, the literature (as of 1993) contained no detailed explanation.

Cattle

Horses

Sheep

General symptoms of poisoning:

[ascites](#)

[brain, vacuolation of](#)

[coat, rough and dry](#)

[cytoplasm vacuolation](#)

[depression](#)

[fetus, dead](#)

[kidney, vacuolation of](#)

References:

James, L. F., Van Kampen, K. V., Hartley, W. J. 1983.
Astragalus bisulcatus--a cause of selenium or locoweed poisoning? Vet. Hum. Toxicol., 25: 86-89.

Swine

[Another search?](#)

[Français](#) | [Contact Us](#) | [Help](#) | [Search](#) | [Canada site](#)

[Coming Events](#) | [About CBIF](#) | [Links](#) | [Reports and Publications](#) |

[Home](#)

Date modified: 2003-02-06

[Important Notices](#)



Français	Contact us	Help	Search	Canada site
Coming events	About CBIF	Links	Reports and publications	Home

Canadian Biodiversity Information Facility



Notes on poisoning: veined dock

[Introduction](#)

[Interactive](#)

[All poisonous plants by Botanical name](#)

[All poisonous plants by Common name](#)

[Important WWW Poisonous Plants sites](#)



General poisoning notes:

Veined dock (*Rumex venosus*) is a native herb found in the southern part of the Canadian prairies. This plant caused poisoning of cattle in Colorado. Poisoning occurred in early spring when there was little other vegetation. Sickness and death resulted after large amounts of the plants were ingested (Dickie et al. 1978).

References:

Dickie, C. W., Hamann, M. H., Carroll, W. D., Chow, F. 1978. Oxalate (*Rumex venosus*) poisoning in cattle. J. Am. Vet. Med. Assoc., 173: 73-74.

Nomenclature:

Scientific Name: *Rumex venosus* Pursh

Vernacular name(s): veined dock

Scientific family name: *Polygonaceae*

Vernacular family name: buckwheat

Go to ITIS*^{ca} for more taxonomic information on: [Rumex venosus](#)

References:

Agriculture Quebec. 1975. Noms des maladies des plantes du Canada/ Names of plant diseases in Canada. , Quebec City, Que., Canada. 288 pp.

Alex, J. F., Cayouette, R., Mulligan, G. A. 1980. Common and botanical names of weeds in Canada/Noms populaire et scientifiques des plantes nuisibles du Canada. Revised. Agric.

Can. Publ., Ottawa, Ont., Canada. 132 pp.

Bailey, L. H., Bailey, E. Z. 1976. Hortus third. Revised. MacMillan, New York, N.Y., USA. 1290 pp.

Scoggan, H. J. 1978, 1979. The flora of Canada. Nat. Mus. Nat. Sci. (Ottawa) Publ. Bot. 7(1)-7(4). 1711 pp.

Van Wijk, H. L. 1911. A dictionary of plant names. Martinus Nijhoff, The Hague, The Netherlands. 1444 pp.

Victorin, M. 1964. Flore Laurentienne. 2nd ed. Univ. Montreal, Montreal, Que., Canada. 952 pp.

Geographic Information

Alberta

Manitoba

Saskatchewan

References:

Bailey, L. H., Bailey, E. Z. 1976. Hortus third. Revised. MacMillan, New York, N.Y., USA. 1290 pp.

Boivin, B. 1966, 1967. Énumération des plantes du Canada. Provencheria 6. Nat. Can. (Que.) 93: 253-274; 371-437; 583-646; 989-1063. 94: 131-157; 471-528; 625-655.

Image or illustration

veined dock:

Images: images.google.com

Toxic parts:

leaves

stems

References:

Dickie, C. W., Hamann, M. H., Carroll, W. D., Chow, F. 1978. Oxalate (*Rumex venosus*) poisoning in cattle. J. Am. Vet. Med. Assoc., 173: 73-74.

Notes on Toxic plant chemicals:

Oxalate crystals are found in the aboveground parts of the plant. Levels were measured in Colorado, showing oxalates of 9.2% in April and 13.9% in June on a dry-weight basis. If sufficient

quantity of plant material is ingested the oxalates combine with systemic calcium ions to form insoluble calcium oxalate, causing functional hypocalcemia in acute cases (Dickie et al. 1978).

Toxic plant chemicals:

oxalate

References:

Dickie, C. W., Hamann, M. H., Carroll, W. D., Chow, F. 1978. Oxalate (*Rumex venosus*) poisoning in cattle. J. Am. Vet. Med. Assoc., 173: 73-74.

Animals/Human Poisoning:

Note: When an animal is listed without additional information, the literature (as of 1993) contained no detailed explanation.

Cattle

General symptoms of poisoning:

[anorexia](#)
[depression](#)
[kidney, edema of](#)
[lungs, congestion of](#)

Notes on poisoning:

Several cows became ill and died after ingesting veined dock. All the cows were suckling, but none of their calves died. Symptoms included depression and anorexia. Postmortem findings showed ecchymotic and petechial hemorrhaging on the visceral and parietal peritoneum. About 2 L of thin, yellowish fluid was in the abdominal cavity. Mesenteric lymph nodes were enlarged and edematous. Other symptoms included catarrhal abomasitis, enteritis, pale kidneys, and lung congestion (Dickie et al. 1978).

References:

Dickie, C. W., Hamann, M. H., Carroll, W. D., Chow, F. 1978. Oxalate (*Rumex venosus*) poisoning in cattle. J. Am. Vet. Med. Assoc., 173: 73-74.

[Another search?](#)

[Français](#) | [Contact Us](#) | [Help](#) | [Search](#) | [Canada site](#)
[Coming Events](#) | [About CBIF](#) | [Links](#) | [Reports and Publications](#) | [Home](#)

Date modified: 2003-02-06

[Important Notices](#)



Français	Contact us	Help	Search	Canada site
Coming events	About CBIF	Links	Reports and publications	Home

Canadian Biodiversity Information Facility



Notes on poisoning: velvety goldenrod

[Introduction](#)

[Interactive](#)

[All poisonous plants by Botanical name](#)

[All poisonous plants by Common name](#)

[Important WWW Poisonous Plants sites](#)



General poisoning notes:

Velvety goldenrod (*Solidago mollis*) is a native herb found in the southern prairie provinces. This plant was fed experimentally to sheep, killing them. The corrosive resins have caused weight loss in calves, sheep, and small laboratory animals. The toxin has not been determined. In the United States, some other goldenrods (*Solidago* spp.) were shown to be poisonous. The presence of a fungal rust on the plants was implicated in the poisoning (Beath et al. 1953, Kingsbury 1964).

References:

Beath, O. A., Gilbert, C. S., Eppson, H. F., Rosenfeld, I. 1953. Poisonous plants and livestock poisoning. Wyo. Agric. Exp. Stn. Bull., 324. 94 pp.

Kingsbury, J. M. 1964. Poisonous plants of the United States and Canada. Prentice-Hall Inc., Englewood Cliffs, N.J., USA. 626 pp.

Nomenclature:

Scientific Name: *Solidago mollis* Bartl.

Vernacular name(s): velvety goldenrod

Scientific family name: *Compositae*

Vernacular family name: composite

Go to ITIS^{*ca} for more taxonomic information on: [Solidago mollis](#)

References:

Agriculture Quebec. 1975. Noms des maladies des plantes du Canada/ Names of plant diseases in Canada. , Quebec City, Que.,

Canada. 288 pp.

Alex, J. F., Cayouette, R., Mulligan, G. A. 1980. Common and botanical names of weeds in Canada/Noms populaire et scientifiques des plantes nuisibles du Canada. Revised. Agric. Can. Publ., Ottawa, Ont., Canada. 132 pp.

Bailey, L. H., Bailey, E. Z. 1976. Hortus third. Revised. MacMillan, New York, N.Y., USA. 1290 pp.

Scoggan, H. J. 1978, 1979. The flora of Canada. Nat. Mus. Nat. Sci. (Ottawa) Publ. Bot. 7(1)-7(4). 1711 pp.

Van Wijk, H. L. 1911. A dictionary of plant names. Martinus Nijhoff, The Hague, The Netherlands. 1444 pp.

Victorin, M. 1964. Flore Laurentienne. 2nd ed. Univ. Montreal, Montreal, Que., Canada. 952 pp.

Geographic Information

Alberta
Manitoba
Saskatchewan

References:

Bailey, L. H., Bailey, E. Z. 1976. Hortus third. Revised. MacMillan, New York, N.Y., USA. 1290 pp.

Boivin, B. 1966, 1967. Énumération des plantes du Canada. Provencheria 6. Nat. Can. (Que.) 93: 253-274; 371-437; 583-646; 989-1063. 94: 131-157; 471-528; 625-655.

Image or illustration

velvety goldenrod:

Images: images.google.com

Toxic parts:

leaves
stems

References:

Beath, O. A., Gilbert, C. S., Eppson, H. F., Rosenfeld, I. 1953. Poisonous plants and livestock poisoning. Wyo. Agric. Exp. Stn. Bull., 324. 94 pp.

Toxic plant chemicals:

unknown chemical

References:

Beath, O. A., Gilbert, C. S., Eppson, H. F., Rosenfeld, I. 1953. Poisonous plants and livestock poisoning. Wyo. Agric. Exp. Stn. Bull., 324. 94 pp.

Animals/Human Poisoning:

Note: When an animal is listed without additional information, the literature (as of 1993) contained no detailed explanation.

Cattle

General symptoms of poisoning:

[weight loss](#)

Notes on poisoning:

Administering small amounts of the resin to calves caused a loss of body weight. The same resin given to small laboratory animals caused severe weight loss (Beath et al. 1953).

References:

Beath, O. A., Gilbert, C. S., Eppson, H. F., Rosenfeld, I. 1953. Poisonous plants and livestock poisoning. Wyo. Agric. Exp. Stn. Bull., 324. 94 pp.

Sheep

General symptoms of poisoning:

[breathing, rapid](#)

[death](#)

[nausea](#)

[vomiting](#)

Notes on poisoning:

Doses of 0.45 kg of partly dried plant material given 4 h apart caused death in 12 h. Symptoms included nausea, vomiting, distress, and accelerated respiration. Small amounts of the corrosive resin caused a loss of body weight (Beath et al. 1953).

References:

Beath, O. A., Gilbert, C. S., Eppson, H. F., Rosenfeld, I. 1953.
Poisonous plants and livestock poisoning. Wyo. Agric. Exp. Stn.
Bull., 324. 94 pp.

[Another search?](#)

[Français](#) | [Contact Us](#) | [Help](#) | [Search](#) | [Canada site](#)

[Coming Events](#) | [About CBIF](#) | [Links](#) | [Reports and Publications](#) |

[Home](#)

Date modified: 2003-02-06

[Important Notices](#)



Français	Contact us	Help	Search	Canada site
Coming events	About CBIF	Links	Reports and publications	Home

Canadian Biodiversity Information Facility



Notes on poisoning: Virginia creeper

[Introduction](#)[Interactive](#)[All poisonous plants by Botanical name](#)[All poisonous plants by Common name](#)[Important WWW Poisonous Plants sites](#)

General poisoning notes:

Virginia creeper (*Parthenocissus quinquefolia*) is a native climbing vine found in eastern Canada. It is also used as an ornamental climber on trellises and building walls. Children who ingested berries and leaves have reportedly been poisoned and have died. Some authors view these reports as circumstantial. However, this plant should be considered as potentially toxic if ingested (Warren 1912, Kingsbury 1964, Fuller and McClintock 1986).

References:

- Fuller, T. C., McClintock, E. 1986. Poisonous plants of California. Univ. California Press, Berkeley, Calif., USA. 432 pp.
- Kingsbury, J. M. 1964. Poisonous plants of the United States and Canada. Prentice-Hall Inc., Englewood Cliffs, N.J., USA. 626 pp.
- Warren, L. E. 1912. A note on the poisonous properties of *Parthenocissus quinquefolia*. Merck's Rep., 21: 123.

Nomenclature:

Scientific Name: *Parthenocissus quinquefolia* (L.) Planch.

Vernacular name(s): Virginia creeper

Scientific family name: *Vitaceae*

Vernacular family name: grape

Go to ITIS*^{ca} for more taxonomic information on:
[Parthenocissus quinquefolia](#)

References:

Agriculture Quebec. 1975. Noms des maladies des plantes du Canada/ Names of plant diseases in Canada. , Quebec City, Que., Canada. 288 pp.

Alex, J. F., Cayouette, R., Mulligan, G. A. 1980. Common and botanical names of weeds in Canada/Noms populaire et scientifiques des plantes nuisibles du Canada. Revised. Agric. Can. Publ., Ottawa, Ont., Canada. 132 pp.

Bailey, L. H., Bailey, E. Z. 1976. Hortus third. Revised. MacMillan, New York, N.Y., USA. 1290 pp.

Scoggan, H. J. 1978, 1979. The flora of Canada. Nat. Mus. Nat. Sci. (Ottawa) Publ. Bot. 7(1)-7(4). 1711 pp.

Van Wijk, H. L. 1911. A dictionary of plant names. Martinus Nijhoff, The Hague, The Netherlands. 1444 pp.

Victorin, M. 1964. Flore Laurentienne. 2nd ed. Univ. Montreal, Montreal, Que., Canada. 952 pp.

Geographic Information

Ontario

Prince Edward Island

Quebec

References:

Bailey, L. H., Bailey, E. Z. 1976. Hortus third. Revised. MacMillan, New York, N.Y., USA. 1290 pp.

Boivin, B. 1966, 1967. Énumération des plantes du Canada. Provencheria 6. Nat. Can. (Que.) 93: 253-274; 371-437; 583-646; 989-1063. 94: 131-157; 471-528; 625-655.

Image or illustration

Virginia creeper:

Images: images.google.com

Toxic parts:

leaves

mature fruit

References:

Warren, L. E. 1912. A note on the poisonous properties of

Parthenocissus quinquefolia. Merck's Rep., 21: 123.

Notes on Toxic plant chemicals:

Raphide crystals of calcium oxalate have been reported in the leaves and berries of Virginia creeper. Fuller and McClintock (1986) stated that the quantities are small and that the irritant effect is usually not significant.

Toxic plant chemicals:

oxalate

References:

Fuller, T. C., McClintock, E. 1986. Poisonous plants of California. Univ. California Press, Berkeley, Calif., USA. 432 pp.

Warren, L. E. 1912. A note on the poisonous properties of *Parthenocissus quinquefolia*. Merck's Rep., 21: 123.

Animals/Human Poisoning:

Note: When an animal is listed without additional information, the literature (as of 1993) contained no detailed explanation.

Humans

General symptoms of poisoning:

[death](#)

[tenesmus](#)

[vomiting](#)

Notes on poisoning:

Cases have been reported of illness and death resulting after berries of Virginia creeper were ingested. In another case, two children became ill after swallowing the juice from chewed leaves. Symptoms included vomiting, purging, and tenesmus. The children collapsed and were in stupor for 2 h. A dozen ripe berries were fed to a guinea pig, which died within 36 h (Warren 1912). Modern reports view these cases as circumstantial. The amounts of oxalate contained in the plant is usually not significant (Kingsbury 1964, Fuller and McClintock 1986).

References:

Fuller, T. C., McClintock, E. 1986. Poisonous plants of

California. Univ. California Press, Berkeley, Calif., USA. 432 pp.

Kingsbury, J. M. 1964. Poisonous plants of the United States and Canada. Prentice-Hall Inc., Englewood Cliffs, N.J., USA. 626 pp.

Warren, L. E. 1912. A note on the poisonous properties of *Parthenocissus quinquefolia*. Merck's Rep., 21: 123.

[Another search?](#)

[Français](#) | [Contact Us](#) | [Help](#) | [Search](#) | [Canada site](#)

[Coming Events](#) | [About CBIF](#) | [Links](#) | [Reports and Publications](#) |

[Home](#)

Date modified: 2003-02-06

[Important Notices](#)



Français	Contact us	Help	Search	Canada site
Coming events	About CBIF	Links	Reports and publications	Home

Canadian Biodiversity Information Facility



Notes on poisoning: western bleedingheart

[Introduction](#)

[Interactive](#)

[All poisonous plants by Botanical name](#)

[All poisonous plants by Common name](#)

[Important WWW Poisonous Plants sites](#)



General poisoning notes:

Western bleedingheart (*Dicentra formosa*) is a native herb found in the rich forests of southwestern British Columbia. The plant contains the toxic alkaloid protopine and other alkaloids. This chemical is also found in the other *Dicentra* species. Experimental injection of plant extracts has caused poisoning and death in mice (Black et al. 1930).

References:

Black, O. F., Eggleston, W. W., Kelly, J. W. 1930. Toxicity of *Bikukulla formosa* (western bleedingheart). *Vet. J.*, 40: 917-920.

Nomenclature:

Scientific Name: *Dicentra formosa* (Andr.) Walp.

Vernacular name(s): western bleedingheart

Scientific family name: *Fumariaceae*

Vernacular family name: frumitory

Go to ITIS^{*ca} for more taxonomic information on: [Dicentra formosa](#)

References:

Agriculture Quebec. 1975. Noms des maladies des plantes du Canada/ Names of plant diseases in Canada. , Quebec City, Que., Canada. 288 pp.

Alex, J. F., Cayouette, R., Mulligan, G. A. 1980. Common and botanical names of weeds in Canada/Noms populaire et scientifiques des plantes nuisibles du Canada. Revised. Agric. Can. Publ., Ottawa, Ont., Canada. 132 pp.

Bailey, L. H., Bailey, E. Z. 1976. Hortus third. Revised. MacMillan, New York, N.Y., USA. 1290 pp.

Scoggan, H. J. 1978, 1979. The flora of Canada. Nat. Mus. Nat. Sci. (Ottawa) Publ. Bot. 7(1)-7(4). 1711 pp.

Van Wijk, H. L. 1911. A dictionary of plant names. Martinus Nijhoff, The Hague, The Netherlands. 1444 pp.

Victorin, M. 1964. Flore Laurentienne. 2nd ed. Univ. Montreal, Montreal, Que., Canada. 952 pp.

Geographic Information

British Columbia

References:

Bailey, L. H., Bailey, E. Z. 1976. Hortus third. Revised. MacMillan, New York, N.Y., USA. 1290 pp.

Boivin, B. 1966, 1967. Énumération des plantes du Canada. Provencheria 6. Nat. Can. (Que.) 93: 253-274; 371-437; 583-646; 989-1063. 94: 131-157; 471-528; 625-655.

Image or illustration

western bleedingheart:

Images: images.google.com

Toxic parts:

leaves

References:

Black, O. F., Eggleston, W. W., Kelly, J. W. 1930. Toxicity of *Bikukulla formosa* (western bleedingheart). Vet. J., 40: 917-920.

Toxic plant chemicals:

protopine

References:

Black, O. F., Eggleston, W. W., Kelly, J. W. 1930. Toxicity of *Bikukulla formosa* (western bleedingheart). Vet. J., 40: 917-920.

Animals/Human Poisoning:

Note: When an animal is listed without additional information, the literature (as of 1993) contained no detailed explanation.

Cattle

Rodents

General symptoms of poisoning:

[convulsions](#)

[death](#)

[drowsiness](#)

Notes on poisoning:

Postmortem examination of mice showed collapsed lungs, blue extremities, and a distended heart. Death was likely due to respiratory paralysis. The lethal dose from the crude alkaloids was determined to be between 2.5 and 5.0 mg for a 20-g mouse (Black et al. 1930).

References:

Black, O. F., Eggleston, W. W., Kelly, J. W. 1930. Toxicity of *Bikukulla formosa* (western bleedingheart). Vet. J., 40: 917-920.

[Another search?](#)

[Français](#) | [Contact Us](#) | [Help](#) | [Search](#) | [Canada site](#)

[Coming Events](#) | [About CBIF](#) | [Links](#) | [Reports and Publications](#) |

[Home](#)

Date modified: 2003-02-06

[Important Notices](#)



Français	Contact us	Help	Search	Canada site
Coming events	About CBIF	Links	Reports and publications	Home

Canadian Biodiversity Information Facility



Notes on poisoning: western minniebush

[Introduction](#)[Interactive](#)[All poisonous plants by Botanical name](#)[All poisonous plants by Common name](#)[Important WWW Poisonous Plants sites](#)

General poisoning notes:

Western minniebush (*Menziesia ferruginea*) is a native shrub found in western Canada. This plant has occasionally been implicated in cases of sheep poisoning. Feeding experiments have shown that it does cause poisoning in sheep. It is considered less toxic than some other members of the heath family, such as *Kalmia* spp. and *Rhododendron* spp. (Marsh 1914, Kingsbury 1964).

References:



Kingsbury, J. M. 1964. Poisonous plants of the United States and Canada. Prentice-Hall Inc., Englewood Cliffs, N.J., USA. 626 pp.

Marsh, C. D. 1914. *Menziesia*, a new stock-poisoning plant of the northwestern states. U.S. Dep. Agric. Bur. Plant Ind., 16. 3 pp.

Nomenclature:

Scientific Name: *Menziesia ferruginea* Sm.

Vernacular name(s): western minniebush

Scientific family name: *Ericaceae*

Vernacular family name: heath

Go to ITIS*^{ca} for more taxonomic information on: [Menziesia ferruginea](#)

References:

Agriculture Quebec. 1975. Noms des maladies des plantes du Canada/ Names of plant diseases in Canada. , Quebec City, Que., Canada. 288 pp.

Alex, J. F., Cayouette, R., Mulligan, G. A. 1980. Common and botanical names of weeds in Canada/Noms populaire et scientifiques des plantes nuisibles du Canada. Revised. Agric. Can. Publ., Ottawa, Ont., Canada.

132 pp.

Bailey, L. H., Bailey, E. Z. 1976. Hortus third. Revised. MacMillan, New York, N.Y., USA. 1290 pp.

Scoggan, H. J. 1978, 1979. The flora of Canada. Nat. Mus. Nat. Sci. (Ottawa) Publ. Bot. 7(1)-7(4). 1711 pp.

Van Wijk, H. L. 1911. A dictionary of plant names. Martinus Nijhoff, The Hague, The Netherlands. 1444 pp.

Victorin, M. 1964. Flore Laurentienne. 2nd ed. Univ. Montreal, Montreal, Que., Canada. 952 pp.

Geographic Information

Alberta
British Columbia

References:

Bailey, L. H., Bailey, E. Z. 1976. Hortus third. Revised. MacMillan, New York, N.Y., USA. 1290 pp.

Boivin, B. 1966, 1967. Énumération des plantes du Canada. Provencheria 6. Nat. Can. (Que.) 93: 253-274; 371-437; 583-646; 989-1063. 94: 131-157; 471-528; 625-655.

Image or illustration

western minniebush:

Images: images.google.com

Toxic parts:

leaves

References:

Fuller, T. C., McClintock, E. 1986. Poisonous plants of California. Univ. California Press, Berkeley, Calif., USA. 432 pp.

Marsh, C. D. 1914. *Menziesia*, a new stock-poisoning plant of the northwestern states. U.S. Dep. Agric. Bur. Plant Ind., 16. 3 pp.

Notes on Toxic plant chemicals:

Andromedotoxins (grayanotoxins) are diterpenoid alkaloids. These toxins are common to all poisonous members of the heath family (including *Kalmia* spp. and *Rhododendron* spp.).

Toxic plant chemicals:

andromedotoxins

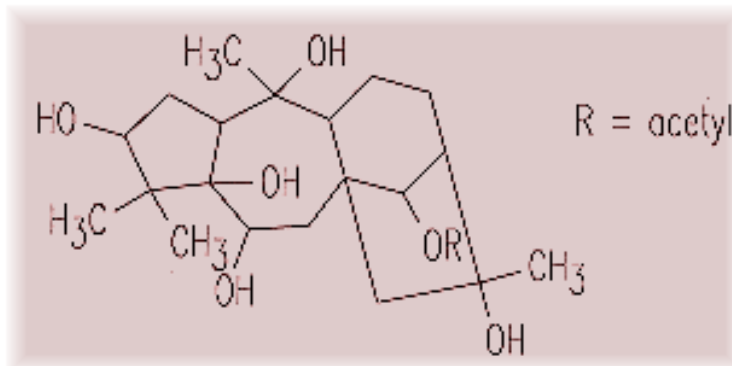

Chemical diagram(s) are courtesy of [Ruth McDiarmid](#), Biochemistry Technician, Kamloops Range Station, Agriculture and Agri-Food Canada, Kamloops, British Columbia, Canada.

References:

Fuller, T. C., McClintock, E. 1986. Poisonous plants of California. Univ. California Press, Berkeley, Calif., USA. 432 pp.

Animals/Human Poisoning:

Note: When an animal is listed without additional information, the literature (as of 1993) contained no detailed explanation.

Sheep

General symptoms of poisoning:

[breathing, labored](#)

[gait, staggering](#)

[mouth, frothing of](#)

[nausea](#)

[paralysis](#)

[salivation](#)

[weakness](#)

References:

Marsh, C. D. 1914. *Menziesia*, a new stock-poisoning plant of the northwestern states. U.S. Dep. Agric. Bur. Plant Ind., 16. 3 pp.

[Another search?](#)

[Français](#) | [Contact Us](#) | [Help](#) | [Search](#) | [Canada site](#)

[Coming Events](#) | [About CBIF](#) | [Links](#) | [Reports and Publications](#) | [Home](#)

Date modified: 2003-02-06

[Important Notices](#)



Français	Contact us	Help	Search	Canada site
Coming events	About CBIF	Links	Reports and publications	Home

Canadian Biodiversity Information Facility



Notes on poisoning: western poison-oak

[Introduction](#)

[Interactive](#)

[All poisonous plants by Botanical name](#)

[All poisonous plants by Common name](#)

[Important WWW Poisonous Plants sites](#)



General poisoning notes:

Western poison-oak (*Rhus diversiloba*; synonym *Toxicodendron diversiloba*) is a native shrub found in southwestern British Columbia. This plant contains urushiol, which is highly sensitizing in humans. Reactions can range from mild redness to large areas of oozing lesions and fever (Mulligan 1990, Gayer and Burnett 1988). For more information please see the bulletin "[Poison Ivy, Western Poison Oak, Poison Sumac](#)"

References:

Epstein, W. L., Byers, V. S. 1981. Poison oak and poison ivy dermatitis. Prevention and treatment in forest service work. U.S. Dep. Agric. For. Serv. Rep., 14 pp.

Gayer, K. D., Burnett, J. W. 1988. *Toxicodendron* dermatitis. *Cutis*, 42: 99-100.

Mulligan, G. A. 1990. [Poison ivy. Western poison oak. Poison sumac](#). Agric. Can. Publ., 1699. 13 pp.

Nomenclature:

Scientific Name: *Rhus diversiloba* T. & G.

Vernacular name(s): western poison-oak

Scientific family name: *Anacardiaceae*

Vernacular family name: cashew

Go to ITIS^{*ca} for more taxonomic information on: [Rhus diversiloba](#)

References:

Agriculture Quebec. 1975. Noms des maladies des plantes du Canada/ Names of plant diseases in Canada. , Quebec City, Que., Canada. 288 pp.

Alex, J. F., Cayouette, R., Mulligan, G. A. 1980. Common and botanical names of weeds in Canada/Noms populaire et scientifiques des plantes nuisibles du Canada. Revised. Agric. Can. Publ., Ottawa, Ont., Canada. 132 pp.

Bailey, L. H., Bailey, E. Z. 1976. Hortus third. Revised. MacMillan, New York, N.Y., USA. 1290 pp.

Scoggan, H. J. 1978, 1979. The flora of Canada. Nat. Mus. Nat. Sci. (Ottawa) Publ. Bot. 7(1)-7(4). 1711 pp.

Van Wijk, H. L. 1911. A dictionary of plant names. Martinus Nijhoff, The Hague, The Netherlands. 1444 pp.

Victorin, M. 1964. Flore Laurentienne. 2nd ed. Univ. Montreal, Montreal, Que., Canada. 952 pp.

Geographic Information

British Columbia

References:

Bailey, L. H., Bailey, E. Z. 1976. Hortus third. Revised. MacMillan, New York, N.Y., USA. 1290 pp.

Boivin, B. 1966, 1967. Énumération des plantes du Canada. Provencheria 6. Nat. Can. (Que.) 93: 253-274; 371-437; 583-646; 989-1063. 94: 131-157; 471-528; 625-655.

Image or illustration

western poison-oak:

Images: images.google.com

Notes on Poisonous plant parts:

All parts of the plant, with the exception of the pollen, anthers, xylem, and epidermis, contain the allergen urushiol. Even in winter, sap from damaged stems causes allergic reactions. Similarly, damage to the root results in dermatitis (Mulligan 1990, Gayer and Burnett 1988).

Toxic parts:

all parts
flowers
immature fruit
leaves
mature fruit
plant juices
stems

References:

Epstein, W. L., Byers, V. S. 1981. Poison oak and poison ivy dermatitis. Prevention and treatment in forest service work. U.S. Dep. Agric. For. Serv. Rep., 14 pp.

Gayer, K. D., Burnett, J. W. 1988. *Toxicodendron* dermatitis. *Cutis*, 42: 99-100.

Mulligan, G. A. 1990. [Poison ivy. Western poison oak. Poison sumac.](#) Agric. Can. Publ., 1699. 13 pp.

Notes on Toxic plant chemicals:

Urushiol, a nonvolatile phenolic allergen, includes alkylcatechols, found in all toxic *Rhus* species. Urushiol is found in the resin canals that occur throughout the plants. The toxin is exposed after damage to the plant (Gayer and Burnett 1988).

Toxic plant chemicals:

urushiol oil

References:

Epstein, W. L., Byers, V. S. 1981. Poison oak and poison ivy dermatitis. Prevention and treatment in forest service work. U.S. Dep. Agric. For. Serv. Rep., 14 pp.

Gayer, K. D., Burnett, J. W. 1988. *Toxicodendron* dermatitis. *Cutis*, 42: 99-100.

Schmidt, R. J., Khan, L., Chung, L. Y. 1990. Are free radicals and not quinones the haptenic species derived from urushiols and other contact allergenic mono- and dihydride alkylbenzenes? *Dermatol. Res.*, 282: 56-64.

Animals/Human Poisoning:

Note: When an animal is listed without additional information,

the literature (as of 1993) contained no detailed explanation.

Humans

General symptoms of poisoning:

[blistering](#)

[blisters, weeping](#)

[itchiness](#)

[temperature, elevated](#)

References:

Epstein, W. L., Byers, V. S. 1981. Poison oak and poison ivy dermatitis. Prevention and treatment in forest service work. U.S. Dep. Agric. For. Serv. Rep., 14 pp.

Mulligan, G. A. 1990. [Poison ivy. Western poison oak. Poison sumac](#). Agric. Can. Publ., 1699. 13 pp.

[Another search?](#)

[Français](#) | [Contact Us](#) | [Help](#) | [Search](#) | [Canada site](#)

[Coming Events](#) | [About CBIF](#) | [Links](#) | [Reports and Publications](#) |

[Home](#)

Date modified: 2003-02-06

[Important Notices](#)



Français	Contact us	Help	Search	Canada site
Coming events	About CBIF	Links	Reports and publications	Home

Canadian Biodiversity Information Facility



Notes on poisoning: western water-hemlock

[Introduction](#)[Interactive](#)[All poisonous plants by Botanical name](#)[All poisonous plants by Common name](#)[Important WWW Poisonous Plants sites](#)

General poisoning notes:

Western water-hemlock (*Cicuta douglasii*) is a native perennial plant found in wet soils in British Columbia. This plant is poisonous to all types of livestock and to humans. Many cases of poisoning have occurred in cattle, sheep, and horses. Pigs seem more resistant to the toxins, but they have still been poisoned. Humans have also been poisoned by this plant. Children are especially susceptible because ingestion of only one bite of the rootstock is sufficient to cause death. The onset of symptoms is so rapid that treatment may not be successful (Starrveld and Hope 1975, James and Ralphs 1986). See additional information in the general notes under [Cicuta maculata](#).

References:

James, L. F., Ralphs, M. H. 1986. Water hemlock. Utah. Sci., 47(2): 67-69.

Panter, K. E., Keeler, R. F., Baker, D. C. 1988. Toxicoses in livestock from the hemlocks (*Conium* and *Cicuta* spp.). J. Anim. Sci., 66: 2407-2413.

Starreveld, E., Hope, C. E. 1975. Cicutoxin poisoning (water hemlock). Neurology, 25: 730-734.

Nomenclature:

Scientific Name: *Cicuta douglasii* (DC.) Coult. & Rose

Vernacular name(s): western water-hemlock

Scientific family name: *Umbelliferae*

Vernacular family name: parsley

Go to ITIS*^{ca} for more taxonomic information on: [Cicuta](#)

[*douglasii*](#)

References:

Agriculture Quebec. 1975. Noms des maladies des plantes du Canada/ Names of plant diseases in Canada. , Quebec City, Que., Canada. 288 pp.

Alex, J. F., Cayouette, R., Mulligan, G. A. 1980. Common and botanical names of weeds in Canada/Noms populaire et scientifiques des plantes nuisibles du Canada. Revised. Agric. Can. Publ., Ottawa, Ont., Canada. 132 pp.

Bailey, L. H., Bailey, E. Z. 1976. Hortus third. Revised. MacMillan, New York, N.Y., USA. 1290 pp.

Scoggan, H. J. 1978, 1979. The flora of Canada. Nat. Mus. Nat. Sci. (Ottawa) Publ. Bot. 7(1)-7(4). 1711 pp.

Van Wijk, H. L. 1911. A dictionary of plant names. Martinus Nijhoff, The Hague, The Netherlands. 1444 pp.

Victorin, M. 1964. Flore Laurentienne. 2nd ed. Univ. Montreal, Montreal, Que., Canada. 952 pp.

Geographic Information

British Columbia

References:

Bailey, L. H., Bailey, E. Z. 1976. Hortus third. Revised. MacMillan, New York, N.Y., USA. 1290 pp.

Boivin, B. 1966, 1967. Énumération des plantes du Canada. Provencheria 6. Nat. Can. (Que.) 93: 253-274; 371-437; 583-646; 989-1063. 94: 131-157; 471-528; 625-655.

Image or illustration

western water-hemlock:

Images: images.google.com

Notes on Poisonous plant parts:

The toxins are concentrated in the chambered rootstock but also occur in the leaves and stems as well (James and Ralphs 1986).

Toxic parts:

leaves
 roots
 young shoots

References:

James, L. F., Ralphs, M. H. 1986. Water hemlock. *Utah. Sci.*, 47(2): 67-69.

Notes on Toxic plant chemicals:

Cicutoxin is a highly unsaturated alcohol that is very toxic. The following dosages have been found:

Lethal dose (fresh green plant material)	Animal
0.1 kg	sheep
0.4 kg	cattle
0.3 kg	horse

Pigs appear to be more resistant to poisoning than other livestock. Adult humans can be poisoned and can die with only two or three bites of the rootstock (Starrveld and Hope 1975, James and Ralphs 1986).

Toxic plant chemicals:

cicutoxin

References:

James, L. F., Ralphs, M. H. 1986. Water hemlock. *Utah. Sci.*, 47(2): 67-69.

Starreveld, E., Hope, C. E. 1975. Cicutoxin poisoning (water hemlock). *Neurology*, 25: 730-734.

Animals/Human Poisoning:

Note: When an animal is listed without additional information, the literature (as of 1993) contained no detailed explanation.

Cattle

General symptoms of poisoning:

[bloat](#)

[coma](#)
[convulsions](#)
[death by asphyxiation](#)
[lesions, no specific](#)
[muscle spasms](#)
[muscle twitching](#)
[nervousness](#)
[salivation](#)

Notes on poisoning:

Symptoms of poisoning are similar to all classes of livestock. See the information in general notes under [Cicuta maculata](#).

References:

James, L. F., Ralphs, M. H. 1986. Water hemlock. Utah. Sci., 47(2): 67-69.

Horses

General symptoms of poisoning:

[bloat](#)
[coma](#)
[convulsions](#)
[death by asphyxiation](#)
[lesions, no specific](#)
[muscle spasms](#)
[muscle twitching](#)
[nervousness](#)
[salivation](#)
[teeth grinding](#)

References:

James, L. F., Ralphs, M. H. 1986. Water hemlock. Utah. Sci., 47(2): 67-69.

Humans

General symptoms of poisoning:

[coma](#)

Notes on poisoning:

Toxicity and death in humans is possible with all three species of the genus *Cicuta* (water-hemlock). See the information in the

general notes under [Cicuta maculata](#).

References:

Starreveld, E., Hope, C. E. 1975. Cicutoxin poisoning (water hemlock). *Neurology*, 25: 730-734.

Sheep

General symptoms of poisoning:

[bloat](#)

[coma](#)

[convulsions](#)

[death](#)

[death by asphyxiation](#)

[gait, unsteady](#)

[incoordination](#)

[lesions, no specific](#)

[mouth, frothing of](#)

[muscle spasms](#)

[muscle twitching](#)

[nervousness](#)

[salivation](#)

[tarsal joint knuckling](#)

[teeth grinding](#)

[trembling](#)

[urination, frequent](#)

References:

James, L. F., Ralphs, M. H. 1986. Water hemlock. *Utah. Sci.*, 47(2): 67-69.

Panter, K. E., Keeler, R. F., Baker, D. C. 1988. Toxicoses in livestock from the hemlocks (*Conium* and *Cicuta* spp.). *J. Anim. Sci.*, 66: 2407-2413.

Swine

General symptoms of poisoning:

[coma](#)

[convulsions](#)

[death by asphyxiation](#)

[muscle spasms](#)

[muscle twitching](#)

[nervousness](#)

[salivation](#)

References:

James, L. F., Ralphs, M. H. 1986. Water hemlock. Utah. Sci., 47(2): 67-69.

[Another search?](#)

[Français](#) | [Contact Us](#) | [Help](#) | [Search](#) | [Canada site](#)

[Coming Events](#) | [About CBIF](#) | [Links](#) | [Reports and Publications](#) | [Home](#)

Date modified: 2003-02-06

[Important Notices](#)



Français	Contact us	Help	Search	Canada site
Coming events	About CBIF	Links	Reports and publications	Home

Canadian Biodiversity Information Facility



Notes on poisoning: white camas

[Introduction](#)[Interactive](#)[All poisonous plants by Botanical name](#)[All poisonous plants by Common name](#)[Important WWW Poisonous Plants sites](#)

General poisoning notes:

White camas (*Zigadenus elegans*) is a native perennial herb that grows from a bulb. The plant can be found across most of Canada from British Columbia to New Brunswick and in parts of northwestern Canada. The plant contains several steroidal alkaloids, including zygacine, which can poison livestock and humans. White camas has caused poisoning in sheep and may have been involved in poisoning cattle. Ingesting the bulbs can also cause poisoning. This plant is considered to be about seven times less toxic than death camas (*Zigadenus venenosus*). Poisoning is most common in early spring because this plant often is available before other forage is plentiful (Kingsbury 1964, Panter and James 1989).

References:

- Cheeke, P. R., Shull, L. R. 1985. Natural toxicants in feeds and poisonous plants. AVI Publishing Company, Inc., Westport, Conn., USA. 492 pp.
- Fuller, T. C., McClintock, E. 1986. Poisonous plants of California. Univ. California Press, Berkeley, Calif., USA. 432 pp.
- Kingsbury, J. M. 1964. Poisonous plants of the United States and Canada. Prentice-Hall Inc., Englewood Cliffs, N.J., USA. 626 pp.
- Panter, K. E., James, L. F. 1989. Death camas-early grazing can be hazardous. Rangelands, 11: 147-149.

Nomenclature:

Scientific Name: *Zigadenus elegans* Pursh

Vernacular name(s): white camas

Scientific family name: *Liliaceae*

Vernacular family name: lily

Go to ITIS^{*ca} for more taxonomic information on: [Zigadenus elegans](#)

References:

Agriculture Quebec. 1975. Noms des maladies des plantes du Canada/
Names of plant diseases in Canada. , Quebec City, Que., Canada. 288 pp.

Alex, J. F., Cayouette, R., Mulligan, G. A. 1980. Common and botanical
names of weeds in Canada/Noms populaire et scientifiques des plantes
nuisibles du Canada. Revised. Agric. Can. Publ., Ottawa, Ont., Canada.
132 pp.

Bailey, L. H., Bailey, E. Z. 1976. Hortus third. Revised. MacMillan, New
York, N.Y., USA. 1290 pp.

Scoggan, H. J. 1978, 1979. The flora of Canada. Nat. Mus. Nat. Sci.
(Ottawa) Publ. Bot. 7(1)-7(4). 1711 pp.

Van Wijk, H. L. 1911. A dictionary of plant names. Martinus Nijhoff, The
Hague, The Netherlands. 1444 pp.

Victorin, M. 1964. Flore Laurentienne. 2nd ed. Univ. Montreal, Montreal,
Que., Canada. 952 pp.

Geographic Information

Alberta
British Columbia
Manitoba
New Brunswick
Northwest Territories
Ontario
Quebec
Saskatchewan

References:

Bailey, L. H., Bailey, E. Z. 1976. Hortus third. Revised. MacMillan, New
York, N.Y., USA. 1290 pp.

Boivin, B. 1966, 1967. Énumération des plantes du Canada. Provencheria
6. Nat. Can. (Que.) 93: 253-274; 371-437; 583-646; 989-1063. 94:
131-157; 471-528; 625-655.

Image or illustration

white camas:

Images: images.google.com

Notes on Poisonous plant parts:

All parts of the plant are toxic. The early leaves are the most common cause of poisoning because the plants grow early, before other forage is plentiful. The bulbs may be pulled up and ingested if the ground is wet (Cheeke and Schull 1985, Panter and James 1989).

Toxic parts:

all parts
bulbs
flowers
leaves

References:

Cheeke, P. R., Shull, L. R. 1985. Natural toxicants in feeds and poisonous plants. AVI Publishing Company, Inc., Westport, Conn., USA. 492 pp.

Panter, K. E., James, L. F. 1989. Death camas-early grazing can be hazardous. Rangelands, 11: 147-149.

Notes on Toxic plant chemicals:

A steroidal alkaloid, zygacine, is one of several alkaloids contained in death camas. The lethal dose is estimated at between 2.0-6.0% of animal body weight. This plant is considered to be less toxic than death camas, *Zigadenus venenosus* (Kingsbury 1964).

Toxic plant chemicals:

zygacine

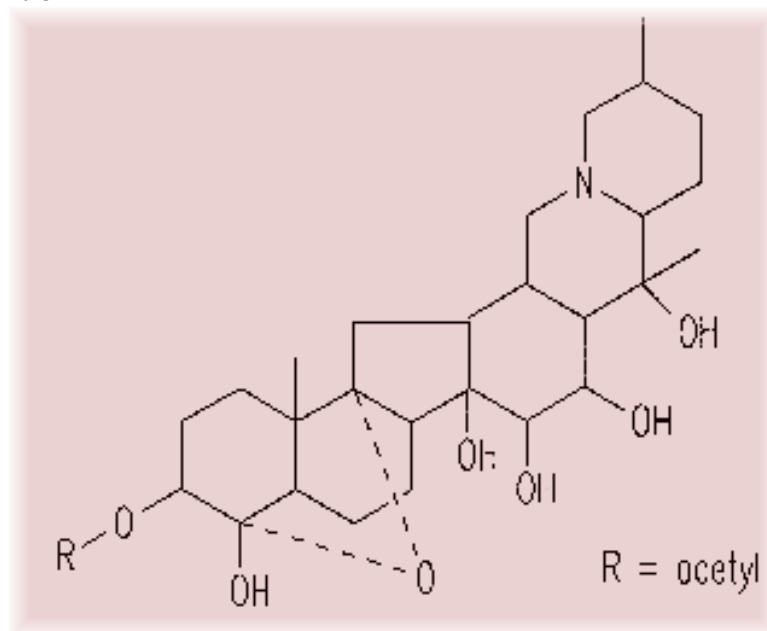

Chemical diagram(s) are courtesy of [Ruth McDiarmid](#), Biochemistry Technician, Kamloops Range Station, Agriculture and Agri-Food Canada, Kamloops, British Columbia, Canada.

References:

Cheeke, P. R., Shull, L. R. 1985. Natural toxicants in feeds and poisonous plants. AVI Publishing Company, Inc., Westport, Conn., USA. 492 pp.

Kingsbury, J. M. 1964. Poisonous plants of the United States and Canada. Prentice-Hall Inc., Englewood Cliffs, N.J., USA. 626 pp.

Animals/Human Poisoning:

Note: When an animal is listed without additional information, the literature (as of 1993) contained no detailed explanation.

Cattle

Horses

Humans

General symptoms of poisoning:

[blood pressure, low](#)

[coma](#)

[dizziness](#)

[heart rate, slow](#)

Notes on poisoning:

Ingesting the bulbs, mistaken for onions, can cause poisoning in humans, even though this species is considered less toxic than death camas (*Zigadenus venenosus*).

References:

Fuller, T. C., McClintock, E. 1986. Poisonous plants of California. Univ. California Press, Berkeley, Calif., USA. 432 pp.

Sheep

General symptoms of poisoning:

[ataxia](#)

[breathing, rapid](#)

[coma](#)

[death](#)

[death](#)
[mouth, frothing of](#)
[nasal discharge](#)
[nausea](#)
[salivation](#)
[urination, frequent](#)
[vomiting](#)

Notes on poisoning:

Symptoms of poisoning are similar for all species of animals. Symptoms in sheep include excessive salivation, froth around the nose and mouth, nausea, vomiting, muscular weakness, ataxia, possible coma, and death. The heart fails before respiration. Postmortem findings reveal the heart in complete diastole. Lesions include severe pulmonary congestion, hemorrhage, and edema. One-time loss of sheep has been reported as 500 head in some species of *Zigadenus* (Cheeke and Schull 1985, Panter and James 1989).

References:

Cheeke, P. R., Shull, L. R. 1985. Natural toxicants in feeds and poisonous plants. AVI Publishing Company, Inc., Westport, Conn., USA. 492 pp.

Panter, K. E., James, L. F. 1989. Death camas-early grazing can be hazardous. Rangelands, 11: 147-149.

[Another search?](#)

[Français](#) | [Contact Us](#) | [Help](#) | [Search](#) | [Canada site](#)

[Coming Events](#) | [About CBIF](#) | [Links](#) | [Reports and Publications](#) | [Home](#)

Date modified: 2003-02-06

[Important Notices](#)



Français	Contact us	Help	Search	Canada site
Coming events	About CBIF	Links	Reports and publications	Home

Canadian Biodiversity Information Facility



Notes on poisoning: white clover

[Introduction](#)[Interactive](#)[All poisonous plants by Botanical name](#)[All poisonous plants by Common name](#)[Important WWW Poisonous Plants sites](#)

General poisoning notes:

White clover (*Trifolium repens*) is widely cultivated across Canada and has also become naturalized throughout much of the country. Under certain circumstances this valuable plant can cause problems in animals. White clover can cause bloat in livestock. It has caused laminitis in horses and cattle. After they are ingested, some varieties can liberate HCN, causing cyanogenic poisoning in animals. White clover is also reported to become estrogenic if infected with various fungi (Cooper and Johnson 1984, Cheeke and Schull 1985).



References:

Cooper, M. R., Johnson, A. W. 1984. Poisonous plants in Britain and their effects on animals and man. Her Majesty's Stationery Office, London, England. 305 pp.

Hall, J. W., Majak, W. 1989. Plant and animal factors in legume bloat. Pages 93-106 in Cheeke, P. R., ed. Toxicants of plant origin. Vol. III. Proteins and amino acids. CRC Press, Inc., Boca Raton, Fla., USA. 271 pp.

Nomenclature:

Scientific Name: *Trifolium repens* L.

Vernacular name(s): white clover

Scientific family name: *Leguminosae*

Vernacular family name: pea

Go to ITIS*^{ca} for more taxonomic information on: [Trifolium repens](#)

References:

Agriculture Quebec. 1975. Noms des maladies des plantes du

Canada/ Names of plant diseases in Canada. , Quebec City, Que., Canada. 288 pp.

Alex, J. F., Cayouette, R., Mulligan, G. A. 1980. Common and botanical names of weeds in Canada/Noms populaire et scientifiques des plantes nuisibles du Canada. Revised. Agric. Can. Publ., Ottawa, Ont., Canada. 132 pp.

Bailey, L. H., Bailey, E. Z. 1976. Hortus third. Revised. MacMillan, New York, N.Y., USA. 1290 pp.

Scoggan, H. J. 1978, 1979. The flora of Canada. Nat. Mus. Nat. Sci. (Ottawa) Publ. Bot. 7(1)-7(4). 1711 pp.

Van Wijk, H. L. 1911. A dictionary of plant names. Martinus Nijhoff, The Hague, The Netherlands. 1444 pp.

Victorin, M. 1964. Flore Laurentienne. 2nd ed. Univ. Montreal, Montreal, Que., Canada. 952 pp.

Geographic Information

Alberta
British Columbia
Labrador
Manitoba
New Brunswick
Northwest Territories
Nova Scotia
Ontario
Prince Edward Island
Quebec
Saskatchewan
Yukon Territory

References:

Bailey, L. H., Bailey, E. Z. 1976. Hortus third. Revised. MacMillan, New York, N.Y., USA. 1290 pp.

Boivin, B. 1966, 1967. Énumération des plantes du Canada. Provencheria 6. Nat. Can. (Que.) 93: 253-274; 371-437; 583-646; 989-1063. 94: 131-157; 471-528; 625-655.

Image or illustration

white clover:

Images: images.google.com

Toxic parts:

all parts

References:

Cooper, M. R., Johnson, A. W. 1984. Poisonous plants in Britain and their effects on animals and man. Her Majesty's Stationery Office, London, England. 305 pp.

Notes on Toxic plant chemicals:

Two cyanogenic glycosides, linamarin and lotaustralin, are found in white clover. In young leaves, the cyanogen levels may reach 350 mg of HCN per 100 g of tissue, with lotaustralin predominating.

Cyanogenesis is controlled by two independently inherited genes in white clover. Only plants possessing at least one dominant functional allele of both genes liberate HCN when damaged. Some cultivars are capable of liberating HCN and others are not (Poultan 1989).

Toxic plant chemicals:

linamarin

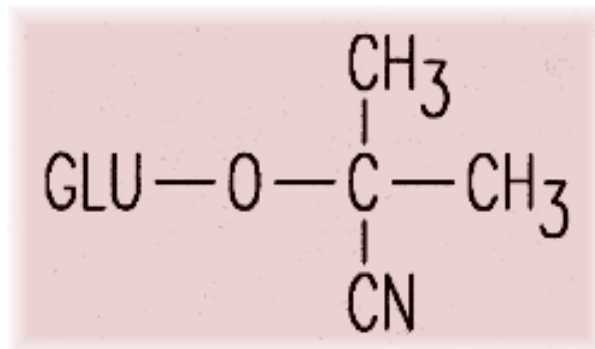

lotaustralin

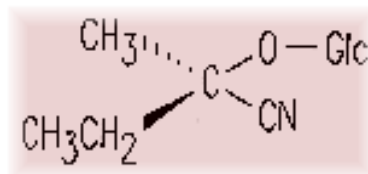

Chemical diagram(s) are courtesy of [Ruth McDiarmid](#), Biochemistry Technician, Kamloops Range Station, Agriculture and Agri-Food Canada, Kamloops, British Columbia, Canada.

References:

Poulton, J. E. 1983. Cyanogenic compounds in plants and their toxic effects. Pages 117-157 in Keeler, R. F., Tu, A. T., eds. Handbook of natural toxins. Vol. 1. Plant and Fungal toxins. Marcel Dekker, Inc., New York, N.Y., USA. 934 pp.

Animals/Human Poisoning:

Note: When an animal is listed without additional information, the literature (as of 1993) contained no detailed explanation.

Cattle

General symptoms of poisoning:

[bloat](#)

References:

Hall, J. W., Majak, W. 1989. Plant and animal factors in legume bloat. Pages 93-106 in Cheeke, P. R., ed. Toxicants of plant origin. Vol. III. Proteins and amino acids. CRC Press, Inc., Boca Raton, Fla., USA. 271 pp.

Horses

General symptoms of poisoning:

[laminitis](#)

Notes on poisoning:

Laminitis is characterized by tenderness, swelling, and inflammation around the hooves. In Britain severe laminitis has been reported in cattle as well (Cooper and Johnson 1984).

References:

Cooper, M. R., Johnson, A. W. 1984. Poisonous plants in Britain and their effects on animals and man. Her Majesty's Stationery Office, London, England. 305 pp.

[Another search?](#)

[Français](#) | [Contact Us](#) | [Help](#) | [Search](#) | [Canada site](#)

[Coming Events](#) | [About CBIF](#) | [Links](#) | [Reports and Publications](#) |

[Home](#)

Date modified: 2003-02-06

[Important Notices](#)



Français	Contact us	Help	Search	Canada site
Coming events	About CBIF	Links	Reports and publications	Home

Canadian Biodiversity Information Facility



Notes on poisoning: white oak

[Introduction](#)

[Interactive](#)

[All poisonous plants by Botanical name](#)

[All poisonous plants by Common name](#)

[Important WWW Poisonous Plants sites](#)



General poisoning notes:

White oak (*Quercus alba*) is a native tree found in southern Quebec and Ontario. Ingesting the leaves and acorns has caused some toxic problems in cattle. The concentration of toxic phenolics is less than in red or black oak (*Q. rubra* or *Q. velutina*). Symptoms are similar for all three species of oak. In severe cases, renal failure usually results in death (Sandusky et al. 1977, Cockrill and Beasley 1979).

References:

Cockrill, J. M., Beasley, J. N. 1979. Renal damage to cattle during acorn poisoning. *Vet. Med. Small Anim. Clin.*, 74: 82, 84-85.

Sandusky, G. E., Fosnaugh, C. J., Smith, J. B., Mohan, R. 1977. Oak poisoning of cattle in Ohio. *J. Am. Vet. Med. Assoc.*, 171: 627-629.

Nomenclature:

Scientific Name: *Quercus alba* L.

Vernacular name(s): white oak

Scientific family name: *Fagaceae*

Vernacular family name: beech

Go to ITIS*^{ca} for more taxonomic information on: [Quercus alba](#)

References:

Agriculture Quebec. 1975. Noms des maladies des plantes du Canada/ Names of plant diseases in Canada. , Quebec City, Que., Canada. 288 pp.

Alex, J. F., Cayouette, R., Mulligan, G. A. 1980. Common and botanical names of weeds in Canada/Noms populaire et scientifiques des plantes nuisibles du Canada. Revised. Agric. Can. Publ., Ottawa, Ont., Canada. 132 pp.

Bailey, L. H., Bailey, E. Z. 1976. Hortus third. Revised. MacMillan, New York, N.Y., USA. 1290 pp.

Scoggan, H. J. 1978, 1979. The flora of Canada. Nat. Mus. Nat. Sci. (Ottawa) Publ. Bot. 7(1)-7(4). 1711 pp.

Van Wijk, H. L. 1911. A dictionary of plant names. Martinus Nijhoff, The Hague, The Netherlands. 1444 pp.

Victorin, M. 1964. Flore Laurentienne. 2nd ed. Univ. Montreal, Montreal, Que., Canada. 952 pp.

Geographic Information

Ontario

Quebec

References:

Bailey, L. H., Bailey, E. Z. 1976. Hortus third. Revised. MacMillan, New York, N.Y., USA. 1290 pp.

Boivin, B. 1966, 1967. Énumération des plantes du Canada. Provencheria 6. Nat. Can. (Que.) 93: 253-274; 371-437; 583-646; 989-1063. 94: 131-157; 471-528; 625-655.

Image or illustration

white oak:

Images: images.google.com

Toxic parts:

acorns

leaves

References:

Sandusky, G. E., Fosnaugh, C. J., Smith, J. B., Mohan, R. 1977. Oak poisoning of cattle in Ohio. J. Am. Vet. Med. Assoc., 171: 627-629.

Notes on Toxic plant chemicals:

See notes under chemicals in red oak ([Quercus rubra](#)).

Toxic plant chemicals:

gallic acid
pyrogallol
tannic acid

References:

Basden, K. W., Dalvi, R. R. 1987. Determination of total phenolics in acorns from different species of oak trees in conjunction with acorn poisoning in cattle. *Vet. Hum. Toxicol.*, 29: 305-306.

Animals/Human Poisoning:

Note: When an animal is listed without additional information, the literature (as of 1993) contained no detailed explanation.

Cattle

General symptoms of poisoning:

[anorexia](#)

[ascites](#)

[death](#)

[dehydration](#)

[depression](#)

[diarrhea](#)

[kidney failure](#)

Notes on poisoning:

Toxic symptoms include anorexia, rumen atony, hemorrhagic diarrhea, subcutaneous edema, ascites, and dehydration. Renal failure usually results in death. Postmortem examination revealed perirenal edema and hemorrhage. The kidneys had a characteristic nephrosis in a multifocal pattern, of the proximal convoluted tubules (Sandusky et al. 1977, Cockrill and Beasley 1979).

References:

Cockrill, J. M., Beasley, J. N. 1979. Renal damage to cattle during acorn poisoning. *Vet. Med. Small Anim. Clin.*, 74: 82, 84-85.

Sandusky, G. E., Fosnaugh, C. J., Smith, J. B., Mohan, R. 1977.

Oak poisoning of cattle in Ohio. J. Am. Vet. Med. Assoc., 171:
627-629.

[Another search?](#)

[Français](#) | [Contact Us](#) | [Help](#) | [Search](#) | [Canada site](#)

[Coming Events](#) | [About CBIF](#) | [Links](#) | [Reports and Publications](#) |

[Home](#)

Date modified: 2003-02-06

[Important Notices](#)



Français	Contact us	Help	Search	Canada site
Coming events	About CBIF	Links	Reports and publications	Home

Canadian Biodiversity Information Facility



Notes on poisoning: white rose-bay

[Introduction](#)[Interactive](#)[All poisonous plants by Botanical name](#)[All poisonous plants by Common name](#)[Important WWW Poisonous Plants sites](#)

General poisoning notes:

White rose-bay (*Rhododendron albiflorum*) is a native shrub found in southwestern British Columbia. This plant is toxic to sheep, although rare cases of cattle poisoning may occur. The plant contains andromedotoxins (grayanotoxins) that can cause sickness and death after they are ingested by animals (Kingsbury 1964, Looman et al. 1983).

References:

Kingsbury, J. M. 1964. Poisonous plants of the United States and Canada. Prentice-Hall Inc., Englewood Cliffs, N.J., USA. 626 pp.

Looman, J., Majak, W., Smoliak, S. 1983. Stock-poisoning plants of western Canada. Agric. Can. Res. Branch Contrib. 1982-7E. 35 pp.

Nomenclature:

Scientific Name: *Rhododendron albiflorum* Lam.

Vernacular name(s): white rose-bay

Scientific family name: *Ericaceae*

Vernacular family name: heath

Go to ITIS^{*ca} for more taxonomic information on: [Rhododendron albiflorum](#)

References:

Agriculture Quebec. 1975. Noms des maladies des plantes du Canada/ Names of plant diseases in Canada. , Quebec City, Que., Canada. 288 pp.

Alex, J. F., Cayouette, R., Mulligan, G. A. 1980. Common and botanical names of weeds in Canada/Noms populaire et scientifiques des plantes nuisibles du Canada. Revised. Agric. Can. Publ., Ottawa, Ont., Canada.



132 pp.

Bailey, L. H., Bailey, E. Z. 1976. Hortus third. Revised. MacMillan, New York, N.Y., USA. 1290 pp.

Scoggan, H. J. 1978, 1979. The flora of Canada. Nat. Mus. Nat. Sci. (Ottawa) Publ. Bot. 7(1)-7(4). 1711 pp.

Van Wijk, H. L. 1911. A dictionary of plant names. Martinus Nijhoff, The Hague, The Netherlands. 1444 pp.

Victorin, M. 1964. Flore Laurentienne. 2nd ed. Univ. Montreal, Montreal, Que., Canada. 952 pp.

Geographic Information

Alberta
British Columbia

References:

Bailey, L. H., Bailey, E. Z. 1976. Hortus third. Revised. MacMillan, New York, N.Y., USA. 1290 pp.

Boivin, B. 1966, 1967. Énumération des plantes du Canada. Provencheria 6. Nat. Can. (Que.) 93: 253-274; 371-437; 583-646; 989-1063. 94: 131-157; 471-528; 625-655.

Image or illustration

white rose-bay:

Images: images.google.com

Toxic parts:

leaves

References:

Looman, J., Majak, W., Smoliak, S. 1983. Stock-poisoning plants of western Canada. Agric. Can. Res. Branch Contrib. 1982-7E. 35 pp.

Notes on Toxic plant chemicals:

Andromedotoxins (including grayanotoxin I) are toxic diterpenoids that are present in all the poisonous members of the heath family, Ericaceae (Cooper and Johnson 1984).

Toxic plant chemicals:

andromedotoxins

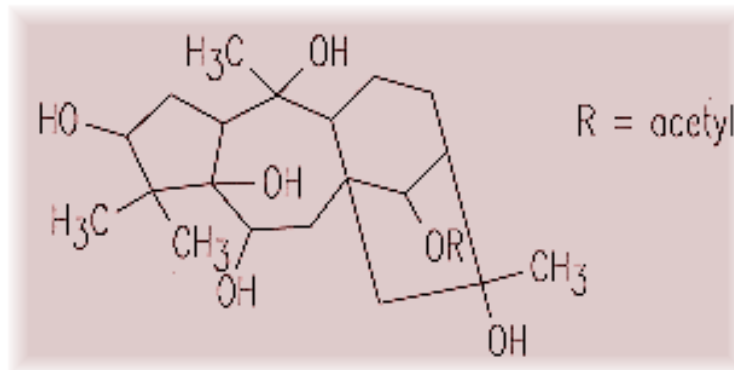

Chemical diagram(s) are courtesy of [Ruth McDiarmid](#), Biochemistry Technician, Kamloops Range Station, Agriculture and Agri-Food Canada, Kamloops, British Columbia, Canada.

References:

Cooper, M. R., Johnson, A. W. 1984. Poisonous plants in Britain and their effects on animals and man. Her Majesty's Stationery Office, London, England. 305 pp.

Animals/Human Poisoning:

Note: When an animal is listed without additional information, the literature (as of 1993) contained no detailed explanation.

Cattle

General symptoms of poisoning:

[anorexia](#)

[death](#)

[nasal discharge](#)

[salivation](#)

[vomiting](#)

[weakness](#)

Notes on poisoning:

Cattle are not poisoned as often as sheep because of the bitter taste of the leaves. Symptoms of ingestion may include initial anorexia, salivation, and dullness. Vomiting may be accompanied by bloat. Abdominal pain and nasal discharge occur. In severe cases, death may result (Kingsbury 1964).

References:

Kingsbury, J. M. 1964. Poisonous plants of the United States and Canada. Prentice-Hall Inc., Englewood Cliffs, N.J., USA. 626 pp.

Sheep

General symptoms of poisoning:

[convulsions](#)

[death](#)

[nasal discharge](#)

[paralysis](#)

[salivation](#)

Notes on poisoning:

The palatability of the leaves is low. However, ingesting the leaves causes symptoms, including salivation, nasal discharge, convulsions, paralysis of the limbs, and weakness. In severe cases, death can occur after a period of coma (Looman et al. 1983).

References:

Kingsbury, J. M. 1964. Poisonous plants of the United States and Canada. Prentice-Hall Inc., Englewood Cliffs, N.J., USA. 626 pp.

Looman, J., Majak, W., Smoliak, S. 1983. Stock-poisoning plants of western Canada. Agric. Can. Res. Branch Contrib. 1982-7E. 35 pp.

[Another search?](#)

[Français](#) | [Contact Us](#) | [Help](#) | [Search](#) | [Canada site](#)

[Coming Events](#) | [About CBIF](#) | [Links](#) | [Reports and Publications](#) | [Home](#)

Date modified: 2003-02-06

[Important Notices](#)



Français	Contact us	Help	Search	Canada site
Coming events	About CBIF	Links	Reports and publications	Home

Canadian Biodiversity Information Facility



Notes on poisoning: white snakeroot

[Introduction](#)

[Interactive](#)

[All poisonous plants by Botanical name](#)

[All poisonous plants by Common name](#)

[Important WWW Poisonous Plants sites](#)



General poisoning notes:

White snakeroot (*Eupatorium rugosum*) is a native herb that grows in rich soils in eastern Canada. This plant has caused illness and death of humans and several types of livestock. Large losses of human life occurred in the 19th century from the mysterious milk sickness. Mortality ranged from 10 to 25%, and the population of entire villages left a location because they could not find the cause of the disease. It was later discovered that cattle had ingested white snakeroot and that a toxin was subsequently passed through the milk to humans and was toxic. With modern collection and combination techniques, milk sickness from commercial milk sources is no longer a problem. However, the resurgence of small-scale farming and home milk production may result in occasional cases of milk sickness (Kingsbury 1964, Stotts 1984, Cheeke and Schull 1985, Beier and Norman 1990).

Several types of herbivorous livestock have also been poisoned by ingesting white snakeroot, resulting in a disease called trembles. Cattle, goats, horses, sheep, and swine have shown toxic reactions. Suckling animals can develop milk sickness as well. Trembles was more of a problem in the past, before the increased use of herbicides and prepared feeds. Poisoning was also more frequent when animals were allowed to range through bushlots. The amount of white snakeroot that must be ingested before death is variable, ranging from 1 to 20%. Symptoms can occur within a few days or up to 3 weeks later. Daily intake rates of 0.5-1.5% of body weight generally leads to the onset of symptoms. Drying the plant material does not completely remove the danger to animals (Doyle and Walkley 1949, Kingsbury 1964, Cheeke and Schull 1985, Beier and Norman 1990).

Additional care must be taken with milk from cattle or goats that may have ingested white snakeroot. Many articles state that a lactating animal does not always show symptoms. However, milk from that animal can still cause milk sickness. Calves, humans,

and cats have been poisoned in such cases. Dogs given the milk are also be at risk. Experimental work has shown that trembles can occur in rabbits and guinea pigs. White snakeroot grows in rich moist open woods and along water courses. Animals should not be allowed to graze this plant.

References:

Beier, R. C., Norman, J. O. 1990. The toxic factor in white snakeroot: identity, analysis and prevention. *Vet. Hum. Toxicol.*, 32: 81-88.

Cheeke, P. R., Shull, L. R. 1985. Natural toxicants in feeds and poisonous plants. AVI Publishing Company, Inc., Westport, Conn., USA. 492 pp.

Couch, J. F. 1927. The toxic constituent of richweed or white snakeroot (*Eupatorium urticaefolium*). *J. Agric. Res.*, 35: 547-576.

Doyle, L. P., Walkey, F. L. 1949. White snakeroot (*Eupatorium urticaefolium*) poisoning in livestock. *Purdue Univ. Agric. Exp. Stn. Bull.*, 270. 14 pp.

Kingsbury, J. M. 1964. Poisonous plants of the United States and Canada. Prentice-Hall Inc., Englewood Cliffs, N.J., USA. 626 pp.

Olson, C. T., Keller, W. C., Gerken, D. F., Reed, S. M. 1984. Suspected tremetol poisoning in horses. *J. Am. Vet. Med. Assoc.*, 185: 1001-1003.

Stotts, R. 1984. White snakeroot toxicity in dairy cattle. *Vet. Med. Small Anim. Clin.*, 79: 118-120.

Nomenclature:

Scientific Name: *Eupatorium rugosum* Houtt.

Vernacular name(s): white snakeroot

Scientific family name: *Compositae*

Vernacular family name: composite

Go to ITIS*^{ca} for more taxonomic information on: [Eupatorium rugosum](#)

References:

Agriculture Quebec. 1975. Noms des maladies des plantes du Canada/ Names of plant diseases in Canada. , Quebec City, Que., Canada. 288 pp.

Alex, J. F., Cayouette, R., Mulligan, G. A. 1980. Common and

botanical names of weeds in Canada/Noms populaire et scientifiques des plantes nuisibles du Canada. Revised. Agric. Can. Publ., Ottawa, Ont., Canada. 132 pp.

Bailey, L. H., Bailey, E. Z. 1976. Hortus third. Revised. MacMillan, New York, N.Y., USA. 1290 pp.

Scoggan, H. J. 1978, 1979. The flora of Canada. Nat. Mus. Nat. Sci. (Ottawa) Publ. Bot. 7(1)-7(4). 1711 pp.

Van Wijk, H. L. 1911. A dictionary of plant names. Martinus Nijhoff, The Hague, The Netherlands. 1444 pp.

Victorin, M. 1964. Flore Laurentienne. 2nd ed. Univ. Montreal, Montreal, Que., Canada. 952 pp.

Geographic Information

New Brunswick
Nova Scotia
Ontario
Prince Edward Island
Quebec

References:

Bailey, L. H., Bailey, E. Z. 1976. Hortus third. Revised. MacMillan, New York, N.Y., USA. 1290 pp.

Boivin, B. 1966, 1967. Énumération des plantes du Canada. Provencheria 6. Nat. Can. (Que.) 93: 253-274; 371-437; 583-646; 989-1063. 94: 131-157; 471-528; 625-655.

Image or illustration

white snakeroot:

Images: images.google.com

Toxic parts:

leaves
stems

References:

Doyle, L. P., Walkey, F. L. 1949. White snakeroot (*Eupatorium urticaefolium*) poisoning in livestock. Purdue Univ. Agric. Exp. Stn. Bull., 270. 14 pp.

Kaufmann, G. W. 1982. Seasonal variation of tremetol concentrations found in white snakeroot, *Eupatorium rugosum*

Houtt (Compositae). Proc. Iowa Acad. Sci., 89: 151-152.

Olson, C. T., Keller, W. C., Gerken, D. F., Reed, S. M. 1984. Suspected tremetol poisoning in horses. J. Am. Vet. Med. Assoc., 185: 1001-1003.

Notes on Toxic plant chemicals:

Tremetol is a secondary aromatic alcohol with a sterol and ketone fraction. One of these ketones, tremetone, has been tested on chickens, with negative results, but was toxic to goldfish in experimental studies. In Iowa the concentration of tremetol was found to be highest during the summer (Kaufmann 1982).

Toxic plant chemicals:

tremetol

References:

Couch, J. F. 1927. The toxic constituent of richweed or white snakeroot (*Eupatorium urticaefolium*). J. Agric. Res., 35: 547-576.

Kaufmann, G. W. 1982. Seasonal variation of tremetol concentrations found in white snakeroot, *Eupatorium rugosum* Houtt (Compositae). Proc. Iowa Acad. Sci., 89: 151-152.

Animals/Human Poisoning:

Note: When an animal is listed without additional information, the literature (as of 1993) contained no detailed explanation.

Cattle

General symptoms of poisoning:

[appetite, loss of](#)

[ataxia](#)

[brain, congestion of](#)

[breathing, rapid](#)

[coma](#)

[constipation](#)

[death](#)

[depression](#)

[gait, unsteady](#)

[lungs, congestion of](#)

[nasal discharge](#)

[nausea](#)
[prostration](#)
[recumbency](#)
[trembling](#)
[urine, yellowish](#)
[vomiting](#)
[weakness](#)

References:

Doyle, L. P., Walkey, F. L. 1949. White snakeroot (*Eupatorium urticaefolium*) poisoning in livestock. Purdue Univ. Agric. Exp. Stn. Bull., 270. 14 pp.

Stotts, R. 1984. White snakeroot toxicity in dairy cattle. Vet. Med. Small Anim. Clin., 79: 118-120.

Dogs

Goats

Horses

General symptoms of poisoning:

[breathing, labored](#)
[breathing, rapid](#)
[breathing, shallow](#)
[constipation](#)
[death](#)
[depression](#)
[gait, rigid](#)
[lungs, congestion of](#)
[nasal discharge](#)
[prostration](#)
[pupil dilation](#)
[recumbency](#)
[sweating](#)
[trembling](#)

References:

Doyle, L. P., Walkey, F. L. 1949. White snakeroot (*Eupatorium urticaefolium*) poisoning in livestock. Purdue Univ. Agric. Exp. Stn. Bull., 270. 14 pp.

Olson, C. T., Keller, W. C., Gerken, D. F., Reed, S. M. 1984. Suspected tremetol poisoning in horses. J. Am. Vet. Med. Assoc.,

185: 1001-1003.

Humans

Rabbits

Sheep

General symptoms of poisoning:

[acidosis](#)

[death](#)

[nervousness](#)

[trembling](#)

References:

Couch, J. F. 1927. The toxic constituent of richweed or white snakeroot (*Eupatorium urticaefolium*). J. Agric. Res., 35: 547-576.

Kingsbury, J. M. 1964. Poisonous plants of the United States and Canada. Prentice-Hall Inc., Englewood Cliffs, N.J., USA. 626 pp.

[Another search?](#)

[Français](#) | [Contact Us](#) | [Help](#) | [Search](#) | [Canada site](#)

[Coming Events](#) | [About CBIF](#) | [Links](#) | [Reports and Publications](#) |

[Home](#)

Date modified: 2003-02-06

[Important Notices](#)



Français	Contact us	Help	Search	Canada site
Coming events	About CBIF	Links	Reports and publications	Home



Notes on poisoning: white sweet-clover

[Introduction](#)

[Interactive](#)

[All poisonous plants by Botanical name](#)

[All poisonous plants by Common name](#)

[Important WWW Poisonous Plants sites](#)



General poisoning notes:

White sweet-clover (*Melilotus alba*) is a cultivated and naturalized plant that occurs as a weed across most of Canada. This plant contains a glycoside with a coumarin fraction. When sweet-clover is harvested for feed, the succulent stems usually mold before drying. The molds metabolize the glycoside into dicoumarol, which interrupts vitamin K activation of prothrombin, necessary in blood clotting. Levels of dicoumarol at more than 10 ppm are suspected of possible poisoning. Dicoumarol levels are usually higher in small and round bales than in stacks. Cattle, horses, and sheep have been poisoned. However, cattle are almost exclusively poisoned by sweet-clover (Blakely 1985, Cheeke and Schull 1985).

References:

- Alstad, A. D., Casper, H. H., Johnson, L. J. 1985. Vitamin K treatment of sweet clover poisoning in calves. J. Am. Vet. Med. Assoc., 187: 729-731.
- Blakley, B. R. 1985. Moldy sweet clover (dicoumarol) poisoning in Saskatchewan cattle. Can. Vet. J., 26: 357-360.
- McDonald, G. K. 1980. Moldy sweetclover poisoning in a horse. Can. Vet. J., 21: 250-251.
- Radostits, O. M., Searcy, G. P., Mitchall, K. G. 1980. Moldy sweetclover poisoning in cattle. Can. Vet. J., 21: 155-158.
- Turkington, R. A., Cavers, P. B., Rempel, E. 1978. The biology of Canadian weeds. 29. *Melilotus alba* Desr. and *M. officinalis* (L.) Lam. Can. J. Plant Sci., 58: 523-537.

Nomenclature:

Scientific Name: *Melilotus alba* Desr.

Vernacular name(s): white sweet-clover

Scientific family name: *Leguminosae*

Vernacular family name: pea

Go to ITIS^{*ca} for more taxonomic information on: [Melilotus alba](#)

References:

Agriculture Quebec. 1975. Noms des maladies des plantes du Canada/ Names of plant diseases in Canada. , Quebec City, Que., Canada. 288 pp.

Alex, J. F., Cayouette, R., Mulligan, G. A. 1980. Common and botanical names of weeds in Canada/Noms populaire et scientifiques des plantes nuisibles du Canada. Revised. Agric. Can. Publ., Ottawa, Ont., Canada. 132 pp.

Bailey, L. H., Bailey, E. Z. 1976. Hortus third. Revised. MacMillan, New York, N.Y., USA. 1290 pp.

Scoggan, H. J. 1978, 1979. The flora of Canada. Nat. Mus. Nat. Sci. (Ottawa) Publ. Bot. 7(1)-7(4). 1711 pp.

Van Wijk, H. L. 1911. A dictionary of plant names. Martinus Nijhoff, The Hague, The Netherlands. 1444 pp.

Victorin, M. 1964. Flore Laurentienne. 2nd ed. Univ. Montreal, Montreal, Que., Canada. 952 pp.

Geographic Information

Alberta
British Columbia
Labrador
Manitoba
New Brunswick
Northwest Territories
Nova Scotia
Ontario
Prince Edward Island
Quebec
Saskatchewan
Yukon Territory

References:

Bailey, L. H., Bailey, E. Z. 1976. Hortus third. Revised. MacMillan, New York, N.Y., USA. 1290 pp.

Boivin, B. 1966, 1967. Énumération des plantes du Canada. Provencheria 6. Nat. Can. (Que.) 93: 253-274; 371-437; 583-646;

Image or illustration

white sweet-clover:

Images: images.google.com

Notes on Poisonous plant parts:

Moldy sweet-clover is produced through insufficient drying of bales and silage. Dicoumarol production by molds is not likely to occur if animals ingest living plants.

Toxic parts:

leaves
stems

References:

Cheeke, P. R., Shull, L. R. 1985. Natural toxicants in feeds and poisonous plants. AVI Publishing Company, Inc., Westport, Conn., USA. 492 pp.

Notes on Toxic plant chemicals:

A glycoside, melilotoside, contains an ether and coumarin. The coumarin is metabolized by various molds (e.g., *Penicillium* spp.) into dicoumarol. Dicoumarol inhibits vitamin K, which causes hemorrhaging. Sweet-clover has a succulent stem, which makes molding common after cutting. Round bales have been found to have significantly higher dicoumarol (mean of 22.9 +/- 3.10 mg/kg) than stacks of silage (means 1.8 of +/- 6.3 and 0.6 +/- 2.1 mg/kg). The outer parts of round bales had a higher concentration of dicoumarol (Benson et al. 1981, Cheeke and Schull 1985).

Toxic plant chemicals:

dicoumarol

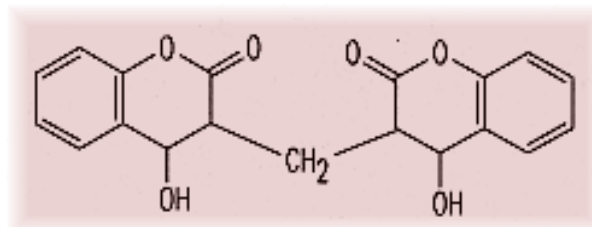

melilotoside

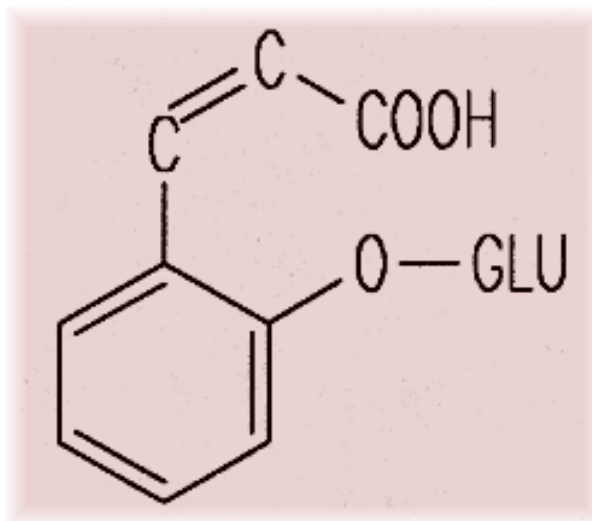

Chemical diagram(s) are courtesy of [Ruth McDiarmid](#), Biochemistry Technician, Kamloops Range Station, Agriculture and Agri-Food Canada, Kamloops, British Columbia, Canada.

References:

Benson, M. E., Casper, H. H., Johnson, L. J. 1981. Occurrence and range of dicumarol concentrations in sweet clover. *Am. J. Vet. Res.*, 42: 2014-2015.

Cheeke, P. R., Shull, L. R. 1985. Natural toxicants in feeds and poisonous plants. AVI Publishing Company, Inc., Westport, Conn., USA. 492 pp.

Animals/Human Poisoning:

Note: When an animal is listed without additional information, the literature (as of 1993) contained no detailed explanation.

Cattle

General symptoms of poisoning:

[abortion](#)

[anemia](#)

[heart rate, elevated](#)

[hemorrhage](#)

Notes on poisoning:

Symptoms of moldy sweet-clover poisoning may appear without any obvious cause. Trauma and surgery are often followed by severe hemorrhage and death. Hemorrhage may result after uncomplicated parturition. Newborn calves may die during the first few days of life if their dams have been fed on toxic feed. In Saskatchewan 286 animals from 56 herds were affected in 1983. The mortality rate was

12.1%. Aborted fetuses and calves less than 2 weeks old were affected most often. Poisoning usually occurred between January to April. Sweet-clover fed as bales was more of a problem than when fed as silage (Radostits et al. 1980, Blakely 1985). Treatment using vitamin K1 was effective at dosages of 1.1-3.3 mg/kg of body weight after poisoning by sweet-clover containing dicoumarol at a minimum of 90 ppm. Vitamin K3 was ineffective as treatment (Alstad et al. 1985).

References:

Alstad, A. D., Casper, H. H., Johnson, L. J. 1985. Vitamin K treatment of sweet clover poisoning in calves. J. Am. Vet. Med. Assoc., 187: 729-731.

Blakley, B. R. 1985. Moldy sweet clover (dicoumarol) poisoning in Saskatchewan cattle. Can. Vet. J., 26: 357-360.

Radostits, O. M., Searcy, G. P., Mitchall, K. G. 1980. Moldy sweetclover poisoning in cattle. Can. Vet. J., 21: 155-158.

Horses

General symptoms of poisoning:

[anemia](#)

[hemorrhage](#)

Notes on poisoning:

In one case in Saskatchewan, a Percheron mare was anemic and was hemorrhaging from the left nostril at 60 drops per min. Mucous membranes were blanched. Subcutaneous edema extended from the intermandibular space to the pectoral region. The animal was treated with an injection of 4.2 g of menadione sodium bisulphate and with 4 L of whole blood preserved in acid citrate dextrose solution. Complete recovery resulted. The mare had been fed weathered sweet-clover hay free-choice with access to pasture (McDonald 1980).

References:

McDonald, G. K. 1980. Moldy sweetclover poisoning in a horse. Can. Vet. J., 21: 250-251.

[Another search?](#)

[Français](#) | [Contact Us](#) | [Help](#) | [Search](#) | [Canada site](#)

[Coming Events](#) | [About CBIF](#) | [Links](#) | [Reports and Publications](#) |

[Home](#)

Date modified: 2003-02-06

[Important Notices](#)



Français	Contact us	Help	Search	Canada site
Coming events	About CBIF	Links	Reports and publications	Home



Notes on poisoning: wild cabbage

[Introduction](#)

[Interactive](#)

[All poisonous plants by Botanical name](#)

[All poisonous plants by Common name](#)

[Important WWW Poisonous Plants sites](#)



General poisoning notes:

Brassica oleracea includes common cultivated crops such as kale, broccoli, Brussels sprouts, and cabbage. All these vegetables are capable of forming toxic quantities of SMCO, a chemical that can cause hemolytic anemia in livestock. These plants also contain glucosinolates, which can cause goiter. In general, these widely used vegetables are safe for human consumption. Cases of livestock poisoning occur when they are used almost exclusively as fodder for animals (Kingsbury 1964, Smith 1980, Cheeke and Schull 1985, Benevenga et al. 1989). Glucosinolates contained in kale, cabbage, and broccoli (*Brassica oleracea*) can cause goiter in humans. These plants cause goiter in less than 5% of cases in humans. The chemicals cause a reduction in performance of young livestock, especially swine and poultry (Fenwick et al. 1989). It is important to note that the frequency of toxicity has dropped dramatically since a few decades ago. Researchers have changed the quantity of toxic compounds in the entire *Brassica* spp., creating new cultivars with lower quantities of these chemicals. The threat of poisoning from some of the plants has diminished or virtually disappeared in some cultivars. For example, the Canadian development of rapeseed into the so-called "double-zero" cultivars (low in glucosinolates and in erucic acid) has allowed rapeseed meal to be used for livestock at much higher levels without reducing performance (Cheeke and Schull 1985).

References:

Benevenga, N. J., Case, G. L., Steele, R. D. 1989. Occurrence and metabolism of s-methyl-l-cysteine and s-methyl-l-cysteine sulfoxide in plants and their toxicity and metabolism in animals. Pages 203-228 in Cheeke, P. R., ed. Toxicants of plant origin. Vol. III. Proteins and amino acids. CRC Press, Inc., Boca Raton, Fla., USA. 271 pp.

Cheeke, P. R., Shull, L. R. 1985. Natural toxicants in feeds and

poisonous plants. AVI Publishing Company, Inc., Westport, Conn., USA. 492 pp.

Fenwick, G. R., Heaney, R. K., Mawson, R. 1989. Glucosinolates. Pages 1-41 in Cheeke, P. R., ed. Toxicants of plant origin. Vol. II. Glycosides. CRC Press, Inc., Boca Raton, Fla., USA. 277 pp.

Kingsbury, J. M. 1964. Poisonous plants of the United States and Canada. Prentice-Hall Inc., Englewood Cliffs, N.J., USA. 626 pp.

Smith, R. H. 1980. Kale poisoning: the brassica anemia factor. Vet. Rec., 107: 12-15.

Nomenclature:

Scientific Name: *Brassica oleracea* L.

Vernacular name(s): wild cabbage

Scientific family name: *Cruciferae*

Vernacular family name: mustard

Go to ITIS*^{ca} for more taxonomic information on: [Brassica oleracea](#)

References:

Agriculture Quebec. 1975. Noms des maladies des plantes du Canada/ Names of plant diseases in Canada. , Quebec City, Que., Canada. 288 pp.

Alex, J. F., Cayouette, R., Mulligan, G. A. 1980. Common and botanical names of weeds in Canada/Noms populaire et scientifiques des plantes nuisibles du Canada. Revised. Agric. Can. Publ., Ottawa, Ont., Canada. 132 pp.

Bailey, L. H., Bailey, E. Z. 1976. Hortus third. Revised. MacMillan, New York, N.Y., USA. 1290 pp.

Scoggan, H. J. 1978, 1979. The flora of Canada. Nat. Mus. Nat. Sci. (Ottawa) Publ. Bot. 7(1)-7(4). 1711 pp.

Van Wijk, H. L. 1911. A dictionary of plant names. Martinus Nijhoff, The Hague, The Netherlands. 1444 pp.

Victorin, M. 1964. Flore Laurentienne. 2nd ed. Univ. Montreal, Montreal, Que., Canada. 952 pp.

Geographic Information

Newfoundland
Ontario
Prince Edward Island
Quebec

References:

Bailey, L. H., Bailey, E. Z. 1976. Hortus third. Revised. MacMillan, New York, N.Y., USA. 1290 pp.

Boivin, B. 1966, 1967. Énumération des plantes du Canada. Provencheria 6. Nat. Can. (Que.) 93: 253-274; 371-437; 583-646; 989-1063. 94: 131-157; 471-528; 625-655.

Image or illustration

wild cabbage:

Images: images.google.com

Notes on Poisonous plant parts:

SMCO is most abundant in young leaves and growing points. Brussels sprouts can have high amounts of the chemical, as can the flowering parts of the plants. The most drastic hemolytic anemia occurs when these plants form exclusive fodder for livestock (Smith 1980).

Toxic parts:

all parts
flowers
leaves

References:

Smith, R. H. 1980. Kale poisoning: the brassica anemia factor. Vet. Rec., 107: 12-15.

Notes on Toxic plant chemicals:

Glucosinolates are chemicals that can inhibit the function of the thyroid gland. Various components of the chemicals can be detrimental to both humans and livestock. Goitrin inhibits thyroid function. Thiocyanates and isothiocyanates inhibit iodine uptake by the thyroid gland. Nitriles can be formed from glucosinolates and these chemicals are toxic, affecting the liver and kidneys (Cheeke and Schull 1985). SMCO (S-methyl-L-cysteine sulfoxide) is an alpha-amino acid that causes hemolytic anemia in livestock. This chemical is restricted to various members of the family Cruciferae in the genera *Brassica* and *Raphanus* as well as the family Liliaceae in the genus *Allium* (onions). Additional notes on this chemical can be found under members of these genera. The concentration of SMCO

in kale plants may double as the plants mature. The quantity of SMCO is increased with the addition of nitrogen to high-sulfate soils. SMCO can be greatly reduced in low-sulfate soils. The variation of SMCO varies greatly amongst different varieties of plants in the genus *Brassica*, suggesting that concentrations of SMCO may be heritable (Benevenga et al. 1989).

Toxic plant chemicals:

glucosinolates

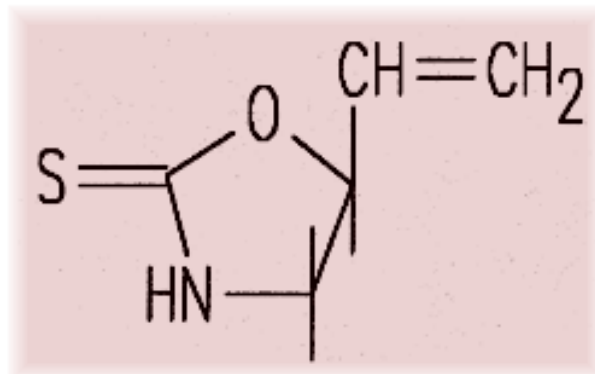

glucosinolates

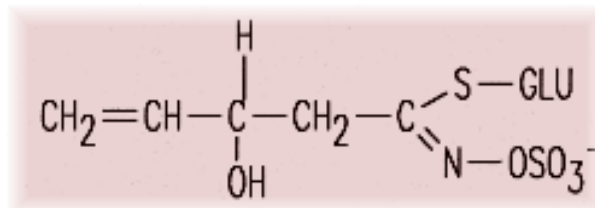

glucosinolates

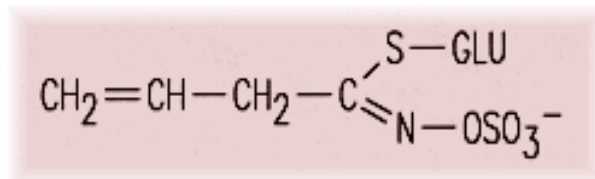

S-methyl-L-cysteine sulfoxide (SMCO)

Chemical diagram(s) are courtesy of [Ruth McDiarmid](#), Biochemistry Technician, Kamloops Range Station, Agriculture and Agri-Food Canada, Kamloops, British Columbia, Canada.

References:

Benevenga, N. J., Case, G. L., Steele, R. D. 1989. Occurrence and metabolism of s-methyl-l-cysteine and s-methyl-l-cysteine sulfoxide in plants and their toxicity and metabolism in animals. Pages 203-228 in Cheeke, P. R., ed. Toxicants of plant origin. Vol. III. Proteins and amino acids. CRC Press, Inc., Boca Raton, Fla., USA. 271 pp.

Cheeke, P. R., Shull, L. R. 1985. Natural toxicants in feeds and

poisonous plants. AVI Publishing Company, Inc., Westport, Conn., USA. 492 pp.

Animals/Human Poisoning:

Note: When an animal is listed without additional information, the literature (as of 1993) contained no detailed explanation.

Cattle

General symptoms of poisoning:

[Heinz bodies](#)
[hemoglobinuria](#)
[weight gain, reduced](#)

References:

Smith, R. H. 1980. Kale poisoning: the brassica anemia factor. Vet. Rec., 107: 12-15.

Goats

General symptoms of poisoning:

[Heinz bodies](#)
[hemoglobinuria](#)

References:

Smith, R. H. 1980. Kale poisoning: the brassica anemia factor. Vet. Rec., 107: 12-15.

Humans

General symptoms of poisoning:

[thyroid, enlarged](#)

References:

Cheeke, P. R., Shull, L. R. 1985. Natural toxicants in feeds and poisonous plants. AVI Publishing Company, Inc., Westport, Conn., USA. 492 pp.

Poultry

Sheep

General symptoms of poisoning:

[Heinz bodies](#)
[hemoglobinuria](#)

References:

Benevenga, N. J., Case, G. L., Steele, R. D. 1989. Occurrence and metabolism of s-methyl-l-cysteine and s-methyl-l-cysteine sulfoxide in plants and their toxicity and metabolism in animals. Pages 203-228 in Cheeke, P. R., ed. Toxicants of plant origin. Vol. III. Proteins and amino acids. CRC Press, Inc., Boca Raton, Fla., USA. 271 pp.

Swine

General symptoms of poisoning:

[weight gain, reduced](#)

Notes on poisoning:

Glucosinolates in the plants can cause general reduced weight gain in young pigs (less than 20 kg) (Fenwick et al. 1989).

References:

Fenwick, G. R., Heaney, R. K., Mawson, R. 1989. Glucosinolates. Pages 1-41 in Cheeke, P. R., ed. Toxicants of plant origin. Vol. II. Glycosides. CRC Press, Inc., Boca Raton, Fla., USA. 277 pp.

[Another search?](#)

[Français](#) | [Contact Us](#) | [Help](#) | [Search](#) | [Canada site](#)

[Coming Events](#) | [About CBIF](#) | [Links](#) | [Reports and Publications](#) |

[Home](#)

Date modified: 2003-02-06

[Important Notices](#)



Français	Contact us	Help	Search	Canada site
Coming events	About CBIF	Links	Reports and publications	Home

Canadian Biodiversity Information Facility



Notes on poisoning: wild calla

[Introduction](#)[Interactive](#)[All poisonous plants by Botanical name](#)[All poisonous plants by Common name](#)[Important WWW Poisonous Plants sites](#)

General poisoning notes:

Wild calla (*Calla palustris*) is a native plant that grows in swamps and marshes through much of Canada. Calcium oxalates occur, which can cause severe irritation of the mouth and throat. No cases of livestock poisoning are found in the literature, but the potential for poisoning is present. Humans are also at risk from this plant (Kingsbury 1964, Lampe and McCann 1985).

References:

Lampe, K. F., McCann, M. A. 1985. AMA Handbook of poisonous and injurious plants. American Medical Assoc. Chicago, Ill., USA. 432 pp.

Nomenclature:

Scientific Name: *Calla palustris* L.

Vernacular name(s): wild calla

Scientific family name: *Araceae*

Vernacular family name: arum

Go to ITIS^{*ca} for more taxonomic information on: [Calla palustris](#)

References:

Agriculture Quebec. 1975. Noms des maladies des plantes du Canada/ Names of plant diseases in Canada. , Quebec City, Que., Canada. 288 pp.

Alex, J. F., Cayouette, R., Mulligan, G. A. 1980. Common and botanical names of weeds in Canada/Noms populaire et scientifiques des plantes nuisibles du Canada. Revised. Agric. Can. Publ., Ottawa, Ont., Canada. 132 pp.

Bailey, L. H., Bailey, E. Z. 1976. Hortus third. Revised. MacMillan, New York, N.Y., USA. 1290 pp.

Scoggan, H. J. 1978, 1979. The flora of Canada. Nat. Mus. Nat. Sci. (Ottawa) Publ. Bot. 7(1)-7(4). 1711 pp.

Van Wijk, H. L. 1911. A dictionary of plant names. Martinus Nijhoff, The Hague, The Netherlands. 1444 pp.

Victorin, M. 1964. Flore Laurentienne. 2nd ed. Univ. Montreal, Montreal, Que., Canada. 952 pp.

Geographic Information

Alberta
British Columbia
Labrador
Manitoba
New Brunswick
Newfoundland
Northwest Territories
Nova Scotia
Ontario
Prince Edward Island
Quebec
Saskatchewan
Yukon Territory

References:

Bailey, L. H., Bailey, E. Z. 1976. Hortus third. Revised. MacMillan, New York, N.Y., USA. 1290 pp.

Boivin, B. 1966, 1967. Énumération des plantes du Canada. Provencheria 6. Nat. Can. (Que.) 93: 253-274; 371-437; 583-646; 989-1063. 94: 131-157; 471-528; 625-655.

Image or illustration

wild calla:

Images: images.google.com

Notes on Poisonous plant parts:

All parts of the plant contain calcium oxalate crystals, which can cause irritation of the mouth and throat (Lampe and McCann 1985).

Toxic parts:

leaves
rhizome
roots
stems

References:

Lampe, K. F., McCann, M. A. 1985. AMA Handbook of poisonous and injurious plants. American Medical Assoc. Chicago, Ill., USA. 432 pp.

Toxic plant chemicals:

oxalate

References:

Lampe, K. F., McCann, M. A. 1985. AMA Handbook of poisonous and injurious plants. American Medical Assoc. Chicago, Ill., USA. 432 pp.

Animals/Human Poisoning:

Note: When an animal is listed without additional information, the literature (as of 1993) contained no detailed explanation.

Cattle

Humans

General symptoms of poisoning:

[mouth, irritation of](#)

Notes on poisoning:

Mouth and throat irritation, accompanied by pain and swelling, occurs upon chewing of plant parts. The insoluble oxalates do not produce systemic poisoning in humans. Washing or heating the rhizome can inactivate the oxalates. In northern Europe the ground rhizome is used as flour for bread (Frohne and Pfander 1983, Lampe and McCann 1985).

References:

Lampe, K. F., McCann, M. A. 1985. AMA Handbook of poisonous and injurious plants. American Medical Assoc. Chicago, Ill., USA. 432 pp.

[Another search?](#)

[Français](#) | [Contact Us](#) | [Help](#) | [Search](#) | [Canada site](#)

[Coming Events](#) | [About CBIF](#) | [Links](#) | [Reports and Publications](#) |

[Home](#)

Date modified: 2003-02-06

[Important Notices](#)



Français	Contact us	Help	Search	Canada site
Coming events	About CBIF	Links	Reports and publications	Home

Canadian Biodiversity Information Facility



Notes on poisoning: wild false indigo

[Introduction](#)

[Interactive](#)

[All poisonous plants by Botanical name](#)

[All poisonous plants by Common name](#)

[Important WWW Poisonous Plants sites](#)

General poisoning notes:

Wild false indigo (*Baptisia leucantha*) is a native perennial herb found in southern Ontario. The plant contains toxic alkaloids that have caused poisoning in cattle (Hansen 1930). This plant is potentially poisonous to humans, but no cases of human poisoning have been reported (Cheeke and Schull 1985).



References:

Hansen, A. A. 1930. Indiana plants injurious to livestock. Purdue Univ. Agric. Ext. Stn. Circ., 175. 38 pp.

Lampe, K. F., McCann, M. A. 1985. AMA Handbook of poisonous and injurious plants. American Medical Assoc. Chicago, Ill., USA. 432 pp.

Nomenclature:

Scientific Name: *Baptisia leucantha* T. & G.

Vernacular name(s): wild false indigo

Scientific family name: *Leguminosae*

Vernacular family name: pea

Go to ITIS^{*ca} for more taxonomic information on: [Baptisia leucantha](#)

References:

Agriculture Quebec. 1975. Noms des maladies des plantes du Canada/ Names of plant diseases in Canada. , Quebec City, Que., Canada. 288 pp.

Alex, J. F., Cayouette, R., Mulligan, G. A. 1980. Common and

botanical names of weeds in Canada/Noms populaire et scientifiques des plantes nuisibles du Canada. Revised. Agric. Can. Publ., Ottawa, Ont., Canada. 132 pp.

Bailey, L. H., Bailey, E. Z. 1976. Hortus third. Revised. MacMillan, New York, N.Y., USA. 1290 pp.

Scoggan, H. J. 1978, 1979. The flora of Canada. Nat. Mus. Nat. Sci. (Ottawa) Publ. Bot. 7(1)-7(4). 1711 pp.

Van Wijk, H. L. 1911. A dictionary of plant names. Martinus Nijhoff, The Hague, The Netherlands. 1444 pp.

Victorin, M. 1964. Flore Laurentienne. 2nd ed. Univ. Montreal, Montreal, Que., Canada. 952 pp.

Geographic Information

Ontario

References:

Bailey, L. H., Bailey, E. Z. 1976. Hortus third. Revised. MacMillan, New York, N.Y., USA. 1290 pp.

Boivin, B. 1966, 1967. Énumération des plantes du Canada. Provencheria 6. Nat. Can. (Que.) 93: 253-274; 371-437; 583-646; 989-1063. 94: 131-157; 471-528; 625-655.

Image or illustration

wild false indigo:

Images: images.google.com

Toxic parts:

flowers
leaves
stems

References:

Hansen, A. A. 1930. Indiana plants injurious to livestock. Purdue Univ. Agric. Ext. Stn. Circ., 175. 38 pp.

Toxic plant chemicals:

cytisine

References:

Hansen, A. A. 1930. Indiana plants injurious to livestock. Purdue Univ. Agric. Ext. Stn. Circ., 175. 38 pp.

Lampe, K. F., McCann, M. A. 1985. AMA Handbook of poisonous and injurious plants. American Medical Assoc. Chicago, Ill., USA. 432 pp.

Animals/Human Poisoning:

Note: When an animal is listed without additional information, the literature (as of 1993) contained no detailed explanation.

Cattle

General symptoms of poisoning:

[anorexia](#)

[diarrhea](#)

References:

Hansen, A. A. 1930. Indiana plants injurious to livestock. Purdue Univ. Agric. Ext. Stn. Circ., 175. 38 pp.

Humans

[Another search?](#)

[Français](#) | [Contact Us](#) | [Help](#) | [Search](#) | [Canada site](#)

[Coming Events](#) | [About CBIF](#) | [Links](#) | [Reports and Publications](#) |

[Home](#)

Date modified: 2003-02-06

[Important Notices](#)



Français	Contact us	Help	Search	Canada site
Coming events	About CBIF	Links	Reports and publications	Home

Canadian Biodiversity Information Facility



Notes on poisoning: wild ginger

[Introduction](#)

[Interactive](#)

[All poisonous plants by Botanical name](#)

[All poisonous plants by Common name](#)

[Important WWW Poisonous Plants sites](#)

General poisoning notes:

Wild ginger (*Asarum canadense*) is a native wildflower growing in rich woods in eastern Canada. This plant can cause dermatitis in some humans (Mitchell and Rook 1979).

References:



Mitchell, J. C., Rook, A. 1979. Botanical dermatology. Greenglass Ltd, Vancouver, B.C., Canada. 787 pp.

Nomenclature:

Scientific Name: *Asarum canadense* L.

Vernacular name(s): wild ginger

Scientific family name: *Aristolochiaceae*

Vernacular family name: birthwort

Go to ITIS*^{ca} for more taxonomic information on: [Asarum canadense](#)

References:

Agriculture Quebec. 1975. Noms des maladies des plantes du Canada/ Names of plant diseases in Canada. , Quebec City, Que., Canada. 288 pp.

Alex, J. F., Cayouette, R., Mulligan, G. A. 1980. Common and botanical names of weeds in Canada/Noms populaire et scientifiques des plantes nuisibles du Canada. Revised. Agric. Can. Publ., Ottawa, Ont., Canada. 132 pp.

Bailey, L. H., Bailey, E. Z. 1976. Hortus third. Revised. MacMillan, New York, N.Y., USA. 1290 pp.

Scoggan, H. J. 1978, 1979. The flora of Canada. Nat. Mus. Nat. Sci. (Ottawa) Publ. Bot. 7(1)-7(4). 1711 pp.

Van Wijk, H. L. 1911. A dictionary of plant names. Martinus Nijhoff, The Hague, The Netherlands. 1444 pp.

Victorin, M. 1964. Flore Laurentienne. 2nd ed. Univ. Montreal, Montreal, Que., Canada. 952 pp.

Geographic Information

Manitoba

New Brunswick

Ontario

Quebec

References:

Bailey, L. H., Bailey, E. Z. 1976. Hortus third. Revised. MacMillan, New York, N.Y., USA. 1290 pp.

Boivin, B. 1966, 1967. Énumération des plantes du Canada. Provencheria 6. Nat. Can. (Que.) 93: 253-274; 371-437; 583-646; 989-1063. 94: 131-157; 471-528; 625-655.

Image or illustration

wild ginger:

Images: images.google.com

Toxic parts:

leaves

References:

Mitchell, J. C., Rook, A. 1979. Botanical dermatology. Greenglass Ltd, Vancouver, B.C., Canada. 787 pp.

Animals/Human Poisoning:

Note: When an animal is listed without additional information, the literature (as of 1993) contained no detailed explanation.

Humans

[Another search?](#)

[Français](#) | [Contact Us](#) | [Help](#) | [Search](#) | [Canada site](#)
[Coming Events](#) | [About CBIF](#) | [Links](#) | [Reports and Publications](#) |
[Home](#)

Date modified: 2003-02-06

[Important Notices](#)



Français	Contact us	Help	Search	Canada site
Coming events	About CBIF	Links	Reports and publications	Home

Canadian Biodiversity Information Facility



Notes on poisoning: wild indigo

[Introduction](#)[Interactive](#)[All poisonous plants by Botanical name](#)[All poisonous plants by Common name](#)[Important WWW Poisonous Plants sites](#)

General poisoning notes:

Wild indigo (*Baptisia tinctoria*) is a native perennial herb found in southern Ontario. Cheeke and Schull (1985) call the plant toxic but no cases of human poisoning have been reported.

References:



Lampe, K. F., McCann, M. A. 1985. AMA Handbook of poisonous and injurious plants. American Medical Assoc. Chicago, Ill., USA. 432 pp.

Nomenclature:

Scientific Name: *Baptisia tinctoria* (L.) Br.

Vernacular name(s): wild indigo

Scientific family name: *Leguminosae*

Vernacular family name: pea

Go to ITIS*^{ca} for more taxonomic information on: [Baptisia tinctoria](#)

References:

Agriculture Quebec. 1975. Noms des maladies des plantes du Canada/ Names of plant diseases in Canada. , Quebec City, Que., Canada. 288 pp.

Alex, J. F., Cayouette, R., Mulligan, G. A. 1980. Common and botanical names of weeds in Canada/Noms populaire et scientifiques des plantes nuisibles du Canada. Revised. Agric. Can. Publ., Ottawa, Ont., Canada. 132 pp.

Bailey, L. H., Bailey, E. Z. 1976. Hortus third. Revised.

MacMillan, New York, N.Y., USA. 1290 pp.

Scoggan, H. J. 1978, 1979. The flora of Canada. Nat. Mus. Nat. Sci. (Ottawa) Publ. Bot. 7(1)-7(4). 1711 pp.

Van Wijk, H. L. 1911. A dictionary of plant names. Martinus Nijhoff, The Hague, The Netherlands. 1444 pp.

Victorin, M. 1964. Flore Laurentienne. 2nd ed. Univ. Montreal, Montreal, Que., Canada. 952 pp.

Geographic Information

Ontario

References:

Bailey, L. H., Bailey, E. Z. 1976. Hortus third. Revised. MacMillan, New York, N.Y., USA. 1290 pp.

Boivin, B. 1966, 1967. Énumération des plantes du Canada. Provencheria 6. Nat. Can. (Que.) 93: 253-274; 371-437; 583-646; 989-1063. 94: 131-157; 471-528; 625-655.

Image or illustration

wild indigo:

Images: images.google.com

Toxic parts:

all parts
leaves

References:

Lampe, K. F., McCann, M. A. 1985. AMA Handbook of poisonous and injurious plants. American Medical Assoc. Chicago, Ill., USA. 432 pp.

Perkins, K. D., Payne, W. W. 1978. Guide to the poisonous and irritant plants of Florida. Univ. Fla. Agric. Ext. Serv. Circ., 441. 84 pp.

Toxic plant chemicals:

baptisin
cytisine

References:

Lampe, K. F., McCann, M. A. 1985. AMA Handbook of poisonous and injurious plants. American Medical Assoc. Chicago, Ill., USA. 432 pp.

Perkins, K. D., Payne, W. W. 1978. Guide to the poisonous and irritant plants of Florida. Univ. Fla. Agric. Ext. Serv. Circ., 441. 84 pp.

Animals/Human Poisoning:

Note: When an animal is listed without additional information, the literature (as of 1993) contained no detailed explanation.

Humans

[Another search?](#)

[Français](#) | [Contact Us](#) | [Help](#) | [Search](#) | [Canada site](#)

[Coming Events](#) | [About CBIF](#) | [Links](#) | [Reports and Publications](#) | [Home](#)

Date modified: 2003-02-06

[Important Notices](#)



Français	Contact us	Help	Search	Canada site
Coming events	About CBIF	Links	Reports and publications	Home

Canadian Biodiversity Information Facility



Notes on poisoning: wild mustard

[Introduction](#)[Interactive](#)[All poisonous plants by Botanical name](#)[All poisonous plants by Common name](#)[Important WWW Poisonous Plants sites](#)

General poisoning notes:

Wild mustard (*Sinapis arvensis*) is a naturalized herb found in fields and waste places across Canada. Cattle have been poisoned after ingesting hay containing large quantities of wild mustard seed. This plant contains glucosinolates. See the general notes under [Brassica oleracea](#), which further explain the poisoning potential of plants that contain these chemicals.

References:



Gwatkin, R., Moynihan, I. W. 1943. Wild mustard seed poisoning in cattle. *Can. J. Comp. Med.*, 7: 76-77.

Nomenclature:

Scientific Name: *Sinapis arvensis* L.

Vernacular name(s): wild mustard

Scientific family name: *Cruciferae*

Vernacular family name: mustard

Go to ITIS^{*ca} for more taxonomic information on: [Sinapis arvensis](#)

References:

Agriculture Quebec. 1975. Noms des maladies des plantes du Canada/ Names of plant diseases in Canada. , Quebec City, Que., Canada. 288 pp.

Alex, J. F., Cayouette, R., Mulligan, G. A. 1980. Common and botanical names of weeds in Canada/Noms populaire et scientifiques des plantes nuisibles du Canada. Revised. Agric. Can. Publ., Ottawa, Ont., Canada. 132 pp.

Bailey, L. H., Bailey, E. Z. 1976. Hortus third. Revised. MacMillan, New York, N.Y., USA. 1290 pp.

Scoggan, H. J. 1978, 1979. The flora of Canada. Nat. Mus. Nat. Sci. (Ottawa) Publ. Bot. 7(1)-7(4). 1711 pp.

Van Wijk, H. L. 1911. A dictionary of plant names. Martinus Nijhoff, The Hague, The Netherlands. 1444 pp.

Victorin, M. 1964. Flore Laurentienne. 2nd ed. Univ. Montreal, Montreal, Que., Canada. 952 pp.

Geographic Information

Alberta
British Columbia
Labrador
Manitoba
New Brunswick
Newfoundland
Northwest Territories
Nova Scotia
Ontario
Prince Edward Island
Quebec
Saskatchewan
Yukon Territory

References:

Bailey, L. H., Bailey, E. Z. 1976. Hortus third. Revised. MacMillan, New York, N.Y., USA. 1290 pp.

Boivin, B. 1966, 1967. Énumération des plantes du Canada. Provencheria 6. Nat. Can. (Que.) 93: 253-274; 371-437; 583-646; 989-1063. 94: 131-157; 471-528; 625-655.

Image or illustration

wild mustard:

Images: images.google.com

Toxic parts:

leaves
seeds

References:

Gwatkin, R., Moynihan, I. W. 1943. Wild mustard seed poisoning in

cattle. *Can. J. Comp. Med.*, 7: 76-77.

Mulligan, G. A., Bailey, L. G. 1975. The biology of Canadian weeds. 8. *Sinapis arvensis* L. *Can. J. Plant Sci.*, 55: 171-183.

Toxic plant chemicals:

glucosinolates

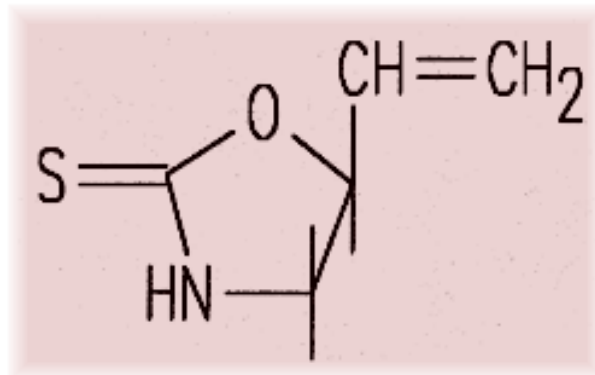

glucosinolates

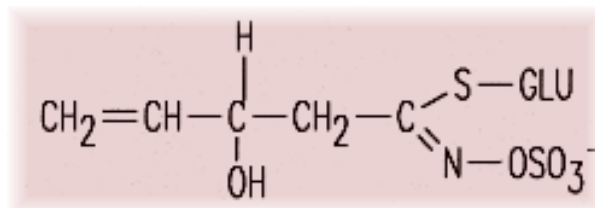

glucosinolates

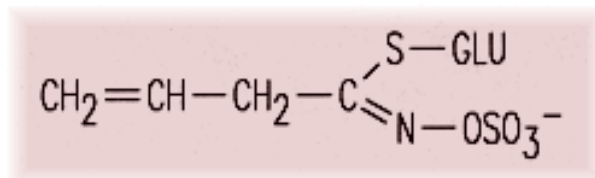

Chemical diagram(s) are courtesy of [Ruth McDiarmid](#), Biochemistry Technician, Kamloops Range Station, Agriculture and Agri-Food Canada, Kamloops, British Columbia, Canada.

References:

Gwatkin, R., Moynihan, I. W. 1943. Wild mustard seed poisoning in cattle. *Can. J. Comp. Med.*, 7: 76-77.

Animals/Human Poisoning:

Note: When an animal is listed without additional information, the literature (as of 1993) contained no detailed explanation.

Cattle

General symptoms of poisoning:

[collapse](#)

[death](#)

[gait, staggering](#)

Notes on poisoning:

Cattle have been poisoned in Canada after ingesting hay containing large quantities of wild mustard seed. The cattle first produced excessive saliva, after which they staggered, collapsed, and died (Gwatkin and Moynihan 1943).

References:

Gwatkin, R., Moynihan, I. W. 1943. Wild mustard seed poisoning in cattle. *Can. J. Comp. Med.*, 7: 76-77.

Swine

[Another search?](#)

[Français](#) | [Contact Us](#) | [Help](#) | [Search](#) | [Canada site](#)

[Coming Events](#) | [About CBIF](#) | [Links](#) | [Reports and Publications](#) |

[Home](#)

Date modified: 2003-02-06

[Important Notices](#)



Français	Contact us	Help	Search	Canada site
Coming events	About CBIF	Links	Reports and publications	Home

Canadian Biodiversity Information Facility



Notes on poisoning: wild onion

[Introduction](#)

[Interactive](#)

[All poisonous plants by Botanical name](#)

[All poisonous plants by Common name](#)

[Important WWW Poisonous Plants sites](#)



General poisoning notes:

Wild onion (*Allium canadense*) is a native herb found in parts of eastern Canada. This plant can cause gastroenteritis in young children who ingest parts of this plant. Chronic ingestion of the bulbs reduces iodine uptake by the thyroid gland, which can lead to problems. No specific treatment is suggested other than to prevent dehydration (Lampe and McCann 1985). Livestock have also been poisoned by ingesting wild onions, and some have died (Pipal 1918). Horses have developed hemolytic anemia from ingesting wild onion leaves (Scoggan 1989).

References:

Lampe, K. F., McCann, M. A. 1985. AMA Handbook of poisonous and injurious plants. American Medical Assoc. Chicago, Ill., USA. 432 pp.

Pipal, F. J. 1918. A suspected case of stock poisoning by wild onion (*Allium canadense*). Proc. Indiana Acad. Sci., 1917: 139.

Nomenclature:

Scientific Name: *Allium canadense* L.

Vernacular name(s): wild onion

Scientific family name: *Liliaceae*

Vernacular family name: lily

Go to ITIS^{*ca} for more taxonomic information on: [Allium canadense](#)

References:

Agriculture Quebec. 1975. Noms des maladies des plantes du

Canada/ Names of plant diseases in Canada. , Quebec City, Que., Canada. 288 pp.

Alex, J. F., Cayouette, R., Mulligan, G. A. 1980. Common and botanical names of weeds in Canada/Noms populaire et scientifiques des plantes nuisibles du Canada. Revised. Agric. Can. Publ., Ottawa, Ont., Canada. 132 pp.

Bailey, L. H., Bailey, E. Z. 1976. Hortus third. Revised. MacMillan, New York, N.Y., USA. 1290 pp.

Scoggan, H. J. 1978, 1979. The flora of Canada. Nat. Mus. Nat. Sci. (Ottawa) Publ. Bot. 7(1)-7(4). 1711 pp.

Van Wijk, H. L. 1911. A dictionary of plant names. Martinus Nijhoff, The Hague, The Netherlands. 1444 pp.

Victorin, M. 1964. Flore Laurentienne. 2nd ed. Univ. Montreal, Montreal, Que., Canada. 952 pp.

Geographic Information

New Brunswick

Ontario

Quebec

References:

Bailey, L. H., Bailey, E. Z. 1976. Hortus third. Revised. MacMillan, New York, N.Y., USA. 1290 pp.

Boivin, B. 1966, 1967. Énumération des plantes du Canada. Provencheria 6. Nat. Can. (Que.) 93: 253-274; 371-437; 583-646; 989-1063. 94: 131-157; 471-528; 625-655.

Image or illustration

wild onion:

Images: images.google.com

Toxic parts:

bulbs

leaves

References:

Scoggan, R. D. 1989. Wild onion toxicosis and other hemolytic anemia toxins. Equine professional topics. Univ. Ill. Urbana-Champaign Ext., 14(1): 1-2.

Notes on Toxic plant chemicals:

The three onion species (*Allium* spp.) mentioned in this information system contain S-methyl-L-cysteine sulfoxide (SMCO), which is a sulfur-containing alpha-amino acid. The empirical formula is C₄-H₉-O₃-NS. The common garden onion (*A. cepa*) contains the following:

- 100 mg/kg wet weight of SMCO in the leaves,
- 1600 mg/kg wet weight of SMCO in the bulbs (Benevenga et al. 1989)

Toxic plant chemicals:

S-methyl-L-cysteine sulfoxide (SMCO)

References:

Benevenga, N. J., Case, G. L., Steele, R. D. 1989. Occurrence and metabolism of s-methyl-l-cysteine and s-methyl-l-cysteine sulfoxide in plants and their toxicity and metabolism in animals. Pages 203-228 in Cheeke, P. R., ed. Toxicants of plant origin. Vol. III. Proteins and amino acids. CRC Press, Inc., Boca Raton, Fla., USA. 271 pp.

Animals/Human Poisoning:

Note: When an animal is listed without additional information, the literature (as of 1993) contained no detailed explanation.

Cattle

General symptoms of poisoning:

[breathing, rapid](#)

[death](#)

[gastroenteritis](#)

[heart rate, elevated](#)

[Heinz bodies](#)

[recumbency](#)

[weakness](#)

References:

Pipal, F. J. 1918. A suspected case of stock poisoning by wild onion (*Allium canadense*). Proc. Indiana Acad. Sci., 1917: 139.

Horses

Humans

[Another search?](#)

[Français](#) | [Contact Us](#) | [Help](#) | [Search](#) | [Canada site](#)

[Coming Events](#) | [About CBIF](#) | [Links](#) | [Reports and Publications](#) |

[Home](#)

Date modified: 2003-02-06

[Important Notices](#)



Français	Contact us	Help	Search	Canada site
Coming events	About CBIF	Links	Reports and publications	Home

Canadian Biodiversity Information Facility



Notes on poisoning: wild parsnip

[Introduction](#)[Interactive](#)[All poisonous plants by Botanical name](#)[All poisonous plants by Common name](#)[Important WWW Poisonous Plants sites](#)

General poisoning notes:

Parsnip (*Pastinaca sativa*) is a cultivated and a naturalized herb in much of Canada. The plant juices can cause photodermatitis in some individuals after exposure to sunlight. Exposure to leaves, stems, and peeling roots can cause the problem. The edible roots contain enough furocoumarins to be physiologically active in some cases. These toxins are mutagenic (even in the dark) inducing melanization in human skin. Photodermatitis from this plant is often confused with poison-ivy dermatitis (Mitchell and Rook 1979, Ivie et al. 1981).

References:

Ivie, G. W., Holt, D. L., Ivey, M. C. 1981. Natural toxicants in human foods: psoralens in raw and cooked parsnip root. *Science* (Wash D. C.), 213: 909-910.

Mitchell, J. C., Rook, A. 1979. *Botanical dermatology*. Greenglass Ltd, Vancouver, B.C., Canada. 787 pp.

Nomenclature:

Scientific Name: *Pastinaca sativa* L.

Vernacular name(s): wild parsnip

Scientific family name: *Umbelliferae*

Vernacular family name: parsley

Go to ITIS^{*ca} for more taxonomic information on: [Pastinaca sativa](#)

References:

Agriculture Quebec. 1975. Noms des maladies des plantes du

Canada/ Names of plant diseases in Canada. , Quebec City, Que., Canada. 288 pp.

Alex, J. F., Cayouette, R., Mulligan, G. A. 1980. Common and botanical names of weeds in Canada/Noms populaire et scientifiques des plantes nuisibles du Canada. Revised. Agric. Can. Publ., Ottawa, Ont., Canada. 132 pp.

Bailey, L. H., Bailey, E. Z. 1976. Hortus third. Revised. MacMillan, New York, N.Y., USA. 1290 pp.

Scoggan, H. J. 1978, 1979. The flora of Canada. Nat. Mus. Nat. Sci. (Ottawa) Publ. Bot. 7(1)-7(4). 1711 pp.

Van Wijk, H. L. 1911. A dictionary of plant names. Martinus Nijhoff, The Hague, The Netherlands. 1444 pp.

Victorin, M. 1964. Flore Laurentienne. 2nd ed. Univ. Montreal, Montreal, Que., Canada. 952 pp.

Geographic Information

Alberta
British Columbia
Labrador
Manitoba
New Brunswick
Newfoundland
Nova Scotia
Ontario
Prince Edward Island
Quebec
Saskatchewan
Yukon Territory

References:

Bailey, L. H., Bailey, E. Z. 1976. Hortus third. Revised. MacMillan, New York, N.Y., USA. 1290 pp.

Boivin, B. 1966, 1967. Énumération des plantes du Canada. Provencheria 6. Nat. Can. (Que.) 93: 253-274; 371-437; 583-646; 989-1063. 94: 131-157; 471-528; 625-655.

Image or illustration

wild parsnip:

Images: images.google.com

Notes on Poisonous plant parts:

Exposure to the plant juices in the leaves, stems, or roots can result in dermatitis caused by phototoxic furocoumarins. Wetness of the skin accentuates the results. Ingesting large quantities of parsnip root may expose people to sufficient quantities of psoralens to have physiological affects. Parsnips produce much higher concentrations of these toxins in response to disease infection (Mitchell and Rook 1979, Ivie et al. 1981).

Toxic parts:

plant juices

roots

References:

Ivie, G. W., Holt, D. L., Ivey, M. C. 1981. Natural toxicants in human foods: psoralens in raw and cooked parsnip root. *Science* (Wash D. C.), 213: 909-910.

Mitchell, J. C., Rook, A. 1979. *Botanical dermatology*. Greenglass Ltd, Vancouver, B.C., Canada. 787 pp.

Notes on Toxic plant chemicals:

Three furocoumarins (psoralen, xanthotoxin, bergapten) are found in parsnip roots. These chemicals are phototoxic, mutagenic, and photo- carcinogenic. The cumulative concentration is about 40 ppm. Consumption of 0.1 kg of parsnip could expose a person to 4-5 mg of psoralens, a level that may cause some physiological effects. These chemicals are potent photosensitizers and are highly mutagenic in long-wavelength ultraviolet light (Ivie et al. 1981).

Toxic plant chemicals:

furocoumarin

References:

Ivie, G. W., Holt, D. L., Ivey, M. C. 1981. Natural toxicants in human foods: psoralens in raw and cooked parsnip root. *Science* (Wash D. C.), 213: 909-910.

Animals/Human Poisoning:

Note: When an animal is listed without additional information,

the literature (as of 1993) contained no detailed explanation.

Humans

General symptoms of poisoning:

[blistering](#)

[erythema](#)

References:

Ivie, G. W., Holt, D. L., Ivey, M. C. 1981. Natural toxicants in human foods: psoralens in raw and cooked parsnip root. Science (Wash D. C.), 213: 909-910.

[Another search?](#)

[Français](#) | [Contact Us](#) | [Help](#) | [Search](#) | [Canada site](#)

[Coming Events](#) | [About CBIF](#) | [Links](#) | [Reports and Publications](#) | [Home](#)

Date modified: 2003-02-06

[Important Notices](#)



Français	Contact us	Help	Search	Canada site
Coming events	About CBIF	Links	Reports and publications	Home



Notes on poisoning: wild radish

[Introduction](#)

[Interactive](#)

[All poisonous plants by Botanical name](#)

[All poisonous plants by Common name](#)

[Important WWW Poisonous Plants sites](#)

General poisoning notes:

Wild radish (*Raphanus raphanistrum*) is a naturalized herb found across most of Canada. This plant, like the cultivated radish (*Raphanus sativus*) contains glucosinolates in the seeds, which can cause poisoning if eaten in sufficient quantities by livestock. Symptoms are similar to those discussed in the general notes under [Brassica oleracea](#).

References:



Kingsbury, J. M. 1964. Poisonous plants of the United States and Canada. Prentice-Hall Inc., Englewood Cliffs, N.J., USA. 626 pp.

Nomenclature:

Scientific Name: *Raphanus raphanistrum* L.

Vernacular name(s): wild radish

Scientific family name: *Cruciferae*

Vernacular family name: mustard

Go to ITIS*^{ca} for more taxonomic information on: [Raphanus raphanistrum](#)

References:

Agriculture Quebec. 1975. Noms des maladies des plantes du Canada/ Names of plant diseases in Canada. , Quebec City, Que., Canada. 288 pp.

Alex, J. F., Cayouette, R., Mulligan, G. A. 1980. Common and botanical names of weeds in Canada/Noms populaire et scientifiques des plantes nuisibles du Canada. Revised. Agric. Can. Publ., Ottawa, Ont., Canada. 132 pp.

Bailey, L. H., Bailey, E. Z. 1976. Hortus third. Revised. MacMillan, New York, N.Y., USA. 1290 pp.

Scoggan, H. J. 1978, 1979. The flora of Canada. Nat. Mus. Nat. Sci. (Ottawa) Publ. Bot. 7(1)-7(4). 1711 pp.

Van Wijk, H. L. 1911. A dictionary of plant names. Martinus Nijhoff, The Hague, The Netherlands. 1444 pp.

Victorin, M. 1964. Flore Laurentienne. 2nd ed. Univ. Montreal, Montreal, Que., Canada. 952 pp.

Geographic Information

British Columbia
Labrador
New Brunswick
Nova Scotia
Ontario
Prince Edward Island
Quebec
Saskatchewan

References:

Bailey, L. H., Bailey, E. Z. 1976. Hortus third. Revised. MacMillan, New York, N.Y., USA. 1290 pp.

Boivin, B. 1966, 1967. Énumération des plantes du Canada. Provencheria 6. Nat. Can. (Que.) 93: 253-274; 371-437; 583-646; 989-1063. 94: 131-157; 471-528; 625-655.

Image or illustration

wild radish:

Images: images.google.com

Toxic parts:

seeds

References:

Kingsbury, J. M. 1964. Poisonous plants of the United States and Canada. Prentice-Hall Inc., Englewood Cliffs, N.J., USA. 626 pp.

Palechek, N. 1986. Toxic weed seeds in cattle feed. Can. Vet. J., 26: A10.

Notes on Toxic plant chemicals:

Glucosinolates are contained in the seeds of this plant. See the discussions on these toxins in general notes under [Brassica oleracea](#).

Toxic plant chemicals:

glucosinolates

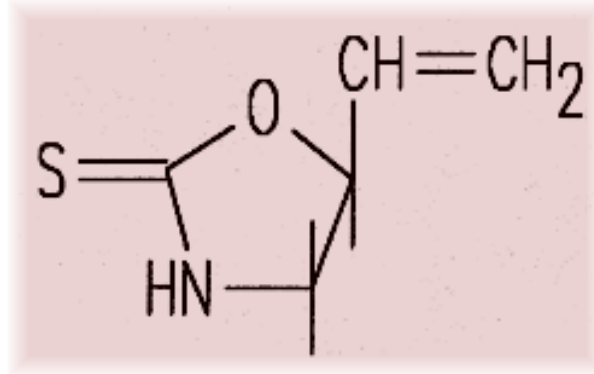

glucosinolates

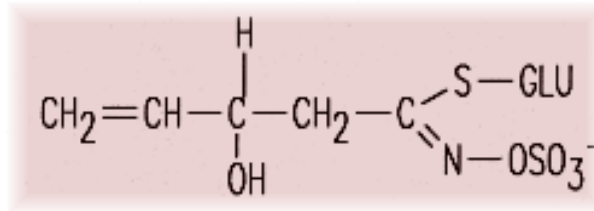

glucosinolates

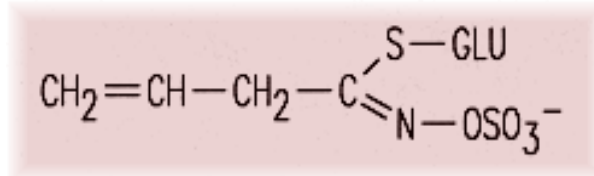

Chemical diagram(s) are courtesy of [Ruth McDiarmid](#), Biochemistry Technician, Kamloops Range Station, Agriculture and Agri-Food Canada, Kamloops, British Columbia, Canada.

References:

Kingsbury, J. M. 1964. Poisonous plants of the United States and Canada. Prentice-Hall Inc., Englewood Cliffs, N.J., USA. 626 pp.

Animals/Human Poisoning:

Note: When an animal is listed without additional information, the literature (as of 1993) contained no detailed explanation.

Cattle

General symptoms of poisoning:

[hemoglobinuria](#)

References:

Kingsbury, J. M. 1964. Poisonous plants of the United States and Canada. Prentice-Hall Inc., Englewood Cliffs, N.J., USA. 626 pp.

Sheep

[Another search?](#)

[Français](#) | [Contact Us](#) | [Help](#) | [Search](#) | [Canada site](#)

[Coming Events](#) | [About CBIF](#) | [Links](#) | [Reports and Publications](#) |

[Home](#)

Date modified: 2003-02-06

[Important Notices](#)



Français	Contact us	Help	Search	Canada site
Coming events	About CBIF	Links	Reports and publications	Home

Canadian Biodiversity Information Facility



Notes on poisoning: wormseed mustard

[Introduction](#)

[Interactive](#)

[All poisonous plants by Botanical name](#)

[All poisonous plants by Common name](#)

[Important WWW Poisonous Plants sites](#)

General poisoning notes:

Wormseed mustard (*Erysimum cheiranthoides*) is a naturalized herb found across Canada in fields and waste places. It contains large quantities of glucosinolates, which release allyl isothiocyanate upon hydrolysis. Cattle and swine were poisoned in Canada when feeds were contaminated with sufficient quantities of seed from wormseed mustard plants (Kingsbury 1964, Palechek 1986).

References:



Kingsbury, J. M. 1964. Poisonous plants of the United States and Canada. Prentice-Hall Inc., Englewood Cliffs, N.J., USA. 626 pp.

Palechek, N. 1986. Toxic weed seeds in cattle feed. Can. Vet. J., 26: A10.

Nomenclature:

Scientific Name: *Erysimum cheiranthoides* L.

Vernacular name(s): wormseed mustard

Scientific family name: *Cruciferae*

Vernacular family name: mustard

Go to ITIS*^{ca} for more taxonomic information on: [Erysimum cheiranthoides](#)

References:

Agriculture Quebec. 1975. Noms des maladies des plantes du Canada/ Names of plant diseases in Canada. , Quebec City, Que., Canada. 288 pp.

Alex, J. F., Cayouette, R., Mulligan, G. A. 1980. Common and

botanical names of weeds in Canada/Noms populaire et scientifiques des plantes nuisibles du Canada. Revised. Agric. Can. Publ., Ottawa, Ont., Canada. 132 pp.

Bailey, L. H., Bailey, E. Z. 1976. Hortus third. Revised. MacMillan, New York, N.Y., USA. 1290 pp.

Scoggan, H. J. 1978, 1979. The flora of Canada. Nat. Mus. Nat. Sci. (Ottawa) Publ. Bot. 7(1)-7(4). 1711 pp.

Van Wijk, H. L. 1911. A dictionary of plant names. Martinus Nijhoff, The Hague, The Netherlands. 1444 pp.

Victorin, M. 1964. Flore Laurentienne. 2nd ed. Univ. Montreal, Montreal, Que., Canada. 952 pp.

Geographic Information

Alberta
British Columbia
Manitoba
New Brunswick
Newfoundland
Northwest Territories
Nova Scotia
Ontario
Prince Edward Island
Quebec
Saskatchewan
Yukon Territory

References:

Bailey, L. H., Bailey, E. Z. 1976. Hortus third. Revised. MacMillan, New York, N.Y., USA. 1290 pp.

Boivin, B. 1966, 1967. Énumération des plantes du Canada. Provencheria 6. Nat. Can. (Que.) 93: 253-274; 371-437; 583-646; 989-1063. 94: 131-157; 471-528; 625-655.

Image or illustration

wormseed mustard:

Images: images.google.com

Toxic parts:

seeds

References:

Kingsbury, J. M. 1964. Poisonous plants of the United States and Canada. Prentice-Hall Inc., Englewood Cliffs, N.J., USA. 626 pp.

Palechek, N. 1986. Toxic weed seeds in cattle feed. Can. Vet. J., 26: A10.

Toxic plant chemicals:

glucosinolates

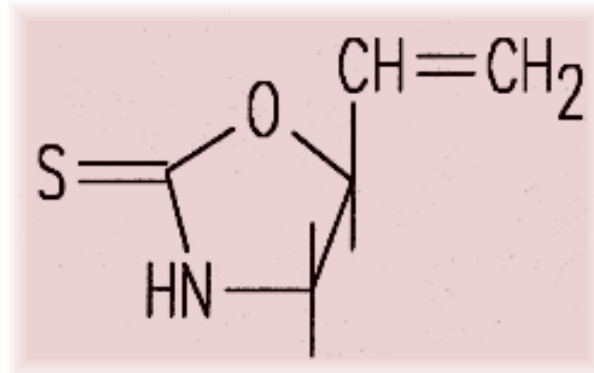

glucosinolates

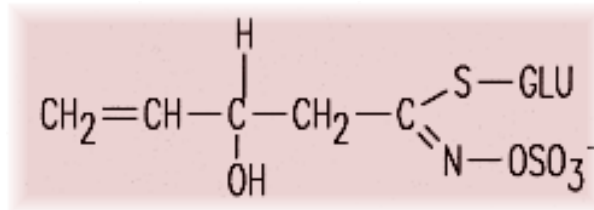

glucosinolates

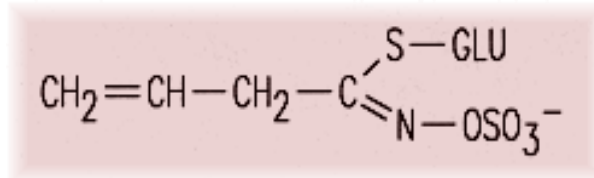

Chemical diagram(s) are courtesy of [Ruth McDiarmid](#), Biochemistry Technician, Kamloops Range Station, Agriculture and Agri-Food Canada, Kamloops, British Columbia, Canada.

References:

Kingsbury, J. M. 1964. Poisonous plants of the United States and Canada. Prentice-Hall Inc., Englewood Cliffs, N.J., USA. 626 pp.

Palechek, N. 1986. Toxic weed seeds in cattle feed. Can. Vet. J., 26: A10.

Animals/Human Poisoning:

Note: When an animal is listed without additional information, the literature (as of 1993) contained no detailed explanation.

Cattle

General symptoms of poisoning:

[colic](#)

[depression](#)

References:

Palechek, N. 1986. Toxic weed seeds in cattle feed. Can. Vet. J., 26: A10.

Swine

General symptoms of poisoning:

[death](#)

Notes on poisoning:

Swine died after ingesting food that contained 1.7% seeds of the plant by weight (Kingsbury 1964).

References:

Kingsbury, J. M. 1964. Poisonous plants of the United States and Canada. Prentice-Hall Inc., Englewood Cliffs, N.J., USA. 626 pp.

[Another search?](#)

[Français](#) | [Contact Us](#) | [Help](#) | [Search](#) | [Canada site](#)

[Coming Events](#) | [About CBIF](#) | [Links](#) | [Reports and Publications](#) |

[Home](#)

Date modified: 2003-02-06

[Important Notices](#)



Français	Contact us	Help	Search	Canada site
Coming events	About CBIF	Links	Reports and publications	Home

Canadian Biodiversity Information Facility



Notes on poisoning: yellow iris

[Introduction](#)

[Interactive](#)

[All poisonous plants by Botanical name](#)

[All poisonous plants by Common name](#)

[Important WWW Poisonous Plants sites](#)



General poisoning notes:

Yellow iris (*Iris pseudacorus*) is a naturalized plant found in wet areas in parts of southern Canada. This plant has poisoned cattle and swine and may cause similar symptoms in humans if the rhizomes are ingested. The plant juices can cause dermatitis in sensitive humans. In British Columbia cattle were poisoned by a cultivated blue-flowered *Iris* species. The symptoms of that poisoning are described under this species (Bruce 1920, Cooper and Johnson 1984).

References:

Bruce, E. A. 1920. Iris poisoning of calves. J. Am. Vet. Med. Assoc., 56: 72-74.

Cooper, M. R., Johnson, A. W. 1984. Poisonous plants in Britain and their effects on animals and man. Her Majesty's Stationery Office, London, England. 305 pp.

Nomenclature:

Scientific Name: *Iris pseudacorus* L.

Vernacular name(s): yellow iris

Scientific family name: *Iridaceae*

Vernacular family name: iris

Go to ITIS*^{ca} for more taxonomic information on: [Iris pseudacorus](#)

References:

Agriculture Quebec. 1975. Noms des maladies des plantes du Canada/ Names of plant diseases in Canada. , Quebec City, Que.,

Canada. 288 pp.

Alex, J. F., Cayouette, R., Mulligan, G. A. 1980. Common and botanical names of weeds in Canada/Noms populaire et scientifiques des plantes nuisibles du Canada. Revised. Agric. Can. Publ., Ottawa, Ont., Canada. 132 pp.

Bailey, L. H., Bailey, E. Z. 1976. Hortus third. Revised. MacMillan, New York, N.Y., USA. 1290 pp.

Scoggan, H. J. 1978, 1979. The flora of Canada. Nat. Mus. Nat. Sci. (Ottawa) Publ. Bot. 7(1)-7(4). 1711 pp.

Van Wijk, H. L. 1911. A dictionary of plant names. Martinus Nijhoff, The Hague, The Netherlands. 1444 pp.

Victorin, M. 1964. Flore Laurentienne. 2nd ed. Univ. Montreal, Montreal, Que., Canada. 952 pp.

Geographic Information

British Columbia
Manitoba
Nova Scotia
Ontario
Prince Edward Island
Quebec

References:

Bailey, L. H., Bailey, E. Z. 1976. Hortus third. Revised. MacMillan, New York, N.Y., USA. 1290 pp.

Boivin, B. 1966, 1967. Énumération des plantes du Canada. Provencheria 6. Nat. Can. (Que.) 93: 253-274; 371-437; 583-646; 989-1063. 94: 131-157; 471-528; 625-655.

Image or illustration

yellow iris:

Images: images.google.com

Notes on Poisonous plant parts:

Ingesting the rhizome causes poisoning in animals, and the plant juices cause dermatitis in sensitive individuals (Cooper and Johnson 1984).

Toxic parts:

plant juices
rhizome

References:

Cooper, M. R., Johnson, A. W. 1984. Poisonous plants in Britain and their effects on animals and man. Her Majesty's Stationery Office, London, England. 305 pp.

Notes on Toxic plant chemicals:

The toxin in Iris species has not been confirmed, but a glycoside, iridin (or irisin), has been implicated (Cooper and Johnson 1984).

Toxic plant chemicals:

iridin

References:

Cooper, M. R., Johnson, A. W. 1984. Poisonous plants in Britain and their effects on animals and man. Her Majesty's Stationery Office, London, England. 305 pp.

Animals/Human Poisoning:

Note: When an animal is listed without additional information, the literature (as of 1993) contained no detailed explanation.

Cattle

General symptoms of poisoning:

[abdominal pains](#)

[blistering](#)

[death](#)

[diarrhea](#)

[mouth, irritation of](#)

[recumbency](#)

[salivation](#)

Notes on poisoning:

Ingesting yellow flag rhizome has apparently caused diarrhea and bloody feces in cattle in Europe. The toxin can survive drying because yellow flag in hay causes diarrhea (Cooper and Johnson

1984).

In a case in British Columbia, cattle ingested rhizomes from an unidentified blue-flowered cultivated *Iris* species. Three calves showed symptoms and died within 4 days. Initial symptoms included recumbency and excessive salivation. The glands of the head and throat became hard and enlarged. Raised sores appeared on the lips and muzzle, becoming yellowish scabs that irritated animals. Acute abdominal pain occurred, and bloody feces were passed. Death followed. Postmortem findings showed irritation of the lower stomachs and intestines. The kidneys, liver, and spleen were very dark-colored. Unfortunately, the identity of this iris was never determined (Bruce 1920). Livestock should be denied access to any *Iris* species that grow in the wild or in gardens, because ingestion may cause poisoning.

References:

Bruce, E. A. 1920. Iris poisoning of calves. *J. Am. Vet. Med. Assoc.*, 56: 72-74.

Cooper, M. R., Johnson, A. W. 1984. Poisonous plants in Britain and their effects on animals and man. Her Majesty's Stationery Office, London, England. 305 pp.

Humans

General symptoms of poisoning:

[blistering](#)

References:

Cooper, M. R., Johnson, A. W. 1984. Poisonous plants in Britain and their effects on animals and man. Her Majesty's Stationery Office, London, England. 305 pp.

Swine

General symptoms of poisoning:

[abortion](#)

[death](#)

[diarrhea](#)

Notes on poisoning:

Swine that ingest rhizomes suffer diarrhea; one sow hemorrhaged, aborted, and died (Cooper and Johnson 1984).

References:

Cooper, M. R., Johnson, A. W. 1984. Poisonous plants in Britain and their effects on animals and man. Her Majesty's Stationery Office, London, England. 305 pp.

[Another search?](#)

[Français](#) | [Contact Us](#) | [Help](#) | [Search](#) | [Canada site](#)

[Coming Events](#) | [About CBIF](#) | [Links](#) | [Reports and Publications](#) |

[Home](#)

Date modified: 2003-02-06

[Important Notices](#)



Français	Contact us	Help	Search	Canada site
Coming events	About CBIF	Links	Reports and publications	Home

Canadian Biodiversity Information Facility



Notes on poisoning: yellow lady's-slipper

[Introduction](#)[Interactive](#)[All poisonous plants by Botanical name](#)[All poisonous plants by Common name](#)[Important WWW Poisonous Plants sites](#)

General poisoning notes:

Yellow lady's-slipper (*Cypripedium calceolus*) is a native perennial wild flower found across Canada. The plant causes a type of dermatitis that resembles the dermatitis caused by poison-ivy (*Rhus spp.*). See additional information under general notes for [Cypripedium acaule](#).



References:

Reddoch, A. H., Reddoch, J. M. 1984. Warning: Lady's-slippers can be hazardous to your health. Plant Press, 2(1): 10.

Nomenclature:

Scientific Name: *Cypripedium calceolus* L.

Vernacular name(s): yellow lady's-slipper

Scientific family name: *Orchidaceae*

Vernacular family name: orchid

Go to ITIS*^{ca} for more taxonomic information on: [Cypripedium calceolus](#)

References:

Agriculture Quebec. 1975. Noms des maladies des plantes du Canada/ Names of plant diseases in Canada. , Quebec City, Que., Canada. 288 pp.

Alex, J. F., Cayouette, R., Mulligan, G. A. 1980. Common and botanical names of weeds in Canada/Noms populaire et scientifiques des plantes nuisibles du Canada. Revised. Agric. Can. Publ., Ottawa, Ont., Canada. 132 pp.

Bailey, L. H., Bailey, E. Z. 1976. Hortus third. Revised. MacMillan, New York, N.Y., USA. 1290 pp.

Scoggan, H. J. 1978, 1979. The flora of Canada. Nat. Mus. Nat. Sci. (Ottawa) Publ. Bot. 7(1)-7(4). 1711 pp.

Van Wijk, H. L. 1911. A dictionary of plant names. Martinus Nijhoff, The Hague, The Netherlands. 1444 pp.

Victorin, M. 1964. Flore Laurentienne. 2nd ed. Univ. Montreal, Montreal, Que., Canada. 952 pp.

Geographic Information

Alberta
British Columbia
Labrador
Manitoba
New Brunswick
Newfoundland
Northwest Territories
Nova Scotia
Ontario
Quebec
Saskatchewan

References:

Bailey, L. H., Bailey, E. Z. 1976. Hortus third. Revised. MacMillan, New York, N.Y., USA. 1290 pp.

Boivin, B. 1966, 1967. Énumération des plantes du Canada. Provencheria 6. Nat. Can. (Que.) 93: 253-274; 371-437; 583-646; 989-1063. 94: 131-157; 471-528; 625-655.

Image or illustration

yellow lady's-slipper:

Images: images.google.com

Toxic parts:

leaves
stems

References:

Reddoch, A. H., Reddoch, J. M. 1984. Warning: Lady's-slippers can be hazardous to your health. Plant Press, 2(1): 10.

Toxic plant chemicals:

cypripedin

References:

Reddoch, A. H., Reddoch, J. M. 1984. Warning: Lady's-slippers can be hazardous to your health. Plant Press, 2(1): 10.

Animals/Human Poisoning:

Note: When an animal is listed without additional information, the literature (as of 1993) contained no detailed explanation.

Humans

General symptoms of poisoning:

[blisters, weeping](#)

References:

Reddoch, A. H., Reddoch, J. M. 1984. Warning: Lady's-slippers can be hazardous to your health. Plant Press, 2(1): 10.

[Another search?](#)

[Français](#) | [Contact Us](#) | [Help](#) | [Search](#) | [Canada site](#)

[Coming Events](#) | [About CBIF](#) | [Links](#) | [Reports and Publications](#) | [Home](#)

Date modified: 2003-02-06

[Important Notices](#)



Français	Contact us	Help	Search	Canada site
Coming events	About CBIF	Links	Reports and publications	Home

Canadian Biodiversity Information Facility



Notes on poisoning: yellow rocket

[Introduction](#)[Interactive](#)[All poisonous plants by Botanical name](#)[All poisonous plants by Common name](#)[Important WWW Poisonous Plants sites](#)

General poisoning notes:

Yellow rocket (*Barbarea vulgaris*) is a naturalized plant found across much of Canada. This plant poisoned a horse in one unusual case in which the animal ate large quantities of the plant from a wagon that was hauling the weed from a field (Hansen 1930). The symptoms suggested glucosinolate poisoning, as in *Brassica* spp.



References:

- Hansen, A. A. 1930. Indiana plants injurious to livestock. Purdue Univ. Agric. Ext. Stn. Circ., 175. 38 pp.
- MacDonald, M. A., Cavers, P. B. 1991. The biology of Canadian weeds. 97. *Barbarea vulgaris* R.Br. Can. J. Plant Sci., 71: 149-166.

Nomenclature:

Scientific Name: *Barbarea vulgaris* R. Br.

Vernacular name(s): yellow rocket

Scientific family name: *Cruciferae*

Vernacular family name: mustard

Go to ITIS*^{ca} for more taxonomic information on: [Barbarea vulgaris](#)

References:

- Agriculture Quebec. 1975. Noms des maladies des plantes du Canada/ Names of plant diseases in Canada. , Quebec City, Que., Canada. 288 pp.

Alex, J. F., Cayouette, R., Mulligan, G. A. 1980. Common and botanical names of weeds in Canada/Noms populaire et scientifiques des plantes nuisibles du Canada. Revised. Agric. Can. Publ., Ottawa, Ont., Canada. 132 pp.

Bailey, L. H., Bailey, E. Z. 1976. Hortus third. Revised. MacMillan, New York, N.Y., USA. 1290 pp.

Scoggan, H. J. 1978, 1979. The flora of Canada. Nat. Mus. Nat. Sci. (Ottawa) Publ. Bot. 7(1)-7(4). 1711 pp.

Van Wijk, H. L. 1911. A dictionary of plant names. Martinus Nijhoff, The Hague, The Netherlands. 1444 pp.

Victorin, M. 1964. Flore Laurentienne. 2nd ed. Univ. Montreal, Montreal, Que., Canada. 952 pp.

Geographic Information

Alberta
British Columbia
Labrador
Manitoba
New Brunswick
Newfoundland
Northwest Territories
Nova Scotia
Ontario
Prince Edward Island
Quebec
Saskatchewan
Yukon Territory

References:

Bailey, L. H., Bailey, E. Z. 1976. Hortus third. Revised. MacMillan, New York, N.Y., USA. 1290 pp.

Boivin, B. 1966, 1967. Énumération des plantes du Canada. Provencheria 6. Nat. Can. (Que.) 93: 253-274; 371-437; 583-646; 989-1063. 94: 131-157; 471-528; 625-655.

Image or illustration

yellow rocket:

Images: images.google.com

Toxic parts:

leaves

stems

References:

Hansen, A. A. 1930. Indiana plants injurious to livestock. Purdue Univ. Agric. Ext. Stn. Circ., 175. 38 pp.

Animals/Human Poisoning:

Note: When an animal is listed without additional information, the literature (as of 1993) contained no detailed explanation.

Horses

[Another search?](#)

[Français](#) | [Contact Us](#) | [Help](#) | [Search](#) | [Canada site](#)

[Coming Events](#) | [About CBIF](#) | [Links](#) | [Reports and Publications](#) |

[Home](#)

Date modified: 2003-02-06

[Important Notices](#)



Français	Contact us	Help	Search	Canada site
Coming events	About CBIF	Links	Reports and publications	Home

Canadian Biodiversity Information Facility



Notes on poisoning: yellow sage

[Introduction](#)

[Interactive](#)

[All poisonous plants by Botanical name](#)

[All poisonous plants by Common name](#)

[Important WWW Poisonous Plants sites](#)



General poisoning notes:

Yellow sage (*Lantana camara*) is occasionally sold as a houseplant and may also be planted outdoors in the summer in Canada. Children who ingested green berries became ill and died. In warmer parts of the world (e.g., Florida, Australia), the plant grows outside and becomes weedy. Livestock have been poisoned after ingesting the entire plants. Importantly, livestock that ingest berries exhibit symptoms that are different from those of children who ingest the berries. Livestock do not normally encounter this plant in Canada, but the symptoms of poisoning are included under cattle. Sheep and goats have also been poisoned. Care should be taken to keep children as well as family pets away from this plant (Wolfson and Solomons 1964, McLennan and Amos 1989, Spoerke and Smolinske 1990). Cats and dogs that have access to yellow sage indoors can become poisoned if they ingest the immature berries of foliage of this plant. No records were found in the literature of toxicity in pets from yellow sage ingestion.

References:

McLennan, M. W., Amos, M. L. 1989. Treatment of lantana poisoning in cattle. *Aust. Vet. J.*, 66: 93-94.

Spoerke, D. G., Smolinske, S. C. 1990. Toxicity of houseplants. CRC Press, Inc., Boca Raton, Fla., USA. 335 pp.

Wolfson, S. L., Solomons, T. W. 1964. Poisoning by fruit of *Lantana camara*. *Am. J. Dis. Child.*, 107: 109-112.

Nomenclature:

Scientific Name: *Lantana camara* L.

Vernacular name(s): yellow sage

Scientific family name: *Verbenaceae*

Vernacular family name: vervain

Go to ITIS^{*ca} for more taxonomic information on: [Lantana camara](#)

References:

Agriculture Quebec. 1975. Noms des maladies des plantes du Canada/ Names of plant diseases in Canada. , Quebec City, Que., Canada. 288 pp.

Alex, J. F., Cayouette, R., Mulligan, G. A. 1980. Common and botanical names of weeds in Canada/Noms populaire et scientifiques des plantes nuisibles du Canada. Revised. Agric. Can. Publ., Ottawa, Ont., Canada. 132 pp.

Bailey, L. H., Bailey, E. Z. 1976. Hortus third. Revised. MacMillan, New York, N.Y., USA. 1290 pp.

Scoggan, H. J. 1978, 1979. The flora of Canada. Nat. Mus. Nat. Sci. (Ottawa) Publ. Bot. 7(1)-7(4). 1711 pp.

Van Wijk, H. L. 1911. A dictionary of plant names. Martinus Nijhoff, The Hague, The Netherlands. 1444 pp.

Victorin, M. 1964. Flore Laurentienne. 2nd ed. Univ. Montreal, Montreal, Que., Canada. 952 pp.

Geographic Information

Plant or plant parts used in or around the home.

References:

Bailey, L. H., Bailey, E. Z. 1976. Hortus third. Revised. MacMillan, New York, N.Y., USA. 1290 pp.

Boivin, B. 1966, 1967. Énumération des plantes du Canada. Provencheria 6. Nat. Can. (Que.) 93: 253-274; 371-437; 583-646; 989-1063. 94: 131-157; 471-528; 625-655.

Image or illustration

yellow sage:

Images: images.google.com

Notes on Poisonous plant parts:

Ingesting the leaves has caused poisoning in livestock in areas

where the plant can survive outdoors, such as Florida and Australia. Young children who ingested the green berries became ill and died (Wolfson and Solomons 1964, McLennan and Amos 1989).

Toxic parts:

immature fruit
leaves

References:

McLennan, M. W., Amos, M. L. 1989. Treatment of lantana poisoning in cattle. Aust. Vet. J., 66: 93-94.

Sharma, O. P., Dawra, R. K., Makkar, H. P. 1989. Toxicity of isolated lantana (*Lantana camara* L.) constituents to male and female guinea pigs. Vet. Hum. Toxicol., 31: 10-13.

Notes on Toxic plant chemicals:

Lantadene A and lantadene B, which are pentacyclic triterpenes, have been suspected as the toxic constituents of yellow sage leaves. However, there are conflicting findings on the chemical toxins and their toxic affects on animals. Sharma et al. (1989) found that crystal polymorphism in the triterpenoids changes the toxicity (polyhedral crystals are toxic to guinea pigs and rod-shaped crystals are not). In addition, the toxic component of the berries has not been defined. The plant also contains a fish poison, lancamarone, that is present in the greatest concentration in the summer. The effects of this chemical on mammals have not been studied (Spoerke and Smolinske 1990).

Toxic plant chemicals:

lantadene A & B

References:

Sharma, O. P., Dawra, R. K., Makkar, H. P. 1989. Toxicity of isolated lantana (*Lantana camara* L.) constituents to male and female guinea pigs. Vet. Hum. Toxicol., 31: 10-13.

Animals/Human Poisoning:

Note: When an animal is listed without additional information, the literature (as of 1993) contained no detailed explanation.

Cats

Cattle

General symptoms of poisoning:

[appetite, loss of](#)

[dehydration](#)

[jaundice](#)

[urine, yellowish](#)

References:

Spoerke, D. G., Smolinske, S. C. 1990. Toxicity of houseplants. CRC Press, Inc., Boca Raton, Fla., USA. 335 pp.

Dogs

Goats

Humans

General symptoms of poisoning:

[ataxia](#)

[breathing, labored](#)

[cyanosis](#)

[death](#)

[diarrhea](#)

[lethargy](#)

[liver, congestion of](#)

[pupil dilation](#)

[pupils, pinpoint](#)

[unconsciousness](#)

[vomiting](#)

[weakness](#)

Notes on poisoning:

Ingesting the green berries of yellow sage produces the following symptoms: vomiting, diarrhea, weakness, lethargy, cyanosis, slow labored breathing, dilated pupils, ataxia, coma, and depressed deep tendon reflexes. Postmortem findings showed congestion of the lungs and kidneys. The small intestines were dilated. These symptoms all occurred after an unknown quantity of the immature green berries was ingested. The rough texture of the leaves and stems discourages children from ingesting them. Humans have therefore not shown the photosensitivity and liver problems that occur when livestock ingest entire plants. Lavage

should be done quickly to reduce or prevent symptoms. Several authors have reported that the ripe berries are nontoxic to humans (Wolfson and Solomons 1964, Spoerke and Smolinske 1990).

References:

Spoerke, D. G., Smolinske, S. C. 1990. Toxicity of houseplants. CRC Press, Inc., Boca Raton, Fla., USA. 335 pp.

Wolfson, S. L., Solomons, T. W. 1964. Poisoning by fruit of *Lantana camara*. Am. J. Dis. Child., 107: 109-112.

Sheep

[Another search?](#)

[Français](#) | [Contact Us](#) | [Help](#) | [Search](#) | [Canada site](#)

[Coming Events](#) | [About CBIF](#) | [Links](#) | [Reports and Publications](#) |

[Home](#)

Date modified: 2003-02-06

[Important Notices](#)



Français	Contact us	Help	Search	Canada site
Coming events	About CBIF	Links	Reports and publications	Home

Canadian Biodiversity Information Facility



Notes on poisoning: yellow star-thistle

[Introduction](#)

[Interactive](#)

[All poisonous plants by Botanical name](#)

[All poisonous plants by Common name](#)

[Important WWW Poisonous Plants sites](#)

General poisoning notes:

Yellow star-thistle (*Centaurea solstitialis*) has the same toxic effect on horses as Russian thistle, which is more toxic. Chewing disease becomes incurable once clinical signs are present (Cordy 1987). See the general notes under Russian thistle.



References:

Cordy, D. R. 1978. *Centaurea* species and equine nigropallidal encephalomalacia. Pages 327-336 in Keeler, R. F., Van Kampen, K. R., James, L. F., eds. Effects of poisonous plants on livestock. Academic Press, New York, N.Y., USA. 600 pp.

Nomenclature:

Scientific Name: *Centaurea solstitialis* L.

Vernacular name(s): yellow star-thistle

Scientific family name: *Compositae*

Vernacular family name: composite

Go to ITIS^{*ca} for more taxonomic information on: [Centaurea solstitialis](#)

References:

Agriculture Quebec. 1975. Noms des maladies des plantes du Canada/ Names of plant diseases in Canada. , Quebec City, Que., Canada. 288 pp.

Alex, J. F., Cayouette, R., Mulligan, G. A. 1980. Common and botanical names of weeds in Canada/Noms populaire et scientifiques des plantes nuisibles du Canada. Revised. Agric. Can. Publ., Ottawa, Ont., Canada. 132 pp.

Bailey, L. H., Bailey, E. Z. 1976. Hortus third. Revised. MacMillan, New York, N.Y., USA. 1290 pp.

Scoggan, H. J. 1978, 1979. The flora of Canada. Nat. Mus. Nat. Sci. (Ottawa) Publ. Bot. 7(1)-7(4). 1711 pp.

Van Wijk, H. L. 1911. A dictionary of plant names. Martinus Nijhoff, The Hague, The Netherlands. 1444 pp.

Victorin, M. 1964. Flore Laurentienne. 2nd ed. Univ. Montreal, Montreal, Que., Canada. 952 pp.

Geographic Information

Manitoba

Ontario

Saskatchewan

References:

Bailey, L. H., Bailey, E. Z. 1976. Hortus third. Revised. MacMillan, New York, N.Y., USA. 1290 pp.

Boivin, B. 1966, 1967. Énumération des plantes du Canada. Provencheria 6. Nat. Can. (Que.) 93: 253-274; 371-437; 583-646; 989-1063. 94: 131-157; 471-528; 625-655.

Image or illustration

yellow star-thistle:

Images: images.google.com

Toxic parts:

all parts

leaves

stems

References:

Cordy, D. R. 1978. *Centaurea* species and equine nigropallidal encephalomalacia. Pages 327-336 in Keeler, R. F., Van Kampen, K. R., James, L. F., eds. Effects of poisonous plants on livestock. Academic Press, New York, N.Y., USA. 600 pp.

Toxic plant chemicals:

unknown chemical

References:

Cordy, D. R. 1978. *Centaurea* species and equine nigropallidal encephalomalacia. Pages 327-336 in Keeler, R. F., Van Kampen, K. R., James, L. F., eds. Effects of poisonous plants on livestock. Academic Press, New York, N.Y., USA. 600 pp.

Animals/Human Poisoning:

Note: When an animal is listed without additional information, the literature (as of 1993) contained no detailed explanation.

Horses

General symptoms of poisoning:

[death](#)

[incoordination](#)

[water intake, reduced](#)

References:

Cordy, D. R. 1978. *Centaurea* species and equine nigropallidal encephalomalacia. Pages 327-336 in Keeler, R. F., Van Kampen, K. R., James, L. F., eds. Effects of poisonous plants on livestock. Academic Press, New York, N.Y., USA. 600 pp.

[Another search?](#)

[Français](#) | [Contact Us](#) | [Help](#) | [Search](#) | [Canada site](#)

[Coming Events](#) | [About CBIF](#) | [Links](#) | [Reports and Publications](#) | [Home](#)

Date modified: 2003-02-06

[Important Notices](#)



Français	Contact us	Help	Search	Canada site
Coming events	About CBIF	Links	Reports and publications	Home



Notes on poisoning: yellow sweet-clover

[Introduction](#)

[Interactive](#)

[All poisonous plants by Botanical name](#)

[All poisonous plants by Common name](#)

[Important WWW Poisonous Plants sites](#)

General poisoning notes:

Yellow sweet-clover (*Melilotus officinalis*) is cultivated and naturalized across most of Canada. When cut for feed, molding usually occurs because of the succulent stems. The molds can metabolize coumarin which is hydrolyzed from a plant glycoside. Dicoumarol is produced, which is toxic to animals. See notes under white sweet-clover ([Melilotus alba](#)).

References:



Cheeke, P. R., Shull, L. R. 1985. Natural toxicants in feeds and poisonous plants. AVI Publishing Company, Inc., Westport, Conn., USA. 492 pp.

McDonald, G. K. 1980. Moldy sweetclover poisoning in a horse. Can. Vet. J., 21: 250-251.

Radostits, O. M., Searcy, G. P., Mitchall, K. G. 1980. Moldy sweetclover poisoning in cattle. Can. Vet. J., 21: 155-158.

Turkington, R. A., Cavers, P. B., Rempel, E. 1978. The biology of Canadian weeds. 29. *Melilotus alba* Desr. and *M. officinalis* (L.) Lam. Can. J. Plant Sci., 58: 523-537.

Nomenclature:

Scientific Name: *Melilotus officinalis* (L.) Lam.

Vernacular name(s): yellow sweet-clover

Scientific family name: *Leguminosae*

Vernacular family name: pea

Go to ITIS*^{ca} for more taxonomic information on: [Melilotus officinalis](#)

References:

Agriculture Quebec. 1975. Noms des maladies des plantes du Canada/ Names of plant diseases in Canada. , Quebec City, Que., Canada. 288 pp.

Alex, J. F., Cayouette, R., Mulligan, G. A. 1980. Common and botanical names of weeds in Canada/Noms populaire et scientifiques des plantes nuisibles du Canada. Revised. Agric. Can. Publ., Ottawa, Ont., Canada. 132 pp.

Bailey, L. H., Bailey, E. Z. 1976. Hortus third. Revised. MacMillan, New York, N.Y., USA. 1290 pp.

Scoggan, H. J. 1978, 1979. The flora of Canada. Nat. Mus. Nat. Sci. (Ottawa) Publ. Bot. 7(1)-7(4). 1711 pp.

Van Wijk, H. L. 1911. A dictionary of plant names. Martinus Nijhoff, The Hague, The Netherlands. 1444 pp.

Victorin, M. 1964. Flore Laurentienne. 2nd ed. Univ. Montreal, Montreal, Que., Canada. 952 pp.

Geographic Information

Alberta
British Columbia
Manitoba
New Brunswick
Newfoundland
Northwest Territories
Nova Scotia
Ontario
Prince Edward Island
Quebec
Saskatchewan
Yukon Territory

References:

Bailey, L. H., Bailey, E. Z. 1976. Hortus third. Revised. MacMillan, New York, N.Y., USA. 1290 pp.

Boivin, B. 1966, 1967. Énumération des plantes du Canada. Provencheria 6. Nat. Can. (Que.) 93: 253-274; 371-437; 583-646; 989-1063. 94: 131-157; 471-528; 625-655.

Image or illustration

yellow sweet-clover:

Images: images.google.com

Toxic parts:

leaves
stems

References:

Cheeke, P. R., Shull, L. R. 1985. Natural toxicants in feeds and poisonous plants. AVI Publishing Company, Inc., Westport, Conn., USA. 492 pp.

Notes on Toxic plant chemicals:

A glycoside, melilotoside, hydrolyzes to coumarin. Coumarin is metabolized by molds into dicoumarol, which interrupts vitamin K use in animals. Blood-clotting abilities are affected. See additional notes under white sweet-clover ([Melilotus alba](#)).

Toxic plant chemicals:

dicoumarol

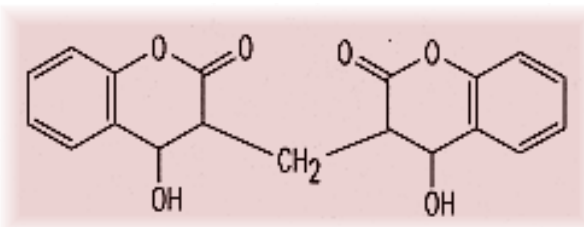

melilotoside

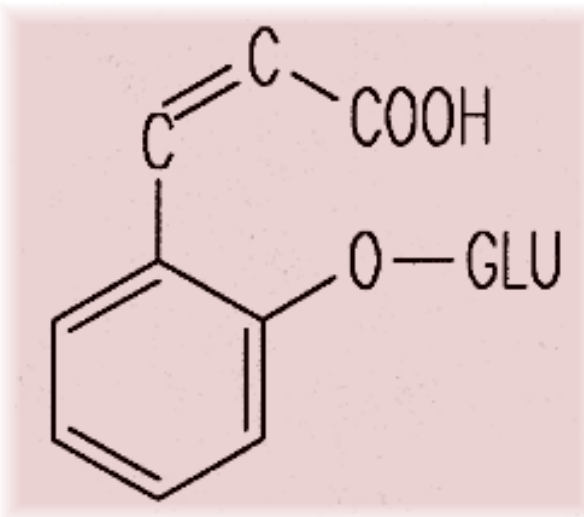

Chemical diagram(s) are courtesy of [Ruth McDiarmid](#), Biochemistry Technician, Kamloops Range Station, Agriculture and Agri-Food Canada, Kamloops, British Columbia, Canada.

References:

Cheeke, P. R., Shull, L. R. 1985. Natural toxicants in feeds and poisonous plants. AVI Publishing Company, Inc., Westport, Conn., USA. 492 pp.

Animals/Human Poisoning:

Note: When an animal is listed without additional information, the literature (as of 1993) contained no detailed explanation.

Cattle

General symptoms of poisoning:

[anemia](#)

[hemorrhage](#)

Notes on poisoning:

See notes under white sweet-clover ([Melilotus alba](#)).

References:

Cheeke, P. R., Shull, L. R. 1985. Natural toxicants in feeds and poisonous plants. AVI Publishing Company, Inc., Westport, Conn., USA. 492 pp.

Radostits, O. M., Searcy, G. P., Mitchall, K. G. 1980. Moldy sweetclover poisoning in cattle. Can. Vet. J., 21: 155-158.

Horses

General symptoms of poisoning:

[anemia](#)

[hemorrhage](#)

Notes on poisoning:

See notes under white sweet-clover ([Melilotus alba](#)).

References:

McDonald, G. K. 1980. Moldy sweetclover poisoning in a horse. Can. Vet. J., 21: 250-251.

[Another search?](#)

[Français](#) | [Contact Us](#) | [Help](#) | [Search](#) | [Canada site](#)
[Coming Events](#) | [About CBIF](#) | [Links](#) | [Reports and Publications](#) |
[Home](#)

Date modified: 2003-02-06

[Important Notices](#)



Français	Contact us	Help	Search	Canada site
Coming events	About CBIF	Links	Reports and publications	Home

Canadian Biodiversity Information Facility



Notes on poisoning: yellow toadflax

[Introduction](#)

[Interactive](#)

[All poisonous plants by Botanical name](#)

[All poisonous plants by Common name](#)

[Important WWW Poisonous Plants sites](#)



General poisoning notes:

Yellow toadflax (*Linaria vulgaris*) is an introduced herb that is widely naturalized across Canada. This plant contains several compounds, including glucosides and the cyanogenic glucoside prunasin. The plant is regarded as toxic to livestock in Europe. Cattle generally avoid grazing stands of this plant, but there is more potential for poisoning when the animals are provided with hay that has a high content of yellow toadflax. No definitive records of poisoning are found in the literature. Other members of the genus are found in Canada as well, including the introduced Dalmatian toadflax (*Linaria dalmatica*). For safety's sake, hay should not be fed to livestock if it contains a high content of these plants.

References:

Kingsbury, J. M. 1964. Poisonous plants of the United States and Canada. Prentice-Hall Inc., Englewood Cliffs, N.J., USA. 626 pp.

Sticher, O. 1971. Isolation of antirrinocide from *Linaria vulgaris*. Phytochemistry (Oxf.), 10: 1974-1975.

Nomenclature:

Scientific Name: *Linaria vulgaris* Mill.

Vernacular name(s): yellow toadflax

Scientific family name: *Scrophulariaceae*

Vernacular family name: fringwort

Go to ITIS^{*ca} for more taxonomic information on: [Linaria vulgaris](#)

References:

Agriculture Quebec. 1975. Noms des maladies des plantes du Canada/ Names of plant diseases in Canada. , Quebec City, Que., Canada. 288 pp.

Alex, J. F., Cayouette, R., Mulligan, G. A. 1980. Common and botanical names of weeds in Canada/Noms populaire et scientifiques des plantes nuisibles du Canada. Revised. Agric. Can. Publ., Ottawa, Ont., Canada. 132 pp.

Bailey, L. H., Bailey, E. Z. 1976. Hortus third. Revised. MacMillan, New York, N.Y., USA. 1290 pp.

Scoggan, H. J. 1978, 1979. The flora of Canada. Nat. Mus. Nat. Sci. (Ottawa) Publ. Bot. 7(1)-7(4). 1711 pp.

Van Wijk, H. L. 1911. A dictionary of plant names. Martinus Nijhoff, The Hague, The Netherlands. 1444 pp.

Victorin, M. 1964. Flore Laurentienne. 2nd ed. Univ. Montreal, Montreal, Que., Canada. 952 pp.

Geographic Information

Alberta
British Columbia
Labrador
Manitoba
New Brunswick
Newfoundland
Northwest Territories
Nova Scotia
Ontario
Prince Edward Island
Quebec
Saskatchewan

References:

Bailey, L. H., Bailey, E. Z. 1976. Hortus third. Revised. MacMillan, New York, N.Y., USA. 1290 pp.

Boivin, B. 1966, 1967. Énumération des plantes du Canada. Provencheria 6. Nat. Can. (Que.) 93: 253-274; 371-437; 583-646; 989-1063. 94: 131-157; 471-528; 625-655.

Image or illustration

yellow toadflax:

Images: images.google.com

Toxic parts:

leaves

References:

Sticher, O. 1971. Isolation of antirrinocide from *Linaria vulgaris*. *Phytochemistry (Oxf.)*, 10: 1974-1975.

Notes on Toxic plant chemicals:

Yellow toadflax contains several chemicals, including the cyanogenic glycoside prunasin. It also contains a glucoside, antirrinocide (Sticher 1974; Conn 1981).

Toxic plant chemicals:

antirrinocide

prunasin

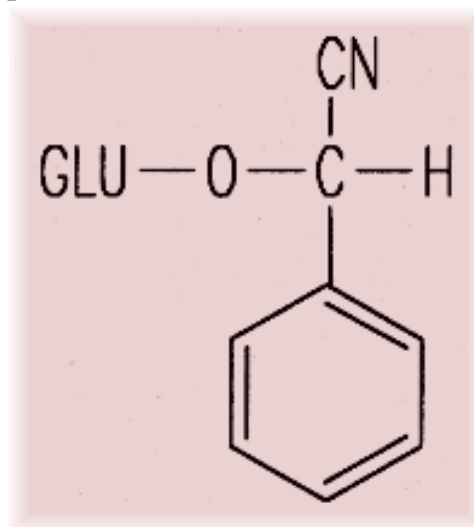

Chemical diagram(s) are courtesy of [Ruth McDiarmid](#), Biochemistry Technician, Kamloops Range Station, Agriculture and Agri-Food Canada, Kamloops, British Columbia, Canada.

References:

Conn, E. E. 1981. Cyanogenic glycosides. Pages 479-501 in Stumpf, P. K., Conn, E. E., eds. *The biochemistry of plants*. Vol. 7. Secondary plant products. Academic Press, New York, N.Y., USA. 600 pp.

Sticher, O. 1971. Isolation of antirrinocide from *Linaria vulgaris*. *Phytochemistry (Oxf.)*, 10: 1974-1975.

Animals/Human Poisoning:

Note: When an animal is listed without additional information, the literature (as of 1993) contained no detailed explanation.

Cattle

General symptoms of poisoning:

[breathing, rapid](#)

[cyanosis](#)

[dyspnea](#)

[gait, staggering](#)

[paralysis](#)

Notes on poisoning:

General symptoms of cyanide poisoning are listed above. These symptoms have not been reported in the literature for ingestion of yellow toadflax. The general symptoms for cyanide poisoning were taken from Kingsbury (1964).

References:

Kingsbury, J. M. 1964. Poisonous plants of the United States and Canada. Prentice-Hall Inc., Englewood Cliffs, N.J., USA. 626 pp.

[Another search?](#)

[Français](#) | [Contact Us](#) | [Help](#) | [Search](#) | [Canada site](#)

[Coming Events](#) | [About CBIF](#) | [Links](#) | [Reports and Publications](#) |

[Home](#)

Date modified: 2003-02-06

[Important Notices](#)