

AT MICROFICHE
REFERENCE
LIBRARY
A project of Volunteers in Asia

Better Freshwater Fish Farming: The Pond

By: FAO Better Farming Series

Published by: Food and Agriculture Organization of the United Nations
Publications Division
Via delle Terme di Caracalla
00100 Rome
ITALY

Available from: Food and Agriculture Organization of the United Nations
Publications Division
Via delle Terme di Caracalla
00100 Rome
ITALY

Reproduced with permission.

Reproduction of this microfiche document in any form is subject to the same restrictions as those of the original document.

better freshwater fish farming

the pond

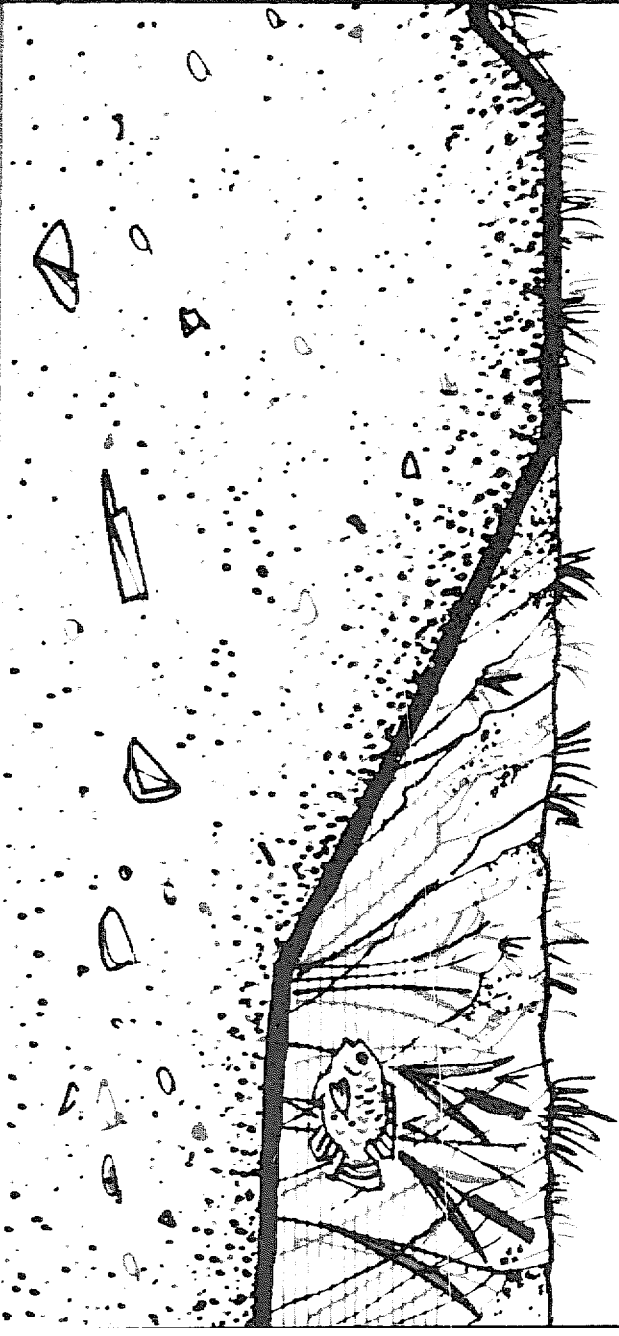

BETTER FARMING SERIES

Twenty-nine titles have been published in this series, designed as handbooks for agricultural education and training. They may be purchased as a set or individually.

FIRST YEAR

1. The plant: the living plant; the root
2. The plant: the stem; the buds; the leaves
3. The plant: the flower
4. The soil: how the soil is made up
5. The soil: how to conserve the soil
6. The soil: how to improve the soil
7. Crop farming
8. Animal husbandry: feeding and care of animals
9. Animal husbandry: animal diseases; how animals reproduce

SECOND YEAR

10. The farm business survey
11. Cattle breeding
12. Sheep and goat breeding
13. Keeping chickens
14. Farming with animal power
15. Cereals
16. Roots and tubers
17. Groundnuts
18. Bananas
19. Market gardening
20. Upland rice
21. Wet paddy or swamp rice
22. Cocoa
23. Coffee
24. The oil palm
25. The rubber tree
26. The modern farm business
27. Freshwater fish farming: how to begin
28. Water: where water comes from
29. Better freshwater fish farming: the pond

**Better
freshwater
fish farming**

the pond

First printing 1981

P-69

ISBN 92-5-101127-3

© FAO 1981

PREFACE

The FAO Better Farming Series is essentially based on the **Cours d'apprentissage agricole** prepared in the Ivory Coast by the **Institut africain de développement économique et social** for use by extension workers in contact with illiterate or semi-literate farmers. The approach is deliberately a general one, the intention being to constitute basic prototype outlines, to be supplemented in each area according to local conditions of agriculture.

Many of the booklets deal with specific crops, while others, such as this one, are intended to give the farmer information concerning the general agricultural context, and thus to allow him to gain some understanding of **why** he does what he does so that he will be able to do it better.

Adaptations of the series, or of individual volumes in it, have been published, among others, in Amharic, Arabic, Bengali, Creole, Hindi, Igala, Indonesian, Kiswahili, Malagasy, SiSwati and Turkish. This impressive list is some indication of the success and also of the value of the series. This volume has been prepared by the Inland Water Resources and Aquaculture Service, Fishery Resources and Environment Division of the Food and Agriculture Organization of the United Nations.

Requests for permission to issue this manual in other languages and to adapt it according to local climatic and ecological conditions are welcomed. They should be addressed to the Director, Publications Division, Food and Agriculture Organization of the United Nations, Via delle Terme di Caracalla, 00100 Rome, Italy.

OUTLINE OF THE COURSE

● Improving your fish farm	3
● Planning a bigger pond	7
Where to put your pond	7
Water	7
Place	9
Soil	10
Testing soil	11
How large should your pond be?	14
● Building a bigger pond	18
How to make your old pond bigger	18
How to build a new, bigger pond	20
The inlet	29
The outlet	31
A better outlet	34
The overflow	35
A siphon	38
Screens	41

IMPROVING YOUR FISH FARM

1. You have already built the small pond described in Booklet No. 27, **Freshwater fish farming: how to begin**, and you have grown many fish in it.

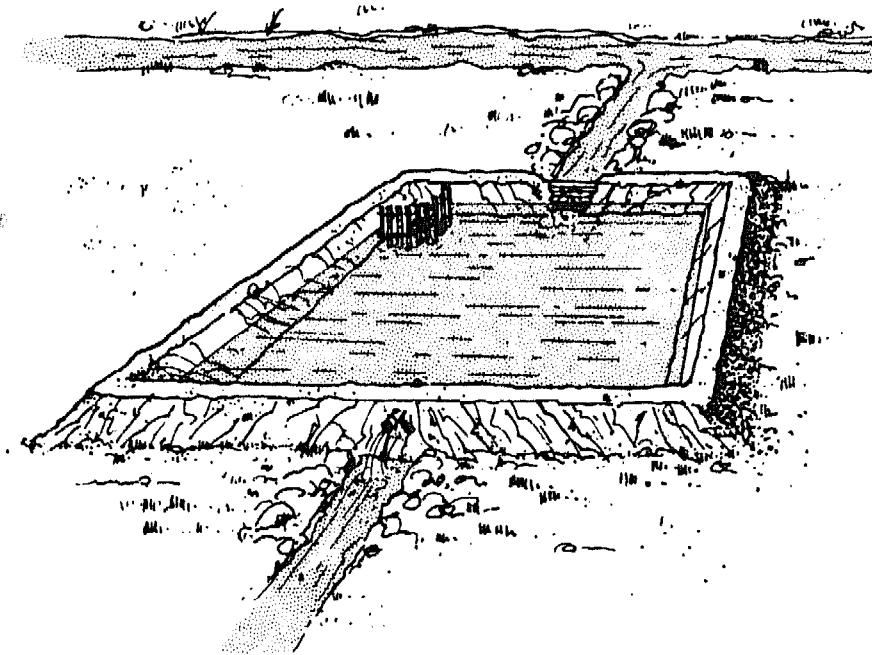

2. Your family would like to have more fish to eat, and you have learned at the market that you can sell more fish if you have them.
3. You would like to grow more fish to eat and to sell at the market so that you and your family can live better. Growing more fish is improving your fish farm.



4. You can improve your fish farm by making your old pond bigger. If your old pond was 10 by 10 metres, you can make it twice as big by moving some of the banks. You can make it 10 by 20 metres.

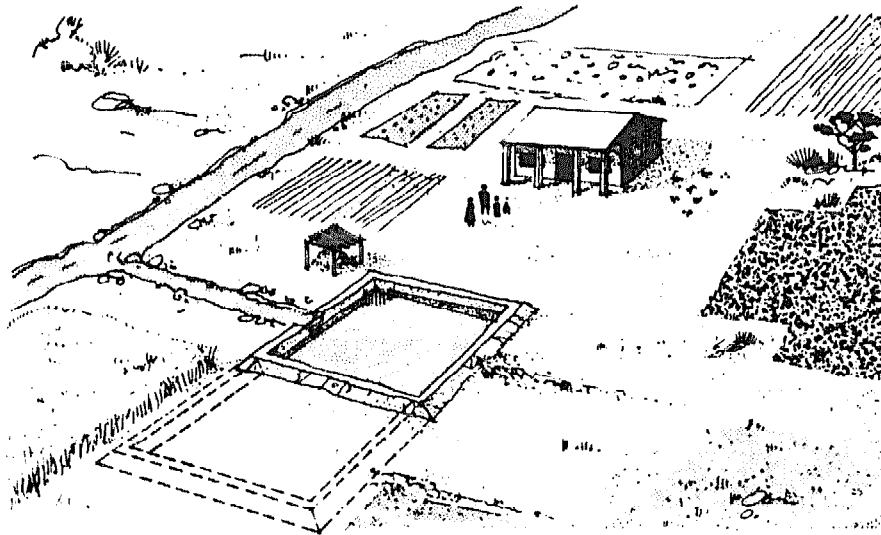

5. You can improve your fish farm by building a new, bigger fish pond either next to your old pond

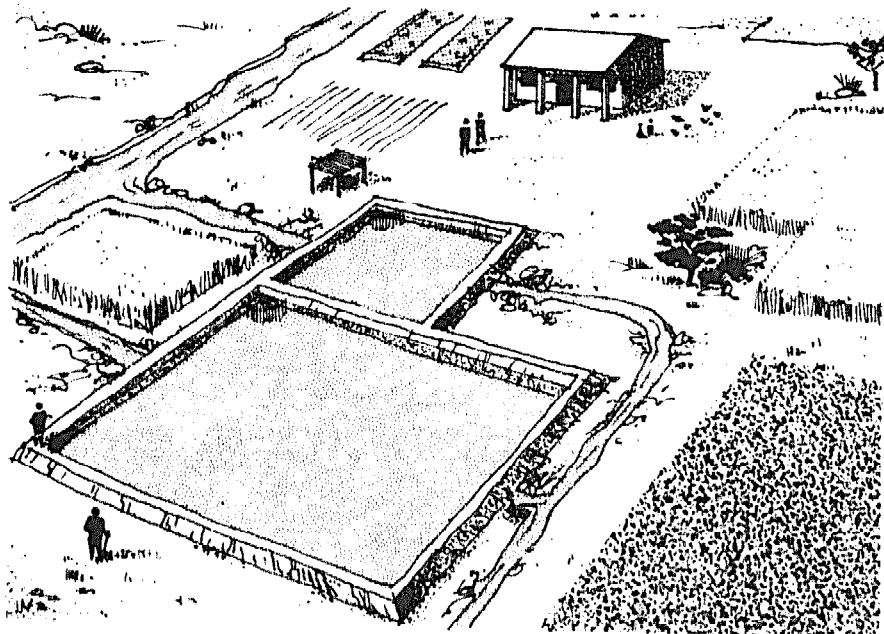

or in another place.

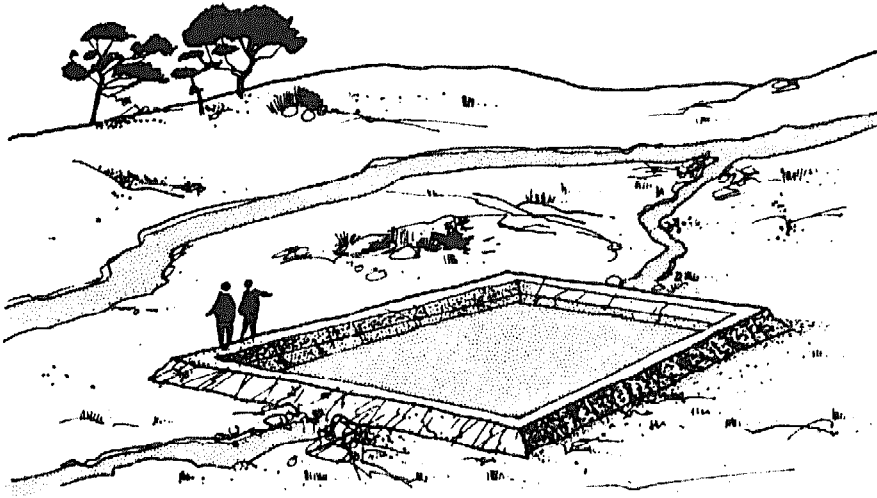

You can improve your fish farm by building more than one pond.

6. But start slowly and carefully. First, build only one new pond. After you have built your first bigger pond and you know how to use it to grow more fish, you can build more ponds and grow fish all year round.
7. After you have built one or more new, bigger ponds, you will need more baby fish than you did before. You may decide to grow your own baby fish so that you will have them when you need them.
8. This is another way of improving your fish farm. You will learn more about it in Booklet No. 30.

9. Before you begin
to improve your fish farm,
you must be sure that:

- you have enough
of the right kind of land

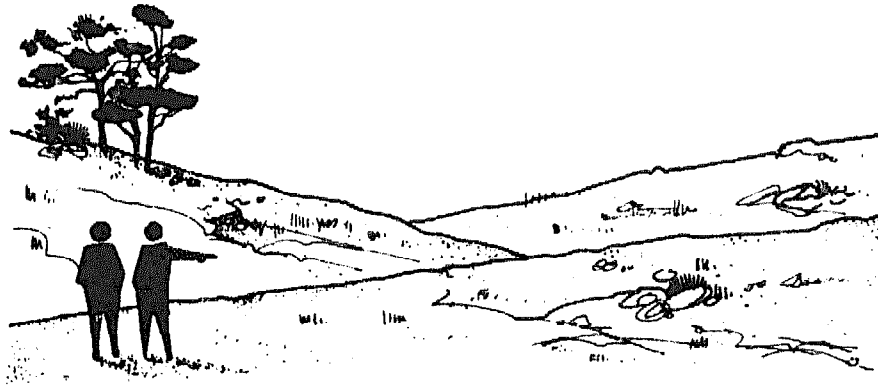

- you have enough good water near by

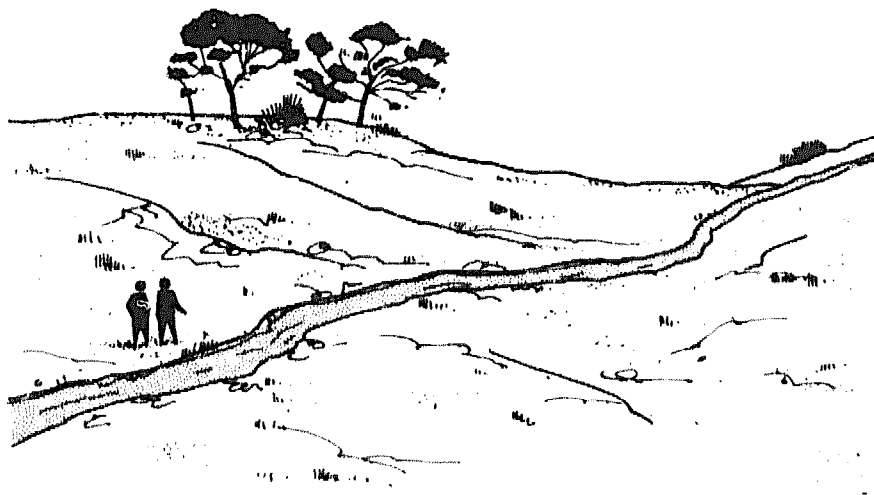

- you and your family have enough time
to work a bigger pond or more ponds.

PLANNING A BIGGER POND

Where to put your pond

10. If your old pond was in the right place and you have enough water and enough good land there, you can make your old pond bigger or you can build one or more new ponds in the same place.
11. If there is no room or not enough water near your old pond, you will have to choose another place for your new pond. You must choose the new place very carefully.

Water

12. Your new pond must be near a good supply of water such as a spring, stream, lake or reservoir with plenty of water all year round.

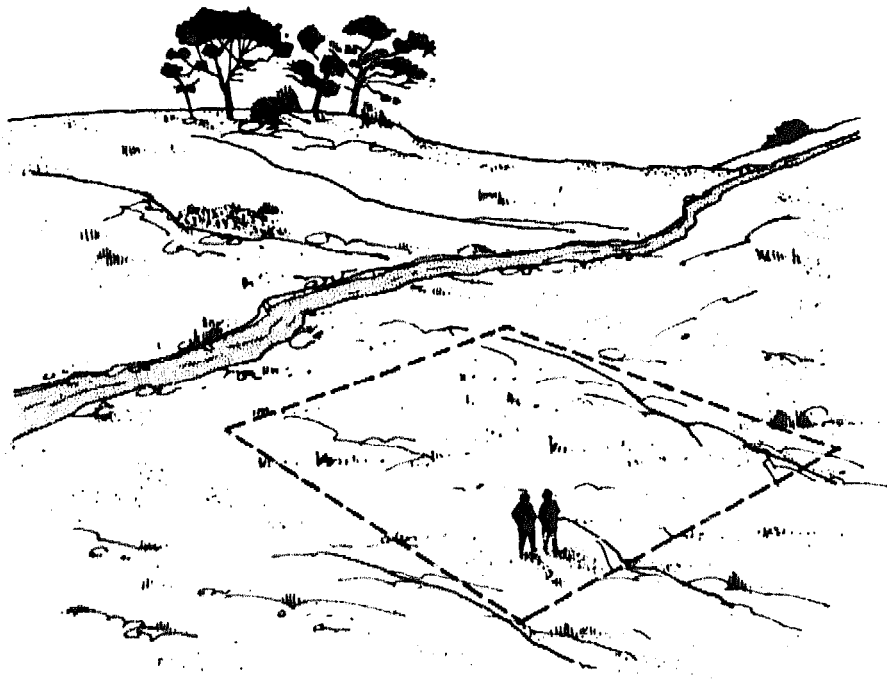

13. You must be sure that you have enough water to fill your pond when it is time to fill it and to add more water when you need it.
14. Do not depend on rain-water to fill your pond. When it does not rain, there may not be enough water to keep your pond full and the fish may die.

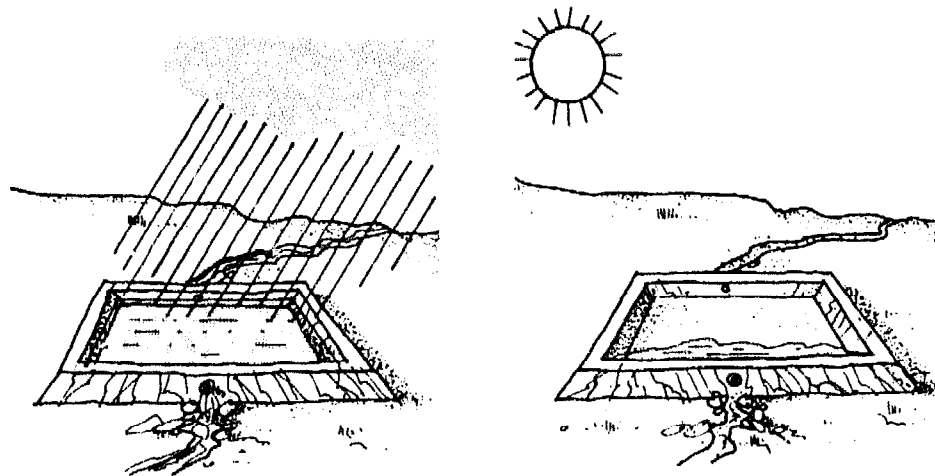

15. Your water must come from a place that is higher than the pond so that the water will flow into the pond by itself.

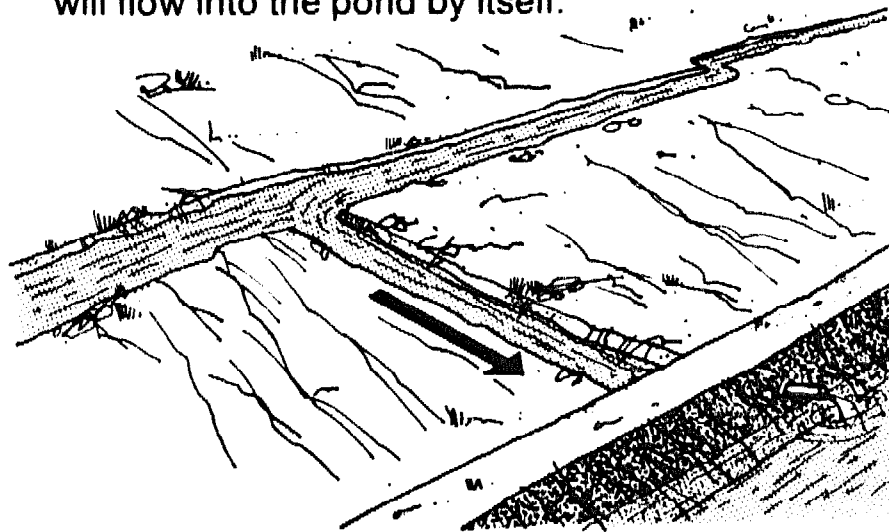

16. The water should not have a bad smell, taste or colour. It should not be too muddy.

17. The water should not have wild fish in it.
You do not want wild fish in your pond because they may eat your fish or keep them from growing.
18. Water from a natural spring close to the pond site is usually good and there will not be wild fish in it.
19. Water from a stream or from a lake or reservoir is usually good but it may have wild fish in it. You will have to be careful that the wild fish do not swim into your pond.

Place

20. It is best to put a pond in a place with a slope or on a hillside because you will not have to dig as much soil to build it. A pond built on a slope is also easier to drain.

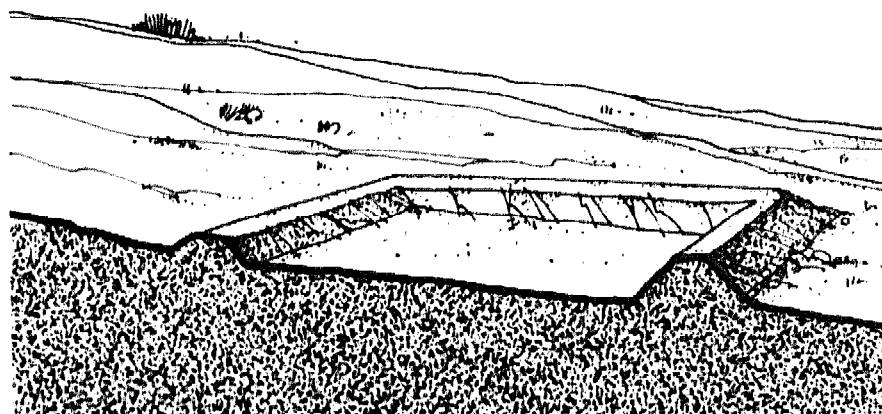

21. Do not build your pond in a place that is so low that it is flooded during the rainy season.

Soil

22. The soil where you build your pond should not be too sandy.
Soil with too much sand or gravel in it will not hold water.
23. In sandy soil the water will sink into the ground and there will not be enough water for your fish.

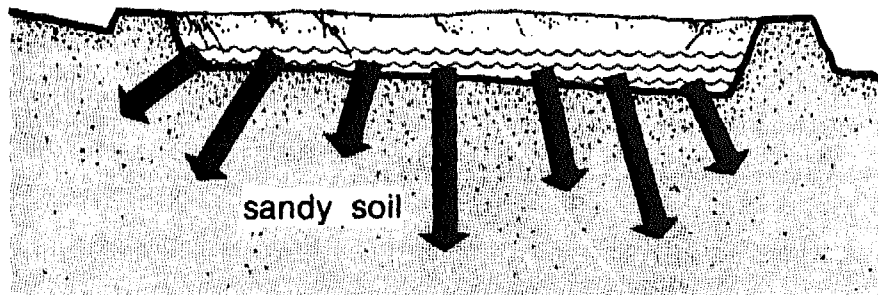

24. If the banks of your pond are built of sandy soil, they will not be strong enough to keep the water from flowing away.
25. The soil where you build your pond should have enough clay in it.
Clay soil holds water very well.
26. In clay soil, very little water will sink into the ground, and banks of clay will be strong enough to hold the water in the pond.

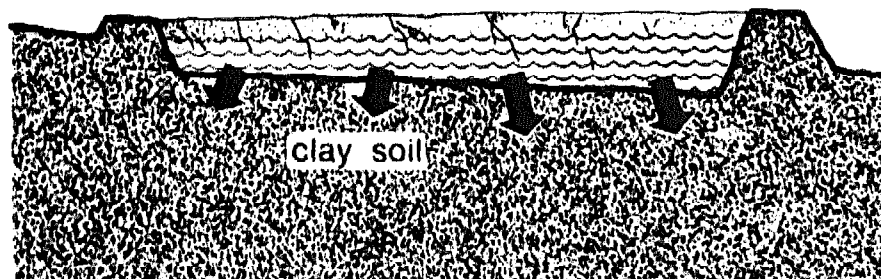

Testing soil

27. You should test the soil to see if it is good for building a pond.
28. The **first test** is easy. Take a handful of soil from the surface and squeeze it into a ball.



29. Throw the ball of soil into the air and catch it.



30. Bad soil with too much sand or gravel in it will not stick together and the ball will fall apart.
31. If the ball sticks together well, the soil may be good but you cannot be sure. Now you should make a **second test** to be sure that the soil is good.

32. Dig a hole as deep as your waist.



Early in the morning
fill it with water.
Fill it to the top.

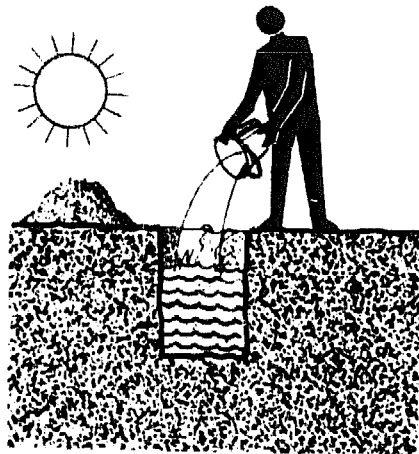

33. By evening some of the water
will have sunk into the soil.

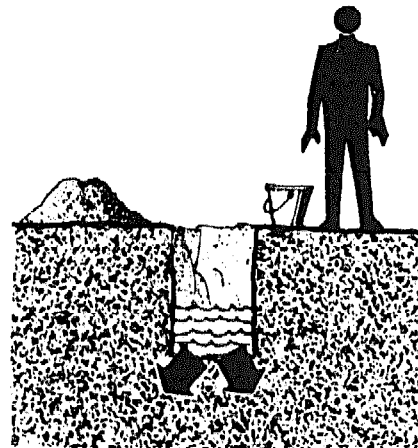

34. Then fill the hole with water again.
Fill it to the top.
Cover the hole with boards
or leafy branches.

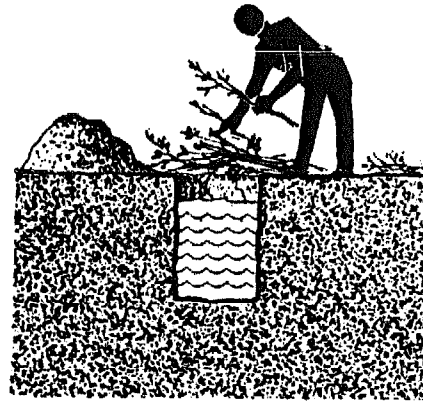

35. The next morning
if most of the water
is still in the hole,
the soil will hold enough water
to build a fish pond there.

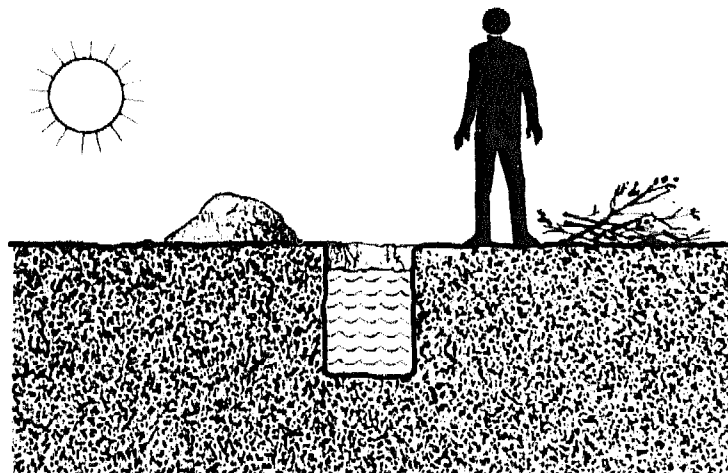

How large should your pond be?

36. It is good to start with a pond about twice as big as your old pond.
- 37 For example, if you build a pond 15 by 15 metres, the pond will measure about 225 square metres.

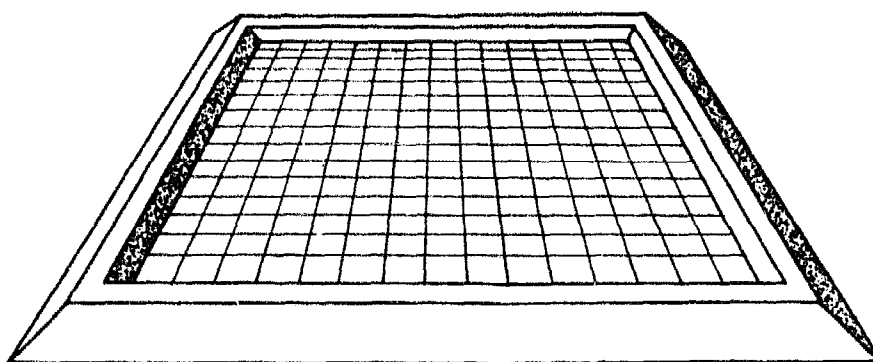

$$15\text{m} \times 15\text{m} = 225\text{m}^2$$

Your old pond measured 100 square metres.

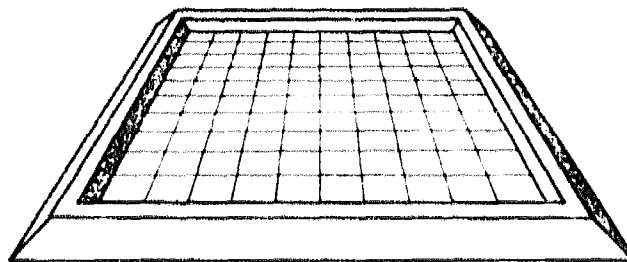

$$10\text{m} \times 10\text{m} = 100\text{m}^2$$

38. A square pond is easier to build,

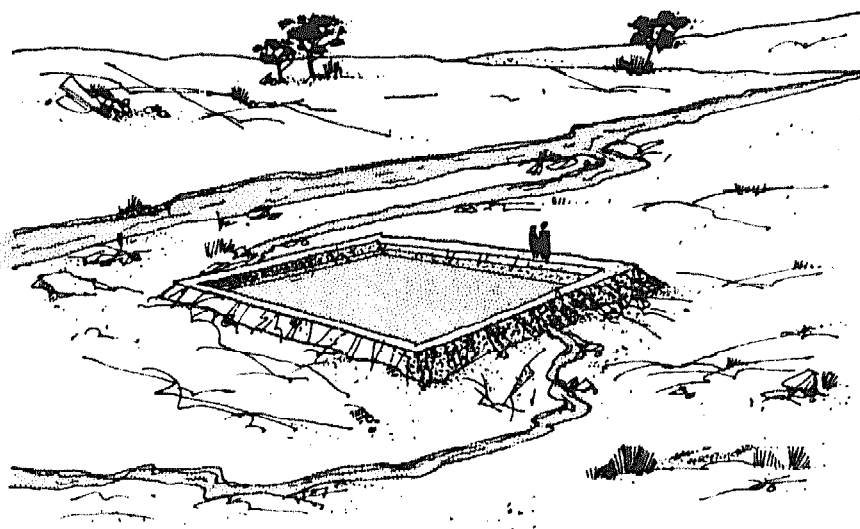

but your pond can have a different shape to fit the size and shape of your land.

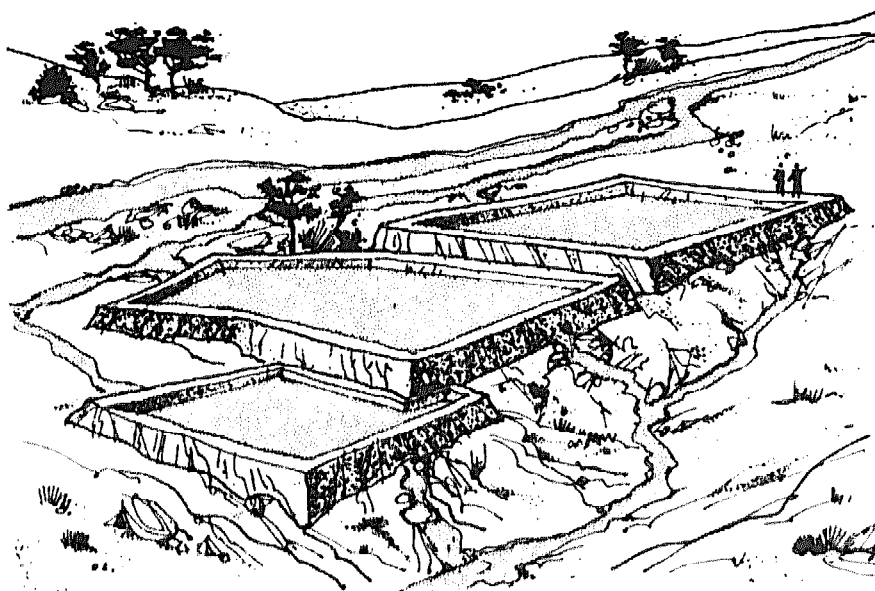

39. This book will tell you how to make your old pond bigger. Then it will tell you how to build a new, square pond measuring 15 by 15 metres.
40. When you build a bigger pond, you should try to make it better than your old pond.
41. A bigger pond should have:
- an inlet to let the water into the pond, which should have a screen to keep out wild fish, twigs, leaves and other trash;

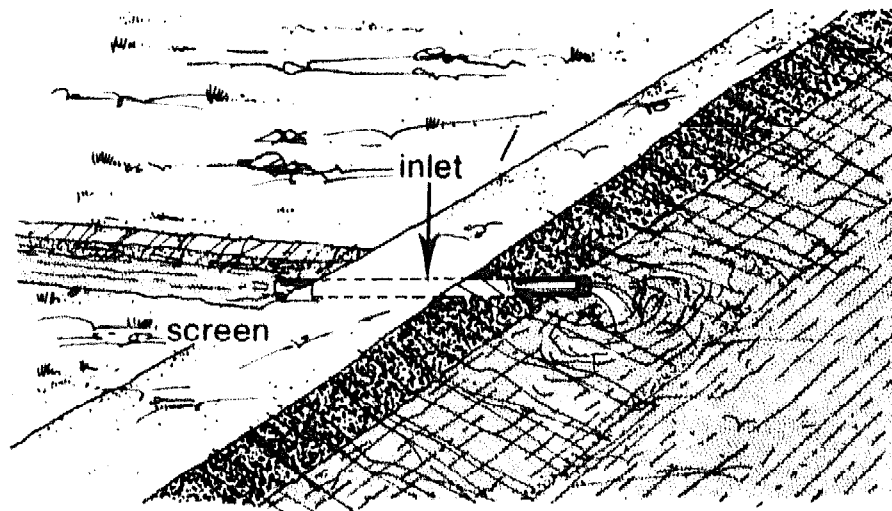

- an outlet to let the water flow out of the pond so that you can take out all the fish and clean the pond, the outlet having a screen to keep your fish from getting away when you drain the pond;

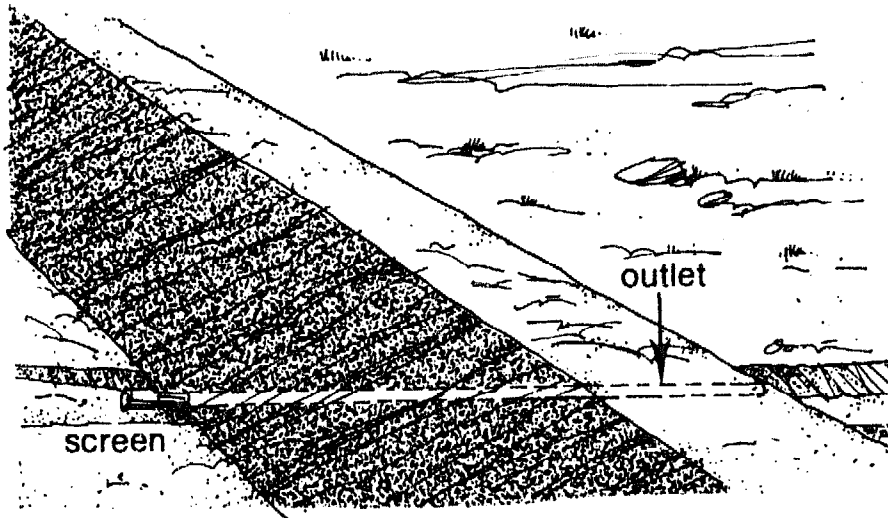

- an overflow
to let some of the water flow away
when there is too much water in the pond.
If there is too much water in the pond,
some of the water may flow over the banks
and some of your fish may get away.
The overflow should have a screen
to prevent this happening.

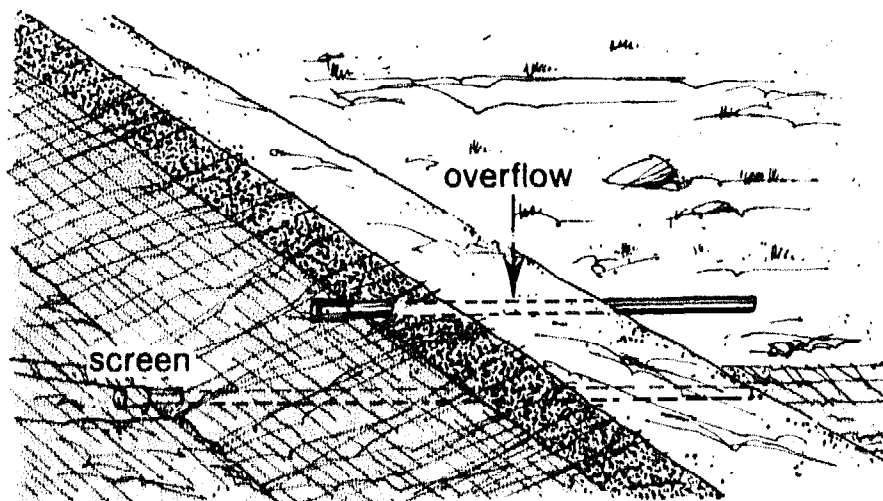

BUILDING A BIGGER POND

How to make your old pond bigger

42. The easiest way to make your old pond bigger is to build a new, small pond next to your old pond.

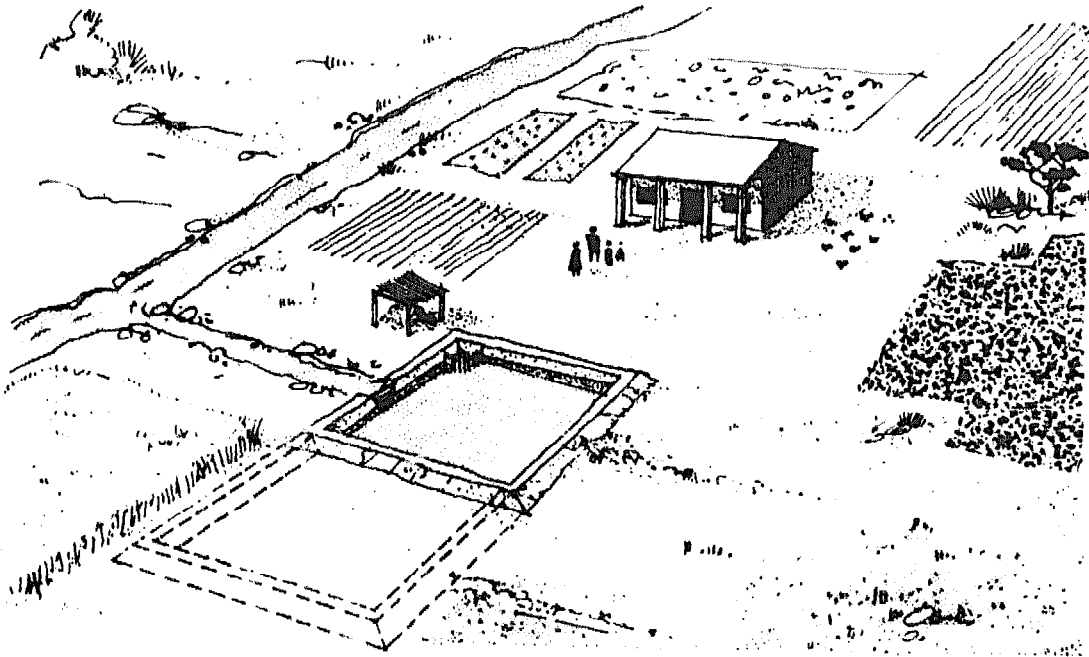

43. Build the new pond in the same way that you built the old pond.
Booklet No. 27 tells you how to do it.
44. In building the new pond, take away one side bank of the old pond and use the earth to build the new banks.

45. **You will not need** to make a new inlet for your new pond because the old one in the old part of the pond is all you will need.
46. **You will need** to make a new outlet in your new pond to let the water flow from the old part of the pond into the new part of the pond.
47. **You will also need** to make an overflow for the new pond. The old pond did not have one.
48. The drawing shows you where to put the new outlet and how the water should flow and where to put the overflow. You will learn how to build an outlet and an overflow later in this book.

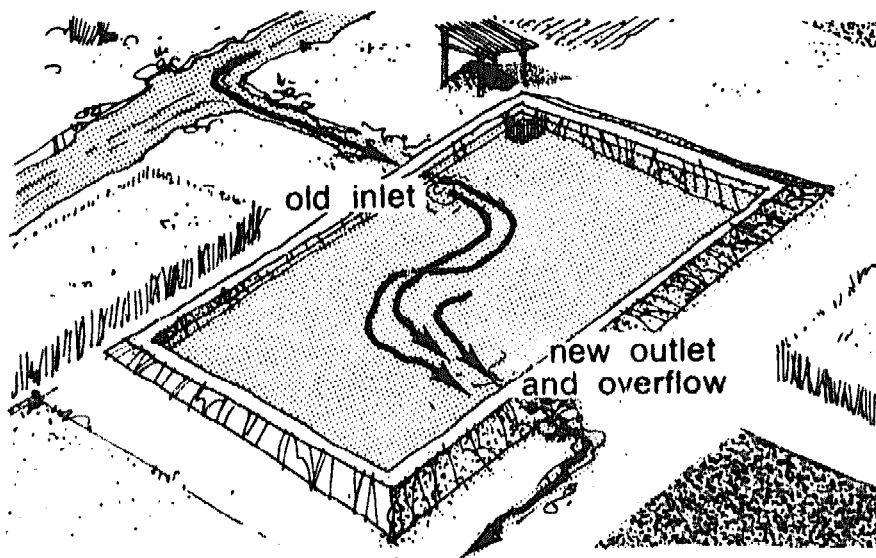

How to build a new, bigger pond

49. There is much more work to do when you build a big pond than when you build a small pond
50. First mark out a big square on the site you have chosen, about 21 by 21 metres. Mark the corners with pegs and run a string between the pegs to show you where the outside of the banks will be.
51. Clear the big square of all trees, bushes and grass and take away all the big roots you can.

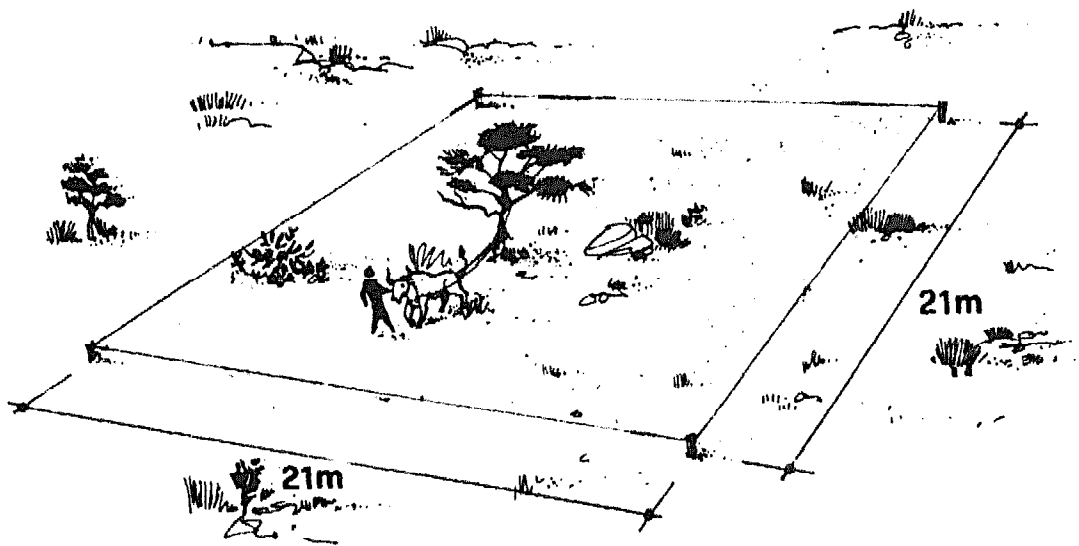

52. Take away about 20 centimetres of topsoil from all over the square. Put the topsoil aside. Later you will put it back on the top and outer sides of the banks.

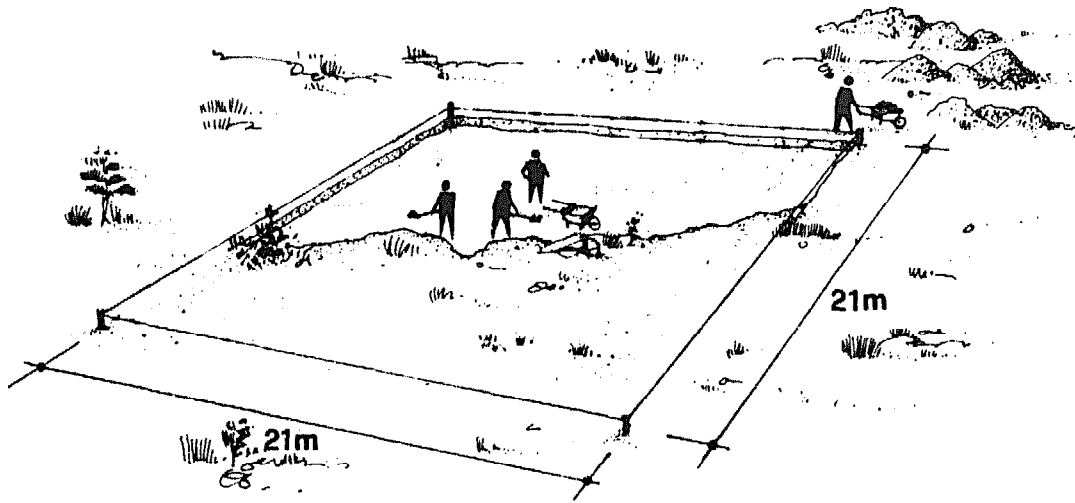

53. Then mark out a small square inside the big square, about 15 by 15 metres. Mark the corners with pegs and run a string between the pegs to show you where the inside of the banks will be.

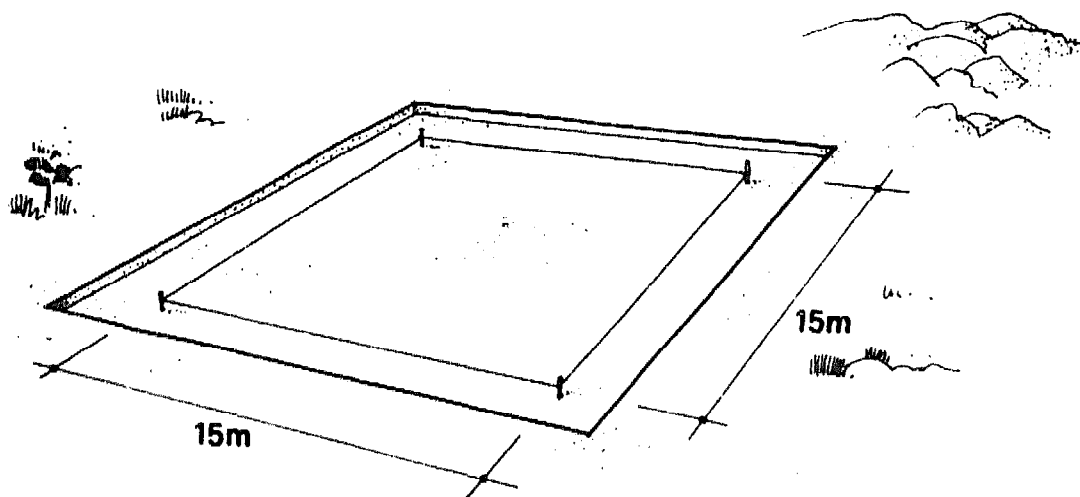

54. The bottom of the bank in the shallow part of your pond and along the sides should be about 1 metre from the upper end and sides of the small square.
55. The bottom of the bank in the deepest part of your pond should be about 2 metres from the lower end of the small square.
56. Now mark out a third smaller area in the centre of your pond, about 12 by 13 metres. We will call this the central area. Mark the corners with pegs and run a string between the pegs to show where the bottom of the banks will be.

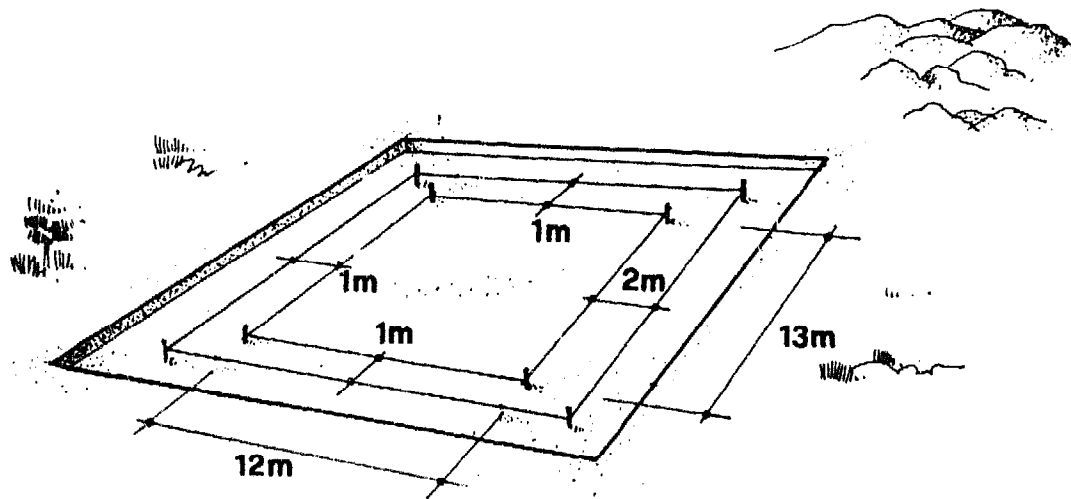

57. Be sure that all the pegs and strings marking the 21-metre square, the 15-metre square and the central area are set up in the way shown in the drawings.

58. Now you are ready
to begin digging out soil
from inside the central area
to build the banks of your pond.
59. Ask your neighbours to help you
to dig your big pond.
Then you can help them in turn
to dig their ponds.

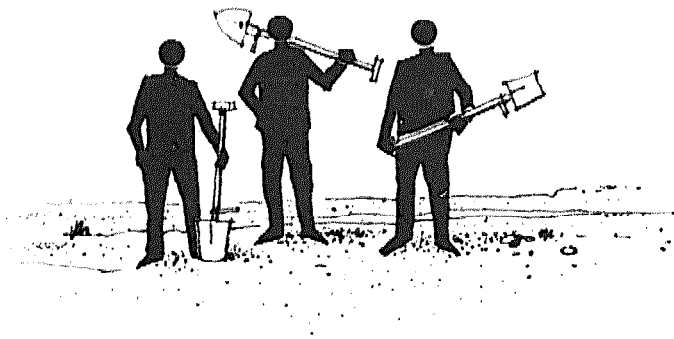

60. Shared work is lighter work.
When we work together
with our neighbours,
the work is easier and better.
61. Begin digging at the 1-metre string
marking the central area
at the upper end of your pond.
Dig about 20 centimetres deep.
As you dig toward the lower end,
dig a little deeper.
When you get to the deepest part,
at the 2-metre string
marking the central area,
you should be digging
about 30 centimetres deep.

62. As you dig out the soil, put it between the 15 by 15-metre square and the 21 by 21-metre square where the banks will be. Put it nearest to where you are digging. This way, the banks will be higher and wider as you move toward the lower end.

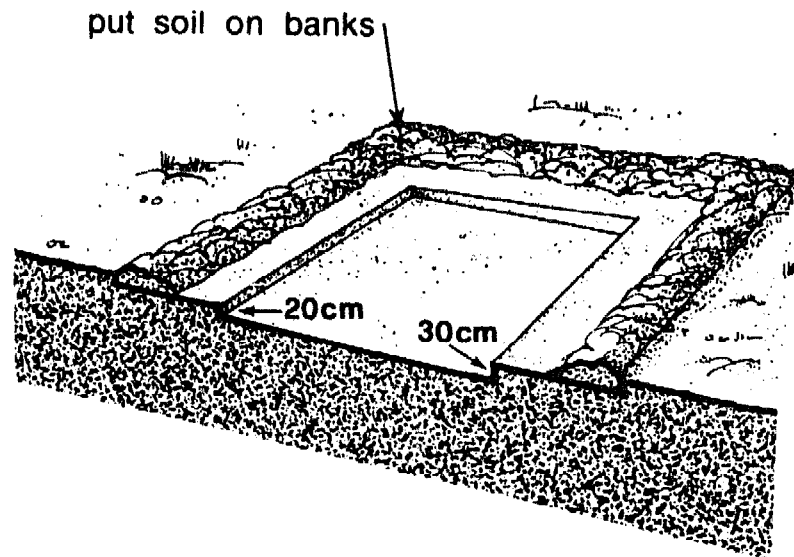

63. When you come to roots, take away as much of them as you can.

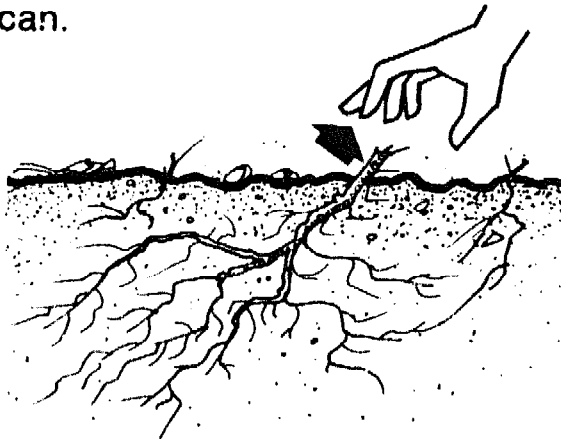

64. Whenever the loose soil you put on the banks reaches half as high as your knees, pack it down tightly. You can do this by beating the soil with a heavy plank, a length of tree trunk or an earth tamper.

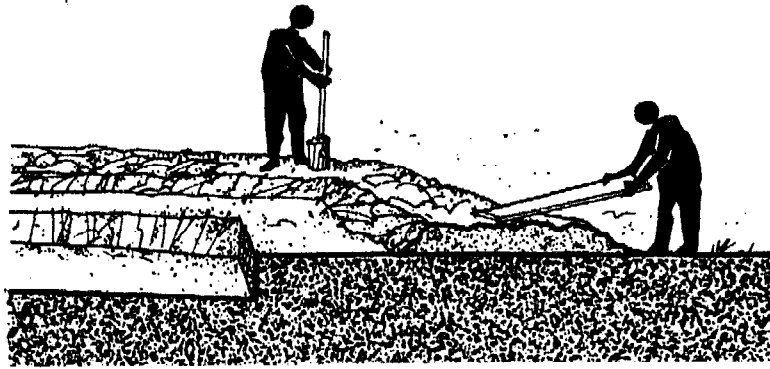

65. When you are digging, keep the slope of the pond bottom as regular as you can. It should slope gently down from the upper end to the deepest part. The bottom of the pond should have slopes like those in the drawings.

66. Begin again to dig soil out of the central area. Dig 20 more centimetres from the upper end and 30 more centimetres from the deepest part. Put the soil on the banks and pack it down tightly as before.

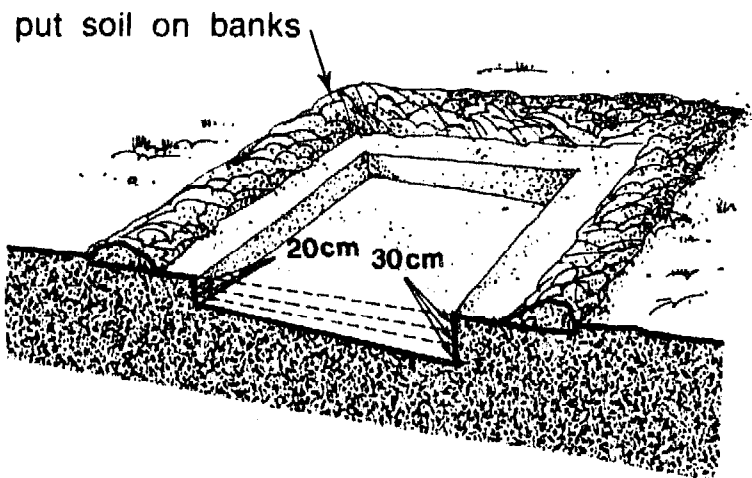

67. Now begin again, for the third and last time, to dig soil out of the central area. Dig 20 more centimetres from the upper end and 30 more centimetres from the deepest part. Put the soil on the banks and pack it down tightly.

68. When you have finished digging out the central area and you have put on the banks all the soil that you have taken out, you will have a hole 12 by 13 metres with straight sides. Now it is time to shape the banks.
69. Dig the soil away from the edges of the central area to form the slope of the banks. Put this soil on top of the banks and pack it down tightly.

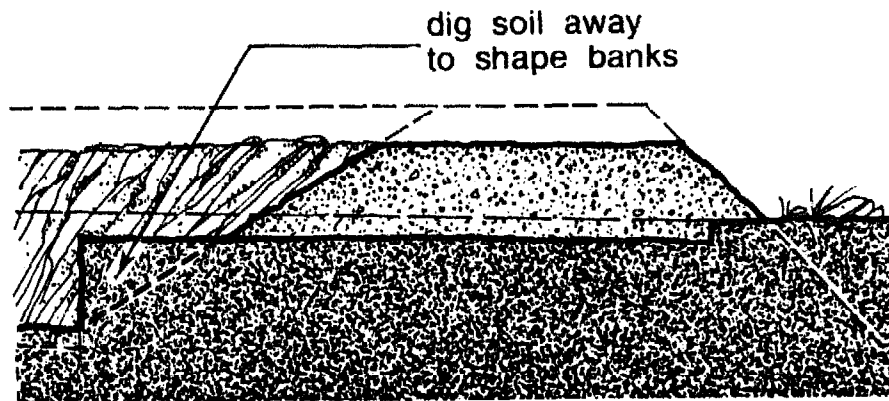

70. The inside of the banks should slope less steeply than the outside. The drawing shows you what the banks should look like when they are finished.

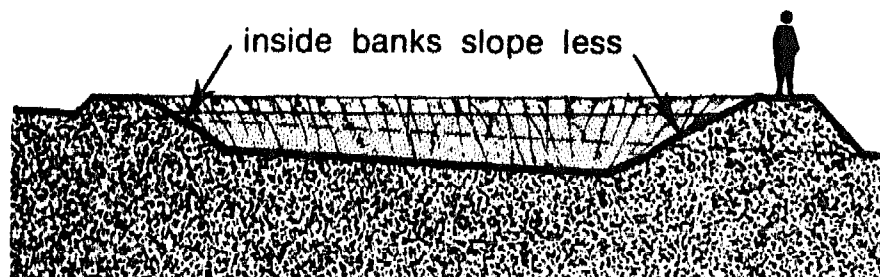

71. The top of the banks should be about 1.5 metres wide and should be straight and flat all the way around the pond.

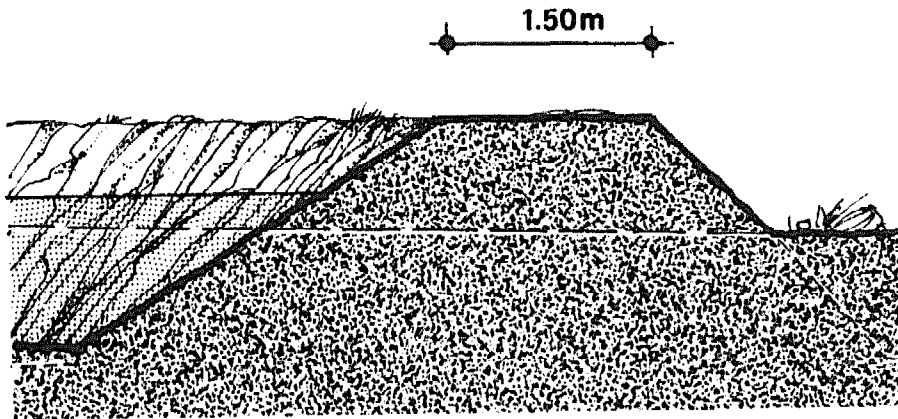

72. Put the 20 centimetres of topsoil you took away when you began digging on the top and outer sides of the banks. Plant grass on the banks. Banks covered with grass last longer.
73. The bottom of your pond should be about 1.10 metres from the top of the banks at the shallow upper end and about 1.40 metres from the top of the banks at the deepest part.

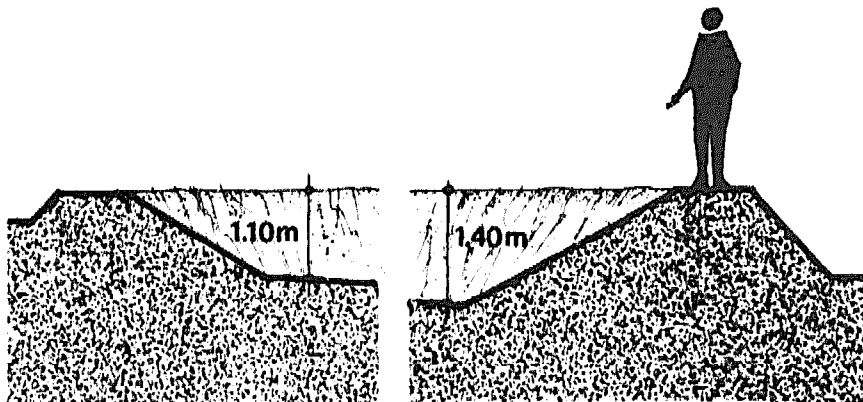

74. Be sure that the bottom of the pond is fairly smooth and regular.

75. Now dig a ditch
in the bottom of the pond
from the centre to the lower end.
The ditch should be
about 50 centimetres wide
and about 20 centimetres deep.
This ditch will help
to drain out all the water
when you empty your pond.

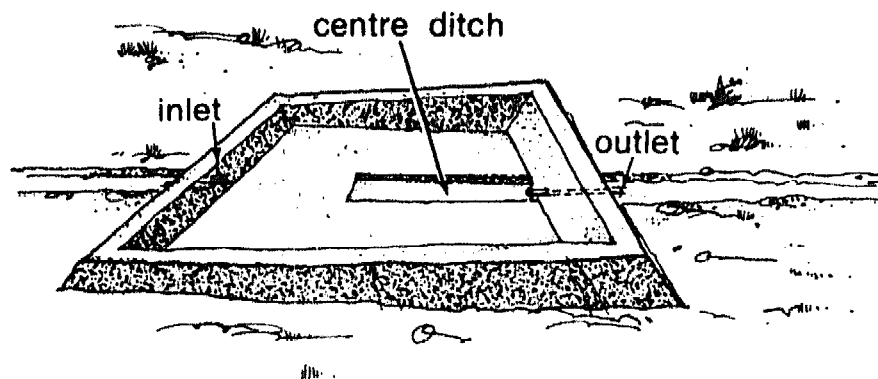

76. When the ditch is finished,
remove all loose soil and other trash
from the bottom of the pond.

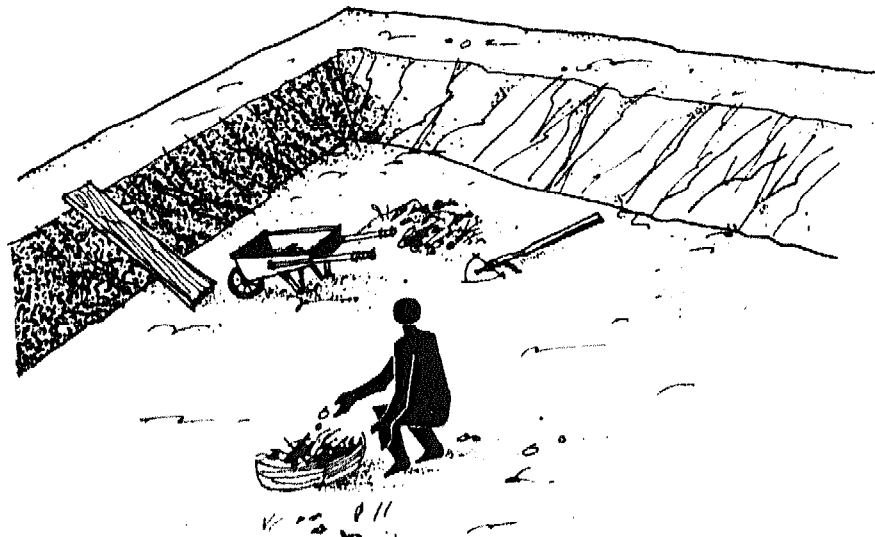

77. Now you are ready
to install your inlet,
outlet and overflow.

The inlet

78. You will need an inlet to let water into your pond when you want to fill it.
79. You should place the inlet at the point nearest to the water supply. Most often this will be at or near the **upper end** of your pond.



80. Your inlet can be made from a piece of heavy bamboo or a pipe of plastic or metal. The inlet pipe should be about 10 centimetres in diameter.

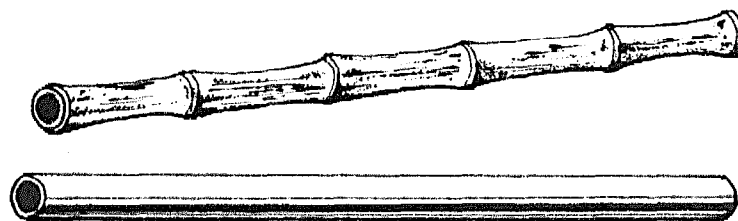

81. The inlet pipe should be long enough to reach through the top of the bank from one side to the other. You will need a pipe about 3 metres long to reach through the bank at the upper end of your pond.

82. Now dig a gap in the bank where you want the inlet to be. It should be a little above the water-level on the inside of your pond and a little below the level of the water which flows from the source on the outside of your pond.

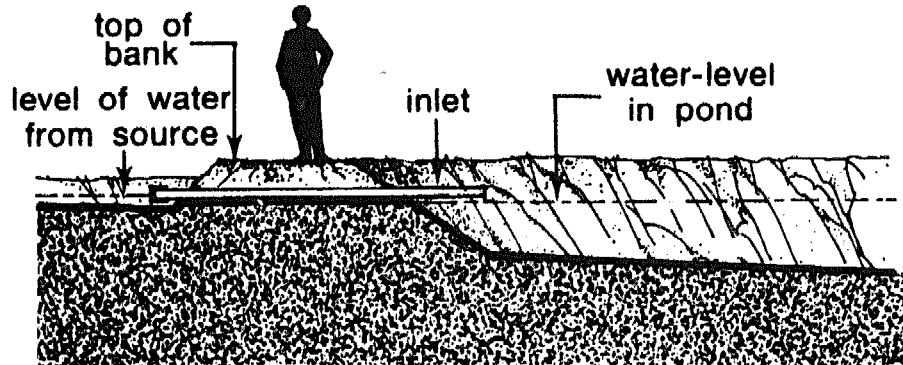

83. Put the inlet pipe in the gap in the bank and rebuild the bank over it.
84. You can also make an inlet by cutting a shallow trench through the bank to let the water into the pond.
85. If you use a shallow trench to get water into your pond, you can improve it and keep it from washing away by using a trough of roofing metal to line the bottom of the trench.

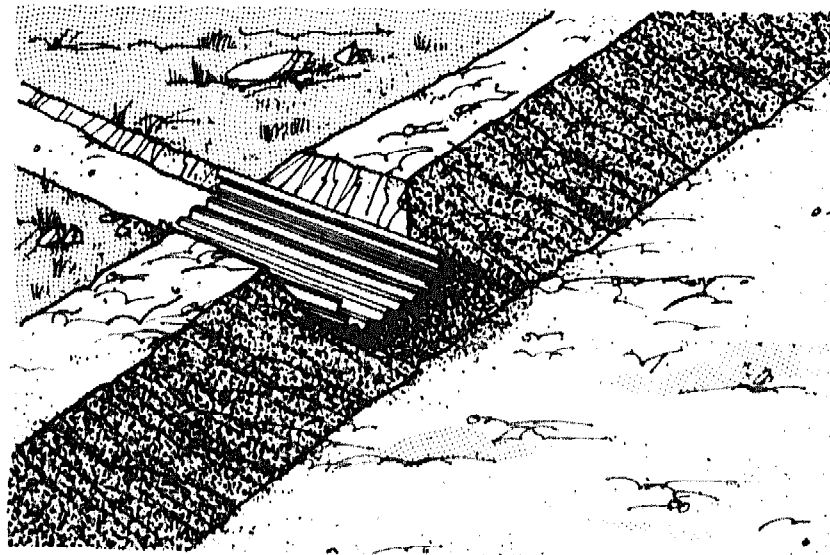

The outlet

86. You will need an outlet to let water out of your pond when you want to empty it.
87. You should place the outlet at the bottom of the bank at the **lower end** of your pond at the **deepest part**.

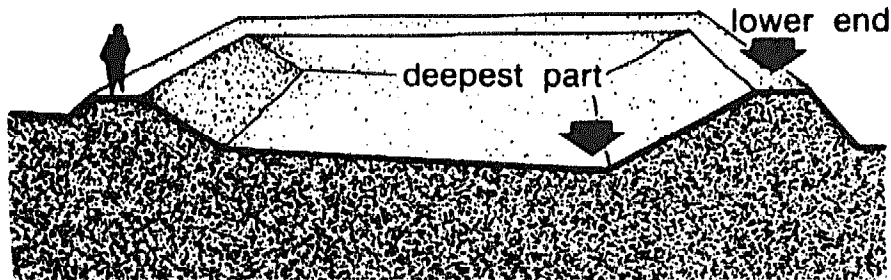

88. The outlet can be made from a piece of heavy bamboo or a pipe of plastic or metal. The outlet pipe should be about 10 centimetres in diameter. The bank of your pond is much wider at the lower end than at the upper end, so the outlet pipe will have to be longer than the inlet pipe.



89. The outlet pipe should be long enough to reach through the bottom of the bank from one side to the other. You will need a pipe about 6.5 metres long to reach through the bank at the lower end of your pond.

90. If you cannot get a pipe that is long enough to go through the bank, you can join shorter pieces of pipe together using straight pieces of pipe like the ones in the drawing.

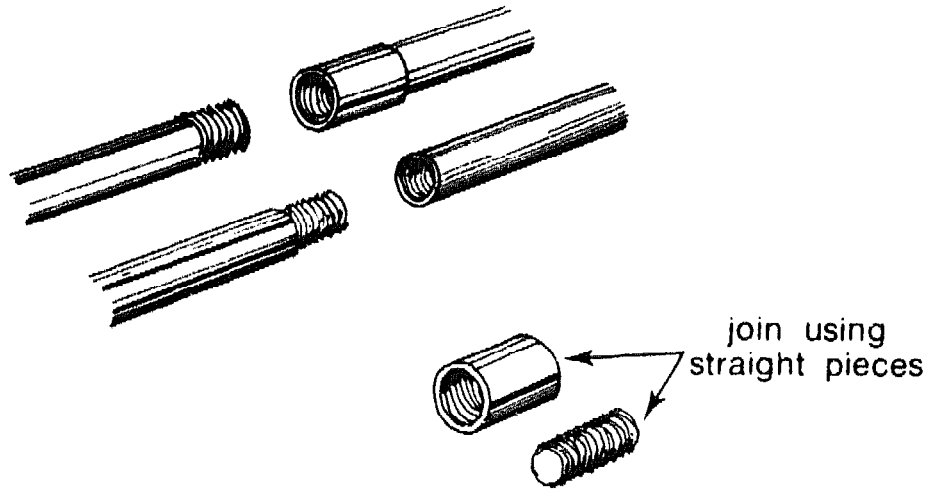

91. If you are using bamboo, you can join short pieces of bamboo together with pieces of smaller bamboo in the centre, but the smaller pieces should be at least 8 to 9 centimetres in diameter. Wrap the bamboo joints with rope and close them with tar to keep water from seeping out.

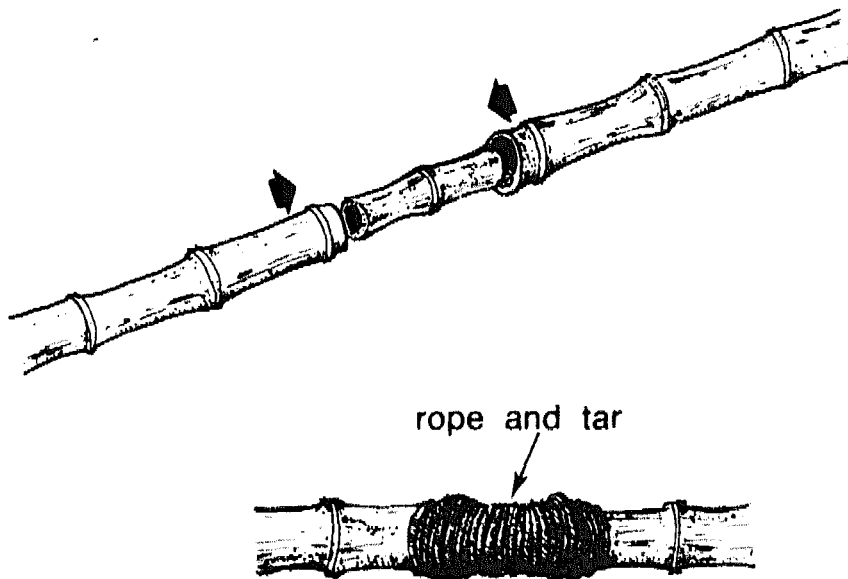

92. Now dig a gap in the bank where you want the outlet to be. It should reach from the deepest part on the inside of the pond through the bank to the outside of the pond.

93. If the outlet pipe is below ground level on the outside of the pond, you will have to dig a ditch to take the water away from the outlet.

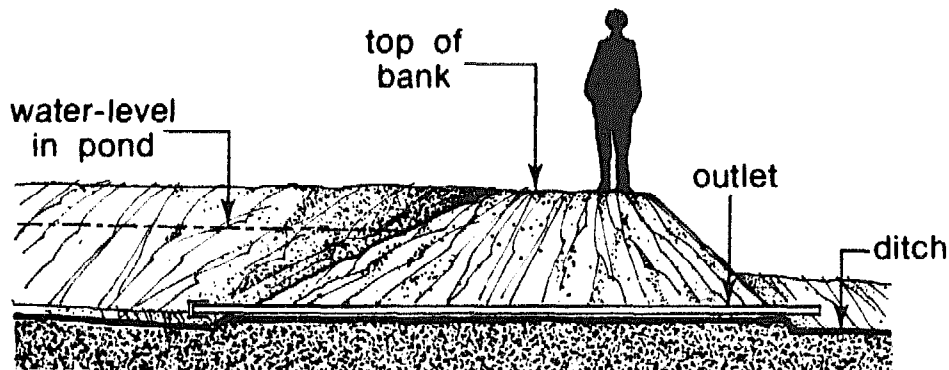

94. Put the outlet pipe in the gap in the bank and rebuild the bank over it.

95. If you use an outlet of about 10 centimetres in diameter, it will take about half a day to empty your pond.

96. It is easier to place the outlet where you want it to be before you dig out the centre of the pond and build the banks. When you build another pond, you will understand this and you will be able to do it when you are building the banks. But now, when you are building your first pond, you should place the outlet in the way you have just learned in this booklet because it is easier to understand.

A better outlet

97. If you use a plastic or metal pipe for the outlet of your pond, you can make it better by putting an upright length of pipe on the end of the outlet using an L or a T piece like the ones in the drawing. Close the T piece with a plug as shown.

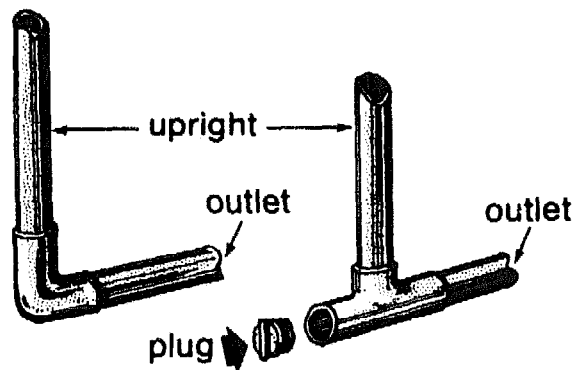

98. Put the L or T piece and the upright pipe on the end of the outlet outside the pond, but protect it so that it cannot be reached by animals or other people.
99. The top of the upright pipe should reach about 3 to 5 centimetres above the water-level of your pond. If the water rises above this level, it will overflow from the upright pipe.

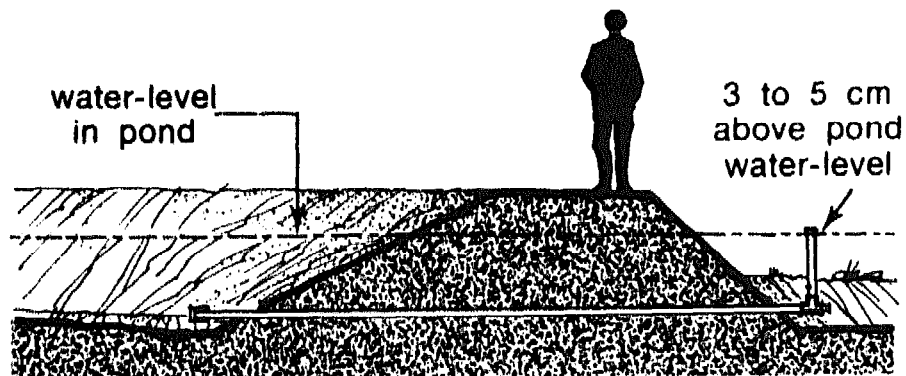

100. Tie the upright pipe to a pole which has been pounded into the ground so that it will not slip down and let the water out of the pond before you want it to.
101. When you want to let out the water, untie the upright pipe and push it down. The water will then flow out of the pond.

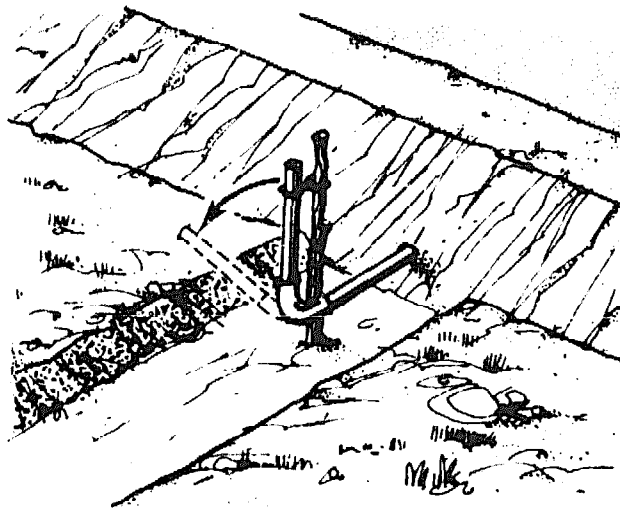
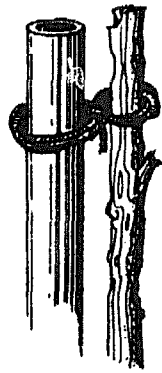

102. There is still another way to let water out of your pond, using a siphon. You will learn how to use a siphon in Items 114-124.

The overflow

103. If there is too much water in your pond, some of the water may flow over the banks. This may wash the banks away and some of your fish may get out.
104. You can use an overflow to keep the water in your pond from rising over the banks.

105. The better outlet you learned about in Items 97-101 will act as an overflow.
106. If you use a straight pipe outlet or a siphon to let water out of your pond, you will need another kind of overflow.
107. This kind of overflow can be made from a piece of bamboo or a pipe of plastic or metal. The overflow pipe should be about 6 centimetres in diameter.
108. The overflow pipe should be long enough to reach through the top of the bank from the inside of the pond to a place far enough on the outside to keep overflow water from washing away the bank. You will need a pipe about 4.5 metres long to do this.
109. If you cannot get a pipe that is long enough, join short pieces of pipe or bamboo together. (see Items 90 and 91).
110. It is best to place your overflow in the bank at the **lower end** of your pond right above the outlet so that the water that overflows can run off in the outlet ditch.

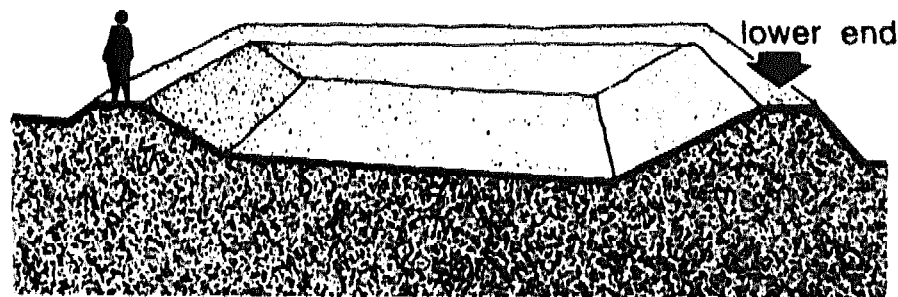

111. If you are going to put the overflow over the outlet, you can put it in the same gap that you dug for the outlet in Item 92. The water-line should be about 50 centimetres below the top of the bank, so put your overflow there as you rebuild the bank.

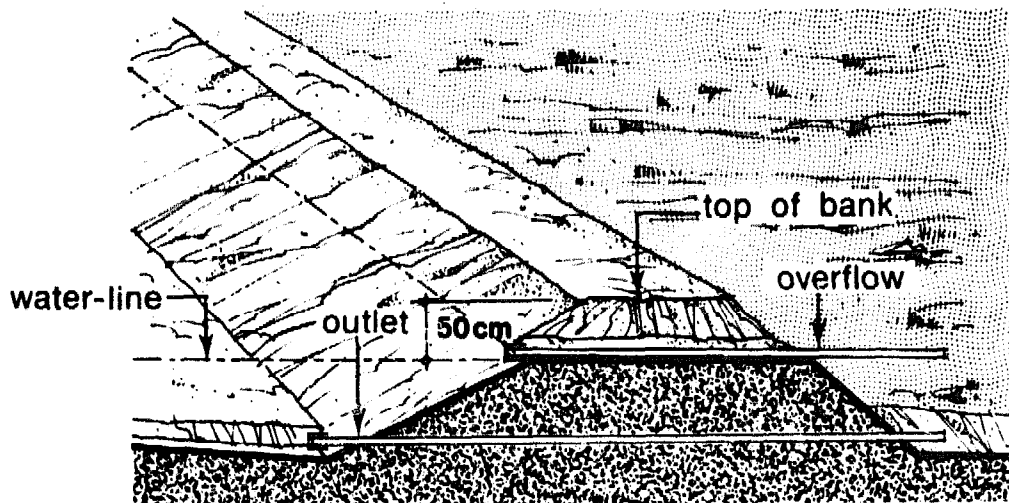

112. If you are going to put the overflow in another place, you will have to dig another gap in the bank about 50 centimetres deep.
113. When the pond is 'full, the overflow will keep the water about 60 centimetres deep at the shallow upper end and about 90 centimetres deep at the deepest part.

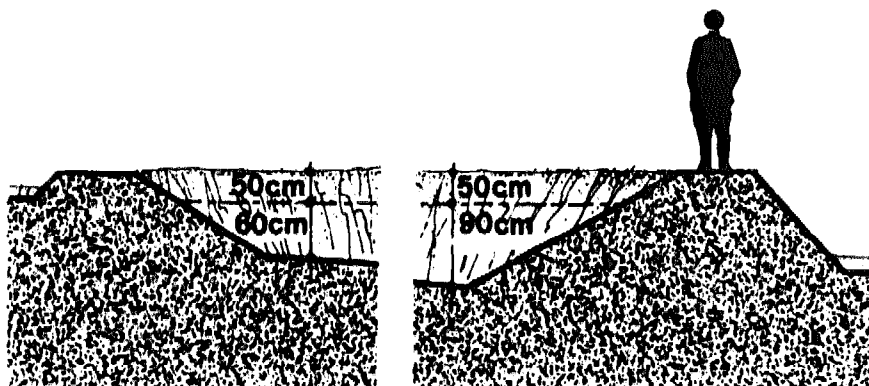

A siphon

114. You can also use a siphon to empty your pond.
If you use a siphon, you will not need an outlet but you will need an overflow like the one described in Items 103-113.
115. A siphon is a simple tube that runs from the inside of the pond over the bank and lies on the ground outside the pond.
116. A siphon can be made of plastic or rubber tubing at least 3 centimetres in diameter.

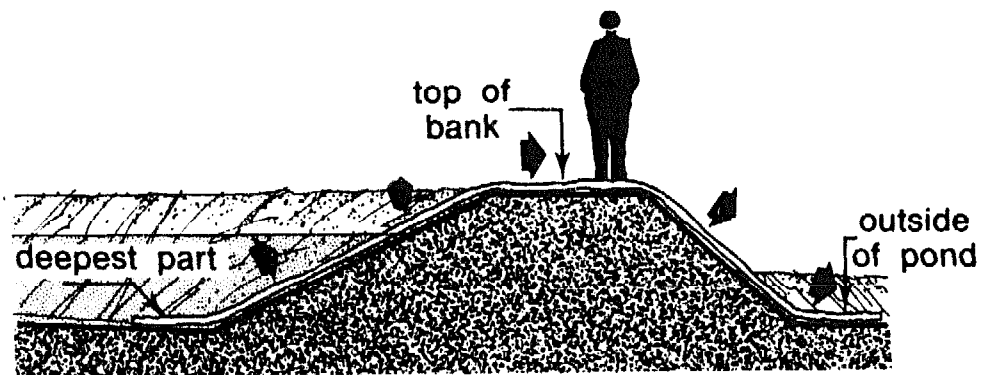

117. The siphon must be long enough to reach from the deepest part of the pond, run over the top of the bank and down the outside of the bank. You will need a siphon about 8 metres long to reach over the top of the bank from the deep part to the outside.
118. When you are ready to empty your pond, put all of the siphon into the pond. It will fill with water. Be sure the tube is full of water from one end to the other. If the siphon is not full of water, it will not work.

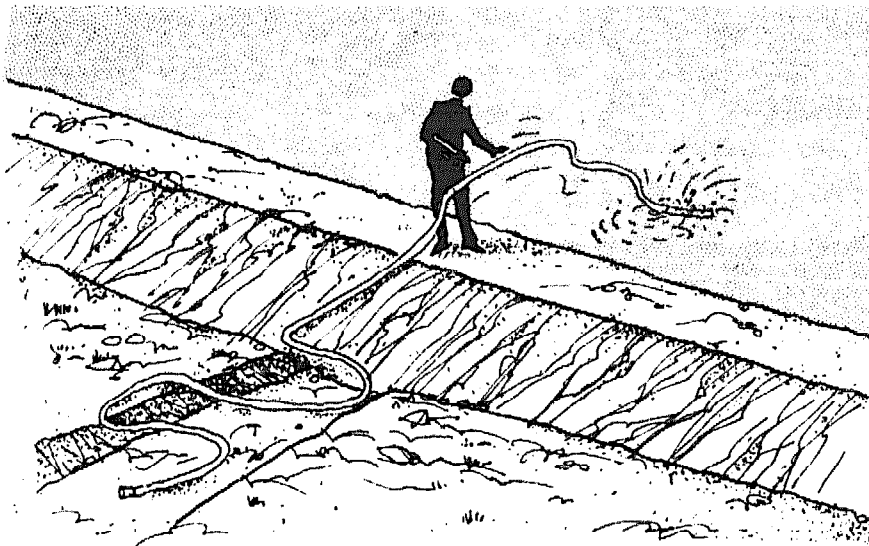

119. While the siphon is still in the water, close one end of the tube with a plug and leave the other end open.

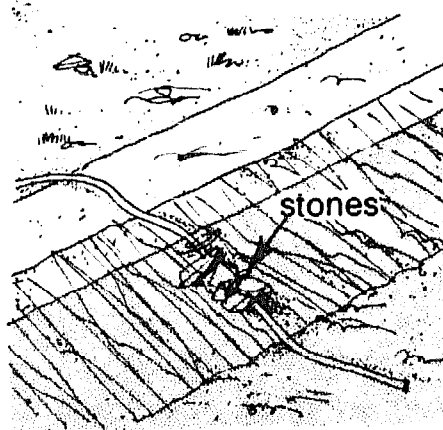
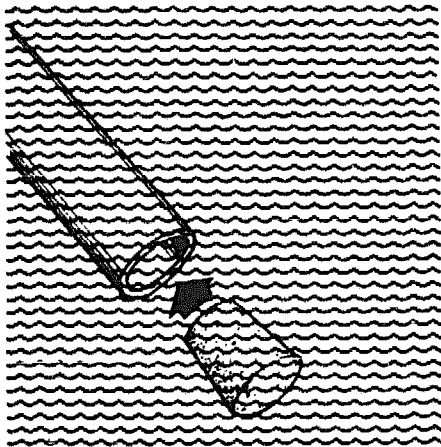

120. Leave the open end of the siphon below the surface of the water. You can use stones to hold the siphon under the water, but be sure that they are not so heavy that the water will be shut off.
121. Take the other end of the siphon, which is closed with the plug, over the top of the bank and put it on the ground outside the pond.

If the ground on the outside of the pond is higher than the pond bottom at the deepest part, you will have to dig a ditch so that the end of the siphon on the outside of the pond will be lower than the end of the siphon in the pond. The ditch will also take the water away when you empty your pond.

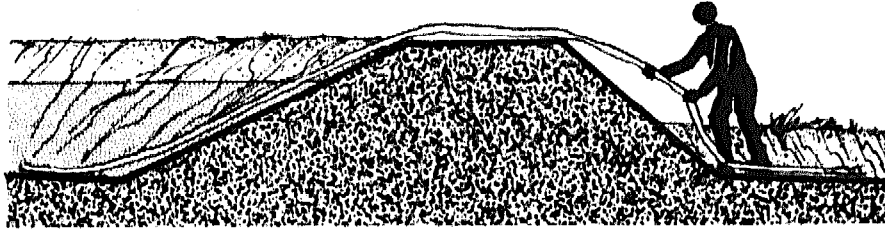

122. Now, take the plug out of the siphon. If the end on the outside is lower than the end in the pond and if the end in the pond is under water, water will start to flow through the tube and out of your pond.



123. If the end of the siphon in the pond comes to the surface, the water may stop flowing. If this happens, put the siphon into the pond to fill it with water and begin again.
124. It will take a lot more time to empty a pond with a siphon than with an outlet. If you use a siphon of about 3 centimetres in diameter, it will take about three days to empty your pond.

Screens

125. Your inlet should have a screen to keep out wild fish, dirt and trash when you fill the pond.
126. If you fill your pond with an inlet trench, it should have a screen, too.

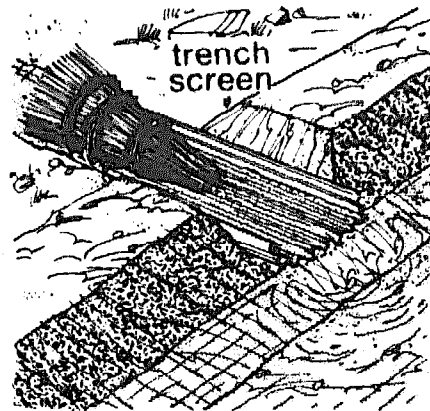
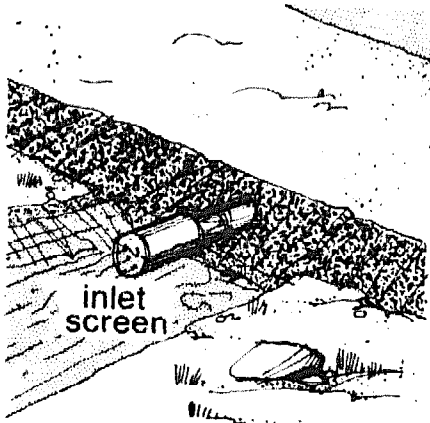

127. A siphon, which is very small, usually does **not** have a screen.
128. Your outlet should have a screen to keep your fish from getting away when you empty your pond.
129. Your overflow should have a screen to keep your fish from getting away when the pond is too full and the water begins to overflow.

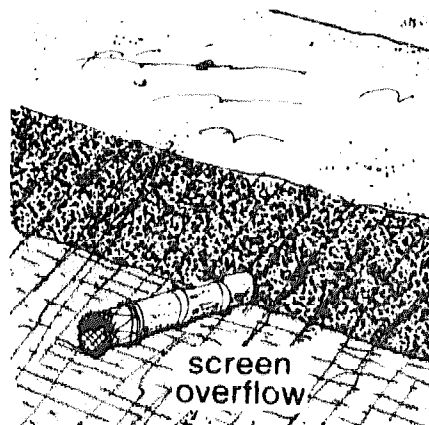
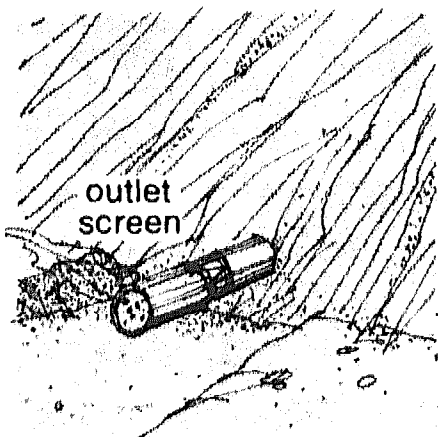

130. You can easily make screens for your inlet, outlet and overflow from fine-mesh plastic or metal or from a tin with holes in the end.

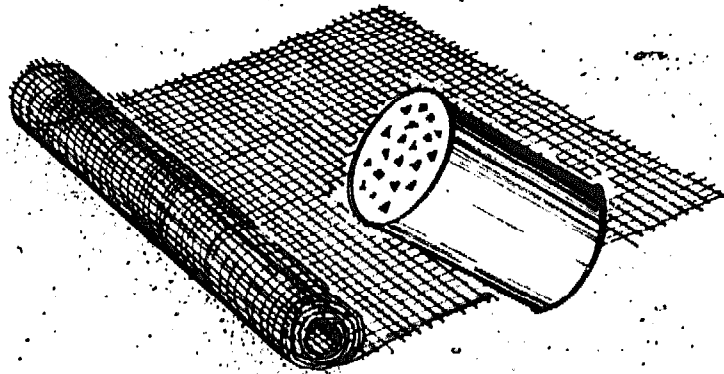

131. Screens should be placed **outside** the pond on the inlet pipe and **inside** the pond on the outlet and overflow pipes.

place inlet screen outside the pond

place outlet and overflow screens inside the pond

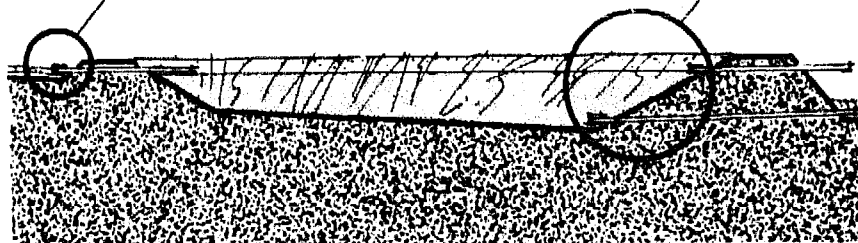

132. This will keep the pipes from filling with trash which could stop the flow of water.

133. Lash the screens tightly in place on the pipes, using heavy cord or light wire.

lash with cord or wire

plastic or metal screen

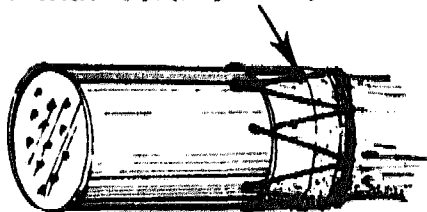

tin with holes

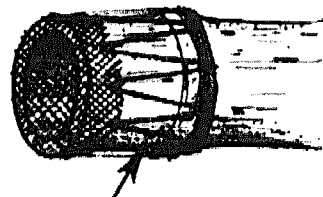

lash with cord or wire

134. If you fill your pond by cutting a trench through the bank, you can screen the opening using a fish trap, split and woven bamboo, a clay pot with holes in the bottom or a piece of metal roofing with holes, as you did in Booklet No. 27, page 21.
135. When you are filling or emptying your pond, clean the screens often. If you do not do this, dirt and leaves will cover them up and the water will not flow.
136. This book has told you how to build a bigger pond and how to build it better.
137. Now that your new pond is built, you will have to learn more. You will need to learn
- how to fill your pond with water
 - how to fertilize your pond
 - about the fish you will put into your pond
 - how to feed your fish every day
 - how to care for your fish
 - how to harvest your fish
138. The next booklet in this series, Booklet No. 30, **Better freshwater fish farming: the fish**, will help you.