



This is a digital copy of a book that was preserved for generations on library shelves before it was carefully scanned by Google as part of a project to make the world's books discoverable online.

It has survived long enough for the copyright to expire and the book to enter the public domain. A public domain book is one that was never subject to copyright or whose legal copyright term has expired. Whether a book is in the public domain may vary country to country. Public domain books are our gateways to the past, representing a wealth of history, culture and knowledge that's often difficult to discover.

Marks, notations and other marginalia present in the original volume will appear in this file - a reminder of this book's long journey from the publisher to a library and finally to you.

### **Usage guidelines**

Google is proud to partner with libraries to digitize public domain materials and make them widely accessible. Public domain books belong to the public and we are merely their custodians. Nevertheless, this work is expensive, so in order to keep providing this resource, we have taken steps to prevent abuse by commercial parties, including placing technical restrictions on automated querying.

We also ask that you:

- + *Make non-commercial use of the files* We designed Google Book Search for use by individuals, and we request that you use these files for personal, non-commercial purposes.
- + *Refrain from automated querying* Do not send automated queries of any sort to Google's system: If you are conducting research on machine translation, optical character recognition or other areas where access to a large amount of text is helpful, please contact us. We encourage the use of public domain materials for these purposes and may be able to help.
- + *Maintain attribution* The Google "watermark" you see on each file is essential for informing people about this project and helping them find additional materials through Google Book Search. Please do not remove it.
- + *Keep it legal* Whatever your use, remember that you are responsible for ensuring that what you are doing is legal. Do not assume that just because we believe a book is in the public domain for users in the United States, that the work is also in the public domain for users in other countries. Whether a book is still in copyright varies from country to country, and we can't offer guidance on whether any specific use of any specific book is allowed. Please do not assume that a book's appearance in Google Book Search means it can be used in any manner anywhere in the world. Copyright infringement liability can be quite severe.

### **About Google Book Search**

Google's mission is to organize the world's information and to make it universally accessible and useful. Google Book Search helps readers discover the world's books while helping authors and publishers reach new audiences. You can search through the full text of this book on the web at <http://books.google.com/>

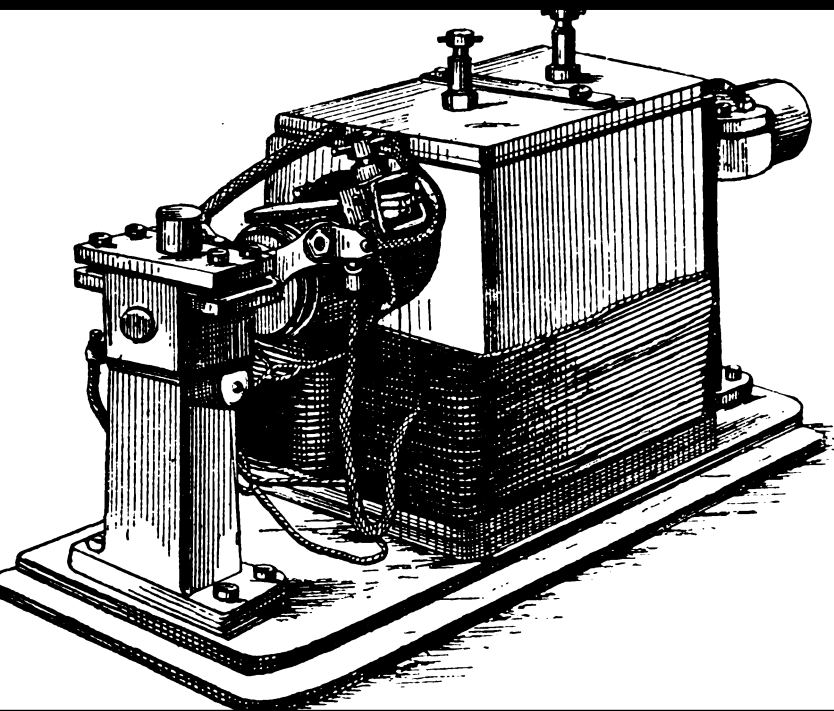

*The electro-platers' handbook*

G. E. Bonney

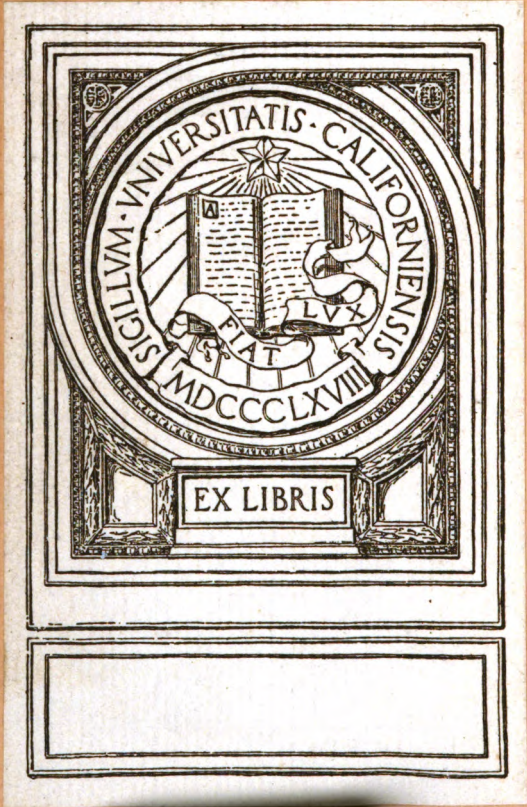









**THE  
ELECTRO-PLATERS' HANDBOOK.**



**WORKS BY G. E. BONNEY.**

- INDUCTION COILS.** A Practical Manual for Amateur Coil-makers. With 100 Illustrations. 3s.  
**THE ELECTRO-PLATERS' HANDBOOK.** A Practical Manual for Amateurs and Students in Electro Metallurgy. With 61 Illustrations. 3s.  
**ELECTRICAL EXPERIMENTS.** A Manual of Instructive Amusements. With 144 Illustrations. 2s. 6d.

---

**WORKS BY S. R. BOTTONE.**

- A GUIDE TO ELECTRIC LIGHTING.** For Householders and Amateurs. By S. R. BOTTONE. With many Illustrations. Pictorial cover. 1s.  
**HOW TO MANAGE A DYNAMO.** A Handbook for Engineers, Electric Light Engineers, and Electro-platers. Illustrated. Pocket size. 1s.  
**WIRELESS TELEGRAPHY AND HERTZIAN WAVES.** With 37 Illustrations. 3s.  
**ELECTRICAL INSTRUMENT-MAKING FOR AMATEURS.** A Practical Handbook. With 96 Illustrations. 3s. 6d.  
**ELECTRO-MOTORS: HOW MADE AND HOW USED.** A Handbook for Amateurs and Practical Men. With 90 Illustrations. 3s.  
**ELECTRICITY AND MAGNETISM.** A Popular Treatise. With 103 Illustrations. 2s. 6d.  
**ELECTRIC BELLS AND ALL ABOUT THEM.** A Practical Book for Practical Men. With more than 100 Illustrations. 3s.  
**THE DYNAMO: HOW MADE AND HOW USED.** With Illustrations. 2s. 6d.  
**RADIOGRAPHY: ITS THEORY, PRACTICE, AND APPLICATIONS.** With Constructional and Manipulatory Details. With 47 Illustrations. 3s.  
**GALVANIC BATTERIES.** Their Theory, Construction, and Use. Comprising Primary, Single and Double Fluid, Gas and Secondary Batteries. With 144 Illustrations. 5s.  
**RADIUM, AND ALL ABOUT IT.** With Coloured Wrapper and Illustrations. 1s. net.

- 
- WHITTAKER'S ELECTRICAL ENGINEERS' POCKET-BOOK.** Edited by KENELM EDGECUMBE, A.M.I.E.E. With 143 Illustrations. Leather, 3s. 9d. post free.  
**ELECTROLYTIC METHODS OF ANALYSIS:** the Theory and Practice of. By DR. NEUMANN. Translated and Revised by J. B. C. KERSHAW, F.I.C. With 36 Illustrations. 6s.

---

WHITTAKER AND CO. : LONDON, E.C.

THE  
• ELECTRO-PLATERS' •  
HANDBOOK. •

A PRACTICAL MANUAL  
FOR AMATEURS AND STUDENTS IN  
ELECTRO-METALLURGY.

BY  
G. E. BONNEY.

*WITH SIXTY-ONE ILLUSTRATIONS.*

FOURTH EDITION.



WHITTAKER AND CO.

2, WHITE HART STREET, PATERNOSTER SQUARE,  
LONDON.

1905.

TS610  
B6

GENERAL

133106

CHISWICK PRESS: CHARLES WHITTINGHAM AND CO.  
TOOKS COURT, CHANCERY LANE, LONDON.

## PREFACE.

THIS book has been written to meet the wants of amateurs and young workmen desiring a practical manual on electro-plating at a low price. It supposes the workman to have an elementary acquaintance with electrical science, and a wish to put this knowledge to a practical use in the electro-deposition of metals. Although the information given here has been proven in the workshop, the author has not relied entirely on his own experience, but has incorporated with it the experience of fellow-workers in the art. His thanks are specially due to Mr. J. E. Hartley, of the firm of Messrs. J. E. Hartley and Co., 13, St. Paul's Square, Birmingham, for useful information and loan of electros; to Mr. T. Hemming, of the firm of Messrs. Canning and Co., Birmingham; to Messrs. Doulton and Co., Lambeth Potteries, S.E.; Messrs. Cassell and Co., Crosby Lockwood and Co., and the Electrical Engineering Corporation, for loans of electros.

Much of the information contained in Chapter III. has been kindly supplied by Mr. S. Bottone, the well-known author of "Electrical Instrument Making for Amateurs," "Electric Bells and all About Them," "Electro-Motors, How Made and How Used," etc., etc. The hints herein given on the choice, management, and care of electro-plating dynamos, will, it is believed, supply a want long felt by electro-platers.

*January, 1891.*

## PREFACE TO THE SECOND EDITION.

IN preparing this Second Edition of the *Electro-Platers' Handbook*, I make use of the opportunity to thank those reviewers of the first edition who so generously aided me with suggestions for its improvement. The chapter on *Dynamo-Electric Plating Machines* has been left practically untouched, because there has been little or nothing added to the list of good plating dynamos since this chapter was first published, and, the old ones mentioned there, still serve as obsolete ensamples to be avoided in the future. Some additional notes on this subject will be found in the Appendix, which also contains an additional chapter on *Electrotyping*, together with short sections on *Frosting Gold*, *Stopping-off Varnishes*, and *Rates of Deposit* for the principal metals in use by electro-platers.

## PREFACE TO THE THIRD EDITION.

IN issuing a Third Edition of this work, I have deemed it advisable to revise the chapter on Dynamo-Electric Plating Machines, replacing some of the old dynamos with machines of a more modern type. Advances in the application of electro-metallurgy to Cycle Plating has rendered an expansion of Chapter VIII. a necessity. This has been done by adding two sub-sections dealing with Nickel-Plating Cycle Fittings, and Nickelling Small Articles. In the preparation of these I have received assistance from Mr. H. E. Hartley, and Messrs. Canning and Co., of Birmingham.



## CONTENTS.

CHAPTER	PAGE
I. ELECTRO-DEPOSITION OF METALS . . . . .	1
II. ELECTRO-DEPOSITION BY CURRENT FROM BATTERIES . . . . .	11
III. DYNAMO-ELECTRIC PLATING MACHINES . . . . .	32
IV. ELECTRO-PLATERS' MATERIALS . . . . .	70
V. PREPARING THE WORK . . . . .	92
VI. ELECTRO-PLATING WITH SILVER . . . . .	115
VII. ELECTRO-PLATING WITH GOLD . . . . .	149
VIII. ELECTRO-PLATING WITH NICKEL . . . . .	165
IX. ELECTRO-PLATING WITH COPPER . . . . .	177
X. ELECTRO-PLATING WITH ALLOYS . . . . .	183
XI. ELECTRO-PLATING WITH ZINC, TIN, IRON, ETC. . . . .	191
XII. ELECTROTYPING, AND APPENDIX . . . . .	201
GENERAL INDEX . . . . .	214







FIG.		SEC.	PAGE
26.	Speed Indicator . . . . .	48	67
27.	Harding's Patent Speedometer . . . . .	48	68
28.	Swilling and Scouring Trough . . . . .	52	75
29.	Scouring Brush . . . . .	53	76
30.	Potash Brush of Cotton Fibre . . . . .	54	76
31.	Polishing Bob . . . . .	55	77
32.	Circular Scratch Brush . . . . .	56	78
33.	Cup Brush . . . . .	56	78
34.	Scratch-Brush Knot . . . . .	56	79
35.	Scratch-Knot Lathe . . . . .	56	79
36.	Foot-power Scratch-Brush Lathe . . . . .	57	80
37.	Heavy Grinding and Polishing Lathe . . . . .	57	81
38.	Polishing Lathe . . . . .	58	82
39.	Specific Gravity Hydrometer . . . . .	63	86
40.	Tall Glass Jar for Hydrometer . . . . .	64	87
41.	Resistance Board . . . . .	64	89
42.	Resistance Board and Ammeter combined . . . . .	65	90
43.	Dipping or Mixing Pan for Acid Pickles . . . . .	76	108
44.	Dipping Pan for Acids . . . . .	76	108
45.	Stoneware Dipping Basket . . . . .	76	109
46.	"    "    Bowl . . . . .	76	109
47.	Dipping Basket of Platinum Gauze . . . . .	76	109
48.	Trinkets strung on Wire for Dipping . . . . .	76	109
49.	Dipping Hook . . . . .	76	109
50.	Mohr's Burette and Holder . . . . .	86	126
51.	Bink's Burette . . . . .	86	127
52.	Foot-power Polishing Lathe . . . . .	95	142
53-60.	Burnishers for burnishing Electro-Plate . . . . .	97	146
61.	View of a Birmingham Electro-Plating Workshop . . . . .	97	148

## INDEX TO SECTIONS.

SEC.	PAGE
1. Definition of Electro-Metallurgy . . . . .	1
2. Origin of the Art . . . . .	1
3. First Considerations . . . . .	3
4. Suitable Depositing Solutions . . . . .	3
5. First Experiments . . . . .	4
6. Metals of Low Cost . . . . .	5
7. Metals of High Cost . . . . .	5 4
8. Metals easily Deposited . . . . .	6 5
9. Metals not easily Deposited . . . . .	7
10. Alloys of Metals . . . . .	7
11. Deposition of Metals . . . . .	8
12. Deposition by Simple Immersion . . . . .	8 23
13. Single Cell Deposition . . . . .	10 25
14. Electro-Deposition of Metals . . . . .	10 28
15. Deposition by Battery . . . . .	11 26
16. Suitable Batteries . . . . .	11
17. Unsuitable Batteries . . . . .	13
18. Maintenance of Batteries . . . . .	13
19. Amalgamation of Zincs . . . . .	14
20. The Wollaston Battery . . . . .	15
21. The Smee Battery . . . . .	17
22. The Daniell Battery . . . . .	20
23. The Bunsen Battery . . . . .	23
24. Construction and Maintenance of Batteries . . . . .	25
25. Batteries for Electro-Plating . . . . .	26
26. How to arrange Battery Cells . . . . .	28
27. Electro-Deposition by Dynamo . . . . .	32
28. Origin of the Dynamo . . . . .	34
29. Evolution of the Plating Dynamo . . . . .	36
30. What is a Dynamo? . . . . .	37
31. Plating Dynamos . . . . .	40

SEC.	PAGE
32. Winding a Plating Dynamo . . . . .	41
33. Choice of a Dynamo . . . . .	44
34. Types of Plating Dynamos . . . . .	47
35. The Wilde Dynamo . . . . .	48
36. The Ladd Dynamo . . . . .	49
37. The Siemens Dynamo . . . . .	51
38. The Weston Dynamo . . . . .	52
39. The Kapp Over-type Dynamo . . . . .	54
40. The Hartley Plating Dynamo . . . . .	56
41. The Bottone Dynamo . . . . .	57
42. The Canning Plating Dynamo . . . . .	58
43. The Austin "Infant" Dynamo . . . . .	60
44. The Canning Four-Pole Dynamo . . . . .	61
45. The Avery Lahmeyer Dynamo . . . . .	62
46. The Gramme Dynamo . . . . .	64
47. Transformers . . . . .	66
48. Speed of Dynamo Machines . . . . .	66
49. Management of Dynamos . . . . .	68
50. Workshop Appliances . . . . .	70
51. Vats . . . . .	71
52. Dipping Vessels . . . . .	74
53. Scouring, Swilling, and Rinsing Troughs . . . . .	75
54. Scouring Brushes . . . . .	76
55. Polishing Tools . . . . .	76
56. Scratch Brushes . . . . .	78
57. Scratch-Brush Lathes . . . . .	80
58. Polishing Lathes . . . . .	81
59. Polishing Materials . . . . .	82
60. Slinging Wires . . . . .	84
61. Leading Wires . . . . .	84
62. Sawdust . . . . .	85
63. Thermometers . . . . .	86
64. Hydrometers . . . . .	86
65. Resistance Boards . . . . .	90
66. Cleanliness essential . . . . .	92
67. Cleaning Cast Iron . . . . .	93
68. Cleaning Wrought Iron and Steel . . . . .	94

*INDEX TO SECTIONS.*

xv

SEC.	PAGE
69. Cleaning Copper, Brass, and German Silver . . . . .	95
70. Cleaning Old Articles . . . . .	98
71. Stripping . . . . .	101
72. Cleaning Zinc . . . . .	104
73. Cleaning Britannia Metal and Pewter . . . . .	105
74. Cleaning Silver and Gold . . . . .	106
75. Clearing off Corrosion and Rust . . . . .	106
76. Dips and Dipping . . . . .	107
77. Potash and Cyanide Dips . . . . .	110
78. Quicking Solutions . . . . .	111
79. Preparing Articles by Hand . . . . .	113
80. Polishing Trinkets . . . . .	114
81. Electro-Silvering . . . . .	115
82. Nitrate of Silver . . . . .	115
83. Cyanide of Silver . . . . .	116
84. Double Cyanide of Silver and Potassium . . . . .	121
85. Cyanide of Potassium . . . . .	123
86. Testing Cyanide of Potassium . . . . .	125
87. Silvering Solutions . . . . .	128
88. Management of Silver-Plating Solutions . . . . .	130
89. Character of Silver Deposit . . . . .	131
90. Thickness of Silver Deposits . . . . .	134
91. Rate of Silver Deposition . . . . .	136
92. Bright Silver Plating . . . . .	137
93. Practical Hints . . . . .	138
94. Finishing Silver-Plated Articles . . . . .	140
95. Polishing Silver Plate and Silver . . . . .	141
96. Colouring and Finishing . . . . .	143
97. Burnishing . . . . .	144
98. Electro-Gilding . . . . .	149
99. Terchloride of Gold . . . . .	149
100. Cyanide of Gold . . . . .	151
101. Double Cyanide of Gold and Potassium . . . . .	152
102. Amateurs' Gilding Solution . . . . .	154
103. Strength of Gilding Bath . . . . .	156
104. Assaying Gilding and Silvering Solutions . . . . .	156
105. Testing Solutions for Free Cyanide . . . . .	157

SEC.	PAGE
106. Management of Gilding Baths . . . . .	158
107. Characteristics of Gold Deposits . . . . .	160
108. Power required to deposit Gold . . . . .	161
109. Polishing and Finishing Electro-Gilt Articles . . . . .	162
110. Electro-Deposition of Platinum . . . . .	162
111. Electro-Nickeling . . . . .	165
112. Nickel Solutions . . . . .	166
113. Single Salts of Nickel . . . . .	167
114. The Double Salts of Nickel . . . . .	167
115. Nickel Solutions for Electro-Deposition . . . . .	169
116. Working Nickel Solutions . . . . .	170
117. Rate and Thickness of Nickel Deposits . . . . .	173
118. Power required to deposit Nickel . . . . .	173
119. Finishing Nickel Deposits . . . . .	174
120. Care of Nickel Baths. 120a. Nickel-plating Cycle Fittings	175
121. Electro-Deposition of Copper . . . . .	177
122. Alkaline Solution of Copper . . . . .	178
123. Cyanide of Copper Solution . . . . .	179
124. The best Alkaline Copper Solution . . . . .	179
125. Working Alkaline Copper Solutions . . . . .	180
126. Electric-Type Solutions of Copper . . . . .	181
127. Rate and Thickness of Copper Deposits . . . . .	182
128. Electro-Deposition of Alloys . . . . .	183
129. Electro-Deposition of Brass . . . . .	184
130. Watt's Brassing Solution . . . . .	187
131. Management of Brassing Solutions . . . . .	188
132. Power required for Electro-Brassing . . . . .	189
133. Electro-Bronzing . . . . .	189
134. Electro-Deposition of German Silver . . . . .	189
135. Electro-Deposition of Zinc . . . . .	191
136. Watt's Electro-Zincing Solution . . . . .	192
137. Deposition of Tin . . . . .	192
138. Electro-Deposition of Tin . . . . .	193
139. Electro-Plating with Iron . . . . .	196
140. Electro-Plating with other Metals . . . . .	197
141. Recovery of Gold and Silver from Waste . . . . .	198
142. Health in the Workshop . . . . .	199



# ELECTRO-PLATERS' HANDBOOK.

## CHAPTER I.

### ELECTRO-DEPOSITION OF METALS.

§ 1. **Definition of Electro-Metallurgy.** Metallurgy is the name given to the art of extracting metals from their ores and working them. In the ordinary processes of this art, fire is the agent employed in the reduction of metals from their ores. Electro-metallurgy is the name given by Mr. Smee to the art of working in metals and extracting them from their solutions by the agency of electricity. All metals can be reduced from solids to liquids by dissolving them in acids, and can be brought back to a solid condition again by passing a current of electricity through properly prepared solutions of the metals. The name given to this art by Mr. Smee is also expanded to embrace a later development of electrical science, in a process by which the metals can be extracted from their ores, and afterwards smelted in the high temperature of an electric arc light.

§ 2. **Origin of the Art.** Although the art of electro-metallurgy may be said to be a modern one, it cannot be said



to own an inventor, and the exact date of its origin is somewhat obscure. Facts which lie at the foundation of the art were well known to experimenters in chemistry at the close of the last century, but these appear to have been first made known to the world by Dr. Wollaston, who describes one of his experiments in the "Philosophical Transactions" dated 1801. He therein says: "If a piece of silver, in connection with a more positive metal, be put into a solution of copper, the silver is coated over with copper, which coating will stand the operation of burnishing." Even then, no one appears to have applied this fact to any useful purpose, and for several years afterwards we can only trace the progress of the art by means of several curious isolated observations on the results of experiments performed for other purposes. In 1805, Brugnatelli mentions, in a letter to a friend, that he succeeded in gilding two silver medals in a new solution of ammoniacal solution of gold. In 1837 Mr. Thomas Spencer, of Liverpool, deposited copper on a penny immersed in the copper solution of a Daniell cell, and, on peeling off the deposited copper, found it to be an exact counterpart of the head and letters on the coin. In 1839 Mr. C. J. Jordan published in the "London Mechanic's Magazine" a letter detailing a method of obtaining electrotypes. On September 12th, 1839, Mr Spencer read a paper on "Working in Metal by Voltaic Electricity" before a meeting of the Liverpool Polytechnic Society. Mr. Smee gives Mr. Spencer the credit of making known to the British public the idea of the electrotype, but claims Professor Daniell as the parent of electro-metallurgy.

Mr. De la Rue had explained a process of electrotyping in the "Philosophical Magazine" for 1836, and Professor Jacobi announced a galvano-plastic process discovered by him in 1838. It is therefore difficult to fix a date for the discovery of the art, since Professor Daniell only published an account of his battery in the "Philosophical Transactions" of 1836.

§ 3. **First Considerations.** The information conveyed in the foregoing paragraph has only a historic value, and, therefore, will be of but little interest to the practical man. His first thoughts will be centred in some work that he wishes to have done, and the best method of achieving his purpose. His first consideration, therefore, should be to get the best advice, the best tools, and the best material to work with. Wit bought is certainly wit taught, and there is no other teacher equal to that of experience. But, without a competent guide, the road of experience will prove to be a long one, and the time wasted in aimless experiments will represent a high money value at the end of the road.

§ 4. **Suitable Depositing Solutions.** One of the first considerations should be given to a selection of the best depositing solution to the purpose in hand. In this selection the student should be guided by the following rules. 1. Select, first, a solution that will yield up its metal freely under the influences of the electric current, but will not deposit its metal on articles by simple immersion of these in the solution. 2. Choose one that will dissolve the anode freely, and thus maintain the solution in a constant working condition. 3. The former rules

having been observed, let the choice rest upon a solution made up in the most simple manner, out of the least number of ingredients. The solution should contain only the salts of the metal to be deposited, and these salts should break up at the cathode into deposited metal and its solvent, which should be retained in the solution. For example, the best depositing solution for silver is one composed of the double cyanide of silver and potassium in distilled water. This solution will yield up its metal freely under the influence of a low tension current of electricity, and the double salt breaks up at the cathode into deposited silver and potassium cyanide. As the latter is a solvent of silver when this metal forms the positive electrode in a solution of cyanide of potassium, the anode dissolves freely, and maintains the solution in working order. That is to say, it furnishes to the solution an equivalent of silver for each equivalent withdrawn. This solution is easily made up, as will be seen further on. The double cyanide salts are of general utility, forming excellent depositing solutions of gold, silver, platinum, copper, zinc, and mercury.

**§ 5. First Experiments.** The student of electro-metalurgy, and the amateur attempting an essay in electro-deposition, should first practise with an easily-deposited metal of low cost, and study some of the principles of the art whilst conducting those experiments. I recommend a thorough insight into the theory and practice of copper deposition before proceeding with that of other metals, because copper is easily deposited and its cost is low. Some very good practice can be had in duplicating

gold and silver coins and medals in copper, the duplicates being afterwards gilded or plated to represent the originals.

§ 6. **Metals of Low Cost.** The least costly metals are not, as a general rule, the most easy to deposit in a good condition. Iron may be placed first, as being of least cost, but it cannot be easily deposited in good condition. Zinc is also a cheap metal, but there are difficulties attending its deposition. Tin may be easily deposited, but the depositing solution needs careful attention to keep it in working order. Lead offers little of practical interest to the electro-plater. The same may be said of bismuth and antimony. Copper is a useful metal, of moderately low cost, and one easily deposited in good condition.

§ 7. **Metals of High Cost.** Nickel at 1*s.* 9*d.* to 2*s.* per lb. is, as compared with copper at 10*d.* to 1*s.* per lb., a costly metal; but it is also a very useful metal, and its merits will be treated of in a future chapter. Cobalt, the sister metal of nickel, has not come into general use, but it may be classed with that metal. Silver is the electro-plater's metal, and a general favourite with amateur depositors. For electro-depositing purposes it may be put down as costing from 5*s.* to 5*s.* 6*d.* per oz., since absolutely pure silver must be employed, and the cost of labour added to the cost of the other materials used in the process of electro-plating. Platinum comes next in point of cost, at a price of from 35*s.* to 40*s.* per oz. If

we except the rare metals as being of little practical interest to the electro-plater, gold stands the highest on the list as regards cost, the price for the pure metal being from 85s. to 87s. per oz.

§ 8. **Metals easily Deposited.** Gold may be deposited from its solution of the double cyanide of gold and potassium in good condition under the influence of a very feeble current, such as that obtained from an earth battery composed of buried coke opposed to buried scrap iron. This is mentioned to show how easily the metal may be deposited. A properly constructed battery should always be used to ensure proper control of the current, which may, however, have an electro-motive force of only half a volt. Copper is also a metal easily deposited from its solution of copper sulphate. This solution will deposit copper on zinc, iron, and steel, by simply immersing these metals in the solution, but the copper so deposited can be easily rubbed off again, as it is only a mere film obtained by chemical action on the surface of the immersed metal. The electro-motive force needed to decompose a solution of copper sulphate, may be as low as half a volt, and need not in most cases exceed one volt. Higher tensions than these are used to overcome resistances met with in actual practice, and to effect rapid depositions of the metal. To deposit copper from its alkaline solutions, a current of higher tension is needed, ranging from 5 to 10 volts according to the resistance of the work in the circuit. Silver requires a current of higher tension to deposit it from its solution of the double cyanide of silver and potassium, than that

employed to deposit gold from the corresponding solution. A tension of from  $1\frac{1}{2}$  to 2 volts is necessary, and this may have to be increased if the solution is not rich in metal, the electrodes far apart, or other resistance interposed in the circuit.

§ 9. **Metals not easily Deposited.** Although we have seen that such metals as gold, copper, and silver may be easily deposited in good condition from suitable solutions when employing an electric current of low tension, this only touches the fringe of comparatively easy deposition or otherwise, and the rapidity of the process under suitable conditions. The condition of the deposited metal is greatly affected by the tenuity or the density of the solution, and the density of current as well as its electro-motive force or tension. Some metallic salts need a higher tension current to decompose them than others, but the main consideration must be directed to current density rather than current tension, since the quantity of metal deposited from a solution in a good condition in a given time, will greatly depend upon the number of ampères of current we can get through the solution. This will be considered when dealing with the subject in a later section. The salts of nickel, zinc, tin, and iron, appear to need a current of higher density to decompose them than those of gold, silver, and copper.

§ 10. **Alloys of Metals.** Alloys of metals are more intractable than the simple metals themselves. This is mainly due to the difference between the chemical equivalents of the metals composing the desired alloy. As

the current exercises a selective effect on the metals contained in the alloyed solution, depositing them in proportions determined rather by their chemical equivalents than by the quantity of metal present in the solution, it follows that the deposited alloy will vary in its composition as the density of the current varies and the solution alters in density.

§ 11. **Deposition of Metals.** Metals may be deposited from their solutions by simple immersion, by the single cell process, or by a current of electricity. The first is effected by a chemical interchange of elements in the depositing solution, as when the sulphuric acid in a sulphate of copper solution dissolves the surface of a piece of iron immersed in the solution, and copper is deposited in place of the dissolved iron. The second is effected also by a chemical interchange of elements, but the two elements are in separate solutions, and a real galvanic pair is formed. In the third, we have a separate generator of electricity, and a separate depositing solution.

§ 12. **Deposition by Simple Immersion.** In this process the deposited metal takes the place of the metal dissolved from the surface of the article receiving the deposit. The solution must therefore contain a solvent having a greater affinity for the surface of the article than it has for the metal held by it in solution. The following observations of deposition by simple immersion are given by Mr. George Gore, in his work on "Electro-Deposition." I have arranged the examples in tabular form for easy reference.

## TABULAR EXAMPLES OF DEPOSITION BY SIMPLE IMMERSION.

SOLUTION.	METAL.																		
	Antimony.	Arsenic.	Bismuth.	Brass.	Cadmium.	Cobalt.	Copper.	Gold.	German Silver.	Iron.	Lead.	Platinum.	Palladium.	Manganese.	Mercury.	Nickel.	Silver.	Tin.	Zinc.
Antimony Terchloride	n	o	d	d	o	o	o	n	d	o	d	n	o	o	o	n	n	d	d
Bismuth Chloride . . .	n	o	n	n	o	o	n	n	n	d	d	n	o	o	o	o	o	d	d
Copper Sulphate . . .	n	o	n	o	o	o	n	n	o	d	d	n	o	o	o	n	n	d	d
" Nitrate . . .	n	o	n	o	o	o	n	n	o	d	d	n	o	o	o	n	n	d	d
" Chloride . . .	n	o	d	o	o	o	n	n	o	d	d	o	o	o	o	n	n	d	d
" Dichloride . . .	n	o	n	o	o	o	n	n	o	n	n	n	o	o	o	n	n	d	d
Gold Terchloride . . .	d	d	d	d	d	d	d	n	d	d	d	d	d	d	d	d	d	d	d
" Dble. Cyanide . . .	n	o	n	d	o	o	d	n	d	n	n	n	o	o	o	n	n	n	v
Mercury Nitrate . . .	d	o	d	o	d	o	d	n	o	d	d	n	o	o	o	o	n	o	d
Mercurous Salts . . .	d	d	d	d	d	o	d	o	d	d	d	o	o	o	o	o	d	d	d
Platinum Chloride . . .	d	d	d	d	d	d	d	n	d	d	d	n	o	o	d	d	d	d	d
Lead Nitrate } . . .	n	o	n	n	o	o	n	n	n	n	n	n	o	o	o	n	n	n	d
" Acetate } . . .	n	o	n	n	o	o	n	n	n	n	n	n	o	o	o	n	n	n	d
Silver Nitrate . . .	d	d	d	d	o	o	d	o	d	d	v	n	o	d	o	d	n	v	d
" Alcoholic Nitrate . . .	d	o	d	d	o	o	d	o	d	n	o	o	o	o	o	o	o	d	d
" Dble. Cyanide . . .	n	o	n	d	o	o	v	n	d	n	v	n	o	o	o	n	n	n	v
Tin Chloride . . .	n	o	n	n	o	o	n	n	n	d	n	o	o	o	o	n	n	n	d
Zinc Salts . . .	n	o	n	n	o	o	n	n	n	n	n	n	o	o	o	n	n	n	n

## REFERENCES.

d. Deposition.    n. No deposition.    o. Not observed.    v. Quickly deposited.

The following observations have also been made by Mr. Gore. That no metal becomes coated by simple immersion in a solution of the same metal. That the baser metals, such as zinc, lead, tin, and iron, become coated more frequently than such noble metals as gold and platinum, whilst solutions of these yield their metal more readily than those of the baser metals. That the coherent and adhesive deposits were very thin, and the heavy, rapidly-formed deposits had the appearance of a dark-coloured powder. To this mode of deposition belongs the processes of wash-tinning, simple silvering, and water-gilding



§ 13. **Single Cell Deposition.** In the single cell process of deposition, the article to be coated forms one element of a galvanic pair. The positive element is generally a plate, a rod, or a cylinder of zinc immersed in a solvent contained in a porous cell dipping into the depositing solution. The article to be coated is connected by a wire to the zinc element, and suspended in the depositing solution. It therefore becomes the negative element of the pair, and receives an equivalent of deposited metal for each equivalent of zinc dissolved in the porous cell. The cell of a Daniell battery is an example of the single cell process, the negative element of copper taking the place of the article in the depositing solution. Some excellent electrotypes have been taken in copper by this process, and it is a most suitable one to the wants and means of young students.

§ 14. **Electro-Deposition of Metals.** An example of the electro-deposition of metals is furnished in the preceding paragraph, where deposition by the single cell process is explained. But the term is usually applied to processes in which a current of electricity is generated in an apparatus separate from the depositing vat, such apparatus being either a galvanic battery or a machine constructed to generate a current of electricity. Metals are electro-deposited when a current of electricity is made to decompose a solution of a metal salt into its constituent parts, and deposit the metal only on the surface of a conductor prepared to receive such a deposit.

## CHAPTER II.

### ELECTRO-DEPOSITION BY CURRENT FROM BATTERIES.

§ 15. **Deposition by Battery.** All first experiments in this art were carried out with current derived from voltaic batteries. Its application to commercial purposes was also made by the same means. Some really good work on a large scale has been done with current from batteries, whilst some large and excellent electrotypes have been made by the single cell process. Although, in large workshops, the battery as a generator has been quite superseded by the dynamo-electric machine, it still retains its position in small workshops and in the atelier of the amateur electro-plater. When operations in a small way have to be conducted at intervals in small workshops where motive power cannot be readily obtained to drive a dynamo, the use of a battery becomes a necessity, and is a less costly generator than a machine with its motor and other accessories.

§ 16. **Suitable Batteries.** Some of the first batteries used were those invented by Professor Daniell and Mr. Smee. These are still preferred by some electro-depositors working on a small scale. When the battery invented by Dr. Wollaston became known, it superseded

the Smee battery, because it furnished a larger volume of current, and because of the handiness of the arrangement by which the elements were lifted out of the cells when the battery was not at work. This battery, and its modifications, is still largely used in operations for plating with silver, and in electrotypy. With the development of the plating art and the introduction of nickel-plating, came the necessity for a more constant battery than either the Smee or the Wollaston, and one with a higher E. M. F. per cell than the Daniell. This led to the adoption of the Bunsen battery, which is now largely used whenever a strong, full current is required, as in operations for the deposition of nickel, of brass, and of copper from alkaline solutions. The desired qualities in a battery for electro-deposition are:—1. *Constancy*. If the battery furnishes a full volume at first, when closing the circuit, but fails afterwards to furnish the same volume of current, it may be regarded as useless to the electro-plater. The battery must furnish a full current throughout a working day. 2. *Low internal resistance*. This is secured in the Wollaston battery by using large cells and corresponding large elements. A similar arrangement in other batteries will produce similar results. By reducing the internal resistance of a battery, we increase the volume of current obtainable from it. The internal resistance of a battery may be reduced by placing the elements closer together, adding more acid to the solution, slightly warming the solution, and using large connecting wires between the cells. 3. *High electro-motive force*. Unless the electro-motive force of the

battery is high, we must use a large number of cells in series when doing such work as brassing, nickeling, and coppering in alkaline solutions. As an E. M. F. of not less than 4 volts will be required, and as no battery yet discovered will give a higher E. M. F. than 2.30 volts, whilst the most useful ones give less than 2 volts per pair of elements, it follows that for electro-plating work two or more cells in series must be employed to form a battery. The cells should not be less than  $\frac{1}{2}$  gallon capacity for all plating work.

§ 17. **Unsuitable Batteries.** Batteries with a high internal resistance, such as the general run of those used in electric bell and telegraph work, are altogether unsuitable to the work of electro-deposition. Batteries which soon polarize when a large current is demanded from them on a circuit of low resistance, such as the bichromate batteries in general use, are also unsuitable. Batteries of small cells should be avoided, except for trinket work in electro-gilding and silver-plating in a very small way, where their use is admissible.

§ 18. **Maintenance of Batteries.** One of the greatest objections to the use of batteries, lies in the daily labour necessary to keep them in working order. Batteries used in the work of electro-deposition, must receive as much attention as a horse. Before one can set to work with them in the morning, or to do a small job with them, every part must be cleaned and the cells freshly charged with solution. They must be watched during the day, and, should local action set in, which is shown by an excessive fizzing action of the acids on the zincs, they

must be taken to pieces and the zincs re-amalgamated. In the evening of each day, the battery must be taken to pieces and each part cleaned. The porous cells of double fluid batteries should be rinsed with water, after their acid contents have been placed in a pitcher or jug for use the next day. The cells should be kept in clean water. The zinc elements should be brushed, rinsed in water, and coated afresh with mercury. The binding screws should be cleaned and put away ready for use the next day. The acid solutions must be renewed whenever they are spent, which is shown by the sluggish action of the battery.

§ 19. **Amalgamation of Zincs.** The zinc plates used in batteries, are rarely made of pure metal. Even the best rolled Belgian zinc contains impurities. The effect of these impurities is seen in local action, in which the impure zinc forms with the purer particles a number of galvanic pairs. By coating the plates or cylinders of zinc with mercury, this tendency to local action is reduced to a minimum. As the plates or cylinders come from the maker, they are coated with a greasy film, unless sent out amalgamated. To remove this film, dip the zincs in hot water in which some washing soda has been dissolved, and rinse them in clean water. Pour some mercury in a shallow dish, such as a baking dish or a photographer's porcelain tray, and cover the mercury with a mixture of sulphuric acid and water, by adding one part by measure of sulphuric acid to three or four parts by measure of water. Some caution is always required when adding this acid to water, as the acid

combines with the water in such a violent manner as to cause great heat and spurting of the mixture. The consequences might be, serious damage to skin and to clothing, as the acid is very corrosive and will quickly destroy clothing. Therefore, always add acid *to the water* slowly, but never add water *to the acid*.

Place the zincs in the dilute acid and brush the mercury all over their surface with a mop made of fine brass wires and hemp, until all the surface has been made bright with the mercury. Then set the zincs aside in an empty dish to drain off the surplus mercury. Zincs must be re-amalgamated in a similar manner when any part of them have lost their coat of mercury, and bare grey patches appear on them whilst being cleaned. A wide plate brush will be found a very useful tool for brushing zincs after use in the battery. When zinc cylinders are used, the insides must receive most attention, as these are the parts subject to the action of the acid. Set the zincs in empty cells when not in use, to catch the mercury draining from them.

§ 20. **The Wollaston Battery.** Were I engaged in writing a history of voltaic batteries, I should trace their evolution upward from the pile of alternate copper and zinc discs invented by Volta, and note the improvement introduced by Cruikshank in his trough battery with copper and zinc plates, arranged alternately and soldered together; then mention its improvement by Babington, which consisted in dividing the trough into water-tight compartments or cells, with a pair of plates in each cell. I should then note a further improvement effected by

Dr. Wollaston, which consisted in doubling the negative surface of the elements, by inclosing the zinc in a loop of sheet copper. This improvement was a great advantage, as it secured a larger volume of current by reducing the internal resistance of the cells, and also utilized both sides of each zinc plate. The loop form of copper sheet, however, had its inconveniences, among the most prominent being the short circuiting and polarizing of the plates by pieces of amalgamated zinc falling in the loop and coating the copper with mercury.

In the improved form of the Wollaston arrangement, two copper plates inclose between them a plate of zinc in each cell. The copper plates should have their surfaces roughed with scratches, or have a coat of copper electro-deposited on them, as they then get rid of the hydrogen more freely than when the plates are smooth. The cells for this battery should be tall and thin rectangular vessels of glass or of stoneware, where compactness with a lifting arrangement for the elements is desired. An arrangement for lifting the plates is shown at Fig 1. The advantages of this battery are:—1. Low first cost, and easy construction. 2. By the lifting arrangement, the volume of current can be regulated to the work in hand, as the plates can be lifted to reduce the volume, or lowered to increase it as required. The disadvantages are:—1. One common to nearly all single fluid batteries, namely, that of polarization. Even when the copper plates are made rough, they do not throw off the hydrogen as fast as it forms on them. As a consequence, the plates become coated with a film of hydrogen in a short

time, and, as this exerts a counter E. M. F. to that of the zinc, besides offering a high internal resistance, the current rapidly falls. 2. Besides this defect, the copper plates get coated with a black slime composed of impurities found in the zinc and copper plates, and this slime increases the internal resistance of the battery.

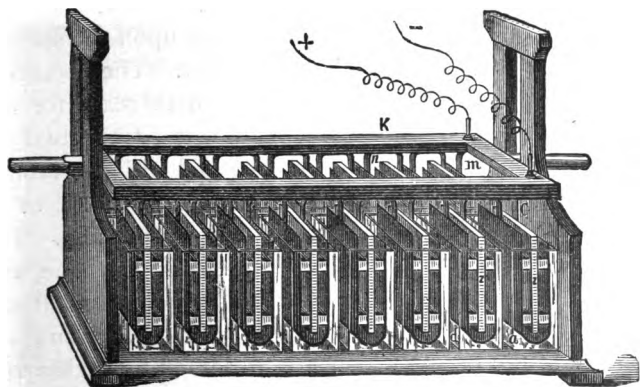

FIG. 1. THE WOLLASTON BATTERY.

C, Copper plate. Z Z, Zinc plates. K, Frame for lifting plates.

§ 21. **The Smee Battery.** The discovery by Mr. Smee of the fact that the negative plates in a Wollaston battery were improved by roughing their surfaces with sand-paper, together with the knowledge that platinum was more strongly electro-negative to zinc than copper, led him to substitute platinum plates made rough, instead of copper plates. He subsequently found that silver plates coated with platinum were equally effective and less costly. He prepared his silver plates out of silver foil in the fol-



lowing manner. The foil was first brushed over with a little strong nitric acid to give it a frosted appearance, then immersed in dilute sulphuric acid to which had been added a few drops of nitro-muriate of platinum, and connected to a piece of zinc dipping into a solution of sulphuric acid contained in a porous cell placed in the platinum solution. "Contact being made, the platinum will, in a few seconds, be thrown down upon the surface of the silver as a black metallic powder. The operation is now completed, and the platinized metal ready for use. However, iron, when thus prepared, is as effectual as silver, and may be sometimes employed with advantage. The metal generally employed is silver, because of its cheapness and its not undergoing any alteration. But whatever metal be used, the principle is the same, viz., providing a surface to which the hydrogen shall not adhere, but from which it shall be evolved; and the infinity of the points which are presented by such a surface as above described, appears to be the cause of this excellent result."<sup>1</sup> The nitro-muriate of platinum above mentioned, is prepared by heating platinum foil, sponge, or wire, in a mixture composed of two parts hydrochloric acid and one part nitric acid, until the acid ceases to act on the platinum.

In the Smee battery, the order of arranging the elements is reversed. Instead of employing one positive plate between two negative plates as in the Wollaston battery, Mr. Smee, out of regard to the cost of silver, employed one negative plate of silver foil between two

<sup>1</sup> "Elements of Electro-Metallurgy," Alfred Smee, 1851.

positive plates of zinc, the whole being clamped to a bar of wood, as shown at Fig. 2. By this arrangement some loss of zinc and effective electrical power is sustained, since only one side of each zinc plate comes into action. It would be much better to have two negative plates, one on each side of a zinc plate, and the cost would not be great if thin foil set in frames of silver wire (to insure rigidity) were employed. For large cells, the platinized foil may be tacked to a thin board previously saturated with melted paraffin wax to protect it from the action of the acid. Silver foil, ready platinized for the purpose, is sold by dealers in platers' outfits at about 10s. per oz. The cells of a Smee battery are charged with a solution of one part

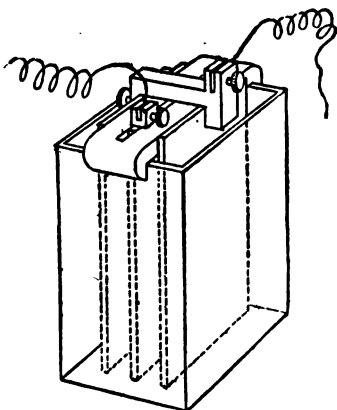

FIG. 2. SMEE CELL.

sulphuric acid in seven or eight parts of water. The E. M. F. of each pair is from .50 to .60 volt. The elements may be advantageously arranged on a lifting bar, as in the Wollaston battery, or as shown at Fig. 3.

Although the Smee is a decided improvement on the Wollaston battery, it does not utilize the full force obtainable from the consumption of zinc in acid, and rapidly fails in power if worked with a full current pass-

ing through a low resistance in the outer circuit. This is due to the counter electro-motive force exerted by the hydrogen collecting on the negative plate. Mr. Sprague estimates this force to be equal to 1.464 volts. Therefore if we take the highest possible force of zinc as 2.300

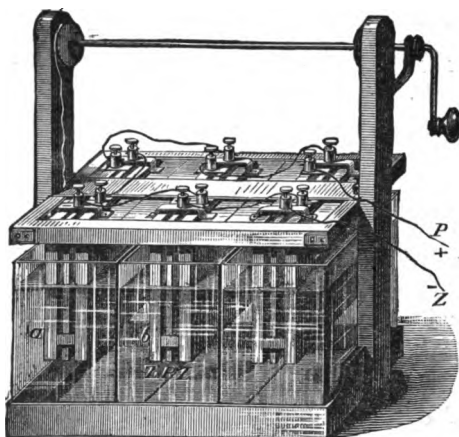

FIG. 3. THE SMEE BATTERY, WITH LIFTING FRAME.

*P*, Positive pole from platinized silver plate. *Z*, Negative pole from zinc plate.

volts, and deduct 1.464 volts as the counter E. M. F. of hydrogen, together with .260 volt as the counter E. M. F. of silver, we get a total E. M. F. of .576 volt as representing that of the Smee cell.

§ 22. **The Daniell Battery.** The battery invented by Professor Daniell, is composed of an outer cylinder or cell of copper to form the negative element, and a bolt of

zinc suspended in a porous cell to form the positive element. There are two cells, one inside the other, to form one compound cell, and two separate liquids. The outer cell, containing the negative element, is charged with a saturated solution of copper sulphate, and it

also contains a reservoir of crystals to keep the solution saturated, as shown at Fig. 4. The inner cell is made of porous earthenware, and is charged with a mixture of sulphuric acid in water, the proportions of which may vary from 1 in 10 to 1 in 15. The zinc bolt must not touch the porous cell, and is therefore suspended from a wood bar or cover placed on the cell.

Several modifications of this arrangement have been made to suit the wants of users. When the outer cylinder is corrugated, and a cylinder of

rolled zinc is employed in the porous cell, the power of the arrangement is increased, because the internal resistance of the cell is decreased. If a large porous cell is employed, containing a cylinder of copper filled with copper sulphate crystals, and a zinc cylinder is placed in the outer cell, it will not be necessary to suspend either of the elements. But, however the cell is made up, it is

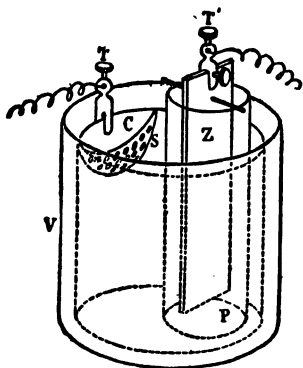

FIG. 4. DANIELL CELL.

- C*, Copper cylinder.
- S*, Pocket for copper sulphate.
- P*, Porous cell. *Z*, Zinc plate.
- V*, Outer cell.
- T T*, Binding Screws.

necessary to have the tops and the bottoms of the porous cells well soaked in hot paraffin wax before using them, to prevent endosmose of the copper salts, and formation of copper nodules in the pores of the porous cells. By employing outer cells of rectangular form, and flat porous cells, we may use plates instead of cylinders of copper and of zinc for the battery elements. In this form we may carry on electrotyping operations in the cells themselves by suspending the small moulds in the copper solution together with the negative plates. To the accidental discovery of this use of the Daniell cell, we owe, probably, the birth of the electro-plating trade. The Daniell battery is one of the most constant and least costly of any yet invented, if we take together the value of the materials used, the products obtained, and the work done by it. The strength of its current remains fairly constant throughout a working day, whilst that of the Smee falls to one third in the course of three hours. The working cost is set down by Mr. Sprague at 0.0584 of a penny per unit, as compared with 0.0438 of a penny per unit for the Smee, and 0.1570 for the Bunsen, but against this must be set the value of the pure copper deposited from the depolarizing solution of the Daniell, as compared with the useless product of the other cells. Its constancy is due to the perfect depolarizer employed, by which the hydrogen is absorbed in doing useful work, pure copper being deposited by it from the copper sulphate solution on the negative element.

But the Daniell has its disadvantages as seen from an electro-plater's point of view. It is troublesome to

set up and keep in order. Even when the tops of the porous cells are soaked in hot melted paraffin, the copper salts creep up the sides of the cells and over into the zinc solution, causing deposition of copper on the zinc, and consequent local action, unless the circuit is kept constantly closed. The permanent closed circuit may be through a very high resistance, however, such as a fine wire of German silver, and thus the waste of zinc may be kept down. The zincs become very dirty, and are with difficulty kept in working order. They need frequent attention and cleaning. Bits of zinc fall to the bottoms of the porous cells and induce nodules of copper to form in the pores, whilst the salts of copper will also crystallize in the pores above solution line and disintegrate the cells.

Notwithstanding these disadvantages, it is a very useful cell to the small electro-typer and electro-plater with constant work on hand requiring a constant current for several hours in succession. The E. M. F. of each pair of elements in a Daniell battery, is 1.07 volts.

§ 23. **The Bunsen Battery.** The battery invented by Professor Bunsen, consisted of a cylinder of compressed and baked coke-dust immersed in strong nitric acid in the containing cell, and a rod of zinc immersed in dilute sulphuric acid in the inner or porous cell. This arrangement is now reversed, and we have a bar of carbon in the porous cell with the nitric acid, and a cylinder of rolled zinc in the outer cell with the dilute sulphuric acid. The outer cells may be round, or square, or oval, and are generally made of stoneware. The

inner porous cells are round or flat as may be required. Plates of carbon and plates of zinc may be used instead of bars of carbon and cylinders of zinc. Fig. 5 shows a type of Bunsen cell introduced from America for nickel-plating purposes. This cell furnishes a large volume of current, as its internal resistance is low. The solution of dilute sulphuric acid may be of any strength

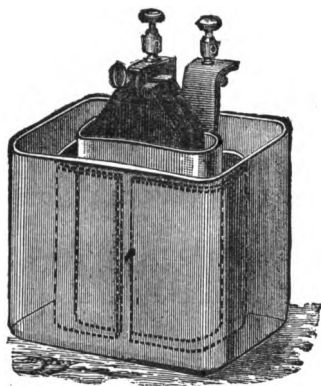

FIG. 5. AMERICAN BUNSEN CELL FOR NICKEL-PLATING.

from 1 in 7 to 1 in 15. The nitric acid must be strong commercial acid. The zincs must be well amalgamated, but there will be little trouble in keeping them in working order if a little mercury is kept in the cells whilst the battery is at work, and care is taken to prevent spilling of the nitric acid in the sulphuric acid solution. It is an easy battery to set up and keep in working order, and fur-

nishes at all times a full and constant current. Its E. M. F. is about 1.80 volts for each pair of elements, and the internal resistance of the cells low. The inconvenience attending its use, lies in the deleterious fumes of nitrous oxide given off from the depolarizer whilst the battery is at work; these become intolerable in a small ill-ventilated workshop, and are specially troublesome in damp weather. The battery should therefore be kept in a well-

ventilated cupboard, or in a shed or box outside the workshop.

§ 24. **Construction and Maintenance of Batteries.** In the construction of batteries for electro-deposition, we must be guided by the requirements of the work. These demand a full, constant current at a low tension. To insure the first condition, we must use large cells, and have therein plates with a large surface. The outer cells should be of not less than half-gallon size, and may be of ten-gallon size with advantage in such batteries as the Smee and Wollaston. The plates or cylinders must be large, to correspond with the cells, but, in the Smee and Wollaston with lifting arrangement, there should be at least one inch free space below the plates when they are fully immersed; this space being needed to prevent short circuiting and local action caused by particles of metal falling from the plates to the bottoms of the cells. It is a well-known rule, that the surface of the plates in a battery should slightly exceed that of the anodes in the depositing solution, and these should present a surface slightly in excess of the surface to be plated. When cells are arranged in series, we can only calculate the surface of the plates in one cell, all the others being employed in pushing the current through the resistance in the circuit. Large cells and large plates insure a low internal resistance of the battery, and consequently more force for use in the outer circuit, since the strength of the current will be equal to the force of the battery divided by *all* the resistances in the circuit. To insure constancy, both the exciting and the depolarizing liquids



must be in a condition to work through the required time. The internal resistance of a battery increases as the acids in the exciting liquid approach saturation with zinc, but a battery will work well up to a point of half-saturation. In the Daniell battery, the depolarizer is kept in working order whilst the cell is kept charged with copper sulphate crystals. In the Bunsen battery, the depolarizer is exhausted when its colour passes from a deep to a light green, and is fumeless when poured from the cell. It must then be thrown away and fresh nitric acid used in its place. The zinc plates must always be kept well amalgamated with mercury. The carbons should be of a dense, close composition, because this is a better conductor than soft, spongy carbon. The clamps and binding screws should be massive, and present a clean, broad contact surface to the plates. The connecting wires should be large. It is useless having a large conductor from the battery to the vat if the connecting wires between the cells are small. When wooden supports are required, they should be made acid proof by soaking them in melted paraffin wax. This substance is solid paraffin, obtainable from all dealers in electrical sundries. It is the best insulator known. It should be melted on a water bath to prevent burning, and the article to be treated with it should also be made hot before the melted paraffin is applied.

§ 25. **Batteries for Electro-Plating.** Experience has proved the following as being the most suitable work to each battery. *Electro-Gilding*: One or more cells of either the Wollaston, Smee, Daniell, or Bunsen. *Electro-*

*Silvering*: Two or more cells in series of either the Wollaston, Smee, Daniell, or Bunsen. For large operations through long periods, the Daniell is superior to the others. *Electro-Nickeling*: Three or more cells of the Bunsen in series. *Electro-Coppering*: From alkaline solutions, the same as for nickeling. *Electro-Brassing*: Six or more cells in series of the Bunsen battery. *Electro-Typing*: One or more cells of the Wollaston, Smee, or Daniell. Although good work has been done by the Smee, and can be done by it, the Daniell is preferable in long sustained operations. In choosing a battery, or in determining the number of cells to be used in series, we must be guided by the resistance of the work to be done in the circuit, or more strictly, the total resistance in the whole circuit. If the resistance is high, we must employ a sufficient number of cells in series to push the required current through the sum total of *all* the resistances. It is just possible we may find the E. M. F. of a battery current too high to deposit the metal in good condition when the resistance in the circuit is also high, because there is little internal resistance in the battery cells. This defect may be remedied by giving the battery more work to do, as by dividing the circuit, when the increased volume of current through the cells will increase their internal resistance and lessen the E. M. F. of the battery. It should be understood, however, that the current in a divided circuit will be proportioned to the various resistances in the circuit (if these differ one from another), the lower resistance taking a larger volume of the current than the high resistances. If, therefore, we are operating

on work offering a high resistance, and finding that the E. M. F. of the current is too high, divide the circuit by placing in it a branch offering a lower resistance than the work to be done, we shall probably find too much current passing through the low resistance, and an insufficient quantity going through the work.

§ 26. **How to arrange Battery Cells.** In some of the old text-books treating of electricity, we find directions for coupling the cells up together "for quantity," and again "for intensity." These old expressive terms (meaning respectively for volume, and for tension) have



FIG 6. BATTERY CELLS CONNECTED IN SERIES.

been superseded by the modern terms "coupling the cells in multiple arc, or in parallel," to give a large volume, and "coupling the cells in series," to increase the tension of the current. As the difference between these two arrangements can be more clearly shown by illustrations than by a whole page of letterpress, two diagrams are here given to illustrate both arrangements. In Fig. 6 the cells are shown arranged in series, the zinc in one cell being coupled to the carbon of the next, and so on through the whole line of cells. By this arrangement we get the E. M. F. or pushing force of each cell added to that of its neighbour, and we also get the internal resistance of each cell added in a similar manner. But, we only get the volume of current generated in one cell. This is shown by the following figures, calculated according to a law discovered by Professor Ohm, and

now known as Ohm's law.<sup>1</sup> Supposing the E. M. F. of each cell to be 1·80 volts, and the internal resistance of each cell 0·06 ohms, then, taking three cells in series, the figures will be :—

$$\frac{1\cdot80 + 1\cdot80 + 1\cdot80 = 5\cdot40 \text{ volts}}{0\cdot06 + 0\cdot06 + 0\cdot06 = 0\cdot18 \text{ ohms}} = 30 \text{ ampères.}$$

But, if we take only one cell, the figures will be :—

$$\frac{1\cdot80 \text{ volts}}{0\cdot06 \text{ ohms}} = 30 \text{ ampères.}$$

The difference being, in the first case we get a current of 30 ampères at a pressure of 5·40 volts, whilst in the second case we get the same current of 30 ampères at a pressure of only 1·80 volts.

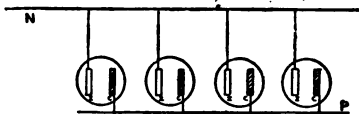

FIG. 7. BATTERY CELLS CONNECTED IN PARALLEL.

In Fig. 7 the cells are shown arranged in parallel, the zincs being all coupled to one conductor, and the carbons to the other conductor of the circuit. By this arrangement we convert the three cells into a combination equal to one large cell, and get the E. M. F. of one original cell divided by one third of its resistance, since there are now three paths of presumably equal resistance open to the passage of the current. The figures therefore are :—

<sup>1</sup> Ohm's law may be thus expressed : The total value of current obtainable from any generator of electricity, may be ascertained by dividing the electro-motive force of the current by *all* the resistances in the circuit. This includes the internal resistance of the generator as well as the resistances of the conductors.

$$\frac{1.80}{0.06 \div 3 = 0.02} = 90 \text{ ampères, at a pressure of only } 1.80 \text{ volts.}$$

It must be understood, however, that this only represents the current at the battery terminals, and only at the first moment of closing the circuit, as the internal resistance of the cells rises rapidly and the E. M. F. falls when the circuit is closed. When the external resistance of the circuit is added to the internal resistance of the battery, we shall get far different results of a more practical value. Supposing, for instance, that the resistance of solution, slinging wires, and leading wires amount to the total of 1 ohm, then the figures will be, in the first arrangement :—

$$\frac{1.80 \times 3 = 5.40}{0.06 \times 3 + 1.00 = 1.18} = 4.57 \text{ ampères.}$$

Whilst in the second arrangement we should have the following result :—

$$\frac{1.80}{0.02 + 1.00} = 1.76 \text{ ampères.}$$

This will show how useless it will be to couple up cells in parallel to a high resistance in the outer circuit, such as would be met with in actual plating practice. But, if we take four cells and couple them as shown in Fig. 8, which may be

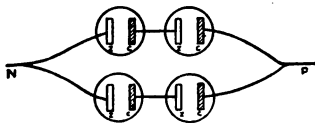

FIG. 8. BATTERY CELLS CONNECTED IN PARALLEL SERIES.

described as coupling in parallel series, we get the following results as shown by figures :—

$$\frac{1.80 \times 2 = 3.60}{0.03 \times 2 + 1.00 = 1.06} = 3.39 \text{ ampères.}$$

Thus, by arranging the cells in groups, in either series, parallel, or parallel series, we may get the required volume of current through the work at the pressure suitable to the deposition of the metal in a proper condition. It is preferable to so arrange cells, instead of dividing the circuit as shown in the preceding section, or adding resistances to keep back the current.

## CHAPTER III.

### DYNAMO-ELECTRIC PLATING MACHINES.

§ 27. **Electro-Deposition by Dynamo.** Reasoning from the data supplied by the foregoing figures, there should be no difficulty in obtaining any desired volume and tension of electric current from galvanic batteries. If this were the case, we should be able to undertake electro-depositing work of any magnitude with current derived from this source. Providing we could obtain the necessary volume and tension of current, it would matter but very little from what source it was obtained. It is found, however, in practice, that there is a limit to the magnitude of operations capable of being carried to a successful issue with current obtainable from batteries. The current is not constant, even from the most constant battery. From the time of setting up the cells in the morning, up to the conclusion of the day's work in the evening, there are forces at work inside the cells which tend towards a gradual diminution of the current in the working circuit. These are, mainly, increased internal-resistance, due to alteration of the exciting liquid consequent upon its increasing charge of zinc salt, and a similar alteration in the depolarizing liquid caused by an

abstraction of its oxygen, and conversion of this, together with hydrogen, into water. These alterations are most rapid when the resistance of the outer circuit is low, as when a number of articles to be plated are placed in the vats at one time. Therefore, just as a larger volume of current is needed to meet the larger demand, it falls lower from a battery, because of increased internal resistance of the cells. Batteries also entail the employment of much time and labour in setting up the cells and in putting them away after the work is finished. They are also costly in working, since the price of zinc and its excitants is high, and the wear and tear very great.

All these objections to the use of batteries has led to the adoption of dynamo-electric machines as generators of current whenever the work in hand has demanded a large and constant current. The current from a dynamo, when properly constructed and driven, is constant, varying only with the speed at which it is driven, or with the resistance of the bath. The volume of current obtainable from a dynamo constructed specially for electro-plating purposes is very large, and the tension of the current is so arranged as to be just high enough to deposit the metal in good condition. When the machine is so constructed as to have its field magnet coils connected in shunt with those of its armature, the strength of its current (within a certain limit) is self-regulated by the work to be done in the outer circuit. This provision (which will be more particularly noted in another section) makes the dynamo a most valuable generator of current for electro-plating purposes.



§ 28. **Origin of the Dynamo.** The origin of the dynamo may be said to date from the time when Professor Oersted, of Copenhagen, discovered that an electric current passing through a coil of wire produced an inductive effect on a magnetic needle placed beneath it, or, in other words, an electric current passing through a wire, exerted magnetic effects on iron and steel placed near the wire. This discovery led Michael Faraday, in 1831, to think that, since a magnetic effect could be produced in iron by a current of electricity, a magnetized piece of steel in motion should produce an electric current. He therefore procured a long spiral or helix of copper wire, and connected its ends to a galvanometer. He next procured a powerful bar magnet and introduced it into the spiral of wire. This being done, he noted that a deflection of the galvanometer needle took place instantly when he placed the bar magnet in the coil, and an opposite deflection was caused when the magnet was withdrawn. This discovery led him to make a machine in which a disc of copper connected by wires to a galvanometer was caused to revolve between the poles of a powerful horse-shoe magnet, and thus set up a current of electricity in the wire. Other experimenters followed on the same lines, and, in the course of a few years, the magneto-electric machine was so far developed as to produce brilliant sparks, give powerful shocks, and effect chemical decomposition. In 1835 Mr. Saxton constructed a powerful magneto-electric machine with a compound horse-shoe magnet made up of steel plates, and a soft iron armature wound with helices of silk-covered copper

wire. The representatives of this machine still exist in the magneto-electric shocking machines sold for medical purposes. The first practical application of Faraday's

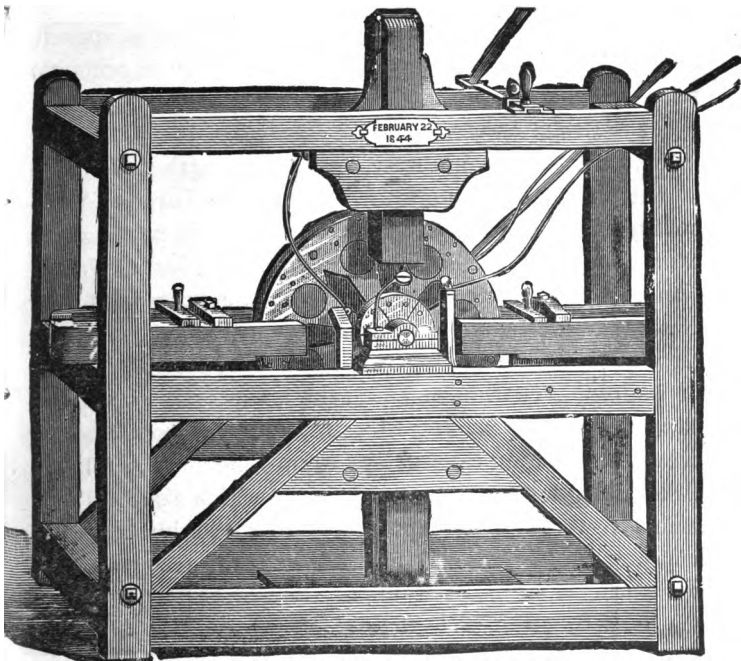

FIG. 9. WOOLRICH'S FIRST DYNAMO-ELECTRIC MACHINE.

wonderful discovery to the art of electro-deposition, was made by Mr. J. S. Woolrich, of Birmingham, who patented in 1842 the first magneto-electric plating machine (shown at Fig. 9). In 1844 this machine was finished and successfully worked by Messrs. Prime and Sons, of

Northwood Street, Birmingham, and was in operation at their works for many years. It has since been presented to the Corporation of Birmingham, and is preserved as a valuable and interesting relic. It is said that Faraday visited the works of Messrs. Prime and Sons purposely to see the application of his discovery to a practical purpose.

§ 29. **Evolution of the Plating Dynamo.** It is not my intention to trace minutely, step by step, the evolution of the plating dynamo from the time of Faraday's discovery until the present day; but to note, in passing, the transition from the magneto-electric machine of Woolrich to the dynamo of Wilde. In the year 1865 Mr. Henry Wilde secured a patent for the first dynamo-electric machine employed for the purposes of electro-deposition. In this machine the inventor hit upon the happy device of causing the small current from a small Siemens machine to circulate round the coils of a large electro magnet, between the poles of which a second and much larger armature was caused to rotate by means of a powerful engine. From this second armature the working current was obtained. The invention of Wilde has been of great service to electro-depositors, and improved Wilde machines are now at work in Sheffield and Birmingham. The idea of dispensing altogether with permanent magnets, and of producing the current by means of the feeble magnetism set up in masses of soft iron by the earth, or otherwise, strengthened by the passage of a portion or the whole of the current thus set up round the coils encircling these masses of soft iron,

is due to Dr. Antonio Pacinotti, who, in 1864, devised the first real dynamo. This principle—"the conversion of *dynamic or mechanical force* into *electric force* without the aid of permanent magnets"—is the foundation of all dynamo electric machines, and was soon adopted by M. Gramme, Dr. Siemens, Sir Charles Wheatstone, and other scientific men.

### § 30. What is a Dynamo?

A dynamo-electric machine is a machine constructed to convert dynamic or mechanical force into electric energy. We have already seen in § 29 that a moving bar magnet will induce a current of electricity in a helix of copper wire surrounding the magnet. The influence of a magnet is not only felt in a wire wrapped around its poles, but extends to a considerable distance beyond them. In the case of a horse-shoe magnet the magnetic influence fills the space between the poles, and extends beyond them, as shown at Fig. 10. This space, thus filled with magnetic lines of force, is named the magnetic field. If we wrap some folds of insulated copper wire around a bar of iron, and cause it to move in this magnetic field so as to cut the lines of force, a current of electricity will be induced in

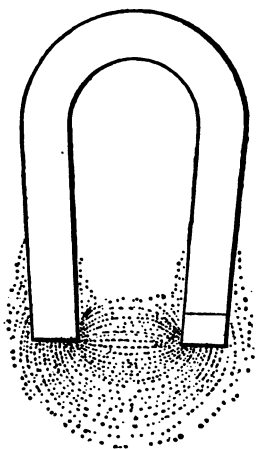

FIG. 10. HORSE-SHOE MAGNET. SHOWING LINES OF MAGNETIC FORCE.

the folds of wire wound on the iron bar, by the cutting of the lines of magnetic force through which it moves. If now we wind some insulated copper wire around the legs of the magnet, we shall get a current of electricity set up in the magnet coils as well as in the coils of wire surrounding the iron bar. Proceeding further, we shall

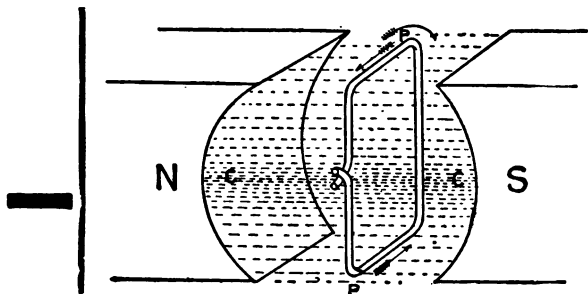

FIG. II. DIAGRAM SHOWING HOW THE LINES OF MAGNETIC FORCE IN THE FIELD OF A DYNAMO ARE CUT BY THE WIRE ON ITS ARMATURE.

*N*, North pole. *S*, South Pole. *CC*, Most intense part of magnetic field. *PP*, Coil of wire. Curved arrow shows direction of rotation of armature. Straight arrows show direction of current in armature coil.

note that in the field of a horse-shoe magnet there is a neutral zone in which there are few lines of magnetic force to be cut by the moving bar.<sup>1</sup> It follows, therefore, that the electric inductive influence of the magnet on the armature coils will be greatest where the lines cut are thickest. (See Fig. II.) As the armature is

<sup>1</sup> It must be borne in mind, that unless the lines of force are *cut* by the coils, no current is set up. If the motion is parallel to the lines of force, no effect is produced.

made to move in the magnetic field, there will be two strong magnetic impulses and two reversals. If we can connect the ends of the armature coil to the ends of the magnet coil so as to send the strong impulses through this coil in one continuous direction, the effect of this current of electricity flowing through the magnet coils will be an increase of magnetic strength in the magnet. This is done in a dynamo machine by means of a device named the commutator. A commutator is made in the form of a split ring of brass mounted on an insulated hub, and fixed to the spindle of the armature. The two ends of the armature coils are fixed to the two sections of the commutator, and the current is picked up from these by two strips of metal named brushes. In some armatures there are several coils. When this is the case, the commutator has as many segments as there are coil ends, but the action is the same. As the coil of wire passes out from the most intense part of the magnetic field into the comparatively neutral zone, the impulse given to it is interrupted by a division in the commutator, and diverted by way of the brush to the magnet coil or to the outer field. In this way a current of electricity is generated by motion of the armature in the coils of wire wound on this and on the field magnets, and the machine becomes a generator of electricity. We have already seen in § 30 that a permanent magnet is not necessary, in fact the best modern machines are those in which soft malleable iron is used in their construction. This subject is more fully treated by Messrs. Hawkins and Wallis in their work on "The

Dynamo,"<sup>1</sup> and in "The Dynamo: How made and used," by S. R. Bottone, Wallington, Surrey.

§ 31. **Plating Dynamos.** In the preceding section some idea is given of a dynamo-electric machine, and the reader is directed to books which will give full instructions on how to make these machines. A plating dynamo differs from those in general use for electric lighting in the following important particulars. The machines in general use for electric lighting are constructed to yield an electric current of high tension to overcome high resistances in the outer circuit. Plating dynamos are constructed to give a large volume of current at a low tension, as the resistances in the circuit are always low, and a high E. M. F.—a quality not desired in electro-deposition. The tension of the current from a dynamo depends upon the number of yards of wire wound on the armature of the machine, and the speed at which the armature revolves. It is estimated that each yard of wire will develop one volt when the armature has an angular velocity of 1,250 ft. per minute. Therefore, to keep down the tension of the current in a plating dynamo, a large wire is used, and the speed is kept low. As a large volume of current is required, the wires must be large enough to carry the current safely, and the internal resistance of the machine be kept low. The field magnets should be massive, to allow of being magnetized to a high extent without reaching the limits of magnetic saturation. As the volume of current is largely affected by the position of the brushes, these

<sup>1</sup> Published by Whittaker and Co., price 10s. 6d.

should be attached to a movable rocker, to allow of being adjusted to any angle required.

§ 32. **Winding a Plating Dynamo.** In designing a plating dynamo, as in all others, the resistance of the outer circuit has to be taken into consideration. The probable resistance of the plating solution, slinging wires, and wires conducting the current from the dynamo to the vat being known, the armature must be wound with a coil of wire offering a resistance of  $\frac{1}{20}$ th the working resistance of the outer circuit. This being done, we must wind the field magnets with coils of wire having a total resistance 400 times that of the armature, or 20 times the total working resistance of the outer circuit.

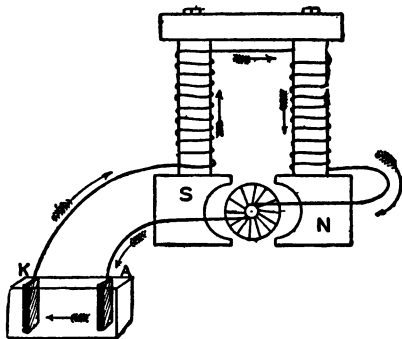

FIG. 12. DYNAMO MACHINE CONNECTED IN SERIES SENDING CURRENT THROUGH PLATING VAT.

The armature coils should be connected in shunt with the coils of the field magnets, to insure constancy in the current under varying loads, and to prevent reversal of the magnetism in the dynamo by the current being sent through the field magnet coils in the wrong direction. It should be understood by every plater, that all solutions through which a current has been passing, form in themselves a galvanic battery,



with the articles being plated and the anodes as elements. As a rule the plated articles are the positive elements, and the anodes the negative elements, in this battery. The current generated by these is therefore opposite to that employed in the work of electro-plating. If the coils of the field magnets of a dynamo are connected in series with those of the armature and the outer circuit, as shown at Figs. 12 and 13, this back current from

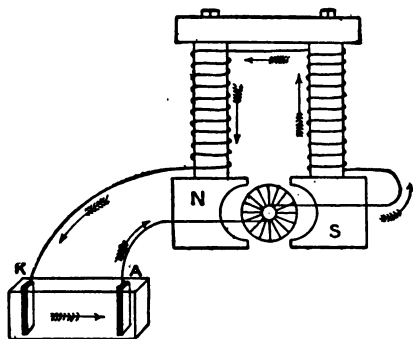

FIG. 13. DYNAMO MACHINE CONNECTED IN SERIES BEING REVERSED BY CURRENT FROM THE VAT.

the solution will rush around the coils immediately on stopping the machine, or on slowing down the speed of the motor, and will reverse the poles of the field magnets by inducing in them an opposite condition of magnetism to that existing whilst the machine is in proper working order. After such an accident, the machine will generate a current flowing in the opposite direction, or in unison with the solution current, and thus dissolve off the metal deposited on the plated articles. This is prevented by connecting the field magnet coils in shunt with the armature; should the back current from the solution become sufficiently powerful to pass round the field magnet coils, it passes

the solution will rush around the coils immediately on stopping the machine, or on slowing down the speed of the motor, and will reverse the poles of the field magnets by inducing in them an opposite condition of magnetism to that exist-

in the same direction as it is sent by the dynamo itself, and therefore does not reverse the sub-permanent magnetism of the field magnets. This will be best understood by reference to Figs. 14 and 15.

In a machine wound for electro-plating, with the coils connected in shunt, the magnetism of the field magnet cores will be proportionate to the resistance in the outer circuit. If there are several articles suspended in the solution, and a proportionate surface of anode, the resistance of the outer circuit will be low, and the greater volume of current will flow by the path offering least resistance, which will be, in this case, through the solution. As a consequence, only a small portion will pass around the field magnet coils, and thus the magnetic in-

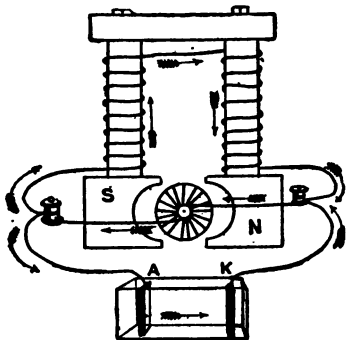

FIG. 14. SHUNT-WOUND DYNAMO SENDING CURRENT THROUGH PLATING VAT.

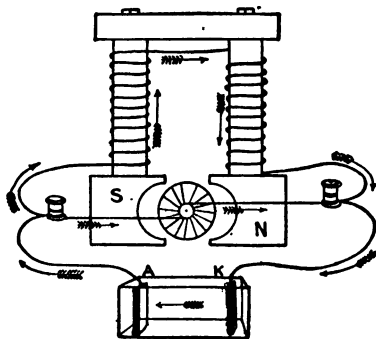

FIG. 15. CURRENT FROM PLATING VAT GOING ACROSS AND THROUGH SHUNT-WOUND DYNAMO.

tensity of the fields will be low. If, on the contrary, the resistance in the outer circuit is high, as when only a few articles are immersed in the solution, the path of least resistance will be by way of the field magnet coils; the armature current will flow by this path, increase the intensity of the magnetic field, and raise the tension of the current, thus enabling it to overcome the increased resistance in the outer circuit. Hence the necessity of having the resistance of the field magnet coils so many times greater than that of the estimated highest resistance likely to be placed in the working circuit.

§ 33. **Choice of a Dynamo.** In the early days of dynamo machines in use for electro-deposition, the makers were few and far between, thus leaving the depositor but a small field of choice. At the present day any good maker of dynamos will make a machine for electro-deposition, and some well-known firms give special attention to this branch of their business. As a consequence, the field of choice has become enlarged, and choice becomes correspondingly difficult among so many good machines. In the succeeding sections I shall notice a few of the leading names, but must leave their respective merits to be judged by the rules set up in the following observations. In choosing a new dynamo, see that it is SHUNT wound; that is, that the wires from the field magnet coils are connected one to each brush, and that the terminals which lead to the outer circuit are also connected one to each brush. Let no machine be accepted that is not shunt wound, since, although the series machine is cheaper for a given output, yet it is sure to

reverse sooner or later. It is true that mechanical devices have been employed to prevent the injurious "back flow" of the current from the vat, but these are not always trustworthy. The best will be described in their place. "Compound" wound machines, which possess both shunt and series coils, are equally liable to reversal; but these machines may be used in special work requiring a constant low voltage through varying resistances in vats connected in parallel with this type of dynamo. Get the maker to guarantee the output of the machine in current, the speed at which it must be driven, and the power necessary to drive it. The output should be expressed in ampères, but may be given in ounces of metal deposited per hour, this being more easily understood by platers than units of measurement. Some makers express the output of the machine by so many square feet of exposed cathode surface, thus giving the plater some idea of the surface of goods he can cover at the same time. In the sections devoted to the deposition of each metal, I give the power needed to deposit a given quantity of metal in a given time. From this the depositor can choose a machine to suit his own requirements. The rule being different for each different metal, a general rule applicable to all cannot be given. The machine chosen, should have a broad, firm base, so as to stand steady whilst being driven. Its bearings should be long, and provided with means to keep them well lubricated, to prevent heating in this part whilst at work. It must be well ventilated by air spaces between the coils, to keep them cool whilst the machine is at work.

Heating of the machine coils and bearings mean a loss of power in the outer circuit, and a loss of driving power, since heat absorbs the force which should be converted into electricity. The driving pulleys should have broad, smooth surfaces, to prevent loss of power by slipping belts, and the machine should be driven from a counter-shaft. All wearing parts should be so arranged as to be easily got at and removed for repair. This applies specially to the brushes, brush-holders, and commutator bars of the machine. The brush-holders should not be fixed to any part of the machine, or to pillars screwed into the base of the machine, but should be attached to a rocking bar pivoted in such a manner as to allow of free movement through the arc of a circle, for the easy adjustment of the brushes to any angle. The commutator bars should be of hard brass, gun-metal, or phosphor bronze. The brushes may be of copper foil, phosphor bronze foil, or fine copper gauze. A pad made of several thicknesses of copper gauze is superior to any other when working on hard brass, or on gun-metal. The brush-holders should be pivoted on the rocker, and furnished with springs to exert an equal and gentle pressure on the brushes.

In choosing a second-hand dynamo, the foregoing hints should be taken advantage of, and special attention should be paid to the condition of the spindle of the armature and its bearings. If these are much worn, allowing much side shake,<sup>1</sup> the value of the machine

<sup>1</sup> End play is not only admissible, but advisable, since it prevents *grooving* of the commutator.

will be lowered, since these parts will have to be renewed. If the commutator is much worn, this also will have to be renewed. The probable cost of such renewals must be taken into consideration when purchasing the machine. If the spindle is very loose, there may be some damage done to the faces of the armature and also to the faces of the field magnets. Such damages may necessitate a renewal of the armature and re-boring the armature tunnel, besides the trouble of unwinding and re-winding the coils. After such damages, the insulation of the wires may be destroyed, and thus rendered useless. A second-hand dynamo should therefore be closely examined before being purchased, as it may appear all right on the exterior, whilst its interior condition may render it of the mere value of old metal.

§ 34. **Types of Plating Dynamos.** The following are some of the types of plating dynamos now in use. Some of these are almost obsolete, and will be abandoned as they get worn out. Some of the best and latest types will be more extensively noticed in succeeding sections. Amongst old type machines, may be mentioned the Wilde (old type), Holmes, Gramme (old type), Ladd, Wallace-Farmer, Weston (old type), Siemens (old type), Gülcher, Schuckert, and Burgin machines. Many other makes of dynamos have been adapted to the work of electro-deposition.

Among the new type machines we may mention the improved Wilde, Weston, Gramme, Manchester, and Siemens machines, and the more modern Kapp or over-type dynamos, with their armature tunnels above the

field magnet coils, their armatures being of drum, pole, or ring types. For the sake of clearness we will divide these various dynamos into three great classes, viz. :

1st. Those with "*drum*" or cylindrical armatures, in which the wire is wound longitudinally in two or more slots.

2nd. Those with radial or peripheral arms or spokes, around which the coils are wound ; known as *pole* armatures.

3rd. Those in which the armature takes the form of a ring, around which the wire is coiled longitudinally, both inside and out.

§ 35. **The Wilde Dynamo.** Beginning with the first or cylindrical armature, we may notice the old form of Wilde's machine, in which a small cylinder of soft iron, about three times as long as its diameter, with a channel about  $\frac{1}{3}$  the diameter all round it longitudinally, is wound with wire,<sup>1</sup> connected to a "two-part" commutator. This armature was constructed to run at a high speed between the poles of a powerful steel magnet. The current thus produced, was led to the wire coils which surrounded a much larger cast-iron electro magnet. The polar extremities, or "pole pieces," of this electro magnet, were made very massive, and a tunnel bored out between them, in which a second much longer cylindrical armature was caused to rotate. This second armature was similar in general construction to the first, but very much larger. The wire also with which it was wound was

<sup>1</sup> Also known as the "old Siemens armature," or "H girder armature."

very much stouter, so as to present less resistance, thereby insuring a larger current. Since this machine was separately excited (*i.e.*, the magnetism of the larger field magnets was dependent on the separate current produced by the smaller dynamo) it was not subject to "reversal"; but owing to the fact of the armatures being both *solid*, which favours the generation of Foucault or "eddy" currents in the iron, the armatures soon became very hot, so that, unless special devices were made use of to keep the rise of temperature within bounds, the covering of the wire of the armature coils was soon charred, and the insulation broken down. The favourite device for keeping down the excessive heat generated by those Foucault currents, was to run a stream of water into the interior of the armature cylinder, through the shaft. Apart from the mechanical difficulty of doing this in such a manner as to preclude leakage of water, there remained the fact, that the generation of Foucault currents meant so much power wasted, which should have appeared in the outer circuit.

§ 36. **The Ladd Dynamo.** Closely allied to the Wilde machine, was the dynamo designed by Mr. Ladd, of Beak Street, Regent Street. In this the permanent steel magnet was done away with altogether: two soft iron slabs, lying horizontally and parallel to one another, took its place, and acted at once as the exciting and the generating electro magnets. To effect this purpose, each slab was wound with insulated copper wire, so as to produce an electro magnet with poles of opposite name at the two extremities. These two electro magnets were



then arranged over one another, with opposite poles facing, and between the two polar extremities, at each end, armatures precisely similar to those described at § 35 were caused to rotate. The two armatures were not of the same size ; the smaller produced a current which was sent directly round the coils of the electro magnets ; the larger one furnished the current which went round the outer circuit, and was totally separate from the electro magnet coils. The novelty of this machine consisted in the application of the theory of the conversion of energy, and of the cumulative effect of the current. The iron slabs, either by percussion during manufacture, or by intentionally passing current round the coils afterwards, acquired a weak sub-permanent magnetism. When the smaller armature was rotated, a weak current was set up in its coils ; this current was collected and transmitted (rectified by the commutator) through the field magnet coils. This current yet further enhanced the magnetic condition of the electro magnets ; which, in their turn, induced more powerful currents in the armature coils. This cumulative effect increased, until the limit of magnetic saturation was reached, when the two slabs became powerful magnets, and induced in their turn powerful currents in the larger armature rotating between the poles at the other end of the slabs. This machine, like the Wilde, had the advantage of not being subject to reversal, but, owing to the solid armature, the heating was excessive, and the old device of streams of cold water circulating in the inside of the armature was resorted to in order to mitigate this evil.

§ 37. **The Siemens Dynamo.** The old form of Siemens' dynamo next claims our attention, more especially since there are several machines of this type (under new names) which are extensively sold even at the present day. In this machine, shown in diagrams at Figs. 12 to 15, we have a pair of iron field magnets, nearly square, the section of which is a trifle over  $\frac{1}{2}$  the height or width. At the top they are joined together by an iron cross piece or "yoke," while below there are enlargements or "pole pieces" which form a segment of a circle (about  $\frac{1}{3}$  on each field magnet), so that they conjointly give rise to a tunnel in which the armature can turn. The field magnet cores are wound with sufficient wire to treble their original bare diameter, and of such a gauge as to present about  $\frac{2}{3}$  the resistance of the wire put on the armature. The armature consists of a cylinder of soft iron, about three times as long as its diameter, with a deep, wide, square channel cut all round its length, so that the section of the armature is that of an H girder with rounded sides. In this channel is wound longitudinally a sufficient length of wire to give the desired E. M. F., of such gauge as to present a resistance equal to  $\frac{1}{20}$  of the entire outer circuit, and of such section as to convey the necessary current without injurious heating. This armature is fitted with a spindle and a "two-part" commutator, on which brushes rest, above and below, to pick up the current generated. The armature is supported at either end by brass bearings, and at one end with a driving pulley or "rigger." One of the brushes is connected to the wire of one of the field

magnet coils, while the other brush is connected to one terminal. The other terminal is connected directly to the other field magnet coil wire, as shown at Fig. 13, § 32. In other words, the machine is series connected. The defects of this form of dynamo are many. In the first place, owing to the "Foucault" or "eddy" currents set up in the solid mass of the iron armature, this latter soon gets dangerously hot, so that such a machine is only fit for short runs, not exceeding twenty minutes each. Secondly, as it is series wound it is almost sure to reverse, either when the plating vat has acquired sufficient "polarity" to send a back current as strong as the dynamo, or when the engine slows down, so that the electro-motive force of the dynamo falls below that of the electro-plating vat itself.

§ 38. **The Weston Dynamo.** Closely allied to the old Siemens in general principles, though differing considerably from it in outward appearance, is the "Weston" electro-plating machine. In this, the field magnets take the form of a cast-iron cylinder (see Fig. 16), having for pole pieces six internally projecting electro magnets with steel cores. These are attached by bolts to the inside of the cylinder, and point towards the centre. The wire coils of the six field magnets form one circuit; but the wires are wound so that adjacent poles are of opposite polarity. In order to magnetize these electro magnets, the currents generated in the armature are conducted through their coils on the dynamo-electric principle. The armature is a cylinder similar to the one last described (§ 37), with the difference that it is furrowed

with six longitudinal channels, the projecting shoulders of which are wound with wire connected in series. The commutator (F E) consists in two wide rings insulated from each other, each ring having three equidistant square teeth and three equidistant square gaps between the teeth. These two rings are so placed on the spindle

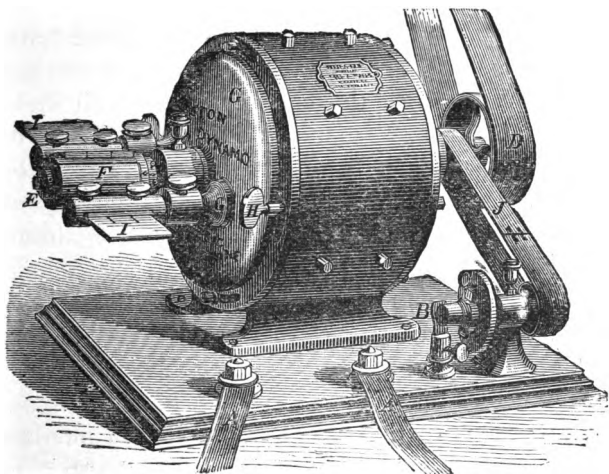

FIG. 16. THE WESTON PLATING DYNAMO.

with regard to one another, that the teeth of the one ring fit into the gaps of the other, without however touching at any part. This arrangement rectifies the alternating currents produced by the sections of the armature passing alternatively before poles of opposite names, and sends them all in the same direction. The Weston machine, owing to the fact that the armature is not so

massive as in the Siemens, is not quite so subject to heating as this latter. Since it is series wound, it would be just as liable to reversal of current, were it not for the adaptation of a very ingenious device, which, by automatically breaking connection between the dynamo and the plating vat, when the armature speed of the dynamo falls below a certain point, prevents the back current of the vat from entering the magnetizing coils of the dynamo, and thus obviates any risk of reversal from this cause. This device (B, Fig. 16) consists in a small metallic cylinder supported on trunnions, and actuated by a band (J) running off the spindle of the dynamo. This cylinder is made so as to expand by centrifugal tendency when driven at a certain speed, and thus to press against and make electrical contact with a small spring connected with one of the terminals of the dynamo.

Though this device is effectual against reversal dependent on the slowing down of the engine, yet it by no means remedies that due to the E. M. F. of the dynamo being overcome by that of the vats when a number of these latter are run in series. The heating also is very annoying. Still, the Weston has done good work, and many are to be found in workshops to the present day.

§ 39. **The Kapp, or "overtyping" Dynamo.** The next improvement consists in the use of laminæ of soft charcoal iron instead of the solid armature of the old Siemens form. These dynamos, especially if shunt wound, give perfect satisfaction as regards absolute impossibility of reversal and absence of all injurious heating. This is due to the fact that the lamination of the armature effectually

precludes the development of Foucault currents, while the air spaces existing between the lateral extensions of the laminations serve to carry off in a very effectual manner any heat set up by the passage of the current in the armature coils.

Armatures of the shuttle type, as employed in the Siemens dynamo, described in § 37, may now be built with a number of T-shaped laminations strung together on a steel spindle. This type is only used by amateurs making their own small machines. It is easy to wind, but not an effective type. Ring type armatures, with or without cogged projections, are also built with a number of *ring*-shaped laminations bolted together and secured to gun metal spiders. These cylinders of laminated rings, may be wound with several coils of wire passed over and through the rings—"ring winding;" or with coils of wire passing wholly over the rings on the outside only, named "drum winding." The latter method is the more effective, since it admits a minimum of dead wire in its coils. When an armature is run in a field over the field-magnet coils, as shown in Figs. 17, 18, and 19, the machine is said to be a Kapp or overttype dynamo. Drum armatures, run in fields of this type, are the leading features in all first-class plating dynamos. Some of these are described and illustrated in the following sections.

§ 40. **Hartley's Plating Dynamo.** Fig. 17 illustrates a machine of this type, made and sold by Messrs. J. E. Hartley and Son, Birmingham. This dynamo is simple in design, and solidly built. All the working parts can or

may be easily seen, cleaned, or removed for repair by any ordinary mechanic. Spare armatures and commutators are kept in stock by the makers, and therefore these parts can be readily renewed at any time. The machines are made in four sizes, ranging from No. 1, giving a current of 40 ampères at a pressure of  $4\frac{1}{2}$  volts, when driven at a speed of 1,700 revolutions per minute, and

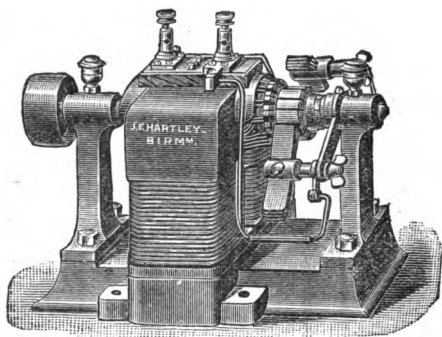

FIG. 17. HARTLEY'S NO. 4 PLATING DYNAMO.

taking  $\frac{1}{2}$  H.P. to drive it; up to No. 4, giving a current of 400 ampères at a pressure of from 6 to 8 volts when driven at speeds of 800 and 900 revolutions per minute, and taking  $3\frac{1}{4}$  H.P. on a full load. The first machine will deposit 4 oz., and the latter, 40 oz. of silver per hour.

§ 41. **Bottone's Plating Dynamo.** This machine, shown in Fig. 18, is also of the vertical Kapp overtypé, with a long laminated drum armature; but it differs from some other machines of this type, in having its field magnets and pole pieces in one casting with the bed of the

machine. In a dynamo thus constructed, there cannot be any loss due to faulty joints between the pole-pieces, field magnets, yokes, and bed of the machine, since all these form together one continuous horse-shoe magnet. Consequently less current will be required to maintain

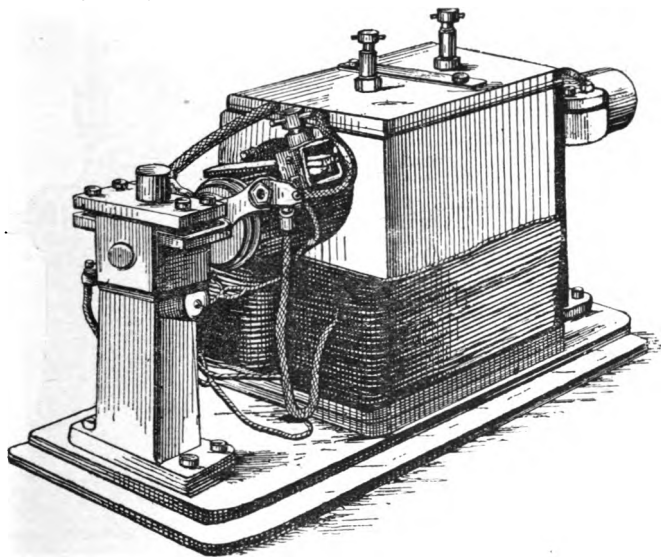

FIG. 18. BOTTON'S PLATING DYNAMO.

the strength of the magnetic field, than in machines where the magnet is composed of several parts separated from each other by films of air, or of oil, or possibly dirt. Another good point in the design of this machine, is the length of the field magnets, which not only allows a long drum armature to be used, with a consequently small



proportion of dead wire in its coils; but also insures the centre of gravity being kept low, so that even in the largest machine the spindle is only  $9\frac{1}{2}$  inches off the ground level. The drum is laminated, and the laminations are insulated from each other and from the spindle.

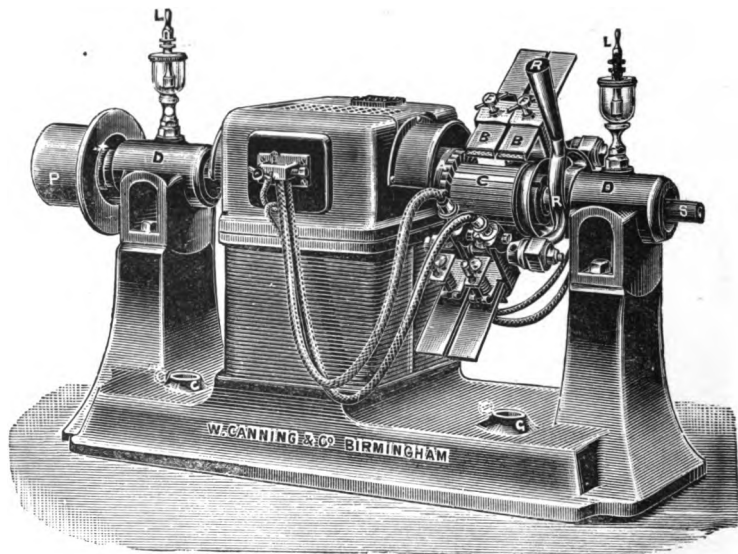

FIG. 19. CANNING'S PLATING DYNAMO.

This device, together with suitable wire in the coils, prevents loss from heating the coils and iron of the armature. The fields are connected in shunt with the armature, and may be furnished with a regulator, by which the E.M.F. of the current may be controlled, and the machine be thus adapted to all kinds of electrolytic

work. The machines are wound to give from 100 to 400 ampères of current, at a pressure of 6 volts; depositing from 1 to 4 lb. of silver per hour, and taking from  $\frac{1}{2}$  to 2 H.P. respectively to drive them.

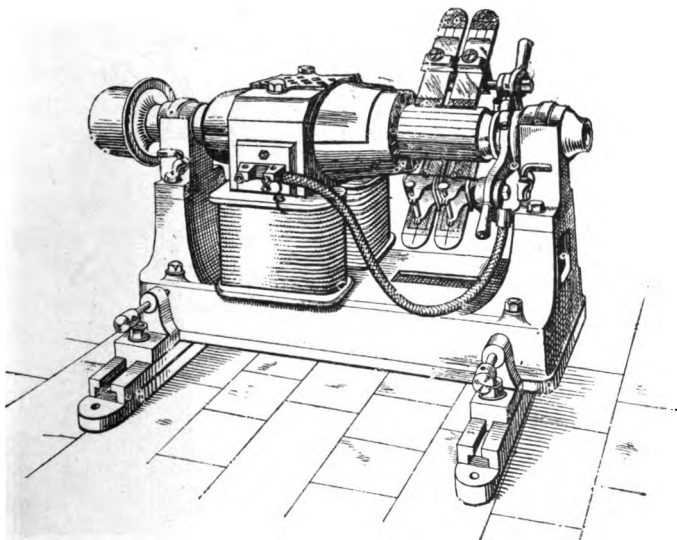

FIG. 20. THE LISTER PLATING DYNAMO.

§ 42. **Canning's Plating Dynamo.** This machine, made and sold by Messrs. Canning and Co., Birmingham, is also of the Kapp upright overtype, solidly and firmly built, with wrought-iron field magnets and pole-pieces, and laminated drum armatures. The commutator bars are made of hard gun-metal, insulated with mica, and the machine is furnished with sight-feed lubricators. All

parts are made in duplicate, and can be renewed at any time from stock. These machines are made in 5 sizes of 50, 100, 400, 1,000, and 3,000 Watts capacity respect-

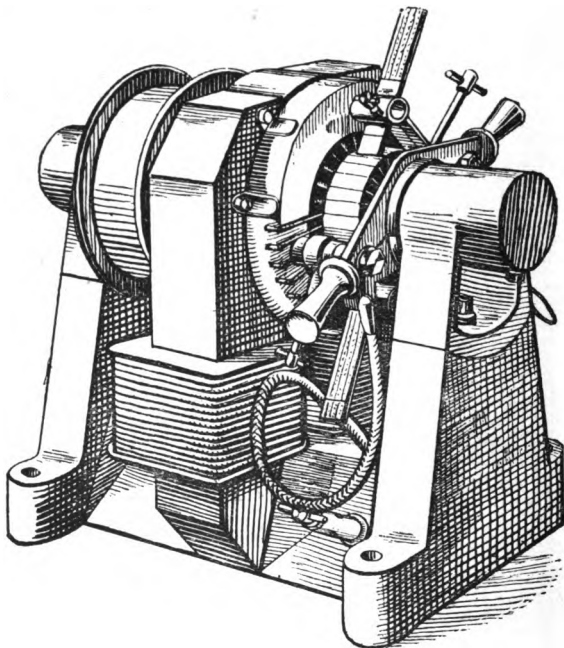

FIG. 21. THE AUSTIN "INFANT" PLATING DYNAMO.

ively, wound to give any voltage required, and run at speeds ranging from 600 to 2,800 revolutions per minute. The smallest, or "Midget" type, takes  $\frac{1}{10}$  H.P., and the largest E machine takes 5 H.P. to drive it.

Dynamos manufactured by the Lister Co. (for the

Birmingham plating trade) have a similar design and method of construction, differing only in armature guards, commutators, brush holders, and connections, all of which appear to be designed and finished in a superior manner, as seen by reference to Fig. 20.

§ 43. **The Austin "Infant" Plating Dynamo.** Makers of dynamos not only construct their machines in various designs, but also adopt variety in the materials employed. One chooses malleable cast iron as the material for carcase, field magnets, yokes, and pole-pieces; another announces soft grey cast iron as the chosen material; another uses wrought iron field magnets and pole-pieces; whilst the makers of the Austin dynamo pin their choice to "special dynamo steel." They also adopt a novel method of construction in the armature, which is built up of charcoal iron wire wound on a brass drum spider. The illustration, Fig. 21, shows us a compact, well-made machine of the Kapp oertype, which may be made to give outputs of 200, 300, 400, 600, 800, 1,200, 1,600, 2,400, and 3,200 Watts, at speeds varying from 2,300 to 1,500 revolutions per minute, and power needed, from  $\frac{1}{2}$  to 4 H.P.

§ 44. **Canning's Four-Pole Plating Dynamo.** In the earlier editions of this handbook, we noticed such multi-polar machines as the Carlyle and Elmore dynamos. These have now become obsolete, having been replaced by more efficient machines of the bi-polar type. Messrs. Canning of Birmingham, have, however, revived the multi-polar type in a machine of novel construction (shown at Fig. 22), made to the order of the Birmingham

Small Arms Company, Ltd. This machine has four wrought iron field magnets bolted to a cast iron yoke frame, each wound with a coil of wire having a low resistance, and the four coils are connected in parallel. The armature is of the Gramme ring type, wound with

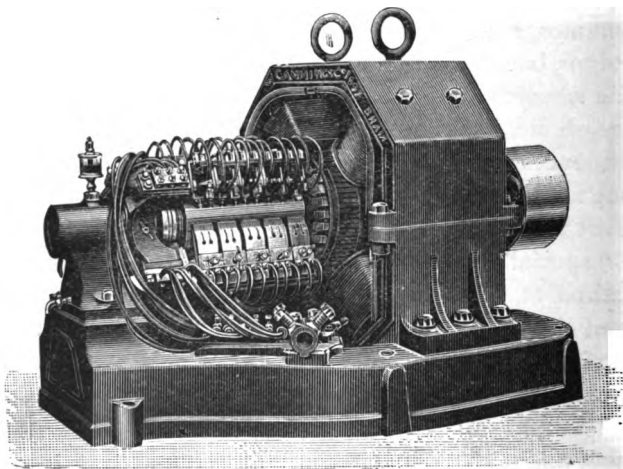

FIG. 22. CANNING'S FOUR-POLE PLATING DYNAMO.

stranded cable of several turns connected in parallel. The commutator has twenty-eight sections, and there are four sets of brushes. The machine is designed to give an output of 1,500 ampères, at a pressure of 7 volts, when run at a speed of 890 revolutions per minute, and has given great satisfaction to the users.

§ 45. **Avery's Lahmeyer Plating Dynamo.** Attempts have been made at various times to construct a dynamo

with an apparently closed magnetic field. The Siemens Hefner-Alteneck, the Gramme, and the Manchester dynamos may be taken as examples. It has occurred to Mr. Avery, that there is much magnetic leakage in

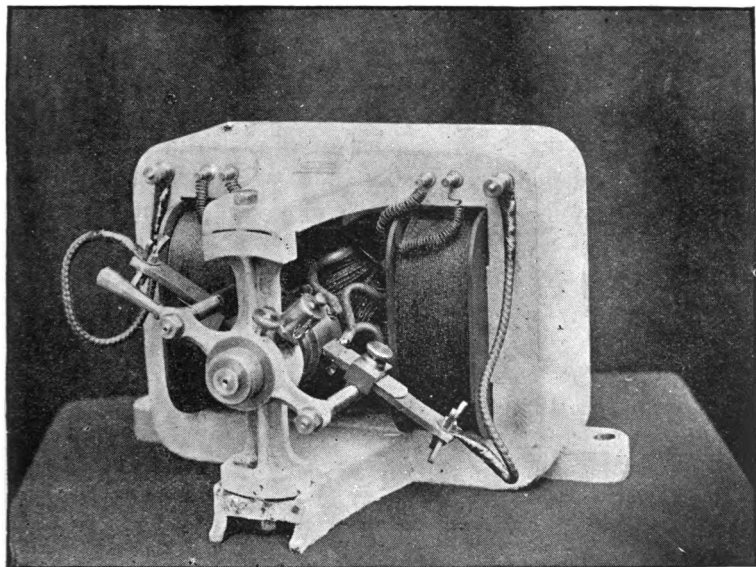

FIG. 23. AVERY'S LAHMEYER PLATING DYNAMO.

dynamos of this type, which might be prevented by constructing a machine embodying the iron-clad principles found so useful in transformers. He has therefore designed the dynamo shown in Fig. 23, and has named it the "Lahmeyer" Plating Dynamo. By referring to the

annexed figure, it will be seen that field magnets, yokes, and pole-pieces are cast in one mass with the bed of the machine, in such a manner as to surround the magnetic field with iron and thus prevent magnetic leakage. By constructing machines thus designed, he claims a high efficiency with less wire on the fields, and a less expenditure of current to maintain the strength of the magnetic field than in machines otherwise designed.

The carcasses of these machines are made of the best soft grey iron ; the armatures are of the drum type, and constructed of fine Swedish charcoal iron laminations. They are made in six sizes, giving outputs of 30, 60, 120, 240, 480, and 960 Watts respectively, at the usual voltages employed in electrolytic work, and are run at speeds ranging from 1,500 to 2,500 revolutions per minute.

§ 46. **The Gramme Dynamo.** Other types of plating dynamos have been made and used. Some have been superseded by machines of more modern design, whilst other old types are still in use, and will be used until quite worn out. Among those old types still in use may be mentioned the Manchester and the Gramme machines. In the Gramme machine (Fig. 24) we have a ring, either forged, made out of punchings, or out of soft iron wire, which is wound in sections around the external and internal periphery of the ring with insulated copper wire. The beginning and ending wire of each section (of which there may be any number up to forty) are left long, and when the ring is wound, the end of one section is twisted up with, and soldered

to, the beginning of the next, and so on, all round the ring. Then each twisted end is soldered to a separate bar of the commutator, of which there must be as many

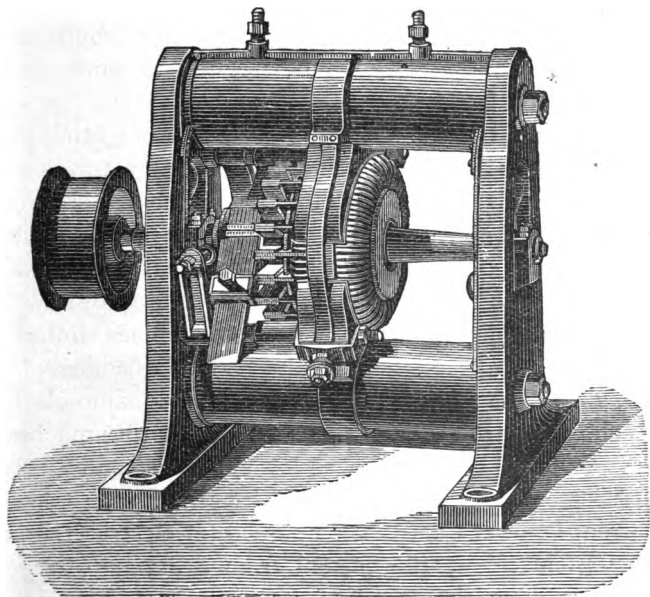

FIG. 24. GRAMME ELECTRO-PLATING DYNAMO.

as there are sections in the coil. In the original form of the Gramme machine, the armature was surrounded above and below by semilunar projections from the field magnets, or pole pieces, embracing altogether about two-thirds of its circumference. On either side of these

F



pole pieces were the two F. M. cores, a pair above and a pair below, so wound with wire as to produce consecutive poles in the middle (*i.e.*, where the pole pieces were). (See Fig. 24.) Wound with several strands of heavy wire, coupled up in parallel, on the armature, and a proper proportion of wire on the fields, shunt connected, this form of dynamo is found to work satisfactorily and well.

§ 47. **Transformers.** Electric current for lighting purposes is now brought to our doors in large towns and cities. If this current is continuous in character, it can easily be transformed down to the required voltage and adapted for plating work by competent electricians. Even a current of an alternating character can now be utilized for the purpose by means of machines similar in construction to the dynamos already described.

§ 48. **Speed of Dynamo Machines.** All dynamo-electric machines are run at lively speeds ; but plating machines are generally built to run at lower speeds than electric lighting machines, because the E. M. F. of a plating current is lower than that employed for electric lighting. The E. M. F. of the current from a dynamo, largely depends upon the speed of its armature. Bearing in mind the rule that each yard of active wire on an armature coil is capable of developing one volt when driven at an angular velocity of 1,250 feet per minute, we can easily calculate the voltage of the current from a machine if we know the length of active wire on one of its armature coils, and the speed at which the armature is driven.

The angular velocity of the armature may be ascertained by first measuring exactly its diameter, multiplying this by 3.14 to find the circumference, and then multiply this by the speed of the armature. To increase the voltage of the current from a machine, we must increase its speed, and to lower the voltage we must decrease the speed. By such means as these we can adapt a machine to the work of brassing, which requires an E. M. F. of

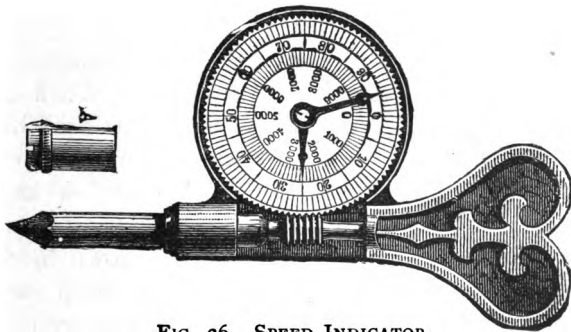

FIG. 26. SPEED INDICATOR.

*A*, Attachment for pointed Spindles.

from 8 to 10 volts, or lower its voltage to suit silver-plating work by lowering its speed. Plating machines are usually driven at speeds varying from 700 to 1,500 revolutions per minute. The speed can be ascertained by counting the revolutions of the driving-wheel and calculating the speed of the pulley driven by it, or the speed of the armature spindle may be taken direct by means of a speed indicator. At Fig. 26 is shown a very simple form of speed indicator, sold by J. E. Hartley

and Son, Birmingham, at the low price of 12s. 6d. The counter will indicate up to 10,000 revolutions. At Fig. 27 is shown Harding's Patent Direct Reading Speed Indicator in a morocco case. This instrument enables the speed of a machine to be read at a glance. It

is sold in various sizes, at prices varying from £2 up to £10 10s., by vendors of dynamo electric machines.



FIG 27.

HARDING'S PATENT SPEEDOMETER.

§ 49. **Management of Dynamos.** When a dynamo-electric machine is running in good order, evidence of a current passing around the F. M. coils is shown by a few faint greenish sparks playing between the brushes and their points of contact with the commutator bars. If these sparks are long, or have

a yellow or red tint, they are rapidly burning the brushes and commutator bars. This will sometimes happen when there is a very high resistance in the circuit, or when the machine is running idle, for then a large portion of the current is traversing the coils and increasing the magnetic intensity of the fields. Excessive sparking may be prevented by readjustment

of the brushes, and placing more work in the circuit. The commutator bars must be often cleaned with emery cloth, care being taken to keep the insulating spaces free from copper dust worn off from the brushes, as this will short circuit the armature coils. The pads of the brushes must also be examined occasionally, and readjusted, to prevent undue wear on one part, and consequent grooving of the commutator bars. If these become badly grooved, they should be trued up by taking a very light cut on them with a turning tool. Always keep the bearings cool and well lubricated. Avoid short circuiting a series or a compound machine by placing thick wires across the terminals, as this may overheat the wires of the coils and spoil the insulation by charring the covering. The direction of the current may be ascertained at any time by simply trying it on a small portion of a coppering or plating solution held in a basin. The copper wire receiving the deposit will be seen to come from the negative pole of the machine, and this must be connected to the cathode system of the plating vat, whilst the opposite or positive pole must be connected to the anode system of the vat. Should the polarity of the F. M.s be reversed by accident, its original condition may be restored by sending a powerful current from a battery through the F. M. coils, in the direction shown at Figs. 12-14 and 15, § 32.

If the bars are only slightly grooved, and their edges burnt a little, forming "flats," run the machine slowly, and hold a fine cut file on the bars, or use a pad of emery cloth (wound around a lath) for the same purpose, resting one end on a block of wood placed close to the commutator.

## CHAPTER IV.

### ELECTRO-PLATERS' MATERIALS.

§ 50. **Workshop Appliances.** In a well-found plater's workshop there are many other appliances (beside batteries and dynamo machines) for carrying out the work. Some of these may be called necessities, without which not even the most simple job can be done, whilst others may be termed conveniences for facilitating larger operations or works of a more intricate nature. Every plater, working in the smallest way with a battery as a generator of electricity, must have suitable vessels for holding the plating solutions and the various pickles used by him in preparing the work. He must also have slinging wires for holding the articles in the solutions, and suitable brushes for cleaning the goods before being plated, and finishing their surface afterwards. Among conveniences may be mentioned a selection of revolving scratch brushes, and a lathe for revolving them; a similar selection of small polishing wheels, made of different materials, and denominated dollies, mops, bobs, etc., together with a suitable machine for working them; a set of hand brushes for cleaning and polishing, and a set of burnishers if he intends

burnishing the work himself. He should also have a galvanometer furnished with two coils, one fine and the other coarse, or, better still, two measuring instruments, named respectively a voltmeter and an ammeter, the first for measuring the tension of the current, and the other for giving him a correct idea of its volume. Having thus given a general idea of the appliances required, I will now detail them, and describe their uses.

§ 51. **Vats.** These are the vessels to hold the plating solutions. They must be selected with a view to the magnitude of the operations to be performed in them. If the amateur wishes to electro-gild a few rings, scarf-pins, brooches, studs, sleeve-links, solitaires, and similar small articles, he will find a suitable vat in an enamelled iron saucepan holding from one to two pints of liquid, or in a stoneware salt-jar immersed in hot water in a saucepan; but if his ambition rises to watch-chains, watch-cases, and similar longer or more bulky goods, he must get a larger saucepan or vat. If operations are to be extended to a paying trade, a larger enamelled iron vat, capable of holding from five to ten gallons, will be required, and this must be heated over a suitable furnace, or over an atmospheric gas-burner, or by means of a steam-jacket. The two last means are preferable, as being more under control than the first. It must be understood at first, that the vat for gold-plating solutions must be impervious to the attacks of potassium cyanide when heated to a temperature of from 150° to 180° Fahrenheit. All metals except platinum are soluble in hot cyanide solutions, and nearly all other substances, except glass, vitri-



fied stoneware, and enamelled iron. Even the last is not always proof against the combined attacks of heat and cyanide, both of which, acting together, peel off the enamel in course of time, leaving the iron exposed. But, as an all-round useful vat, there is nothing equal to one of enamelled iron. This remark applies equally to vats for coppering with alkaline solutions, and for electro-brassing, when the solutions have to be heated. Silver-plating, nickel-plating, and coppering in a small way, is best done in accumulator cells made of glass or of stoneware. These can now be obtained at large potteries and glass works, and through dealers in electrical sundries, in sizes ranging from 8" x 8" x 10" holding 2 gallons, to 19" x 19" x 10" holding 12 gallons, and at prices varying from seven shillings to twenty-two shillings each. For large operations requiring vats holding from 5 to 75 gallons of solution, vessels made of cast iron, enamelled on the inside, will be found most suitable and economical, since they do not absorb the silver salts, and can always be kept clean. Vats for this purpose are made in Birmingham, and sold at the following prices:—

No.	Inside measure.	Price.
1.	13 in. x 12 in. 8 in. deep.	9 shillings.
2.	18 " x 14 " 8 "	16 "
3.	24 " x 15 " 10½ "	25 "
4.	27 " x 17 " 12 "	34 "
5.	36 " x 24 " 13 "	60 "
6.	48 " x 21 " 21 "	90 "

From 75 gallons upward, the vats for silver, nickel, and copper, are made of wood lined with lead, and then

match-lined. Although the outer containing box is made of strong wood with well-fitting joints, this material alone is not suitable for plating solutions, since the wood absorbs a large quantity of the solution, and the salts creep over the sides. The frame must therefore be lined with a material impervious to speedy action of cyanide, and that generally chosen (more because of its general adaptability to the work than for its special quality of resistance to cyanide) is sheet lead; this will resist the action of cyanide for many years, but all joints must be made by burning instead of soldering, as solder will form with lead a galvanic pair, and galvanic action will soon corrode the joints. The lead-lined tank must next be lined with match-board, to prevent accidental contact of the goods with the lead lining, and the upper rim of the vat should then be framed with strips of wood boiled in paraffin wax, to prevent internal absorption and creeping of the salts. It is not usual to thus protect the frame, but I recommend it on the score of economy and cleanliness.

The following are some measurements for plating vats:—

No.	Inside measure.	Capacity.
1.	2 ft. × 1 ft. × 18 in.	12 gallons.
2.	3 " × 18 in. × 18 "	30 "
3.	4 " × 2 ft. × 21 "	50 "
4.	5 " × 2 " × 24 " -	100 "
5.	7 " × 2 " × 36 "	200 "
6.	7 " × 3 " × 36 "	300 "
7.	10 " × 3 " × 30 "	500 "



Each vat should be furnished with long metal rods connected with the generator of electricity, on which to hang the anodes and the goods to be plated. The size of these rods may vary from  $\frac{1}{2}$  inch up to 1 inch in diameter, according to the length of the vat. They should be made of solid copper, but may be of brass, brass tube, or brassed iron, the latter, however, being a very inferior conductor. One each of these rods run along the sides of the vat, and are connected by a stout copper cable at one end. The rods are connected by means of stout brass clamps to the copper cable from the positive pole of the machine or the carbon element of the battery, and to these rods the anodes are suspended all along the sides of the vat by means of stout metal hooks. This leaves a free space all along the centre of the vat for the goods to hang in whilst being plated. The goods are suspended from another metal rod connected to the opposite pole of the generator by similar stout clamps and cables. It is most important that these rods, cables, and connections, be of large size, and all contact faces of the connections be kept clean, to keep down resistance in this part of the circuit.

§ 52. **Dipping Vessels.** As various solutions of acids and alkalies are employed in cleaning the goods whilst preparing them to be plated, we must have a separate vessel for each solution, the size of the vessel depending upon the size and number of the articles to be dipped in them. All vessels to hold acid solutions must be made of a material impervious to acids, such material being vitrified stoneware or glass. Common earthenware is useless, even

when thickly glazed. Large potteries, such as those of Messrs. Doulton, and Messrs. Stiff, supply acid-proof stoneware vessels specially made for this purpose. (See § 76.) Alkaline solutions are best contained in wrought-iron tanks, with provision made for heating them when required. Bowls of perforated stoneware (see Figs. 45 and 46, § 76) are also used when a large number of small articles have to be dipped at the same time. Stoneware dipping pans cost from 4*d.* to 4*s.* each, according to size.

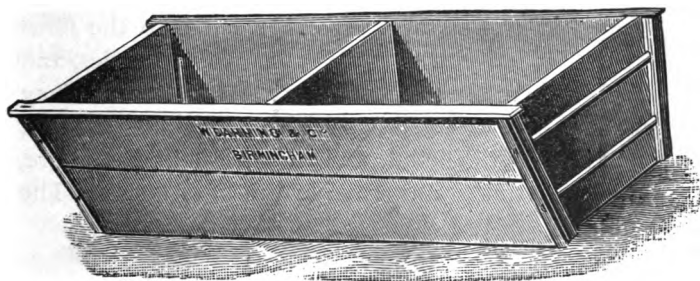

FIG. 28. SWILLING AND SCOURING TROUGH.

Large pans with stoneware taps cost about 1*s.* per gallon up to twelve gallons. Stoneware dipping baskets cost from 8*d.* to 1*s.* 3*d.* each, for those having from one to three pints capacity, and 2*s.* each for those holding four quarts.

§ 53. **Scouring, Swilling, and Rinsing Troughs.** These are made of wood, closely jointed, bolted together at both ends, lined with lead, and divided in the middle as shown at Fig. 28. They are fixed on trestles of a height convenient to the workman, who stands at the sloping side, and holds the article to be cleaned in the scouring

trough with one hand, whilst he scours off the dirt with a brush held in the other hand. One division is used for scouring the work in, whilst the other holds clean water for rinsing the work when clean. The various brushes and scouring materials for this purpose are mentioned in another section (§ 54).



FIG. 29. SCOURING BRUSH.

§ 54. **Scouring Brushes.** These are made to the form shown at Fig. 29, with solid wood backs and handles, and bunches of bristle or of hard fibre set in rows. They are made in several widths, such as 1-2, 3-4, 5 and 6 rows, to suit the work in hand, and in two qualities of fibre, "soft" and "stiff." The usual length is 11 inches. The



FIG. 30. POTASH BRUSH OF COTTON FIBRE.

prices vary from 2s. 3d. to 8s. per dozen, according to size and quality. When the work is being cleaned in strong alkaline solutions to remove grease, animal fibre cannot be employed, as it would soon get soft, dissolve, and wear away. A class of brushes known as "potash brushes," shown at Fig. 30, is then used. They are made of hard wood backs, fitted with tufts of cotton and similar vegetable fibre.

§ 55. **Polishing Tools.** The tools used for polishing the

articles, may be divided into two classes. Those for preparing the surfaces for plating may be placed first, and comprise sets of wheels and discs mounted on the spindle of a specially designed lathe driven at a high rate of speed. These discs are made of various materials, and are charged with a variety of abrading substances, each chosen to suit the work in hand. Bobs are discs of hard, tough wood, about 1 inch in thickness, and 4 inches in diameter, turned true and furnished with a rim or ring of bull-neck hide, walrus hide, or of buff leather. This is shown at Fig. 31. Mops are circular pieces of calico, felt, swansdown, basil-leather, etc., stitched or riveted together, to form solid discs from  $\frac{3}{4}$  to 1 inch in thickness, and from 4 to 6 inches, or even 12 inches, in diameter. Two perforated discs of thick leather riveted together enclose the softer material, and form a hub for the wheel. The bobs, charged with sharp-cutting or coarse abrading substances, such as silver sand, trent sand, emery, etc., are used for cutting away the rough surface left on castings and metal deeply corroded with rust. The mops in various degrees of softness are then used with Sheffield lime, rouge compo., crocus compo., tripoli compo., etc., to render the previously "bobbed" surfaces smooth. This is absolutely necessary before nickel-plating the article. Scratch brushes are also used for preparing surfaces to be plated, but these will be noticed in another section.

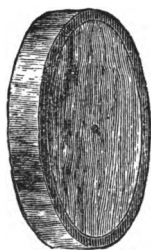

FIG. 31.  
POLISHING BOB.

§ 56. **Scratch Brushes.** These are brushes made of fine brass wire, specially selected and drawn for the purpose, to make it hard and pliable. The bunches of wire may be fixed in hard wood backs like other brushes, but are generally made up into circular brushes, such as that shown at Fig. 32. Such brushes are furnished with box-wood hubs, pierced with a hole in the centre to fit the spindle of the scratch-brush lathe. The circular

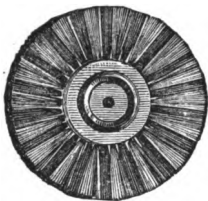

FIG. 32. CIRCULAR SCRATCH BRUSH.  
MADE OF WIRE OR OF  
BRISTLES.



FIG. 33. CUP BRUSH.

brush shown at Fig. 32 is intended for the general work of brushing broad surfaces, and may be had in various sizes and various degrees of softness, according to the fineness of the brass wire. These brushes are also made with steel wire and German silver wire when required to cut into hard metals, or with bristles and other fibre when softer brushes are needed. When the insides of cups and similar hollow surfaces have to be polished, the form known as the cup brush (Fig. 33) is employed. Smaller hollows, such as the insides of thimbles, are reached with a smaller brush of similar form, named a

"thimble brush." The insides of metal tubes are polished with a specially designed brush named a "box inside brush." The frosted appearance on silver-plated and electro-brassed goods, is got by cutting up the surface with a swing brush, which is made up of knots of brass, German silver, or steel wire hung to a hub of box-wood. It does not pay the plater to make up his own brushes, since they are made by experienced persons who do this only, and consequently turn them out at a cheap rate, in a condition of finish unattainable by the amateur.



FIG. 34.  
SCRATCH-BRUSH KNOT.



FIG. 35. SCRATCH-KNOT LATHE.

The smaller circular wire brushes,  $\frac{1}{4}$  of an inch in diameter, cost from 10s. to 14s. per dozen. The prices vary according to diameter of brush, number of rows, fineness or finish of the brass wire, and metal employed, until we reach brushes made of heavy brass wire with 6 rows of bunches, 4 inches in diameter, costing 72s. per dozen.

The wire for making these brushes is sold in knots, and these may be improvised into brushes by twining copper wire around them, as shown at Fig. 34. A number of these may be mounted on a wood or brass chuck, and used on a lathe as shown at Fig. 35. It will be readily understood that this is a wasteful use of wire, since, although the burred ends can be cut off with a

chisel, and the binding wire unwound as the ends wear, there must be a stout bunch of wire left at the last, for which there can be no use. But these improvised scratch brushes are often used by amateurs, and are not unknown in professional workshops.

§ 57. **Scratch-Brush Lathes.** The use of circular scratch brushes necessitates the employment of some machine



FIG. 36. FOOT-POWER SCRATCH-BRUSH LATHE.

to revolve the brushes. This is met in the scratch-brush lathe shown at Fig. 36. The revolving spindle is fixed under a tap connected to a pipe leading to a cistern charged with stale beer or some other lubricating liquid. This liquid falls on the revolving brush, to keep it cool and prevent its worn particles from cutting into the metal being polished. A hood is erected over the brush, to protect the workman and surrounding objects from

the spray of dirty liquor thrown up by the revolving brush. The lathe may be driven by foot-power, or by the machinery which drives the dynamo and polishing lathes. It is generally driven at a high rate of speed, because this is found most effectual. A scratch-brush lathe costs from £3 to £4

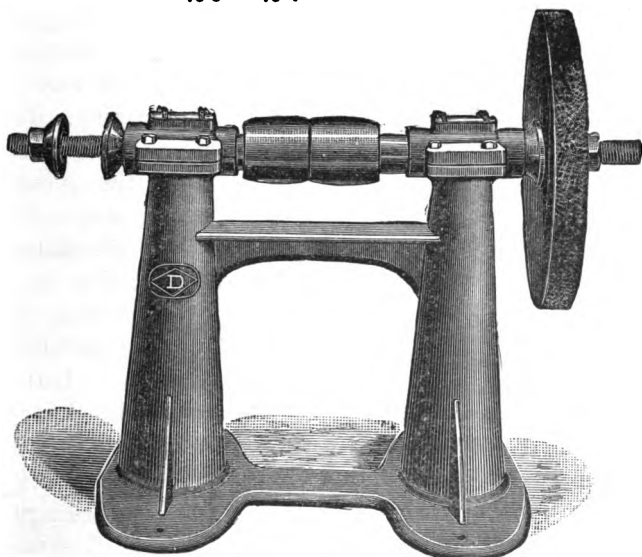

FIG. 37. HEAVY GRINDING AND POLISHING LATHE.

§ 58. **Polishing Lathes.** The difference between these and scratch-brush lathes will be seen by comparing the illustrations, Figs. 37, 38, with that of Fig. 36. Polishing lathes are made of strong materials, cast-iron pedestal, long hard-metal bearings, and steel spindles, to stand heavy work at quick speeds. The spindles finish off at

G



the ends with screwed threads and collars, to clamp closely the mops and buffs fixed upon them. The pedestal should be firmly bolted down to a stout bench, and the speed taken from a counter-shaft furnished with fast and loose pulleys. The pulleys on the spindle are

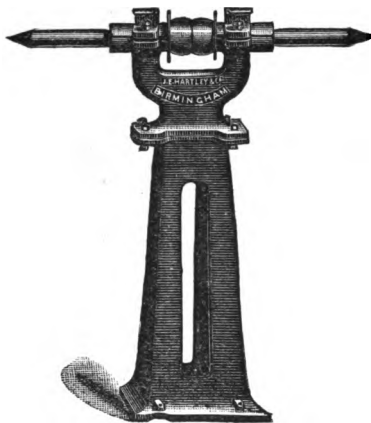

FIG. 38. POLISHING LATHE.

made wide to insure a good grip of the strap, and this should also be made wide to avoid loss of power by slipping. The work of polishing is best done when the spindle is driven at a speed of over 3,000 revolutions per minute, for, as a rule, "the greater the speed of the polishing spindle, the better, quicker, and cheaper finish is imparted to the surface of the work."

Polishing lathes cost from 25s. to 90s. each, according to size and fittings.

§ 59. **Polishing Materials.** The materials in use for polishing metals to prepare them for plating, are: finely prepared and sifted Trent sand, Sheffield lime, rotten stone, pumice stone, water of Ayr stone, and various compositions of emery, crocus, tripoli, and rouge for imparting a high state of finish to the articles. Sheffield lime is a lime specially selected for polishing purposes,

and packed to preserve it from air. It is used for preparing surfaces to be nickel-plated. Its use is being superseded by "Tripoli Composition," which is said to be healthier for the workpeople, and produces a polish at less cost for time, labour, and material. It is supplied in two grades, "rough cut" and "fine cut," by dealers in electro-platers' materials. Tripoli, crocus, and rouge, in various grades to suit the work in hand, are now made up with fat into cakes or bars. In this form it gives less trouble, and makes less waste than when used in the form of loose powder. The cake of composition is pressed against the selected mop whilst it revolves, which then becomes charged with the abrading material, and holds it whilst the work of polishing is being done. Tripoli is used in the rough on leather mops for preparing cabinet brass work, and such steel work as bits and spurs. The fine cut is used on calico mops for imparting a higher finish on brass, copper, steel, iron, etc., before it is plated, and in finishing nickel-plated work. Crocus is used for a similar purpose. Rouge compo. is employed for imparting a high state of finish to jewellery, spoons, forks, and electro-plated goods. Pumice stone in fine powder, and rotten stone, are used in scouring goods by hand with brushes in the scouring trough. Pumice stone in lumps, and water of Ayr stone, are both employed as abrading materials to rub down by hand, rough, pitted, and corroded surfaces in out-of-the-way places difficult to be got at with mops. Full instructions on the use of these materials are given in the sections of Chapter V.

§ 60. **Slinging Wires.** When the surfaces of the goods have been prepared to receive a deposit of metal, they are hung from the cathode rod of the vat in the plating solution by lengths of copper wire. These wires have received the name of "slinging wires." They are simply suitable lengths of copper wire of a gauge to suit the work in hand. Wire of No. 22 B.W.G. is generally employed for such light work as spoons, forks, and table utensils. Larger wires should be employed for large and heavy goods. As the immersed ends of these wires get coated with the metal being deposited, they should be carefully set aside each time after use, and when the deposit gets thick, it should be stripped off in a stripping acid, the wire afterwards annealed, and straightened for future use.

§ 61. **Leading Wires.** The wires leading from the dynamo or battery to the vat, must be of well-annealed copper, and have a sectional area capable of carrying the maximum quantity of current without offering appreciable resistance. I give here the safe carrying capacity of wires and cables made of copper wire. On comparing these with the ascertained quantity of current likely to be required, we may select the most suitable size of leading wires. Cables should be chosen instead of large wire where a large volume of current must be carried, as cables are more flexible than wire of a large size, and can be more easily laid.

TABLE OF SAFE CARRYING CAPACITY OF COPPER WIRE.

No. B.W.G.	Am- pères.	Cable. Wires. No.	Am- pères.	Cable. Wires. No.	Am- pères.
20 ... ..	1	7—16 ...	22'9	37—15 ...	154'1
18 ... ..	1'8	7—14 ...	35'6	37—14 ...	190'9
16 ... ..	3'2	19—16 ...	62'4	37—13 ...	251'6
14 ... ..	5	19—15 ...	78'9	37—12 ...	321'7
12 ... ..	8'5	19—14 ...	97'3	61—13 ...	416'2
10 ... ..	12'8	19—13 ...	128'2	62—12 ...	531'9
8 ... ..	20'1	19—12 ...	164'7		

This table shows the volume of current capable of being carried without injuriously heating the conductor. There need be no difficulty experienced in getting cables of the size mentioned here, as they are manufactured for electric light leads, and sold in any length, well insulated with rubber, tarred tape, and an outside preservative compound. If naked rods are used as leads, instead of insulated cables, they should be supported at intervals by hard-wood cleats previously soaked in hot paraffin wax.

§ 62. **Sawdust.** Electro-silvered and gilded goods are dried in sawdust after they have been rinsed to free them from traces of the plating solution. The sawdust used for this purpose, is that made by box-wood block-makers, as box-wood dust has been found least likely of all other to soil the delicate whiteness of newly deposited silver. The dust must be clean, free from grit and dirt, and sifted to free it from chips. As it is to be employed hot, and there is a danger of charring it when heating the sawdust pan by means of gas or over a furnace, I recommend that the pan be fitted up with a steam-

jacket, or hot-water jacket, as in the vats for electro-gilding.

§ 63. **Thermometers.** In electro-gilding operations a thermometer is needed to ascertain the right temperature of the gilding solution. This instrument must be wholly of glass, as any metal-work will dissolve in the hot gilding solution. The best for this purpose are

those with a white enamelled scale enclosed in a glass tube, and named "milk-scale" thermometers. The scale may be graded in degrees, Fahrenheit or Centigrade, as may be most convenient to the operator. Such a thermometer will cost from 3s. 6d. If the scale is graded in Centigrade degrees, and we wish to ascertain the value of a reading in degrees Fahrenheit, add 32 to the reading, multiply the product by 9, and divide it by 5. If the reading is in degrees Fahrenheit, multiply the reading by 5, subtract 32 from the product, and divide it by 9 to convert the reading

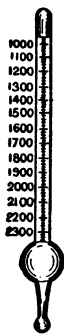

FIG. 39.  
SPECIFIC GRAVITY  
HYDROMETER.

into Centigrade degrees.

§ 64. **Hydrometers.** These are glass instruments resembling thermometers in outward appearance, but having a large glass bulb near the bottom, as shown in Fig. 39. They are used for testing the specific gravity of liquids, or, in other words, to test their density as compared with that of pure water. The liquid to be tested, may be placed in a narrow glass jar (see Fig. 40)

together with the hydrometer, or may be contained in any other vessel. The instrument floats in the liquid to be tested, with its bulb below the surface and its stem standing above the surface. This stem is graded in degrees similar to that of a thermometer, and shows the depth of the bulb beneath the surface. In pure water the bulb sinks down to the 0° mark, or to 1000 as marked on some scales, 1000 being taken to represent the density of water at a temperature of 60° Fah. As the density of the water increases by the addition of salts or of liquids having a greater density than water, the bulb is forced upwards, and the scale then registers so many degrees greater density than water.

Three differently graduated hydrometers are in use in this country. These are: hydrometers graded to read direct the specific gravity of liquids in comparison with that of water, taking this as represented by 1000; hydrometers graded by a scale adopted by a Mr. W. Twaddell, and known as Twaddell's hydrometers; and hydrometers graded by a scale adopted by M. Baumé, and named Baumé's hydrometers. The difference between the three gradings is shown in the following table. In some text-books and printed instructions on this art, reference is made to testing solutions by means of a hydrometer, and certain figures are given to denote the required

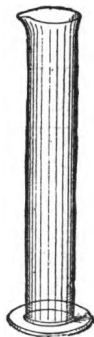

FIG. 40. TALL GLASS JAR FOR HYDROMETER.

density of the solution. These are fallacious unless direct reference is also given to the kind of hydrometer to be used. This will be seen on reference to the following table, wherein is shown at a glance the difference between the readings of Twaddell, Baumé, and the direct specific gravity hydrometers.

TABLE SHOWING READINGS OF DIFFERENT  
HYDROMETERS.

Specific Gravity.	Baumé.	Twaddell.	Specific Gravity.	Baumé.	Twaddell.
.817°	40°	—	1.250°	—	50°
.827°	38°	—	1.263°	30°	—
.837°	36°	—	1.300°	—	60°
.847°	34°	—	1.321°	35°	—
.856°	32°	—	1.350°	—	70°
.871°	30°	—	1.385°	40°	—
.880°	28°	—	1.400°	—	80°
.892°	26°	—	1.450°	—	90°
.903°	24°	—	1.454°	45°	—
.915°	22°	—	1.500°	—	100°
.928°	20°	—	1.532°	50°	—
.942°	18°	—	1.550°	—	110°
.955°	16°	—	1.600°	—	120°
.970°	14°	—	1.618°	55°	—
.985°	12°	—	1.650°	—	130°
1.000°	0° or 10°	0°	1.700°	—	140°
1.036°	5°	—	1.714°	60°	—
1.050°	—	10°	1.750°	—	150°
1.075°	10°	—	1.800°	—	160°
1.100°	—	20°	1.823°	65°	—
1.116°	15°	—	1.850°	—	170°
1.150°	—	30°	1.900°	—	180°
1.161°	20°	—	1.946°	70°	—
1.200°	—	40°	1.950°	—	190°
1.210°	25°	—			

It will be seen that every degree Twaddell represents  $\cdot 005^\circ$  in the specific gravity hydrometer, and every  $10^\circ$  represents  $\cdot 050^\circ$ . To convert degrees Baumé into readings showing direct specific gravity, subtract the readings on Baumé's rule from the number 144,

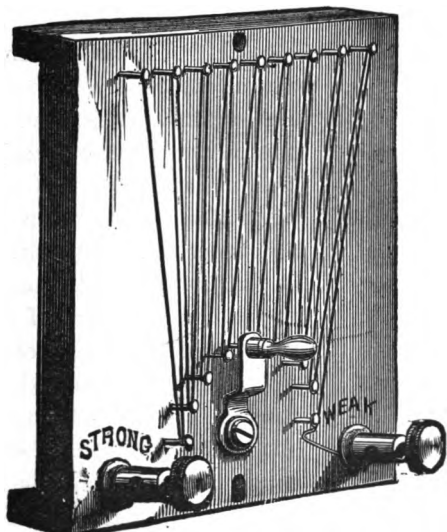

FIG. 41. RESISTANCE BOARD.

and divide this by the difference. For example,  $144 - 66 = \frac{144}{78} = 1.846^\circ$ , the specific gravity of a liquid registering  $66^\circ$  on a Baumé hydrometer. Baumé has one hydrometer for liquids lighter than water (the readings for which are given in the first 16 sets of



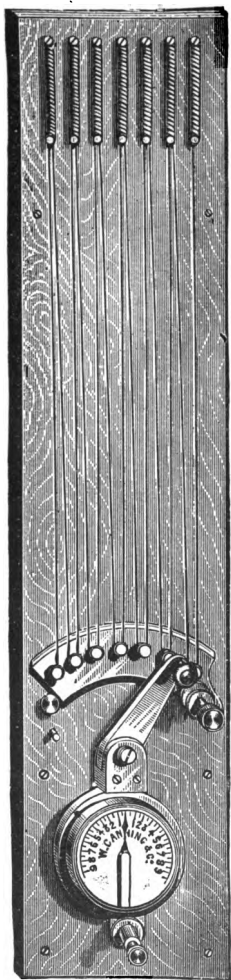

FIG. 42. COMBINED  
RESISTANCE BOARD  
AND AMMETER.

figures in the foregoing table), and one for liquids heavier than water.

§ 65. **Resistance Boards.** These are simply a slab of mahogany or other hard wood furnished with a switch and studs as shown at Fig. 41. A brass or German silver wire is attached to one terminal of the switch, and then wound on the board from stud to stud in a zigzag manner, each turn of wire being calculated to offer an additional resistance to the current. The lever of the switch is so constructed as to take one or more of these turns into circuit, or throw one or more out, as may be required, by moving it from stud to stud. By this action the plater is able to check back as much of the current as he pleases whilst putting the first few articles in the bath, and thus prevent the condition named "burning" the deposit, until enough articles have been placed in the vat to receive a fuller current, when the switch can be altered to suit the work. If an ammeter is fixed on the switch board, as shown at Fig. 42, the full

value of the current can be read off as the switch is moved. The resistance board and ammeter is to be placed in the circuit with the work. These boards cost from £1 to £2 each without an ammeter. With switch board and ammeter combined the price is £3.

## CHAPTER V.

### PREPARING THE WORK.

§ 66. **Cleanliness Essential.** Absolute cleanliness is essential to success in all electro-plating operations. The full meaning of this word, when applied to the surfaces of metals, is not clearly understood outside the plating shop, except by those who have had some training in chemical manipulations. The term—cleanliness, when applied to metal surfaces about to receive a coat of electro-deposited metal, means absolute freedom from the least trace of dust, grease, or other animal matter, rust, corrosion, or any other form of oxidized metal. As an example, a surface made clean by any mechanical means alone will not serve our purpose, because loose metal dust and minute particles of the polishing material may be left on the surface, or the cleaning material may be oily or greasy, and the particles of dirt thus left on would prevent perfect adhesion of the deposited metal. The perfect cleanliness required is shown by this example: If a perfectly cleaned surface be handled with the naked hand, the deposited coat will strip off the spots touched with the hand. The surfaces to be plated must therefore be made clean by mechanical means, and then

made chemically clean by suitable solutions of acids or of alkalies. As each metal requires a slightly different treatment to that of others, a section will be devoted to the cleaning of each metal.

§ 67. **Cleaning Cast Iron.** Iron castings may be coated with copper or with brass in an alkaline bath, or with nickel or zinc; but are rarely coated with silver or with gold. The method of cleaning is the same for each process. The casting must be first freed from the hard black crust of burnt sand on its surface, and particles of sand from its pores. To do this, immerse the casting in a pickle composed of six fluid ounces of sulphuric acid to each gallon of water, and let it soak therein for half-an-hour. If, at the end of this time, the black crust has become sufficiently loose to be rubbed off with the tip of a finger, the operation of pickling is complete. If there are obstinate scales, re-immerses it in the pickle for a short time, then try the hard spots again. If they are still obstinate, pour a little muriatic acid on them and put the casting again in the pickle. When the black scale is all loosened, well rinse the casting in water and take it to the scouring tray, where it must be well scoured with wet silver sand and a hard brush until a clean bright surface has been obtained. If there are any sand-holes, these must be cleaned out with a sharp steel point, and the clean bright casting well rinsed at once in clean water, then transferred without loss of time to a cold potash solution. In this it may remain for a short time whilst getting the bath ready, when it must be again rinsed in clean water, and transferred at once to the bath

of copper, nickel, brass, tin, or zinc. If the casting is large, a number of stout slinging wires must be employed, as cast iron itself is an inferior conductor of electricity. If the casting is greasy, or has been used where oil could get on it, the casting must be put in a hot potash dip (see § 76), scoured, and rinsed before placing in the acid pickle. If it is rusty, the rust spots should be smeared with muriatic acid before being placed in the pickle.

§ 68. **Cleaning Wrought Iron or Steel.** Wrought iron should be treated in a similar manner to cast iron, the pickle being the same for both, but it will not be necessary to leave the articles so long in the pickle before scouring them. As a high polish may be desired on wrought iron and steel articles, this is given to them on the polishing lathe by means of emery wheels, and bobs charged with sand, Sheffield lime, emery, rough cut tripoli, and other abrading substances, to first grind down all roughness, then finish with crocus compo. on a basil-leather mop, or with the same compo. on a circular bristle brush. After being thus brought to a high state of polish they should be passed through the potash dip (see § 76) to free them from the grease contracted in polishing, rinsed in water, and brushed with a soft brush free from grease, then transferred at once to the plating vat. Should there be any delay in finishing the polished steel, or should the article be large, its surface will be sure to contract a slight film of rust, and this must be removed by dipping each article for a few moments in a pickle composed of eight fluid ounces of muriatic acid in each gallon of water, then rinsing in water and transfer-

ring at once to the plating bath. Celerity in finishing wrought iron and steel is necessary, because of the tendency of these metals to rust when wet and exposed to the air. The slightest film of rust, not to be detected by the eye, will be sufficient to cause a loose deposit which will strip whilst being finished or burnished.

§ 69. **Cleaning Copper, Brass, and German Silver.** As brass and German silver are alloys of copper with zinc and nickel, they may be conveniently classed together for preparatory treatment, this being the same for all of them. There are also several other alloys of copper with zinc, nickel, tin, aluminium, and iron, named respectively pinchbeck, Dutch metal, dipping metal, bronze, nickel silver, nickeline, delta metal, ormuline, aluminium gold, aluminium bronze, Canadian gold, and other high-sounding names. But, to the plater, they are all brass, and are to be treated in a similar manner in preparing them for plating. It must be distinctly understood beforehand by the would-be plater, that defects in the surfaces of metals cannot be covered up by depositing upon them a coat of another metal. If the surface of the article is scored with scratches, or pitted with corrosion, the scratches and pits, however small, will appear on the plated surface, and cannot afterwards be effectually removed by subsequent polishing and burnishing. Even when the surface has been highly polished, if it should be accidentally marred by a stain, the dull irregular spot will appear on the plated surface and mar its appearance. This fact points to the necessity of care being taken in removing all scratches and other rough-

ness from the surface by a series of polishings, beginning with rough cutting materials on bobs and buffs made of bull-neck, walrus, and basil leather, walrine, felt, etc., and finishing off with the finer abrading materials on calico and swansdown mops. In large establishments this work is done in the polishing room by men who devote their whole time to this branch of the business, and the polished articles are handed into the plating room on shallow wooden trays. As they leave the hands of the polisher their surfaces have a bright lustrous appearance, and it would appear to the uninitiated that it would be only necessary to wire the goods, and hang them at once in the plating vat, so clean and bright do they appear. If the novice is tempted to do this he will probably rue his want of experience when he commences scratch-brushing the plated surface, or, if the coat fails to strip then, it will assuredly do so whilst being burnished. As a fact, the smooth bright surface left by the polisher is covered by a slight film of grease left from the polishing materials, and this must be removed by soaking the goods in the hot potash dip (see § 76). They must therefore be connected to lengths of wire, and suspended in the hot potash solution until wanted at the scouring-trough. After the film of grease has been moved in the potash dip, the articles are taken one at a time to the scouring trough, and laid on a transverse shelf of wood, whilst briskly brushed with hogs' bristle brushes dipped in finely-powdered pumice stone, or with a mixture of equal parts pumice and rotten stone. This is done to clear off the last remaining trace of animal matter, and

also to impart a slight uniform roughness to the surface, such being necessary to insure perfect adhesion of the deposited coat of metal. To insure this, it is not necessary to scour the surface hard, but to merely brush it briskly to and fro with a wet brush charged with the scouring powder, care being taken to keep the brush well charged with the powder. The brush to be used for this purpose must be free from grease, but should the presence of grease or oil be suspected, it will be well to take the precaution of dipping the hairs for an instant in the potash solution and rinsing the brush in water before using it. The scouring trough, described and illustrated in § 53, is divided into two equal parts, one division being used for scouring, and the other containing water for rinsing the scoured articles. The powdered pumice is held in a box fixed to the inside edge of the scouring division, furthest from the workman, who first dips his brush in the water and shakes out the surplus, then dips it in the box of powder, some of which adheres to the wet hair. This process is repeated as the powder wears off, and, when the article is properly scoured, it is rinsed in the water contained in the rinsing division, wired with the necessary slinging wires, dipped in the final dipping solution, again rinsed in clean water, and suspended at once in the plating solution.

Whilst German silver, brass, and some other alloys of copper are being scoured, they contract a slight film of oxide. If the cleaned articles are to be nickel-plated, this film is removed by dipping in a solution of cyanide of potassium in water, called a cyanide dip (see § 77),



and this is the final dip before placing the goods in the plating vat. If the goods are to be silver-plated, they receive a final dip in a dilute solution of nitrate of mercury, which coats the surface with a thin film of mercury. This process, named quicking, is adopted to remove the film of oxide already noticed, and to replace it with a film of clean metal to which the silver can closely adhere. It is sometimes used in preparing articles to be gilded, but quicking is not always necessary to perfect adherence of silver or of gold. If the gilding or plating solutions are properly prepared, and the scouring operations conducted with sufficient celerity and care, a perfect adherence of the gold or silver coat can be secured by swilling the article in a cyanide dip, as for nickel-plating, or by merely moving it to and fro in the plating bath for a few moments before connecting the slinging wires to the cathode rod.

§ 70. **Cleaning Old Articles.** Much of the plater's time in jobbing shops will be taken up in plating old articles, or in re-plating those that have formerly been coated with tin, zinc, nickel, silver, brass, or gold. The practice of the amateur plater will largely consist of these re-plating jobs. The first consideration should be paid to a correct detection of the nature of the old plated coat, with a view to adopting the proper means for its complete removal, since we cannot successfully re-plate an article coated with patches of metal, some of which may be loose. As old articles are generally more or less discoloured by tarnish and dirt, this coat must be first removed by boiling in potash solution, and brushing with the scratch brush.

The plated coat being now exposed, we can easily detect its character. Gold may be distinguished from brass by dropping on the coat from the tip of a glass rod a single drop of nitric acid. This acid will immediately dissolve the brass and cause a green spot, but on gold it will not have any effect. Silver may be distinguished from nickel or from German silver by dropping on the coat a mixture of 6 parts nitric acid and 1 part chromic acid, to which has been added 2 parts of water, or 2 parts strong bichromate of potash solution instead of chromic acid. If silver is present, it will be indicated by a blood-red spot where the mixture attacks the metal, whilst a greenish spot will reveal the presence of German silver or of nickel. Tin and zinc will freely dissolve in a mixture of muriatic acid and water, but this will have no effect on silver, and very little effect on nickel. Directions for stripping the deposited coats are given in another section (§ 71). When the outer coat of grease, dirt, or plated metal has been removed, the surface will be seen to be pitted, scratched, and otherwise worn. These marks must be removed on the polishing lathe, or by hand if we wish to give the re-plated article a finished appearance, unless in so doing the metal is worn too thin to be of any use. When the surface is thus polished, it must be further treated as new work to be plated. It sometimes happens that old goods are made up in pieces put together with soft solder. These soldered joints will clearly appear after the dirt and outer coats have been removed, and are likely to cause trouble if not discovered and properly treated before

placing the goods in the plating vat. Soldered joints must be coated with copper in the following manner after the article has been scoured. A small glue brush or paint brush must first have some fine iron wires twined among its hairs, which must then be dipped in a strong solution of sulphate of copper and drawn along the soldered seam. This will cause a thin film of copper to be deposited on the solder, and this film will readily take the mercury from the quicking solution. If there are large patches of solder, or lead mounts on the article, it will be best to coat the whole article with copper or with brass in an alkaline coppering or brassing solution before attempting to plate it with silver, gold, or nickel. If old cruet-stands are made up of two or more different kinds of metals or their alloys soldered together, these must be unsoldered and the different parts treated apart, or the whole must be coated with copper in an alkaline copper bath before we attempt a coat of silver. It sometimes happens that these cheap-jack articles are made up of tinned iron bottoms, cast pewter legs and sides soldered together, German silver or brass wires and steps, and pewter knob or loop at the top. These parts may be detected by scraping some obscure spot with an old knife or a file. As such dissimilar metals will not plate together in the bath at the same time, because they form galvanic pairs in the solution, we must either separate them by unsoldering, and plate them separately, soldering them together again afterwards, or give the whole a coat of copper under a vigorous current, then quick with mercury and re-plate without loss of time. Such jobs,

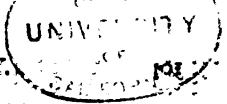

however, never repay the plater for his trouble. Old plated copper tea-pots, coffee-pots, and similar hollow ware, are frequently found lined with a film of tin. This must be removed by filling the vessel with boiling hot caustic potash or caustic soda solution, and allowing it to cool in the vessel. The alkaline solution must then be poured out, the inside rinsed with water and then filled with muriatic acid, which will dissolve off the remaining trace of tin and leave the copper bare. All hollow ware should have the insides thus attended to before attempting cleaning the outsides, and should be well scoured out with sand and water after being subjected to the caustic alkali and acid treatment. Gilt mugs, and similar articles with gilt insides, must have the gold stripped from them by the means recommended in § 71. Old candlesticks, and other articles of ornamental hollow ware, are sometimes met with, which require close examination before attempting to re-plate them. They are put together in pieces by solder, and filled with a mixture of resin and pitch to which some sand has been added. A piece of baize or cloth at the bottom hides the defect, or the bottom may be a piece of tin soldered on. This must be removed and the stuffing melted out in an old iron pot before we attempt cleaning the articles for plating. When finished, the composition may be restored and a new piece of baize put on the bottom.

§ 71. **Stripping.** This term is employed to denote accidental loosening of the deposited metal under the scratch brush or the burnisher, and also a purposed loosening of a deposit by means of acid solutions. Silver

is stripped from old plated work on copper and its alloys, before they can be re-plated, by immersing the plated article in hot and strong sulphuric acid, and adding from time to time a few crystals of saltpetre. The acid must be made hot; the articles to be stripped must be quite dry before immersing them in the acid, and must be moved about whilst adding the saltpetre. If this is done as directed, the whole coat of silver may be loosened without serious damage to the metal beneath. The same operation may be performed in a cold mixture, composed of one part strong nitric acid added to ten parts of sulphuric acid in a stoneware vessel. The goods to be stripped in these acids should be first attached to stout wires, as they must be frequently moved about in the solution, and taken out to be examined from time to time, to prevent overdoing the process and injuring the metal beneath the coat. When all the silver has been stripped off, the article must be at once rinsed in clean water to free it from acid; but should it be necessary to re-immerser the article, it must be first dried, since the presence of water in the acid will cause it to attack the metal beneath the coat of silver. When the plated article is made of iron, steel, zinc, pewter, lead, or Britannia metal, it must not be immersed in the stripping acid, but should be desilvered in a solution of cyanide of potassium by means of a current from a battery or a dynamo. An old disused plating solution will do very well for this purpose if it has plenty of free cyanide. Immerse the article to be stripped, and connect it as an anode to the positive pole of the battery or dynamo, and suspend a

plate of carbon or a strip of platinum foil in the solution as a cathode. Then pass a strong current until all the deposited coat of silver has been dissolved. Gold may be removed from gilded articles by a similar method in an old gilding solution. The gilt insides of cups and mugs can be removed by filling them with the cyanide solution, connecting them to the positive pole of the battery, and passing a strong current from them to platinum cathodes suspended in the solution without touching the sides of the vessels. Gold may also be stripped from base metals by immersing them in hot nitric acid, and adding some common salt as required. This operation is similar to the acid process for stripping silver, and needs equal care. Nickel is stripped from nickel-plated articles in a mixture composed of one pint of water, one pint of strong nitric acid, and four pints of strong sulphuric acid. The water must be first placed in a lead-lined vessel, or in one of enamelled iron, and the sulphuric acid added gradually and carefully, as the addition of this acid to water raises its temperature to a scalding point. This sudden generation of heat will burst ordinary vessels of stoneware or of glass. When the sulphuric acid has been mixed with the water, the mixture must be poured into a stoneware dipping pan and the nitric acid added. These precautions are necessary, because the mixture of the two acids and water will dissolve lead and enamel, but will not pierce acid-proof stoneware, whilst this in turn will not stand sudden expansion caused by the heat generated in mixing the sulphuric acid with water. Whenever this acid is to be

mixed with water, the acid must be poured slowly into the water, instead of mixing them by pouring water into acid. All operations in stripping by acids, must be performed in the open air, or under conditions similar to those laid down for dipping processes as explained in § 76. The process must be closely watched throughout, and the article removed from the stripping solution immediately its coat of metal has been stripped off. The time taken up in this operation may be only a few minutes if the coat is thin, or it may extend to half-an-hour, or even more when thick coats have to be stripped.

§ 72. **Cleaning Zinc.** Some highly artistic and ornamental articles in cast zinc, have the appearance of solid silver and solid gold imparted to them by electro-deposition. Zinc goods of all kinds should be first immersed for a few minutes in a hot potash solution to free the surface from any trace of grease, then well rinsed and immersed in a pickle composed of sixteen fluid ounces of sulphuric acid to each gallon of water, for a few minutes, then rinsed to free the surface from acid; and passed on to the scouring trough. Here they must be dealt with at once, and scoured with a stiff brush charged with wet silver sand until the surface has been made uniformly bright, then rinsed in water and transferred to a brassing or alkaline copper bath rich in metal. The current should be strong enough to coat the article with brass or with copper in a few seconds, to prevent the surface from being blackened by the solution. When a film of copper or of brass has gone all over the surface, the anode should be raised and deposition allowed to go on more

slowly. If the article has been made up in pieces put together with soft solder, or if the zinc casting has been doctored with solder, the soldered seams or patches may not at first receive a deposit of copper or of brass, but will appear black after the rest of the surface has been coated. In this case the article must be taken out, the black spots well scratch-brushed, rinsed with water, and placed again in the brassing or coppering bath with the defective spots close to the anode. By carefully moving the goods so as to bring the anode close to the defective spots in turn, they may be soon coated with metal. After the zinc has been thus coated with brass or with copper, it may be made to receive an adherent coat of gold or silver, and should be transferred direct from the brassing or coppering solutions to the gilding or plating solutions. If the finished gilded surface is to be bright, the article should go direct from the brassing to the gilding solution, but if some parts are to appear dead and others bright, the brassed zinc must be placed in a silvering solution until it gets a dead white coat of silver, then rinsed, and the intended bright parts scratch-brushed and burnished before placing in the gilding bath.

§ 73. **Cleaning Britannia Metal and Pewter.** These alloys of lead and tin, as well as the metals of which they are composed, require a special course of treatment to fit them for receiving an adherent coat of silver or of gold. The oxides of these metals and their alloys are soluble in hot caustic alkali solution. We have only to immerse them, therefore, in a hot solution of caustic potash to loosen any dirt or corrosion, brush the surface clean



and bright, rinse again in a caustic potash solution, and transfer at once to the silver-plating vat. If they are to be coated with gold or with nickel, they should be transferred to a hot brassing or coppering bath and receive a coat of brass or of copper before placing them in the gold or the nickel bath.

§ 74. **Cleaning Silver and Gold.** Tarnish on silver may be loosened by immersing the article in a hot solution of cyanide of potassium. Discoloured gold may be cleaned in a similar manner. Strong warm carbonate of ammonia solution will also loosen the tarnish on silver. After being thus loosened, the tarnish must be removed by brushing and scouring, or by means of a scratch brush. A special form of brush, called a "cup brush" (see Fig. 33, § 56), is used to prepare the insides of silver vessels about to be electro-gilt. Filigree work, and similar delicately formed articles in gold and silver, should be first heated on a jeweller's warming pan before plunging them in the hot cyanide solution, as we cannot clean this class of goods by brushing or scouring. East Indian jewellers employ lemon juice and green tamarind stems for cleaning gold and silver. The articles to be cleaned are covered with slices of lemon or with bruised tamarind stems in a vessel for several hours. They are then rinsed in water, boiled in soap-suds, again rinsed, and finally dried on a hot-water bath. Silver may also be cleaned by boiling in potato water.

§ 75. **Clearing off Corrosion and Rust.** *Corroded copper, brass, German silver,* and similar alloys, must be first immersed in a pickle composed of sulphuric acid 3 pints,

nitric acid  $1\frac{3}{4}$  pints, water 4 pints. This will loosen and dissolve the corrosion. *Corroded zinc* should be immersed in a pickle composed of sulphuric acid 1 fluid ounce, hydrochloric acid 2 fluid ounces, water 1 gallon. *Rusty iron or steel* should be first pickled in a solution composed of sulphuric acid 6 fluid ounces, hydrochloric acid 1 fluid ounce, water 1 gallon. When the rust has been removed, immerse the iron or steel in a pickle composed of sulphuric acid 1 pint, added to 1 gallon of water in which  $\frac{1}{4}$  lb. of zinc sulphate has been previously dissolved. Dirty lead, pewter, Britannia metal, and tin, may be cleaned in a hot solution of caustic potash or caustic soda.

§ 76. **Dips and Dipping.** When articles are in a good state of polish as regards the mere smoothness of the surface, but are coated with a film of oxidized metal, *i.e.*, tarnished, and are also free from animal matter, such as grease, the required condition of surface for plating may be imparted by dipping them in an acid solution, and then swilling them in an abundance of clean water. This process is named "dipping," and the acid solutions are known as "dips" or "steps." Copper, brass, German silver, and all copper alloys, may be dipped in common aquafortis (the nitric acid of commerce), or in a mixture composed of nitric acid 2 pints, sulphuric acid 4 pints, water 1 gallon. If this does not work well on bronze, German silver, and pale brass, add a little hydrochloric acid, say 1 fluid ounce at a time, until the desired effect has been obtained. A bright surface, named "bright lustre," may be imparted to the surface of such

alloys by dipping them for a few minutes in a mixture composed of hydrochloric acid 6 pints, old nitric acid dip 1 pint, water 1 pint. By repeated dips and subsequent brisk swilling in water, the desired brightness may generally be obtained; but if a dirty surface forms instead, this must be first scoured off with finely powdered pumice or whiting, and the dip repeated, or a finish imparted by a momentary dip in strong nitric acid. To alter a bright surface on these metals and



FIG. 43. DIPPING OR MIXING PAN FOR ACID PICKLES.

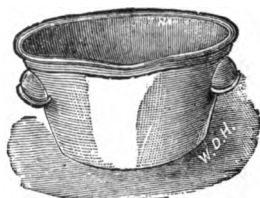

FIG. 44. DIPPING PAN FOR ACIDS.

alloys to one having a dead lustrous appearance, immerse them in a mixture composed of strong nitric acid 2 pints, sulphuric acid 1 pint, common salt 1 ounce. When taking them from this dip they must be at once passed into the bright lustre dip for a moment, and then quickly rinsed in an abundance of water.

In all dipping operations an abundance of clean water must be provided, and this should be contained in several vessels, if access cannot be had to a running stream. Water should be used without stint, and the articles well rinsed to free them from the least trace of acid. If

this is not done, the surface will rapidly oxidize and the plating solutions be spoiled by the introduction of acid to them. If the articles are not immediately placed in the bath they should be thrown in a weak solution of argol. The dipping acids must be contained in special



FIG. 45. STONWARE  
DIPPING BASKET.

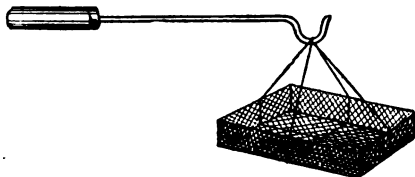

FIG. 47. DIPPING BASKET OF PLATINUM  
GAUZE.



FIG. 46. STONWARE  
DIPPING BOWL.



FIG. 48. TRINKETS  
STRUNG ON WIRE  
FOR DIPPING.

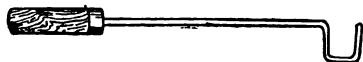

FIG. 49. DIPPING HOOK.

acid-proof stoneware vessels, such as those shown at Figs. 43 and 44. These may be obtained at Doulton's Lambeth Pottery if the plater cannot get them in his own neighbourhood. All other ware, such as earthenware, salt-glazed stoneware, and common stoneware, are useless, since the acid mixture will percolate through

them and peel off the glaze in the course of a few days. Stoneware pitchers are also provided for carrying the acids, and dipping baskets, such as those shown at Figs. 45 and 46, for dipping large numbers of small articles at a time. Some platers prefer a platinum gauze cage, such as that shown at Fig. 47, instead of a dipping bowl of stoneware. Articles with holes in them are strung on wire, as shown at Fig. 48. Larger articles are supported by strong hooks of copper or brass, fashioned as shown at Fig. 49. The hooks for dipping operations should be made of a metal nearly resembling that being dipped, to prevent galvanic action between the metals and consequent marks where the hook touches the article. The operation of dipping must be either carried on in the open air, where the workmen must stand to windward of the dipping pans, or in a "stink cupboard" connected by stoneware pipes to a flue with a strong up-draught. An up-draught may be insured by burning a gas-flare in the flue, or by means of a fire in a stove with an outlet into the flue. Some such means must always be provided, because the fumes given off in all operations of acid pickling and dipping are highly poisonous, besides being destructively corrosive to all material except glass, and specially glazed stoneware.

§ 77. **Potash and Cyanide Dips.** To free the surfaces of metal from grease left by the polishing processes, it is necessary to steep the articles in a hot potash dip made by dissolving half a pound of caustic potash or American potash in each gallon of water employed. This solution

should be kept in a wrought-iron tank or pot, with means provided for keeping it hot. As its solvent power is impaired quickly by contact with air, it should be covered up when not in use; and as its caustic properties are neutralized by the grease dissolved off the articles, the solution must be kept in working order by frequent renewals. Care must be taken in handling the material and its solutions, as it has a powerful caustic action on the skin and animal tissues. Cyanide dips are employed to dissolve slight traces of oxide from the surfaces of goods prepared for nickel-plating. The dip is prepared by dissolving half a pound of commercial cyanide of potassium in each gallon of water contained in a stoneware vessel. This dip is used cold.

§ 78. **Quicking Solution.** This name is given to a solution of mercury (commonly named quicksilver) used to impart a silvery lustre to articles about to receive a coat of silver or of gold. It was formerly supposed to act as a solder between the metal to be plated and the coat deposited on the metal, but it is now known to have no other purpose than that of protecting the metal's surface from the oxidizing action of the air, and may be dispensed with altogether if particular care is taken to insure a clean surface, and to get the article quickly into a good plating solution. A quicking solution of nitrate of mercury is made by dissolving mercury in a cold solution of dilute nitric acid until the acid will not dissolve any more mercury, and diluting this with enough distilled water to have one ounce of mercury in each gallon of water. This is employed in quicking copper surfaces.

Brass and German silver are best quicked in a solution of the double cyanide of mercury and potassium, made by adding cyanide of potassium to a nitrate of mercury quicking solution as long as a precipitate falls; then pour the whole on a calico filter, wash the precipitate on the filter, and dissolve it in a strong solution of cyanide of potassium. This solution also should contain one ounce of mercury to the gallon, and a slight excess of cyanide over and above that required to dissolve the precipitate. Almost any salt of mercury may be employed in making the cyanide of mercury solution. Zinc articles that have been coppered or brassed, are best quicked in a solution composed of one measure of strong nitrate of mercury solution, and two measures of sulphuric acid, added to 1,000 measures of water. The pernitrate of mercury, made by dissolving mercury in strong nitric acid, may also be used in making either of the two last solutions. The best test for the efficiency of a quicking solution is actual practice. The solution should deposit its metal in a bright condition by simple immersion upon the metal in course of preparation. If the mercury is thrown down quickly in large quantity or in blotches, the solution is unsuitable, either because it contains too much metal, or too much free nitric acid, which acts too energetically on the surface of the immersed article. If the deposit is black, there is too much free solvent in proportion to the mercury in solution, or other metals are present. In this case it will be better to throw away the old solution and make up a new one, than to attempt repairing the old one with fresh materials. To insure

success, the article should come out of the quicking solution with an uniformly thin, white, and bright coat of mercury, be rinsed at once in clean water, and transferred without loss of time to the plating solution. It will therefore be seen that the quicking process is the last before placing the articles in the plating vat.

§ 79. **Preparing Articles by Hand.** The introduction of American machinery for polishing metals, has, to a certain extent, superseded the old practice of preparing and finishing the articles by hand labour. But a large quantity of good work has been done by hand in the past; and the same good quality of work may be turned out in small workshops now, where all the scouring, polishing, and brushing must be laboriously done by hand. The first thing to be done, is to remove all dirt and corrosion. This is effected by means of the acid and other dips already mentioned in preceding sections, combined with alternate brushings with coarse bristle and wire brushes in the scouring trough. The next thing, is the removal of all corrosion pits, scratches, and other damages to the surface. The first part of the process is done with lumps of pumice stone previously faced by rubbing on a flat stone. With these prepared lumps dipped in water, go over all the corroded and scratched parts of the surface, grinding them down until they are almost obliterated, then go over all the surface in a similar manner to produce a uniform effect. This done, well rinse the article and dry it. Whilst dry, go over all the surface with a piece of fine emery cloth placed over a bung, and rub out the scratches made by the stoning process.



Scour off all traces of emery with a soft hair brush in water, well rinse the surface, and go all over it with water of Ayr stone to rub out all the scratches made by the emery. The stone must be frequently dipped in water and rubbed in one direction, going over all the surface until it appears quite smooth. When this has been accomplished, the surface may be finished with a piece of buff leather smeared with fine cut crocus compo., fine cut tripoli compo., or rotten stone and oil, the leather being glued to a strop-stick or held over a bung. The polished surface may now be scoured and prepared for plating as directed in previous sections.

§ 80. **Polishing Trinkets.** Such trinkets as studs, sleeve links, solitaires, buttons, earrings, finger rings, and small brooches, become tedious to polish when a large number of them have to be done by hand at one time. In factories where a large number of such things have to be polished, they are all put together in a rumble, that is, a barrel revolved by machinery, and polished by friction against each other. This may be imitated by hand, using a canvas sack instead of a barrel. The small goods are placed in a long canvas bag with some dry sawdust, and well shaken by two persons, one at each end, or one end may be tied to a post and the other shaken up and down until the small goods are polished. Messrs. J. E. Hartley and Son, Birmingham, have recently introduced a machine which plates and polishes such small goods in one operation at the rate of sixty gross per day. See § 120*b*.

## CHAPTER VI.

### ELECTRO-PLATING WITH SILVER.

§ 81. **Electro-Silvering.** The plater may choose either of the above terms as a name for his work when engaged in the electro-deposition of silver. The term "plating" was originally used in Sheffield to designate the process of coating metals by rolling them whilst hot between two plates of silver. The transition from this to the process of enclosing the metal between two plates of silver electro-deposited, is easy and natural. In the early days of this branch of the art, many experiments were made in devising various solutions of silver to be used as electro-plating solutions. These are fully described in Mr. Watt's excellent book on Electro-Deposition. As the outcome of all these experiments has been the almost universal selection of the double cyanide of silver and potassium solution as the best silver-plating solution, I shall not stay to give details of others.

§ 82. **Nitrate of Silver.** This is the salt of silver used in making up silver-plating solutions. Other salts, such as the chloride, sulphide, oxide, sulphite, hyposulphite, acetate, iodide, and chromate of silver may be mentioned, but most of them are made from the nitrate of silver, and

all, except this one, are unsuitable for conversion into cyanide of silver on account of the bad effects of the bye-products formed in the process of conversion. In using nitrate of silver, there is no waste, since the salt is perfectly soluble in distilled water, from which all the silver can be precipitated as a single cyanide of silver. The nitrate can also be cheaply and easily made, and can be purchased at a reasonably low price in a state of purity. As pure silver nitrate can usually be purchased at about 3*s.* 6*d.* per oz., and each 170 grains of the salt contains 108 grains of the pure metal, it does not pay either the amateur or the professional plater to make it at home. There are circumstances, however, when a man may wish to make his own silver nitrate, and to meet these, I herewith give directions for the process.

It must be understood at the outset that only perfectly pure silver is at all admissible in a silver-plating solution. Standard silver is useless, because this contains copper, as does also nearly all commercial silver, but alloyed silver may be refined at home by the plater and then converted into the pure silver nitrate. But, if we wish to have pure nitrate of silver, we must first have pure silver in the form of silver foil or grain silver. This obtained, we have only to dissolve the pure metal in a warm mixture of four parts pure nitric acid and one part distilled water, and evaporate off all excess of acid to form the desired silver salt. As this may still contain some free acid, it is advisable to dissolve the salt in distilled water and again evaporate and re-crystallize the silver nitrate. If now the salt contains any copper, it will

be shown on the sides of the evaporating dish in greenish or slightly blue streaks and spots. To demonstrate exactly the presence of copper, dissolve a small portion of the suspected nitrate of silver in a test tube with a little distilled water, and add to it a few drops of diluted liquor ammonia. If copper is present in the nitrate solution, a blue ring will be formed in the test tube where the ammonia meets the nitrate of copper, and the intensity of this blue ring will show at once whether the copper is present in large or in small quantity. If copper is detected, the whole mass of silver nitrate must be dissolved in distilled water, and common salt (sodium chloride) added as long as a white precipitate of silver chloride is thrown down. The liquid above this will contain all the copper in the form of copper chloride; and as this is soluble in water, whilst silver chloride is not, the two may be entirely separated by pouring away the supernatant liquor and washing the silver chloride several times in an abundance of clean hot water. This is done by pouring water into the vessel containing the silver chloride, stirring it up well with a glass rod, allowing the white powder to subside, and then pouring off the wash water. It is not necessary to pour off the last few drops of wash water each time, and at the last some of it may be left to cover the precipitate, and to this should be added a small quantity of hydrochloric acid. Some clean scraps of zinc or some granulated zinc must now be well stirred into the silver chloride precipitate and frequently moved about in it. The chlorine in the silver chloride, having a stronger affinity for zinc than it has for silver, will now leave the

silver in the form of very small grey grains, and combine with the zinc to form soluble zinc chloride. When all the silver chloride has been thus decomposed, and not a trace of the white precipitate remains, stir in a little more hydrochloric acid and pour off the zinc chloride solution. Next add equal parts of hydrochloric acid and water to the grey mass remaining, and stir up well for several minutes, to completely dissolve the last trace of zinc remaining entangled in the silver grains, and finally well wash the mass in an abundance of water, using distilled water for the last two washings. The grey wet mass should now be perfectly pure silver, which may be dried and melted in a crucible under a layer of charcoal, or dissolved at once in dilute nitric acid to form silver nitrate.

This operation must be performed in a stink cupboard, or in a fireplace with a very good draught, to carry away the highly poisonous fumes of nitrous oxide thrown off from the solution. It is best carried on in a porcelain capsule or evaporating dish over a sand bath heated by a small gas stove. Only enough acid should be employed to dissolve *all* the silver, as all excess acid will be wasted. The right quantity, is about four fluid ounces of acid and one of distilled water to each ounce of silver. The heat applied should be very moderate at first, until all the silver has been dissolved, then increased to evaporate excess water and acid, but in no case should the solution be allowed to boil. When it has become thick, it may be taken off the stove and set aside to cool. As the thick liquor cools,

it will congeal to a mass of crystals, and these may hold some free acid ; this may be removed by dissolving the crystals in distilled water and evaporating the solution again. All free acid left in a silver nitrate solution, means a corresponding loss of silver and of cyanide when making up the cyanide of silver solution, as the acid decomposes part of the cyanide of potassium, converting it into nitrate of potash and free cyanide gas, whilst some of the silver is left in the solution.

§ 83. **Cyanide of Silver.** The single cyanide of silver is prepared from nitrate of silver by adding a solution of cyanide of potassium to a solution of silver nitrate as long as a precipitate is formed. This precipitate is in the form of small white grains (if the silver nitrate is pure), and is composed of one equivalent of silver (108 parts) added to one equivalent of cyanogen (26 parts), making cyanide of silver, having a molecular weight of 134. The action which takes place on adding the two solutions is as follows: Potassium cyanide added to silver nitrate exchanges its cyanogen for the nitrogen and oxygen of the silver nitrate and becomes nitrate of potash, whilst the cyanogen unites with an equivalent of silver to form silver cyanide. As nitrate of potash is soluble in water, and cyanide of silver is not soluble in water, we have only to pour off the supernatant liquor and wash the precipitate in water to get pure cyanide of silver.

The most practical method of making silver cyanide for electro-plating purposes is as here directed: Dissolve the silver nitrate in distilled water or in clean rain water, in the proportion of  $1\frac{1}{2}$  ounces troy of the salt in

half a gallon of water. Next make a solution of cyanide of potassium in distilled water or in clean rain water, in the proportion of 1 ounce troy of 90 per cent. cyanide in 1 quart of water. Add this gradually, with frequent stirring, to the silver nitrate solution, pouring in the last few drams carefully and noting the result. If the precipitate settles down and leaves the supernatant liquid clear, enough cyanide has been added; but if the liquid is cloudy, make up some more cyanide solution, and add this drop by drop until the cloudy appearance has been removed. If too much cyanide is added, it will dissolve some of the precipitate, and give a slightly brown tint to the supernatant liquid as it passes through. In this case add a few drops of silver nitrate solution until it ceases to form a white cloudy precipitate. This operation is best carried on in a glass vessel, such as a bell glass fixed in a stand of wood, or in the glass cell of an accumulator. When all the precipitate has settled down, the supernatant liquor must be poured off into another vessel and treated for recovery of silver, as directed in § 141, and the silver cyanide well washed with water. It is then ready to be dissolved in strong cyanide solution to form the plating bath, or may be dried gently on a water bath, and be stored away in glass jars for future use. Cyanide of silver is insoluble in water and in cold nitric acid, but is freely soluble in solutions of ammonia, carbonate of ammonia, nitrate of ammonia, sal-ammoniac, hyposulphite of soda, the cyanides of ammonium, sodium, and potassium, ferrocyanide of potassium, and in solutions of the alkaline chlorides. Hydrochloric acid decomposes it with an

evolution of hydrocyanic acid gas ; boiling sulphuric acid and water has a similar effect, and produces a formation of silver sulphate. The gas given off in these reactions is dangerously poisonous, and must not be inhaled, as its effects are identical with those of prussic acid. It must be also understood that all the cyanides are equally dangerous poisons, and must be used with great care to avoid fatal consequences.

§ 84. **Double Cyanide of Silver and Potassium.** This salt, dissolved in distilled water, forms the best solution for silver-plating purposes. It is formed by dissolving an equivalent of silver cyanide (134 parts) in a solution containing an equivalent of pure cyanide of potassium (65 parts), the resulting salt being composed of one equivalent of silver (108 parts), one equivalent of potassium (39 parts), and two equivalents of cyanogen (52 parts), making together a double salt having the molecular weight 199.

In practice, the silver-plating solution of this salt is formed by dissolving the wet cyanide of silver (as freshly prepared) in a solution containing as much cyanide of potassium as it took to throw down the silver cyanide, and then adding about one-fifth more of potassium cyanide to form free cyanide, this excess being necessary to dissolve the silver anode and keep the solution in working order. This solution is then made up with distilled water so as to contain a certain weight of silver per gallon, which may vary from  $\frac{1}{2}$  an ounce up to 5 ounces or more in the gallon.

The variation in the strengths of silver-plating solu-



tions adopted by various platers, is regulated by the special requirements of the trade in which each workman is employed. Attenuated solutions, containing from  $\frac{1}{4}$  oz. to 1 oz. of silver in the gallon, deposit their silver more slowly than rich solutions containing from 4 oz. to 6 oz. of silver in the gallon, but the deposit from each and all may be equally good. As weak solutions are bad conductors of the current, a higher E. M. F. must be employed to force the current through them than will be found necessary in richer solutions. The amount of silver per gallon may be determined at the outset by reckoning each 170 ounces of silver nitrate to yield 108 ounces of pure silver. By a simple proportion sum based on these figures, the required silver for any solution may be calculated.

The quantity of excess cyanide of potassium (technically expressed as "free cyanide") in each gallon of solution also varies with the requirements of the work to be done in the solution. The generally received proportion is given above. This should, however, be lessened if such metals as bare copper, coppered zinc, coppered iron, or any other metal or alloy on which cyanide of potassium acts quickly, or on which silver is readily deposited from its plating solution, is to be plated in the solution. It is just in such instances as these where quicking the surface with mercury comes in useful. It is possible to so arrange the proportion of free cyanide in a solution as to suit exactly one class of work, and to deposit an adherent coat of silver in this class without quicking the surface, but it is not always convenient to

keep one solution for one class of work, and therefore, it is preferable to have a greater excess of cyanide, and to counteract the bad effects of this by quicking. A good solution must always have enough free cyanide in it to dissolve the anode cleanly and freely, but as an excessive quantity will dissolve the anode too rapidly, alter the proportionate parts of the solution, and cause a loose deposit of silver, this also must be avoided. Experience alone can determine the right quantity to the work in hand.

§ 85. **Cyanide of Potassium.** All directions involving the use of cyanide of potassium in given weights and proportions, must be qualified by the known quality of the cyanide about to be used. No other material used by the plater is so liable to variations in quality. The quality is determinable by the amount of cyanogen contained in the salt. Each 65 parts should contain 26 parts of cyanogen, and 39 parts of potassium; but the best commercial cyanide rarely assays 98 per cent. of cyanide of potassium, indeed it is a good sample which will show 95 per cent. of pure cyanide. The impurities may consist of iron, carbon, silica, and the carbonate, sulphide, chloride, cyanate, and ferrocyanide of potassium. Some of these are contracted in the process of manufacture. Carbon is added to the salt whilst in process of manufacture, to prevent formation of the cyanate, and this gives to some samples a dirty grey appearance. White samples absorb carbonic dioxide from the atmosphere, with formation of the carbonate and cyanate of potassium. If care be not taken in selecting the yellow

prussiate of potash used in making cyanide of potassium, or if the makers are not sufficiently careful in the manufacturing process, as much as 75 per cent. of the salt will consist of these impurities, and only 25 per cent. turn out to be pure cyanide. Pure white cyanide of potassium resembles (nearly) in appearance, flakes of white sugar frosting, with a wax-like gloss on their rounded edges. Good grey, or "black cyanide" as it is sometimes called, resembles lumps of grey granite, and all have a peculiar disagreeable odour, which has been likened to that of bitter almonds. But no odour or peculiarity of colour will help us to determine the degree of purity in cyanide. I have analyzed samples of cyanide having a beautiful white appearance, and found them to contain 75 per cent. of foreign salts, whilst a sample of most unpromising dirty stuff, having a brownish grey tint, showed only 10 per cent. impurity. Nor can one be guided in a choice of cyanide by the price charged for it, except when sold by firms who make platers' outfits a speciality. Unprincipled middlemen, who scruple not to line their own pockets whilst fleecing the poor plater, have been known to charge 8*s.* per lb. for 95 per cent. grey cyanide, although a fair price for this quality is 2*s.* 6*d.* per lb. I have paid 2*s.* 9*d.* per lb. for worthless rubbish of very fair appearance, but containing less than 25 per cent. cyanide, and have bought 98 per cent. pure white cyanide at the same figure.

In making up a plating or a gilding solution, the quality of cyanide employed to precipitate the cyanides of silver or of gold need not receive consideration, as

none of its impurities enter into combination with these metals whilst forming their single cyanides. But, when the single cyanides are to be dissolved to form the plating solution, cyanide of potassium of the best quality should be employed, because, when common cyanide is used, all its impurities enter into the solution and load the bath with foreign matter at the outset. Best quality cyanide only should be used in keeping these solutions in working order, because all the impurities contained in the common qualities enter into the solution and impair its condition by interposing salts which can take no part in the electrolysis of the plating solution, and therefore offer a useless resistance to the current. Apart from this, however, there are commercial reasons against the use of common qualities, since the large per centage of impurity in them is sheer waste of material.

§ 86. **Testing Cyanide of Potassium.** Since so much depends upon the quality of cyanide employed in making up and maintaining plating solutions, the plater should be prepared to test each sample before using it. This can be easily done by means of a graduated burette, or a similar glass instrument graduated for measuring small quantities of liquid. I prefer for my own use a Mohr burette to hold 1,000 grains of water, graduated in grains, and furnished with a glass stop-cock. This instrument resembles a long glass tube, as shown at Fig. 50, and is held by a wood clip lined with cork, mounted on a stand similar to that of a filter-holder. Another instrument, less convenient, is shown at Fig. 51. An ordinary graduated glass measure will

also be needed, and this may be employed entirely in making rough tests of the sample, but in this case a larger quantity of the sample must be used up in making the test, and exact accuracy cannot be guaranteed. The

price of a Mohr burette will be under 5*s.*, and the holder need not cost over another 2*s. 6d.*

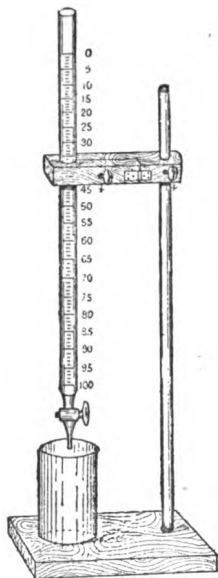

FIG. 50. MOHR'S BURETTE AND HOLDER.

The sample of cyanide to be tested must be accurately weighed in a balance showing a variation of  $\frac{1}{10}$  grain. Either 100 grains of the cyanide should be weighed out, or some multiple of this quantity, or (if preferred by the student) some decimal part of this number. The sample thus selected may be dissolved in any quantity of distilled water, but greater accuracy is secured in dilute solutions containing the salt in the proportion of 100 grains in 5 fluid ounces of water. This solution of cyanide should be contained in a tall glass beaker, as it will have to be shaken by hand

during the testing process. Next weigh out 131 grains of pure double crystallized silver nitrate, and dissolve in 1,000 grains of pure distilled water. Place this in a burette holding 1,000 grains, and graduated in not less than 100 divisions, representing 10 grains of solution in each

division. Each division, or each 10 grains of solution, will contain 1.31 grains of silver nitrate, and this will satisfy 1 grain of potassium cyanide. If 100 grains of potassium cyanide is dissolved in the solution to be tested, each 10 grains of the testing solution will satisfy 1 per cent. of cyanide. Deliver the testing solution from the burette gradually into the beaker containing the cyanide solution. At first the silver nitrate solution will curdle as it touches the cyanide solution, and the curdy precipitate will dissolve almost as soon as formed, or disperse on shaking the beaker. When the precipitated silver cyanide ceases to thus quickly dissolve, the beaker must be shaken or the liquid stirred with a glass rod until all the precipitate dissolves, and the testing solution delivered with more care. Thus go on delivering small quantities of the testing solution (some two or three drops at a time), and shaking the cyanide solution between each delivery, until the cyanide solution refuses to dissolve the last few drops of silver nitrate, and a few clots of the white precipitate are left undissolved. The number of divisions of nitrate solution thus used will show at once the per centage of real cyanide in the cyanide of potassium solution. Thus, if the 100 grains of potassium cyanide contain 90 grains of the active principle, 900 grains of the nitrate of silver solution will have been used, and this will have been contained in 90

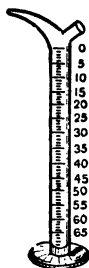

FIG. 51. BINK'S BURETTE.

divisions of the burette. The sample of cyanide of potassium thus tested will have contained 90 per cent. of real cyanide and 10 per cent. of impurity, consisting of all or some of those mentioned in the last section.

§ 87. **Silvering Solutions.** As some text-books give the plater a choice of some seven or eight silvering solutions, it is perhaps desirable to notice them here and examine their practical qualities. In some of these the oxide of silver is recommended instead of the single cyanide. This is prepared by adding to a nitrate solution some liquid ammonia, caustic potash, caustic soda, or magnesia. The precipitate thus thrown down is washed, and dissolved in cyanide of potassium. The solution is therefore one of the double cyanide of silver and potassium mixed with one of caustic potash. As this salt is quite useless in a plating solution, and quite as much cyanide must be employed as in making up the standard solution, nothing is gained by converting the nitrate into an oxide of silver. Similar reasons would lead me to reject solutions in which carbonate of silver is first formed and then dissolved in a solution of potassium cyanide.

Solutions prepared by the battery process have the same faults, as caustic potash is formed in the solution (according to Mr. Gore), probably by oxidation of some of the potash.

Mr. Watt recommends a solution of iodide of silver in cyanide of potassium as the best for depositing silver on German silver, without first quicking with mercury. The iodide of silver is precipitated from a solution of

its nitrate by adding a solution of iodide of potassium in the proportion of 3 ounces of the latter to 1 ounce of the former salt. The precipitate must be allowed to settle in a dark place and then well washed. The same care must be exercised throughout as in throwing down the cyanide of silver, as explained in § 84, and the solution made up as a double cyanide of silver and potassium solution. A lack of free cyanide in this solution is shown by a greenish film on the anode.

The same author also gives directions for making up a silver solution by dissolving washed chloride of silver in a strong solution of potassium cyanide. This solution, which should contain 1 ounce of silver to the gallon, will deposit a very white coating of silver on chased figures, cast figures, and other work not requiring to be burnished, but only scratch-brushed, or left dead white. Solutions made up from silver chloride will not deposit a firm coat of silver, the deposit being always liable to strip under the burnisher. This fact in itself should deter platers from "faking" up a solution with common salt, as this forms with the potassium a chloride of potash, and this causes a loose deposit of silver.

Silver sulphate dissolved in carbonate of ammonia, and silver cyanide dissolved in the same, has also been used for depositing silver on German silver. Solutions containing hyposulphite of silver are decomposed by sunlight, and those containing yellow prussiate of potash do not dissolve the anode freely.

§ 88. **Management of Silver-Plating Solutions.** The golden rule to guide the plater in the management of



his plating solutions is: Never add anything to the solution except distilled water and the best cyanide of potassium when these are required. Do not be tempted into "faking" up the solution with other salts. If the solution is too rich in silver for a given purpose, take out some of it and dilute the rest with distilled water. If it is not rich enough, do not add any other salt of silver except silver cyanide well washed as at first. Keep the solution covered up when not in use, to keep out dust and insects, and filter it through a filter made of well-washed calico should it be dirty. Shade it from direct sunlight, as this decomposes some of the silver salt and wastes the solution. Keep it as near as possible to a regular metal pitch, that is, with an approved quantity of silver in each gallon of solution, by working it with a sufficient anode surface and a sufficient quantity of free cyanide to dissolve the anodes freely. When the anode surface exposed to the action of the solution exceeds slightly the surface of goods to be plated, and the solution contains a sufficient quantity of free cyanide, the current will dissolve off from the anode as much silver as it deposits on the articles being plated. If, however, the contrary conditions are present, the solution will be gradually impoverished, and the deposit show, sooner or later, the bad effects of impoverishment. It is quite possible to err on the contrary side, and get a solution too rich in silver from having too much free cyanide, or exposing too much anode surface to the solution. A lack of free cyanide is shown when the anode plates assume a hard close-grained appearance, and are more

or less coated with a dark slimy deposit of silver oxide. An excess of free cyanide is shown on the anodes by their very white frosted surfaces being pitted and their edges ragged. It is also shown on the deposit by a soft loosely-deposited coat which strips under the scratch brush and the burnisher. The odour of cyanide is also strongly pronounced, and this is mingled with an odour of ammonia in hot weather if much work is being done. In adding free cyanide, it is best to dissolve it in distilled water and filter the solution into the bath to remove any loose dirt held in the cyanide of potassium.

Never swill freshly cleaned articles in the plating solution, nor allow them to remain in the solution unless they form part of the plating circuit and are receiving a deposit of silver; because the free cyanide will dissolve copper, brass, and other metals, and thus contaminate the solution with base metal. Solutions thus contaminated will not yield a pure white deposit of silver. Owing to such a large bulk of liquid being contained in a wooden vat, its temperature cannot be regulated, but the best results are obtained between 50° and 60° Fah.

In a word or two, the plater should jealously guard his solution from all dirt and foreign substances, and carefully preserve it in the best working condition. Pure silver only must be used for anodes.

§ 89. **Character of Silver Deposit.** Electro-deposited silver is pure, if the silver employed in making up the solution is pure and the anodes are also pure. As the articles leave the solution coated with silver, their surfaces appear to have been whitewashed. The coat of pure

silver upon them is composed of a number of fine grains beautifully massed and interlaced together. In this condition they absorb the light, and have a peculiar dead white appearance, named "matt" in the plating trade. If the solution is contaminated with copper or other base metal, or if the current is too dense, or if the solution is deficient in silver, or if the E. M. F. of the current is too high, the deposit will have a hard and dark appearance, and will be intractable to the burnisher. If the current is too dense, the silver will go on loosely in dark grey grains, and the deposit is said to be burnt. This may be prevented by interposing a resistance in the circuit, and thus checking the volume of current passing through the article being plated. It may also be prevented by moving the article at a greater distance from the anode, or by placing more articles in the vat, or by lessening the anode surface exposed to the solution. If the E. M. F. of the current is too high, the bad effects just noted will be intensified, providing the volume is also large; but a thin current with a high E. M. F. will also deposit silver in a hard dark condition, different from that above noticed. For this there is no other remedy except that of reducing the E. M. F. by driving the dynamo at a slower speed, or taking off battery cells and reducing the number in series. If the hard dark appearance of the deposit is due to a deficiency of silver in the solution, it must be remedied by adding more silver cyanide, or working with a weaker current and placing the articles nearer the anode. In another section (§ 104) I give directions for analyzing a plating solution. If the solu-

tion is contaminated with copper or other base metal, it is only fit for the most common work, and can only be remedied by turning it over to the refiner to be evaporated and reduced to old silver. One other cause of hard dark silver must be mentioned here. This is due to the addition of brightening liquid to the solution, to get a bright deposit from it. A solution thus treated, is spoiled for general work, and will rarely recover its former condition.

All solutions have a tendency to settle down in stratified layers, with the denser and richer layers nearest the bottom of the vat, and light layers containing an excess of free cyanide near the top. In this condition they are apt to deposit silver in vertical streaks, and also in horizontal patches on large articles. This fault is intensified in rich solutions and in old solutions. It may be prevented by agitation of the solution, or keeping the articles in motion whilst they are being plated. This insures an equable coating of silver all over the articles. Motion may be given to the articles, by suspending them to a large ring hung by wires to a bottle-jack suspended over the bath and connected to the positive pole of the battery. If dynamo machines are employed as generators of the current, the same machinery can be adapted to drive an eccentric disc connected by a rod to a movable frame on which the cathode rods rest. The effect of stratification of the solution is most marked on forks and spoons, which receive a thicker coat on the lower parts if allowed to rest in the solution. Even when motion is imparted to them whilst being plated, this fault

can only be met by turning them when partly coated, so as to have the handles downward during a part of the time, and the other parts downward during the remainder of the time. Prominent parts of articles always take the silver first, and get a thicker deposit than hollow and obscure parts, but flat surfaces take the silver quicker and better than those that are perforated and ornamented with raised projections. It will also be noticed that the silver is harder and more crystalline on projecting parts, such as the prongs of forks, than on plane surfaces.

If silver-plated articles are exposed for a few minutes to the air and light after taking them from the bath, before rinsing them, the deposit will turn yellow. This is due to the action of light and air on the sub-cyanide of silver left on the surface. To prevent this, gently swill the articles to and fro for a few moments in the plating solution after disconnecting them from the cathode, rinse them at once in hot water, and place them in hot clean box-wood sawdust. Extra care should be taken in this finishing operation when the surface has to be left dead white instead of being polished or burnished.

§ 90. **Thickness of Silver Deposits.** It is not practicable to gauge the thickness of a silver deposit with a pair of callipers, or even with a micrometer calliper gauge, but the thickness may be ascertained if we know its superficial area and its weight. The first can be obtained by exact measurement and calculation, and the next by noting the difference between the weight of the article both before and after plating. The weight of silver may also be approximately known by noting the volume of

current passing through the solution in a given time. Thus it takes one ampère of current per second to deposit  $\cdot 017064$  gr. of silver. If this volume of current passes through the solution for one hour, it should deposit  $61\cdot 344$  grs. of silver, and this should be the weight of silver acquired by the article. If now we measure the coated surface, we can ascertain exactly the thickness of the silver coat. The following calculations may help the plater to determine the thickness of his silver deposit. The calculations are made on 1000ths of an inch. If the deposit weighs, on calculation,  $2\cdot 5371$  grs. on each square inch, the deposit is  $\cdot 001$  inch in thickness ;  $5\cdot 0742$  grs. per square inch will give a thickness of  $\cdot 002$  inch ;  $7\cdot 6113$  grs., a thickness of  $\cdot 003$  inch ;  $10\cdot 1484$  grs., a thickness of  $\cdot 004$  inch ;  $12\cdot 6855$  grs., a thickness of  $\cdot 005$  inch, or No. 40 B.W.G. ;  $25\cdot 3710$  grs., a thickness of  $\cdot 010$  inch, or No. 32 B.W.G. The last two may be regarded as thick deposits of silver. Mr. Gore says, in his book on the art of Electro-Metallurgy : " One ounce of silver per square foot of surface is equal to a coating of about the thickness of thin writing paper, and is considered an excellent coating." This would be at the rate of  $3\cdot 04$  grs. per square inch, and have a thickness a little over  $\cdot 001$  inch. Mr. Gore also says : " Great quantities of Britannia metal articles are coated with only a few pennyweights of silver per square foot." The thickness of the deposit cannot be determined by its appearance only, as almost any degree of thinness may be made to *look* well. In France the thickness of the deposit is controlled by law, and French electro-platers are bound to give an account

of the weight of silver deposited on an article, which is then marked by a government official to denote the quality. In England there is no such restriction, but respectable firms are always willing to give a guarantee with really good work sold at a fair price.

§ 91. **Rate of Silver Deposition.** Silver may be deposited from its solutions in good condition at the rate of  $\cdot 017064$  gr. per second on  $\cdot 1$  square foot of surface with 1 ampère of current. The following table will show at a glance the rate suitable for surfaces up to 10 square feet. The decimal parts of a square foot may be taken as square inches for all practical purposes.

TABLE SHOWING THE RATE OF SILVER DEPOSITS.

Sq. feet exposed.	Rate of current. Ampères.	Grains of silver deposited in one hour.	Grains of silver deposited in one day of ten hours.	Weight of silver deposited per day, given in ounces Troy.		
				ozs.	dwt.	grs
$\cdot 1$	1	61 $\cdot$ 344	613 $\cdot$ 44	1	5	13
$\frac{1}{4}$ = $\cdot 2$	2	122 $\cdot$ 688	1226 $\cdot$ 88	2	11	2
$\cdot 3$	3	184 $\cdot$ 032	1840 $\cdot$ 32	3	16	16
$\cdot 4$	4	245 $\cdot$ 376	2453 $\cdot$ 76	5	2	5
$\frac{1}{2}$ = $\cdot 5$	5	306 $\cdot$ 720	3067 $\cdot$ 20	6	7	19
$\cdot 6$	6	368 $\cdot$ 064	3680 $\cdot$ 64	7	13	8
$\frac{3}{4}$ = $\cdot 7$	7	429 $\cdot$ 408	4294 $\cdot$ 08	8	18	22
$\cdot 8$	8	490 $\cdot$ 752	4907 $\cdot$ 52	10	4	11
$\cdot 9$	9	552 $\cdot$ 096	5520 $\cdot$ 96	11	10	0
1 $\cdot$	10	613 $\cdot$ 440	6134 $\cdot$ 40	12	15	14
2 $\cdot$	20	1226 $\cdot$ 880	12268 $\cdot$ 80	25	11	4
3 $\cdot$	30	1840 $\cdot$ 320	18403 $\cdot$ 20	38	6	19
4	40	2453 $\cdot$ 760	24537 $\cdot$ 60	51	2	9
5	50	3067 $\cdot$ 200	30672 $\cdot$ 00	61	16	8
6	60	3680 $\cdot$ 640	36806 $\cdot$ 40	76	16	2
7	70	4294 $\cdot$ 080	42940 $\cdot$ 80	89	9	4
8	80	4907 $\cdot$ 520	49075 $\cdot$ 20	100	3	3
9	90	5520 $\cdot$ 960	55209 $\cdot$ 60	115	0	9
10	100	6134 $\cdot$ 400	61344 $\cdot$ 00	127	16	0

On referring to the above table, the plater can ascertain at a glance how much current he will require to coat a surface with silver, or how much surface a certain volume of current will coat properly, or how much silver will be deposited by a known volume of current in a given time. It should be clearly understood, however, that the above figures relate solely to the actual volume of current passing through a solution as measured by an ammeter in circuit, but not to the mere capacity of the generator as ascertained by measurement of the current on short circuit between its poles. When dynamos are advertised as having a capacity of so many ampères or so many ounces of silver per hour, the figures merely give an idea of their maximum output, without reference to the resistance of the circuit. The maximum current obtainable from a dynamo can only be made available in depositing silver when the resistance of the conducting wire is low, and the full surfaces of anode and cathode are exposed to the plating solution.

§ 92. **Bright Silver Plating.** Silver is deposited from a silver plating solution in a matt condition without lustre, and is afterwards made bright by scratch-brushing, polishing, and burnishing. It is sometimes desirable to deposit silver in a bright condition upon parts that will not admit of being burnished. This is effected by adding a solution of carbon bisulphide to the plating solution and stirring it in well some hours before the operation of plating. The following is a most convenient method for preparing a brightening solution. Procure one quart of old silver solution, place it in a bottle



capable of holding two quarts, and furnished with a glass stopper. Add to this, two fluid ounces of carbon bisulphide, place the stopper in the bottle and shake well together, then nearly fill the bottle with a strong solution of potassium cyanide, again shake well together, and then set aside in a cool place for twenty-four hours. The solution for bright plating should either be an old one, or one set aside for the purpose. To this add two fluid ounces of the brightening solution as often as may be required. Too much of this will quite spoil the solution, and the deposit of silver will be brownish or spotted with brown spots. The bright deposit spreads from the lower parts of the articles upward until all has been covered. It is darker than ordinary silver, and the sombre hue deepens after the article has been removed from the solution unless well rinsed in boiling water. Bisulphide of carbon has a most noxious odour, resembling that of rotting cabbage. Its vapour is inflammable and highly poisonous. It should therefore be used with caution, and kept in a closely stoppered bottle in a cool place. Its solution with cyanide of potassium gradually turns black, but the blackness may be lessened by adding plenty of free cyanide. According to Planté, a bright silver deposit may be obtained by adding a little sulphide of silver to a plating solution.

§ 93. **Practical Hints.** Always rinse the articles well in clean water after each cleaning operation, and especially after dipping in acid, before placing them in the silvering bath. Always connect the slinging wires before dipping and rinsing the goods, so as not to touch

them with the fingers. Pass Britannia metal, lead, and pewter direct from the potash bath into the plating vat without rinsing. Do not attempt to plate articles made of different metals together in the same vat at the same time. Connect the dynamo or battery to the vat before getting the articles ready, so that they may be placed at once under the influence of the current. Adapt the current to the size of the article by means of the resistance board or the size of the anode, and turn on more current when more articles are placed in the vat. Keep the articles moving from the first, and until they are taken from the vat. Silver goes on more evenly when the articles are moving. Take them from the bath when they have received a thin coat of silver all over, and scratch-brush the deposit to test its adherence. If patches strip off, clear away all the remaining coat and begin again afresh. If depositing silver by weight on spoons, forks, and similar articles of uniform size, weigh one of the articles, and employ this as the test sample for the whole. Keep the suspending rods [laid across the vat] clean by frequent rubbing with emery cloth, but do not clean them whilst in position over the vat. Also keep all slinging wires clean. Unless this is done, the deposit will not be equally thick on all the batch of goods being plated. Anneal the anode plates before using, by making them red hot. Cut a long slot with a cold chisel near the edges of both ends, and insert in this a narrow strip of pure silver bent in the form of a hook for making connection between the anode and the suspending rod. Turn the anode plates each day, and thus wear both

ends equally. When the plates are cut through in the middle by the action of the solution, trim the ragged edges with a pair of shears, and hang the thickest parts in the bath.

§ 94. **Finishing Silver-Plated Articles.** When the articles have received a sufficiently thick deposit of silver, disconnect each from the connecting rod, one at a time, swill them in the plating solution for a moment, allow them to drain off the solution taken by them from the bath, rinse each article well in clean hot water, and place at once in clean hot box-wood sawdust to dry. In this they should dry quite white. If they dry yellow or spotty, the cause may be traced to imperfect rinsing, or the use of soiled sawdust. When they are dry they may be taken to the scratch-brush lathe described in § 58, and brushed until all the white "burr" or "matt" has been worked down. The brushes must not be worked dry, or they will stain the silver with brass, but must be kept wet with stale beer. This is best applied by means of a small drip-cock over the brush, attached to a lead pipe leading to a small cistern of stale beer placed over the lathe. Very little will be required to keep the brush moist, and the drips may be used over again if caught in a tray beneath the brush. The brush should either be made to revolve away from the workman, or from left to right, to prevent splashing of the beer on his clothes, and snatching of the work out of his hands by the brush. Only a very moderate pressure is required on the article to get its surface well brushed, a little more being necessary to force the wires of the brush

into crevices. Brushes suitable to hollow goods, such as thimbles and cups, and to intricate patterns, have been described in § 56. The brushes, as they come from the maker, are usually very stiff, and the ends of the wires very sharp. In this condition they are apt to tear off some of the silver when first used. It is therefore advisable to "break down" the points by holding a piece of steel or cast iron to the revolving brush for a few minutes before using it on the silver-plated article. This wears down the sharpness of the freshly cut ends, and breaks the brush into a working condition. Brushes should, however, be selected to suit the class of work being done, the softer wires for thin coated goods, and stiffer wires for more thickly covered and larger articles. A certain state of finish suitable to low priced goods may be imparted by suitable soft scratch brushes alone. When the articles have been scratch-brushed, they must be rinsed in clean water, and again dried in sawdust preparatory to the next operations of polishing or burnishing.

§ 95. **Polishing Silver Plate and Silver.** The degree of brightness or lustre imparted to the surface of silver-plated articles is insured by the number of processes through which it passes. A dull whiteness is left on the surface after scratch-brushing. A better finish is given by the process of polishing. This is usually done on a polishing lathe, with similar buffs, bobs, and circular brushes to those employed in polishing the metal before plating. The lathe may be driven by foot power. A good lathe for this purpose is represented at Fig. 52,

which shows an American patent foot lathe sold in this country by Messrs. J. E. Hartley and Son, 13, St. Paul's

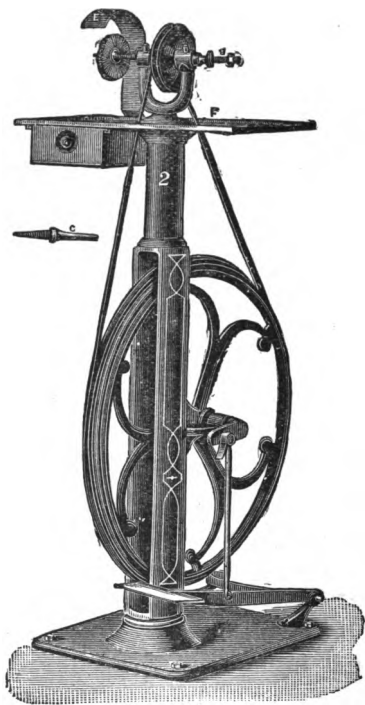

FIG. 52. FOOT-POWER POLISHING LATHE.

*B*, Spindle for Mops and Dollies. *C*, Spindle for Circular Brushes.  
*F*, Tray.

Square, Birmingham. This lathe stands 3 feet 9 inches from floor to centre of spindle, has a 26 inch driving wheel, turned with grooves for three different speeds, and

will run the spindle easily at from 300 to 3,000 revolutions per minute. The weight of the whole is 128 lbs., and the price £3 10s. The spindle B is suitable for leather, calico, and swansdown bobs, buffs, and mops; this can be unscrewed and replaced by the spindle C, which is furnished with a taper screw for the bosses of circular brushes.

If the coat of silver is thick and rough, it will be advisable to first employ a leather buff charged with tripoli compo., or with rotten-stone and oil, and thus take off the roughness of the surface. Rub some tripoli or rotten-stone paste on the buff, and revolve it whilst pressing the article against it evenly all over the surface. Examine the surface from time to time, and when a certain polish has been imparted, change the buff for a leather bob (made up of leather discs) also charged with tripoli compo., or with rotten-stone and oil. When the surface is deemed to be polished enough, the article must be laid aside for the finishing or colouring process mentioned in the next section. If the deposit is thin, the buff must not be employed, or it will be likely to cut through the thin coat of silver. In such cases as these, soft bobs and mops of leather only must be employed, the softness of the bob, and the pressure employed, being regulated by the character of the work in hand. When the surface is broken up into intricate patterns, the use of a bristle brush will be preferable to a leather bob although a clever workman can often suit the thickness of his bobs to his work.

§ 96. **Colouring and Finishing.** These terms are em-

ployed to denote the finishing process of polishing silver and silver-plated goods. The work is done in the finishing room of large establishments. The articles are first well cleansed by washing in warm water, to which a little soap and soda has been added. They are then held to a revolving mop or dolly made of swansdown, charged with a paste made of the finest jeweller's rouge and water. The lathe is driven at a very high rate of speed, and this, together with the rouge paste, imparts a very brilliant lustre to the already partly polished surface. A clean dolly will fetch out any rouge that may get in the crevices. The same process may be performed by hand, if the finisher has a soft, velvety hand. The cleaned articles are first wiped dry with a piece of soft linen, then smeared with the rouge paste above mentioned, or a very fine rouge compo. made for the purpose. The paste is applied with the tips of the fingers, and then rubbed briskly with the ball of the thumb, or with the opposite soft muscle below the little finger, until a brilliant lustre has been obtained uniformly all over the surface. The remaining traces of rouge are washed out with warm soapy water applied with a soft brush kept for the purpose, the surface is then rubbed dry with clean soft linen rags, and finally with a piece of fine wash-leather. The utmost care and cleanliness must be observed in this last process, as the least particle of grit in the rouge, on the hands, on the linen, or on the leather, will spoil the whole effect.

§ 97. **Burnishing.** When a very highly polished mirror surface is required on spoons, forks, salvers, and stoutly

plated table ware, they are submitted to the burnisher, after they have been scratch-brushed, instead of to the polisher and finisher. In large establishments the work of burnishing is done by skilled female operatives who have served an apprenticeship to this branch of the trade, or have become skilful in the use of the tools by long practice. As the amateur plater, and jewellers in a small way of business, cannot be within reach of this class of skilled labour, I have deemed it advisable to devote a section to this work for their benefit.

The operation of burnishing is performed by means of highly polished steel tools, or tools faced with polished pieces of agate, bloodstone, and other hard substances capable of receiving a highly polished smooth surface. These tools are pressed on the surface of the plated article, and rubbed to and fro until a bright mirror-like surface has been produced.

The plated articles, having been scratch-brushed and dried in sawdust, are next taken in hand to be burnished. The work is first *prepared* by scouring the surface with very fine silver sand applied on a soft flannel pad dipped in warm soapy water. This is done to level down any roughness left from the scratch brush, and so secure a uniform surface, but the amateur can effect a similar condition by first going over the surface on his polishing lathe, and then brushing it with a soft brush dipped in warm soapy water. The work must then be well rinsed in warm water, and dried by rubbing with soft linen rags. The next operation is *grounding*. This is done with steel burnishers having a long thin edge. A few of



these, of different sizes and shapes to suit the different surfaces to be burnished, are shown at Figs. 53 to 60.

It will be seen that these steel tools are mounted in wooden handles about four inches in length. The tool is held in the right hand with the handle resting on the back of the little finger near the first knuckle, the next three fingers on the upper part of the handle, and the thumb on the top to apply pressure. The work is placed

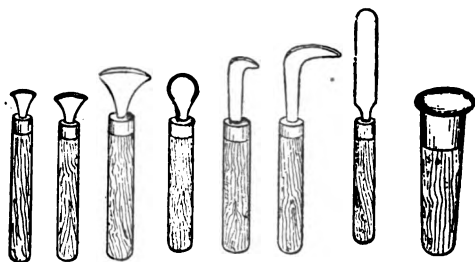

FIGS. 53-60.

**BURNISHERS FOR BURNISHING ELECTRO-PLATED ARTICLES.**

on a pad of linen rag on a bench or table of convenient height. A lubricating liquid having been made of soap shavings and warm water, the burnisher must be dipped in the suds and applied to the surface of the plated article in a slanting direction with moderate pressure. Commence at one selected part, and direct the strokes of the burnisher so that each succeeding stroke shall slightly overlap that of its predecessor. The strokes must be all in one direction, and the surface thus gone over until all has been grounded. This will leave an

imperfectly burnished surface. Next go over the whole with a thicker steel burnisher, or one of thick bloodstone, in a similar manner, to erase the marks left by the grounding tool. Then finish with a bloodstone burnisher of the finest quality to impart the required *finish* lustre. The burnisher must be kept well lubricated with soap-suds during the whole process, or it will heat, drag on the surface, and strip the coat. It must also be wiped frequently to remove the dirty suds, and frequently polished on a piece of buff leather fixed on a slab of wood (as a razor strop, hone, or oilstone) charged with jeweller's rouge for steel burnishers, or with putty powder for the bloodstone burnishers. Fresh suds must be made up for each day's work, and the burnishers must be kept free from the least trace of rust by frequent examination and polishing. Plated articles made of Britannia metal, pewter, lead, and similar soft metals, will not stand burnishing, and only very moderate pressure may be applied to those made of copper or of soft brass. Thin deposits should be very lightly burnished, or not burnished at all if very thin. Very thin deposits should be finished by polishing as directed in § 95.

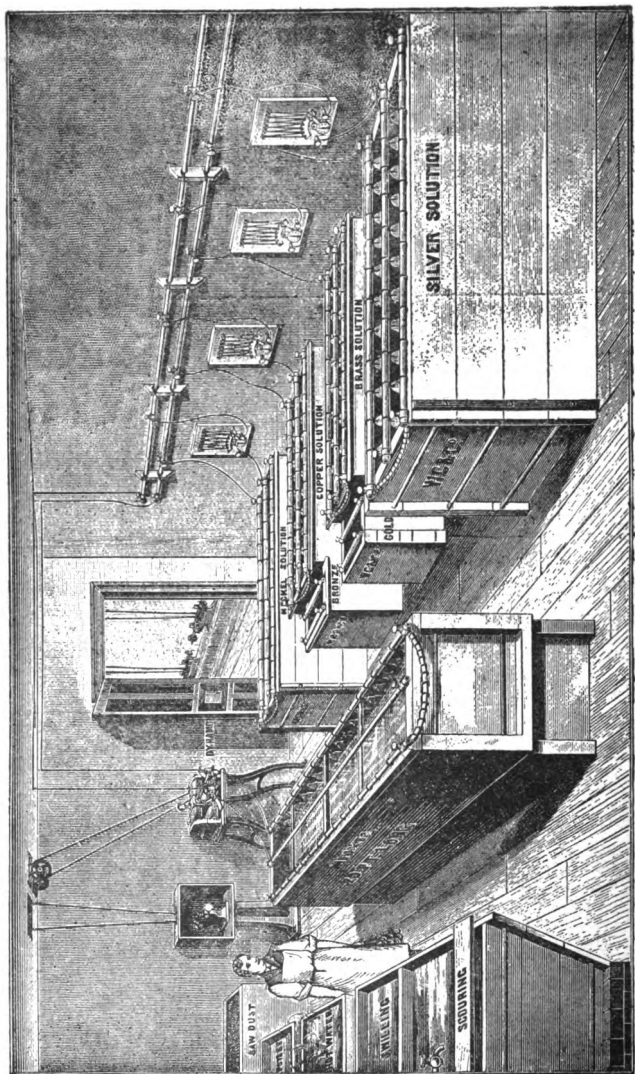

VIEW OF INTERIOR OF A BIRMINGHAM ELECTRO-PLATING WORKSHOP.

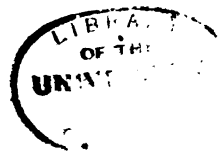

## CHAPTER VII.

### ELECTRO-PLATING WITH GOLD AND WITH PLATINUM.

§ 98. **Electro-Gilding.** Gold is easily electro-deposited from all its solutions by a small current of electricity, but the deposits of gold are not all equally good from all solutions. Although it is a metal easily deposited, there is no other capable of such an infinite variety in the colour and character of the deposit. This varies with the character of the solution from which it was deposited, the temperature of the solution at the time of deposition, and the current employed to deposit the metal. As gold is deposited from its solution in potassium cyanide in good condition and colour, this solution has become the general favourite with electro-gilders.

§ 99. **Terchloride of Gold.** As this soluble salt of gold can be readily prepared, it is used generally in making up gold solutions. It is easily made by dissolving pure gold in a solution of *aqua regia*, evaporating excess of acid, and continuing the heat until the salt forms ruby red crystals on the sides of the evaporating dish. The details of this process are as follows: Make up a mixture of 3 parts pure hydrochloric acid, 1 part pure nitric acid, and 1 part distilled water, to dissolve 1 part of pure

gold, that is to say, it will take 6 fluid ounces of this mixture to dissolve 1 Troy ounce of pure gold. The acid mixture must be placed in a large glass beaker, or large porcelain evaporating dish, over a sand bath or water bath, in a stink cupboard, or in some place where the highly poisonous and corrosive fumes of the mixture can be carried away by a strong draught. Heat must then be applied to the sand bath until the mixture becomes warm, when the gold must be added in small quantities at a time until all the gold is dissolved or the warm acid ceases to take up any more. During this operation, dense brown fumes of a penetrating, pungent, and strongly corrosive character will be given off from the mixture. The heat must be continued below boiling point, until all excess acid and water has been driven off in the form of steam, and only a dark thick liquid remains at the bottom of the evaporating dish. The operator should now protect his hands with a pair of thick gloves, and then proceed to turn the dish about, tilting it from side to side until the dark liquid all crystallizes on the sides of the dish in the form of ruby red crystals. The whole contents of the dish should then be dissolved in hot distilled water and set aside to cool, when it must be filtered through blotting paper to remove any dirt contracted in the previous process. If any brown powder remains at the bottom of the dish, it is probably finely divided gold, and this must be dissolved in a little more of the acid mixture, and treated like the bulk of the sample. As gold is a very precious metal, great care must be exercised to avoid waste and all rinsings of the vessels, to-

gether with washings of the filter, must be made with distilled water, then added to the filtered solution. The terchloride of gold solution thus made, may be again evaporated over a water bath at a low temperature, and the dried salt stored away in wide-mouthed bottles; or the solution may be diluted with distilled water and treated direct with cyanide of potassium, to form gold cyanide, as directed in the next section.

Terchloride of gold is formed of three equivalents of chlorine ( $35.5 \times 3$ ) added to one equivalent (197) of gold, and has, therefore, the molecular weight 302.15. It is very soluble in water, and its solution stains the skin a dark purple tint.

§ 100. **Cyanide of Gold.** Cyanide of gold is formed as a yellow precipitate when a solution of cyanide of potassium is added to a solution of terchloride of gold in distilled water. The precipitate forms slowly and falls tardily. In making cyanide of gold, the terchloride solution should be largely diluted with distilled water, so as to contain not more than 1 ounce of gold in  $\frac{1}{4}$  gallon of water, and the solution of cyanide should also be very dilute to produce good results. If the terchloride solution is too dense, or contains any free acid, or the cyanide solution is too strong, a large proportion of the gold will enter into combination with the cyanide of potassium to form a double soluble salt of gold and potassium, and thus be taken up by the supernatant liquid. Even when the greatest care is exercised in making this salt, some gold is found in the supernatant liquid and in the wash waters. These should be carefully

preserved and treated for the recovery of gold as directed in another section (§ 141). The details of the process for making cyanide of gold, are precisely the same as those for making cyanide of silver, as described in § 83, but, owing to the difficulties experienced in determining the end of the process, and the loss of metal likely to be sustained by the operation, it should only be undertaken by experienced persons.

§ 101. **Double Cyanide of Gold and Potassium.** When an excess of cyanide of potassium solution is added to the yellow cyanide of gold precipitate, it dissolves and forms a solution containing the double cyanide of gold and potassium. If the gold cyanide has been properly prepared and washed, as directed for the silver cyanide in § 83, this solution is undoubtedly the best for electro-gilding.

The double cyanide of gold is composed of one equivalent of gold and one equivalent of potassium added to two equivalents of cyanogen. But the gilding solutions made by amateurs and inexperienced persons usually contain a large addition of chloride of potash, formed whilst attempting to throw down the gold cyanide. It is done in this way: The operator adds cyanide of potassium solution to the terchloride of gold solution, and watches for the promised yellow precipitate. As this comes very slowly, he adds more cyanide, and awaits results. As these are not very pronounced, he adds more cyanide, and thus goes on until at last the solution clears in a moment, and he looks in vain for the yellow precipitate, because he has dissolved it, forming

instead a clear solution. This solution is then employed as the gilding solution, and nothing is said about the failure to precipitate the gold as a gold cyanide. The solution thus formed, yields fairly good results, but the deposit is not so coherent as that obtained from a really good solution made up without the accidental introduction of the chloride of potash.

Owing to the difficulty experienced by operators in throwing down the cyanide of gold, many make-shifts have been resorted to, with a view to avoid having chloride of potash in solution. If an excess of liquid ammonia is added to a solution of terchloride of gold, a bulky brown precipitate is formed. This is an oxide of gold, having dangerously fulminating properties when dried, as it will then explode violently if heated or subjected to friction. This precipitate must therefore be well washed, and dissolved whilst wet in a solution of potassium cyanide to form the gilding bath. It must then be boiled for several minutes to expel the ammonia still held in the solution. This is a fairly good solution, yielding a rich gold deposit when first made up, but liable to deposit a darker gold as it gets old. As it was made from oxide of gold dissolved in cyanide of potassium, it contains an oxide of potash in addition to the double salt of gold and potassium. The same may be said of all solutions made from oxide of gold, which may be prepared in another way by adding calcined magnesia to the terchloride of gold solution as long as a brown precipitate falls. This must be removed from the mother solution by filtration, and then digested (*i.e.* soaked) in



dilute nitric acid to remove excess magnesia. The gold oxide must then be well washed to remove the last trace of acid, and dissolved in a solution of cyanide of potassium to form the gilding bath in the usual manner.

Mr. Watt recommends a solution made by first throwing down all the gold as a precipitate from its terchloride solution by adding sulphide of ammonium. This precipitate is to be well washed, and dissolved whilst wet in a solution of cyanide of potassium to form the gilding bath. It must then be boiled for half an hour to expel excess ammonia, and the loss by evaporation made up with distilled water. With a moderate excess of free cyanide, this solution will yield a fine colour when worked at a temperature of 130° Fah., and will give good results for a considerable period.

§ 102. **Amateurs' Gilding Solution.** The best and cheapest solution for amateur electro-gilding, and also for operators in a small way of business, is the double cyanide of gold and potassium solution made up by the battery process. This contains some oxide of potash, but if made up of pure gold and pure 98 percent. cyanide of potassium, it will yield good results at once, and continue to give them for years if kept in proper working condition. This solution is made up in the following manner: Procure 5 dwts. pure gold ribbon, leaf, or wire (and divide it into two parts), 3 dwts. pure white 98 percent. cyanide of potassium, and 1 quart of distilled water. Dissolve the cyanide of potassium in the distilled water made hot in a good enamelled saucepan, and keep it at nearly scalding heat whilst making and working the gilding solution. Make

up a battery of two Bunsen cells or three Daniell cells in series. Hang one strip of gold from the wire leading to the negative element of the battery, and the other strip to the wire leading to the positive element of the battery. Get a small clean white porous battery cell, nearly fill it with cyanide of potassium solution, place it in the saucepan, and suspend in the porous cell the strip of gold connected to the zinc element of the battery. Immerse the other strip of gold in the outer cyanide solution, and pass current [from the battery] from one to the other for some two or three hours. During that time some of the gold will have dissolved off the anode strip and entered into combination with the cyanide of potassium solution to form the double cyanide of gold and potassium gilding bath, but this will not have penetrated into the porous cell, nor will the strip of gold therein have suffered any loss. If at the end of this time a piece of German silver, suspended from the cathode wire in the outer solution, receives a fair coat of gold in a few moments, the bath is ready for gilding work. The contents of the porous cell may be poured into the outer solution, both strips of gold used as the anode, and the work may proceed with current from one or more cells as may be required. At first there may be too much free cyanide, and the deposit may in consequence be too dark, but this fault will be soon corrected if the anode plates are wholly immersed whilst gilding. If the contrary condition exists, and the anode plates are dirty, or do not dissolve freely, add a very little more cyanide to the solution. This will be found to be the

cheapest solution, because there is no loss of material in making it up. If the whole of the gold strip dissolves in the cyanide solution, the bath will not be too rich in gold, as a very useful strength is 2 dwts. of gold in the quart of solution. A larger quantity may be made in the same manner in the same proportions.

§ 103. **Strength of Gilding Bath.** Gilding baths will yield good results with only 5 dwts. of gold in each gallon of solution, if worked under suitable conditions, or they will yield equally good deposits with 1 ounce or more of gold in each gallon of solution. A very good working strength is insured with from 10 to 15 dwts. of gold in the gallon. Solutions poor in gold are liable to great fluctuations in the colour of the deposit, which will assume a dark, hard appearance, resembling 15-carat gold, if the battery power is too high. A similar appearance will result from the presence of too much free cyanide. A great excess of free cyanide will cause the gold deposit to assume a foxy red tint, which cannot be altered by subsequent scratch-brushing and polishing. Solutions too rich in gold, deposit the metal too fast, and in a non-coherent condition, liable to strip under the burnisher. This condition is intensified if the solution contains an excess of free cyanide in addition to an excess of gold.

§ 104. **Assaying Gilding and Silvering Solutions.** The exact strength of a gilding or silvering solution may be ascertained in the following manner. Take one fluid ounce of the solution and evaporate it to dryness in a porcelain capsule, on a sand bath over a small gas stove. To the dried salt add an equal bulk of litharge, and mix

the whole well together. Calcine the mixture in a small crucible, and keep it at a glowing red heat until all the litharge has been decomposed and a small pool of molten lead appears at the bottom of the crucible. This lead will contain all the silver or gold in the sample to be assayed, and must be poured out on a clean iron slab to cool. The button of lead must now be placed on a bone-ash cupel (a small cup of boneash), and subjected to a strong heat in the presence of air, until all the lead has been oxidized and absorbed into the boneash of the cupel, and only a button of pure gold or pure silver remains. This must be allowed to cool on the cupel, from which it can be easily detached, then cleaned from adhering boneash and exactly weighed. The weight of the button thus obtained will be  $\frac{1}{160}$ th that of the silver or gold in a gallon of the solution; therefore if the weight is multiplied by 160 (the number of fluid ounces in a gallon), we shall get the exact weight of precious metal in a gallon. The work of calcination and cupellation is best done in a small gas furnace or muffle, such as those made and sold by Mr. Fletcher of Warrington.

§ 105. **Testing Solutions for Free Cyanide.** Free cyanide, is the cyanide of potassium contained in the solution over and above that needed to form a solution of the double salt. The presence of this free cyanide is absolutely necessary to the proper working condition of the double cyanide silvering and gilding solutions, since they require excess cyanide to dissolve the anodes and keep up the right working strength of the baths. The quantity of free cyanide needed for this purpose can only be

determined by experience in working the solutions, and varies with the class of work to be done. If, from indications in the character of the deposit, too much or too little free cyanide is suspected, the exact quantity can always be ascertained by the analytical process described in § 86 for determining the quality of cyanide of potassium. Take one fluid ounce of the silvering or plating solution, and dilute it with three fluid ounces of distilled water in a large glass beaker. Deliver into this from a burette a known weight of silver nitrate dissolved in distilled water, very gradually, in small quantities at a time, with frequent stirring and shaking, until the free cyanide ceases to dissolve any more of the silver nitrate, and a permanent white cloudiness is caused in the solution being tested. Ascertain the exact weight of silver nitrate used to effect this; then, as it takes 130 grains of cyanide of potassium to convert 170 grains of silver nitrate into the double cyanide of silver and potassium, the exact weight of free cyanide may be ascertained by the simple proportion sum of  $130 : 170 ::$  the weight of free cyanide to the weight of silver nitrate used to produce permanent cloudiness. The weight of free cyanide multiplied by 160 will give the weight per gallon of solution. This calculation may also be used to determine the value of a sample of cyanide.

§ 106. **Management of Gilding Baths.** The rules given in § 88 for the management of silver-plating solutions, are equally applicable to the management of gilding baths. Gold solutions are contained and worked in vessels of enamelled iron, as described in § 51. The

solutions are worked at a temperature of from 150° to 180° Fah. Gold can be deposited from a cyanide of gold solution whilst cold, and, in fact, at all temperatures above freezing point up to boiling point, but the colour and character of the deposit varies with each variation of temperature, being as a rule very pale when deposited cold, and of a higher tint when deposited hot. The right temperature to suit the work in hand must be ascertained by experience. No harm can be done to the solution by working it at a high temperature, other than loss in water and also cyanogen from the free cyanide, consequent upon evaporation. Great care must be exercised in keeping the solution at the same metal strength, and with the right quantity of free cyanide to suit the work being done. A deficiency of anode surface will lead to an impoverishment of the solution, which will soon show bad results in the character of the deposit. An excess of anode surface will tend to enrich the solution and cause the deposit to go on faster. A deficiency of cyanide has the same effect as a deficiency in anode surface, and is indicated partly by the colour of the deposit, and partly by the dirty appearance of the anode. An excess of cyanide will dissolve the anode too freely, and also cause the deposit to have a brown or even foxy red appearance. The very best cyanide of potassium (see § 85-86) must be employed in making up loss in free cyanide. Only pure distilled water must be used to make up loss by evaporation. Pure gold only must be employed for anode plates, and these should be suspended from the anode rod by stout platinum wires, as

these will not dissolve in the solution. The least trace of copper, silver, or other base metal, will largely affect the colour of the deposit, therefore they should be rigidly excluded from positions where they are likely to dissolve in and contaminate the solution. Silver will cause a pale, tending to green, deposit; and copper will be deposited with the gold in varying quantity, effecting various ranges of colour represented by the known alloys of gold used in making jewellery. The range of colour is very uncertain from alloyed gold baths, as the deposit varies with each variation in current and temperature. Therefore the plater should never intentionally alloy his gold solution if he intends using it again for good work, as he can never be sure of working all the alloy out again. Should the solution appear dirty at any time, it must be filtered whilst quite cold through a filter of previously washed calico.

§ 107. **Characteristics of Gold Deposits.** Some of these have been noticed in a previous section. When gold is deposited from a cold or cool solution, it has a paler tint and is less coherent than when deposited from a hot solution. A rise in temperature causes the deposit to go on faster and assume a brown tint, which disappears on scratch-brushing the article. Movement of the article being gilded, has a tendency to prevent this dark brown appearance, and cause a paler deposit. If a thick deposit is desired, the article should be taken from the bath every few minutes, scratch-brushed to remove the brown appearance, and returned to the bath for another coat. It must be understood beforehand that

the character of the deposit will be largely affected by the condition of the surface to be gilded. Coats of gold are usually so thin as to present all the characteristics of the surfaces on which they are deposited. All roughness, discoloured patches, and other irregularities in the polished surface, will be faithfully reproduced in the thin coat of gold, and cannot be afterward removed by polishing, because all attempts at removing the roughness of the surface by abrasion, will only rub off the thin deposit of gold. Therefore the very highest polish and best state of cleanliness must be given to the surfaces of articles intended to be gilded, before they are immersed in the gilding solution.

The characteristics of gold deposits are also affected by those of the current employed to deposit them. A high tension current, say from 5 to 10 volts, will deposit a dark coat of gold, which will get darker and more crystalline with each rise in tension above 5 volts, until only a loose dark brown powder is deposited. On the other hand, low tension currents, from 5 volts down to  $\frac{1}{2}$  a volt, deposit a paler and smoother and tougher coat of gold, which varies as the tension is varied.

§ 108. **Power required to deposit Gold.** Gold can be deposited from its double cyanide solutions by means of a very low tension current, rarely exceeding 3 volts. If a battery is employed as a generator of current, it will be found that gold can be deposited in good condition from one pair of elements in any battery, if thick connecting wires are employed. If thin slinging wires are used, and the articles hang at some distance from the anode,



we must employ more than one cell, and connect the cells in series to overcome the extra resistance. One or two Bunsens, or three Daniells, are usually sufficient for most purposes. Amateur gilders, and jewellers in a small way of business, will get enough power for their small jobs from two cells in series of Dr. Gassner's Patent Dry Battery. The large double carbon cells should be used by preference. These will furnish current at any time, and thus save trouble and expense of charging a battery to do a little gilding job, as the Gassner cells only need re-charging once in two or three years if only used for short runs of a few minutes each day. The large cells give a current volume of 3 ampères, and this is enough to deposit 20 grains of gold per minute, the rate of deposit being  $\cdot 0127806$  grains per ampère second.

§ 109. **Polishing and Finishing Electro-Gilt Articles.** After the articles have received the desired coat of gold, they should be rinsed in clean warm water and scratch-brushed whilst wet, then polished and finished as directed in §§ 94, 95, and 96. If it is necessary to burnish parts of the work, full directions for this process will be found in § 97.

§ 110. **Electro-Deposition of Platinum.** The peculiar character of platinum, as shown in its non-liability to corrosion in acid fumes, and in all the simple acids, points to its usefulness as a protective coating to articles of brass, copper, German silver, etc., used in chemists' laboratories. With reasonable care in conducting the process, platinum can be deposited in good condition from a solution of the

double cyanide of platinum and potassium in distilled water. The solution is to be made up as directed for making the double cyanide of gold and potassium, by precipitation from a dilute solution of chloride of platinum (made as directed for obtaining terchloride of gold), and dissolving the precipitate in a solution of cyanide of potassium. All the directions given previously for the process of electro-gilding will apply equally to the electro-deposition of platinum, except in the following, which are made to meet the peculiar character of the metal now under consideration. As platinum solutions are easily decomposed by the introduction of other metals, and thus always liable to deposit their metal by simple immersion, success is achieved in its electro-deposition by employing dilute solutions, and a current with a low E. M. F. If strong currents are employed, the deposit will be loose and spongy, presenting the appearance of black grains, instead of a reguline deposit.

The solution of double cyanide of platinum and potassium must therefore be very dilute, and care must be taken to add some chloride of platinum at frequent intervals to neutralize the free cyanide, and also to replenish the solution with metal, since platinum anodes are not soluble in solutions of potassium cyanide.

The following solution gives less trouble than that previously mentioned, but requires more battery power.

1. Take 5 fluid ounces of platinic chloride containing  $\frac{1}{4}$  oz. of platinum in 5 oz. of water, and stir it into 10 pints of distilled water. 2. Take 20 drams of crystallized phosphate of ammonia and dissolve it in distilled water, then

add the solution to the platinic chloride solution whilst stirring it with a glass rod. 3. Take 100 drams of crystallized phosphate of soda, dissolve in distilled water, and stir this into the mixed solution before prepared, to dissolve the precipitate caused by adding the phosphate of ammonia. 4. Boil the whole in an enamelled iron vessel until it ceases to give out the odour of ammonia and will slightly redden blue litmus paper, it is then ready for use. Work the solution at a temperature of from 190° to 200° Fah., using a large platinum anode, and a current having an E. M. F. of from 5 to 6 volts. As the anode does not dissolve in the solution, it is necessary to add some chloride of platinum occasionally to maintain the bath at its proper metal strength. This is best done at the close of an operation, adding just as much chloride as will contain enough platinum to represent that drawn from the bath, and stirring all well together. It is also advisable to add occasionally a small quantity of phosphate of soda to dissolve any platinum precipitate which may form at the bottom of the bath, and to prevent it from becoming too acid. This solution will deposit reguline platinum of the usual steel-grey appearance on copper and brass, and alloys of copper. If it is wished to coat with platinum such metals as iron, zinc, lead, tin, or alloys of these metals, they must first be electro-coppered or electro-brassed, since they decompose the platinum bath and deposit the metal on themselves by simple immersion.

## CHAPTER VIII.

### ELECTRO-PLATING WITH NICKEL.

§ III. **Electro-Nickeling.** The art of electro-depositing nickel from its solutions on metal surfaces in a reguline condition, as practised so largely at the present day, must be ranked among modern inventions. Very little was effected in a practical way with the electro-deposition of this metal until 1870, when Mr. Adams discovered that it could be deposited from a solution of the double sulphate of nickel and ammonia in a reguline condition. In the early days of its practice, operators sought to use nickel as a substitute for silver in plating drinking vessels and table ware, but they found it unsuitable as a coating to utensils employed in the preparation of foods and drinks, because of its ready solubility in fatty and vegetable acids, which soon permanently discolour the polished surface of nickel and form with it poisonous salts. Its use is now well established as a protective coating against rust and other forms of oxidization on the surfaces of iron, steel, brass, copper, and similar hard metals, when these are exposed to the oxidizing influence of the atmosphere. It is specially suitable as a protective coating to bright ornamental fittings made of steel and iron, and also to those

made of brass and German silver. In such uses as these electro-deposited nickel has no rival, since its hardness, combined with its peculiar metallic lustre (having a tint similar to polished steel or burnished silver, and yet distinct from both), renders it specially suitable as a bright coating to hard metals. Nickel may be deposited from its solutions in good condition by a persevering amateur, using a few gallons of a nickel solution and a large Bunsen battery, but success does not usually attend first attempts made in depositing the metal on such a small scale. The best work is done in large vats holding several hundred gallons of solution, and worked with current obtainable from a dynamo machine. In fact, nickel is not an easy metal to deposit in good condition, and is specially intractable in small volumes of solution.

§ 112. **Nickel Solutions.** Nickel has been deposited by various operators from the following solutions of its salts. The double sulphate of nickel and ammonium, prepared as directed in § 114; the double chloride of nickel and ammonium, prepared as directed in § 114; the double cyanide of nickel and potassium, prepared by adding cyanide of potassium to a neutral nickel solution whilst a precipitate falls, and following the process described in § 83 for making a cyanide of silver solution; Weston's solution of double sulphate of nickel and ammonium, with the addition of from 25 to 50 per cent of boric acid; Powell's solution of double sulphate of nickel and ammonium, with the addition of 2 drams of benzoic acid to each gallon of solution; Pott's acetate of nickel and calcium solution; and Desmar's double sulphate of nickel

and ammonium solution, with the addition of bicarbonate of soda.

§ 113. **Single Salts of Nickel.** These are not employed by themselves in making up depositing solutions, but are then associated with other salts. Nickel may be dissolved in dilute nitric acid with the assistance of heat, to form nitrate of nickel. It may also be dissolved in a mixture of three parts nitric acid and one part sulphuric acid, in which process sulphate of nickel is formed. The metal may also be dissolved in aqua regia to form chloride of nickel. These are all green salts, usually obtained in large crystals by evaporating the excess of acid and setting the solution aside to cool. On adding a strong solution of caustic soda to a solution of the nitrate or the sulphate of nickel, a black precipitate falls, which is the oxide of nickel. If carbonate of soda is used instead of caustic soda, a greenish precipitate is thrown down, which is carbonate of nickel. Either of those latter named salts may be dissolved in acetic acid to form the acetate of nickel.

§ 114. **The Double Salts of Nickel.** The most important double salt of nickel is that of the *double sulphate of nickel and ammonium*. To prepare this, first make up a mixture of 1 part sulphuric acid, 2 parts distilled water, and  $\frac{1}{3}$  part of nitric acid. Make this warm in a stone-ware vessel on a fireplace furnished with a good flue to carry off the nitrous fumes, and add pure cube nickel until the acid ceases to dissolve any more of the metal. Drive off excess acid, if any remains, by boiling the solution for a short time, dilute it with one fourth its bulk of

boiling water, and set aside to cool. When cool enough to filter, pass it through a calico filter into a vessel capable of holding double the bulk of liquid. Next dissolve some sulphate of ammonium in hot water until this will not take up any of the ammonium salt, and set it aside to cool. Add the cold ammonium sulphate solution to the cold nickel sulphate solution with free stirring, until the nickel solution loses all its colour and a copious precipitate of the double sulphate of nickel and ammonium has been thrown down to the bottom of the vessel. Pour off the supernatant liquid, and wash the crystals with a little more of the ammonium solution. The crystals may now be dissolved in hot water and filtered. The resulting solution may be employed as the nickel bath, or may be evaporated down and set aside to cool, when the double salt will crystallize out.

*The double chloride of nickel and ammonia* may be prepared by first dissolving pure cube nickel, or oxide of nickel, in pure hydrochloric acid, to which has been added a small quantity of pure nitric acid. This must be done in an acid-proof stoneware vessel, on a fireplace furnished with a good flue to carry off the fumes; and heat should be applied to assist the action. Add cube nickel, or nickel oxide, until the acid refuses to dissolve any more metal, and all fumes cease; then dilute the solution with enough cold water to contain 8 ounces of nickel in the gallon. To this solution add chloride of ammonium (sal-ammoniac) dissolved in rain or distilled water, in the proportion of 5 or 6 ounces to the gallon of water. Heat this mixture in an open vessel until a large

part of the liquid has been driven off in the form of steam, and crystals begin to form. Allow the liquid to cool, pour it off from the crystals, then heat the liquid again, and repeat the operation until all has been crystallized. These crystals are the double salt of chloride of nickel and ammonium, which may be dissolved in hot water, and filtered to form the depositing solution. The depositing solution should contain about 8 ounces of nickel to the gallon, and have a density of from 1.050 to 1.075.

§ 115. **Nickel Solutions for Electro-Deposition.** As will be seen on reference to § 112, there have been many different solutions made up for this purpose by various operators. Mr. Watt devotes one chapter in his book on Electro-Deposition to a full account of the various solutions. Of these, the only solution which finds general favour in this country is the double sulphate of nickel and ammonium. The double salt may be prepared as directed in § 114, or it can be obtained pure at prices ranging from 9d. to 1s. per lb., according to quantity ordered, from such respectable houses as those of Messrs. Canning and Co., and Messrs. Hartley and Son, Birmingham. To insure success, it is necessary to have the nickel anodes *pure*, and this can only be relied upon by purchasing the goods from some well-known respectable firm supplying electro-platers' materials.

In making up a bath of the double sulphate of nickel and ammonia, from 12 ounces to 1 lb. of the dry double salts should be used to each gallon of solution. Dissolve the crystals in boiling water in a wooden tub with



frequent stirring, add cold water to make up the right quantity, allow the solution to cool, then filter it all through a calico filter. In filtering large volumes of solution into large vats, it will be found convenient to nail the calico to a frame of wood made like a picture frame, and long enough to stretch across the vat. The filtered solution should have a density of about 1.520 (at a temperature of 60° Fah.) as shown on the specific gravity hydrometer. If the density is less than this, add more dissolved and filtered double salt of nickel and ammonia. If heavier, add rain water. Distilled water is best for all solutions, because it is free from earthy salts, which only clog depositing solutions, but it is costly, and therefore the best substitute is rain water. The solution should be made slightly acid by the addition of a little sulphuric acid, if to be used in plating iron and steel.

§ 116. **Working Nickel Solutions.** Nickel solutions work best in large volumes of from 100 gallons upward, and these are contained in large lead-lined tanks constructed to suit the work to be done in them. For instance, if long pieces of iron and steel, such as the shafting of machines or harness chains, have to be nicked, the nickel solution may be contained in a long, narrow, and shallow trough. If sheets of iron or such articles as stove-fronts form the bulk of the business, a thin and deep vat will be preferable. In such a vat as this, too, we may nickel a large number of small articles strung together on wires, such as screws, which can be wired by taking a turn of a long wire around each screw head, and thus making a long string of them; or bicycle spokes,

which can be wired in a similar manner to form staves of a ladder, with the slinging wires as supports. If the trade is principally in urns, mullers, and similar large vessels, we must have a large and deep vat, so as to allow a good volume of solution above and below, as well as at the sides, of the article being nickeled. As nickel solutions are not good conductors of the current, it is necessary to have a large anode surface, and to bring the anodes close to the article being nickeled. When large round articles are in the bath, it is advisable to surround them with anodes, to get an equable deposit on all sides. In general practice it is usual to have the anode rods running along on both sides of the vat, and to hang the anode plates on them so thickly as to line the sides of the vat with nickel plates. The work is suspended from a stout rod running along the centre of the vat between the anode rods. When the articles have been thoroughly cleaned and prepared as directed in Chapter V., they should be placed at once in the nickel solution, which should be previously connected to a strong current of electricity, and thus expose the articles without delay to the full influence of the current. The surface of the articles thus become "struck" with a film of nickel, and, this being done, the rest of the deposit may proceed more slowly, to obtain a tough, coherent coat of nickel. A successful result largely depends upon the regulation of the current. If this is too intense, the nickel will be thrown on in small hard grains, which will not present any surface capable of being polished; or the deposit will be ragged, that is, specked with tiny blisters, which will

cause the metal to strip, and leave a ragged appearance on the coat. Both of these defects are due to excessive evolution of hydrogen at the cathode. The best results are obtained when hydrogen is liberated freely at the cathode in a gently flowing stream. When small steel articles are placed in the nickeling solution by themselves, this tendency to blister and cast off the coat of nickel is sometimes very troublesome. This fault may be remedied by placing each steel article between two of brass or some other metal, and thus divert part of the current on each side by easier paths.

TABLE<sup>1</sup> SHOWING RATE OF NICKEL DEPOSITION.

Ampères of current.	Sq. ft. of surface.	Grains per hour.	Grains per 10 hours.			
			lbs.	oz.	drms.	
1.	'1	16'756	167'56 = nearly	0	0	6
2.	'2	33'512	335'12 = "	0	0	12
3.	'3	50'268	502'68 = "	0	1	2
4.	'4	67'024	670'24 = "	0	1	8
5.	'5	83'780	837'80 = "	0	1	14
6.	'6	100'536	1005'36 = "	0	2	4
7.	'7	117'292	1172'92 = "	0	2	10
8.	'8	134'048	1340'48 = "	0	3	1
9.	'9	150'804	1508'04 = "	0	3	7
10.	1	167'560	1675'60 = "	0	3	12
20.	2	335'120	3351'20 = "	0	7	10
30.	3	502'680	5026'80 = "	0	11	7
40.	4	670'240	6702'40 = "	0	15	5
50.	5	837'800	8378'00 = "	1	3	2
60.	6	1005'360	10053'60 = "	1	6	15
70.	7	1172'920	11729'20 = "	1	10	13
80.	8	1340'480	13404'80 = "	1	14	10
90.	9	1508'040	15080'40 = "	2	2	7
100.	10	1675'600	16756'00 = "	2	6	4

<sup>1</sup> The decimal parts of a square foot in the second column of the above table, may be taken as square inches in estimating the surface to be covered.

§ 117. **Rate and Thickness of Nickel Deposits.** Nickel is deposited in good condition from its solutions at the rate of  $\cdot 004641$  gr. per ampère second, or at the rate of  $16\cdot 756$  grs. per ampère hour on  $\cdot 1$  square foot of surface. This is shown in the preceding table. See also p. 212 in appendix.

The thickness of a nickel deposit may be nearly ascertained by noting the strength of current employed, and the exact surface of metal coated with nickel in a given time; then, knowing that 1 square foot of nickel  $\frac{1}{1000}$ th of an inch in thickness weighs  $319\cdot 752$  grains, the thickness of the whole deposit, together with its weight, may be found by calculation. Following the same rule, we may find how long it will take to coat a known area of surface with a determined thickness of nickel whilst employing a known strength of current. Supposing, for instance, we wish to coat 1 square foot of iron with nickel to the thickness of  $\frac{1}{1000}$ th of an inch. We know that this will take  $319\cdot 752$  grains of nickel, and we can deposit nickel at the rate of  $167\cdot 560$  grains per hour on 1 square foot of surface when we employ a current of 10 ampères; in two hours we shall deposit  $335\cdot 120$  grains of nickel, which will be a little in excess of what we require if all the conditions have been observed.

§ 118. **Power required to Deposit Nickel.** To break up the nickel salt in solution, and deposit the metal in good condition on an article when first placed in the bath, we shall require an electro-motive force of from 5 to 6 volts, or that furnished by from 3 to 4 Bunsen cells in series. If a plating dynamo does not give the necessary E. M. F. to deposit nickel in good condition, it may be made to do

so by driving the machine at a higher rate of speed. As a rule, there should be a flow of hydrogen gas observable from the article being nickeled, but this may be excessive, as noted in § 116. Therefore the E. M. F. and strength of the current must be regulated until the best results have been obtained by experience. When the articles have been "struck" with a deposit of nickel, that is, merely covered with a thin film of this metal, the intensity of the current may be reduced, and deposition allowed to go on more slowly, to insure a tough deposit. The intensity of one cell may then be found sufficient for the purpose.

§ 119. **Finishing Nickel Deposits.** Nickel deposits differ from those of silver in appearance and hardness, and must receive different treatment. Deposition must go on from the start to the finish without interruption. We may not remove the article to see how the deposit will stand brushing, as in the case of silver; if this is done the next layer will be likely to strip from the first. The deposit of nickel may not be white or brilliant, but of a dull yellowish appearance when it leaves the vat. It must then be well rinsed in hot water and dried, then passed over to the finisher, who changes the dull yellow surface to the brilliant polish desired, by brushing the deposit with mops and dollies charged with Sheffield lime. This is best done on the polishing lathe, with circular mops and dollies made of felt, fustain, calico, and swansdown, the final finishing polish being imparted with a very soft clean mop. The articles should then be brushed with a soft brush to remove all traces

of lime left in crevices on the article, and wiped with chamois leather.<sup>1</sup> Nickel deposits must not be scratch-brushed with brass scratch brushes, because the brass will wear off the brushes, and become embedded in the harder nickel deposit, causing it to have a brassy appearance. If there should be any faulty spot from which the coat strips whilst being finished, it may be "doctored" (as proposed by Mr. A. Watt) by applying a small strip of nickel anode bound up in a rag pad dipped in the nickel solution, and connected by a wire with the battery or dynamo. Rest this pad on the well-cleaned bare spot, connect a wire from the negative pole of the battery to the article, and pass a current from the pad to the article until the bare spot has been coated with nickel. Experienced platers and finishers can so work this between them as to successfully patch up a spot and render it indistinguishable from the rest of the article, thus avoiding the necessity of having the work re-nickeled. This will do for small faults discovered in finishing, but when the coat strips off in large patches, or in several such patches, the whole coat should be stripped as directed in § 71, and the whole work of preparation gone over again as at the first.

§ 120. **Care of Nickel Baths.** Nickel baths should be as carefully guarded against contamination with dirt and impurities as those of silver. The anodes should be always left in the bath, but the connecting wires and the sides of the vat should be frequently cleansed from the nickel

<sup>1</sup> Nickel is best polished on a calico mop charged with Tripoli compo., then finished or "cleared off" with a clean mop and Sheffield lime.

salts which creep out of the solution and crystallize upon them. When the solution gets contaminated with dirt, and this interferes with the cleanly working of the bath, it should be filtered through a calico filter. If the metal is withdrawn from the bath faster than its equivalent is dissolved from the anodes (which will not infrequently happen) the solution will become acid, and this acidity must be neutralized by adding liquid ammonia to the solution in small quantities at a time, with stirring, until it ceases to redden blue litmus paper. When the solution becomes too dirty to be used, or is otherwise spoiled, all the nickel may be recovered as a double salt of nickel by adding to it a saturated solution of ammonium sulphate until the double salt falls, and the solution loses its green colour. The crystals thus obtained may be dissolved in hot water, the solution filtered, and purified by crystallization to form a new bath.

If an old nickel solution fails to give a satisfactory deposit of metal, it may be improved by adding some common salt (sodium chloride) to the extent of from 1 to 10 per cent. of the nickel salt in solution. The addition of common salt increases the conductivity of the solution, and gives a whiter deposit of nickel than that obtained from an impure solution of double sulphate of nickel and ammonia.

If a nickel solution becomes too alkaline,—as shown by a yellow deposit, and its power to turn red litmus paper to blue,—add sulphuric acid (with stirring) until it shows a slightly acid reaction.

§ 120a. **Nickel-Plating Cycle Fittings.** New cycle

fittings, fresh from the maker, have rough surfaces, more or less scored with file marks and scratches, and blotched with fire and brazing stains. These must all be taken out by grinding the surfaces on emery-coated bobs until a perfectly smooth polish has been obtained, before the fittings are handed to the plater. On the perfection of this preparatory finish will depend the brilliance of polish obtained on the finished nickel-plated fittings. As this grinding process must tend to weaken tubes and other light parts, the interests of maker and plater will be both best served by clean and good workmanship in making the fittings. The bobs employed in preparing fittings for the plater are made of solid felt, and also of wooden discs, from 1 to  $1\frac{1}{2}$  inches thick, and from 6 to 12 inches in diameter, turned true, covered with bull-neck or buff leather, and coated with a mixture of glue and emery (see Fig. 31, p. 77). The leather coat is first glued and nailed on the wooden rim. At the end of twelve hours the nails are drawn and replaced by wooden pegs, and the bob trued on a lathe. The rim is then run around in a pot of hot glue (or hot glue brushed over the leather); then on a sheet of paper covered with a layer of grain emery (No. 90 or 120 as required), until the leather has acquired a good coat of emery. The bob is then laid aside for twelve hours to dry and get firm. Felt bobs do not require a leather coat to receive the glue and emery coating. The bobs, thus prepared, are mounted on such powerful lathes as those shown by Figs. 37, 38, pp. 81, 82, and run at a speed of 2,500 revolutions per minute. The spindle is made to revolve to-



wards the workman, who holds the work under the bob; first starting with No. 90 emery to get out the roughest file marks, then using another bob, with No. 120 emery, to remove smaller defects, and finally finishing with fine flour emery and oil on a bristle brush, shaped as shown by Fig. 32, p. 78. When the handle-bar or other part gets too hot to be held, it is set aside, and other fittings proceeded with, thus keeping one part going whilst another is cooling.

Tinned iron, copper, and brass work, should be polished with calico mops, charged with Tripoli compo, and finished with Sheffield lime on clean calico mops. Brass or copper castings, may be first ground with emery, then sanded with Trent sand and oil on a bob, then finished on calico mops with Tripoli and Sheffield lime, as above directed.

When thus prepared, the fittings are handed to the plater, whose first aim is to remove the film of oil or grease left on their surface by the polisher. They should be first wired: that is, a length of No. 22 soft copper wire, twisted around one end of each handle-bar, seat pillar, crank, or other large fitting, or around several smaller ones, such as nuts, collars and bolts. Spokes, and articles of small diameter, are best wired with No. 26 copper wire. Each length of wire must be long enough to have the free end twisted around the cathode rod, whilst the article is sunk a few inches below the surface of the plating solution; and each article must be free from contact with others. The wired articles are then to be moved about for five minutes or more in a

boiling solution of American potash, containing  $\frac{1}{2}$  lb. of potash in each gallon of water, contained in a plain wrought iron tank ; then swilled in clean hot water, and transferred to the scouring tank (Fig. 28, p. 75). When scoured, as directed on p. 75, and on pp. 96-97, each article must be taken by its slinging wire (not touched with the bare hand), swilled in clean water and transferred to the nickel-plating vat at once, or to the copper-plating vat, if they are to be coppered first.

It is not necessary to coat cycle fittings with copper previous to coating them with nickel ; but it is strongly advisable to do so, for several good reasons. A coat of copper will adhere firmly to iron and steel and other metals if these are properly prepared, and will show defects in the preparation, readily, by not coating the defective parts. These defects can be at once remedied without loss of time and nickel. Nickel will also firmly adhere to copper, and the two together form a better protecting coat than that of nickel alone. Some platers not only deposit a good coat of copper on high class work ; but also polish this, and re-copper the surface before depositing nickel on the fittings. Which-ever method is adopted, it must be borne in mind that success not only depends on a good coat of copper, but also on absolute cleanliness in the preparation, for only a touch with the bare hand on the prepared article will cause the nickel to strip from the spot whilst being polished. In a good coppering solution, as given (pp. 179, 180), a sufficiently durable coat of copper should be obtained in from fifteen to twenty minutes.

See that the nickel solution is ready for the fittings, and connected to the source of electric current before the articles are immersed in the vat. If this is not done, the prepared surface may take on a slight film of oxide which will prevent perfect adherence of the metals. For the same reason, the utmost celerity must be employed in rinsing the articles after being scoured and coppered, and in transferring them to the nickel vat. Copper and brass articles must be prepared as directed on pp. 96, 97.

Have just enough resistance in the circuit (by means of the resistance board, Figs. 41 or 42, pp. 89 and 90) to put a white coat of nickel quickly on the first article, then reduce the resistance as the vat gets filled. Employ the converse method whilst removing articles from the vat, and thus prevent "burning," that is, depositing the nickel in a pulverent condition. It is also advisable to shake each fitting when first immersed, to loosen any air bubble which may form, and thus prevent pinholes in the deposit. Some motion should be given to the anodes, now and then, to clear them from any resisting scum that may form on their surfaces. The solution should also be well stirred with a stick on Saturday after leaving work, then covered with calico to keep out dust, as this may cause pin holes in the deposit.

A sufficiently thick deposit of nickel should be obtained in the course of from  $\frac{3}{4}$  to 1 hour. Each article should be then removed, rinsed in clean cold water, then in hot water, then rubbed in hot boxwood sawdust until dry, then passed to the finisher.

Nickel-plated articles are finished in the polishing shop

by the polisher on the same lathes as those employed in preparing the work ; but with mops made of calico discs charged with Tripoli compo. The nickel coat should be on firm enough to stand a good pressure on these mops ; such being necessary to bring up the required colour and lustre ; but care must be taken to keep the surface in motion and well alive under the mop to prevent this from cutting through the coat of nickel. Special care will be needed when nearing sharp edges, because these are subject to more friction, and are also more lightly coated than other parts. The finished articles are cleared off, and a brilliant polish imparted to their surfaces by dry Sheffield lime applied on a clean calico mop. Nuts and collars are best polished whilst held on a tapering mandrel, and small bolts, pins, etc., whilst held in a pair of gas pliers.

Much of the work of a cycle plater consists of old fittings sent to be re-plated. All the old nickel must be stripped from these, to get surfaces capable of adhering firmly to the new coat. This is best done on the polishing lathe, as in preparing new fittings. First wipe off all excess of dirt, grease, oil, etc., with rag or cotton waste, then hand the fittings to the polisher. Rusty fittings must receive similar treatment. Old nickel may be removed from copper and brass fittings by stripping in acid as directed on p. 103. They must then be rinsed, dried, and handed to the polisher to be prepared. Old tinned fittings are scarcely worth the labour and expense of being re-nickelled, as they rarely look well after being stripped of their coat of nickel and tin.

The cost of nickel plating outfits range from £36 up to £97, the latter including a coppering outfit. Coppering outfits cost from £11 up to £17. Brass-plating outfits, from £40 to £45. Polishing and finishing outfits cost from £4 up to £14, according to size of lathe, and quantity of material. Estimates for all plating and polishing outfits may be obtained from Messrs. Hartley and Messrs. Canning of Birmingham.

§ 120*b*. **Nickel-Plating Small Articles.** A machine to lessen the labour of polishing small articles has been invented and patented by Messrs. Canning and Co., Birmingham. It consists of a wooden frame, inclosing an ebonite box, in which the small articles and anodes are placed, and the whole immersed in the plating solution. The whole apparatus is then given a rocking motion by means of an eccentric and belt, and thus the small articles are polished whilst being plated. A good coating can be deposited and polished in the course of from  $\frac{3}{4}$  to 1 hour. Messrs. Hartley and Son, Birmingham, are also the makers of a patented Automatic Plating Apparatus, for nickel-plating and polishing, in one operation, small steel and brass articles. This consists of a drum immersed in the plating solution, and caused to revolve in the same, whilst the articles are being plated and polished at the same time by friction against each other, and the sides of the drum. The makers estimate that each drum can plate and polish sixty gross of buckles, or similar small articles in a day, at a cost of 2*d*. per gross. These combined plating and polishing machines can be used in brassing, coppering, and tinning, as well as in nickelling solutions.

## CHAPTER IX.

### ELECTRO-PLATING WITH COPPER.

§ 121. **Electro-Deposition of Copper.** Copper is deposited from an acid solution of copper sulphate, in the various processes of electrotyping and copying artistic objects in this metal. The deposits thus obtained are removable from the moulds on which they are deposited, and afterwards have a separate existence of their own. The process of obtaining them, therefore, cannot be deemed a branch of electro-plating proper, but forms a separate art or trade, demanding a separate volume to deal with all its details. As in this treatise we are dealing only with electro-plating, or coating metals with plates or coats of other metals, we must confine ourselves strictly to this part of the subject. Copper is employed chiefly as a coating on such metals as iron, steel, zinc, tin, lead, pewter, and Britannia metal, when preparing these to receive a deposit of silver, because silver will not adhere perfectly to iron, steel, zinc, tin, or lead, when deposited upon these metals direct, but will adhere perfectly to copper when deposited on these metals, and copper can be made to adhere firmly to each and all of them. A coat of copper is also preferred by some platers on such

alloys of tin and lead as pewter and Britannia metal before these are plated with silver, because a firm and adherent deposit of silver can only be obtained on these alloys by special precautions taken in their preparation. It is also deposited on articles made of iron and of zinc, and the coating is subsequently subjected to the action of acids, to produce bronzing effects on the copper coating. It is likewise employed as a preparatory coating to a deposit of gold and of nickel on the above-named metals, although this is not always necessary, since gold and nickel can be firmly deposited on iron, steel, zinc, etc., without the intervention of copper.

§ 122. **Alkaline Solutions of Copper.** As all acid solutions of copper (even the saturated solution of copper sulphate) deposit their metal on iron, steel, zinc, lead, and its alloys, by simple immersion or chemical displacement, they are unsuitable as depositing solutions for electroplating with copper, since such deposits are never firmly adherent to the metal on which they are deposited. We have therefore to employ an alkaline solution which will not deposit its metal by simple immersion on those we wish to cover. Several various solutions have been employed by inventors and experimenters, among which may be mentioned Roseleur's solution of cyanide of copper and bisulphite of sodium, Dr. Elsner's solution of bitartrate of potash and carbonate of copper, Walenn's solution of cyanide of copper and tartrate of ammonia, Gulenson's solution of phosphate of copper and ammonia, and Weil's solution of sulphate of copper, tartrate of potash, and caustic soda.

§ 123. **Cyanide of Copper Solution.** The solution in general use for coppering iron and zinc, is that of the double cyanide of copper and potassium. This may be readily prepared by the battery process, as directed for preparing gold solutions, using an anode of pure copper in a hot solution of cyanide of potassium. Or it may be prepared by throwing down the copper from any of its acid solutions as cyanide of copper, and then dissolving this in a solution of potassium cyanide, by the process given for making up the solution of double cyanide of silver and potassium. This solution possesses the disadvantage of having to be used at a temperature of from  $160^{\circ}$  to  $180^{\circ}$  Fah., and it does not freely dissolve the anode unless a large excess of free cyanide is present in the solution, and this excess is detrimental to the deposit of copper, since it has a tendency to dissolve the newly deposited coat and make it loose or spongy.

§ 124. **The Best Alkaline Copper Solution.** The best alkaline copper solution is that introduced by Mr. A. Watt, and subsequently modified by Mr. J. T. Sprague. Dissolve eight ounces of copper sulphate in one quart of hot rain water, and set aside to cool. When cool, add liquid ammonia, whilst stirring with a stick or glass rod. At first a green precipitate will fall, and then this will dissolve on adding more ammonia, until the whole solution assumes a lovely blue tint. Dilute this with an equal bulk of cold rain water, and add to it enough solution of potassium cyanide, whilst stirring, to destroy the fine blue colour of the ammonia sulphate and give the colour of old ale to the solution. Set this aside for



a few hours, then pass it through a calico filter, and make it up to a gallon of solution with rain water. This solution may be worked cold, but the rate of deposition is increased and the deposited copper of improved quality when the solution is heated to a temperature of from 110° to 130° Fah.

§ 125. **Working Alkaline Copper Solutions.** As the bonds of affinity between copper and cyanide are stronger than those between copper and acid, it takes a higher E. M. F. to break them and deposit the copper in good condition. Copper may be deposited from an acid solution with a force of less than 1 volt, but it takes a force of from 6 to 8 volts to deposit copper on iron from an alkaline solution. Gas must be freely given off from the article whilst deposition is proceeding, but the volume of gas must be reduced by reducing the E. M. F. of the current if the deposit shows a tendency to become dark and sandy. An anode of pure copper must be employed; the disused coppers from a Daniell cell will be found most suitable. If the anode coats itself with a green crust soon after deposition commences, add some liquid ammonia whilst stirring the solution, until the green crust dissolves and the anode works clean. If the anode becomes coated with a blue crust, add cyanide of potassium solution. By thus noting the condition of the anode, and adding ammonia or cyanide as required from time to time, the solution may be kept in working order. It is not usual to deposit thick coats of copper from alkaline copper solutions, but to just cover the article with copper and then transfer it at once to the plating or

electro-typing solution before the pure copper coat can become oxidized by the action of the air. When thick deposits of copper are required, the articles are transferred from the copper plating bath at once to an acid solution of copper sulphate, and deposition continued in this until the desired thickness of copper has been obtained.

§ 126. **Electro-Type Solutions of Copper.** If the electro-type is to be made by the single cell process, *i.e.*, by connecting the mould or article to rods or plates of zinc in a sulphuric acid solution contained in porous cells immersed in the electro-typing solution, this may be a saturated solution of copper sulphate, maintained in a saturated condition by means of copper sulphate crystals held in bags of muslin suspended in the solution. If the solution is to be worked with current from a battery or from a machine, it must contain some free acid to act as a solvent on the copper anode, and thus maintain the solution in proper working order. In this case the best electro-typing solution is made by dissolving sulphate of copper in hot water, diluting this with cold water so as to contain 1 lb. of copper sulphate in 1 gallon of water, and adding 1 pint of sulphuric acid to each gallon of solution. Copper may be deposited from this solution with an E. M. F. of less than one volt, and in good condition with one cell of a Daniell or Smee battery. It is usual to employ the same force as that employed to deposit gold and silver, and to have the conducting wires and straps large, so as to convey a large volume of current at a low tension. High tension currents deposit copper from acid solutions in a brittle, sandy condition,

whilst the deposit from a low tension current is usually tough.

§ 127. **Rate and Thickness of Copper Deposits.** Copper is deposited from its solutions in good condition at the rate of  $0.05045354$  grain per second with 1 ampère of current, or at the rate of  $18.163$  grains per ampère hour. With 1 ampère of current depositing copper on  $\frac{1}{16}$  of a square foot of surface we shall get  $181.63$  grains in 10 hours, while with 10 ampères of current we can deposit  $181.63$  grains of copper on 1 square foot of surface in 1 hour, and with 100 ampères we can deposit  $1816.3$  grains of copper per hour. The rate of deposit suitable for a known surface can thus be readily ascertained, together with the volume of current necessary to effect the desired deposit in a given time, bearing in mind always that to force copper rapidly on a small surface it will be necessary to increase the E. M. F. of the current, and this may deposit brittle metal. The thickness of a copper deposit may be ascertained by calculating each  $2.2468$  grains per square inch to measure  $\frac{1}{16000}$  of an inch in thickness.

For further information on Electrotyping, see the section on this subject in the Appendix.

## CHAPTER X.

### ELECTRO-PLATING WITH ALLOYS.

§ 128. **Electro-Deposition of Alloys.** Imitations of alloyed metals may be successfully made by electro-depositing two or more of the metals together which compose the alloy to be imitated. Thus, various proportions of copper and zinc may be deposited together to form varieties of brass and of bronze, or copper and tin may be deposited together to form bronze. Copper, zinc, and nickel may be deposited together to form German silver. Alloys composed of tin and silver, and also of platinum and silver, have been deposited together. Some interesting and pleasing effects may be produced by depositing gold and copper, gold and silver, gold, silver, and copper, and copper and silver together, from mixtures of the double cyanide solutions of these metals. Greater skill and care must, however, be exercised to successfully deposit an alloy than would be employed in depositing either of the metals composing the alloy. Special and rigid conditions must be imposed and adhered to respecting the regulation of current strength, strength and condition of the bath, and surface of anode employed. Any variation from these conditions will result in a variation

in the composition and appearance of the deposited alloy. The colour of alloys, made by melting two or more metals together, depends very largely on the proportionate parts of the composition, and, reasoning from analogy, we might suppose that we have only to mix solutions of metals in a similar proportionate manner to obtain a corresponding proportionate deposit from the mixed solutions. For instance, supposing we wish to deposit a brass composed of 50 per cent. copper and 50 per cent. zinc. If we mix together equal bulks of copper and of zinc solutions containing equal weights of the two metals, we should have a mixed deposit consisting of equal parts of the two metals copper and zinc. We find, however, in practice, that from such a solution we can obtain a great variety in shades of brass, depending merely on the temperature of the solution and the strength of the current. As the quantity of metal deposited from a solution depends greatly on its electric valency, and this varies with each metal, it becomes a matter of difficulty to always adjust the current to the composition of the solution so as to deposit each metal in the proportion desired to obtain a given effect of colour in the deposited alloy.

§ 129. **Electro-Deposition of Brass.** Brass has been deposited from a great variety of brassing solutions, as will be seen by reference to the annexed table. Among the first attempts to deposit brass, may be mentioned that of M. de Ruolz in 1841, who employed a mixed solution of the double cyanides of copper, zinc, and potassium. Cyanide of potassium forms an important ingredient in the

majority of brassing solutions, but ammonia in some form is also necessary to keep the solutions in working order.

TABLE OF BRASSING SOLUTIONS.

	1.	2.	3.	4.	5.	6.	7.	8.	9.	10.	11.	12.
Water . . . . .	1280	5000	3200	5000	5000	800	160	160	250	1000	160	16c
Copper Acetate . . .	5	...	...	...	...	160	...	...	...	...	...	...
" Carbonate . . .	...	...	...	...	...	...	...	...	...	...	2	...
" Chloride . . .	...	10	16	25	15	...	...	...	...	...	...	...
" Sulphate . . .	...	...	...	...	...	...	...	...	1	25	...	4
" Cyanide . . .	...	...	...	...	...	...	2	2	...	...	...	...
Zinc Acetate . . .	...	...	...	...	...	16	...	...	...	...	...	...
" Carbonate . . .	...	...	...	...	...	...	...	...	...	...	2	...
" Cyanide . . .	...	...	...	...	...	...	1	1	...	...	...	...
" Sulphate . . .	10	20	32	48	35	...	...	...	8	30	...	5
Potassium Acetate . . .	...	...	...	...	...	160	...	...	...	...	...	...
" Carbonate . . .	...	160	400	610	500	...	...	...	...	...	...	...
" Cyanide . . .	8	24	...	12	50	q. s.	15	16	18	q. s.	4	q. s.
" Caustic . . .	72	...	...	...	...	...	...	...	...	...	...	...
Ammonia Liquid . . .	50	q. s.	...	...	...	...	...	...	...	...	...	...
" Carbonate . . .	...	...	...	...	...	...	...	16	...	...	...	...
" Nitrate . . .	...	...	200	305	...	...	...	...	...	...	...	...
Soda Carbonate . . .	...	...	...	...	...	...	...	...	...	200	4	45
" Bisulphite . . .	...	...	...	...	...	...	...	...	...	50	4	73
Arsenious Acid . . .	...	...	...	...	...	...	...	...	...	...	1/20	...

The following general conditions are to be observed in making up the solutions according to the proportions given in the foregoing table. Fluid ounces of liquids are intended, and ounces avoirdupois for the solids. When potassium carbonate (carbonate of potash) is to be used, the copper and zinc salts are first dissolved in water, and then precipitated as carbonates from this solution by adding a portion of the potassium carbonate. Where the sign q. s. is given in the foregoing table, a sufficient quantity of the ammonia or cyanide must be added to produce the desired effect,

ammonia being generally employed to dissolve the precipitates, forming a deep blue liquid, and cyanide being used until the blue colour has all disappeared. Both are employed as solvents to the anodes, which will not freely dissolve unless one or both are present in the solution. Even when a brassing solution is made up without the use of cyanide and ammonia, it is necessary to add them afterwards to keep the solutions in working order, as the ammonia alone does not freely dissolve the copper of the anode, and cyanide alone does not dissolve the zinc oxide formed on the anode. The following details apply to each numbered solution in the foregoing table.

1. Dissolve all the salts separately in portions of the water; add the ammonia in equal parts to the solutions of the copper and zinc salts with stirring; mix the copper and zinc solutions together, then add the caustic potash solution, and lastly the cyanide solution; stir well at frequent intervals during the next twelve hours, then allow the solution to rest a short time before working it.
2. Dissolve all the salts separately; pour enough potash solution into the solutions of copper and zinc to precipitate all the metal; add ammonia until the precipitate has been dissolved; decolorize with the cyanide, then add remainder of potash and water.
3. Dissolve all separately; mix copper, zinc, and potash solutions, then add the nitrate of ammonia.
4. Proceed in a similar manner as for No. 3 solution.
5. Proceed in a similar manner as for No. 3 solution.
6. Dissolve all the salts; add the cyanide solution to the others with stirring.
8. Dissolve all the salts in distilled water, mix

together, and add two ounces of sal-ammoniac. 9. Dissolve all the salts separately, then mix together. 10. Dissolve the copper and zinc salts and mix the solutions; add a solution of 100 parts of the carbonate of soda and stir well together; when the precipitate has subsided, pour off the clear liquor, wash the precipitate, add the remainder of the carbonate of soda together with the bisulphite of soda previously dissolved in water, then add enough cyanide to dissolve the precipitate. 11. Dissolve the zinc and copper salts in water, then add the other ingredients; dissolve the arsenious acid in the hot cyanide solution before adding it to the other solutions. 12. Dissolve the copper and zinc salts in one gallon of water and precipitate them as carbonates with thirty ounces of carbonate of soda; drain off all the liquid, wash the precipitate, add the carbonate and bisulphite of soda, then stir in enough cyanide to make a clear solution.

§ 130. **Watt's Brassing Solution.** Mr. Watt recommends making up a brassing solution by the direct process, viz., dissolving good sheet brass in nitric acid and using this solution instead of copper and zinc salts in making up the brassing bath. To do this, dissolve strips of sheet brass in warm dilute nitric acid until the acid ceases to dissolve any more brass. Avoid the poisonous fumes, as in dissolving silver; add the brass solution to water in the proportion of one ounce of brass to half a gallon of water; to this add strong liquid ammonia until the solution assumes a clear deep blue colour; to this add a strong solution of potassium cyanide until the blue



colour entirely disappears and the solution assumes the tint of old ale, then filter, and make up with water so as to contain one ounce of brass in the gallon of solution. This solution will work well, cold or hot, but should be left at rest for some hours after being made, before it is used.

§ 131. **Management of Brassing Solutions.** Brassing solutions are not easily managed, but require constant attention to keep them in proper working order. The anodes may be of good sheet brass, or they may be of best rolled sheet zinc and sheets of electro-type copper in equal numbers. Unless the anodes work clean, that is, dissolve freely, the solution will become poor in metal and deposit an undesirable variety of brass. The zinc of the anodes is apt to be especially troublesome because the oxide of zinc formed upon them does not freely dissolve in the solution. To remedy this defect employ an excess of liquid ammonia in solution. If there is an excess of zinc in the solution add more free cyanide, and this will dissolve the copper part of the anodes. To get up a solution into working order after it has fallen into a bad condition, add carbonate of copper, or carbonate of zinc dissolved in liquid ammonia, as may be required. If the deposit lacks brightness, dissolve a few grains of white arsenic in a hot solution of cyanide of potassium, and add this to the bath with stirring. An excess of this will give the deposit a steely grey appearance. The deposit of brass will vary with the strength of the current. A current of high intensity tends to deposit an excess of zinc, whilst one of low intensity may

deposit an excess of copper. The deposit, however, will be greatly affected by the density or volume of current passing, and this may be controlled by the resistance of the conductors in circuit. Thus with large conductors and anodes close to the article being brassed we may get an excess of zinc, whilst with smaller conductors we may get good brass or an excess of copper. The density or the temperature of the solution will also affect the deposit, dense solutions at high temperatures being better conductors than dilute solutions at low temperatures. These remarks apply to all brassing solutions, which will generally yield results according to the skill and experience of the depositor.

§ 132. **Power required for Electro-Brassing.** Brassing solutions require an E. M. F. of from six to nine volts (according to their composition) to deposit a good coat of brass. The current volume must be regulated according to the kind of brass desired in the deposit.

§ 133. **Electro-Bronzing.** The appearance of bronze may be given to electro-deposited brass by brushing it with a paste made of jeweller's rouge and blacklead, made moist with chloride of platinum. The current can also be regulated to deposit an excess of copper, and thus produce a bronze effect. Or a bronzing bath may be made up according to any of the preceding directions for making up brassing baths, if we substitute chloride of tin for the salt of zinc.

§ 134. **Electro-Deposition of German Silver.** Mr. Watt has deposited German silver in good condition from a solution made up like his brassing solution (see § 130),

using German silver instead of brass, and employing an anode of the same quality of German silver as that dissolved in making up the depositing solution. A small excess of cyanide only must be allowed, and the bath should be worked with a strong current of electricity. The deposit looks well on bright steel surfaces.

## CHAPTER XI.

### ELECTRO-PLATING WITH ZINC, TIN, IRON, COBALT, ETC.

§ 135. **Electro-Deposition of Zinc.** Zinc has been electro-deposited from a solution of its sulphate by Mr. Gore whilst using a feeble current. It has also been deposited from its solutions of chloride, acetate, tartrate, ammonia sulphate, and ammonia chloride. By M. Hermann's process, a dilute solution of sulphate of zinc is mixed with a solution of an alkaline sulphate, such as that of ammonia, potassium, or sodium, and a strong current is employed. By Person and Lire's process, a solution is made up of one part oxide of zinc, dissolved in a solution of ten parts of alum in 100 parts of water. This is said to be easily decomposed with an E. M. F. of one volt, and to deposit its metal freely upon any other metal. But the electro-deposition of zinc has not received much attention from electro-metallurgists because of its own commercial value. Articles made of iron can be so much more cheaply and effectually coated with zinc by dipping them in a bath of the molten metal, as to entirely exclude all ideas of electro-depositing zinc for commercial purposes. As, however, the amateur plater or student may wish to try his hand at electro-zincing, I herewith give directions for

making a solution which Mr. Watt has proved to give excellent results.

§ 136. **Watt's Electro-Zincing Solution.** Dissolve 200 ounces of best cyanide of potassium in 20 gallons of water, and stir into this 80 ounces of strong liquid ammonia. Place several large clean porous cells in the solution, and fill these with the bath liquid. In each cell suspend a strip of copper, and connect each strip to the negative pole of a strong battery or a plating dynamo. From the other pole suspend a large anode of best milled zinc, and pass a current until 60 ounces of zinc have been dissolved from the anode. Next dissolve 80 ounces of carbonate of potash in part of the bath solution, stir this into the main bulk, and let it rest for 12 hours. Filter the bath before using, and work it with a current of from 4 to 5 volts, using anodes of best milled zinc. The articles for zincing should be cleaned and treated as for the deposition of silver, but not quicked in mercury.

§ 137. **Deposition of Tin.** The so-called tin vessels commonly in use for domestic and other purposes, are made of thin sheet iron coated with tin. The sheets of iron are dipped in a bath of molten tin, and thus acquire a thin film of this metal. The insides of copper and iron vessels employed for culinary purposes, are coated with tin by a similar process. Whenever it is deemed desirable to coat an article with tin, it may be cheaply and expeditiously done by this, the molten process. This being the case, very little attention has been given to the electro-deposition of tin, although this metal can be

easily deposited from a large variety of solutions in excellent condition. Small brass articles, such as pins, hooks and eyes, and small copper articles, such as hooks and buttons, may be easily coated with tin by simple immersion in a bath composed of a saturated solution of cream of tartar in which has been dissolved a small quantity of chloride of tin. The quantity of this salt is immaterial, as it is only employed to start the process, the remaining tin being supplied from anodes of sheet tin suspended in the bath. The liquid is kept at a boiling temperature, and the articles to be tinned are suspended in the bath between the tin anodes until sufficiently whitened, when they are rinsed in water and rattled about in hot bran until dry and bright. Iron articles may be similarly whitened in a boiling solution made by dissolving 3 drams of fused protochloride of tin and 6 ounces of ammonia alum in  $1\frac{1}{4}$  gallons of water. Bronze may be coated with tin in a hot solution of caustic soda in contact with anodes of pure tin.

§ 138. **Electro-Deposition of Tin.** Tin may be readily deposited by the single cell process from its solution in caustic soda or in caustic potash. Make up a strong solution of either of those caustic alkalies, and add to it a small quantity of perchloride of tin, also line the vat with plates of pure tin. Place some of the caustic alkali solution in porous cells with strips or bolts of zinc, and connect the articles to be tinned, to copper wires attached to the zinc, and immerse the whole in the tinning solution. Solutions for the electro-deposition of tin, with current from a separate battery, have been invented by

Messrs. Roseleur, Fearn, and Steel. M. Roseleur's solution may be made up of 11 lbs. pyrophosphate of soda or potash dissolved in 100 gallons of water, then add either 21 ounces of protochloride of tin crystals, or suspend in a copper sieve (half immersed in the solution) 18 ounces of fused chloride of tin, and agitate until all has been dissolved. Mr. Fearn's patent process for electro-tinning, embraces the use of four different solutions, in which he employs a home-made chloride of tin solution prepared by dissolving pure grain tin in hydrochloric acid (with the aid of heat) to saturation, and diluting the solution to contain 3 ounces of metallic tin in the gallon. Solution No. 1 is made in the following manner: Dissolve 30 lbs. of caustic potash in 20 gallons of water, 30 lbs. of cyanide of potassium in 20 gallons of water, and 30 lbs. of pyrophosphate of soda in 60 gallons of water. Into the caustic potash solution pour gently, whilst stirring all the time with a glass rod, 200 fluid ounces of the chloride of tin solution, then all the cyanide solution, and lastly all the soda solution. This solution is used for tinning zinc articles, and is worked at a temperature of 70° Fah., with a current having an E. M. F. of from 3 to 4 volts. Solution No. 2 is made up of 20 lbs. pyrophosphate of soda dissolved in 40 gallons of water into which is poured 100 fluid ounces of the chloride of tin solution, and, finally, there is added to this, 56 lbs. of sal-ammoniac dissolved in 60 gallons of water. This solution may be worked with a weaker current than that employed for No. 1 solution, but must be used at a temperature of from 100° to 110° Fah. No. 3 solution is

made up of 150 lbs. of sal-ammoniac dissolved in 100 gallons of water, into which is poured, with stirring, 200 fluid ounces of the chloride of tin solution. This solution may be worked at a temperature of 70° Fah., and has the merit of dissolving the anode more freely than the others. No. 4 solution is made up of 400 ounces of tartrate of potash dissolved in 50 gallons of water, to which is added, with brisk stirring, 600 fluid ounces of the chloride of tin solution, then add 1,200 ounces of solid caustic potash dissolved in 50 gallons of water, and stir all well together until the precipitate which forms has all been dissolved. This solution may be worked cold, and will yield a thick deposit of metal without requiring alternate scratch-brushing and re-immersion. Cast iron must be coppered before it can be tinned in these solutions, and their strength must be maintained by adding occasionally some oxide of tin. As tinning solutions do not dissolve the anodes of tin in proportion to the metallic tin drawn from the bath, it is necessary to keep up the proper metal strength of the bath by adding to it from time to time small quantities of some tin salt, or some fresh tin solution. To obviate the fluctuation in strength consequent upon such occasional additions of tin, Mr. A Watt recommends in his works on "Electro-Deposition" and "Electro-Metallurgy" that a stoneware vessel filled with a concentrated tin solution be kept on a shelf near the bath, and a length of rubber tubing be led from the tap to the bath, to supply a continuous trickle of tin solution into the bath. When the stoneware vessel is exhausted, fill it up with some of the



bath solution in which a quantity of tin salt has been dissolved. All articles to be tinned must first be thoroughly cleansed by the processes previously mentioned (see Chapter V.), and it will be advisable to give a coat of copper (see § 124) to iron articles before tinning them.

§ 139. **Electro-Plating with Iron.** Iron may be electro-deposited from suitable solutions, in a condition resembling hard steel, and in this state has been found useful for facing printers' type, engraved copper plates, and electro-types of copper. The process has been named *acierage*, or steel-facing. Various solutions have been tried for the purpose. Klein's solution is made as follows: Dissolve a quantity of iron sulphate in water, and add a solution of ammonia carbonate until all the iron has been thrown down. Wash the precipitate several times, and dissolve it in sulphuric acid, taking care to only add as much acid as will dissolve the precipitate. Use this solution in a concentrated state, with iron anodes having a combined surface some seven or eight times larger than the copper surface to be coated. The bath must not be allowed to get acid, so must be kept well supplied with iron, and it is advisable to add carbonate of ammonia occasionally. The copper plate to be steel-faced, must be well cleaned with benzine, then with caustic potash, and well rinsed in water. It should be placed at once in the iron solution, and well scrubbed every five minutes, until a sufficient thickness of iron has been secured. When the face is deemed thick enough, wash it thoroughly in warm water, dry it quickly whilst rubbing

with a soft brush, then coat it with a thin film of wax to preserve it from rust.

Some good results have been obtained from a solution of the double salt of ammonio-sulphate of iron. Mr. Walenn has obtained good results from a solution of sulphate of iron and sulphate of ammonia, one part of iron sulphate to five parts of water. Meidenger found that a solution of iron sulphate gave good results when sal-ammoniac was added to the bath. It is advisable to cover the surface of the bath with glycerine whilst at work, and to keep it under cover when not in use, to prevent decomposition by action of the air.

§ 140. **Electro-Plating with other Metals.** All metals have received the attention of electro-metallurgists, and have been electro-deposited from suitable solutions, but as the deposits have little or no commercial value, we omit the details of the processes. *Cobalt* may be electro-deposited from an alkaline solution of the double sulphate of cobalt and ammonia. *Palladium* may be deposited from the double cyanide of palladium and potassium, or from the double chloride of palladium and potassium. *Bismuth* may be deposited from a slightly acid solution of the double chloride of bismuth and ammonia. A good reguline deposit of *antimony* may be obtained from a solution of the double chloride of antimony and ammonia. *Lead* may be deposited from its acetate solution or from a solution of oxide of lead, in caustic soda or potash, in the form of beautiful metallo-chromes, on polished surfaces of steel or nickel. *Aluminium* may be deposited on copper from a dilute

solution of the double chloride of aluminium and ammonia. *Cadmium* has been electro-deposited from a solution of the double cyanide of cadmium and potassium. *Magnesium* has been deposited from a solution of the double chloride of magnesium and ammonia.

For more detailed information respecting the electro-deposition of these and other metals, the student is directed to an excellent book on the "Electro-Deposition of Gold, Silver, Copper, Nickel," etc., etc., by Alexander Watt, published by Crosby, Lockwood, and Co., London, price 12s. 6d.

§ 141. **Recovery of Gold and Silver from Waste.** Several methods have been proposed for the recovery of gold and silver from exhausted baths, dipping and stripping acids, wash-waters, etc., etc. Silver may be recovered from stripping acids by diluting the acid largely with water, and adding either common salt or spirits of salts, which throws down the silver as silver chloride. When all the white precipitate has settled down, pour away the acid and dry the white powder remaining. The silver may be extracted from this by heating the silver chloride to a white heat in a crucible, together with an equal bulk of carbonate of soda, but it will not repay the plater the cost of labour and material. The only effectual, and the cheapest method of recovering gold and silver, is to drive off all excess liquid by heat, mix the resulting pasty mass with the sweep and soiled sawdust of the workshop, and sell the waste to a refiner or dealer in jewellers' sweep. Alkaline liquids may be evaporated in iron vessels, but all acids must be evaporated in acid-proof vessels of porcelain or stoneware.

§ 142. **Health in the Workshop.** To preserve the health of the workers in the workshop, should be one of the chief considerations of the master electro-plater, since more and better work is done by healthy than by unhealthy workmen. An abundance of outside or fresh air should be insisted on in all weathers, even if the workmen have to wear more clothing. This can be insured without exposing anyone to draughts, by the exercise of proper care in the ventilation. A want of pure air to mix with the poisonous fumes inseparable from a plating shop, must result in poisoning of the blood, since that passes through lungs charged with the poisonous air. For the same reason, extra care should be taken to carry away from the workman any fumes raised in chemical operations, such as those from the preparation of solutions and from pickling operations. If the workmen must handle very frequently or continuously, articles in contact with cyanide of potassium, or solutions of this poison, the hands must be protected with gloves of india-rubber, since cyanogen is readily absorbed by the skin, and passes into the body, causing ill health. This absorption of cyanogen causes painful sores on the hands. These are best treated by dipping the sore into dilute sulphuric acid (1 in 10 parts of water), freshly mixed, and enduring the consequent pain as long as possible. Then well wash the sore in warm soapy water, and bind it up in a rag wet with soap-suds. Frequent rinsing of the hands in a solution of iron sulphate will neutralize the bad effects of cyanide, and the nervous exhaustion caused by breathing cyanide

fumes, is best met by taking Parrish's Chemical Food, or a similar preparation of iron.

ATOMIC WEIGHTS AND CHEMICAL EQUIVALENTS  
OF ELEMENTARY SUBSTANCES.

Names.	Symbols.	Atomic Weights.	Valency.	Chemical Equivalents.
Aluminium	Al	27'5	3	9'17
Antimony	Sb	122'0	3	40'66
Arsenic	As	75'0	3	25
Barium	Ba	136'8	2	68'4
Bismuth	Bi	210'0	3	70
Boron	B	11'0	3	3'66
Bromine	Br	79'75	1	79'75
Cadmium	Cd	111'6	2	55'8
Calcium	Ca	39'9	2	19'95
Carbon	C	12'0	4	3
Chlorine	Cl	35'37	1	35'37
Chromium	Cr	52'5	6	8'75
Cobalt	Co	59'6	4	14'9
Copper	Cu	63'0	2	31'5
Fluorine	F	19'1	1	19'1
Gold	Au	196'7	3	65'56
Hydrogen	H	1'0	1	1
Iodine	I	126'63	1	126'63
Iridium	Ir	193'0	4	48'25
Iron	Fe	56'0	2	28
Lead	Pb	206'4	2	103'2
Magnesium	Mg	23'94	2	11'97
Manganese	Mn	54'8	2	27'4
Mercury	Hg	200'0	2	100
Nickel	Ni	58'8	2	29'4
Nitrogen	N	14'01	3	4'67
Oxygen	O	15'96	2	7'98
Phosphorus	P	30'96	3	10'32
Platinum	Pt	197'18	4	49'295
Potassium	K	39'04	1	39'04
Silver	Ag	108'0	1	108
Sodium	Na	23'0	1	23
Sulphur	S	32'0	2	16
Tin	Sn	118'0	2	59
Tungsten	W	184'0	6	30'66
Zinc	Zn	65'0	2	32'5

## APPENDIX.

**Electro-typing.**—This name was originally given to an electro-reproduction of printing type in copper, but has since been extended to similar reproductions of chased, engraved, and rough surfaces, and also the replication in electro-deposited copper of images and statues. The process may be briefly described in three paragraphs. First, a mould of some plastic substance is taken of the subject to be copied, the surface of the mould is coated with a conductive film, and this film is connected to the wires employed to suspend the mould in the depositing solution. Second, the mould is suspended in a solution of copper sulphate, connected by suitable wires with the negative pole of an electric battery or dynamo, a plate of copper to form an anode is connected to the positive pole of the electric generator and suspended in the solution opposite to the mould, and an electric current is passed between them until the mould is covered with a strong coating of copper. Third, when the coat of copper on the mould is deemed to be thick enough for the purpose required, it is removed from the mould, well washed to free it from copper salts, allowed to dry, then

strengthened by the application of solder or type-metal to the back, and mounted on a suitable block, or support.

To ensure success in this process, it is advisable to follow certain instructions relating to details dictated by the experience of others. These relate mainly to the choice and manner of working the moulding material, the arrangement of conducting wires, the choice and management of the depositing solution, and the regulation of electric current employed in depositing the copper.

*Moulding Materials.*—Moulds for electrotyping have been made of various plastic materials, such as gutta-percha, bees-wax, sealing-wax, shoemaker's wax, paraffin wax, stearine, marine glue, sulphur, plaster of Paris, printer's elastic compo., gelatine, and fusible metal or "clichee." Gutta-percha may be employed as a mould to take the impression of a flat engraved surface, coin, medal, or similar object capable of bearing pressure without injury. The gutta-percha is made soft in scalding hot water, rolled in the hands under cool water to form a smooth ball, pressed on the oiled coin, and worked all over it with the fingers, then put under pressure until cold and hard. Both sides of the medal or coin must be thus copied on separate moulds. Bees-wax may be used in a similar manner, but it is generally employed in a molten condition, when it is poured over the object to be copied whilst this is held in a suitable metal tray. The wax should be completely melted over a hot water bath, then allowed to partially cool before pouring it in the moulding tray. An ounce of dry white lead stirred well into each pound of molten wax, is said to improve

the mould. Bees-wax has been extensively used for electrotypes of printers' formes and engravings. Paraffin wax, stearine, and marine glue have been used in a similar manner, but are not recommended. Sealing-wax, shoemaker's wax, sulphur, and "clichee" have been used by amateurs and experimenters, with varying success in copying coins and medals. Plaster of Paris has been largely employed as a moulding material in copying images, statues, busts, and other works of art. The very best plaster must be chosen for this purpose. The work to be copied must be first oiled all over. The plaster is then mixed with water to the consistence of cream and poured at once over the object to be copied, and allowed to set hard before it is removed. Images, statues, and similar rounded objects must be copied in two or more moulds separately. When such objects are much undercut, copies must be taken of them in printers' compo. (a mixture of glue and treacle), and this elastic material employed as a mould for a copy in bees-wax. Gelatine is used in taking copies of finely-engraved plates, and other works of art in which very fine lines only are employed. As this substance is readily soluble in water, a solution of it is employed, and this is poured on the object to be copied, then allowed to set hard by drying before taking off the film. As this film is liable to swelling and consequent distortion in the depositing solution, it is necessary to so treat it as to render it insoluble in water. This is attained by mixing bichromate of potash solution, or a solution of tannic acid with the gelatine before moulding, and exposing the mould to



strong sunlight for several hours. Gelatine and also glue are rendered insoluble in water by this process.

*Metallising the Moulds.*—As the moulding materials employed in making electrotype moulds, are either non-conductors or bad conductors of electricity, it is necessary to coat the surface to be copied with some conducting substance to serve as a bridge for the coating of copper. Moulds of gutta-percha, bees-wax, resinous substances, and plaster of Paris, are coated with blacklead, applied with a soft brush. Only the finest and best powdered blacklead must be employed, and this is carefully brushed whilst dry into every crevice of the surface to be copied until every part has been covered with a film of the powder. Fine white bronze powder mixed with two-thirds blacklead, forms a superior conducting film. Moulds of plaster of Paris must be previously well dried, coated with warm stearine or paraffin wax, baked in an oven, again well saturated with hot melted stearine or paraffin wax, then baked hard to prevent the plaster from absorbing the coppering solution. Moulds composed of gelatine, glue, and elastic or printer's compo., must be first rendered insoluble. This is done by mixing two parts of tannic acid with the solution; to each 100 parts of the dry glue or gelatine employed, or by soaking the mould in a solution of bichromate of potash (a 10% solution), then exposing it to strong sunlight for some hours. Such moulds may be metallised by one of the following processes. (1) Wet the surface with a strong solution of nitrate of silver, place it on a porcelain plate under a bell glass, and expose it to sulphuretted hydrogen,

hydrogen gas, or vapour of phosphorous dissolved in carbon bisulphide. (2) Wash the surface alternately at intervals of five minutes with a solution of one part silver nitrate in four parts of distilled water, and a solution of one part protosulphate of iron in three parts of distilled water. When the surface has a whitish-grey tint, rinse in clean water, immerse in the typing solution, and connect at once to the battery. This preparation takes a film of copper rapidly. (3) Wash the surfaces with liquid hair dye, followed by a solution of pyrogallic acid; or with iodised collodion, followed by a solution of silver nitrate, and (after exposure to light) a solution of protosulphate of iron acidulated with nitric acid.

*Connecting the Moulds.*—The conducting surface of the metallised mould must be connected to the wire leading to the battery or dynamo. One, two, or more fine copper wires have their ends inserted in the edge of the mould, and the blacklead or other conducting medium is carefully brushed around the ends of the wires to form a starting-point for the deposit. In copying statues, busts, etc., a perfect network of such fine wires are formed, with their ends sticking into every remote part of the mould. These wires are then twisted around a main line wire to form the main conductor leading to the negative pole. Forms of type and similar large surfaces are connected by copper straps leading from the frame of the mould. The moulds are weighted with strips of lead, and thus kept below the surface of the solution.

*Electrotyping Solution.*—Some good electrotypes have been made by the single cell process. A vessel of a

suitable size to contain the mould and solution is obtained, and this contains a nearly saturated solution of sulphate of copper made slightly acid by the addition of a few drops of sulphuric acid to each gallon. In this, one, two, or more cells of porous earthenware are immersed up to within an inch of their tops, after being charged with a solution of one part sulphuric acid in each fifteen parts of filtered rain water. The tops and bottoms of these cells should be previously soaked in paraffin wax to prevent creeping of copper salts, and formation of copper nodules. Each cell has a plate, a cylinder, or a bolt of amalgamated zinc suspended from a wooden cover to prevent the zinc touching the sides or bottoms of the cells. The wires from the moulds are connected to the zinc, and the work of deposition goes on, an equivalent of zinc being dissolved for each equivalent of copper deposited on the mould. Reserves of copper sulphate crystals must be suspended in wire-gauze bags around the top of the vessel in the solution to keep up its strength.

When the solution is to be employed with a separate battery or dynamo, one quart of water and four ounces of sulphuric acid must be added to each gallon of the above saturated solution. Anode plates of pure copper must also be employed, connected to the positive pole of the generator, and the moulds must be connected to the negative pole of the dynamo or zinc element of the battery. No reserve of crystals will be required in this solution, as the anodes supply copper to it as required.

*Working the Solution.*—Immediately after connecting the mould in the electrotyping solution with the generator

of electricity, a spot of electro deposited copper will appear on the surface of the mould connected to the end of the conducting wire, and this spot will spread all over the surface of the mould with more or less rapidity, depending on the condition of the metallic coat and that of the arrangements. A small mould may be coated in the course of a few minutes or within an hour, and yet have a good deposit. The rate of deposit is affected by the density and temperature of the solution; the relative size and nearness of the anode and mould (or the zinc and mould in a single cell arrangement), and the strength of the electric current. The character of the deposit is also affected in a similar manner. A dense solution (containing too much copper and too little water), a low temperature, a low battery power, anodes too small, or, too great a distance between the moulds and anodes, may result in a slowly formed and brittle deposit. A weak solution (poor in metal), a high temperature, a high battery power, anodes too large, or moulds and anodes too close together, may cause a quickly deposited coat of a loose and porous structure. When the solution is too dense, the thickness of the deposit may be unequal, and dark streaks appear on it, but this same defect may be caused by density in the lower part of the solution only, due to want of stirring. The solution should be stirred every evening or at least once a day. The anodes and the zinc elements should be slightly larger than the surface to be coated. The temperature should be as near 60° Fah. as possible, but 5° lower may be permitted. A voltage of from one to two volts is quite enough to

deposit copper in good condition. Higher voltages may be required to push the desired volume of current through resistances, but a reduction of resistance is preferable to an increase of voltage. Much can be done in regulating the rate and character of the deposit by reducing the resistance in the outer circuit, as by enlarging the anodes, using larger conducting wires, and placing the moulds nearer the anodes. The resistance may also be increased, if desired, by the opposite arrangement, or by the use of a resistance board in circuit. Water will be required occasionally to make up for loss by evaporation, but no other alteration should be made in a good solution.

*Backing and Mounting Electrotypes.*—When a sufficiently thick shell of copper has been obtained on the mould, it should be taken out of the solution, rinsed in tepid water, and the two carefully separated to avoid any buckling of the shell. This should then be washed in hot water to free it from salts, then dried. When dry, lay it face downward on a plane surface, brush the back with soldering fluid, sprinkle it with grain soft solder, and place it on a hot plate to melt the solder, then brush the molten solder all over the back. This will give stiffness to the copper shell. The edges may now be trimmed with sharp shears and the electros mounted. The obverse and reverse of medals and coins may have their backs thickened and soldered together, or be soldered to flat discs of metal furnished with loops. They may then be silver plated or gilded. Parts of busts and statues may also be soldered together care-

fully. Engravings and type must be backed with type-metal, sheared, and mounted on type-high blocks of wood.

Instructions for making electrotype copies of fishes, ferns, leaves, etc., will be found on pp. 219-227 in my book on "Electrical Experiments," published by Messrs. Whittaker and Co., at 2s. 6d.

**Frosting Gilded Work.**—A frosted or dead lustre appearance can be imparted to electro-gilded work by several methods.

1. *By Mechanical Means.*—A sand blast skilfully directed on the work to be frosted. By a skilful use of frosting brushes on the metal to be electro-gilded. These brushes are made with four swinging knots of brass, German silver, or steel wires linked to eyes passing through a wooden boss made to fit on the spindle of a polishing-lathe. The work is held to these brushes, and twisted about in such a manner as to allow the ends of the metal wires to strike the surface to be frosted and give it a rough appearance. These brushes cost from 2s. to 3s. each.

2. *By Chemical Means.*—The article to be gilded must be of copper, or some alloy of this metal, such as brass or bronze. First get it clean and bright for gilding. Then dip it in a mixture of equal parts sulphuric and nitric acid to which a little common salt has been added, rinse in two waters and pass at once into the gilding solution.

3. *By Electro Deposition.*—Clean the article as for gilding. Deposit a very thin film of copper on it from a coppering solution, rinse, and pass at once into the gilding solution. If a pale yellow gold is desired,

deposit a thin film of silver over the copper before placing it in the gilding solution.

**Stopping off Deposits.**—It is sometimes advisable to ornament articles with various shades of gold in different parts, or with patches of gold, and silver, and copper. This is done by stopping off the deposit of gold or silver from the parts to be left uncovered, with a suitable non-conducting varnish. After the gold or silver has been deposited on the part to be ornamented, the varnish is dissolved off with warm spirits of wine. The following is a list of varnishes suitable for the purpose. *Yellow Stopping-off Varnish*: Best copal varnish coloured with chromate of lead. This will protect metals in cold solutions only. *Blue Stopping-off Varnish*: Best copal varnish coloured with ultramarine. *Red Stopping-off Varnish*: Best quick-drying copal varnish coloured with rouge. These varnishes will dry in about three or four hours, and will resist hot cyanide solutions. *Gore's Stopping-off Varnish*: the following is given by Mr. Gore in his book on "The Art of Electro-Metallurgy.—Translucent (clear) resin, 10 parts; yellow beeswax, 6 parts; extra fine red sealing wax, 4 parts; the finest polishing rouge, 3 parts. The method of mixing these and forming them into a varnish is not given by the author.

**Plating Dynamos.**—These are dynamo electric machines built specially for the work of electro-plating and electro-deposition of metals. The special features of a good plating dynamo are: (1) A long drum armature formed of iron laminæ or plates, over-wound with insulated copper wire or ribbon of a size large enough to safely carry a

large volume of current at a low tension; (2) Fields of the horse shoe type, with long cheeks or pole pieces to the cores, the coils on which are shunt connected with the armature coils. Fields of the Kapp type, as shown at Figs. 18, 21, and 25, on pp. 56, 59, and 65, are preferable to those of the Manchester, Gramme, or Siemens type, for plating dynamos, because they combine high efficiency in working, with ready and easy access to the working parts; (3) Brush-holders fixed to a rocker, and long bearings, together with other good features as described in § 33, pp. 44-47.

*Output.*—This term is employed to express the quantity of electric current obtainable from a dynamo. The output of a plating dynamo should be given in volts and ampères, at a stated speed of the armature. Outputs in Watts or Kilo-watts do not clearly state the voltage of the current, and are therefore unintelligible to the buyer.

*Speed.*—The fields and armature should be sufficiently large to allow of the machine being driven at a low speed, —say from 700 to 900 revolutions per minute—to get the required voltage for plating. A rule for ascertaining the voltage or E.M.F. of the current obtainable from a small machine is given on p. 40. In larger machines a higher efficiency is obtainable. The term “angular velocity,” given in that rule, means the speed of the outside ring or periphery of the armature. Every wire lying along the surface of this ring (as in the winding of a drum) is regarded as active wire, because it cuts across the magnetic lines of force as shown in Fig 11, p. 38. As the ends of those wires, when bent down over the ends of



the armature, do not cut across the magnetic lines, but glide through them in a line parallel with their direction, they are regarded as "dead" or inefficient wires: merely conducting but not producing current. In a long drum armature, one third of the wire in its coils is estimated to be "dead" wire.

**Rate of Deposit.**—Each metal has its own peculiar qualities which govern the rate at which it can be deposited in a good condition. This condition has been named a "reguline state," that is, a state nearly like that of the metal when melted and cast in a mould. Electro-deposited metal, however, is generally so porous, even in its best condition, as to be rarely air-tight and water-tight. The quality of a deposit is governed by the quality of the solution from which it was obtained, the temperature of the solution, and the quantity of electric current passing through the article to be coated, in a stated time. This last is named the density of the current, and this determines the quantity of metal which can be deposited in a given time. The following list shows the quantity of metal which can be deposited with a current density of one ampère on  $\frac{1}{16}$  square foot of surface in one hour.

Aluminium 52·4977 grains per ampère hour.

Silver 52·1142 " "

Zinc 18·7240 " "

Copper 18·1638 " "

Gold 37·7290 " "

Nickel 16·9030 " "

These quantities are calculated on the most recent determinations of the electro-chemical equivalents of

the metals, and differ from those given in the tables on pp. 136, 162, and 172. The figures in those tables must be held subordinate to these latest determinations, and corrected as required. Even then this rate of deposit cannot be guaranteed in metal of a reguline condition. It is therefore safer to take a slightly lower estimate than that given here, and in the tables referred to above. The whole subject receives some attention in Gore's "Art of Electro-Metallurgy," pp. 35-45.

## GENERAL INDEX.

- Acetate of nickel, 167.  
Acid-proof vessels, 109.  
Acidity, correcting, 176.  
Accumulator cells, 51.  
Advantages of shunt wound dynamos, 43.  
Alkaline copper solutions, 178, 179.  
Alloys, deposition of, 7, 10, 183; cleaning, 93; colour of, 184.  
Altering current of dynamo, 57.  
Aluminium solution, 197, 212.  
Amalgamation of zinc, 14.  
Amateur's gilding bath, 154.  
Ammeter, need of, 71.  
American Bunsen battery, 24.  
American potash, 176c.  
Ammonia, adding to baths, 186, 187.  
Antimony solution, 197.  
Anodes, silver, 131; gold, 159; nickel, 169; brass, 188; zinc, 192; copper, 180; silver, how to arrange, 139; pure, importance of, 131, 159, 169; cube nickel, 176f.  
Antidotes to poisoning, 199, 200.  
Appliances, workshop, 70.  
Aqua regia, composition of, 149.  
Arrangement of anodes, 139, 148, 171; of articles in solution, 171, 133, 154.  
Armature of dynamo, 38.  
Articles, scouring, 97; dipping, 97; cleaning old, 98; re-plating, 100; rusty and corroded, 106; cleaning by hand, 113; motion of in vat, 153; finishing electro-gilt, 162; arrangement of, 133, 154, 171; burnishing, 144.  
Arsenic in brassing bath, 188.  
Arsenious acid, use of, 188.  
Atomic weights, 200.  
Automatic plating apparatus, 176f.  
Avery's Dynamo, 63.  
Ayr, water of, stone, 82, 114.  
Backing electrotypes, 208.  
Battery, Babington's, 15; Bunsen, 23; American Bunsen, 24; Cruikshank's, 15; Smee, 17; Daniell, 20; Volta's, 15; Wollaston, 15; deposition by, 11; cells, how to arrange in series, 28; in parallel, 29.  
Batteries, construction, 25; for gilding, silvering, nickeling, coppering, typing, 26; constant, 11; suitable for electro-deposition, 11; unsuitable for electro-deposition, 13; resistance of, 11, 27; maintenance of, 13, 25; compared with dynamos, 32.

- Baume's hydrometer, 86.  
 Baths, *see* Solutions.  
 Best nickel solution, 169; copper solution, 179.  
 Best work in nickeling, 166.  
 Bismuth solution, 197.  
 Black cyanide, 123.  
 Boards, resistance, 90.  
 Bobs, polishing, 76, 176a.  
 Bottone's dynamo, 57.  
 Box-wood sawdust, 85.  
 Brass, anodes, 188; to clean, 95; electro-deposition of, 183.  
 Brassing, 184-188.  
 Brassing solutions, 184-189; table of, 185; management of, 188; how to make; 186-7; Watt's solution, 187.  
 Bright deposit of silver, 137.  
 Bright lustre dip, 108.  
 Brightening solution, 138.  
 Britannia metal, to clean, 105; to plate, 139.  
 Bronze, to clean, 107.  
 Bronzing, 184-189.  
 Brushes, 76, 78, 80, 176b.  
 Burnishers, 146.  
 Burnishing, 144, 145, 146.  
  
 Cadmium solution, 198.  
 Canning's dynamo, 58.  
 Capacity of vats, 72, 73; of wires, 85.  
 Carbon, 23; bisulphide of, 138.  
 Carbonate, nickel, 167; copper, 188.  
 Care of solutions, 134, 158, 176.  
 Cast iron, to clean, pickle for, 93.  
 Caustic potash solution, 105.  
  
 Caustic alkali, 105.  
 Cells, how to arrange, 28.  
 Cell, single, process, 10.  
 Centigrade thermometer, 86.  
 Character of silver deposits, 132; gold deposits, 161; nickel deposits, 171; copper deposits, 181.  
 Choosing solutions, 3, 128, 169; dynamo, 44.  
 Chemical food, 200.  
 Chloride of nickel, 168.  
 Cleanliness essential, 92.  
 Cleaning cast iron, 93; wrought iron and steel, 94; copper, brass, and German silver, 95; zinc, 104; Britannia metal and pewter, 105; silver and gold, 106; filigree work, 106; rusty and corroded articles, 106; clean water for rinsing, 108; imperfect cleaning, 96.  
 Cobalt solution, 197.  
 Colour of gold deposit, 160; of brass deposit, 184.  
 Colouring and finishing, 143.  
 Copper, electro-deposition of, 177; cyanide, 179; sulphate, 181; cleaning, 95; wires, 84-85; plated metals, 177; anodes, 180.  
 Coppering solutions — Roseleur's, Dr. Elsner's, Walenn's, Weil's, Gulenson's, 178; cyanide solution, 179; Watt's, Sprague's, best, 179; electrotype, 181, 205; working, 180, 206; soldered joints, 100.  
 Copper deposits, how to calculate rate and thickness; effects of high tension currents on, 181-182, 207.  
 Combining weights of metals, 200.  
 Commutator of dynamo, 39.

- Compo, rouge, tripoli, etc., 83.  
 Composition of double cyanide of silver and potassium, 121; of cyanide of potassium, 123; of gold terchloride 151.  
 Constant batteries, 11, 23, 25, 28, 29, 32.  
 Construction of batteries, 25.  
 Conversion of thermometer grading, 86; of hydrometer grading, 89.  
 Corrosion, cleaning off, 106, 107.  
 Cost of metals—copper, silver, gold, platinum, etc., 5; of vats, 72, 73; of dipping vessels, 74; of brushes, 76; of scratch brushes, 78; of scratch-brush lathe, 80; of thermometer, 86; of resistant board, 91; of cyanide, 124; burette, 126; nickel-plating outfits, 176f.  
 Crocus, 83.  
 Canning's four-pole dynamo, 61.  
 Cruikshank's battery, 15.  
 Cupboard, draught, 110, 118.  
 Cup brush, 78.  
 Current required to deposit metals, 7; alloys, 7; silver, 136; gold, 161; nickel, 173; copper, 182; brass, 189.  
 Cyanide, grey, black, white, 124; pure, value of, 125; testing and assaying, 126-7; of silver, 119; gold, 151; copper, 179; how made, 120; double, of silver and potassium, 121; of gold and potassium, 152; of platinum, 163; of mercury, 112; free, 122, 156, 157; testing solutions for, 157.  
 Cyanide of potassium, 123.  
 Cycle fittings, 176a.  
 Daniell battery, 20; E. M. F. of, 22.  
 Dark deposit, cause of, 132, 161.  
 Definition of electro-metallurgy, 1.  
 Density of silver solution, 122; copper, 207; gold, 156; nickel, 168-169; of current, 212.  
 Deposits of silver, 137, 212; gold, 160, 212; nickel, 171, 212; copper, 181, 212; brass, 188.  
 Depositing solutions, selection of, 3.  
 Deposition of copper, 8; tin, 192; by simple immersion, 8; by single cell, 10; by battery, 11; table of examples of, 9.  
 Desmar's nickel solution, 166.  
 Designing plating dynamo, 40.  
 Dips, cyanide, 97; potash, 105; acid, 107.  
 Dipping, 97, 107.  
 Dirty lead, etc., pickle for, 107.  
 Distilled water, importance of, 159.  
 Double salts, silver, 121; gold; 152; nickel, 167, 168; copper, 179.  
 "Doctoring" defective deposits, 175.  
 Draught cupboard, 110-118.  
 Dr. Elsner's coppering solution, 178.  
 Dry battery, Gassner's, 162.  
 Dynamo, origin of, 34; Woolrich's, 35; Wilde's, 36; fundamental principles of, 37; field magnet, 38; commutator, 39; plating, how designed, 40, 210; winding, series wound, 41; reversal of poles, 42; shunt wound, advantage of, 43; how to choose, for plating, 44, 211; how to choose second-hand machine, 46; various types of, 47; Wilde, 48; Ladd, 49; Siemens, 51; Weston, 52;

- compared with battery, 32; Oersted's, Faraday's, and Saxton's discoveries, 34; Hartley's, 55; Bottone's, 57; Canning's, 58; Lister, 59; Austin, 60; Canning's four-pole, 61; Avery's Lahmeyer, 62; Gramme, 64; speed, 66, 211; management, 69; how to increase E.M.F. of, 174.
- Easily deposited metals, 6.
- Effect of high tension on deposits, 132-181, 207; of light on silver deposits, 134.
- Electro-deposition of metals, various, 10; by battery, 11; by dynamo, 32; of silver, 115; gold, 149; nickel, 165; copper, 177; alloys, brass, etc., 183; zinc, tin, iron, cobalt, etc., 191; platinum, 163; cobalt, palladium, antimony, lead, aluminium, cadmium, magnesium, 198.
- Electro-silvering, 115; gilding, 149; nickeling, 165; coppering, 177.
- Electro-metallurgy, defined, 1; Electrotyping, 181, 201.
- Elementary substances, combining weights of, 200.
- Elmore dynamo, 60.
- Emery, 83.
- E. M. F. of batteries, 11, 28-29; Smee, 20; Daniell, 22; Bunsen, 24.
- E. M. F. effect of, on silver deposit, 132; gold, 161; zinc, 191; nickel, 174; tin, 194; copper, 182; brass, 189; how to increase in dynamo, 174; how to increase in battery, 28.
- Essential cleanliness, 92.
- Equivalents, chemical, 200.
- Examples of simple deposition, 9.
- Experiments, first, 4.
- Faraday, discoveries by, 34.
- Fahrenheit thermometer, 86.
- "Faking" solutions, 130.
- Fearn's electro-tinning solutions, 194.
- Field magnets, 38.
- Filigree work, cleaning, 106; plating, 129.
- Filtering solutions, 130, 176.
- Finishing silver-plated goods, 140; thin deposits of silver, 147; electro-gilt articles, 162; nickel deposits, 174.
- Fittings for vats, 74, 148.
- Food, chemical, 199.
- Free cyanide, 122, 132, 152, 156; importance of, 157; testing for, 157.
- Frosting gold, 79; gilded work, 209.
- Fulminating gold, 153.
- Fundamental principles of dynamos, 37, 210.
- Galvanometer, 71.
- Gassner patent dry battery, 162.
- Gilding, electro, 149; baths, 158; solutions, strength of, 156; assaying, 157; testing, 157; amateur's, 154; frosting, 209.
- German silver, cleaning, 69, 106; testing, 99; pickle for, 106; dips and steeps for, 107; Watt's solu-

- tion for plating, 128 ; electro-deposition of, 190.
- Gold, cleaning, 106 ; testing, 99 ; finishing, 162 ; fulminating, 153 ; oxide of, 153 ; pure anodes of, 159 ; terchloride of, 150 ; cyanide 151 ; solutions, 152, 153, 154, 155, 156 ; solutions, assaying, 157 ; deposits, colour of, 160 ; rate of deposit, 162.
- Glass vats, 71.
- Grading thermometer, 86 ; hydrometers, 89.
- Gramme dynamo, 64.
- Gore's observations on simple deposition, 19 ; remarks on silver deposits, 135 ; solution of zinc, 121 ; stopping off varnish, 210.
- Grey cyanide, 123.
- Grounding for burnishing, 145.
- Gulenson's solution of copper, 178.
- Hand-finishing plated goods, 114, 144.
- Harding's dynamo speedometer, 68.
- Hartley's dynamos, 55 ; brushes, 76, 78 ; lathes, 79, 81, 82, 142 ; resistance board, 89.
- Health of work-people, 199.
- Hermann's zinc solution, 191.
- High tension currents, effects of on deposits of copper, 181 ; silver, 132 ; gold, 161 ; nickel, 171.
- History of the art, 2.
- Hooks and eyes, how to tin, 193.
- How to arrange battery cells, 28, 29, 30 ; design a plating dynamo, 40 ; to choose a dynamo, 44 ; prevent dark silver deposits, 132 ; ascertain thickness of deposits, 135 ; work solutions of silver, 130 ; gold, 158 ; platinum, 164, nickel, 171 ; copper, 180 ; brass, 188 ; zinc, 191 ; tin, 194 ; iron, 196.
- Immersion, simple, 8 ; examples, 9.
- Impure cyanide, effects of, 124.
- Importance of cleanliness, 92.
- Indicator, speed, 67.
- Iodide of silver, 129.
- Iron, cleaning, 93, 94, 107 ; pickle for, 93, 94, 107 ; deposition of, 196 ; solutions, Klein's, etc., 196, 197 ; tonic, 199.
- Joints, treating soldered, 100.
- Klein's solution of iron, 196.
- Ladd's dynamo, 49.
- Lathes, 79, 80, 81, 82, 142.
- Lead, cleaning, 107 ; depositing, 197.
- Leading wires and cables, 84.
- Light, effect of on deposits and solutions, 134.
- Lister dynamo, 59.
- Low cost of metals, 5.
- Lustre, bright, 108.
- Machinery, polishing trinkets by, 114.
- Magnet, field of dynamo, 38.
- Magneto-electric machine, 34.
- Magnesium solution, 198.
- Maintenance of batteries, 13, 25.
- Management of dynamos, 69 ; of silver-plating solutions, 130 ; of

- gilding baths, 158; of brassing baths, 188.
- Manchester dynamo, 63, 64.
- Materials for polishing metals, 82.
- "Matt" deposits explained, 132.
- Measurements of vats, 72, 73.
- Meidenger's iron solution, 197.
- Mercury, 14, 24; nitrate of, 111; cyanide of, 112.
- Metals of low cost, 5; of high cost, 5; easily deposited, 6; not easily deposited, 7; current required to electro-deposit, 7; electro-deposition of, 10; simple deposition of, 8, 9; moulds for electrotypes, 201; moulding materials, 202; connecting, 205; metallising, 204; metallising moulds, 204.
- Molten process of tinning, 192.
- Most effective dynamo, 66, 210.
- Motion to articles in plating vat, 133.
- New Wilde dynamo, 59.
- Neutralizing acidity of bath, 176.
- Nickel salts, 167, 169; solutions—Weston's, Pott's, Powell's, Desmar's, 166; density, choice of, best, 169-170; temperature, suitable vats for, 170; working, 171, acidity of, filtering, spoilt, 176.
- Nickel, anodes, where obtained, 169; deposits, rate and thickness, 172, 173; power required to deposit, 173; finishing, 174; acetate, carbonate, oxide, sulphate, 167; double sulphate, 167; double chloride, 168; strength of nickel baths, 169.
- Nickeling, electro, 165; its use, when unsuitable, 165; best work done in, 166; cycle fittings, 176a.
- Nitrate of silver, 115; testing, 117; refining, 117; of mercury, 111.
- Oersted's discovery, 34.
- Ohm's law, 29.
- Old articles, re-plating, 100.
- Old baths, 198.
- Output of plating dynamo, 211.
- Oxide, silver, 128; gold, 153; nickel, 167.
- Parallel, connecting cells in, 29.
- Parrish's food, 200.
- Palladium, solution, 197.
- Person and Lire's zinc solution, 191.
- Perchloride of tin, 193.
- Pewter, cleaning, 105, 107.
- Pickle for iron, 93; steel, 94; zinc, 104; brass, 106; German silver, 106; rust, 107; pewter, 107.
- Platinum, electro-deposition of, 162-164.
- Platinizing silver plates, 17.
- Plating dynamo, 40, 210; solutions, 121-130.
- Polarization of battery, 11-13.
- Poles, reversal of dynamo, 42.
- Polishing tools, 76; lathes, 79-82, 142; materials, 82; by hand, 113-114; trinkets, 114; silver, 141-2; gold, 162; nickel, 174.
- Poisonous fumes, 110.
- Poisoning, antidotes to, 199.
- Potash solution, 105.
- Potassium cyanide, 123-127.
- Pott's solution of nickel, 166.
- Powell's solution of nickel, 166.
- Power to deposit silver, 136; gold, 161; nickel, 173.



- Practical hints on silver-plating, 138.  
 Preparing the work, 92.  
 Pumice stone, 82, 113.  
 Pure anodes, 131, 159, 169; nickel salts, where obtainable, 169; cyanide, importance of 124.
- Quicksilver, 111.  
 Quicking, 111-112.  
 Quantity current, how obtained, 29.  
 Ragged deposits of nickel, 171.  
 Rates of deposit, silver, 136, 212; gold, 162, 212; nickel, 172, 212; copper, 182, 212.  
 Recovering metal from spoilt baths, 176, 198.  
 Recovering waste, wash waters, sweep, 198.  
 Re-plating old articles, 100, 176s.  
 Refining silver, 117.  
 Resistance boards, 89, 90; of battery, 11, 28, 29.  
 Reversal of dynamo poles, 42.  
 Rinsing, clean water for, 108.  
 Roseleur's solution, copper, 178; tin, 194.  
 Rotten stone, rouge, 82.  
 Ruolz', M. de, brassing solution, 184.  
 Rust, 106-107.
- Salt, common, use of in stripping, 103; in nickel solutions, 176.  
 Sand, Trent, 82.  
 Sawdust, boxwood, 85, 139.  
 Scratch brushes, 78, 79; lathes, 79-80.  
 Scouring, 97.  
 Scratch-brushing, 140, 162.  
 Second-hand dynamos, 46.
- Series wound dynamos, 41, 52, 56-60.  
 Series, connecting cells in, 28-29.  
 Shunt wound dynamos, 43, 44.  
 Sheffield lime, 82, 174.  
 Silver plates, 17; anodes, 131; testing, 99.  
 Silver deposits, character of, "matt" how to regulate, 132; hard and dark, how to prevent, 132; thickness of, 134; how to ascertain, 135; bright, 137; table showing rate of, 136, 212; stripping, 102; finishing, 140, 144.  
 Silver solutions, 122, 128, 129, 130, 131.  
 Silver-plating, 115, 139.  
 Silver nitrate, 115-117; cyanide, 119-121; double cyanide, 121; iodide, 129; sulphate, 130.  
 Siemens dynamo, 51, 57.  
 Simple coppering, 10; tinning, 9, 193.  
 Slinging wires, 84.  
 Small articles, nickelling, 176f.  
 Smee cell, 17.  
 Soldered joints, treatment of, 100.  
 Speed of dynamos, speed indicator, 67, 211.  
 Speedometer, Harding's, 68.  
 Specific gravity hydrometer, 86.  
 Spoilt solutions, 176, 198.  
 Sprague's remarks on batteries, 20.  
 "Steeps" or dips, 107.  
 Steel, 94-107.  
 Stratification of baths, 133.  
 Stoneware acid-proof vessels, 74.  
 Stopping off deposits, 210.  
 Stripping processes, 101-103.  
 Sulphate of silver, 130; nickel, 167; copper, 181.

- Table of examples of simple deposition, 9; measurements of vats, iron, 72; wood, 73; safe carrying capacity of wires, 85; readings and gradings of hydrometers, 88; rates of silver deposition, etc., 136, 212; rates of nickel deposition, etc., 172, 212; of brassing solutions, 185; electrical equivalents, etc., 200.
- Temperature of solutions, gold, 157; platinum, 164; copper, 180; tin, 194.
- Testing silver, gold, nickel, etc., 99; cyanide of potassium, 126, 127; for free cyanide, 157; purity of silver nitrate, 117.
- Thermometer, 86.
- Tin, cleaning, 107; deposition of, 192; electro-deposition of, 193; perchloride, 193; solutions, 193-195.
- Tinning pins, hooks, eyes, etc., 10, 193.
- Transformers, 66.
- Trent sand, tripoli, 82.
- Trinkets, polishing, 114.
- Types of plating dynamos, 46.
- Unsuitable batteries for plating, 13.
- Valency, electric, 200.
- Value of metals, 5; of cyanide, 124.
- Varnish, stopping off, 210.
- Vats—iron, wood, glass, etc., 71-72.
- Ventilation of workshop, 199.
- Vessels for dips, 74.
- Volt meter, 71.
- Volta, 15.
- Walenn's copper solution, 178.
- Wash water, waste, etc., recovering gold and silver from, 198.
- Water of Ayr stone, 82, 114.
- Water, clean, for rinsing, 108; distilled for solutions, 159.
- Watt's silver-plating solution, 128; method of "doctoring" deposits, 175; alkaline copper solution, 179; brassing solution, 187; German silver solution, 189; zincing, solution, 122; method of maintaining tin solutions, 195; book on electro-deposition, 198.
- Weight, combining, of metals, 206.
- Weil's copper solution, 178.
- Weston's nickel solution, 166; plating dynamo, 52.
- Wilde's plating dynamo, 36, 48.
- Winding plating dynamos, 41.
- Wires, slinging, leading, 84; capacity of, 85.
- Woolrich's dynamo, 35.
- Wood vats, 71; fittings for, 74.
- Wollaston battery, 15.
- Working electrotyping solution, cost of Daniell cells, 22.
- Wrought iron, cleaning, 94, 107.
- Zinc, electro-deposition of, 191; solutions, anodes, etc., 192; cleaning, pickle for, 104.













U. C. BERKELEY LIBRARIES



C042251059

133106

TS670

B6

UNIVERSITY OF CALIFORNIA LIBRARY



