

[search](#)[subjects](#)[titles a-z](#)[organization](#)[how to](#)

GATE - 2/90 - Biogas for Developing Countries

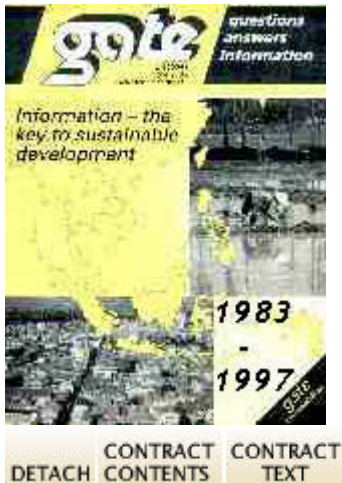

(introductory text)

Editorial

Dear Readers,

Focus

International conference on biogas technologies and implementation strategies - A review

Final recommendations of the international conference on biogas technologies and implementation strategies

Catchword

(introductory text)

Diffusion of biogas technology: strategies and policies

Biogas - An appropriate technology for third world countries

Workshop

Biomanure from small biogas plants

Evaluation of biogas programmes - Methodology and criteria

Biogas in agriculture - A status quo report from the FRG

FRG a "Developing Country" in biogas technology

Biogas in the municipal and industrial sector - A status quo report from the FRG

The promotion of biogas plants in the Federal Republic of Germany

Cartoon & reflection

International scene

Documentation

Visiting card

News from Bonn

News from GATE

Bookbox

Acknowledgements

GATE - 2/90 - Biogas for Developing Countries

GATE - ISAT

Questions-Answers-Information

July 1990

ISSN 0723-2225

GATE -Deutsches Zentrum für Entwicklungstechnologien

Editorial

Publisher:

Deutsche Gesellschaft

für Technische Zusammenarbeit (GTZ) GmbH

(German Agency for Technical Cooperation)

Post Box 5180

Dag-Hammarskjold-Weg 1

D-6236 Eschborn 1

Federal Republic of Germany

Telephone: 0 61 96/79-0

Telex: 41523-0 (gtz d)

Editorial Committee:

Peter Baz, Wolfgang Morbach,

Berthold Pilz, Alexander Wittkowsky

Editor:

Beate Worner

Editorial Assistant:

Henriette Mende

Cover photo:

A family **biogas** plant under construction in Séjenane, Tunisia

Printed by:

Hoehl-Druck

K/ausstra/3e 31

D-6430 Bad Hersfeld

Federal Republic of Germany

"gate" appears quarterly; it is distributed free of charge.

Named contributions do not necessarily represent the views of the publisher or the editorial staff

Reproduction is permitted after consultation; copies should be supplied

ISSN 0723-2225

Dear Readers,

As a result of the first oil crisis, in the early 1970s, **biogas** technology became the appropriate energy supply technology in developing countries. When the first plants built with Federal German Technical Cooperation were put into use, in the mid-1970s, it was found that implementing **biogas** technology is a complex process, and that it is important to take all the factors involved into account in a manner appropriate to the situation. Realizing that the problem of disseminating **biogas** technology called for an Integrated approach, the Federal Ministry for Economic Cooperation (BMZ) commissioned GTZ to develop a supraregional programme - the **Biogas** Extension Programme.

The versatility of the technology is based on the fact that the gas, produced by biochemical processes from agricultural waste products and organic domestic refuse, can be used for lighting, cooking, heating, cooling, and as engine fuel. The digested slurry - the end-product of the fermentation process, is an excellent organic fertilizer. So **biogas** technology also helps to save foreign currency expenditure on mineral fertilizer. Moreover the biomass is returned to the ecological nutrient cycle.

In some regions, **biogas** is used instead of firewood and non-renewable fuels, which are often imported. It thus also helps to conserve natural resources.

The International **Biogas** Conference held in Pune, India, at the beginning of this year prompted us to devote the present issue of "gate" to an in-depth review of this technology which is so important for many people in the Third World. **Biogas** was our focal topic once before, in gate 4/85, but the main emphasis in that issue was on technical aspects.

This time, we focus on the International **Biogas** Conference and its results - backed up, so to speak, by reports from various countries on **biogas** programmes and social and economic aspects, to mention only a few points: the "right blend" we hope, for the **biogas** enthusiasts and experts among our readers.

Heinz-Peter Mang

Focus

International conference on **biogas** technologies and implementation strategies - A review

by Thomas Buhl-Bohnert

The conference had been initiated and was jointly sponsored by the Department of Non-Conventional Energy Sources (DNES), the Ministry of Energy, the Government of India and the German Federal Ministry for Economic Cooperation (BMZ). Preparatory work had been sponsored by the City of Bremen. For the organization of the conference, DNES commissioned UNARP, and on behalf of

BMZ the Deutsche Gesellschaft für Technische Zusammenarbeit (GTZ) GmbH commissioned BORDA as the NGO member of the Joint Steering Committee.

The five-day conference was attended by 135 experts from 36 countries. It is impossible to summarize here all the discussions and interaction between the participants. The official conference report will, however, include all the country papers and a more detailed overview of the course of the conference.

The decision to include representatives of NGOs in the formulation of policy and implementation strategies for **biogas** promotion programmes amounts to clear recognition of the increasing importance of these organizations for programmes such as **biogas** technology promotion, which are closely oriented to the target groups.

High-tech lectures at the beginning of the conference not only illustrated the scientific theories behind some of the anaerobic process technologies, but also included visual presentations of systems in operation under field conditions.

Fighting pollution with **biogas** plants

It became obvious from these presentations that apart from the costs of such systems, anaerobic digestion technology for pollution control and waste recycling in urban and agro-industrial areas indicates the importance of major applications in the future, given the global increase in environmental problems.

There are already several technical solutions available for recycling various types of substrate, from landfill waste to highly diluted urban and industrial organic waste water. It is to be noted that the application of these technologies is so far mainly concentrated in developed, industrialized countries where socio-economic conditions are often totally different from those obtaining in developing countries. It is precisely because of these differences that future research in this field should be directed towards developing efficient, low-cost designs for different-scale operations adapted to differing local conditions. For developing countries in particular, research into and demonstration of this technology in rural and urban areas will be of immense importance. S. Gosh's biphasic system demonstration plant in a Chinese village, or G. Lettinga's example in the Colombian town of Cali are of major interest in this context.

Following a plenary question-and-answer session, with all the hightech experts on the panel, the conference turned its attention more or less exclusively to strategies for implementing family-size small-scale **biogas** programmes in developing countries.

Major differences in dissemination of family-size plants

A total of 42 papers, describing activities in 36 countries and the work of two international bodies, were submitted to the conference. Experience in the implementation of **biogas** technology varies widely from country to country, as can be seen from the numbers of family-size **biogas** plants installed (see Table overleaf).

For two days, theses on five subjects, namely

- technology
- financial issues
- social aspects

- implementation

- evaluation were discussed in five working groups. It was in these working groups that most of the interaction among participants from the different countries and professions took place.

Still more training needed

The predominating discussions among the participants, particularly those from developing countries, was about the small-scale household and farm-level digesters. Existing small-scale digester designs which are technologically fairly mature are available for large-scale implementation in rural areas in most developing countries. Basically, these designs are of two types - fixed dome and floating dome. Although these two designs are fairly standardized some modifications are often needed to adapt them to local conditions, though the basic design principles are the same. These modifications of a given design indicate the unavoidable need for local adaptations, which in turn mean that **biogas** technicians at local level have to have adequate skills and adaptability.

There were considerable discussions in the working groups about the need to set up an international training institute. No one would deny that the training facility is an indispensable precondition for successful programmes. The question of the proposed international facilities needs to be considered in the light of training facilities which already exist in the world.

It would be worthwhile to request a small international group of experts to examine this issue thoroughly and develop a detailed plan of action, including the finance needed to turn the plan into an implementable project.

Table: Family-size biogas plants so far installed

Country	Installed units
Bangladesh	500
Bhutan	54
Brazil	8,300
Burundi	192
Caribbean islands	190
China (People's Republic)	5,000,000
Egypt	100
India	1,260,000
Indonesia	200
Ivory Coast	50
Kenya	300

Mali	75
Morocco	250
Myanmar	< 2,000
Nepal	5,959
Nicaragua	24
Philippines	800
Rwanda	< 200
Sudan	40
Tanzania	320
Tunisia	28

Biogas programmes at risk due to lack of funds

As regards international training facilities or other, similar national, regional and international facilities, the issue which most occupied the participants was the question of financial resources. Foreign aid, through either bilateral agreements or international aid agencies, was considered as necessary and extremely useful financial input. However, it appears that there is often a wide gap between the money required and that available. While nobody questioned the fact that the progress of **biogas** programmes in many developing countries was suffering badly due to a lack of adequate financial resources, it was noted that plans for **biogas** programmes were frequently made on a scale totally incompatible with available financial resources. In this context, the conference noted that the reality of inadequate financial resources (a situation which would not be likely to change for the foreseeable future, as is the case with all development programmes in Third World countries) should be given due consideration when planning the scale and size of the programme. Long-term planning, with a gradual build-up of the scale of operations over a period of time could represent a rational framework for planning.

The highlights of the discussion found expression in the Final Recommendations (see page 6).

Further international **biogas** conferences planned

The last day of the conference was entirely given over to plenary sessions. After the chairpersons of the five working groups had reported to the audience, in the session chaired by Mr. G. Hilliges (Bremen) and co-chaired by Mrs. B. Krishna, the proposals for the final recommendations were presented by Prof. Dr. Moulik in the session chaired by Dr Gururaja (Adviser, DNES) and Mr. K. Hinrichs (BMZ) as co-chairman. Finally, the principal final recommendations were discussed and passed. A six-member committee was entrusted with the task of formulating the final wording of the recommendations.

It became clear at the final meeting that all the participants had found the conference extremely helpful and relevant to their respective places of work, and it was suggested that similar conferences be held every three years, either under the same organizational umbrella or with other countries taking the lead. Even at this early stage a number of unofficial suggestions were made as to who

should host the next conference.

The final session gave everyone who still felt that some points of interest should be submitted to plenary discussion an opportunity to do so. Once again, there was a call for an international publication to improve communication. It was pointed out that **Biogas** Forum, published in close cooperation by GTZ and BORDA (FRG), may be subscribed to free of charge on application. (For address see "Bookbox")

Excursion, exhibition and poster sessions

A one-day village excursion programme was organized by local district authorities and UNDARP on 13 January 1990.

Five groups each visited two villages where numerous farmers had **biogas** plants, of either the floating drum or fixed dome type. There were even some digesters made entirely of plastic bags to be seen. For the international guests, especially those from countries which have just started their **biogas** programmes, it was encouraging to see that **biogas** technology has taken over in a big way from the traditional utilization of energy and fertilizer. The warm welcome extended to the participants by the villagers was greatly enjoyed and appreciated.

Abstract

An international **biogas** conference was held in Pune, India, from 10 to 15 January 1990. It was organized by the Department of Non-Conventional Energy Source (DNES) of the Indian Ministry of Energy and the Federal Ministry for Economic Cooperation (Federal Republic of Germany). The conference was attended by 135 experts. A wide range of topics was covered, but the main emphasis was on five aspects of **biogas**: **biogas** technology, financing of **biogas** programmes, social aspects, introduction of **biogas** technology and questions of evaluation.

Résumé

Du 10 au 15 janvier 1990 s'est déroulée à Pune (Inde) une conférence internationale sur le biogaz. Cette conférence avait été organisée par le Department on Non-Conventional Energy Sources (DNES) du ministère indien de l'Énergie et le ministère fédéral allemand de la coopération économique, et a réuni 135 experts. Les thèmes abordés ont été multiples, mais 5 aspects ont été essentiellement traités: technologie du biogaz, financement des programmes de biogaz, aspects sociaux, introduction de la technologie du biogaz et évaluations.

Extracto

En Pune, India, tuvo lugar del 10 al 15 de enero de 1990 una conferencia de **biogas** internacional, organizada por el Department on Non-Conventional Energy Sources (DNES) del Ministerio de Energía indio y el Ministerio Federal de Cooperación Económica (República Federal de Alemania). Participaron en la conferencia 135 expertos. La diversidad de los temas fue grande, pero principalmente se analizaron cinco aspectos: tecnología del **biogas**, financiación de programas de **biogas**, aspectos sociales, introducción de la tecnología de **biogas** y cuestiones de evaluación.

Final recommendations of the international conference on biogas technologies and implementation strategies

Financial aspects

1) Five million **biogas** plants are under operation in the world. It is considered feasible and realistic to aim at building 20 million units by the end of the decade, provided political will is sustained and

resources are available. The Conference therefore urges that additional resources, including finances, should be generated by national governments, international aid agencies, donor countries and non-governmental organizations in order to enhance **biogas** programmes to the target level.

Efforts should be made to involve financing institutions at both international and regional levels in a big way, considering the annual construction figure of 2 million family-size **biogas** units, costing 900 million US \$. This amount could be financed 50 % by private sources and 50% by public sources.

2) Cost on subsidy should be taken as an investment and development cost.

A substantial percentage of the total funds should be earmarked for software, including education and training programmes for different levels, post-installation servicing of plants and infrastructural support.

3) **Biogas** technology has proven to be an important stimulant for a comprehensive approach to long-term integrated development process. Although energy has been identified as the major advantage in the past, worldwide experience indicates multiple benefits of the **biogas** technology in relation to public health, employment generation, energy, fertilizer, environment, sanitation and abolishment of drudgery of women.

4) Many of the realized benefits are quantified by different methods in different countries. It is evident that the multiple-benefit characteristics of **biogas** technology proves its viability at user level as well as at the national level. Given the serious problems of environmental destruction and clean energy requirements at a global level, the environmentally sound renewable **biogas** technology needs immediate and widespread support from national and international bodies in order to enhance sustainable development in this field. Also, it should be noted that the **biogas** programme envisages a sharing of financial requirement between private individual users on the one hand and public investment on the other.

We therefore recommend: National governments must provide a political framework in favour of promotion of **biogas** technology, such as:

- integration of **biogas** programmes at all levels of government policies and planning processes;
- local, regional and national budgets have to provide allocations mainly for promotion, training, building and improvement of necessary infrastructure, R&D and implementation programmes;
- initially, adequate incentives and regulatory measures in tax-structures and other laws must be provided to bring **biogas** programmes to equal terms with competing technology systems. This will also encourage NGOs and private entrepreneurs.

5) Many developing countries, even though politically committed to **biogas** programmes, find immense difficulties in obtaining adequate financial support, due to severe resource constraints. It is in this context the role of international aid agencies and industrialized donor countries is crucial in the sense of providing sufficient aid for **biogas** programmes in the developing countries. This would, in turn, encourage more developing countries to commit for active promotion of **biogas** technology and apply for external aid assistance.

6) Additionally a part of the outstanding debts of the developing countries to donor countries should be converted into aid as an incremental addition to the existing **biogas** programme.

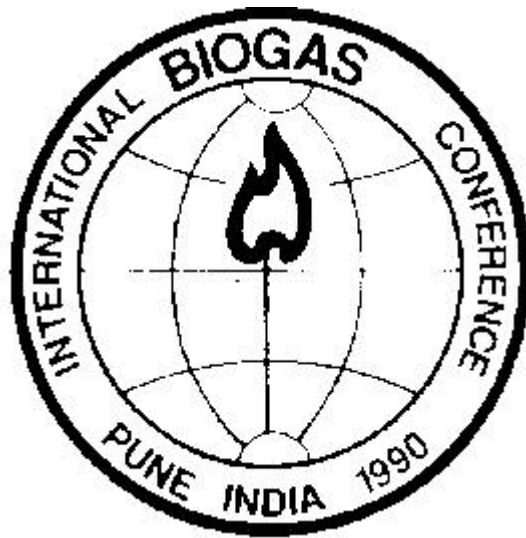

Figure

Technology

7) Anaerobic digestion processes are the heart of effective environmental protection and resource preservation concepts.

Anaerobic digesters are available for a large variety of raw materials and waste water, in technically simple and low-cost systems. They are available at any scale. High-tech hardware should be used only when it can not be avoided.

8) While technical information on small-scale family **biogas** plants and large-scale, high-tech plants is available in most countries, such information for effective low-cost anaerobic digesters for environmental protection is lacking and should be provided.

9) Emphasis should be laid on the utilization of effluents for food production, either as soil conditioner, or fertilizer for plants, or feed for fish and other animals. However, the nutrients contained in slurry are more efficiently used by plants.

10) When proven designs of **biogas** plants are transferred from one situation to another, technical adaptation to the local condition is necessary. Approximately two years are needed to find appropriate to solutions under new conditions.

11) Small-scale and low-cost solutions for waste (e.g. manure) and waste water treatment and **biogas** production require specific R&D and demonstration work in the field of

- sewage and waste water treatment at water temperatures of 5 - 20°C;
- very low-strength and very high strength waste waters, as well as solid wastes;
- post-treatment and re-use systems for fermented wastes.

12) There is a need for organizing International **Biogas** Conferences on a defined theme on a regular basis, preferably every three years.

Implementation

13) Implementation of **biogas** systems on a large scale, preferably on a cluster basis, should be taken

up to harness return in terms of ecological restoration, fossil energy conservation and public health improvement

14) A proper methodology should be developed and measures taken to put the technology within reach of the poor.

15) The commitment and support of international, regional and national resource agencies to create foundations to provide support to the local **biogas** extension organizations, for both hardware and software including infrastructural support is a must to bring about the sustainability of the **biogas** programme implementation, operation and maintenance.

16) **Biogas** technology education and training programmes are an investment rather than an expenditure. Therefore, for a sound and effective implementation and sustainability of **biogas** programmes, a substantial percentage of the total funds must be earmarked for support of different level of trainings as well as exchange programmes for local craftsmen, technicians, engineers, extension workers, managers, trainers, scientists etc. within the regional and global network.

17) China and India have been organizing international training courses on **biogas** for different countries. Other countries may also host this kind of training courses. Multinational and bilateral aid agencies should support these activities so that a larger number of developing countries could avail of these facilities.

18) Post-installation services of **biogas** plants should constitute an important component of the national **biogas** programme, and substantial funds should be earmarked for this purpose.

19) Governments may arrange their energy taxation systems in such a way as to give preference to the utilization of **biogas** technology.

20) The large-scale, high-tech **biogas** systems based on waste water, agricultural and forestry residues, municipal solid waste etc. should also form an integral component of national programmes.

Social issues

21) **Biogas** programmes must provide, from the very beginning also the means of awareness building, training of women (including technical training), social follow-up and participation of the target group. Female staff and integrated programmes are essential in order to avoid social disparity.

22) The awareness building under varying socio-economic conditions is as crucial for the success as any other aspect involved. In order to ensure the success of **biogas** programmes, the relevant socio-economic and cultural situation of the area involved has to be analyzed carefully. The programme should be shaped accordingly. Special emphasis should be given to creation of awareness. Development and use of locally available physical and manpower resources in decision-making, participation, construction, maintenance and running of the programme are important inputs. The programme needs to be regularly followed-up in relation to sociological impact.

23) **Biogas** technology as it stands today is not expected to correct existing socio-economic disparity. But the fact that the whole society gains by **biogas** technology in the long run in terms of sustainable development, the programme should be implemented as an integral part of the total development package, although it more likely serves the better-off part of society.

24) Since women are the major users of **biogas** they are affected by any **biogas** programme. Special emphasis has to be given to their participation in all aspects. To ensure this female workers including women technicians should get a priority in staffing.

25) Training in operation, maintenance and installation has to be given directly to the individuals actually operating the plants and using the outputs. Even in situations where women are normally not operating technical equipment, strong emphasis has to be given to their training in every respect, if they are the operators and/or users.

Evaluation

26) For the necessary evaluation of the implementation process of **biogas** technologies, structural and sufficient financial resources should be made available to ensure the development and application of adequate instruments for regular monitoring and evaluation systems.

27) Government and/or sponsoring organizations should formulate clear objectives, guidelines, format of scientific evaluation of **biogas** extension programmes and **biogas** plants within the planning process.

28) Evaluation parameters should take into account technical performance, economical, social and environmental benefits, and the impact of **biogas** programmes on the weaker section of society, and especially women, since they are the main beneficiaries and users of **biogas** plants.

29) Objective evaluation should be a participatory activity involving government, sponsors, implementing agencies, financial institutions and users and professionals with acknowledged experience in socio-economic, technical and environmental fields relevant to **biogas** technology.

30) Evaluation should cater for the needs and dissemination of information for all involved institutions and individuals, e.g. governments, sponsors, agencies, users and financial institutions in order that they make necessary decisions for taking effective action.

31) In regard to bias of control and diagnostic analysis in evaluation the approach should respect the principles of participation, objectivity, and comprehensive complete information.

Catchword

Biogas

What exactly is "**biogas** extension"?

The stimuli resulting from the GTZ/GATE **Biogas** Extension Programme were successful: as regards the principles of dissemination, there is now a consensus among those responsible in the "**biogas** countries".

Strategy

- The reasons for promoting **biogas** technology may differ depending on regional conditions, and dissemination strategies must take this into account. Even though, in many countries, the emphasis may be on generating energy for cooking and lighting in rural households, the principal reasons are erosion protection (e.g. in India), organic fertilizer production (e.g. in the People's Republic of China), and water protection (e.g. on Barbados and in the FRO).

- It is not possible to reach the poorest sectors of the population directly, because a minimum of 3 - 4 head of cattle or 8 -10 pigs are necessary to supply one family with **biogas**. Since this has been recognized, the technology should not be „burdened" with tasks it cannot fulfil. This does not mean that **biogas** dissemination activities cannot be backed up with appropriate programmes.

- The scale of back-up programmes such as promoting awareness, provision of information, motivation, training, agricultural advice and research must be adequate at all levels (users, artisans, planners and advisory services). This is the mistake most often made in individual projects. Know-how in **biogas** technology now exists in all countries. The emphasis in the **Biogas** Extension Programme is hence shifting towards promoting such back-up programmes and new developments.
- The technology, which has in the meantime become highly dependable, can be made even cheaper by further research and development work in the various countries. Some progress is already detectable. However, there are still some problems, e.g. in the development of low-cost lagoon digesters, in solid state fermentation methods and in the development of full-stirred reactors.
- Generally speaking, up to now preference in dissemination is given to designs with a high craft input, as opposed to prefabricated models.

Technology and agriculture

- The fairly recent development of anaerobic fermentation favours agro-industrial and domestic waste and sewage disposal as a complement to rural **biogas** production. The emphasis here is on maximizing acceleration of the reaction in the digesting chambers rather than on maximizing **biogas** output. There is a considerable technical development potential here.
- The key factor dictating whether or not a **biogas** plant operates economically is the type of alternative energy available.
- If digestion takes place in the alkaline range there is no odour nuisance. Pathogens lose their virulence, and indeed their viability, as a result of the action of micro-organisms and the duration of exposure to anaerobic conditions. Only the essential anaerobic bacteria possess antibiotic forces. It is practically ruled out that the digested dung will include weed seeds. Digestion substantially reduces the number of coliform bacteria. Cooking with **biogas** often means that, for the very first time, kitchens are smoke-free, and thus reduces the incidence of ophthalmic disease among women.
- Where dung has to be collected, operating a **biogas** plant often results in a considerable additional burden of work for farmers; only very few farmers are willing to accept this. Therefore, intensive animal husbandry, with night stabling at least, is a precondition of **biogas** production.
- Where **biogas** technology is regarded as a means of disposal and/or a source of fertilizer, economy is assured. This is influenced by the relevant overall structural conditions. The positive impact of the fertilizer produced is often more positive than that of the **biogas** generated. The technology has proved to be economically worthwhile whenever extraneous costs and benefits, and environmental effects have been taken into account. This is the reason for the willingness of many governments to make funds available for research, dissemination programmes, loans and subsidies.
- **Biogas** appliances, such as burners, lamps and engines, are in production. Kenya, Brazil, Italy, India and the People's Republic of China already export series-produced **biogas** appliances. Small-scale local production and the exchange of experience in this area are both capable of being expanded.

Diffusion of biogas technology: strategies and policies

by T. K. Moulik

Of the NRSE technologies currently being promoted and considered in a large number of countries, the **biogas** programme is the largest, in terms of scale of development, operations and covering. Among the NRSE technologies, **biogas** has been included as a national project in the economic plans of countries such as India and China. This implies that this technology is not only highly relevant to

the problem of meeting people's energy and environmental needs, but also that fairly standard designs have been developed which have been demonstrated successfully under field conditions.

The **biogas** technology under review here satisfies three major requirements for a technology to be judged ready for mass-scale diffusion or commercialization:

- a) marketability, meaning that there is considerable demand and a potential share of the market for the technology, and that it can be supplied;
- b) technical feasibility, meaning that the technology can be readily mass-produced to satisfy a wide range of demands at low cost;
- c) the ability to manufacture or use the technology at a high level of profitability, both financial and economic.

Target: 0.2 million units per annum

In this context, the case of India may be instructive. In 1974 -75, the number of individual family-size **biogas** plants (2 m³ - 6 m³) in India totalled 10,710. By 1986-87, this figure had reached 836,198 - a more than 80-fold "quantum leap" within 12 years. Given the specific requirements of feedstock supply (mainly cattle dung) for family size **biogas** plants (at least 3-5 cattle), the potential market or user target group in India is about 25 million rural households. The National **Biogas** Development Programme (NPBD) is essentially aimed at this market segment for deployment of the technology through an organized delivery system. The current planned diffusion target for **biogas** technology is 0.2 million units per annum. The diffusion strategy for **biogas** technology in India can be clearly understood by identifying the landmarks in the history of the programme (see Table 1).

It should be noted in Table 1 that while the period up to the 1960s might be termed a critical period for the indigenous development of **biogas** plant design and limited demonstration projects, the 1970s should be termed the growth period as regards planned R & D efforts and the mass deployment programme. In the wake of the fuel crisis of the 1970s, the Fuel Policy Committee of the government of India strongly recommended the popularization of **biogas** plants as alternative sources of energy. The successful development of the vastly cheaper Janata Model (fixed dome, Chinese type) during this time made it easier to raise the target figures for plant diffusion, with concomitant commitment of financial, physical and manpower resources by the government. However, in addition to the mass diffusion programme, inaugurated in 1975, the R&D effort in relevant areas and the critically important demonstration and training programme are continuing (see Table 1).

The Indian **Biogas** Diffusion Programme

Apart from providing an alternative energy supply based on locally available resources, the Indian **Biogas** Diffusion Programme is also intended to bring other benefits, e.g. enriched manure, alternative, profitable utilization of available biomass, reduced deforestation and soil erosion, and an improvement in public health and hygiene.

Until the 1970s, the Indian **Biogas** Diffusion Programme was relatively centralized and, apart from KVIC, operated through normal government channels. During this period, the initiative in and administration of the **Biogas** Programme was largely a top-down process in which the government departments concerned (KVIC up to the 1970s, the Agriculture Ministry and DST in the 1970s and 1980s, and DNES from the 1980s onwards) took the lead in and the responsibility for implementation. In other words, the emphasis during this period was on mass transfer of technology to the target group from an external system (e.g. research institutions, experimental stations, government departments) through a network of official and non-official agencies.

In an official administration system such as the one which operates in India, a network of institutional and administrative units would be needed at different operational levels, from national to state/district/block/village level. As mentioned above, until 1973-74 a single-model/single-agency approach was used, with KVIC as the only focal institution. KVIC had its network of recognized and affiliated institutions throughout the country, and this was utilized to deploy **biogas** technology.

By the late 1970s, when **biogas** became part of the national Plan, the institutional arrangements had, of necessity, gradually become relatively more structured on the one hand and broad-based on the other. KVIC's monopoly was replaced by a multi-model/multi-agency approach, in which a large number of official and non-official agencies were involved in implementing the programme under a common fiscal arrangement as regards subsidies and cash incentives.

Just as the subsidies were gradually increased to attract more customers, in line with the drive to meet higher targets, a programme was launched in 1970 to give cash incentives to private promoters for attracting customers at local village/block level, to pay for the cost of turn-key construction by private masons or entrepreneurs, and to provide easy bank loan facilities. In the early 1980s, when the NPBD was launched and the Janata model was introduced on a large scale, it became necessary to institute a systematic training programme for masons. This was perhaps the first organized attempt to provide technical training at village level, thereby involving the potential users directly.

In recent years, a number of organizational strategies aimed at effective diffusion of **biogas** technology have been initiated in India. First, in order to exploit the demonstration effect to the full and to reduce administrative costs, there has been a plan for intensive deployment in clusters of villages (cluster approach), as opposed to sparse deployment over a large number of widely-dispersed villages. Second, in order to enlarge the potential market, a programme designed to popularize medium-size community or group **biogas** plant has been planned. Third, as a part of the popularization programme, manure production in **biogas** plants has received critical attention as an equally important objective. Fourth, in recent years there has been an intensive publicity campaign, using all kinds of media and methods, to promote **biogas** technology, this has increased awareness of **biogas** technology and of the national programme among the Indian public. Finally, it has been felt increasingly necessary to integrate the Indian **Biogas** Programme with other ongoing rural development activities, and this has necessarily resulted in close collaboration with and assistance from various government departments concerned with development and NGOs.

Table 1: Landmarks in the historical evolution of the Indian **Biogas Programme**

Time Period	Steps with Basic Thrust
Early 20th century (1900 - 1920)	Earliest documented attempts to develop biogas technology
1938, at Indian Agricultural Research Institute, Delhi	Serious attempt to develop indigenous technology
1940s - 1950s, at various	Acceleration in indigenous research research institutes
1951	First standardized floating-dome KVIC model developed by J. J. Patel
1954	Floating-dome design improved by J. J. Patel
1955: 500 KVIC model plants	First government-supported demonstration programmes installed with govt. support, but subsequently fail due to design defects
1960: first government-sponsored	KVIC adopts biogas programme as one of its regular ongoing programme development programmes

1960s	Setting up of Biogas Research Station at Ajitmal, UP, prompts renewed	interest in biogas research at various national research institutions
1970: fossil fuel energy crisis	Biogas recommended as alternative energy source by Fuel Policy	Committee
1975 - 80: national mass promotion	Agriculture Ministry adopts biogas as major programme for diffusion,	
programme with emphasis on	promoting multi-agency and multi-design projects	
cheaper Janata model, supported by		
and involving both Govt. and NGOs,		
including KVIC		
1975 - 80	Govt. of India Dept. of Science and Technology institutes All-India	Coordinated Biogas Research and Experiments through network of

		national organizations and institutions
1981: planned target of 0.4 million	Biogas included in Prime Minister's 20-point programme. National	
plants in remaining 4 years of 6th Plan	Project for Biogas Development (NPBD) launched with enhanced target	
1981	Creation of Commission of Additional Sources of Energy, organizational	
interface for overall policy review and coordination of renewable energy programme		
1982	Department of Non-Conventional Energy Sources set up by Ministry of technologies	Energy: government organization with sole implementing and administrative responsibility for promotion and R&D of NRSE
1984 - 85	Higher target planned: crash programme with target of 0.15 millions	plants plus the proposed 1.5 million plants during 7th Plan period.
1985 - 86	Creation of state-level specific and exclusive nodal agencies to implement renewable energy programme; network of official organization	and NGOs at state level involved in deploying biogas technologies

Approaches to diffusion

There are basically three diffusion strategies:

1. the „top-down" strategy, where centralized agencies are entrusted with the task;
2. the "bottom-up" strategy, where individual and voluntary initiative is harnessed for the effort; and
3. the "franchising" strategy, where the advantages of centralized agencies are coupled to the strengths of entrepreneurship.

The Indian **Biogas** Programme predominantly uses the first and third strategies, and to a lesser extent (though in recent years increasingly) the second strategy. Thus, it is a mix of three strategies. Viewed as an approach to adoption of a technology, diffusion strategies can be classified in 5 education approaches. As illustrated below, India's **biogas** diffusion strategies use a mix of these 5 education approaches, with varying degrees of emphasis.

Motivation approach

In recent years, this approach has been used increasingly in India. A number of video and TV clips, with cinema-type social storylines focussing mainly on the introduction of NRSE technologies in rural areas, have been produced and are screened all over India. There is also a van containing the miniature mobile exhibition of NRSE technologies, which accompanies these video or standard 16 mm film shows. There is hardly any exhibition or big fair in India at which NRSE technologies are not on show, often together with the van and the cinema show. Even comic books and puzzles

have been produced, and simple rhymes composed, for the purposes of NRSE education. Attempts are also being made to include NRSE technologies in the curricula of primary and secondary education. Permanent "energy parks" have been established in several places, where all the NRSE technologies are on display and can be inspected by visitors. Finally, the importance of the motivation approach in the **Biogas** Programme is reflected in the fact that local village-level „motivators" are chosen and given cash incentives on the basis of their performance. Other, similar methods of stimulating additional motivation among promoters of the diffusion programme include annual inter-state and state competitions, and well-publicized prizes for both qualitative and quantitative performance.

Creative approach

Apart from training camps, workshops and seminars, where ideas and experience are shared freely, there is hardly any planning behind this approach. In fact, of the five approaches, it is probably the lowest-ranking in terms of planned emphasis. It should be noted, however, that many NGOs involved in the **biogas** diffusion programme often use this approach in small discussion groups involving the beneficiaries, to identify "felt needs" within the framework of existing socioeconomic conditions and development efforts.

Analytical approach

The camps regularly organized all over the country for training masons are perhaps the best example of this approach being utilized while the masons are being trained and **biogas** plants are actually being built. The villagers, gathered in camp for two to three weeks, are thus given an opportunity to understand technological aspects more rationally and analytically.

Planning approach

This is perhaps the most important educational approach used in **biogas** diffusion strategies. The motto, strongly emphasized, is "seeing is believing". The prominence given to demonstration projects or plants in the strategy is obvious. Potential beneficiaries are encouraged to successful demonstration plants or a "showcase" in field conditions. In addition to training camps, implementing agencies also organize field days.

Didactic approach

This is undoubtedly the most commonly used approach in India's **biogas** diffusion strategies. As **biogas** technology is now mature and is available in a widely acceptable and standardized form, together with a sufficient number of successful demonstration plants, the well-known "shotgun

approach" is used. Essentially, this approach assumes that "the technology is familiar and so means of inducing user acceptance should be devised". The delivery system, in terms of implementing organizations, financial, physical and manpower infrastructure supports, clearly shows the predominance of this approach. Also, taking the view that the potential target group is ready for technical information, construction and user's manuals for **biogas** plants have been made available.

On closer study, it is clear that the **biogas** diffusion programme is subject to a host of socio-economic constraints operating at both macro and micro level, as well as economic constraints at both these levels.

Institutional support

The central nodal agency, DNES, has sponsored and supported some 60 R&D projects covering various aspects of **biogas** technology, at national laboratories, the Indian Institute of Technologies, and universities, including agricultural universities. Considerable progress has been made in ongoing research projects, as outlined in the DNES 1987-88 Annual Report. However, most of the research results are currently at the field pilot testing stage, rather than ready for use in the mass diffusion programme, e. g. **biogas** generated from water hyacinth and distillery waste. Many of the research institutes are helping to popularize technologies in the surrounding demonstration areas.

It is only since the 1980s, when the **biogas** diffusion programme was greatly expanded, that a number of well-known commercial manufacturers in India have started to show some interest, no doubt in view of the large potential market. Many of them have established links with DNES and other R&D organizations on their own initiative. The connection thus developed between R&D organizations/DNES on the one hand and the commercial sector on the other is likely to be strengthened further as the programme continues to expand.

Policy directives

The Government of India is committed to the National **Biogas** Programme in its planning, including the necessary financial and infrastructural outlay. The **biogas** programme has been envisaged with the policy objective not only of providing energy at local level, using agricultural residues and manure, but also of helping directly and indirectly to save forests, create jobs, and improve the environment, health and hygiene, social and women's welfare, biofertilizer production, agriculture, drinking water etc. In fact, the **biogas** production process is one with multi-product output for a variety of end-uses, in which the byproducts of a primary production process (agricultural residues and cattle dung) become an input for producing energy and fertilizer (digested slurry). This integrated aspect of **biogas** technology is its true strength, and the reason why it is supported by government policy and programme commitment.

While policy directives relating to the relevance of **biogas** technology in meeting cooking needs in rural areas (for which electricity and fossil fuel derivatives are not realistic alternatives in the near future) and in providing enriched manure are clearly in harmony with the objectives, the subsidized prices of oil, kerosene, diesel and electricity also seem competitive and are often unfavourable to the **biogas** system. This is particularly true where **biogas** is intended to be used for pumping water, lighting, or generating electricity. Since the total potential market for **biogas** includes only a percentage of rural households, and since there is too much emphasis on the need for cooking energy as the most urgent application of **biogas** technology, the problems of competition with other fossil fuel energy sources are compounded to the extent that the economics of **biogas** technology are unfavourably compared.

Table 2: Statewise number of family type **biogas plants installed during the period 1981-82 to 1988-89 under N.P.B.D.**

Sr.	States/Union Territories	No. of plants installed
No.		
1.	Andhra Pradesh	86,141
2.	Arunachal Pradesh	9
3.	Assam	6,980
4.	Bihar	53,863
5.	Goa (plus Daman & Diu)	1,170
6.	Gujarat	76,603
7.	Haryana	16,098
8.	Himachal Pradesh	15,736
9.	Jammu & Kashmir	651
10.	Karnataka	58,093
11.	Kerala	19,746
12.	Madhya Pradesh	32,901
13.	Maharashtra	320,598
14.	Manipur	148
15.	Maghalaya	96
16.	Mizoram	486
17.	Nagaland	75
18.	Orissa	31,223
19.	Punjab	12,725
20.	Rajasthan	31,121
21.	Sikkim	201
22.	Tamilnadu	112,469
23.	Tripura	39
24.	Uttar Pradesh	167,101

25.	West Bengal	30,077
26.	Andaman & Nicobar	87
27.	Chandigarh	72
28.	Dadra & Nagar Haveli	123
29.	Delhi	543
30.	Pondicherry	426
Total		1,075,601

Table 3: Statewise number of family type biogas plants installed up to 31st March, 1389

Sr.	States/Union Territories	No. of plants installed
No.		
1.	Andrah Pradesh	88,998
2.	Arunachal Pradesh	9
3.	Assam	7,055
4.	Bihar	63,689
5.	Goa	1,170
6.	Gujarat	85,788
7.	Haryana	26,375
8.	Himachal Pradesh	15,736
9.	Jammu & Kashmir	651
10.	Karnataka	65,891
11.	Kerala	21,333
12.	Madhya Pradesh	36,553
13.	Maharashtra	332,531
14.	Manipur	148
15.	Meghalaya	96
16.	Mizoram	486

17.	Nagaland	75
18.	Orissa	31,845
19.	Punjab	18,337
20.	Rajasthan	31,530
21.	Sikkim	201
22.	Tamilnadu	119,034
23.	Tripura	39
24.	Uttar Pradesh	194,984
25.	West Bengal	32,490
26.	Andaman & Nicobar	87
27.	Chandigarh	72
28.	Dadra & Nagar Haveli	124
29.	Delhi	594
30.	Pondicherry	426
Total		1,176,344

Abstract

The Indian **Biogas** Diffusion Programme is characterized by a multi-model/multi-organization approach. Numerous participants in the programme at various levels are of critical importance, including scientists and R&D organizations, state-level nodal agencies, district, block and village-level functionaries, a large number of NGOs and a number of commercial manufacturers, as well as private entrepreneurs and masons. A study of the diffusion of household **biogas** technology reveals a number of socioeconomic and technological constraints, while at the same time indicating the importance of R&D and R&D institutions.

Resume

Le programme indien d'expansion du biogaz est caractérisé par la diversité des approches et celle des organisations y participant. Par ailleurs apportent également leur participation: organisations scientifiques et organisations pour la Recherche et le Développement (R&D), organisations ayant une fonction de regroupement au niveau national, fonctionnaires de l'échelon régional à l'échelon local, moult organisations non gouvernementales, représentants du secteur industriel, entreprises privées maçons. La présente étude sur l'expansion de la technologie du biogaz dans le secteur domestique met en évidence une série de facteurs limitatifs d'ordre socio - économique et technologique. Mais elle montre aussi l'importance des efforts entrepris par R&D et celle des institutions R&D.

Extracto

El programa indio de difusión del **biogas** se caracteriza por el hecho de que se siguen diversas formas de difusión y por la participación en la misma de diversas organizaciones. Participan, edemas, organizaciones científicas y de investigación y desarrollo, organizaciones con funciones sectoriales a nivel es ta tal, funcionarios de la administración regional y local, un gran numero de organizaciones no gubernamentales, representantes del sector industrial, empresarios privados y alba iles. El presente estudio sobre la difusión de la tecnología del **biogas** en los hogares privados descubre une serie de factores limitadores socioeconomicos y tecnológicos, pero muestra también la importancia de actividades e instituciones de investigación y desarrollo.

Biogas - An appropriate technology for third world countries

by Udo Theilen

People who live in places where there are no energy resources to satisfy basic needs, especially for cooking, will move on and look for other possibilities, usually in the slum areas of towns and cities. The shortage of energy to meet basic needs is a problem encountered exclusively in Third World countries. The catchword "fuelwood crisis" is a fitting description.

Fuelwood (and dry manure) is the energy source for meeting basic needs in Third World countries, at least in rural areas. Anyone who wants to help solve the fuelwood crisis - which in the long term will affect all countries (and not just the Third World) via the global ecosystem - must look for ways and means of replacing fuelwood with alternative sources of energy.

Small, simple **biogas** plants could be an appropriate substitute for fuelwood as an energy source for cooking. So far, **biogas** technology has not been widely used for this purpose. But in remote rural regions, at least, it is a low-cost alternative to the traditionally used fuels, namely liquid gas or electricity.

These days, most people are acquainted with the term "**biogas**". What is less well known is how a **biogas** plant works, and only very few people realize how much energy even a "simple" **biogas** plant can generate. In order to help rectify this lack of information, this article reviews the main aspects of **biogas** technology.

Technical aspects

The digesting chamber is the heart of the plant. Here, during the hydraulic retention time (20 - 90 days), the organic matter which the fresh manure contains is decomposed by various species of anaerobic bacteria, i. e. bacteria that live and grow in the absence of molecular oxygen. Practically all types of faecal matter, including human excrement, are suitable for anaerobic fermentation. Kitchen waste can also be added to it. However, one should be cautious about adding harvest and bedding residues such as leaves, maize straw, hay etc.

As in every biochemical reaction, the temperature plays a major role in anaerobic fermentation. The ideal temperature is 30 - 35 ° C, but simple **biogas** plants work quite well from about 20°C upwards. In cooler regions the plant has to be thermally insulated and heated to achieve adequate efficiency, i. e. adequate production of gas and fertilizer. In other words, in such regions it is not advisable to build **biogas** plants of the Indian type, or comparably simple plants.

The catabolic products of anaerobic fermentation are **biogas** and biofertilizer. **Biogas** consists of about 60% methane (CH₄) and 40% carbon dioxide (CO₂). Like every other gas, **biogas** is a fairly universal fuel that can be used for cooking, lighting, powering, refrigerators and radiant heaters, and to run converted petrol or diesel engines to generate electricity, etc.

Biofertilizer is an organic fertilizer with a higher fertilizing value than fresh manure, because it is

enriched with nitrogen during anaerobic fermentation. In the long term, the organic fertilizer produced in a **biogas** plant enables the user to improve the structure of his soil, increase yields and thus do without mineral fertilizer. Biofertilizer is also more "hygienic" than fresh manure because anaerobic fermentation destroys, if not all, at least a large percentage of many pathogens and parasites (typhus, paratyphus, cholera, dysentery bacteria, hookworms, Bilharzia, liver fluke etc.). In particular, the reinfection cycle of diarrhoeic diseases responsible for the high rate of infant mortality in Third World countries could be broken if every **biogas** plant had a latrine connected to it (although in some countries there are cultural obstacles to this).

Fig. 1: Individual use of energy

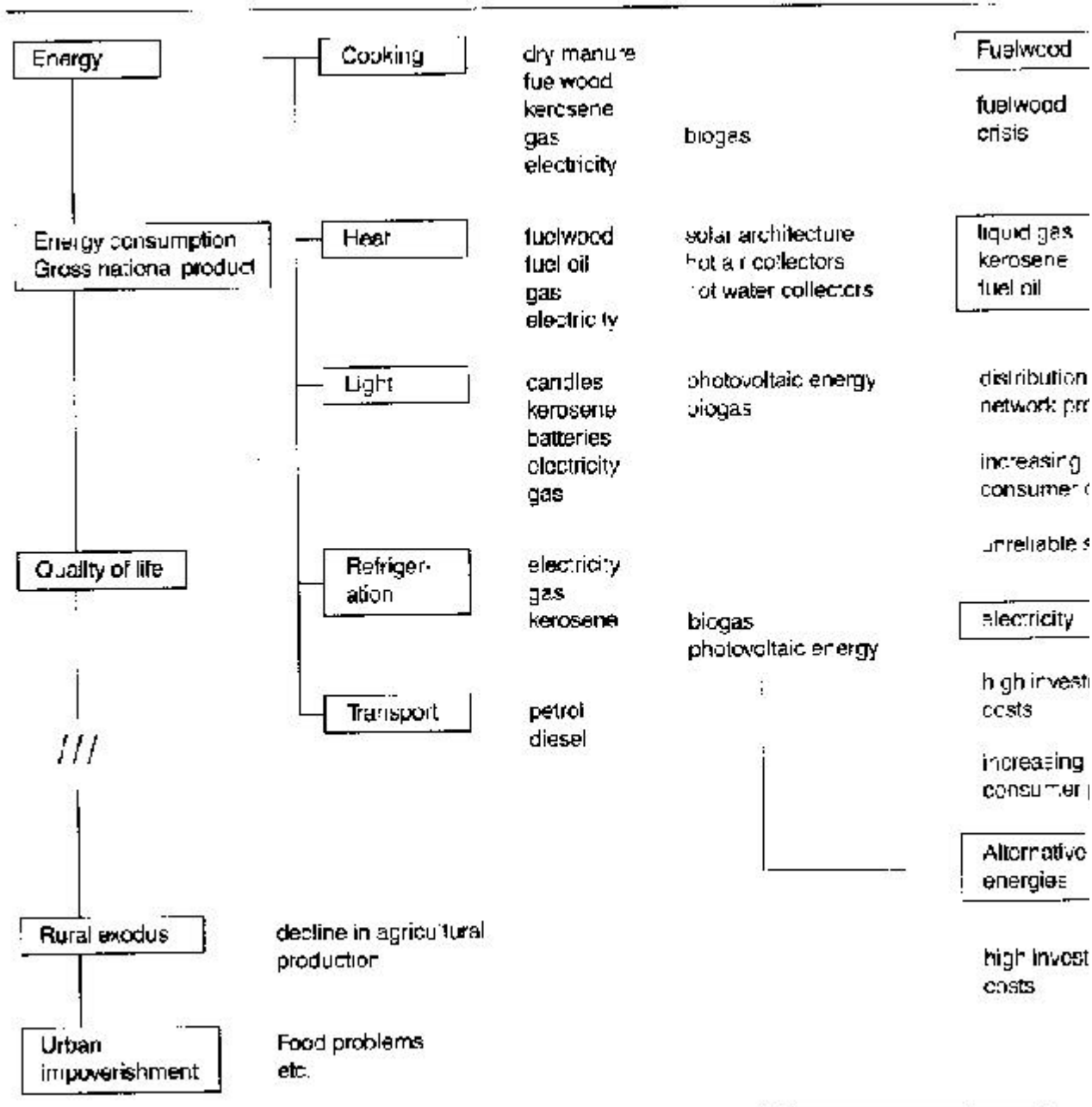

Figure

Table 1: Energy requirements of a family of five

Energy	Cooking	Lighting	Refrigerator
content	2 burners	4 bulbs	230 l
	8 hours/day	4 hours/day	

Consumption	per day / year	per day / year	per day / year
Dry manure	2.5 kWh/kg	26.0 kg	9.5 t
Fuelwood	5.5 kWh/kg	12.9 kg	4.4 t
Charcoal	8.5 kWh/kg	3.7 kg	1.4 t

Petrol	8.5 kWh/l	5.6 l	2000 l	0.5 l	100 l
Diesel	12.0 kWh/l	3.5 l	1300 l		
Kerosene		8.9 kWh/l			

Electricity	1.0 kWh	11.8 kWh	4300 kWh	1.0 kWh	350 kWh		
	5.0	1825 kWh					
Natural gas	9.4 kWh/m ³	1.5 m ³	550 m ³				
Liquid gas	19.9 kWh/kg	0.5 kg	19 bt.	0.3 kg	11 bt.	0.5 kg	19 bt.
Biogas	6.0 kWh/m ³	2.4 m ³	880 m ³	1.9 m ³	770 m ³	2.4 m ³	880 m ³

Source: data in publications	h - hour	(1) equivalent to approx.110 kg fresh manure
manufacturers' data	d - day	per day (8 cows)
author's own calculations		(2) 10 kg propane gas bottles

What can a **biogas** plant do?

To answer this question correctly it is first necessary to analyze the energy needs of a family, irrespective of whether, in Third World countries, these needs are actually satisfied.

Table 1 summarizes the energy needs of a family of five, classified under the headings Cooking, Lighting and Refrigeration, and according to the various fuels used, i.e. dry manure, fuelwood, petrol, electricity, gas etc. It should be noted that the many publications on this subject sometimes contradict one another, so the figures quoted are averages. The fact that electricity can be generated with petrol/diesel or liquid gas/**biogas** was ignored, as this technology is generally out of the question for a rural family farm, owing to the high investment and maintenance costs.

It is clear from Table 1 that with the traditional fuels - dry manure, fuelwood and charcoal - it is only possible to satisfy the basic need cooking. The more sophisticated needs, i. e. lighting, heating and refrigeration, can practically only be met with electricity (which is usually not available) and liquid gas/**biogas**.

As regards the option "**biogas**", it is first of all necessary to establish how big a **biogas** plant must be to satisfy the energy requirements of a family of five and how much biomass (fresh manure) is needed to run the plant. As mentioned above, the efficiency of a **biogas** plant depends to a large extent on the local soil temperature. Two realistic variants are presented in Table 2 in order to illustrate this:

- A **biogas** plant in an ideal, tropical environment, with soil temperatures around 30 ° C.

This plant has a relatively high efficiency of 0.6, i.e., it produces 0.6 cu.m. of **biogas** daily per cubic metre of digestion chamber volume.

- A **biogas** plant in a temperate climatic zone, with soil temperatures around 20° C.

This plant has a substantially lower efficiency of 0.25, i.e., it produces only 0.25 cu.m. of **biogas** daily per cubic metre of digestion chamber volume. Logically, this plant has to be larger to produce the same amount of energy.

One thing is very clear from Table 2, namely that **biogas** technology is not a technology for the poorest of the poor; because in order to satisfy energy requirements for cooking and lighting the owner of a **biogas** plant should also own at least 7 to 11 cows. The investment costs, i. e. the cost of building the plant, also have to be taken into account (see below).

A further interesting aspect should be emphasized: depending on climatic zone and type of husbandry, the fresh manure from 4 - 6 cows is sufficient to meet the basic need cooking. To meet the same energy requirement for cooking with dry manure, the dung from 8 cows is needed (Table 1).

Corral husbandry was included in the two examples to show that stabling is not an essential precondition for using **biogas** technology. However, if a **biogas** plant owner keeps his livestock in corrals he has to accept the extra work involved, namely collecting the fresh manure in buckets and carrying it to the mixing chamber.

But owners of **biogas** plants are in any case forced to keep their livestock and grow the fodder close to the house, since otherwise no fresh manure is available as feed material for the plant. This is extremely important with regard to integration of **biogas** technology into existing production systems.

Table 2: **Biogas** plants which meet the energy needs of a family of five

Biogas	Cooking	Lighting	Refrigerator		Total	
2.4 m ³ /d	1.9 m ³ /d	2.4 m ³ /d	6.7 m ³ d	(40 kWh)		
Plant inrequired biogas tropical zones plant volume			4.0 m ³	3.2 m ³	4.0 m ³	12m ³
(30 °C)	daily input needed when keeping livestock in					
sheds	4 cows	3 cows	4 cows	11 cows		
@= 40 d			faecal matter			
+ urine	75 kg/d	60 kg	75 kg/d	210 kg/d		
# = 0.6	water	25 kg/d	20 kg	25 kg/d	70 kg/d	
corrals dry faecal	6 cows	5 cows	6 cows	17 cows		
matter	25 kg/d	20 kg	25 kg/d	70 kg/d		
water	75 kg/d	60 kg	75 kg/d	210 kg/d		
Plant in required biogas						
temperate zones	plant volume	9.6 m ³	795 m ³	9.6 m ³	27m ³	
(20 °C)	daily input needed when keeping livestock in sheds					
5 cows	4 cows	5 cows	14 cows			
@= 80 d			faecal matter			
+ urine	90 kg/d	70 kg/d	90 kg/d	250 kg/d		
# = 0.25	water	30 kg/d	25 kg/d	30 kg/d	85 kg/d	
corrals dry	7 cows	6 cows	7 cows	20		

faecal				cows
matter	30 kg/d	20 kg/d	30 kg/d	80 kg/d
water	90 kg/d	75 kg/d	90 kg/d	255 kg/d
Calculation bases:	Dairy cows	200 kg live weight,		
faecal matter + urine	9% of l. w. per day, 11 % dry matter			
dry faecal matter	2% of l. w. per day, 30% dry matter			
	@= hydraulic retention time in days			
	# = efficiency of biogas plant			

How much do **biogas** plants cost?

Simple **biogas** plants are relatively primitive constructions; they have no moving parts. If solidly built they can certainly be expected to last 20 years or more. Construction costs are generally estimated at about US\$ 100 per cubic metre of plant volume, including the mixing chamber, outlet tank, gas storage and gas pipings. It is difficult to compare costs in Third World countries because exchange rates are often fixed arbitrarily and in many cases the cost of building materials is subsidized. In general it may be said that the construction costs per cubic metre of installed volume decrease with increasing plant volume.

Compared to other renewable energy systems, **biogas** technology is relatively cheap, even if the production of fertilizer is ignored (Table 3). Nevertheless, the economy balance of many **biogas** plants is negative, especially in countries where conventional fuels and/or mineral fertilizer are subsidized. Any assessment of **biogas** plants should therefore include not only current financial investment and return factors, but also the longer-term factors which cannot be expressed in monetary terms and are not quantifiable, such as

- the global economic appraisal (long-term energy planning, live-stock farming systems, ecosystem etc.);
- the socio-cultural aspects (reliability and autonomy of supply, quality of life, training)
- improved health etc.

Table 3: Investment costs of different RE systems in Bolivia

Type of energy per unit		Investment cost for 40 kWh	
Biogas	gas	US \$ 100/m ³	US \$ 1,200
Solar collectors	hot water	US \$ 1 70/m ²	US \$ 2,900
Micro-hydropower	electricity	US \$ 1 800/kW	US \$ 72,000
	220 V AC		
Wind generators	electricity	US \$ 1500/kW	US \$ 60,000
	220 V AC		
Photovoltaic	electricity	US \$ 11800/kW	US \$ 470,000
	12 V DC		
	220 V AC		

Integration of **biogas** technology into the production system

The form of livestock farming practised most commonly in the Third World is extensive, with all its inherent disadvantages (Fig. 2). In many areas, however, the available resources are sufficient to permit extensive livestock farming without any difficulty. However, where the resources are in short supply in relation to population density, extensive livestock farming places an additional strain on the ecosystem, and in the long term a switch to intensive methods is the only way of avoiding its collapse (catchword: fuelwood crisis).

The massive consumption of dry manure (9.5 t per year and family) and fuelwood (4.4 t per year and family) can only be avoided by satisfying the basic need cooking with other fuels. As indicated in Table 1, electricity and gas are the only viable options.

As an integrated system which produces both fertilizer and energy, **biogas** technology could (as one of several systems) replace the use of dry manure and fuelwood, and at the same time encourage farmers to switch to an intensive form of livestock farming, especially if it is introduced together with other technologies which increase soil productivity (irrigation systems, improved soil management etc.) (Fig. 3).

However, **biogas** technology can only help bring about a substantial reduction in the use of fuelwood if it is diffused on a massive scale in a given country or region. As a rule, such efforts run into several problems:

1. It is not widely recognized by those responsible in Third World countries that renewable energy sources can be a solution to certain structural problems, especially in extremely remote rural regions. As a result, only little importance is attached to these technologies and they are hardly taken into account in longer-term regional development plans. However, the global trend towards increased use of renewable energy sources is beginning to influence this attitude.
2. Many of those who make up the actual target group for **biogas** technology, i. e. medium-sized family farms, do not have the necessary capital to invest in building a **biogas** plant. Backup measures are necessary in the context of medium- to longer-term regional planning, but as a rule no provision

is made for them by either donor or recipient countries.

3. There are problems involved in introducing a new technology, and especially one which necessitates changing the entire production system, because change is always a source of anxieties, both rational and irrational. Logically, therefore, the introduction of new technologies in farming systems should always be linked to agricultural counselling. An alternative, far less problematic approach is first to press ahead with the introduction of **biogas** technology on farms (including larger ones) which have an existing infrastructure with intensive animal husbandry, and subsequently to exploit the effect of the example thus created.

4. While the technology used almost exclusively today in Third World countries, i. e. fixed brick dome and floating-drum plants, is thoroughly sound and well-proven, it is also an obstacle to the rapid diffusion of **biogas** technology, because it takes a relatively long time (3 - 5 week) to build a plant. It should be examined whether the use of "modern" building methods involving shorter construction times and using standardized components, i. e. a modular system, would make better overall economic sense.

Fig. 2: Consequences of extensive livestock farming

Extensive livestock farming (free-range, herded)		
low return	mainly self-sufficient farms	low income
no systematic use of fertilizer	low crop yield	use of mineral fertilizer
	pathogens widespread	reinfection cycle
	high infant mortality	
	livestock in poor health	
no cultivation of fodder	overgrazing	erosion
	recultivation measures endangered	
external energy supply	use of dry manure	no feedback of organic material into soil
	fuelwood	ecology endangered
	health hazard from smoke(2)	
	petrol/diesel	relatively costly and complex equipment
	electricity	high installation costs
	current energy costs	
	liquid gas	economically acceptable,

		but low reliability
	(poor infrastructure, strikes,	
	rainy seasons etc.)	

Fig 3: Consequences of intensive livestock farming with a biogas plant

Intensive livestock farming (in cattle sheds or corrals)		
higher return	link to market	higher income
systematic use of fertilizer	improved crop yield	little or no mineral fertilizer needed
	no dissemination of pathogens	reinfection cycle broken
	lower infant mortality	
	improved health of livestock	
cultivation of fodder	no overgrazing	less erosion
	recultivation possible	
internal energy supply (<u>biogas</u>)	no dry manure or	risk to ecology reduced
	fuelwood consumption	no health hazard
	due to smoke	
	reliable, independent supply	
	no ongoing energy costs	
	less work involved in	
	running <u>biogas</u> plant	

Abstract

When professionally managed, biogas technology fits the context of agricultural production far better than any other renewable energy technology. In terms of the relationship between energy production and investment costs, biogas plants are "cheap". They produce a form of energy with a wide range of applications, they improve available fertilizer, encourage the farmer to change over to a modern form of agricultural production with intensive animal husbandry, and make an important contribution to improving public health. However; these advantages can only begin to take effect if large-scale

diffusion of **biogas** technology is achieved. Where economic problems present an obstacle to diffusion, political decisions are needed.

Résumé

La technologie du biogaz est une technologie qui, utilisée professionnellement, est beaucoup mieux adaptée au contexte de la production agricole que toute autre technologie du domaine des énergies renouvelables: une installation de biogaz est "bon marché" compte tenu du rapport production énergétique/frais d'investissement. Elle produit une forme d'énergie à utilisation universelle, apporte une amélioration de l'engrais existent, permet un passage plus rapide à une forme de production agricole moderne avec élevage intensif et constitue un élément en faveur de l'amélioration de la santé nationale. Tous ces aspects positifs ne peuvent se traduire dans le concret que si l'on en arrive à une expansion massive de la technologie du biogaz. Là où son expansion se heurte à des difficultés économiques, elle nécessite des décisions politiques.

Extracto

La tecnología del **biogas** es una tecnología que, profesionalmente aprovechada, se adapta mucho mejor al conjunto de la producción agrícola que cualquier otra tecnología en el campo de las energías regenerativas. Una planta de **biogas** es "barata": considerada bajo la relación entre producción de energía y costes de inversión. Produce una forma de energía de aplicación universal, mejora los abonos disponibles, fomenta el ambiente a una forma de producción agrícola moderna con una explotación de ganado intensiva y constituye un elemento más en el camino hacia una mejor higiene pública. Pero todos estos aspectos positivos no empezarán a dar sus frutos hasta alcanzar una difusión masiva de la tecnología del **biogas**. Allí donde su difusión choque con problemas económicos serán necesarias decisiones políticas.

Reply to the article by Mr. Claus-Peter Zeitinger, published in "gate - questions, answers, informations", issue 2/89 July 1989

Several of the comments made in relation to the SEP Tunisia by Mr. Claus Peter Zeitinger, Managing Director of Messrs. IPC, in his article "Solar Home Systems - An Under-Exploited Option" published in gate issue 2/89, pp. 15 - 19, force one to protest and set the record straight for the benefit of gate readers.

1. When the article was published, there was no "project carried out" involving the dissemination of Solar Home Systems (SHS) in Tunisia, either by IPC or by anyone else.
2. The elaboration of a regional supply concept for the pilot region El Kef, begun in 1988 by the Special Energy Programme (SEP) Tunisia, includes inter alia the demonstration and dissemination of fully developed RE solutions. The introduction of SHS in Tunisia constitutes one component of the project.
3. This was the context in which Messrs. IPC, on the basis of their previous experience in a GATE project in the Puno region in Peru, were subcontracted for the SEP Tunisia. IPC assists the project through short-term missions on the possible transfer of experience gained in Peru to Tunisia, and in the dissemination of SHS in El Kef.
4. During the pilot phase, which has only been running since June 1989, 90 rural households located in scattered settlements, and several public institutions, have been provided with solar systems. A reliable evaluation of the experience gained with SHS in Tunisia will not be available until March 1990 at the earliest.
5. The SEP Tunisia does not share the view that the SHS discussion should be directed exclusively

towards population groups reachable through commercial channels and with purchasing power. Such an approach would not conform to what the project was commissioned to do.

6. The sections of the target group excluded by the suggested pure marketing strategy in the Puno region of Peru would constitute approximately two-thirds, and in the El Kef region of Tunisia at least one-third, of the rural population in scattered settlements. It is thus rather difficult to share the view that all that is involved here are "segments of the target group, including even very poor households".

7. Parallel to what is a thoroughly appropriate private-sector commercialisation of SHS, it is therefore the declared objective of the SEP to add a solar component to the government-assisted programme of rural electrification, which has been in existence for years in Tunisia. Only in this way can that half of the rural population living in scattered settlements be ensured a supply for basic appliances (lighting, radio, TV).

Dr. Martin Schulte

Project officer at the SEP Tunisia

Responsible for the El Kef

energy supply concept

Tunis, December 1989

Workshop

Biomanure from small biogas plants

by Dierk Demant.

Biomanure (digested slurry), produced by anaerobic fermentation of animal dung in biogas plants, is a valuable organic fertilizer. It is a multinutrient fertilizer which contains all the principal nutrients needed for plant growth, and in some cases it can completely replace mineral or other organic fertilizers. Fertilization with digested slurry maintains and improves the fertility of agricultural soils, thus helping to safeguard their productivity.

When a biogas plant is in use, digested slurry is usually produced continuously, in liquid form. The chemical composition of the digested material, and hence also its fertilizing properties, vary according to the type of dung fed into the plant. Practically all the nutrients contained in the dung which are important for plant growth are preserved during anaerobic fermentation. The availability of these nutrients for plants is enhanced by conversion and mineralization, with simultaneous decrease of the C:N ratio. Substances which inhibit plant growth and compounds with strong odours are decomposed, while the quantity of growth-promoting substances is increased. Digested slurry has lime smell, is homogeneous in consistency, and, given adequate digestion time, poses no danger to health.

As compared to other methods of treating manure, biogas technology has the advantage that losses of fertilizer mass are lower, while at the same time energy is generated in the form of biogas. Whether the benefits in terms of fertilizing economy can actually be reaped in practice depends mainly on how the digested slurry is stored, treated and distributed.

Use of digested slurry

The fact that the digested material is in liquid form makes special demands on the fertilizing systems

of small farms. Plant cultivation and working methods usually mean that it is impossible to spread the fertilizer on the fields continuously as it is produced. So effective use of the fertilizer is tied up with transporting it to the fields at certain times. Therefore the digested slurry sometimes has to be stored for several months; depending on the method used, this may result in loss of nutrients and a reduction in the quantity of fertilizer.

- Storage in liquid form has the advantage that the loss of nutrients is relatively low. However, prolonged storage necessitates large reservoirs, and so usually only a portion of the digested slurry produced is stored in this way. The reservoirs take the form of brick basins or, if soil conditions are suitable, reinforced earth pits.
- If the slurry is dried it is easier to handle and transport to the fields, but drying inevitably involves a high loss of nutrients.
- An alternative to liquid storage or drying of the slurry is composting. A simple and therefore widely-used method is to collect the digested slurry in a compost pit, bedding residues and green matter are added to the slurry in the pit. This method is also used in combination with liquid storage, the storage reservoir overflow being connected to the compost pit. The product is a firm compost which is easy to transport to the fields.

Composting of the digested slurry can be improved by digging two compost pits and feeding the slurry into them alternately. If sufficient green matter is available, composting in clamp silos on which digested slurry is spread regularly is also possible. In this way the compost can be matured uniformly and quickly. But the method involves a great deal of work and has not been widely adopted so far.

Depending on how the digested slurry is stored or treated, it is spread in either liquid or solid form. With liquid fertilizer the availability of nutrients is higher, thus permitting selective fertilization even during plant growth periods. As this is highly labour-intensive and appropriate transport equipment is often unavailable, the use of liquid fertilizer is mainly confined to small, intensively used areas close to the **biogas** plant. An efficient way of using digested slurry is for fertilizing kitchen gardens in the immediate vicinity of the farm buildings. Specially adapted wheelbarrows have proved a simple and effective means of transport for this purpose.

Most digested slurry is used in dry or composted form, because this ensures easy handling and often corresponds to traditional fertilizing methods. The fertilizer can be transported to the fields in the same way as stable manure. No special transport implements are needed.

If the fertilizer is placed in furrows or planting holes before sowing or planting the crop plants, nutrient absorption by the crop plants will be high. When the fertilizer is spread over the surface, nutrient absorption is lower and it is essential to work the fertilizer into the soil. With permanent crops, which are fertilized regularly, the amount of fertilizer added should be matched to nutrient requirements. The digested slurry is spread around the individual plants and covered with mulch to protect the fertilized soil from dehydration and to encourage root growth close to the surface.

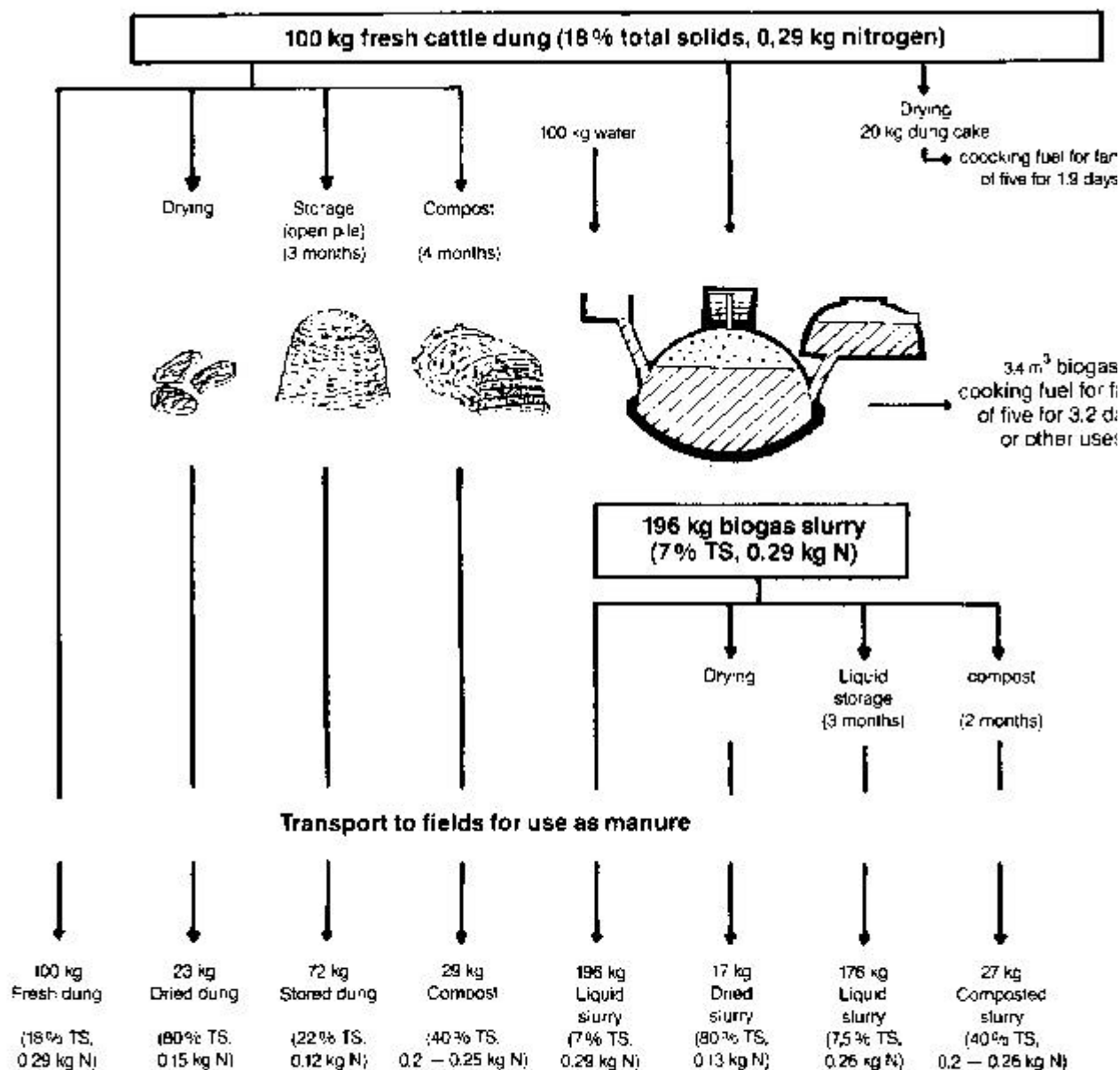

Some alternative options for utilization of 100 kg fresh cattle dung. Values are approximations based on best available information (after Gunnerson and Stucke 1986).

Figure

Fertilizing value

Data concerning the effect of digested slurry on productivity vary, due to the great differences in growing conditions and in the quality of the slurry itself. But experience gained so far in fertilization with digested slurry indicates that if it is appropriately used, good crop yields can be attained under widely differing local conditions and with a wide variety of crop plants. Comparative investigations repeatedly show that anaerobically fermented animal manure improves crop yields more than untreated or stored manure. Substantial increases in yields as a result of fertilizing with digested slurry are seen above all where, prior to construction of a **biogas** plant, the manure was stored in the open, with high nutrient loss, or was only partially used as fertilizer (e. 9. where the rest was used as fuel).

In particular, digested slurry can have a major impact on yields where it is used as a fertilizer for forage plants and vegetable crops, above all when it is applied regularly in liquid form. Use of liquid digested slurry can be optimized by choosing a suitable location for the **biogas** plant, and planting vegetable or forage crops in the immediate vicinity of the plant or the reservoir.

If mineral fertilizer is already being used it can be replaced or complemented by fertilization with digested slurry. Since only a portion of the nutrients contained in the slurry is available in the year it is applied, correspondingly higher quantities of slurry are needed if it is used to replace mineral fertilizer. The saving in the latter is thus achieved at the cost of extra work in transporting and placing the slurry. However, organic fertilization also improves the humus content of the soil, which is a key factor in preserving soil fertility.

Despite the potential improvement in yields, many users of small **biogas** plants still fail to exploit the advantages of fertilization with digested slurry to the full. One reason for this is that energy production is usually the foremost reason for deciding to build a **biogas** plant. Another is that experience in, and advice on using the digested matter as fertilizer are often lacking.

Encouraging optimum utilization of the slurry is also a key factor with regard to the economic viability of a **biogas** plant. To achieve optimum utilization, the use of digested slurry must be taken into account when designing and building a **biogas** plant, e. g., by building a reservoir. Once the **biogas** plant has been put into operation, the users must also be offered advice on questions of organic fertilization and/or given practical demonstrations showing them how to use the slurry under local conditions. Ensuring that appropriate advice is available is therefore an important component of **biogas** extension programmes.

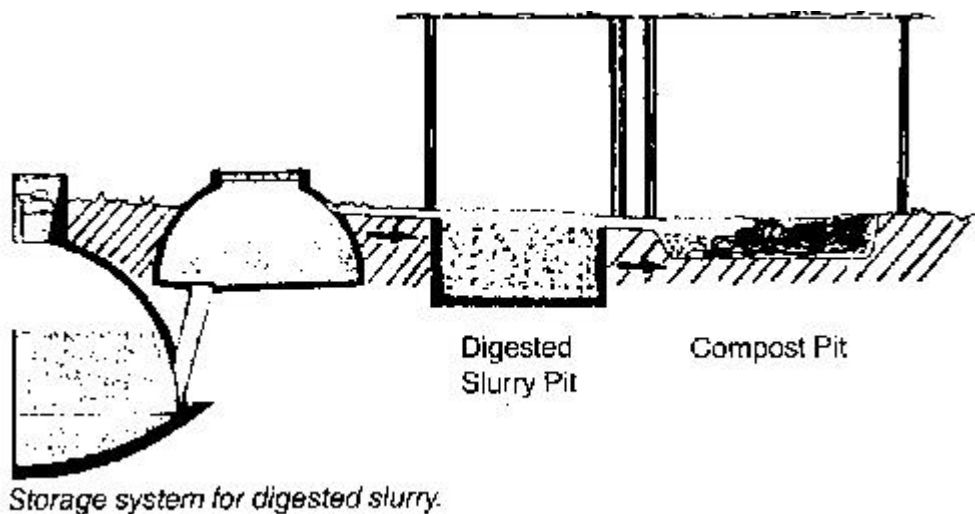

Figure

Evaluation of **biogas** programmes - Methodology and criteria

by Ludwig Sasse

No **biogas** programme can be improved without regular evaluation. And no evaluation is possible without a proper survey. With a **biogas** programme ecological stability could be achieved by satisfying just two criteria, namely burning **biogas** instead of firewood, and not using cattle cake and other agricultural waste directly as fuel, but using it in **biogas** plants to produce both fuel and fertilizer.

A **biogas** programme could also improve the private economies of gas plant owners, by saving fuel costs, improving the quality and increasing the quantity of fertilizer, stimulating an overall improvement in the farm's economy, and enabling farmers to modernize the economy of their households without external resources.

In addition, a **biogas** programme could improve the national economy

- by reducing imports
- by saving afforestation costs
- by increasing agricultural production, using sludge for manure
- by re-investing rural income in the village, creating rural jobs and improving the skills of artisans.

Besides this, **biogas** programmes could have a positive social impact:

- by benefitting the poor more than the rich
- by reducing the workload of women
- by improving the health situation
- by creating non-agricultural jobs, especially in the agricultural off-seasons.

Reference:

Gunnerson, C. G., and Stuckey, D. C. (1986): Integrated Resource Recovery - Anaerobic Digestion: Principles and Practices for **Biogas** Systems. World Bank Technical Paper # 49, Washington.

In order to evaluate a **biogas** programme, we have to distinguish between

- the performance and utilization of individual **biogas** plants and
- the impacts of the **biogas** extension programme as a whole on the environment, on the economy, and on society in general.

In both cases the previous situation, present realities and possible future development must be taken into account.

As regards future development, we mean the option for „development for ever and ever and ever!" - a subject which in itself would provide enough material for a lecture. Key aspects of an everlasting, sustainable development include sustaining the ecological balance, sustaining income from farm activities, sustaining surplus food production for the cities without continuous transfer of resources from rural to urban areas, and securing fair terms in international trade.

A **biogas** programme is not a panacea for development problems. But it is important that it should make a positive contribution; it must not hinder continuous development.

Methodology of evaluation

We have to be aware of the fact that **biogas** plays a fairly minor role in a country's overall ecological and economic planning. This is why funds are limited, and often even insufficient. The methodology of evaluation must take the lack of funds into consideration. It is pointless to describe an ideal

method of surveying and evaluation if the ideal survey will never be financed. Therefore, we need only look for a method that is feasible.

A **biogas** plant is a technical instrument and can only render service by its performance. Therefore, the most important parameter to determine is the current performance of the plant. The only way to accomplish this is to carry out an extensive survey in which gas consumption and sludge utilization are measured. The data collected from individual plants would then represent a basis for evaluating the entire implementation programme. It would be ideal if such a survey could be repeated every three years.

Survey and evaluation of **biogas** plants

To evaluate the efficiency of a **biogas** plant, the gas production must be compared with the amount of substrate fed in, in relation to the volume of the digester. For the digester volume the standard drawing may be used but there is no alternative to measuring daily gas consumption and the amount and TS content of the feed material.

It is also important to know whether the gas will be used for cooking or lighting, or as engine fuel. Because not only the thermal efficiencies, but also the environmental, economic and social impact are different in all three cases. The use of **biogas** for lighting, for example, has practically no environmental impact and has no energy-related advantage over kerosene.

Even with **biogas** plants which function perfectly there are remarkable day-to-day fluctuations in gas production, and even in well-organized households daily gas consumption and the input of substrate vary. Therefore, each **biogas** plant must be monitored for at least three days in succession. On the other hand, our experience has shown that a three-day monitoring period reflects true conditions fairly accurately, provided the monitoring data are adjusted to seasonal fluctuations.

Owing to the lack of funds for extensive surveys, one has to rely on survey assistants with relatively low professional standards. Therefore, the kind of questions asked and the measuring methods used must be as simple as possible.

The main items to be surveyed are as follows:

- gas production and the amount and kind of gas consumption per day
- previous and present fuel alter natives
- amount, kind and TS content of daily feed material, including the quantity of mixing water
- number of animals providing manure and type of stabling
- number of persons supplied with gas and using the toilet
- way in which slurry is used and fertilizing practice Photo: SEP Tunisia
- volume of digester, gas-holder, and gas storage normally used
- type of **biogas** plant, its cost and the year in which it was built
- previous repairs of **biogas** plant necessary and carried out.

In extensive implementation programmes representative examples must be chosen. If no exact statistical method is available, it might be sufficient to survey all the **biogas** plants in one area

assumed to be representative. In order to carry out the calculations necessary for the evaluation we need some additional, more general data, such as the temperature and life of the plant, ecologically relevant data, the foreign exchange rate (both official and black market), prices, and the increase in yield as a result of using slurry as fertilizer.

There is no evaluation without prejudice. We should take this into account before preparing our evaluation.

Evaluation of the performance of **biogas** plants and their ecological and economic impact is no more than an elaborate calculation. Obviously, the formulae used are as important as the data.

Individual profit

For **biogas** plants it is practical to use the „break-even point" as a criterion for evaluating economic viability, as this indicates how long a **biogas** plant has to be in operation before producing a net profit for its owner. The formula would be

$$c / (ai - ae)$$

where

c = capital investment

ai = annual income from the **biogas** plant and

ae= annual expenditure for operating the plant.

National profit

The relationship between the national profit and the construction cost of the plant is most interesting. This figure indicates the extent to which public support of **biogas** plants is economically justifiable. This justifiable support may be calculated using the following simplified formula:

$$s_1 + s_2 + S_3 / (C - R)$$

where

S_n =savings resulting from use of gas and slurry within a given time (life of the plant)

c = initial construction cost, and

R = recovery factor of investment, depending on the assumed life of the plant.

The deposit interest rate may be taken as a basis for calculation.

Each parameter itself comprises several assumptions, e.g. the value of convertible currency compared to local currency, or the likely cost of afforestation when afforestation becomes a national programme.

Evaluation of extension programmes

The number of installed **biogas** plants alone is by no means a criterion of the efficiency of a **biogas** extension programme or of the implementing organization.

In order to evaluate a **biogas** programme, one must first consider the utilization of the products of a **biogas** plant, i.e. slurry and **biogas**.

A second consideration is the construction of the **biogas** plants themselves. Neither the type of plant nor the technical standard can be used as absolute criteria. Only the amount of capital reinvested in rural areas is important.

Thirdly, a **biogas** programme should be judged by its social impact. This applies to the profit that women derive from a programme; it also includes the relationship between rich and poor farmers and the extent to which the introduction of **biogas** stimulates an overall improvement in agriculture.

Finally, the effect on sanitation and health have to be considered.

Extension programmes should be evaluated first and foremost on the basis of their declared aims. One ultimate parameter would be the aggregate performance of the individual **biogas** plants. A comparison between the actual performance and the potential of the plants might indicate the efficiency of a **biogas** programme. It could be assumed that the performance of 33 per cent of the best plants realistically reflects the potential of the programme as a whole. For example, if 33 per cent of the best plants produce 250 litres of gas per cubic metre of digester volume and kg of TS of substrate, but the average production of all plants is only 175 litres, only 70 per cent of the capacity of the programme as a whole is being utilized.

While any one **biogas** plant may be economically viable and make a positive contribution to the national economy, the programme as a whole may still be running at a loss, both as regards its own budget and for the general public.

Here it is necessary to distinguish whether a programme is in the demonstration, the pilot, or already in the implementation phase. The organization must be evaluated to establish whether its structure and provisions will ultimately result in a **biogas** programme that produces a national economic benefit.

Any assessment of the efficiency of a **biogas** implementation programme must be related to the actual performance of all the **biogas** plants put into operation, be they a direct or indirect result of the organization's activities. The funds spent must be set in relation to the national profit, or more accurately to the contribution to overall development.

The salaries for personnel permanently employed to run a **biogas** programme must be reimbursed out of the national profit deriving from a **biogas** programme. The organizational structure is therefore a function of the number of **biogas** plants installed plus the sum of salaries to be paid to initiate construction and to supervise the maintenance of all the **biogas** plants in a programme.

Conclusion

Implementation measures should be selective, and should be chosen in accordance with the goals aimed for. There are objective criteria for evaluating the economic benefits. There are also a number of quite clear criteria for judging whether a **biogas** programme is environmentally compatible. But there are not, and perhaps never can be any objective criteria by which social benefits can be measured. These are subject to political decisions, which are the domain of those with the relevant responsibility. Nevertheless, one fact is indisputable, namely that **biogas** programmes can only help by the amount of gas and slurry actually utilized. Therefore, the prime objective of any **biogas** programme must be to ensure the construction of efficient **biogas** plant.

Biogas in agriculture - A status quo report from the FRG

by Wolfgang Baader

The first **biogas** plants for treating animal waste in the Federal Republic of Germany were installed on farms immediately after World War II in 1947. During the following ten years, the number of plants in operation on farms rose to around 40, with digester sizes of between 25 m³ and 1,000 m³.

As a result of the drop in energy prices at the end of the 1950s, almost all these plants gradually fell into disuse. Not until the 1970s, when energy costs once again soared, was there a revival of activity in the FRG aimed at developing the **biogas** method further and introducing it on a larger scale in agriculture.

Even though there has been a considerable increase in the number of plants installed since 1983, there has been only a relatively small increase in the number of plants still in operation. The reasons why so many plants have been shut down have been, specifically, uneconomic operation due to the low price of energy, high maintenance costs, high repair costs and unreliability.

Processes and digester systems

Irrespective of size, most plants are of the through-flow tank type, with more or less intensive mixing. The majority of the tank digesters are equipped with hydraulic mixing devices or an externally installed pump which pumps the liquid back from the bottom of the tank to the surface, or to a level above the surface, in order to destroy or prevent formation of a float layer. Thorough mixing is also the preferred method of ensuring uniform distribution of heat in the digester.

Only a few tank digesters have mechanical stirrers and gas injectors. Apart from these conventional systems, whose suitability for treating substrates containing few or no coarse solids (manure without bedding matter) varies, the partially mixed and completely filled type of digester (FAL system) has proved highly reliable for processing substrates that are rich in coarse and fibrous solids. This matter is forced to flow in a loop pattern by a downward-acting, slowly rotating propeller or screw in a central draft tube, thus preventing formation of a float layer. In the novel FhG/Schwarting once-through-type digester, the substrate passes through two separate, consecutive digester compartments with vertically oscillating grids, which hold back all coarse solids which are not broken down to the size of the grid mesh.

In addition to vertical tank-type digesters, there are also a large number of digesters of the horizontal channel type. These once-through digesters, with slowly-moving paddles for smooth stirring, are also highly suitable for treating substrates rich in coarse solids. The digesters installed have volumes of up to approx. 100 m³.

On some farms, where the liquid manure storage tank had to be covered to comply with legislation on air pollution, this measure was combined with certain additional installations, transforming the previous storage system into an inexpensive **biogas** plant. The principal components are a flexible balloon-type cover for collecting the gas and a floating PU insulating layer on the surface of the liquid. The balloon is protected against rain, snow and mechanical damage by a rigid lightweight roof. The substrate is mixed by pumping; the digesters are fed discontinuously and are frequently partially emptied.

Outlook for **biogas** technology in the agricultural sector

In the agricultural sector, **biogas** technology as a means of generating energy will not be of any great interest as long as energy prices remain at their present low level. As regards protecting ground water against pollutants (organic and nitrates) from liquid manure distributed on fields in quantities which cannot be completely absorbed by the plants, surpluses of animal liquid waste have to be prevented

in many parts of the FRG by limiting animal production. Alternatively, the nutrient content of the waste has to be reduced by various separation and recovery processes. In treatment plants of this kind, anaerobic digestion is considered an essential step, by which mineralization of organic nitrogen, reduction of COD, and production of fuel gas to cover the energy requirement of the gross process can be achieved.

Table: Gas production of plants currently in use in the agricultured sector

Liquid manure treatment			
Yield from	laying hens	0.30 - 0.35	m ³ CH ₄ /kg VS ₀
	pigs	0.25 - 0.30	m ³ CH ₄ /kg VS ₀
	ruminants	0.18 - 0.22	m ³ CH ₄ /kg VS ₀
Quality	55 - 75	% CH ₄	

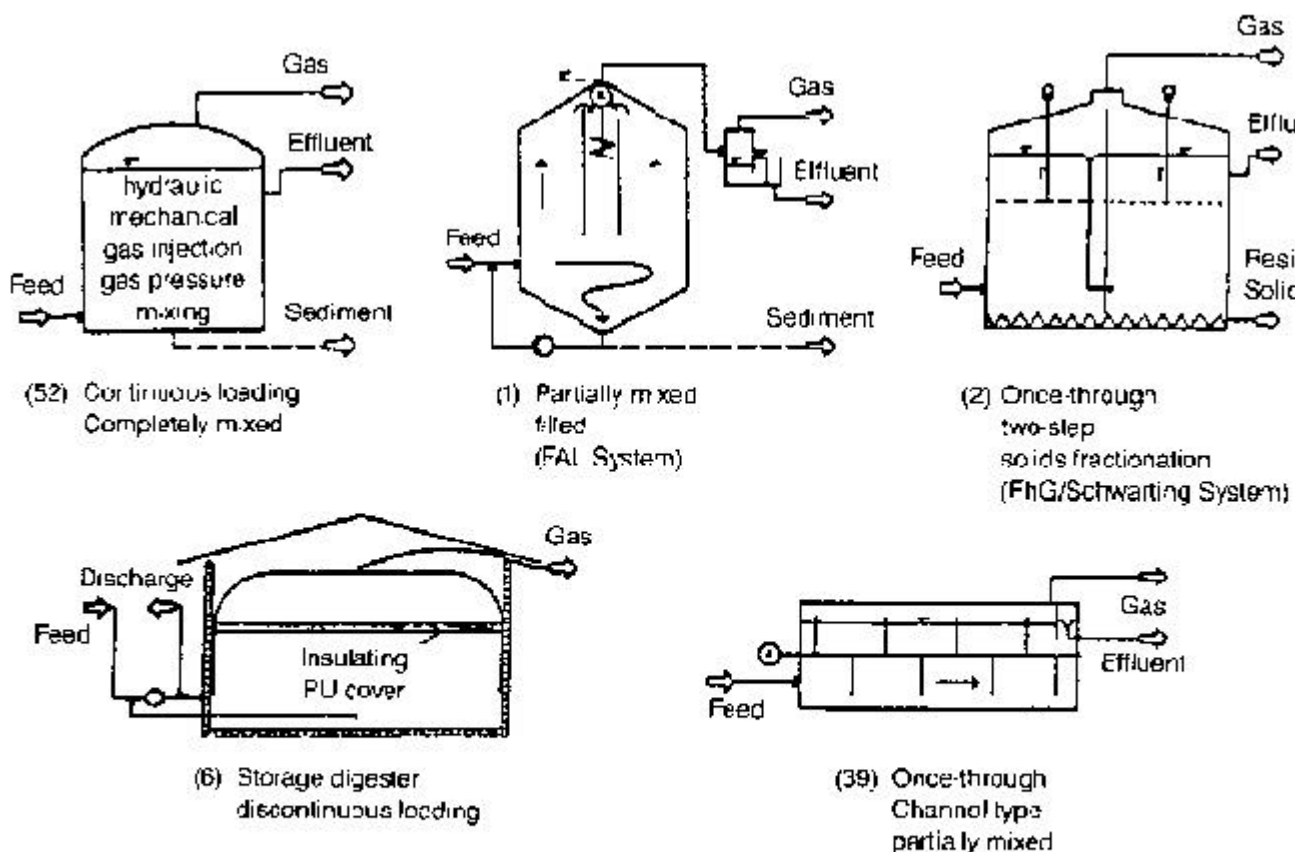

*Digester systems used in the agricultural sector (percentages in brackets).
Drawing: Wolfgang Baac*

Figure

FRG a "Developing Country" in biogas technology

by Heinz Schulz and Hans Mitterleitner

When one considers the large numbers of biogas plants in China and India, Germany could be regarded as a developing country in this field. In the last 12 years only 150 agricultural biogas plants have been built in the FRG. The reasons for this low number are the low price of fossil fuels and the high level of expenditure on technology and plant construction needed to meet German safety standards.

However, it is likely that German agriculture will have to invest more heavily in biogas technology as soon as new environmental protection regulations come into force requiring reductions in ammonia and methane emissions when depositing manure. In addition, the latest round of oil price increases is bound to stimulate further developments in the biogas field.

14 years of assistance for biogas projects

Since 1976, the authors have been conducting laboratory and field experiments and looking after a number of Federally supported pilot projects with the aim of furthering the development of biogas technology.

In the course of this work great differences between the various plants were found as regards their practical suitability, gas production, energy consumption and economy. In particular, there was great uncertainty as to how the side-effects of biogas production and the properties of the fermented slurry should be evaluated.

Study of 35 farms with biogas plants

During the past two years, at the request of the Schweisfurth Foundation of Munich, the authors have carried out a study of 35 typical biogas plants in the south of the FRG.

Most of the plants are to be found on farms of less than 60 hectares (1 hectare [ha] = 10,000 m²), and were installed between 1980 and 1985. The volume of the majority of the digesters is between 50 and 100 m³; the only plants with digester volumes higher than 200 m³ were of the storage tank type. And most of the plants operate in the mesophilic temperature range, i. e. between 30 and 35°C.

The newer storage-type plants operate at a process temperature of 25 ° C. Plants operating at below 25 ° C without heating are not common in Germany. There are only a few plants which work at 35 - 45° C, and the thermophilic range, above 55 ° C is not found at all in practice.

64 per cent of plants owner-built

As can be seen from Fig. 1, most biogas plants operate on the through-flow system, without a post-fermentation pit. Sixty per cent have horizontal digesters, the remaining 40% vertical ones. The majority of the plants have mechanical and hydraulic mixers. More rarely, the mixer is pneumatic or there is no circulation at all. The most common construction material for digesters is concrete, followed by steel, while plastic is used only very rarely. Sixty-four per cent of the plants studied were built by their owners. The rest were professionally built, though additional work by the owners was needed. Altogether, 75% of the plants operate with cattle manure, 8% with pig manure and 3% with a mixture of the two.

In most cases the gas is used to heat water or the house. However, it is also used to generate electricity, for cooking, heating calf sheds, pigsties and swimming pools, and for drying.

The costs of the **biogas** plants studied depend to a very large extent on their size and the amount of work done by the owner. When built by the owner, the plants cost between 300 and 1200 DM/GV; the cost of professionally built plants ranges from 1000 to over 3500 DM/GV (1 GV = 1 head of cattle weighing 500 kg).

Measurements and surveys of the amount of **biogas** produced revealed great differences, but the mean is approx. 1 m³ per GV and day. Gas production from pig manure is about 15% lower than from cattle manure due to the higher water content of the former. Some 40% of the gas produced from pig manure is needed for process energy, the figure for cattle manure is 30 %.

The manure and slurry were also analyzed. Decomposition was found to be 46.4% with pig slurry and 36.6% with cattle slurry. The residence period was 20 - 30 days.

Side-effects most important

Considering the energy production of **biogas** alone, available data show that, given a production period of 20 years, net energy prices vary from 1 to 42 pfennigs per kWh (100 pfennigs = 1 DM).

This means that there are **biogas** plants in the FRG which work economically even when oil prices are low, and ignoring manure-improving effects, there are others which produce gas too expensively, even when oil prices are high. Gas is produced inexpensively in simple plants built by the owner/user, and requiring little maintenance and repair, a greater amount of gas is produced with a 100 % utilization rate and low process energy requirements.

However, no German farmer builds a **biogas** plant just to save oil or electricity, but rather for the side-effects of anaerobically treated manure, which have become increasingly important and attractive. The 35 owners of the plants investigated were therefore asked how they would rate these effects.

First, it is interesting that not one farmer had a negative opinion of the changes in the manure in the **biogas** plant. Moreover, while there was no disagreement regarding the individual effects, great differences were seen between them.

The reduction in acidity levels and unpleasant smells, as well as the improvement in homogeneity (uniformity of distribution) of the manure were seen as the most important points. Use of the slurry as fertilizer and the positive influence on plant communities were considered moderately important, while improvement in plant health, weed control and soil structure were rated as being least important.

Fig. 1: Technical data of 45 **biogas plants in operation in Bavaria**

	through-flow system	storage tank system		
System	without post-fermenter	with post-fermenter		
	33 (73.3 %)	7 (15.6%)	5 (11.1 %)	
Configuration of digester	horizontal	vertical		
	27 (60 %)	18 (40 %)		
Mixer	mechanical	hydraulic	pneumatic	without mixer
	27 (60 %)	12 (26.7 %)	3 (6.7 %)	7 (15.6 %)
Digester material	concrete	steel	plastic	timber
	28 (62 %)	16 (36 %)	1 (2 %)	-
Construction method	industrial	mainly do it yourself		
	16 (35.6 %)	29 (64.4 %)		
Kind of manure	cattle	pig	poultry	mixed
	34 (75 %)	8 (18 %)	-	3 (7 %)

Major savings in artificial fertilizer

Additionally, we asked about savings in artificial fertilizer and improvement in plant production. On average, the farmers had achieved a 36 % saving in artificial fertilizer since putting their **biogas** plants into operation. Two farmers had seen plant production increase by 10 and 25 % respectively, with the same consumption of artificial fertilizer. Four had stopped using artificial fertilizer altogether because they had switched to biological production. Even if these last-mentioned farmers are ignored, the figures show a saving of about 21 %. Bearing economic and environmental considerations in mind, more attention should be drawn to this fact in the future. Of course, these savings are a result not only of the introduction of **biogas** technology, but also of more careful handling of the slurry.

The financial evaluation of the side-effects, as correlated to the usefulness of the gas at the present oil price of DM 0.40 per litre, was also very interesting. Evaluations ranged from 80% for the gas and 20% for the slurry to 20% for the gas and 80% for the slurry. Hence, this point should not be ignored in future economic calculations either, and the cost of **biogas** production should be cut by half the average total cost at an oil price of DM 0.40 per litre.

In spite of this gratifyingly positive evaluation of **biogas** technology by skilled and experienced farmers, many problems still have to be solved and there are many improvements to be made before the advantages of this technology can be exploited in practice in German agriculture.

Good results obtained with Indian Kirloskar engine

There seems to be an especially urgent need to increase **biogas** utilization in summer, e. 9., for drying, cooling or generating electricity. There is a lack of small, sturdy' economical, low-cost engines which run on **biogas**.

Good initial results have been obtained with the Indian-made Kirloskar diesel engine, in dual-fuel operation. Great hopes are also being pinned on small Stirling engines, which are likewise produced in India (St 5 version).

We will soon be conducting our first experiments with simple **biogas** plants, basically consisting of a black plastic tube. But in spite of all the progress made in the **biogas** field, it will still be necessary to develop other renewable, non-polluting energy sources.

Fig. 2: Problems, solutions and developments in biogas technology

Problem	Solution or tendency
Costs too high	prefabrication and DIY modification of existing manure tanks (storage tank plant)
Process energy consumption excessive	heat recovery cold fermentation(if necessary with special bacteria) use of solar and ground heat
Corrosion of digester gas leaks	filled digester with high-grade steel gas dome use of plastic
Blockage by floating covers or sediments	pipe diameter 125 - 300 mm no fodder residues in manure high-performance mixers and pumps
Corrosion of burner and motors	sulphur filter 2-phase system admission of small quantities of air into digester (1 - 3 vol. %; $H_2S + 1/2 O_2 = H_2O + S$)
	Stirling engine with external combustion
Difficulty of using gas in summer	heating of air for drying cooling, use for direct sales of meat, fish, vegetable, fruit generation of electricity for personal use feeding into mains with new tariffs
Small biogas plants below 50 m ³	used tanks biogas engine + heat pump instead of gas furnace simple biogas plant consisting of plastic tube

Biogas in the municipal and industrial sector - A status quo report from the FRG

by Wolfgang Baader.

Anaerobic digestion was already being used in Germany to treat municipal sewage sludge more than

60 years ago. In the food industry, anaerobic treatment of waste water was introduced in the FRG some 20 years ago. And the use of systems for recovering gas from garbage landfills has been steadily increasing over the last 15 years.

In both the municipal and industrial sectors, anaerobic digestion is an ideal waste treatment process, because it satisfies economic requirements and conforms to environmental protection regulations. While gas production is certainly of secondary importance, it often makes a major contribution to plant economy

Scope of application

Municipal sector

Sewage sludge: In 1979/80, there were more than 8,000 municipal treatment plants in the FRG, processing the sewage of 80 per cent of the population. About 67 per cent of the sewage sludge output of these plants was stabilized by anaerobic digestion. In 1983 about 900 digestion plants with digester volumes of up to 8,000 m³ were in operation. (It has not yet been possible to determine the present number of plants.)

Garbage landfills: The rapid increase in the number of landfills at which gas is recovered is a result of official restrictions on air pollution. In addition to the positive environmental impact, the gas is useful in meeting the energy requirements of processes linked to the digesters or of external users.

Industrial sector

The major advantages of anaerobic - as compared to aerobic - processes in waste water purification, combined with increasing environmental constraints, prompted food processing companies to instal increasing numbers of digesters. Most are in sugar refineries (30 %), some in the starch industry(15%),indistilleries(30%)andin the cellulose industry (8%); others are installed in particular in various industries which produce organically contaminated waste water.

Processes and digester systems

Municipal sector

In sewage sludge treatment plants the digesters are designed as one-step, completely mixed reactors. In small and medium-sized digesters, the liquid is mixed either hydraulically, in combination with heating by means of an external heat exchanger installed in the recirculation pipeline, or by gas injection combined with an internal heating device. Many large digesters have a central draft tube with a screw-type rotor which forces the liquid to circulate in a loop-flow pattern. Floatable matter is discharged discontinuously at the top of the digester. All digesters operate in the mesophilic range.

Some 25 per cent of the sewage sludge is spread on arable land. This sludge therefore has to be free of pathogens. To this end, in addition to pasteurizing, the sludge is nowadays treated by an anaerobic-thermophilic process in many plants prior to anaerobic treatment.

There are a variety of systems for recovering gas at garbage landfills. When landfills are being set up, horizontal perforated pipes are installed in them at several levels. If the landfill has already been closed, vertical gas wells are drilled. In order to prevent air pollution the gas is usually extracted by aspiration.

Industrial sector

Some years ago, most of the digesters in this sector worked on the completely mixed reactor principle

and as contact systems. Since about 1982, digesters with internal biomass accumulation have mainly been installed, about half of them being of the biomass retention type (sludge blanket) and the other half of the biomass immobilization type (fixed carrier).

Different materials are used as carriers, depending on the substrate and on costs. Only a few plants have digesters in which the biomass is immobilized on fluidized carriers. In most cases the waste water is treated in a two-step process. Apart from the main purpose, such as liquefaction and acidification of the complex organic compounds, the first step is also a means of buffering the substrate when it occurs discontinuously, and of balancing its composition. All these effects help to make the subsequent methanation process more efficient.

Outlook for **biogas** technology in the FRG

In the domain of environmental protection, anaerobic digestion will continue to make a major contribution as a highly efficient process for degrading and stabilizing organic matter, combined with the benefits of reduction in mass and volume, elimination of unpleasant odours and generation of gas as a substitute for other fuels, thus improving the economy of processes linked to the **biogas** plants.

These advantages have already been put to use on a large scale in the past, and will continue to be exploited intensively for sewage sludge treatment in the municipal sector and waste water purification in industry.

For treating solids, e.g.

- organic breakdown of garbage
- solid agro-industrial by-products and residues
- green biomass from vegetation control on fallow land and recreation areas
- green biomass from farm land anaerobic digestion will have a real

Table: Gas production of plants currently in use

Municipal sector		
- Sewage sludge treatment		
Yield	0.26 - 0.35	m ³ CH ₄ /kg VS ₀
Quality	60 - 70	% CH ₄
- Garbage landfill		
Yield	1 - 3	m ³ CH ₄ /t w.m.
Quality	35 - 55	% CH ₄
Industrial sector		
- Waste sector		
Yield	0.24 - 0.33	m ³ CH ₄ /kg COD
Quality	70 - 85	% CH ₄
COD reduction	70 - 98	%

Chance, provided that suitable technical of progress in engineering research and solutions become available as a result development.

The promotion of biogas plants in the Federal Republic of Germany

by Erich Dohne

One must distinguish between two different kinds of biogas plant: simple plants on farms, for use with animal manure, and high-performance plants, in particular for processing special residues in the food industry and industrial raw materials.

With regard to the first group, the Federal Government and the Federal states are of the opinion that, in the light of the extensive research done and the numerous model and pilot plants constructed since the end of the 1970s, there is no compelling need for assistance, especially since animal dung is an excellent fertilizer even in unfermented form. The main obstacle preventing generous support being given to promote wider dissemination of such plants is their current low level of economic feasibility.

With regard to the second group, things are completely different. In general, acute disposal problems are involved here. Moreover, a large number of basic prerequisites and satisfactory process concepts still have to be created.

There are, therefore, a variety of instruments for promoting such plants, although a formal application is always necessary and there is no general guarantee that support will be forthcoming.

Various donors

The Deutsche Forschungsgemeinschaft (German Association for Scientific Research) supports individual scientists and scientific institutions working in basic research. Whether an application is worthy of support is decided, among other things, by the reports submitted on it.

The Federal Ministry for Research and Technology (BMFT) and the Economy and Environment ministries at state level can grant financial support to research institutes (without these having to provide any financing of their own) and to companies (usually, these have to provide 50% of the total amount themselves).

The BMFT runs an "Energy Research and Energy Technology" programme. Among other things, this promotes research and development efforts aimed at tapping new energy sources, financing 50% of the cost involved. Although **biogas** plants fall into the category of "new energy sources", it must be assumed that only high-performance plants will be short-listed for support.

High-performance **biogas** plants have received consideration - as a subdivision - within the framework of what is in principle a completed liquid manure programme (conceived of as a disposal programme, including nutrient removal and outlet channel cleansing during the liquid phase, for water conservation regions and regions where surplus manure is produced).

Various district councils and bodies in the FRG have attempted to implement community **biogas** plants via state support programmes. Preliminary studies have been carried out and two trial projects started. It has not been possible so far to implement further plants, as economic viability was only achieved with an exceptionally high level of subsidization. The advantages of 100% exploitation of the gas were unfortunately cancelled out, given current energy prices, by the additional input needed to maintain hygiene and the high cost of transporting the liquid manure. Such projects could become interesting again if energy prices in general were to rise.

Support from the EC

The European Community (EC) runs various R&D programmes, within the framework of which „energy from biomass" projects can receive support. **Biogas** plants could also receive consideration here indirectly, if, for example in combination with alcohol production plants, they process organic residues from the latter and the **biogas** improves the energy balance of the plants. Tenders are published in the official EC bulletins on these programmes. Application procedures (sometimes in connection with tenders) are often highly complex, and in some cases cooperation with at least two EC countries is necessary. The amount of support granted does not generally exceed 50% of the total sum required. Applications have to be submitted on special EC forms. Prior to applying it is advisable first to contact the EC Commission in Brussels or the EC Press and Information Office in the FRG.

The most comprehensive support specifically for simple agricultural **biogas** plants was and theoretically continues to be given under the terms of a joint project implemented by the Federal Government and the Federal states, entitled "Improvement of Agricultural Structure and Coastal Protection". This is an ongoing project in which support possibilities and principles to be applied over a number of years are set out in a "framework plan". The framework plan, usually valid for a four-year period, is revised annually. The new framework plan for the period 1990-93 has just been approved; as regards the areas which cover **biogas** plants it is practically identical to the preceding plan.

On the basis of this Federal and state programme, the individual states have drawn up their own promotion schemes, which may differ from the limited scope of the federal framework plan as regards the main emphasis in the activities of the respective states.

Help not granted automatically

The following is worth noting with regard to the principles on which support is granted:

There is naturally no automatic entitlement to funding. The approving body takes its decision on the basis of budget finance available and the expected efficiency of the plant, i.e. the amount of energy likely to be saved. In some cases the project has to show that funds committed will be amortized within half the technological lifetime of the plant. As a matter of principle, support is only granted if overall financing of the project has been secured and the economic condition of the recipient of the funding justifies the assumption that the project will be duly implemented. Applications made under the "Investment Aid for Energy Saving" programme must furnish concrete proof of the appropriateness and economic viability of the project.

Cartoon & reflection

The Eighties - A Wasted Decade for Development Cooperation

Willy Brandt Paints a Gloomy Picture of North-South Cooperation

As we all know, the gap between the rich and poor nations has not narrowed; on the contrary, the gulf between them has widened. And I fear that it will become even wider if there is no radical change for the better in international cooperation. Who would doubt today that the 1980s were a wasted decade for development cooperation, especially as regards joint multilateral action?

Even in the 1970s the North-South Dialogue petered out - for a variety of reasons, among them the Third World's weak negotiating position. Since then the developing countries have been faced with the difficulty of presenting themselves as a united force, capable of action. For several decision-makers in the northern hemisphere - who in any case didn't like the "we want everything" demands of the Third World representatives (and didn't care for the recommendations of my Commission, either) - it was all too convenient to ascertain certain conflicts of interests, between the nouveau riche oil-producing countries on the one hand and the impoverished African nations on the other. So they decided to wait and see.

The senseless East-West confrontation, which found expression in the arms race between the Superpowers, led to a deterioration in North-South relations. The arms race made huge inroads into both our financial and our intellectual resources.

Another major reason why the South was neglected was, without a doubt, the fact that the OECD countries were facing considerable problems of their own: recession, high inflation and unemployment. Among other things, internationally high interest rates had a negative impact on the developing countries. This only served to aggravate the debt problems. And then the debt crisis was tackled not politically, but only with technocratic methods. Structurally weak countries were expected to "put their house in order" without delay.

US Treasury Secretary Brady conceded that in the face of continuing tough competition in the global economy and the astronomical cost of servicing the debts, this was an insurmountable task. And meanwhile even no-nonsense bankers have come round to the view that debt remission is an urgent necessity.

At the moment it looks as though the era of "wangling our way through" and of inconsiderateness in North-South relations is coming to an end. But it is above all the threat of environmental catastrophe that has helped bring about this changed awareness. Isn't it true that, rather as the incalculable risks of the nuclear arms race concentrated our minds on joint security, our knowledge of the gap in the ozone

layer and the greenhouse effect have led to a rational reassessment of interdependent development?

Meanwhile the industrialized countries have to admit that the global threat to the environment is mainly, if not exclusively due to their growth. Today, anyone who wants to rescue the environment of the prosperous has no choice but to cooperate with the "have-nots". Anyone who talks about the environment must also be prepared to talk about development as a kind of "global domestic policy". And I would add that if we are really serious about achieving viable development for all, then we must be alarmed by the rapid rate of population growth.



Peter Kaczmarek entitled his cartoon "Looking ahead".

International scene

The GTZ/GATE **Biogas** Extension Programme

by Thomas Buhl-Bohnert and Heinz-Peter Mang

In 1980, on behalf of the Federal Ministry for Economic Cooperation (BMZ), GTZ/GATE instituted a **Biogas** Extension Programme as a part of German development aid. It was prompted by the realization that **biogas** extension requires an integrated approach, and in the light of results of the first GTZ **biogas** projects in Cameroon in 1978 and some short-term consulting work done between 1977 and 1980.

The aims of the programme are:

- to promote rural development in selected areas by disseminating **biogas** plants on the basis of an integrated project approach;
- to develop and disseminate **biogas** plants adapted to local requirements;
- to develop and apply dissemination strategies suited to the particular situation;
- to promote extension services by cooperation with local, national and international organizations and multidisciplinary consulting teams.

On the basis of a variety of GTZ studies and projects, the **Biogas** Extension Programme (BEP) started in 1982, with comprehensive training of German consultants in China, India and Guatemala.

GATE is in charge of programme coordination and consulting services. These services include continuous evaluation, basic development work, and contact with international **biogas** experts and **biogas** organizations. Parallel to project work, GTZ is interested in an international exchange of experience and in resolving complex problems. For this purpose the BEP backstopping service is documenting the projects and working on major topics via reports, slide presentations and brochures.

National projects

Biogas extension programmes have been launched with the help of local, national and international organizations. Consulting teams or consulting experts have so far been delegated to a total of 14 countries in connection with GTZ's **biogas**-related activities, which have also included further short-term consultancy projects in Botswana, Egypt, Ethiopia, India, Malawi, Mauretania, Turkey, Tunisia and Sudan. Up to May of 1990, some 1500 **biogas** digesters, with 5 volumes ranging from 3 to 810 m³, had been built in cooperation with national partners.

Experience with **biogas** technology

Generally speaking, the digesters and gas-burning appliances available for GTZ **biogas** projects are mature, reasonably priced designs which are suitable for dissemination.

The experience gained so far may be summarized as follows:

- **Biogas** extension is a long-term process; its inherent dynamics and the interaction of partly parallel and partly consecutive project measures, as well as changes in the project environment, call for unbiased planning, continual revision, and flexible concepts for project schedules.
- **Biogas** technology and extension constitute an integrated system which includes site identification in conformity with the needs of the individual target groups, analysis of biomass supply and energy utilization, plant and gas appliance technology, repair and maintenance services, ways and means of promoting **biogas** extension, organizational and infrastructural measures etc.
- With regard to the technology of family-size/small-scale **biogas** plants and gas appliances, dependable and reasonably priced types of plant (floating-drum plant, fixed-dome plant, tunnel plant,

plastic-covered plant are now available and recommended. **Biogas** consultants give professional plant constructions explicit priority over self-help measures.

- It is not only the financial benefits that play a decisive role. It has been noted that many users also regard the provision of light, kitchen hygiene, the reliability of the energy supply and the labour-saving aspect as key factors.
- It is imperative that **biogas** plants be integrated in an agricultural production system, i.e. stabling - **biogas** plant - slurry utilization.
- **Biogas** plants for treating agro-industrial waste and sewage (i. e. anaerobic filters and stirred digesters, UASB digesters) have already become extremely important, in particular as regards environmental protection.
- With regard to the institutional basis of **biogas** extension, a combined system is usually preferred. Governmental/semi-governmental institutions render basic services and ensure political support for the programme. Where possible, private building firms do the construction work and provide maintenance services. Cooperation between the private and public sectors is expected to create optimum conditions for self-perpetuating **biogas** extension.
- Almost all extension projects suggest a customer-oriented approach, i. e. the use of appropriate plants and appliances and standardization of the technology as well as maintenance and consulting services. In this context, the provision of financing aids and the setting up of corresponding funds are usually regarded as long-term processes, with the result that current extension programmes still focus on wealthier customers.
- As an integral part of the **Biogas** Extension Programme high priority is still being given to training engineers and artisans, as well as to the provision of information and advice to plant users and/or prospective users.

Other activities in GTZ/BMZ **biogas** projects focus on the following:

- development and/or consolidation of independent national and regional extension structures in nationwide programmes;
- improvement of technical, planning and socio-economic instruments for **biogas** extension;
- research into and development of the utilization of slurry as fertilizer and optimized utilization of **biogas**;
- increased efforts to ensure that other national and international development institutions share the know-how acquired in GTZ projects;
- dissemination of anaerobic technology for wastewater treatment;
- organization of regional conferences on **biogas** technologies and implementation strategies.

GTZ/GATE is interested in an exchange of information in all areas relevant to **biogas** technology and its dissemination. The address to write to is:

GTZ/GATE

Heinz-Peter Mang

Dpt 4020

P O. Box 5180

D-6236 Eschborn 1

RFG

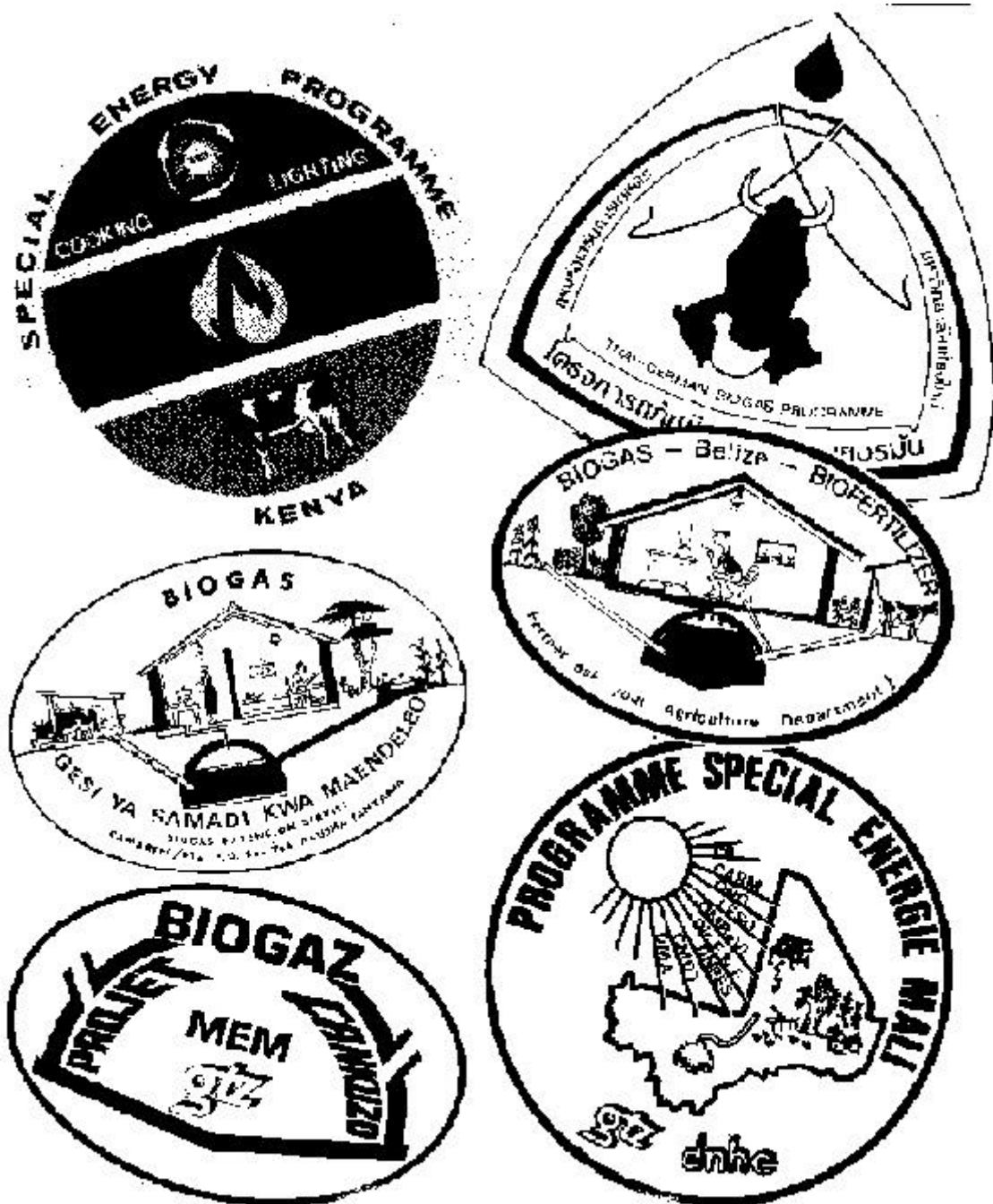

Stickers from different GTZ biogas projects.



Figure

Biogas Programmes and Related Backstopping Services

by ENVIRON

At the same time as the GTZ/GATE **Biogas** Extension Programme was inaugurated, the Federal German consulting firm ENVIRON was commissioned to handle the backstopping for this programme and other GTZ **biogas** projects. One of the main tasks was to document **biogas** activities in the various countries, collect and evaluate working materials such as plans, reports, technical papers and other publications, as well as to make the outputs available for institutions and interested individuals.

In 1989 the backstopping service was reorganized and expanded. The IBEK company, Bremen (FRG), was entrusted with the documentation of **biogas**-relevant literature and other professional papers. This task includes continuous updating and expansion of the information gathered. One special service is the announcement and evaluation of relevant meetings and conferences. Use of a data base will speed up the flow of information between dissemination programmes and scientific institutions.

Information is distributed regularly in **Biogas** Forum, published jointly by the Bremen Overseas Research and Development Association (BORDA) and GTZ. The journal appears quarterly, and provides information on current topics in **biogas** technology and **biogas** dissemination.

The consulting firm ENVIRON GmbH, Frankfurt (FRG), has been appointed to perform backstopping functions for all **biogas** programmes implemented by GTZ.

Personnel concept

The current concept for technical backstopping is based on an integrated approach. Thus, in addition to the permanent staff of ENVIRON, outside experts will be involved in the backstopping activities.

The background to this approach is the long-term conceptual aim of combining the capabilities of relevant research institutions with the experience of practical workers in the construction and operation of **biogas** plants of different technical standards and in the utilization of biomass.

By organizing meetings, the permanent members of staff and the outside experts have the opportunity to discuss, in particular, the backstopping concept and the dissemination of **biogas** technology in both developed and under-developed countries. There is no intention of limiting the number of participants; all institutions, private companies and experts working in the various fields of **biogas** technology and its related aspects are welcome to participate in these discussions and to contribute, either directly or indirectly, to the backstopping effort. In any effort to enlarge the pool of experts, however, it has to be borne in mind that financial resources are limited.

Focal points

The technical functions of backstopping currently cover three fields of activity:

- Analysis of enquiries
 - construction of **biogas** plants, appliances etc.
 - energy supply
 - utilization of biomass (substrate, slurry etc.)
 - dissemination of **biogas** technology.
- Procurement of equipment and establishment of a distribution and manufacturing information system enabling the backstopping institution to obtain and distribute the equipment needed in accordance with present and future demand.
- Information and communication
 - documentation of projects
 - preparation of readers and working materials
 - promotion of information exchange between projects
 - organization of meetings of institutions involved in the **Biogas** Extension Programme.

In an organizational restructuring phase, the central backstopping task will of course be to „administer" the above-mentioned problems and enquiries and to move on to close cooperation with the project teams on site, the GATE staff members and other institutions involved in this programme. These activities will be necessary and fundamental steps towards more conceptual and strategic work.

Points of main effort in backstopping in recent years

Over the years, there has been a clear shift of emphasis. While at the beginning, the majority of information and project reports concerned technical issues, non-technical subjects have become more important in recent years.

Whereas, up to mid-1986, only one-third of the enquiries related to nontechnical issues, such as socioeconomic aspects of dissemination, dissemination strategies, training of counterparts, financing, and utilization of biofertilizer, in the two years that followed there was a tendency to attach greater importance to these issues. An analysis of the topics reveals a rough equilibrium: about half of the enquiries relate to technical problems, the other half to dissemination problems, including the utilization of slurry.

This development reflects the fact that the adaptation of the digester technology has been a success. Digester designs have been improved in such a way that malfunctions due to faulty design or because the plants are only poorly adapted have become less likely. This applies in particular to family-size **biogas** plants.

Thus, there are grounds for assuming that non-technical aspects of **biogas** dissemination will assume even greater importance in the future.

Outlook regarding future topics

As the problems and goals of **biogas** dissemination change, so also, unavoidably, will the subjects dealt with by backstopping services. One major future objective in the dissemination of **biogas** technology as a means of utilizing farm waste will be to improve dissemination management. This will apply in particular to problems of cooperation with the executing agencies, maintenance, financing etc.

In particular, more extensive utilization of **biogas** technology will necessitate evaluation and further development of methods of financing digesters, as there is still no satisfactory solution to the problem of making **biogas** available to potential beneficiaries who meet all the physical requirements but still cannot afford a plant.

As regards the dissemination strategies, methods of improving the sustainability of the measures initiated will have to be studied in detail.

Improving the economic viability of **biogas** plants is another area which will be important in the future. Improved technical performance of the digesters, in-depth planning based on balancing present and future demand, and increased and more effective utilization of the outputs - biofertilizer and **biogas** - will help improve the viability of the plants. Taking the critical and negative aspects into account, more attention will have to be paid to the use of biofertilizer, as analysis show that in many cases utilization of bioslurry significantly improves a **biogas** plant's economic viability.

Another future target will be the utilization of **biogas** technology for anaerobic treatment of sewage and waste, both communal and that of small and medium-sized enterprises, with special consideration of environmental and hygienic aspects.

Although plan designs have been developed to a stage where the likelihood of technical faults developing is reduced, there is still a need for further technical development. It may be assumed that activities will focus on extending the range of applications of **biogas** technology (e.g. agro-industrial plants, waste handling etc.) and on reducing costs, as high investment costs are still the main obstacle to accelerated dissemination of **biogas** plants.

In order to meet the requirements of future **biogas** extension programmes, backstopping must be in a position to emphasize the strategic component of **biogas** programmes, and the integration of this into the backstopping service.

A backstopping service in this field cannot be conceived of simply as a question-and-answer service: it will also include strategic advice on the programmes, in close cooperation with GATE and the project teams. The development of improved concepts will have to be based on country-specific situations and in-depth discussions with the experts involved.

As a part of future work, ENVIRON suggests that an inter-regional **Biogas** Information Exchange be set up. This service centre would not be meant to compete with other documentation organizations, but to act as a complementary institution based on experience and the flow of information relevant to backstopping activities.

"Come on Get Your **Biogas** Now"

Listen people what I'm tellin' you now:

Come on, come on, join in

in the **biogas** plant-buildin'

Biogas is good for land-folks.

And good for townsfolk too.

Biogas is a natural thing

Believe me, it's good for you.

Get your cookstove goin' ,

Put the saucepan on,

Cook your food now with **biogas**.

Connect up the fridge,

And turn the light on.

With **biogas** you can do all these things.

So make sure you get your **biogas**.

They've got **biogas** in China,

And **biogas** in Africa.

And now there's **biogas** for us too,

In Jamaica.

So make sure that you

Get your own **biogas** plant too,

On your own farm,

For with **biogas** all your problems are gone.

In words something like the above, a Jamaican farmer describes his experience with **biogas**. Like many other Caribbean farmers, he has benefitted from the GTZ **biogas** programme in the region. Since 1983, under the Regional Energy Action Plan, **biogas** programmes have been implemented in nine of the seventeen CARICOM countries. The results so far were described by Peter Michels in a 25-minute radio feature titled "**Biogas** and Slurry - Alternative Energy in the Caribbean" The feature was broadcast on Hesse Radio's Channel 2 on 17 January 1990 and included the above song.

Recent Developments in Anaerobic Digestion in The European Economic Community

by Edmond-Jaques Nyns

Throughout the 1980s, the Commission of the European Community (EC), which is the administrative body of the European Economic Community, sponsored surveys of **biogas** plants in Europe (i.e. excluding. - Austria and Switzerland

By mid-1987 there were 743 **biogas** plants in the EC. They may be classified as follows:

Full-scale plants	636
Plants under construction	33
Plants treating urban waste	20
Experimental plants	5
Pilot plants	45

The 669 full-scale **biogas** plants and the plants under construction may be divided into

473 agricultural plants (71 %)

196 industrial plants (29%)

Agricultural **biogas** plants tend to be found on family farms. The current trend indicates that **biogas** plants are still being built on farms, though mainly on larger holdings or as joint ventures initiated by several farms.

Although the agricultural **biogas** plants in the EC outnumber the industrial plants by three to one, the situation is reversed when methane digester volumes are considered. In fact, the total reactor volume of the agricultural plants is only 150,000 m³, while that of the industrial plants is 445,000 m³, i. e. a ratio of 1:3. The situation is even more dramatic when the amount of waste treated is considered: industrial **biogas** plants treat ten times as much waste as agricultural plants.

This is also reflected in the amount of methane produced. Agricultural plants in the EC produce 59,000 m³ of methane a day, whereas industrial **biogas** plants produce 423,000 m³ a day - a ratio of 1:7

On average, industrial **biogas** plants are larger than their agricultural counterparts. The former have an average reactor volume of 2,500 m³; the corresponding figure for the latter is 350 m³. In addition, the performance of industrial **biogas** plants is, on average, two to three times higher than that of agricultural plants.

The contribution of agricultural **biogas** plants in meeting EC energy requirements is equivalent to 18,500 tons of oil. Industrial plants contribute the equivalent of 132,000 tons. In 1987, the total contribution of biomethanation to meeting demand in the EC was equivalent to approximately 150,000 tons of oil.

The first survey, published in 1983, identified 546 **biogas** plants with a total reactor volume of 269,000 m³. Their contribution to meeting overall energy demand in Europe was equivalent to

33,000 tons of oil.



Figure

Biogas Development and Implementation in Nepal

by Dhruva Joshy and Gyanmendra Raj Koirala

The total per capita energy consumption of Nepal is currently 334 kg of oil equivalent. Of this, 75 per cent is met by fuelwood from the country's diminishing forest stocks. Agricultural residues and animal dung satisfy about 20 per cent of the total energy demand. Petroleum products, coal, and electricity supplies account for about 5 per cent of the total energy requirement. Commercial energy supplies, except for indigenous hydropower, are imported.

As in previous plan periods, the domestic sector is the largest single consumer of energy and represents about 95 per cent of the total consumption and approximately 99 per cent of traditional energy consumption. Other sectors of the economy, including transport, industry, and agriculture, account for about 76 per cent of total commercial energy use.

Introduction of **biogas** technology

A promising alternative energy resource, a **biogas** unit, was first built in 1955 for demonstration purposes. Special interest in this technology was seen only after the energy crisis of 1973. For the first time, an Energy Resource and Development Group was set up in 1975 at Tribhuvan University. The Government designated the period 1975/76 as an Agricultural Year, with plans to build 250 family-sized **biogas** plants. Of these, 199 **biogas** plants were successfully built by various private and governmental agencies, with interest-free loans provided through the Agricultural Development Bank of Nepal (ADB/N). During 1976, a joint project entitled "A Study of Energy Needs in the Food System" was set up between the Department of Agriculture and the American Peace Corps, which had successfully introduced community **biogas** plants in the country.

Later commercialization of this technology was accomplished through the setting up of a company in the private sector. In 1977, Gobar Gas Tatha Krishi Yantra Vikash (P) Ltd. (**Biogas** Company) was established as a specialized institution with joint investment by the Agricultural Development Bank of Nepal, the United Missions to Nepal (UMN), and the Nepal Fuel Corporation (now the Timber Corporation of Nepal) for the purpose of promoting **biogas** technology. The Company has its fabrication units, sales and service centres, research, and workshop units in 16 different places in the country.

The Company is entrusted with the responsibility for **biogas** development activities in accordance

with the Government's plans and programs. Essential services for **biogas** buyers and users are provided through its 14 offices. In order to motivate farm families to instal **biogas** plants, Company technicians visit homes to describe the advantages of **biogas** as a substitute for fuelwood, the enriched nutrient value of slurry, the positive impact on health, and the elimination of problems caused by smoke and other pollutants. Once the potential buyers show a positive interest in having a plant constructed, they are assisted in filling out loan application forms of the ADB/N. Assistance continues through the process of filling the construction order, with Company technicians coming to the site to build the **biogas** facility, once the necessary bricks, sand, gravel, and labour are arranged.

At present, there are 4,350 **biogas** plants of different types and capacities in Nepal, of which 90 per cent are in operation.

Design of **biogas** plants

Presently, the Company is mainly constructing two types of **biogas** digesters

(1) floating drum type, and

(2) fixed dome type. The floating drum design (steel gas holder design) was originally transferred from India. This design remained in use until 1977/78, until the fixed dome **biogas** digester (a modified design of a Chinese model) was introduced into construction programmes after a series of tests as to its reliability.

The steel gas holder design proved to be susceptible to corrosion and needed frequent replacement, which increased maintenance and service costs. The fixed dome design has overcome the corrosion problem, as it replaces the metal drum with a concrete dome. It was also observed that gas production in floating drum **biogas** plants was considerably less than that in fixed concrete dome plants during the winter. An additional benefit in this design is that it mainly uses local materials, reducing the construction cost. The tunnel-type digester has also been introduced in high water table and rocky soil areas.

The Company has plans to build fibre-glass dome **biogas** plants for areas which have no access to the transport network. Fibre-glass domes have already been initiated on a pilot scale.

The commonly constructed plants for a household are of 6, 10, 15 and 20 cubic metres size. Plants larger than these capacities, such as 35 and 50 cubic metres are constructed for electrification, irrigation, and milling purposes. Although there is an increasing demand for 500, 1000 and 5000 cubic metre-size plants on the part of various industries and town sewage boards, the company has not been able to construct plants of these capacities due to the lack of technical experts in the country. So far, the Company has been able to construct plants only up to 50 cubic metres capacity.

Repair and maintenance of **biogas** plants

Biogas users inform the Company of any problems encountered in the operation of the plants. The Company's technicians then visit particular plants and correct any faults. The plants are constructed with a seven-year guarantee from the Company, which provides essential repair and maintenance services free of charge for the period. In addition, the Company provides training in the efficient use and operation of this technology. Even after the termination of the seven-year guarantee period, the Company continues to provide essential technical services to the users at a nominal charge.

Financial aspects

The ADB/N is the primary source of funding for the dissemination of **biogas** technology in Nepal. The Company receives a loan from the bank to meet its operational costs. The Company in turn

realizes this amount from **biogas** users in payment against its services. The Bank is involved in financing the cost of plant installation, while the Company is responsible for construction, supervision, maintenance, fabrication, commissioning and training of the farmers and local masons. At different times, the Government has partially subsidized the initial cost of **biogas** plants, as well as underwritten the credit interest. Due to inconsistency in development policy, comprehensive development has lagged.

Biogas Development Programme

Only during the Seventh Five Year Plan did the Government take an interest in **biogas** development by fixing a national target of 4000 **biogas** installations of different capacities. In the past few years, the Water and Energy Commission has been involved in the implementation of the **biogas** programme by channelling Government support for training, research and development. The Company has already constructed 2500 plants out of the target 4000, with the remaining 1500 plants to be constructed by the end of this fiscal year. As a result, the Government is considering building about 50,000 family-size **biogas** plants in almost all areas of the country where construction is feasible during the Eighth Five Year Plan, from 1990 to 1995. In order to check the environmental degradation caused by deforestation, and to minimize the dependency on imported petroleum products and chemical fertilizers, a comprehensive **biogas** development programme for the Eighth Five Year Plan has set various strategies which plan to

- involve departments such as the Water and Energy Commission, Forestry, the Department of Agriculture, the National Planning Commission, and other agencies in the comprehensive plan;
- build 50,000 **biogas** plants in the areas of the country where construction is feasible;
- subsidize 50% of the initial cost of **biogas** plant installations, and, if possible, subsidize the interest rate on loans needed for this purpose;
- develop a base of local manpower of 5000 persons for construction, maintenance, and other services for **biogas** plants;
- involve well established and efficient private contractors in the construction sector with a view to accelerating the rate of **biogas** plant construction in order to meet the target of 50,000 plants;
- increase the efficiency of **biogas** utilization through an effective research development programme;
- extend and develop the present infrastructure of the Company to make it better equipped and efficient.

A major effect of the project will be its direct and very positive impact on problems of unemployment and health in Nepal, with beneficial results expected for at least 250,000 people in the first instance and at least 500,000 people in the second. In the Forest Sector, a saving of 183,632.4 tons of fuelwood, with a value equivalent to US\$ 6.4 million can be foreseen. The Agricultural Sector will benefit through the reduction of imports of chemical fertilizers, with a value equivalent to US \$ 6.8 million.

Problems for **biogas** development programme

- The technology is still expensive for the majority of farm families despite cost subsidies. As a result of an almost increase in the price of construction materials, daily the technology has become more and more expensive over time.
- The subsidy policy for the development of the technology has not been particularly attractive to the

majority of the rural population.

- More than 30% of the digesters constructed so far are directly cemented on the exposed soil of the pit, creating problems of renovation and maintenance.
- Potential **biogas** users are still not adequately aware of the use and benefits of the technology.
- Technological dissemination at the moment is very slow and has not reached all areas of the country where plant installation is feasible. This is due mainly to the financial limitations of the Company.
- **Biogas** extension workers are still not well trained, and do not have sufficient technical knowledge.

1. The Agricultural Development	by GGC supervisors.
Bank (ADB) is the loan-pro- viding agencyis	7. Repair and maintenace: GGC giving farmers a seven-year guarantee on the biogas digesters, so all repair and maintenance work will be car ried out by GGC free of charge.
2. Extension of technology by	8. Training - local masons - supervisors - training of managers etc. - training of farmers.
1) field workers as super- visors, Field Assistant of Gobar Gas Company(GGC),and 2) plans owners 3) local leaders 4) staff of Agricultural Development Bank 5) Ministry of Agriculture of H. M. Government of Nepal 6) JTA/JTA etc.	9. Plan for the future To make the technology more easily available to farmers, we are training more than 60 local masons per year. In due course of time, these experts will be the programme's main agents of dissemination.
7) volunteer missions. 3. Construction of biogas digester by masons, foremen of GGC or local masons trained by GGC.	10. Total number of plants con-structed: 3243 up to last year.

<p>4. Loan agreement between farmers and ADB, to be repaid within 7 years.</p> <p>5. Rate of interest: 15%, but for the fiscal year 88/89, the Government is providing a 50% subsidy on interest, so that it is reduced to 7.5%.</p> <p>6. Supervision/inspection: crease in cost, this type has been completely replaced by dome-type plants of Chinese design.</p>	
	<p>11. Design</p> <p>Five years ago, practically 100% of the plants were of the drum type (Indian KVIC design), but due to transport difficulties and the constant</p>

New **Biogas** Consultants in Tanzania

Arsuha Biocontractors and Consultants (ABC) is a consultant firm recently established in Arusha, Tanzania. In the following we print a short profile of the firm and its activities.

ABC is a private company specializing in the construction of **biogas** units for small holder farmers as well as for institutions. It has already installed more than 1';0 **biogas** units utilizing both animal dung and human wastes (biolatrines).

Activities

The companies activities cover the following range:

- Construction of **biogas** plants on farms
- Construction of biolatrines plants for human waste treatment to provide energy and sanitation for schools, dispensaries and other institutions
- Planning and construction of farm houses, zero-grazing units and other farm buildings

Servicing and supply of gas appliances.

- Servicing and supply of gas appliances
- Construction of Ventilated Improved Pit Latrines for sanitation
- Advice on soil conservation, manure cum-compost-production, organic fertilization and biofertilizer utilization
- Local and international consultancy on **biogas** technologies. implementation and dissemination strategies at farm level.

This short profile is intended to foster communication between the company and the readers of "gate". If you are interested please contact

Arusha Biocontractors and

Consultants (ABC) c/o

P. O. Box 764

Arusha, Tanzania

Documentation

Concept for Technological Cooperation with Developing Countries

The Complementary Technologies Model

by Herbert Theierl

The concept is based on the fact that in all developing countries (DCs) there is a traditional sector (in rural regions) and a modern sector (in urban areas). It follows from this that there are three options for the DCs. They can promote either the expansion of the modern sector, by capital-intensive modern technology or the development of the traditional sector, by a technology "appropriate" to it or integration of the two sectors, by a combination of the two technologies.

A policy limited to promoting modern technology is future-oriented: it exploits the growth opportunities of the modern sector. However, it also neglects present-day problems of domestic integration (deficits in satisfying basic needs, underemployment and rural exodus).

A policy limited to promoting "appropriate technology" is oriented towards the present: it creates jobs in the traditional sector and helps satisfy basic needs. However, it neglects future opportunities for foreign integration (higher income through industrialization and export).

Thus, when choosing a technology, DCs are faced with the question of whether to maximize production and employment now or in the future. This conflict of aims can be resolved with a dualistic technology model in which the emphasis shifts from orientation towards the present to orientation towards the future, in accordance with progress in development. In this model, "appropriate technology" corresponds to orientation towards the present; modern capital-intensive technology corresponds to orientation towards the future. Their effects are intended to complement one another and thus help to overcome the structural split.

Criteria for the two complementary technologies

Since these two technologies compete for resources, a development policy whose actions are based on a dualistic technology model must develop concepts for the ratio in which the technologies are to be promoted. It is impossible to state an approximate value for this ratio which is applicable to all developing countries. Rather, it must be individually determined for each country, and in doing so great importance should be attached to the basic technological potential, the employment situation, the resources, the size of the market, and above all the size of the traditional and modern sectors in the country in question.

A) Criteria for "appropriate technology"

The following are regarded as special conditions in developing countries for which the technology has to be adapted:

- unemployment and shortage of capital
- shortage of foreign currency
- unequal distribution of income
- Lack of purchasing power
- small and incomplete markets
- shortage of skilled labour
- Lack of maintenance and repair facilities
- climate.

Priority should therefore be given to:

- capital-saving, i.e. labour-intensive methods
- use of local raw materials and energy sources
- methods which also create job opportunities for unskilled labour
- cheap means of production and products
- plants permitting low-cost production in small quantities
- simple processes
- means of production and products which are easy to handle, service and repair
- means of production and products suited to the climate.

Not all these criteria will be universally applicable; rather, they are important in various combinations, or individually, for the choice and design of projects.

B) Criteria for modern technology

- Technologies suitable for investment projects in DCs are those with which yields can be achieved - in terms both of corporate and national economies - which are above average for the sector or subsector in question.
- Where the introduction of a new technology causes traditional small businesses to be supplanted, it is important to examine whether the costs associated with supplanting them (above all the loss of jobs) are (over-)compensated by the benefits of the new production and sales structure.
- Apart from heavy industry, which is characterized by significant economies of scale, capital in the DCs, which is in short supply, can be put to better use in small and medium-sized businesses than in large enterprises. Moreover, production in small and medium-sized businesses is usually more labour-intensive than in large enterprises.
- Priority for technologies with which local raw materials can be processed.

- Priority for technologies which can be progressively linked to local technologies.
- Priority for technologies with which development bottlenecks can be eliminated.
- Priority for technologies which strengthen the local innovation system.

Further, it is essential to examine whether effective interaction is possible between the "appropriate" and the modern technology. Here, two points deserve consideration:

- the possibility of small enterprises acting as supplies to the large-enterprise sector;
- the possibility of making secondary production processes (e.g. transport, packaging) labour-intensive even though capital-intensive technologies have to be used for the core processes, for economic or technical reasons.

C) Criteria applicable to both technologies

- Environment:

The technology chosen should have low environmental impact and conserve resources.

- Culture:

The technology chosen should harmonize as far as possible with the cultural identity of the country, and in particular with the value system of its culture. In this context the principle of minimum intervention applies.

Sectoral priorities

The basis for laying down priorities is the difference in labour productivity between the industrialized countries (ICs) and the DCs in the respective sectors, because this is an indicator of the technological lag of the DCs in the individual sectors. According to statistical data of UNCTAD, the biggest difference in productivity in 1975 was in agriculture (12.2:1), the smallest was in mining (1.9:1). The productivity gap between ICs and DCs was also very large in manufacturing industry (7.3 :1), and especially in the consumer goods industry (8.2:1). In both the capital goods and the energy and water supply industries the ratio was 5.1. For the building, transport and telecommunications industries a ratio of 4.8:1 was found.

However, the difference in productivity alone does not make a sector eligible for assistance. But technological transformation of an underdeveloped sector would appear to have priority if its development is necessary to meet basic needs or is a prerequisite for industrialization. Here too, therefore, the key criteria derive from orientation towards the present (basic needs) and towards the future (industrialization).

The criteria for classifying the sectors are thus as follows:

- the degree to which a sector or subsector is technologically underdeveloped;
- the importance of the sector or subsector in satisfying basic needs;
- the importance of the sector or subsector for the industrialization of the country.

In the DCs, scarce resources often mean that orientation towards the future compete with one another. Thus, the sequence of priority sectors changes, depending on whether the basic needs or

industrialization are considered more important. That is, the priority is also based on a decision concerning merit, the correctness of which cannot be proved. However, the decision becomes understandable if the relative importance of basic needs and industrialization is not fixed, but treated as a variable which depends on the country's level of development.

In the following rough classification, three groups of countries are distinguished on the basis of their level of development:

- poorer DCs, i. e. Least developed countries (LDCs) and most seriously affected countries (MSACs),
- DCs with medium income,
- threshold countries.

Using the three criteria mentioned above, the following lists of priorities can be established for these groups of countries:

A) Least developed countries

Priority I

- Agriculture, especially production for the domestic market (satisfaction of basic need for food and prerequisite for industrialization)
- Water supply (satisfaction of basic need "public health")
- Energy supply, to the extent necessary for agriculture, water supply and for preparing food (satisfaction of basic needs).

Priority II

- Commercial energy supply (prerequisite for industrialization)
- Manufacturing industry, especially production for domestic market (satisfaction of basic needs)
- Education, especially technical training (satisfaction of a basic need and prerequisite for industrialization)
- Transport (satisfaction of basic needs and expansion of market as prerequisite for industrialization).

Priority III

- Development of scientific-technological infrastructure (prerequisite for industrialization)
- Telecommunications (expansion of market as prerequisite for industrialization)
- Prospecting for natural resources (prerequisite for industrialization)
- Housing construction (satisfaction of basic need „housing“).

B) DCs with medium income

Priority I

- Agriculture, production for domestic market and export (satisfaction of basic need for food and prerequisite for industrialization)
- Water supply (satisfaction of basic need "public health")
- Energy supply (satisfaction of basic needs and prerequisite for industrialization).

Priority I I

- Manufacturing industry, production for domestic market and export, start of production of capital goods (satisfaction of basic needs and start for industrialization)
- Education, especially technical training (satisfaction of a basic need and prerequisite for industrialization)
- Establishment and expansion of scientific-technological infrastructure (prerequisite for industrialization)
- Transport (satisfaction of basic needs and expansion of market as prerequisite for industrialization).

Priority III

- Housing construction (satisfaction of basic need "housing")
- Telecommunications (expansion of market as prerequisite for industrialization).

C) Threshold countries.

Priority I

- Manufacturing industry, increasing importance of production for export and production of capital goods (industrialization considerations more important than satisfying basic needs)
- Education, especially technical training (prerequisite for industrialization and satisfaction of a basic need)
- Expansion of scientific-technological infrastructure (prerequisite for industrialization)
- Energy supply (satisfaction of basic needs and prerequisite for industrialization)
- Telecommunications (expansion of market as prerequisite for industrialization)

Priority II

- Agriculture, increasing importance of production for export (prerequisite for industrialization and satisfaction of basic need "food")
- water supply (satisfaction of basic need "public health")
- Transport (prerequisite for industrialization and satisfaction of basic needs)
- Housing construction (satisfaction of basic need „housing")

The differences in the lists of priorities are based on the fact that the criterion "satisfaction of basic

needs" dominates in the poorer DCs; in the DCs with medium income it carries approximately the same weight as the criterion "industrialization": while in the threshold countries the latter dominates. However, application of the criteria not only results in a different sequence of priority sectors in the three groups of countries, but also in a differentiation of parts oriented towards basic needs and industrialization within the same sector or subsector. This distinction is of practical value in weighting the domestic and export market for agriculture and manufacturing industry, in the subsectors of material infrastructure, which are given different priorities, and in the different rating given to energy, depending on whether it is used to satisfy basic needs or for commercial purposes.

The high priority given to promoting agriculture in all three lists within the same sector or subsector deserves special comment: the reason is that the reorganization and development of agriculture is important not only for satisfying basic needs, but also for industrialization.

Water and energy supplies also have high priority in almost all cases. In these subsectors, especially in the rural areas, it is a matter not only of increasing productivity, but also of solutions appropriate for the needs of and conditions in the DCs. Here it is especially clear that the "gap" is not only technological (productivity), but also economic and social (low purchasing power, shortage of capital).

In manufacturing industry, technology transfer mainly takes place in the private mainly takes place in the private sector. However, assistance under the terms of Financial or Technical Cooperation may be good policy if it makes production that satisfies a basic need possible. Technical training, which is one of the prerequisites for industrialization, deserves the same priority as manufacturing industry.

While prospecting for natural resources was included in the lists of priorities, mining was not, because this is where the productivity gap between ICs and DCs is smallest.

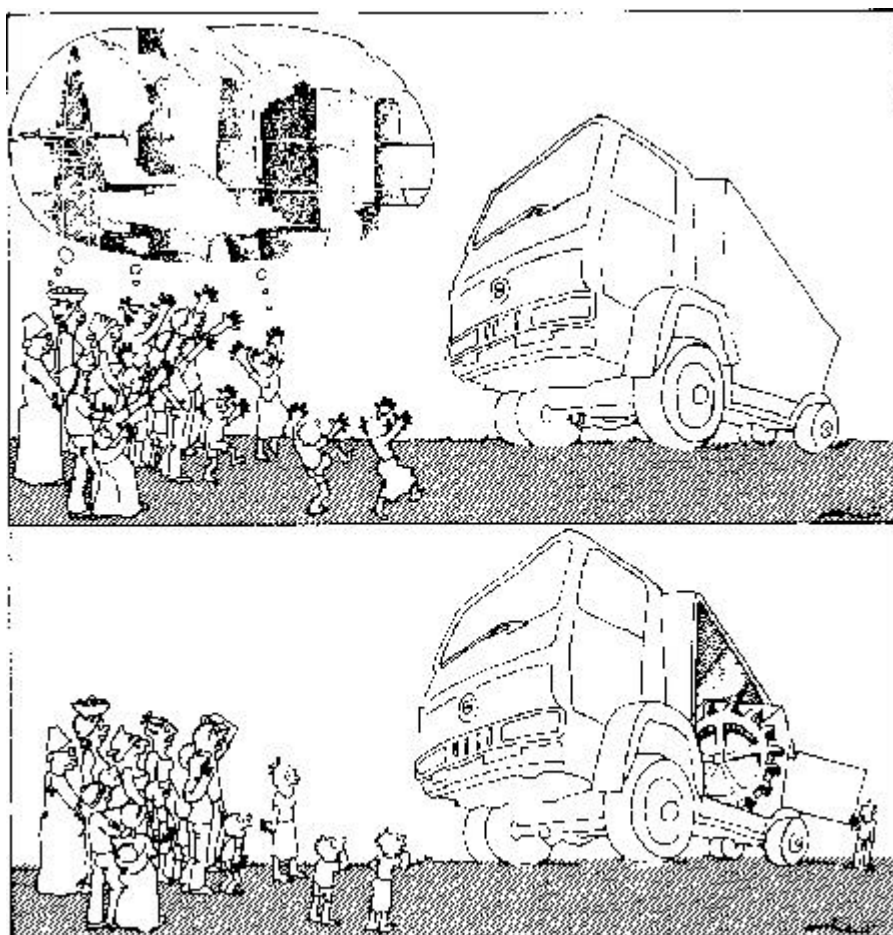

Figure

Four channels for transferring technology to the production system of the DCs

Increased use of science and technology in the DCs can make a major contribution to raising the development of natural resources and production in these countries to a level where they are able to solve their economic and social problems themselves. However, technology transfer not only solves problems, it also creates new ones. One of its negative effects is that it not only complements the services of the innovation systems of the DCs, but to some extent also replaces them. It thus weakens this system, which is responsible for finding appropriate solutions to the problems of its physical and social environment and passing them on to the production system.

This does not mean that the DCs could and should forgo the use of modern and "appropriate" technologies until they have an efficient innovation system of their own. But it is important not only that the channels of direct transfer to the production system of the DCs should be exploited, but also that channels should be used which go via the innovation system of these countries. A "detour" of this kind strenghtens this system, makes the DCs less dependent on imported technology, and encourages solutions that take the special needs of and conditions in these countries into account.

On the basis of these ideas four channels may be distinguished by which technology can reach the production system of the DCs. In the context of the development policy of the Federal Government, these channels correspond to four areas of activity in Technological Cooperation (A, B, C, D; see diagram).

Diagram: Channels by which technology reaches the production system of the developing countries

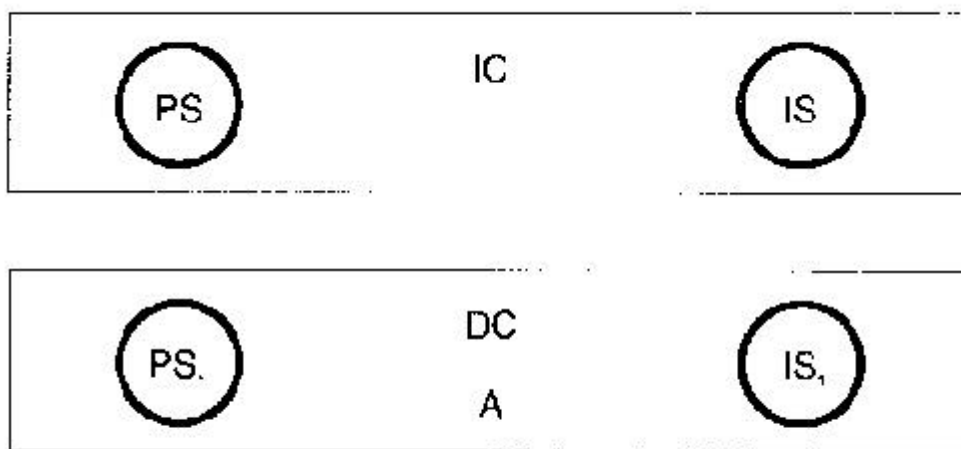

IS = Innovation system of industrialized countries
PS = Production system of industrialized countries
IS₁ = Innovation system of developing countries
PS₁ = Production system of developing countries
A-D = Channels and areas of activity described in text

Figure

A. Strengthening of the innovation system of the DCs and its bridges to the production system

This includes:

- establishing and developing a scientific-technological infrastructure (research institutes, technology centres etc.) and

- integrating this infrastructure in the production system of the DCs, by means of scientific-technological advisory services, setting up weights and measures, inspection and standards authorities etc.

It should be emphasized that strengthening of the innovation system also counteracts the brain drain, because this system offers specialists a field of activity commensurate with their training.

B. Cooperation between the innovation systems of the ICs and those of the DCs

This strengthens the innovation system of the DCs directly and their production system indirectly; the results of such cooperation can stimulate the latter. It is implemented by R&D organizations in the ICs and DCs. Proximity to the problem, which the partner in the DC brings into the cooperation encourages solutions based on the needs of and conditions in the DCs.

C. Cooperation between the innovation system of the ICs and the production system of the DCs

This is suitable primarily when the innovation system of the DCs has an urgent technological need it cannot yet satisfy. In such cases, it may be a good alternative to private-sector technology transfer, because material interests are less important.

D. Cooperation between the production systems of the ICs and those of the DCs

This enables the technology requirements of the DCs to be satisfied in the short term, while the other types of cooperation can only help close the technological gap in the medium and long term. In order to avoid negative effects (see above) it must be complemented by cooperation in the other areas of activity.

It includes private-sector technology transfer, as well as much of the Financial and a smaller portion of the Technical Cooperation of the Federal Government.

The activities in areas A und B are especially important because it is only from them that independent technological development can result.

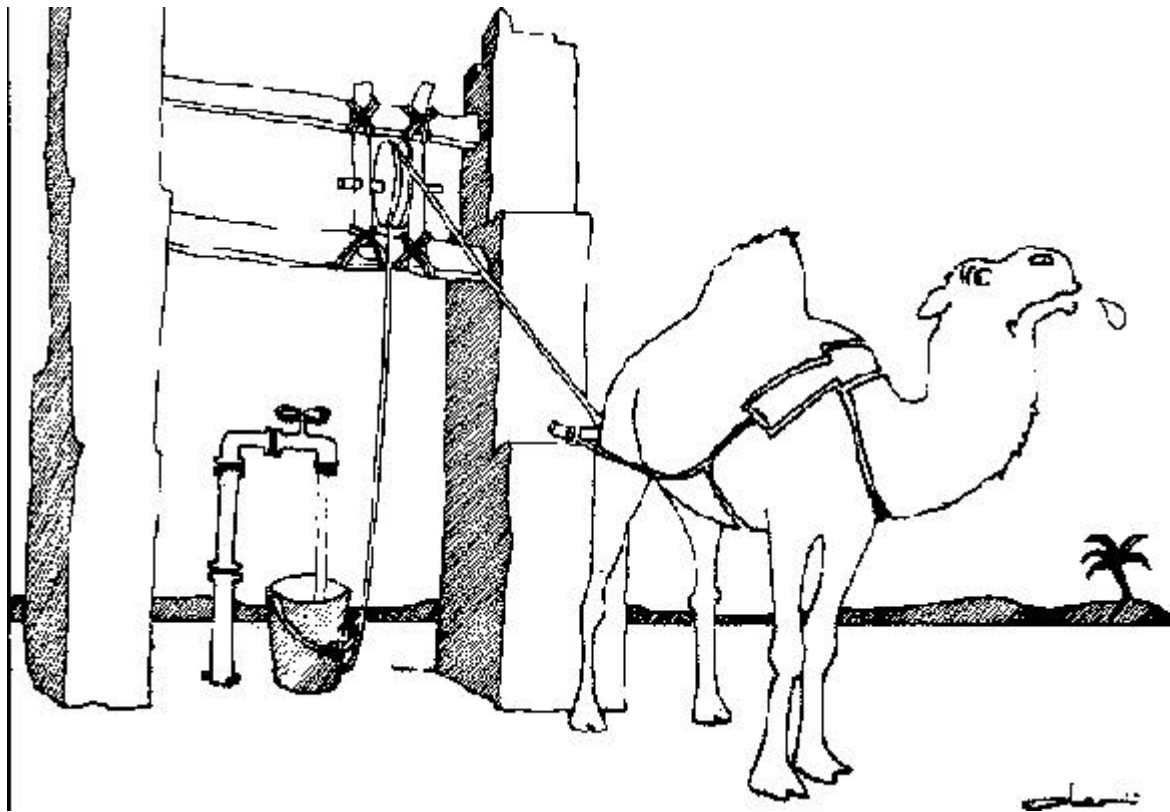

Figure

Visiting card



Figure

Address:

Biogasgruppe im Bundschuh

Dieter Spielberg

Endersbacher Straße 56

D-7000 Stuttgart 50

FRG

The global food situation, the decline in respect for farming as an occupation, the rapid disappearance of the natural environment in Europe and the bleak outlook elsewhere in the world prompted the members of the Biogasgruppe im Bundschuh (Bundschuh **Biogas** Group) to initiate a full-scale project aimed at improving the environment, and via the project to teach practical ecology. The first **biogas** system built by members of the group improved the productivity and economic viability of a medium-sized farm producing ecological (i.e. nonchemical) crops near Stuttgart. In the past few years

this **biogas** system has been further improved.

Implementation strategy

1) The Bundschuh **Biogas** Group is a small, private group which arranges meetings, and at least once a year invites people from all over the Federal Republic to take part in a tour of farms with successfully operating **biogas** plants. These tours, on which about 60 participants - mostly farmers - are accompanied by experts, are very important in a political environment where farming is seen as part of the chemical industry. The Bundschuh spirit offers hope and a haven for farmers who feel they need a **biogas** plant in order to stay independent. The group can help satisfy the emotional communication needs of the individual, which are normally hindered by ignorance in the throwaway society. Bearing in mind that official plans of the Federal German government will spell economic doom for tens of thousands of farms within the next ten years, farmers may want to preserve their heritage by utilizing **biogas** technology.

2) The European Community appears to have set its sights on obtaining more and more cheap energy, and only a minority within the Community is "swimming against the stream". A short time after the Chernobyl disaster, when it became clear that the lessons deriving from official energy policy had still not been learnt, Bundschuh started cooperating with the Danish Folkecenter for Renewable Energy. **Biogas** technology is actively disseminated by developing prototypes and publishing construction manuals for small and medium-sized companies offering good craftsmanship, and other interested organizations. Small firms in rural areas need new products and markets because of difficulties in marketing their usual products, especially in the agriculture and building sectors. To promote the use of **biogas**, the Danish Folkecenter (FC) acts as consultant to interested farmers, prepares draft plans, and assists craftsmen in building the plants. When the plants are in operation the FC follows up by making measurements and paying regular visits to the plants and the farmers. As part of the measurement programme, trials are conducted in which different kinds of organic waste products from the food industry are added. It has been found that this results in a substantial increase in gas yield. The cooperation has led to the development of a new generation of **biogas** plants. As most of the equipment needed can be transported in an ordinary 40-foot container, all the technical installation work can be done in the workshop and then transported without difficulty to the farm. Even the 65 m³ gas storage bag, which is made of gasproof fabric, can be suspended in a 40-foot container.

The Bundschuh strategy aims at

- 1) Increasing awareness, in an industrial society, of **biogas** as an important stepping stone towards a future decentralization of farming;
- 2) preparing the market for semi-industrial or craftsman-made **biogas** plants;
- 3) helping to develop handbooks as a basis for a German or European "crash programme" for the production of **biogas** plants by large-scale industry and local companies, with the advantages of economy of scale.

News from Bonn

Scientific Cooperation

TFAP Reviewed

More Scientific Cooperation with Developing Countries Needed

The Wissenschaftliche Beirat beim Bundesminister für wirtschaftliche Zusammenarbeit (Scientific

Advisory Committee of the Federal Minister for Economic Cooperation) has adopted an Opinion "On the need to strengthen policy for scientific cooperation with developing countries".

While the education systems in many countries have been developed quantitatively, there has often been too little qualitative improvement. In some cases, cultural traditions and group interests are an obstacle to the development of individual creativity. Moreover, scientists trained abroad in western countries are often forced to "retroadapt" because of an anti-innovation attitude in their own countries.

The Committee therefore recommends increasing follow-up assistance for graduates of German universities and colleges, and providing specialist support for scientists in developing countries by means of special-subject literature, laboratory apparatus, financing of travel to congresses etc. Joint applied research projects implemented by institutes in developing countries in cooperation with German research institutes should take up major issues, if possible in connection with local German development projects. The existing scientific assistance programmes should be extended and integrated in a longer-term cooperation strategy of all German institutions active in this field.

The Opinion of the Committee is available as a »BMZ-aktuell« publication from:

Bundesministerium für wirtschaftliche

Zusammenarbeit

Pressereferat

Karl-Marx-Straße 4 - 6

D-5300 Bonn 1

FRG

Tel. (Intl. + 49) 228 535451/2

Tropical Forest Action Plan Reviewed

The group of independent experts reviewing the UN's Tropical Forest Action Plan have now completed their talks in the Federal Republic of Germany.

The talks were held with (among others) Federal ministries, the Enquiry Commission of the Bundestag (Federal Parliament), the Deutsche Gesellschaft für Technische Zusammenarbeit (GTZ) and the Kreditanstalt für Wiederaufbau (KfW)

The purpose of the review is to intensify international efforts aimed at rescuing the rapidly disappearing tropical forest. The Tropical Forest Action Plan was instituted in 1985 by the FAO, the World Bank, the UN Development Programme and the World Resources Institute. Since then, 71 countries have agreed to support the Plan, including the Federal Republic of Germany. The Plan is coordinated by the FAO.

News from GATE

KATE Members Visit GATE

New Head of GATE

GDR Development Aid Workers Visit GATE

by Joachim Prey

German-German talks at GATE, too! At the end of January this year, staff members of the Kontaktstelle für Angepaßte Technologie in der Entwicklungszusammenarbeit (Agency for Appropriate Technology in Development Cooperation - KATE) spent several days in Eschborn.

KATE is a group of engineers and students working in development aid, who since 1988 have been trying to win additional support for the appropriate technology concept in the development policy debate in the GDR. Prior to the country's change of government the group's existence was constantly at risk: non-partisan initiatives were not exactly viewed with interest by the State.

Now, after the change of government, the important thing is to redefine "development cooperation", an area which has been neglected and is, certainly at present, not a major priority. In the opinion of KATE and Dr. Ralf Lennig, representing the Gesellschaft für Entwicklungshilfe (Society for Development Aid), establishing contact and possible cooperation with corresponding Federal German organizations could be useful in this context.

The Gesellschaft für Entwicklungshilfe is a GDR-wide federation of organizations and individuals working in development aid. Its prime objective is to set up a »Development Cooperation Round Table« with the participation of all relevant groups, to speed up the redefinition of development policy in the GDR.

Independent awareness of development issues

This was also the dominant topic during the visit to Eschborn. Are the initiatives in the GDR already so far developed that they can cope with support? It is even realistic to assume that there are independent initiatives in the GDR? Or will everything soon be taken over, anyway, by a "pan-German GTZ".

The standpoint of the GDR visitors on this issue was clear: an awareness of development issues must be allowed to materialize independently in the GDR. It would be a mistake simply to impose it by taking over Federal German structures.

No agreements

Nevertheless, cooperation is necessary. In the present "founding phase" it is clear that often even the basic preconditions for meaningful work are lacking: In what form might a future organization be legally constituted? An association, a foundation, some other form? Rolf Detmering from GTZ's Legal Section could give some useful advice here.

How will projects or activities be planned and implemented? The ZOPP procedure that GTZ is so proud of aroused great interest. So why not make it possible to attend ZOPP courses?

There is a need to set up information services and to issue publications, to foster public awareness in the GDR. Here, GATE could prepare a report drawing on its experience, and make many proposals.

Perhaps the foregoing is also the best way of describing the result of the visit. No definite agreements were reached, but we all got to know one another and learned a lot from one another. The positive impression that the visit made on all concerned will make it easier to lend concrete form to future cooperation.

New Head of GATE

Almost 18 months since the last "change the top", GATE once again has a new Head, Professor Dr.-Ing. Alexander Wittkowsky. In the following he introduces himself to our readers.

As of 1 May 1990 I left my job at the "Development and Design of Technology" Department of Bremen University and took up my duties as the new Head of GATE.

Until now I have been involved in the development of human centred manufacturing systems and small units for exploiting the energy potential of biomass. I regard my move to GTZ as a logical continuation of this work.

GATE's commitment and its contributions

- to protecting the environment as the natural basis of life all over the world, through Technical Cooperation
- to disseminating socially and economically appropriate technologies, and
- to identifying, and evolving plans to overcome, new problems associated with safeguarding the existence of people in the Third World represent a great challenge. A high degree of motivation, awareness and understanding of the situation of GATE's partners and of overall conditions in the Federal Republic of Germany are needed to carry on this work successfully.

GATE has to take up these challenges within the limitations of the Federal Government's development-policy aims - ensuring the provision of life's basic necessities and building up vigorous economies. In particular, I support the guiding principle of helping the poorest sectors of the population to help themselves. A desire we all share is to help both old and - soon, we hope new friends of GATE to profit from the resources that GTZ can put at our disposal.

Prof. Dr. Alexander Witthowsky

A word from GATE. . .

Please Don't Forget the Code Number!

Dear Reader,

If you move to a new address

or you want to cancel your subscription to gate

or you contact us for some other reason connected with mailing gate to you

please don't forget to quote the subscriber code number shown on your

gate address label.

This will save us work and help us to avoid mistakes.

Many thanks.

Bookbox

Self-Help **Biogas**

New GATE

Publication

„Managing Self-Help Support“

Part II Now Available

Is your organization working in self-help support on quite a big scale? Have your activities recently expanded to a level where you are giving project support not just to five or ten, but to more than twenty self-help initiatives simultaneously? Do you, perhaps, feel a little worried about how to keep your organization in a position to manage so many different support activities reliably and appropriately?

If so, you might be interested to know that in 1989, GATE published Part I of Managing Self-Help Support (see "gate" 2/89, p. 42). The book summarizes the experience gained by GATE staff member Thomas Kuby as adviser on appropriate technology for a large village development programme in Tanzania. It proposes a number of appropriate tools for coping with management and administration problems which often hinder further expansion of self-help support.

Part II, which has now appeared, is the user manual for a computer-aided project support monitoring system - called "PSM" - which was recently developed by GATE as a contribution to the ongoing search for appropriate monitoring tool in self-help support.

PSM is being distributed free of charge together with Part II, on a 5 1/4 inch diskette which can be used in conjunction with dBASE-III Plus on any IBM-compatible MS-DOS personal computer.

PSM is a dedicated monitoring tool which fits closely into the management and administration system described in Part I of Managing Self-Help Support. It augments this system, though without replacing any of its manual operations.

Requiring only a minimum of data input, PSM will produce 18 different management reports on all relevant aspects of programme performance. Most of these reports are in tabular form, but some can also be reproduced as line charts, provided that MS-CHART has been installed on your PC together with dBASE-III plus. PSM performs extensive consistency checks on data entries, including the use of "controlled lists" which the user may modify in accordance with local requirements. Several other provisions - such as adding user-written subroutines to a special menu - allow the basic PSM module to be adapted to different situations.

Care has been taken to facilitate the handling of PSM, with special utility programmes which support

- installation of PSM on a hard disk;
- reorganization of databases.
- transfer of databases from one workstation to another;
- copying of PSM reports into other files;
- initial set-up of a PSM database.

If you feel that Managing Self-Help Support might be useful in handling your management and administration tasks, please write to GATE for a copy (for address see p. 2 of this issue), giving your

address and the field you work in. We will then send your Part I of the book, together with a product description of PSM which will enable you to judge the potential usefulness of this computer-aided monitoring tool for your particular purposes. You can then order Part II of Managing Self-Help Support, including the PSM diskette, using the order form enclosed with Part I.

Biogas Forum

Last year saw several changes affecting **Biogas** Forum, the journal published by BORDA which has now been appearing for over 10 years. As of issue 3/1989 there has been close editorial cooperation with GATE. In the following we reprint the preface to this first joint issue. The author is Dr. Hansjorg Elshorst, General Manager of GTZ.

"The development and utilisation of local resources is one of the pillars of an independent regional development such as is the aim of all countries. **Biogas** technology, involving primarily the utilisation of organic waste as a source of energy and as manure, is largely in line with this objective. **Biogas** technology helps improve environmental conditions, playing a particularly important role in conserving water resources.

In 1980 the Deutsche Gesellschaft für Technische Zusammenarbeit (GTZ) GmbH, through GATE (the German Appropriate Technology Exchange) began implementing a **biogas** dissemination programme based on an interdisciplinary approach. Since then many of the programmes and components have been integrated into technical cooperation.

GATE's work on **biogas** initially aimed to put to the test the basic feasibility of appropriate technology.

An interdisciplinary approach was found to be the most appropriate way of working for the professional initiation of the process of technology transfer and dissemination. The "appropriate development approach" has now become one of the development policy guidelines governing technical cooperation.

The entire GTZ has now adopted the model which has been used by GATE in its programmes for several years. The emphasis is put on achieving a joint solution along with the members of the target group and the executing agencies, making use of the existing sociocultural, socioeconomic and organisational experience while bringing in appropriate technology.

In industrialised countries too, **biogas** technology is receiving more and more attention. For this reason the subject ought now to be given an appropriate literary forum, and the BORDA **Biogas** Forum with its ten-year tradition, would seem to be a particularly suitable partner for the GTZ in this context . . ."

"**Biogas** Forum" appears quarterly, additionally, one or two special issues are published each year. The journal is free of charge and may be ordered from

BORDA

Bahnhofplatz 13

D-2300 Bremen

FRG

Acknowledgements

German Appropriate Technology Exchange

Centro Aleman para Tecnologias Apropriadas

Centre allemand d'inter-technologie appropriée

Deutsches Zentrum für Entwicklungstechnologien

GATE is not only the name of this quarterly. It also stands for German Appropriate Technology Exchange, founded in 1978 as a special division (Division 4020) of the government-owned Deutsche Gesellschaft für Technische Zusammenarbeit (GTZ) GmbH (German Agency for Technical Cooperation).

Tasks

GATE is a centre for the dissemination and promotion of appropriate technologies for developing countries. GATE defines "appropriate technologies" as those which appear particularly apposite in the light of economic, social and cultural criteria. They should contribute to socio-economic development whilst ensuring optimal utilization of resources and minimal detriment to the environment. Depending on the case at hand a traditional, intermediate or highly-developed technology can be the "appropriate" one.

Activities

GATE focusses its work on the following areas:

- Technology Dissemination: Collecting, processing and disseminating information on technologies appropriate to the needs of the developing countries; ascertaining the technological requirements of Third World countries; support in the form of personnel, material and equipment to promote the development and adaption of technologies for developing countries.
- Research and Development: Conducting and/or promoting research and development work in appropriate technologies.
- Cooperation in Technological Development: Cooperation in the form of joint projects with relevant institutions in developing countries and in the Federal Republic of Germany.
- Environmental Protection: The growing importance of ecology and environmental protection requires better coordination and harmonization of projects. In order to tackle these tasks more effectively, a coordination centre was set up within GATE in 1985.

Service

GATE offers a free information service in appropriate technologies for all public and private development institutions in countries dealing with the development, adaption, application and introduction of technologies.

Deutsches Zentrum für Entwicklungstechnologien

Dag-Hammarskjöld-Weg 1

D-6236 Eschborn 1

Federal Republic of Germany

[View this page in text format](#)